

2



Preparation

2.1	Items to Check	2-2
2.2	Connecting PC with GP	2-6
2.3	Setting PC Network.....	2-9
2.4	Setting GP Network.....	2-27

2.1 Items to Check

Before installing this product, ensure that the following prerequisites are completed.

2.1.1 PC Specification

› Operating Environment

Ensure that the PC to which 'Pro-Server EX' will be installed meets the requirements of the operating environment of 'Pro-Server EX'. If not, there may be a risk of installation failure or malfunction of software performance.

For details about the operating environment, refer to "OPERATING ENVIRONMENT".

› OS

'Pro-Server EX' operates on 'Windows 2000', 'Windows XP', 'Windows Vista', 'Windows Server 2003', 'Windows 7', 'Windows Server 2008', or 'Windows Server 2008 R2'. Ensure that an Operating System (OS) has been preinstalled and it performs correctly.

› Application Software

The following software must be installed in order to maximize the features of 'Pro-Server EX'. If not, preinstall them.

- 'Microsoft Excel 2000' to 'Microsoft Excel 2010'(For Microsoft Excel 2007 and 2010, only Excel Form Action is supported)
- 'Microsoft Access 2000' to 'Microsoft Access 2003'
- 'Microsoft Internet Explorer Version 5.0' or later

2.1.2 Necessary Equipment

› LAN Hub (10BASE-T/100BASE-T compatible, Switching type)

Used to connect all the Ethernet cables together.

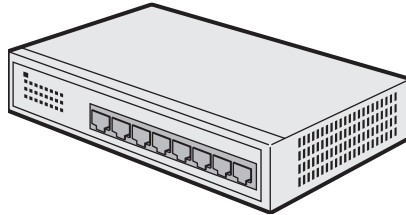

- * A LAN hub is necessary even when connecting one PC and one GP (one-to-one connection).
- * The minimum number of ports required is a sum of PCs and GPs to be connected. When the ports are not enough, prepare plural LAN hubs and make a cascade connection. Refer to the operation manual of the LAN hub for the connection method.

NOTE • The following products for the LAN hub are available in our company.

Model name: Industrial Ethernet Switch

Model Number: SPIDER 8TX-PRO

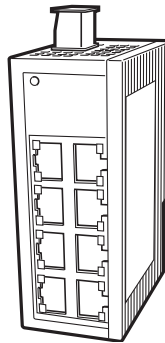

What is 10BASE-T/100BASE-T?

One of the Ethernet standards that uses unshielded twisted pair wires.

What is a cascade connection?

To connect plural LAN hubs using cable wires. This can increase the number of devices to be connected to one network.

For a cascade connection, 1 port is required for cascade.

(Connection Sample)

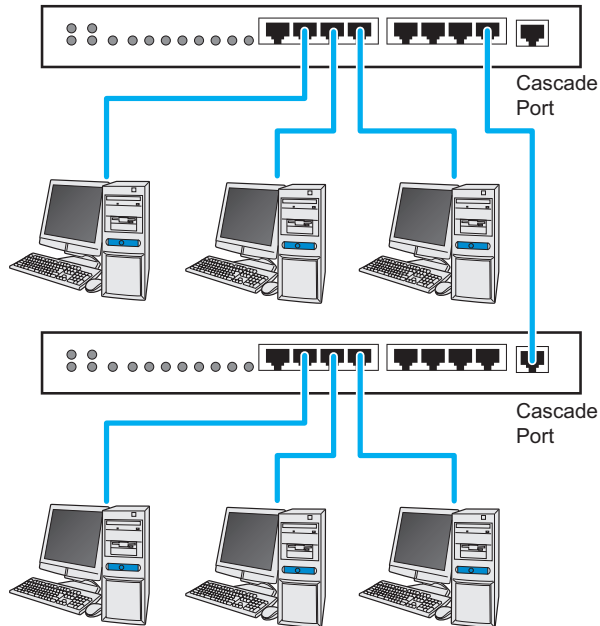

› Ethernet Cable (10BASE-T/100BASE-T compatible UTP straight cable)

Used to connect the PC and the GP

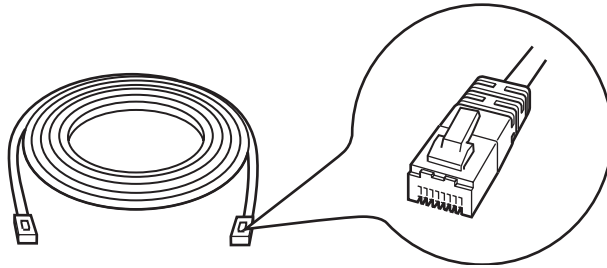

* This cable is necessary even when connecting one PC and one GP (one-to-one connection) since a LAN hub is used even in this case. When you use a cross cable for connection, we do not guarantee the operation.

* The minimum number of cables required is a sum of PCs and GPs to be connected.

What is UTP cable?

An abbreviation for unshielded twisted-pair cable. This is an unshielded cable in which the wires are twisted together. There are two types of UTP cables: straight cables and cross cables. A straight cable is used for connecting device-to-LAN hub. A cross cable is used for connecting device-to-device or LAN hub-to-LAN hub.

› Network Adapter (LAN board/LAN card)

Used by attaching to the PC.

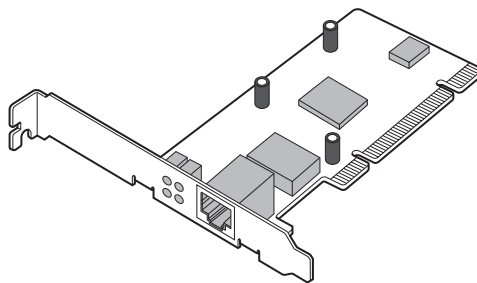

(Illustration shows a LAN board)

* When the Ethernet port for system connection has been preinstalled on the PC, it is not necessary to attach a network adapter.

How to attach the network adapter

Follow either appropriate method below to attach the network adapter to the PC. Refer to the operation manual of the PC or the network adapter for more details about attaching method.

- * Attach a LAN board to the expansion slot (PCI bus or ISA bus) of the PC.
- * Attach a LAN card to the PC card slot of the PC.

2.2 Connecting PC with GP

The following explains how to connect the PC and GPs using Ethernet cables.

Connect Ethernet cables to the PC and the GPs separately, and then connect them together using a LAN hub as shown below.

Example: Connecting three GPs and one PC

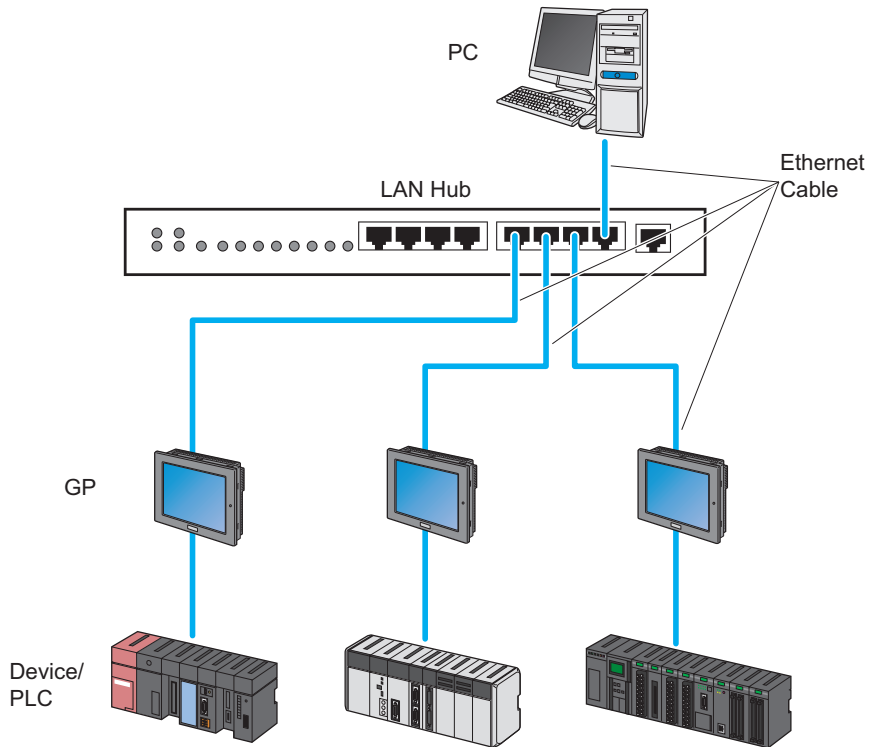

- 1 Connect one end of the Ethernet cable to the Ethernet port of the PC.

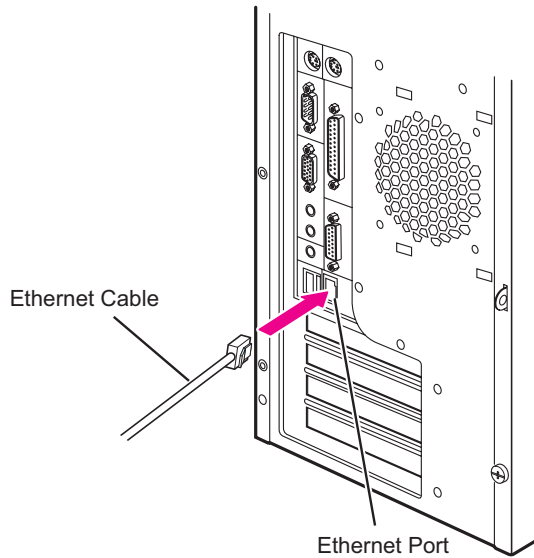

NOTE

- The Ethernet port is provided at a different position depending on the PC.
- Pull off the Ethernet cable while pushing the tab of the connector.

- 2 Connect one end of another Ethernet cable to the Ethernet I/F of the GP.

Example: GP3000 series

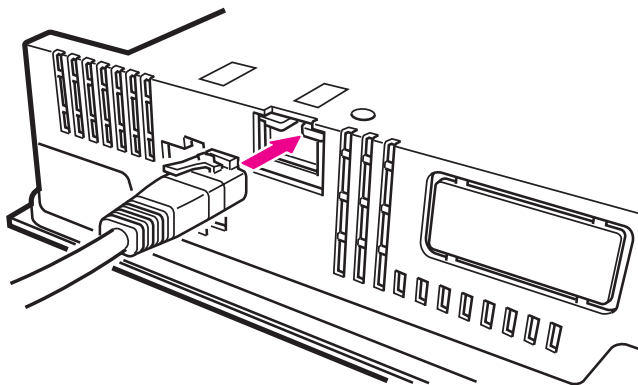

NOTE

- The Ethernet I/F is provided at a different position depending on the GP. Refer to the operation manual for more details.

- 3 Connect the other ends of the Ethernet cables connected to the PC and the GPs to the ports of the LAN hub.

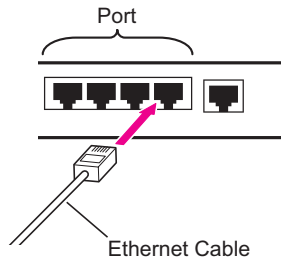

This completes the connection between the PC and the GPs.

2.3 Setting PC Network

The following explains how to connect the PC to the GPs via a network (Ethernet).

Necessary settings are:

- Operation check of the network adapter (LAN board/card); and
- Setting of TCP/IP protocol

Setting methods differ depending on the OS installed on the PC. Refer to the corresponding section to each OS.

- Windows Vista: "2.3.1 In Case of Using Windows Vista"
- Windows XP: "2.3.2 In Case of Using Windows XP"
- Windows 2000: "2.3.3 In Case of Using Windows 2000"

2.3.1 In Case of Using Windows Vista

-
- IMPORTANT** • Log on to Windows with the user name of "Credential Manager" or of the equivalent administrator authority. Refer to the operation manual of the OS for user authority.
-

1 Operation Check of Network Adapter

Check that the network adapter (LAN board/LAN card) attached to the PC performs correctly using the "Device manager" of Windows.

(1) Turn on the PC power and start Windows.

(2) On the desktop, right-click the "Computer" icon, and then select "Properties" from the menu.

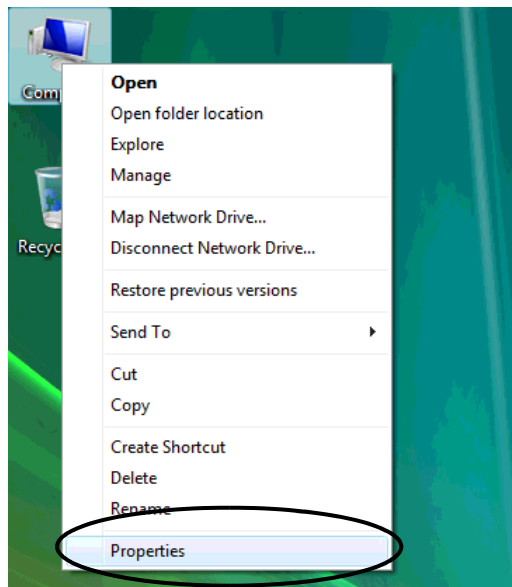

(3) On the displayed screen, click the [Device Manager] button.

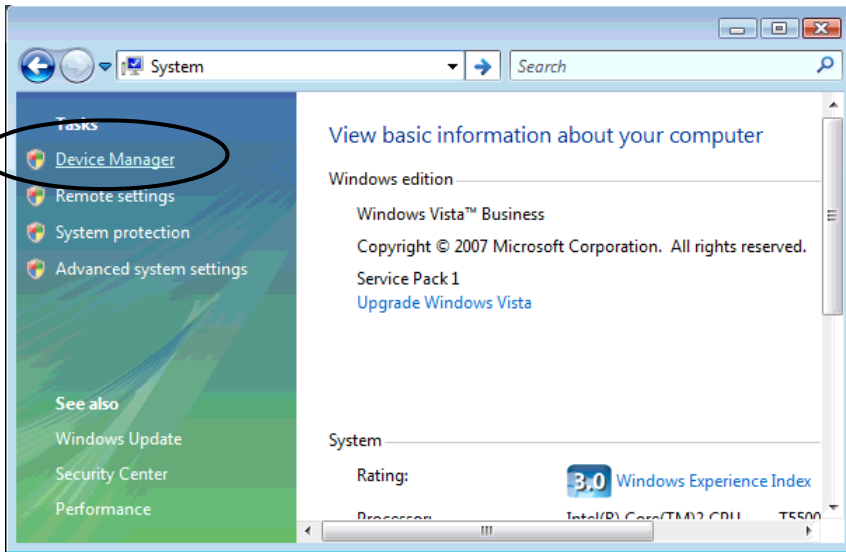

IMPORTANT

- The [User Account Control] dialog box may be displayed. When it is displayed, click the [Continue] button.

(4) On the "Device Manager" screen, double-click the "Network Adapter" in the list of the hardware devices displayed.

Confirm that the name of the network adapter being attached to the PC is displayed.

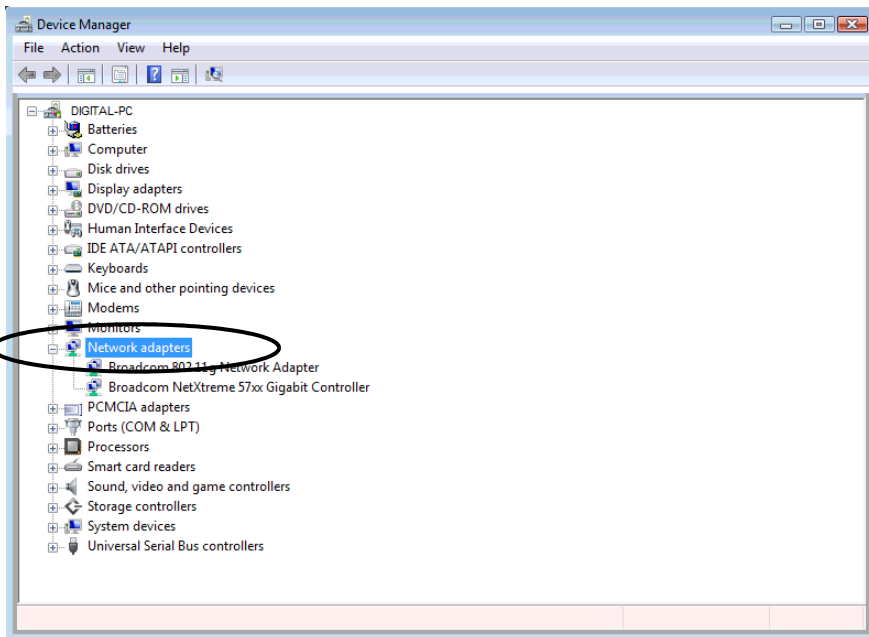

NOTE

- The "x" mark or "!" mark displayed at the head of the name shows that the network adapter is not performing correctly. Take actions so that the network adapter performs correctly referring to the operation manual of the network adapter, etc.

(5) Click the [x] (close) button to close the "Device Manager" screen.

(6) Click the [OK] button to close the "System" screen.

2 Setting of TCP/IP protocol

IMPORTANT

- Contact the network administrator before operation.

(1) Click the [Start] button in the task bar, and then select the "Network and Sharing Center" from "Control Panel".

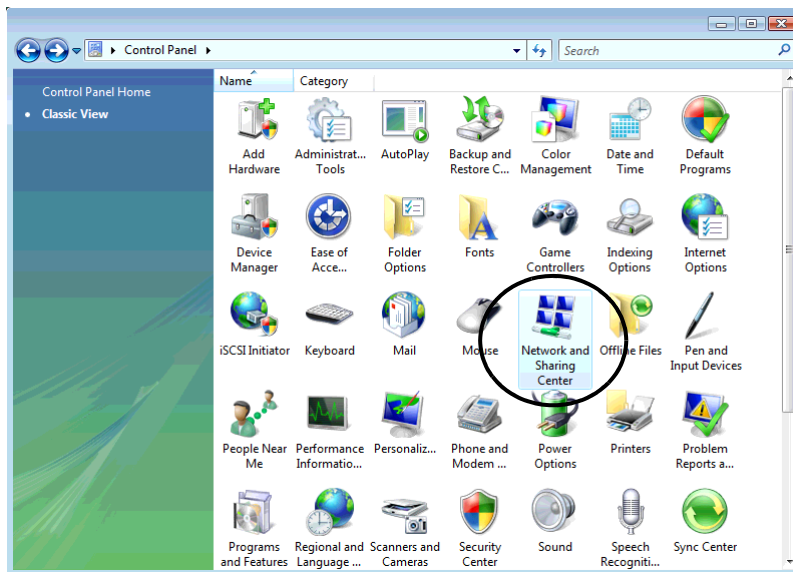

What is TCP/IP protocol?

One of the network protocols (standards regarding communication such as communication speed, and communication method). TCP/IP protocol is a combination of "TCP" (Transmission Control Protocol) and "IP" (Internet Protocol). This protocol is used on the Internet and electronic mails, and is the most popular protocol currently used.

IMPORTANT

- Contact the network administrator before operation.

(2) Click [Manage Network Connections] on the displayed screen.

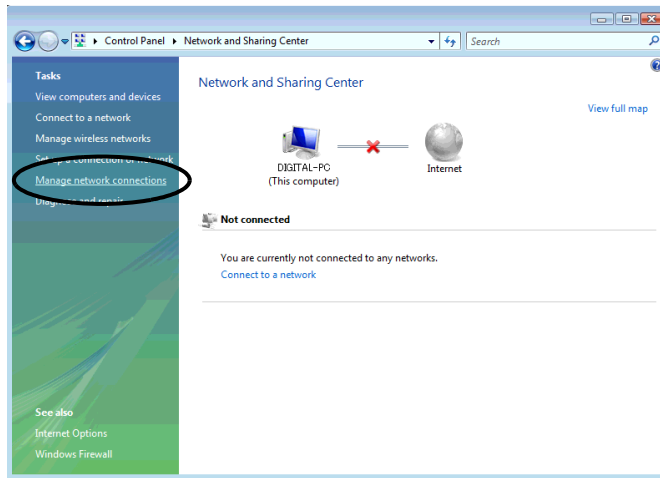

(3) On the "Network Connection" screen, right-click the "Local Area Connection" icon, and then select "Properties" from the menu.

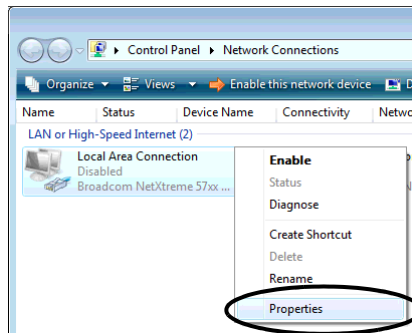

IMPORTANT

- The [User Account Control] dialog box may be displayed. When it is displayed, click the [Continue] button.

(4) On the "Local Area Connection Properties" dialogue, confirm that the check box of the [Internet Protocol Version4 (TCP/IPv4)] in [This connections uses the following items] is turned on.

If not, click the check box to turn on.

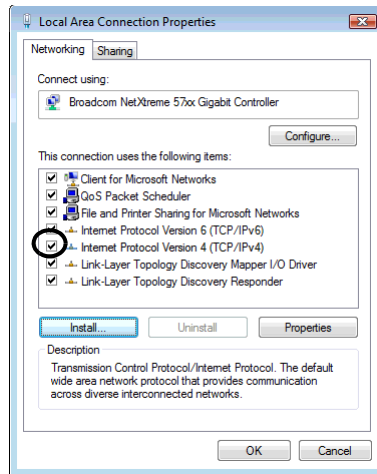

(5) Select [Internet Protocol Version4 (TCP/IPv4)], and then click the [Properties].

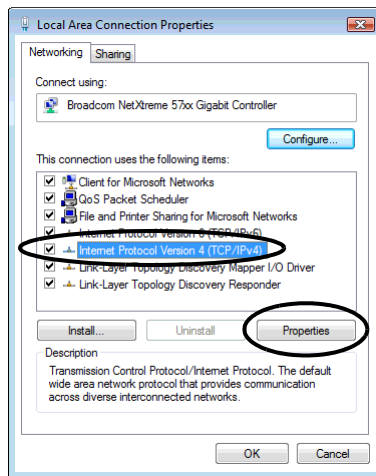

(6) In the [Internet Protocol Version4 (TCP/IPv4) Properties] dialogue, select [Use the following IP address], and then enter the IP address of the PC into the [IP address] field.

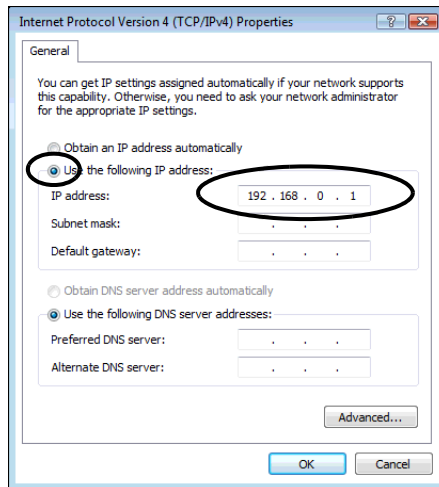

What is IP address?

Internet protocol numerical address assigned to each computer on the network so that its location and activities can be distinguished from other computers. The IP address takes the form of four numbers separated by dots, for example: 192.168.0.3

(7) Click the [Subnet Mask] field, and the subnet mask will be entered automatically. If necessary, change the subnet mask, and then click the [OK] button.

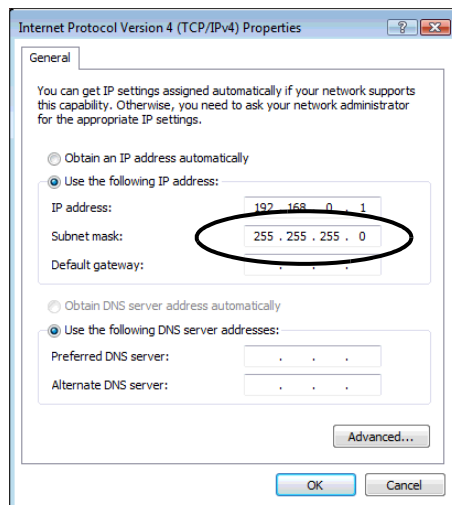

2.3.2 In Case of Using Windows XP

- IMPORTANT** • Log on to Windows with the user name of "Credential Manager" or of the equivalent administrator authority. Refer to the operation manual of the OS for user authority.

1 Operation Check of Network Adapter

Check that the network adapter (LAN board/LAN card) attached to the PC performs correctly using the "Device manager" of Windows.

(1) Turn on the PC power and start Windows.

(2) On the desktop, right-click the "My Computer" icon, and then select "Properties" from the menu.

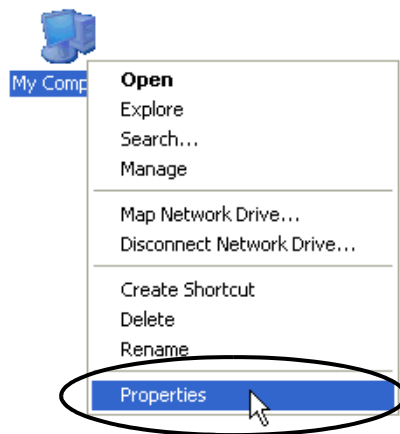

(3) On the "System Properties" dialogue, click the [Hardware] tab, and then the [Device Manager] button.

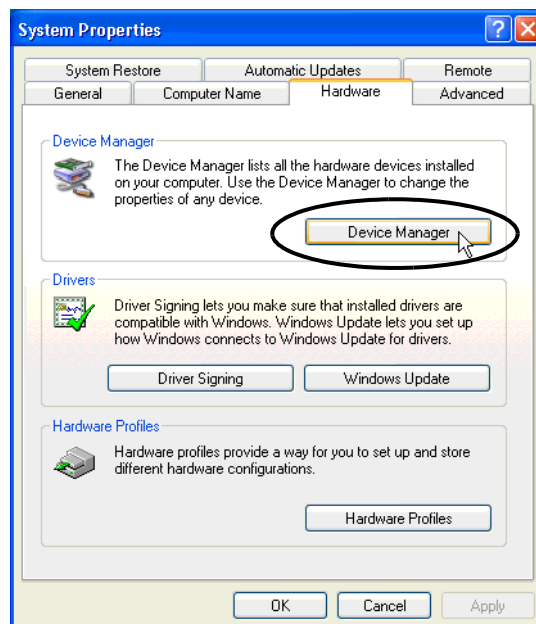

(4) On the "Device Manager" screen, double-click the "Network Adapter" in the list of the hardware devices displayed.

Confirm that the name of the network adapter being attached to the PC is displayed.

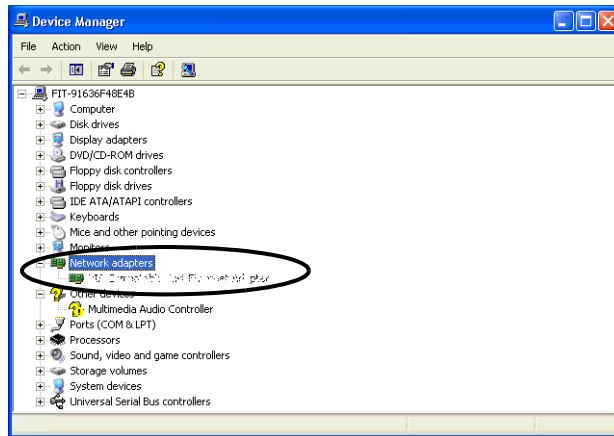

NOTE • The "x" mark or "!" mark displayed at the head of the name shows that the network adapter is not performing correctly. Take actions so that the network adapter performs correctly referring to the operation manual of the network adapter, etc.

(5) Click the [x] (close) button to close the "Device Manager" screen.

(6) Click the [OK] button to close the "System Properties" dialogue.

2 Setting of TCP/IP protocol

(1) Click the [Start] button in the task bar, and then select the "Network Connection" from "Settings".

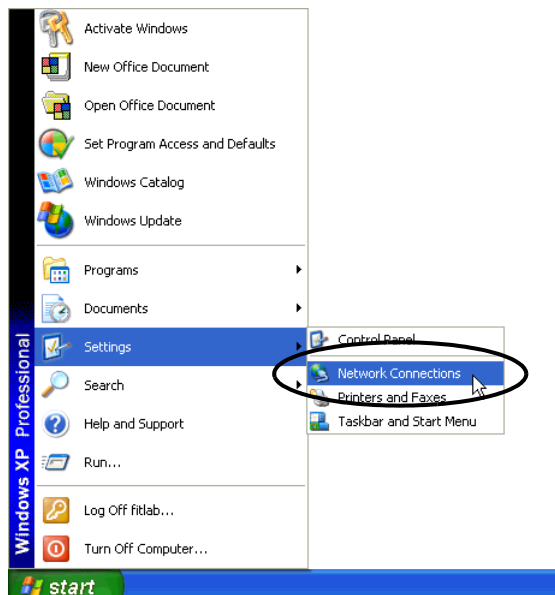

What is TCP/IP protocol?

One of the network protocols (standards regarding communication such as communication speed, and communication method). TCP/IP protocol is a combination of "TCP" (Transmission Control Protocol) and "IP" (Internet Protocol). This protocol is used on the Internet and electronic mails, and is the most popular protocol currently used.

IMPORTANT • Contact the network administrator before operation.

(2) On the "Network Connection" screen, right-click the "Local Area Connection" icon, and then select "Properties" from the menu.

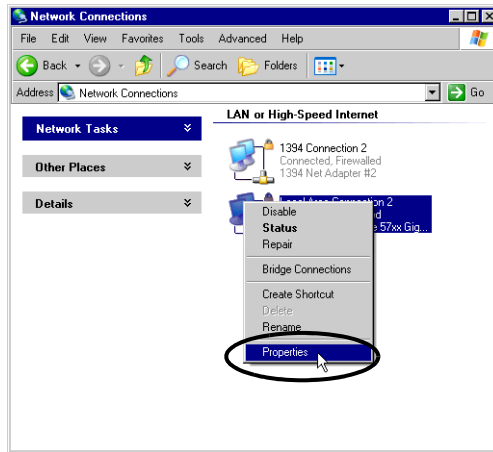

(3) On the "Local Area Connection Properties" dialogue, confirm that the check box of the [Internet Protocol (TCP/IP)] in [Components checked are used in this connection] is turned on. If not, click the check box to turn on.

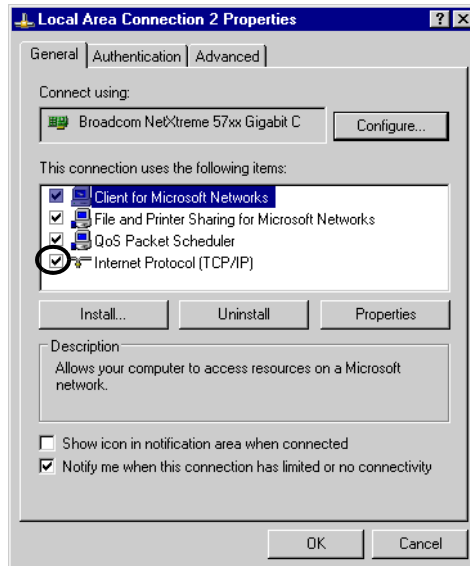

(4) Select [Internet Protocol (TCP/IP)], and then click the [Properties].

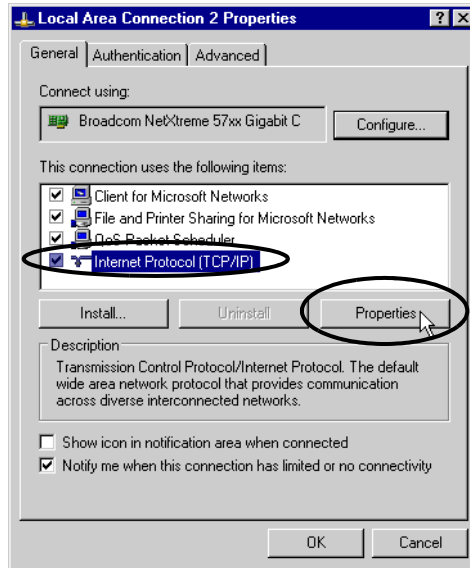

(5) In the [Internet Protocol (TCP/IP) Properties] dialogue, select [Use the following IP address], and then enter the IP address of the PC into the [IP address] field.

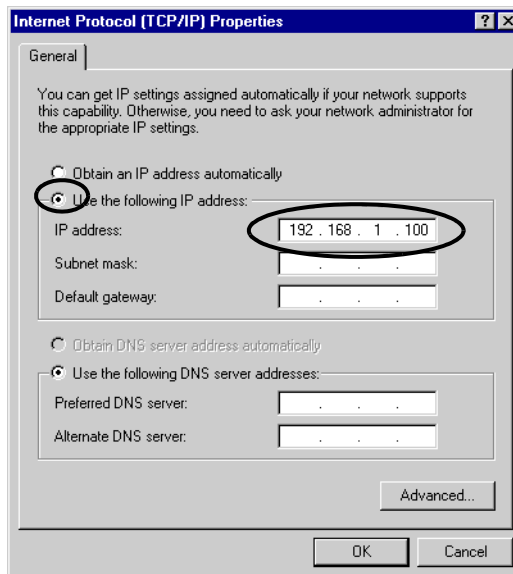

What is IP address?

Internet protocol numerical address assigned to each computer on the network so that its location and activities can be distinguished from other computers. The IP address takes the form of four numbers separated by dots, for example: 192.168.0.3

2.3.3 In Case of Using Windows 2000

- IMPORTANT** • Log on to Windows with the user name of "Credential Manager" or of the equivalent administrator authority. Refer to the operation manual of the OS for user authority.

1 Operation Check of Network Adapter

Check that the network adapter (LAN board/LAN card) attached to the PC performs correctly using the "Device manager" of Windows.

(1) Turn on the PC power and start Windows.

(2) On the desktop, right-click the "My Computer" icon, and then select "Properties" from the menu.

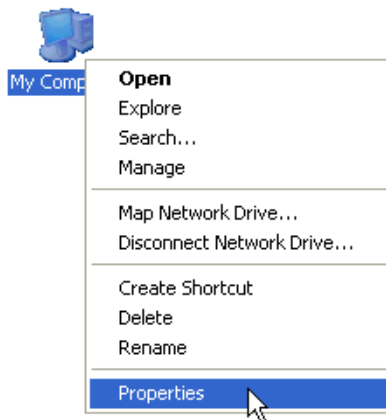

(3) On the "System Properties" dialogue, click the [Hardware] tab, and then the [Device Manager] button.



(4) On the "Device Manager" screen, double-click the "Network Adapter" in the list of the hardware devices displayed.

Confirm that the name of the network adapter being attached to the PC is displayed.

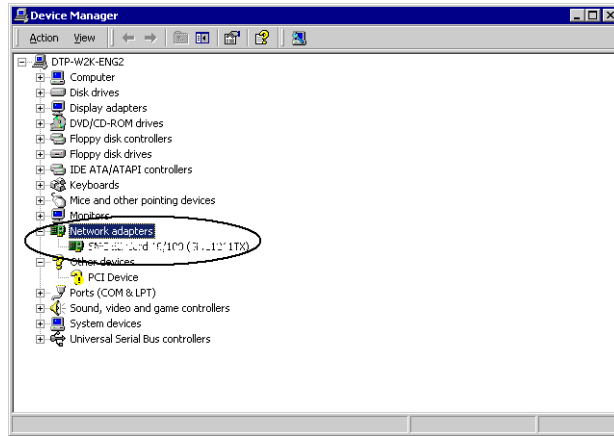

NOTE • The "x" mark or "!" mark displayed at the head of the name shows that the network adapter is not performing correctly. Take actions so that the network adapter performs correctly referring to the operation manual of the network adapter, etc.

(5) Click the [x] (close) button to close the "Device Manager" screen.

(6) Click the [OK] button to close the "System Properties" dialogue.

2 Setting of TCP/IP protocol

(1) Click the [Start] button in the task bar, and then select the "Network and Dial-up Connections" from "Settings".

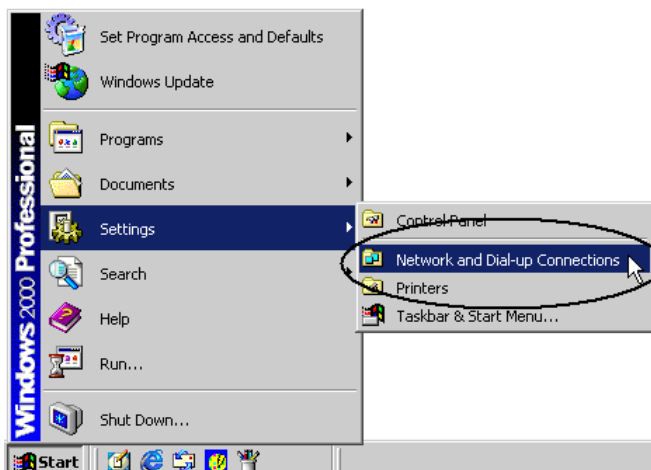

(2) On the "Network and Dial-up Connections" screen, right-click the "Local Area Connection" icon, and then select "Properties" from the menu.

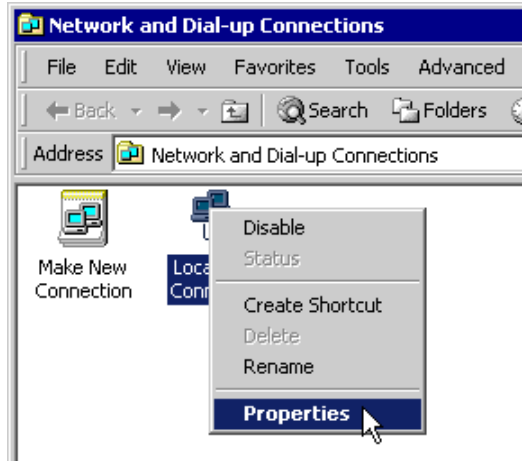

What is TCP/IP protocol?

One of the network protocols (standards regarding communication such as communication speed, and communication method). TCP/IP protocol is a combination of "TCP" (Transmission Control Protocol) and "IP" (Internet Protocol). This protocol is used on the Internet and electronic mails, and is the most popular protocol currently used.

IMPORTANT

- Contact the network administrator before operation.
-

(3) On the "Local Area Connection Properties" dialogue, confirm that the check box of the [Internet Protocol (TCP/IP)] in [Components checked are used in this connection] is turned on.

If not, click the check box to turn on.

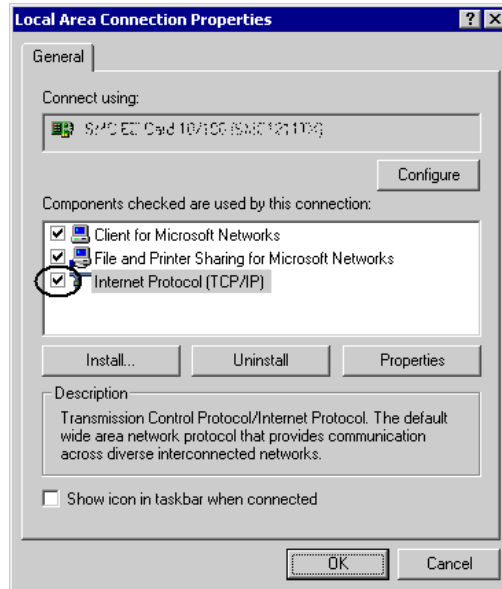

(4) Select [Internet Protocol (TCP/IP)], and then click the [Properties].

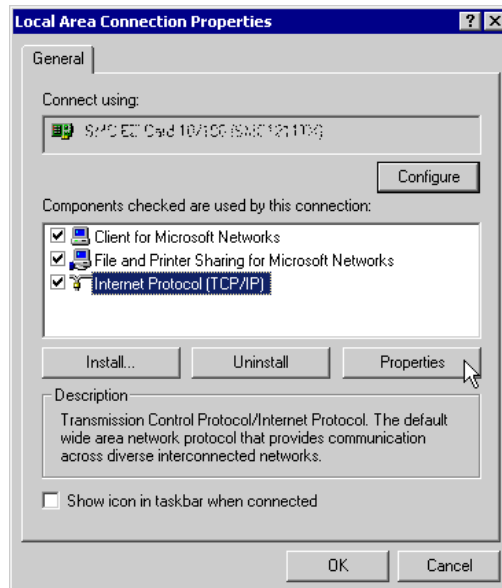

(5) In the "Internet Protocol (TCP/IP) Properties" dialogue, select [Use the following IP address], and then enter the IP address of the PC into the [IP address] field.

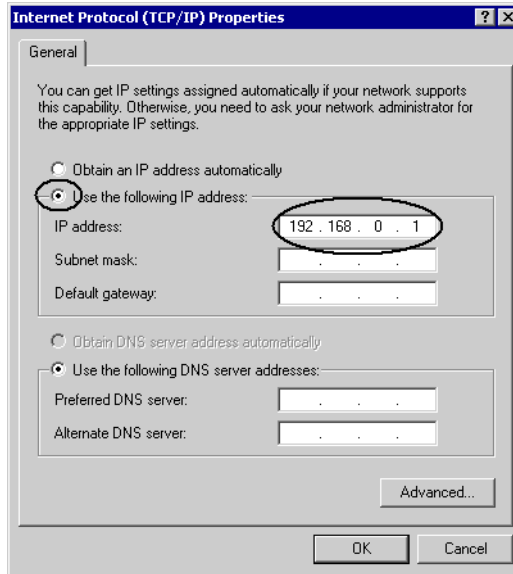

What is IP address?

Internet protocol numerical address assigned to each computer on the network so that its location and activities can be distinguished from other computers. The IP address takes the form of four numbers separated by dots, for example: 192.168.0.3

(6) Click the [Subnet Mask] field, and the subnet mask will be entered automatically. If necessary, change the subnet mask, and then click the [OK] button.

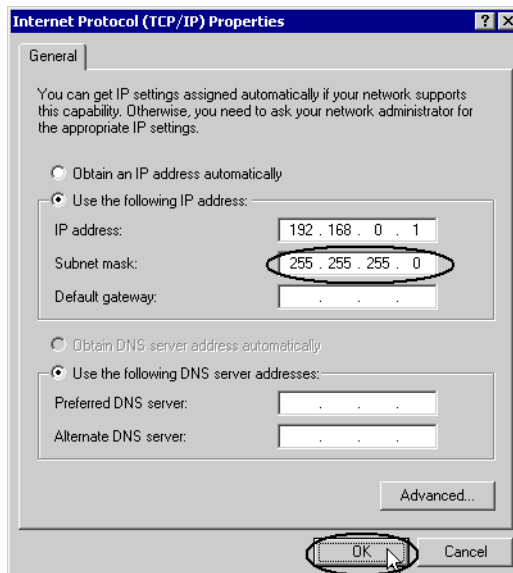

2.4 Setting GP Network

The following explains how to connect the GPs via a network (Ethernet).

1 Turn on the GP power.

After a while, the "Initial Transfer Mode" screen will appear on the monitor of the GP.



2 Touch the [Ethernet Setting] button.

The "Ethernet Setting" screen will appear. This screen displays default settings.

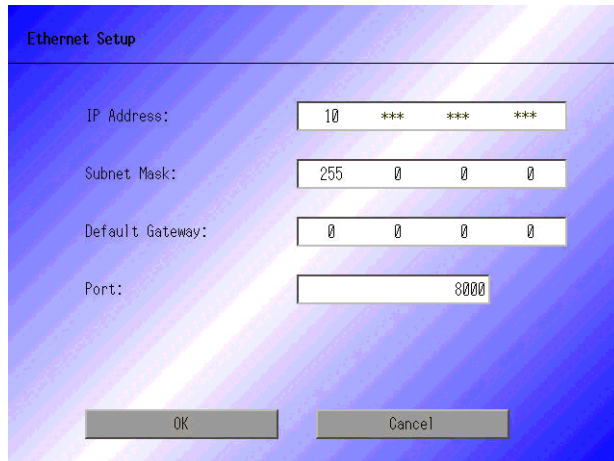

- 3 Enter the numbers of the IP address, Subnet Mask, Default Gateway and Self Node, and then touch the [Set] button.

Contact the network administrator for the values to set.

NOTE

- If no relay device to the other network such as a router is connected, it is not necessary to input about [Default Gateway].
-

This completes the network setting of the GP.