

16 | Bar Code/USB Keyboard Inputs

This chapter explains how to set up and operate external input devices such as barcode readers and USB keyboards for the display unit.

Please start by reading "16.1 Settings Menu" (page 16-2), and then turn to the corresponding page.

16.1	Settings Menu	16-2
16.2	Connecting a Barcode/Two-dimensional Code Reader	16-4
16.3	Display USB Keyboard Inputs.....	16-17
16.4	Settings Guide.....	16-22
16.5	Restrictions	16-29

16.1 Settings Menu

Barcode readers are one of the most widespread ID system for books, CDs, and information devices. You can use a barcode reader with the COM1 or USB interface on the GP series display unit.

NOTE

- You can connect one barcode reader to COM1, and another to the USB port at the same time. However, the system may not work properly if the two barcode readers run the same operation: 1 barcode reader should be set up to read data from the Data Display part and the other barcode reader set up to store data to the internal device.

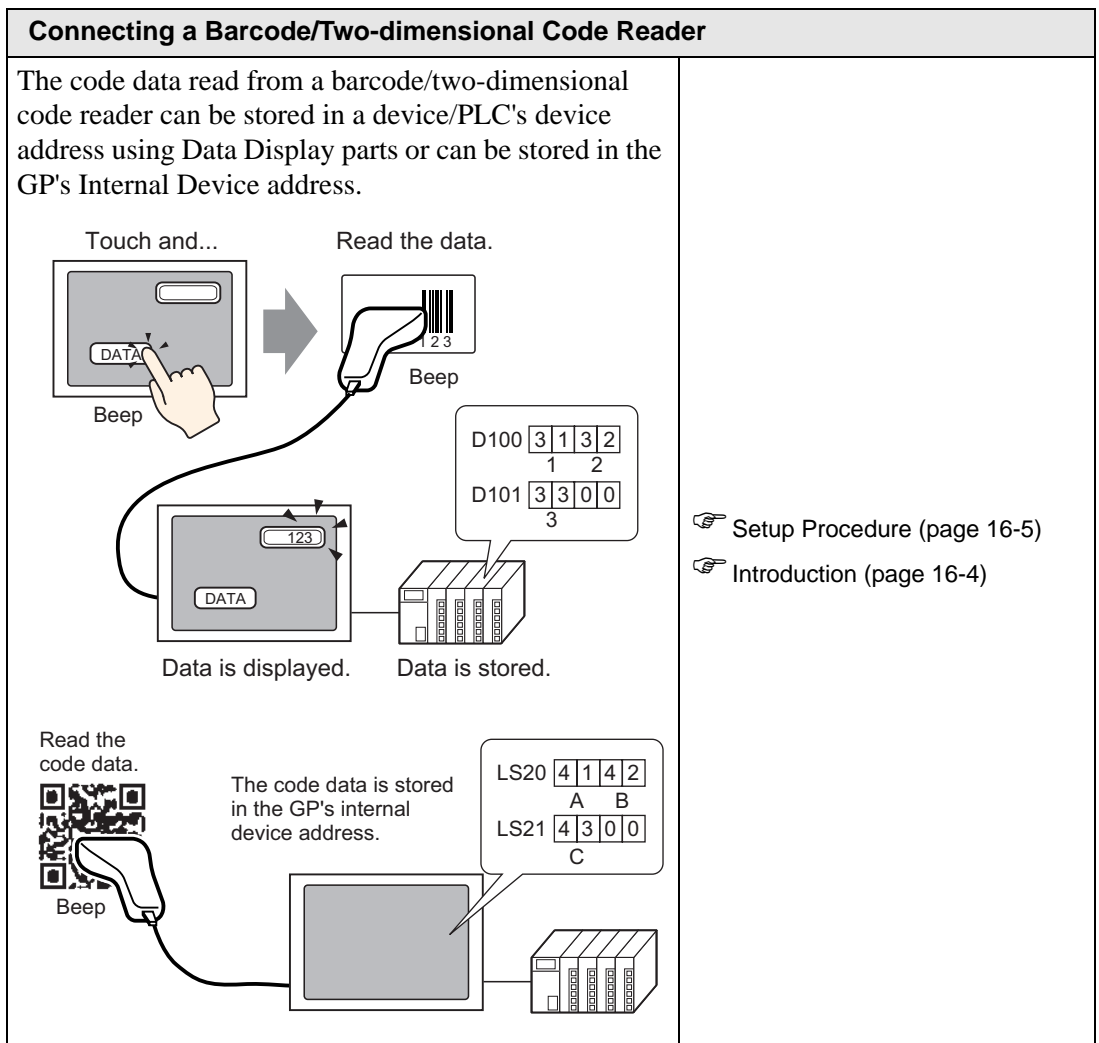

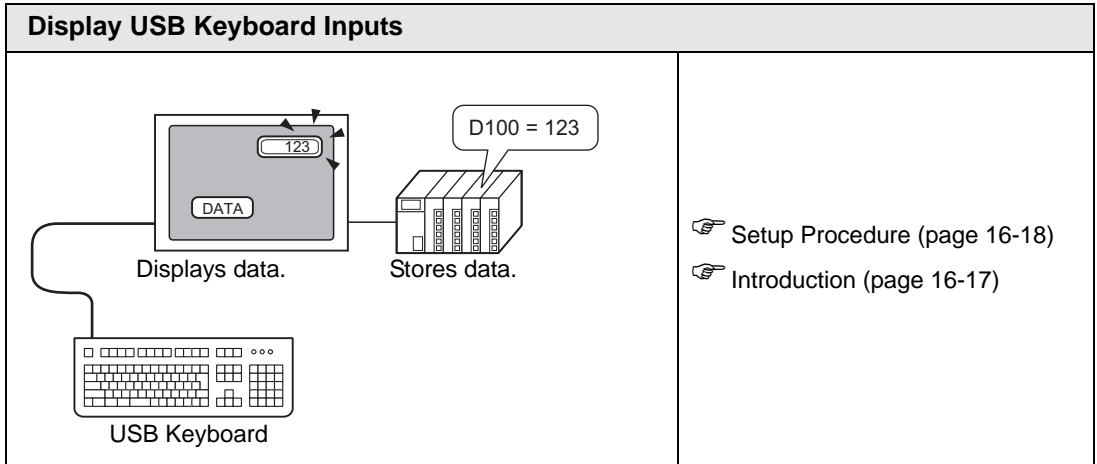

16.2 Connecting a Barcode/Two-dimensional Code Reader

16.2.1 Introduction

The code data read from a barcode reader can be stored in a device/PLC's device address using Data Display parts or can be stored in the GP's internal device address.

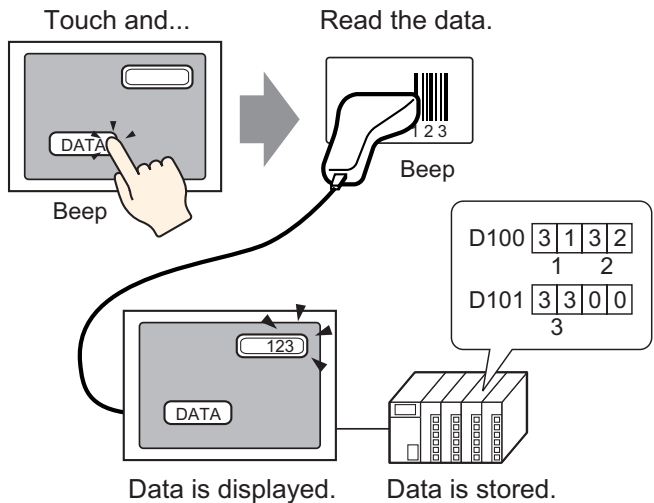

The code data read from a two-dimensional code reader can be stored in a device/PLC's device address through data display parts or can be stored in the GP's internal device address.

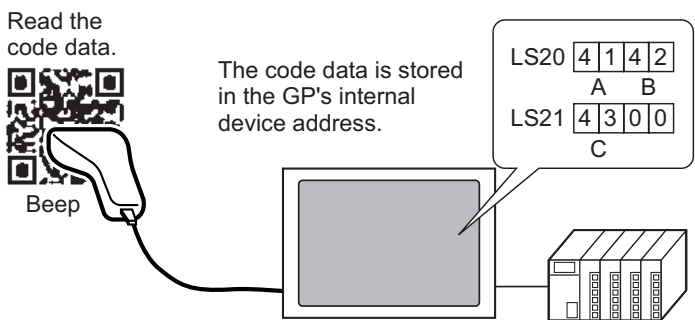

16.2.2 Setup Procedure

■ Bar Code

NOTE

- Please refer to the Settings Guide for details.
 - ☞ "14.11 Data Display Settings Guide" (page 14-42)
 - ☞ "16.4.1 [Input Equipment Settings] Settings Guide" (page 16-22)

Configure settings to display the code data read from a barcode reader in Data Display parts and store it starting from the device/PLC's D100 address.

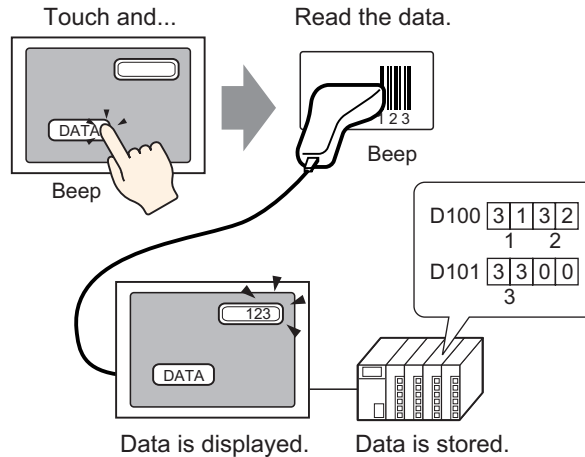

1 The following describes how to set up communication with barcodes. From the [System Settings], click [Input Equipment] to display the following screen.

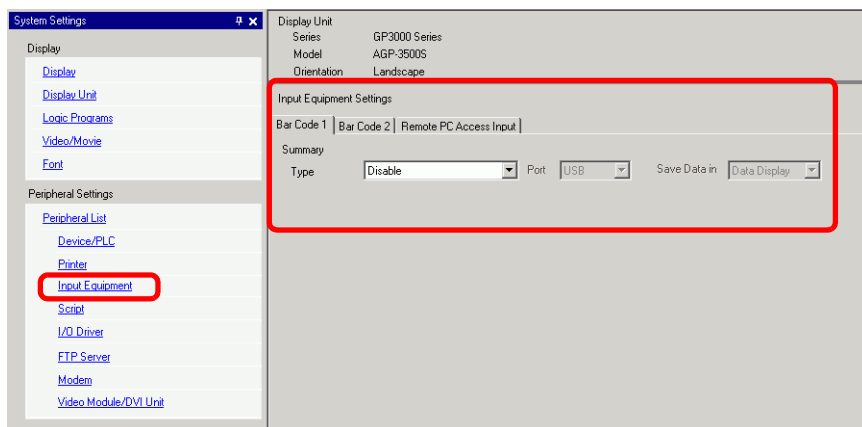

2 From the [Type] drop-down list, select [Bar Code Reader].

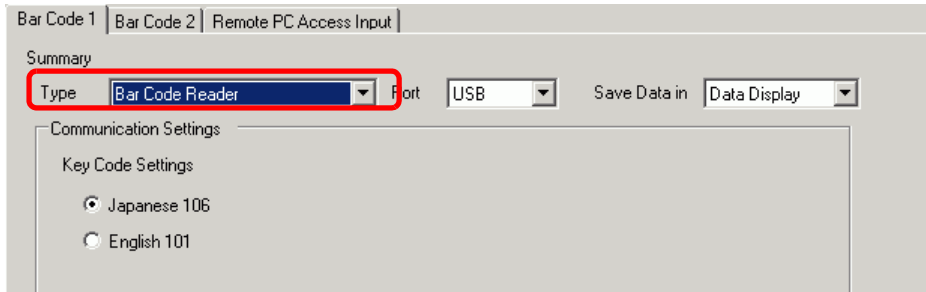

3 In the [Port] drop-down list, select the port to which you want to connect.

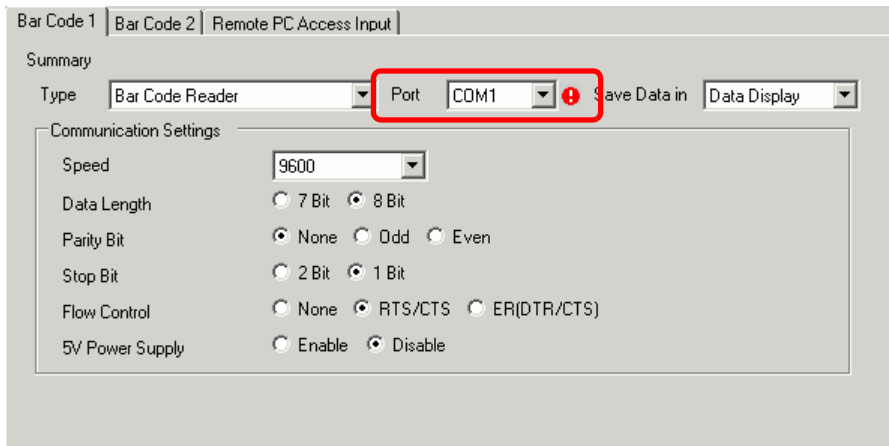

NOTE

- If the port is also used for other devices/PLCs,  displays to the right of the [Port] as above.

4 In [Communication Settings], set [Speed], [Data Length], [Parity], [Stop Bit], [Flow Control], and [5V Power Supply].

5 From the [Save Data In] drop-down list, select a data storage location. The settings for communicating with the barcode are complete.

6 On the drawing screen, configure the Data Display part that displays data from the barcode reader.

From the [Part (P)] menu, point to [Data Display (D)] and select [Text Display], or click  to place a Data Display part on the screen.

7 Click the Data Display part, and the following dialog box appears. Click [Text Display].

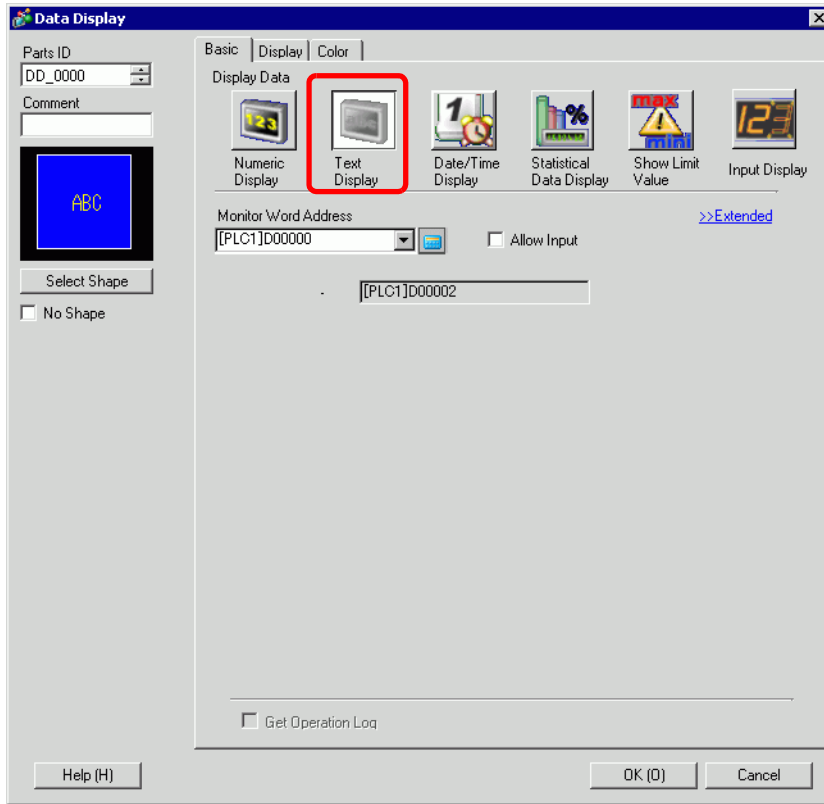

8 Select the Data Display shape from [Select Shape].

9 In the [Display] tab, define the number of single-byte characters in the [Display Characters] field, from 1 to 100. Double-byte characters count as two display characters. (For example, "3" single-byte characters)

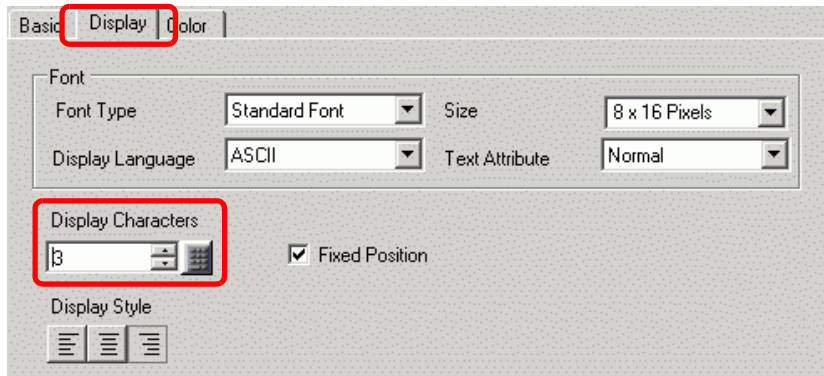

10 Click the [Basic] tab. In the [Monitor Word Address] field, set the address for where the value read from the barcode reader is stored.

Select device "D", input "100" as the address, and press the Enter key.

Click  to display an address input keypad.

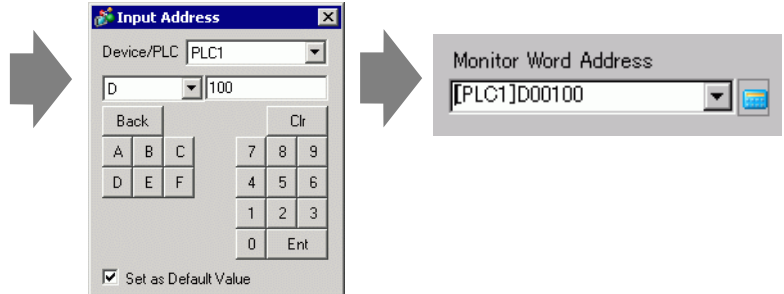

11 The address from the [Monitor Word Address] displays.

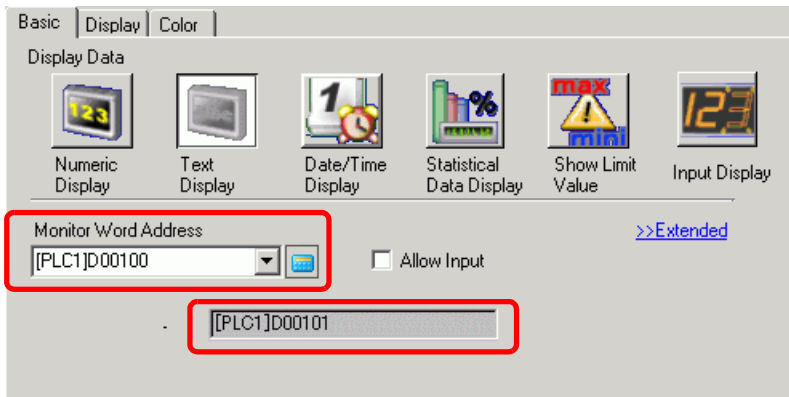

NOTE

- Use two characters for one word in single-byte characters, and one character for one word in double-byte characters. In the above example, two words are used because, in Step 9, [Display Characters] is set to 3 (single-byte characters).

12 Select the [Allow Input] check box. Selecting [Allow Input] displays the [Data Entry] tab where you can enter text data.

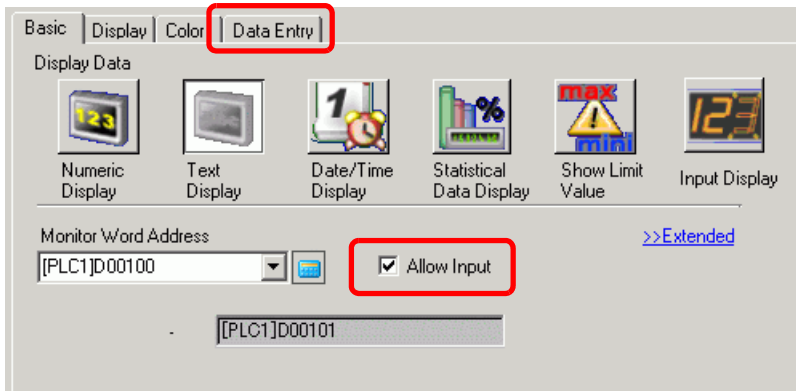

13 Click the [Data Entry] tab, and select [Bit] for the input method.

Select the [Allow Input Bit Address] check box. A barcode reader can input data when this bit address is ON.

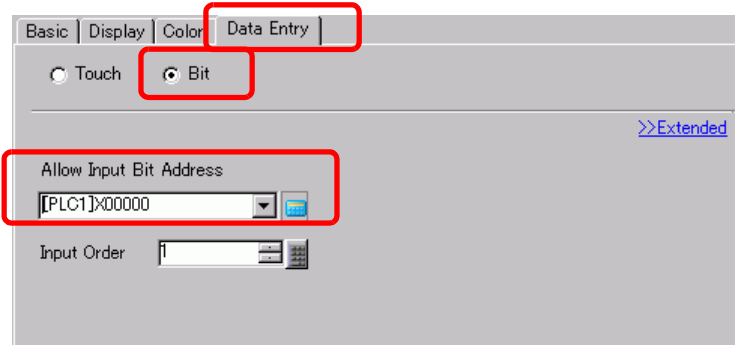

14 Click [Extended] and then select the [Input Barcode] check box.

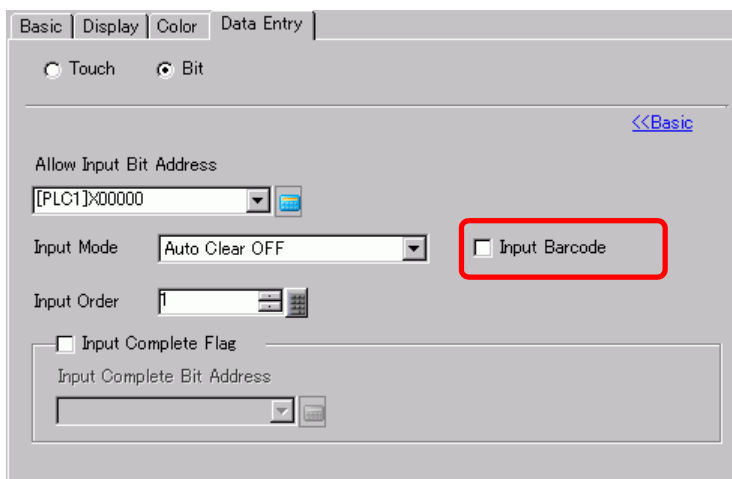

15 From the [Input Mode] drop-down list, select the processing method to overwrite the read code data.

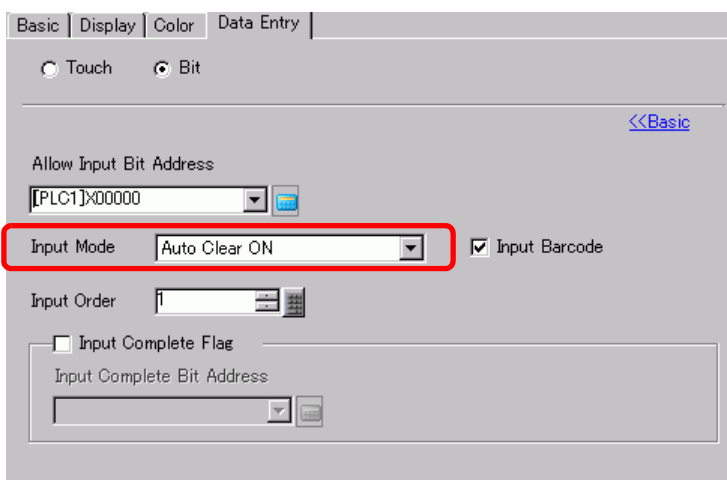

- 16 If necessary, set the Data Display part's color in the [Color] tab or text in the [Display] tab, and click [OK].

NOTE

- You have to set the bit switch to permit input for Data Display parts.
☞ "10.3 Inverting a Bit ON/OFF" (page 10-7)
 - One barcode reader can be connected to each the COM1 and USB port, but when connecting two barcode readers at the same time and storing the code data in the Data Display parts or the internal device from both barcodes, the system may not work properly. One barcode reader should be set up to read data from the Data Display part, and the other barcode reader should be set up to store data to the internal device.
 - If [Input Barcode] is not set in the [Data Entry] tab for the Data Display part, the read code data is not written to the Data Display part.
 - If the number of the read code data exceeds the [Display Characters] set for a Data Display part, the data cannot be properly displayed on the Data Display part. The maximum number of display characters that can be set in a Data Display part is 100 (single-byte) characters.
-

■ Two-dimensional Code Reader

Configure settings to store the code data read from a two-dimensional code reader from LS20 in the GP.

NOTE

- Please refer to the Settings Guide for details.
 ☞ "16.4.1 [Input Equipment Settings] Settings Guide" (page 16-22)

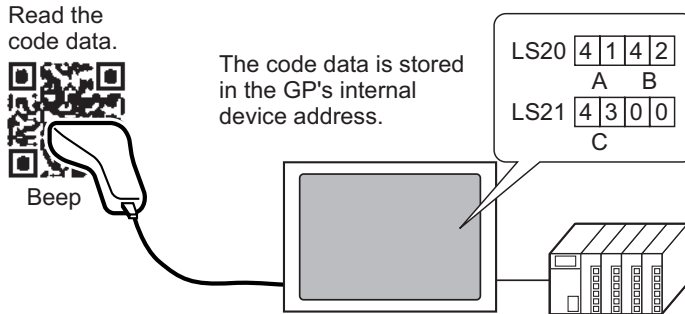

1 From the [System Settings], click [Input Equipment] to display the following screen.

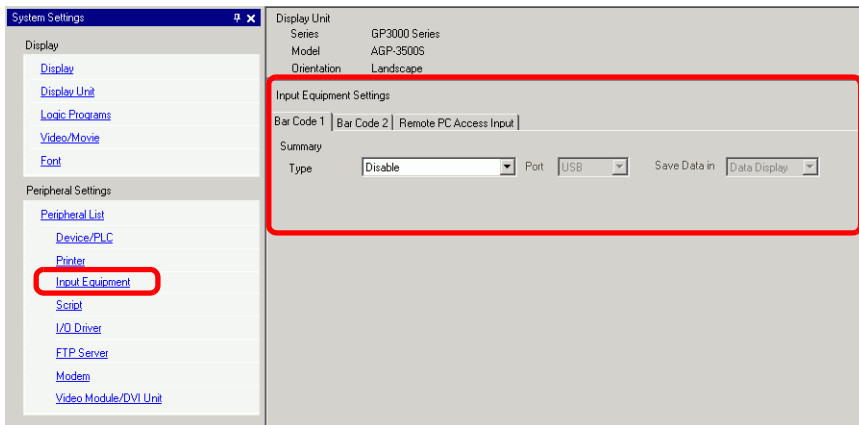

2 From the [Type] drop-down list, select [Two-Dimensional Code Reader].

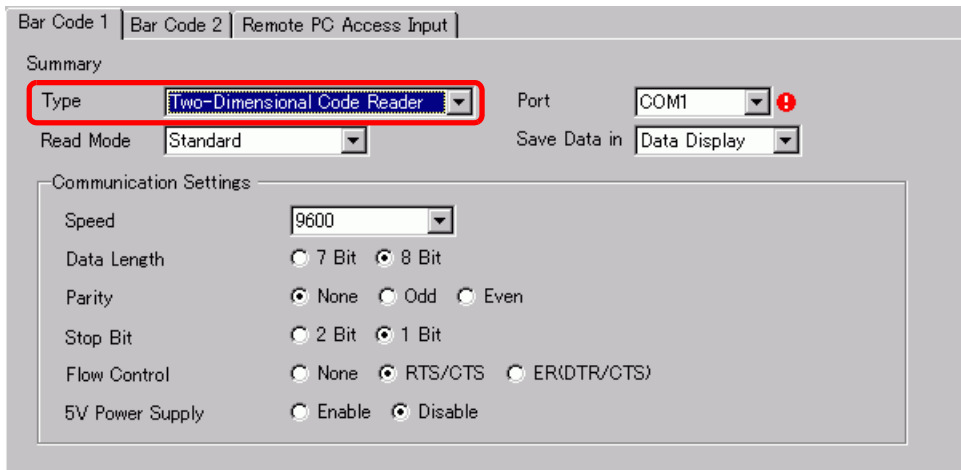

3 In the [Port] drop-down list, select the port to which you want to connect.

NOTE

- If the port is also used for other devices/PLCs,  displays to the right of the [Port] as above.
- A two-dimensional code reader can be set in COM1, USB, and USB/SIO. When IPC Series is selected on the Display, only COM1 can be set.

4 Set the [Read Mode].

5 In [Communication Settings], set [Speed], [Data Length], [Parity], [Stop Bit], [Flow Control], and [5V Power Supply].

6 From the [Save Data In] drop-down list, select a data storage location.

7 From the [Internal Device Storage Start Address] drop-down list, set the data storage internal device's start address (for example, LS20).

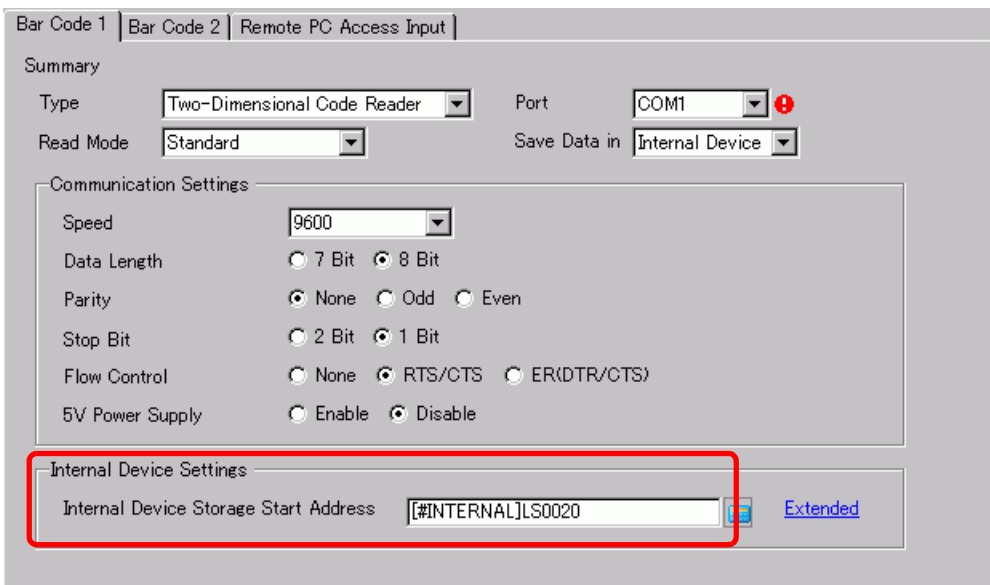

Click  to display an address input keypad.

Select the device "LS", input "20" in the address, and press the "Ent" key.

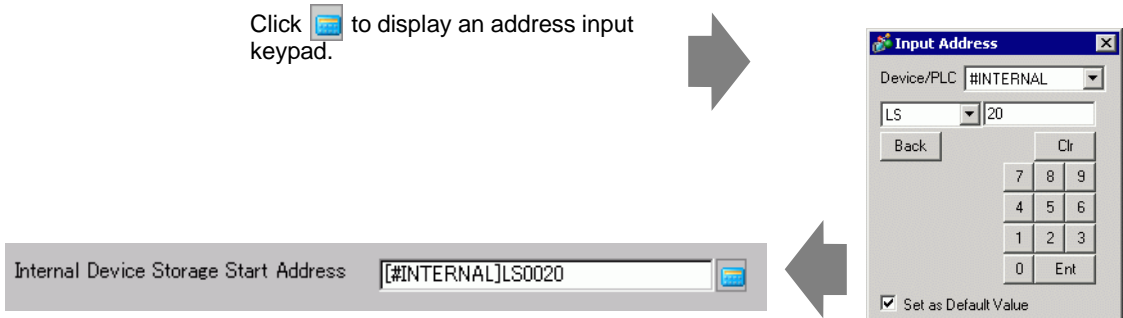

NOTE

- For the internal device's address setting range, refer to "16.2 Connecting a Barcode/Two-dimensional Code Reader ■ Storing Code Data in the GP Internal Device Address ◆ Usable Range of Internal Device Addresses" (page 16-16).

8 Click [Extended] to configure the [Read Completion Bit], [Data Size] and [Initialization Settings].

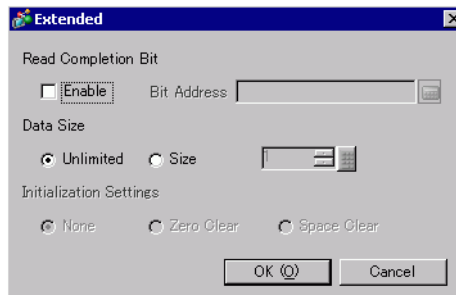

NOTE

- When [Read Completion Bit] is not set, when data is read continuously the data gets overwritten.
- If [Read Completion Bit] is set, turn OFF the [Read Completion Bit] when input is complete. The GP will not read code data without turning the read completion bit OFF.

16.2.3 Barcode Inputs

■ Storing Code Data in the Connected Device's Address

You can store the data read from the barcode in the Display Part [Monitor Word Address] field.

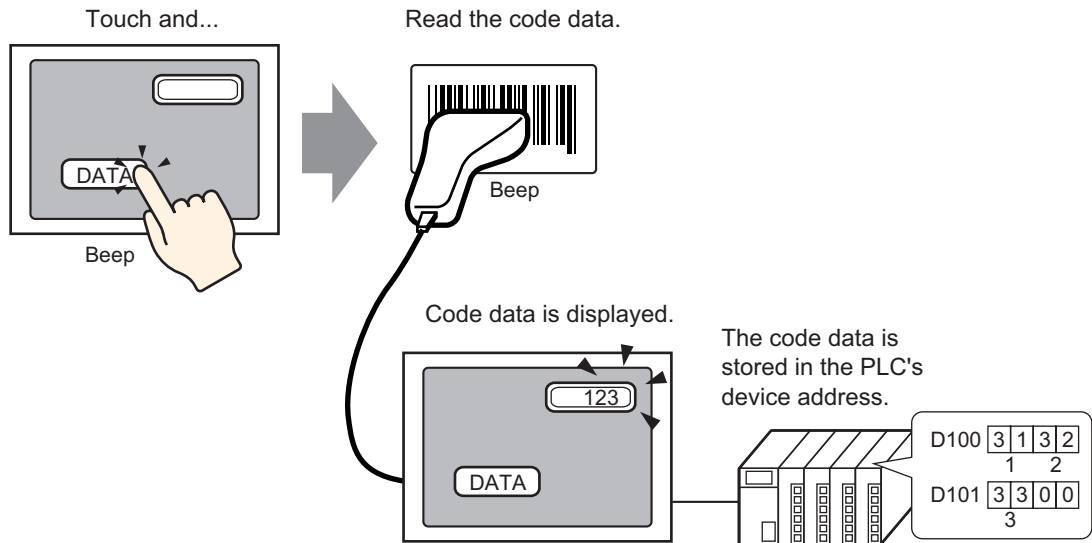

NOTE

- If [Input Barcode] in [Allow Input] has not been set for the data display parts, the data display parts cannot be written even though the code data is read.

■ Storing Code Data in the GP Internal Device Address

Sets the [Internal Device Storage Start Address] and stores the barcode data.

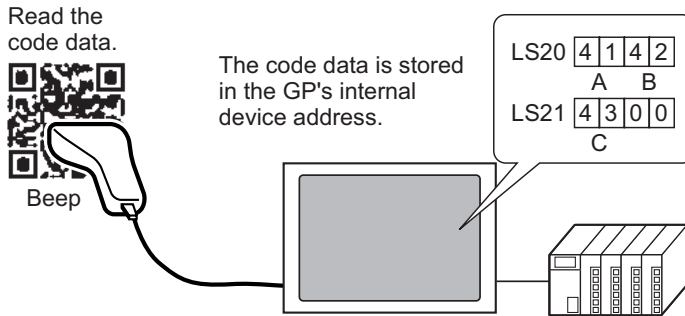

◆ Internal Device Storage Start Address

The barcode data is stored in the [Internal Device Storage Start Address] in the following order.

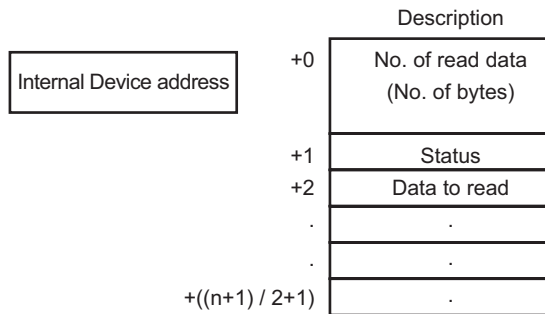

Number of Read Data (Number of Bytes) : The number of bytes to read.

Status : If the data is not read normally or is not written to the internal device address, an error code is stored.

Error Contents

0000h	—
0001h	Read normally.
0002h	Code data read error. Not stored in internal device address.
0003h	Received code data exceeding the maximum number of bytes. The number of bytes of code data, as set in the [Extended] dialog box's [Size] field, is stored to the internal device address. In this case the read completion bit address (when Yes is set) turns ON. Please be aware that any data that exceeds the range is not written to the internal device address.

NOTE

- The read two-dimensional code data is stored according to the [Text Data Mode] set in the GP.
 - ☞ "5.17.6 [System Settings] Setting Guide ■ [Device/PLC] Settings Guide" (page 5-182)

◆ Usable Range of Internal Device Addresses

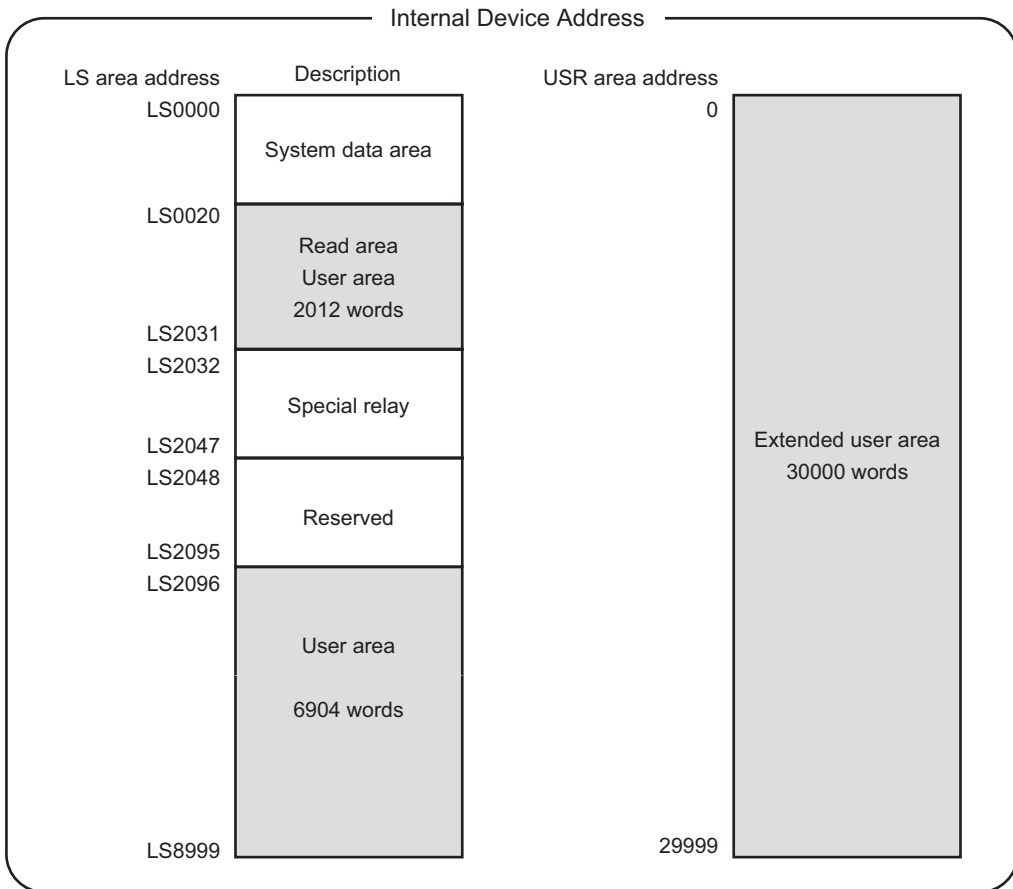

NOTE

- If the data size is out of range, the data within the shaded range is written to the internal device address. However, the status is 0003h (Received code data exceeding the maximum number of bytes allowed for LS storage).

16.3 Display USB Keyboard Inputs

16.3.1 Introduction

You can connect a USB Keyboard to the display unit on the GP screen to input single-byte alphanumeric characters.

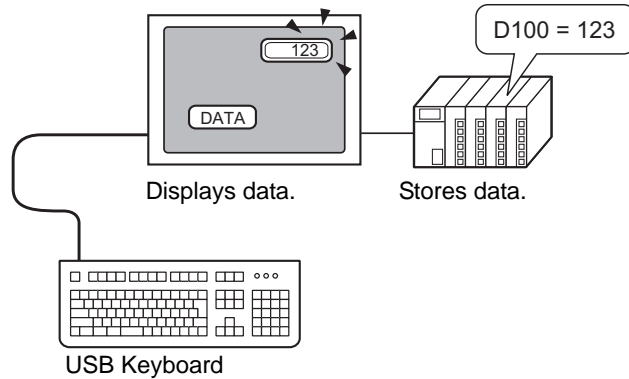
**NOTE**

- You can use a USB Keyboard only for inputting data to a Data Display part that allows barcode inputs. You cannot use the keyboard to enter passwords or other types of data.
- When using WinGP, you can use a PS/2 Keyboard to enter data to a Data Display part.

16.3.2 Setup Procedure

When [Allow Input Bit Address] (X50) is ON, numeric values entered via the USB keyboard are displayed on the Data Display. Define the data storage location of data input from the USB Keyboard as D100 in the Device/PLC.

1 Configure the settings for an external input device.

From the System Settings, click [Input Equipment] to display the following screen.

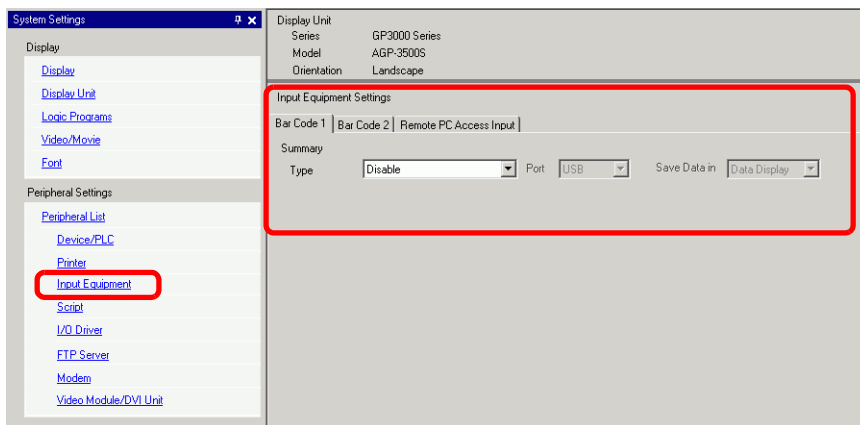

NOTE

- To display the System Settings, from the [View (V)] menu, point to [Work Space] and then select [System Settings].

2 Set [Type] to [Bar Code Reader] and [Port] to [USB]. [In the [Save Data in] field, select [Data Display].

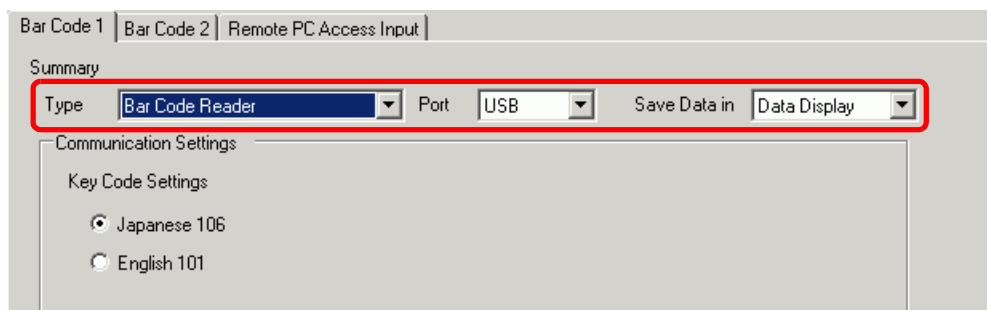

3 Open the screen and configure the Data Display part used to display USB keyboard inputs.

On the [Parts (P)] menu, select [Data Display (D)] and then click [Numeric Display (N)], or click the  icon, and place the Numeric Display on the screen.

4 Double-click the placed element. The Data Display dialog box appears.

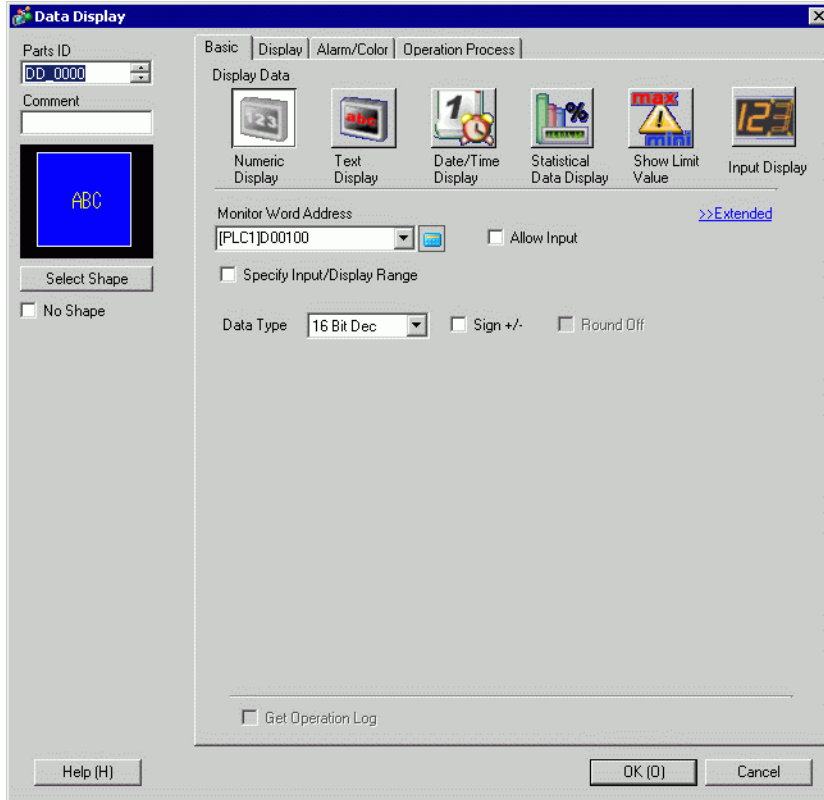

5 Click [Select Shape] and select the appropriate shape.

6 In the [Monitor Word Address] field, select the address (D100) that stores data inputs.

Select device "D", input "100" as the address, and press the Enter key.

Click  to display an address input keypad.

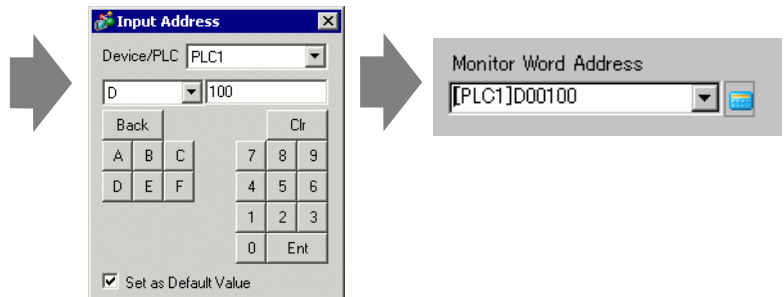

7 Select a data type in [Data Type], and then select the [Allow Input] check box.

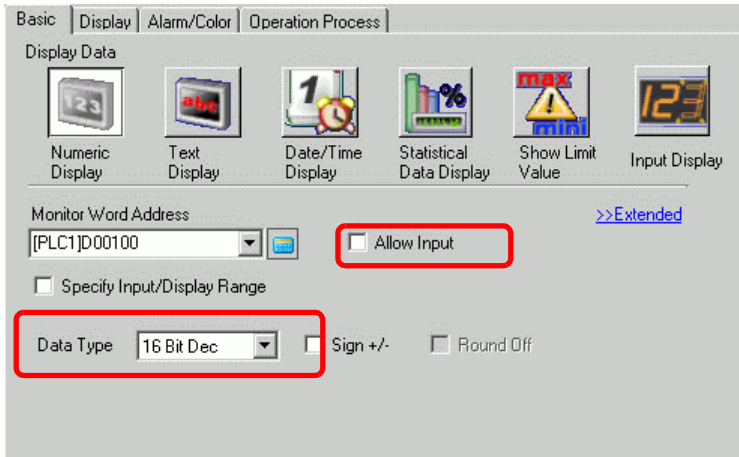

8 Click the [Allow Input] tab, and select [Bit]. [Allow Input Bit Address] field should be defined. Data input is enabled when this bit address is ON.

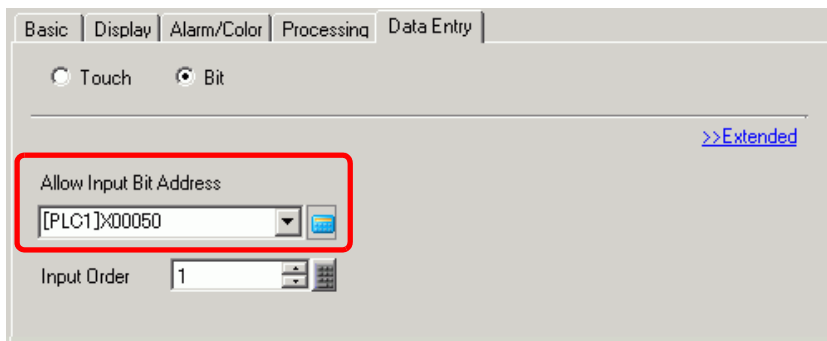

9 Click [Extended] and then select the [Input Barcode] check box. This enables you to input data from an external input device.

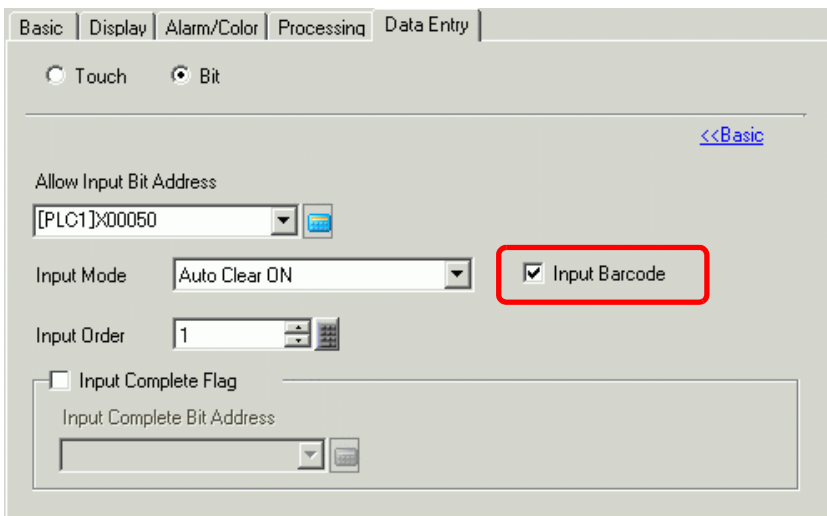

10 As needed, define the Data Display colors in the [Color] tab and fonts in the [Display] tab, and click [OK].

■ Keys You Can Input via a USB Keyboard

Key Name	Remarks
0 to 9	Numeric and character input
a to f	Numeric (HEX) and character input
g to z	Character Input
Tenkey: 0 to 9	Numeric and character input
Tenkey "*"	Character Input
Tenkey "+"	Character Input
Tenkey ", "	Character Input
Tenkey "-"	Character Input
Tenkey "."	Numeric input (Float) and character input
Tenkey "/"	Character Input
:	Character Input
;	Character Input
,	Character Input
-	Character Input
.	Numeric input (Float) and character input
/	Character Input
@	Character Input
[Character Input
	Character Input
]	Character Input
^	Character Input
_	Character Input
Enter	Determine Input
BackSpace	Delete One Character to the Left
ESC	Cancel Input
Delete	Delete One Character
Space (Blank)	Character Input
<--	Move Cursor to the Left
-->	Move Cursor to the Right

You cannot use keys not included in the above table, such as control keys [Ctrl], [Shift], [Alt], and [Tab], function keys [F1] to [F12], and the up/down arrow keys.

16.4 Settings Guide

16.4.1 [Input Equipment Settings] Settings Guide

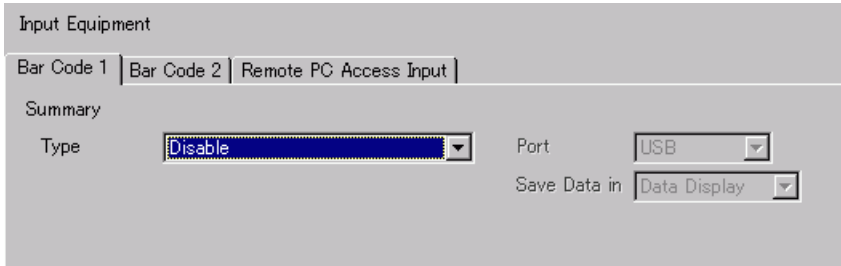

Setting	Description
Type	Select the barcode type to connect. <ul style="list-style-type: none"> • Disable Select when a barcode reader is not in use. • Bar Code Reader Select when using a barcode reader. • Two-dimensional Code Reader Select when using a two-dimensional code reader.
Disable	Select when a barcode/two-dimensional code reader is not in use.
Bar Code Reader	Select when using a barcode reader.
Port	Select the port from which to connect to [COM1]: [USB/SIO] or [USB].
COM1	Select when connecting to COM1. <div style="border: 1px solid black; padding: 5px; margin-top: 10px;"> </div>

Continued

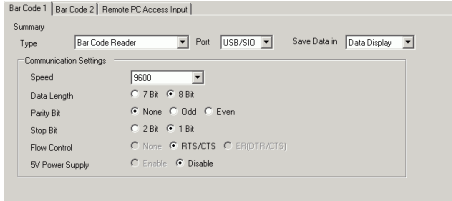
Setting		Description			
Type	Bar Code Reader	Port	COM1	Communication Settings	Configure communication settings.
				Speed	Select a communication speed from [2400], [4800], [9600], [19200], [38400], [57600] or [115200].
				Data Length	Choose the communication data length from [7 bit] or [8 bit].
				Parity Bit	Select the communication parity bit: [Even], [Odd] or [None].
				Stop Bit	Choose the communication stop bit length: [1 bit] or [2 bit].
				Flow Control	Select the communication control method: [None], [RTS/CTS Control], or [ER(DTR/CTS) Control].
				5V Power Supply	Designate whether or not to set the 5V power supply.
			USB/SIO	Select when connecting to the USB/SIO port. 	
			Communication Settings	Configure communication settings.	
				Speed	Select a communication speed from [2400], [4800], [9600], [19200], [38400], [57600] or [115200].
				Data Length	Choose the communication data length from [7 bit] or [8 bit].
				Parity	Select the communication parity bit: [Even], [Odd] or [None].
				Stop Bit	Choose the communication stop bit length: [1 bit] or [2 bit].
				Flow Control	Set to [None] and other selections are disabled.
5V Power Supply	5V Power Supply is fixed as [Disable].				

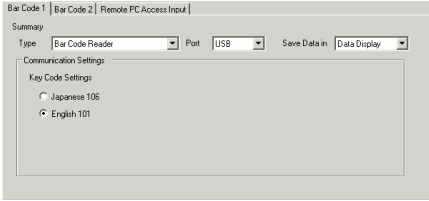
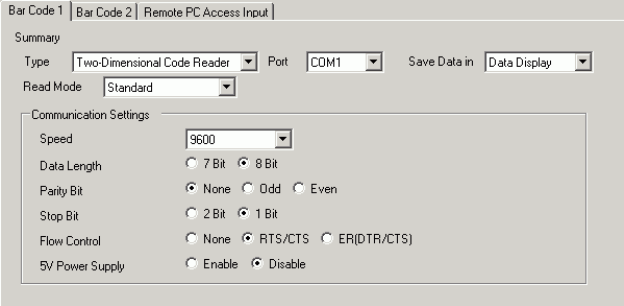

Continued

Setting			Description
Type	Bar Code Reader	Port	<p>Select this when connecting to the USB port.</p> 
		Communication Settings	Configure communication settings.
		Key code Setting	Select the text type that the barcode reader reads: [Japanese 106 Keypad] or [English 101 Keypad].
	Two-dimensional Code Reader		Select when using a two-dimensional code reader.
	Port		<p>Set the port to which to connect the barcode reader. 2-dimensional Code Reader can be set in COM1 or USB. When IPC Series is selected for the Display, it can be set only in COM1.</p> <p>NOTE</p> <ul style="list-style-type: none"> When [USB] is selected, set up items for [Communication Settings] will not be displayed.
	COM1		Select when connecting to COM1.
			
	Communication Settings		Configure communication settings.
	Speed		Select a communication speed from [2400], [4800], [9600], [19200], [38400], [57600] or [115200].
	Data Length		Choose the communication data length from [7 bit] or [8 bit].
Parity Bit		Select the communication parity bit: [Even], [Odd] or [None].	
Stop Bit		Choose the communication stop bit length: [1 bit] or [2 bit].	

Continued

Setting					Description																				
Type	Two-dimensional Code Reader	Port	COM1	Communication Settings	Flow Control	<p>Select the communication control method: [None], [RTS/CTS Control], or [ER(DTR/CTS) Control].</p> <p>NOTE</p> <ul style="list-style-type: none"> When [USB/SIO] is selected for [Port], only [RTS/STC Control] can be set. 																			
					5V Power Supply	<p>Designate whether or not to set the 5V power supply.</p> <p>NOTE</p> <ul style="list-style-type: none"> When [USB/SIO] is selected for [Port], it will be set as [Disable]. 																			
		Read Mode					<p>Select the read mode.</p> <ul style="list-style-type: none"> Standard <table border="1" style="margin-left: 20px;"> <tr> <td>Code Data</td> <td>Terminator (CR)</td> </tr> </table> <p>In [Standard] mode, binary data cannot be handled. In this mode, two-dimensional code readers from other manufacturers can read data using the above setting.</p> <ul style="list-style-type: none"> DENSO QR Code Reader <table border="1" style="margin-left: 20px;"> <tr> <td>Header</td> <td>Code Mark</td> <td>No. of Digits (4 bytes)</td> <td>Code Data</td> <td>Terminator</td> <td>BCC</td> </tr> <tr> <td>STX (Fixed)</td> <td>Has code</td> <td>Has code</td> <td>—</td> <td>CR (Fixed)</td> <td>Has code</td> </tr> </table> <p>In [DENSO QR Code Reader] mode, binary data can be handled. But in this case, the above communication format needs to be set to a two-dimensional code reader as well.</p> <ul style="list-style-type: none"> Tohken Code Reader <table border="1" style="margin-left: 20px;"> <tr> <td>Header</td> <td>Code Data</td> <td>Terminator</td> </tr> <tr> <td>STX (Fixed)</td> <td>—</td> <td>CR+LF (Fixed)</td> </tr> </table> <p>In [Tohken Code Reader] mode, the above communication format needs to be set to a two-dimensional code reader as well. Binary data cannot be handled in [Tohken Code Reader] mode. Unlike DENSO's, the Tohken code reader does not check the number of digits or BBC and determines that the code data ends at the CR+LF code in the code data.</p> <p>NOTE</p> <ul style="list-style-type: none"> When [Port] is "USB" and [Type] is "Two-dimensional Code Reader", only "Standard" Read Mode can be set. 	Code Data	Terminator (CR)	Header	Code Mark	No. of Digits (4 bytes)	Code Data	Terminator	BCC	STX (Fixed)	Has code	Has code	—	CR (Fixed)	Has code	Header	Code Data	Terminator	STX (Fixed)
Code Data	Terminator (CR)																								
Header	Code Mark	No. of Digits (4 bytes)	Code Data	Terminator	BCC																				
STX (Fixed)	Has code	Has code	—	CR (Fixed)	Has code																				
Header	Code Data	Terminator																							
STX (Fixed)	—	CR+LF (Fixed)																							

Continued

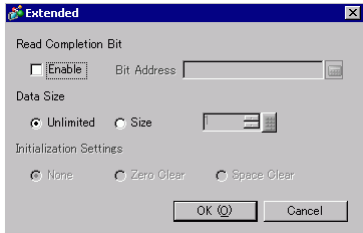
Setting		Description
Save Data in		Select the code data storage location as either [Data Display] or [Internal Device].
Data Display		Stores the data in the [Monitor Word Address] set on the Data Display part. 
Internal Device		Store the data in the Internal Device Address. 
Internal Display		Configure settings to store the read code data in the internal device. 
Internal Device Storage Start Address		Set the internal device address to store the read code data.
Extended		
Read Completion Bit	Enable	Determine whether to turn ON the read completion bit address if the entire data has been written to the internal device address. NOTE <ul style="list-style-type: none"> When [Read Completion Bit] is not set, the data is overwritten if read continuously.

Continued

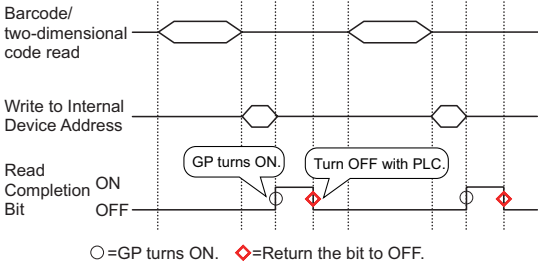
Setting					Description
Save Data In	Internal Device	Internal Display	Extended	Read Completion Bit	<p>Set the read completion bit address.</p> <p>NOTE</p> <ul style="list-style-type: none"> • Please return this bit to OFF after input has been completed. The GP will not read code data without turning the read completion bit OFF. • The barcode/two-dimensional code's read timing and the [Read Completion Bit Address]'s action are as follows:  <p>○=GP turns ON. ◊=Return the bit to OFF.</p>
				Unlimited	<p>Set the code data size stored in the internal device address at read time to unlimited.</p> <p>NOTE</p> <ul style="list-style-type: none"> • If the read code data exceeds the enabled area, the excess data will not be written.
				Specified Size	<p>Set the code data size stored in the internal device address at the read time from 1 to 9,999.</p> <p>NOTE</p> <ul style="list-style-type: none"> • If the read code data exceeds the [Specified Size], the excess data will not be written to the internal device address.

Continued

Setting				Description																																																																								
Save Data In	Internal Device	Internal Display	Extended	<p>Initialization Settings</p> <p>Select the processing method when overwriting the read data code data from [None], [Zero Clear] or [Space Clear].</p> <p>For example, when code data "12345678" is stored, and then code data "ABCDE" is stored, the [Data Size] is 8 bytes.</p> <p>Previous Display: The 8-byte code data "12345678" is stored.</p> <div style="display: flex; justify-content: space-around;"> <div style="text-align: center;"> <p>(Actual display)</p> <div style="border: 1px solid black; padding: 2px; display: inline-block;">12345678</div> </div> <div style="text-align: center;"> <p>(In the internal device address)</p> <table border="1" style="border-collapse: collapse; text-align: center;"> <tr><td>+0</td><td>0</td><td>8</td></tr> <tr><td>+1</td><td>0</td><td>0</td></tr> <tr><td>+2</td><td>'1'</td><td>'2'</td></tr> <tr><td>+3</td><td>'3'</td><td>'4'</td></tr> <tr><td>+4</td><td>'5'</td><td>'6'</td></tr> <tr><td>+5</td><td>'7'</td><td>'8'</td></tr> </table> <p>Currently stored code data</p> </div> </div> <p style="text-align: center; font-size: 2em;">↓</p> <p>Current Display: Reads the 5-byte code data "ABCDE".</p> <ul style="list-style-type: none"> • For [None] <div style="display: flex; justify-content: space-around; margin-top: 10px;"> <div style="text-align: center;"> <div style="border: 1px solid black; padding: 2px; display: inline-block;">ABCDE678</div> </div> <div style="text-align: center;"> <table border="1" style="border-collapse: collapse; text-align: center;"> <tr><td>+0</td><td>0</td><td>5</td></tr> <tr><td>+1</td><td>0</td><td>0</td></tr> <tr><td>+2</td><td>'A'</td><td>'B'</td></tr> <tr><td>+3</td><td>'C'</td><td>'D'</td></tr> <tr><td>+4</td><td>'E'</td><td>'6'</td></tr> <tr><td>+5</td><td>'7'</td><td>'8'</td></tr> </table> <p>Displayed with the previous display remaining.</p> </div> </div> • For [Zero Clear] (data clear with Null) <div style="display: flex; justify-content: space-around; margin-top: 10px;"> <div style="text-align: center;"> <div style="border: 1px solid black; padding: 2px; display: inline-block;">ABCDE</div> </div> <div style="text-align: center;"> <table border="1" style="border-collapse: collapse; text-align: center;"> <tr><td>+0</td><td>0</td><td>5</td></tr> <tr><td>+1</td><td>0</td><td>0</td></tr> <tr><td>+2</td><td>'A'</td><td>'B'</td></tr> <tr><td>+3</td><td>'C'</td><td>'D'</td></tr> <tr><td>+4</td><td>'E'</td><td>00h</td></tr> <tr><td>+5</td><td>00h</td><td>00h</td></tr> </table> <p>The previous code data is overwritten with NULL = "00 (h)".</p> </div> </div> • For [Space Clear] <div style="display: flex; justify-content: space-around; margin-top: 10px;"> <div style="text-align: center;"> <div style="border: 1px solid black; padding: 2px; display: inline-block;">ABCDE_ _ _</div> </div> <div style="text-align: center;"> <table border="1" style="border-collapse: collapse; text-align: center;"> <tr><td>+0</td><td>0</td><td>5</td></tr> <tr><td>+1</td><td>0</td><td>0</td></tr> <tr><td>+2</td><td>'A'</td><td>'B'</td></tr> <tr><td>+3</td><td>'C'</td><td>'D'</td></tr> <tr><td>+4</td><td>'E'</td><td>20h</td></tr> <tr><td>+5</td><td>20h</td><td>20h</td></tr> </table> <p>The previous code data is overwritten with a space_ = "20(h)".</p> </div> </div> 	+0	0	8	+1	0	0	+2	'1'	'2'	+3	'3'	'4'	+4	'5'	'6'	+5	'7'	'8'	+0	0	5	+1	0	0	+2	'A'	'B'	+3	'C'	'D'	+4	'E'	'6'	+5	'7'	'8'	+0	0	5	+1	0	0	+2	'A'	'B'	+3	'C'	'D'	+4	'E'	00h	+5	00h	00h	+0	0	5	+1	0	0	+2	'A'	'B'	+3	'C'	'D'	+4	'E'	20h	+5	20h	20h
				+0	0	8																																																																						
				+1	0	0																																																																						
+2	'1'	'2'																																																																										
+3	'3'	'4'																																																																										
+4	'5'	'6'																																																																										
+5	'7'	'8'																																																																										
+0	0	5																																																																										
+1	0	0																																																																										
+2	'A'	'B'																																																																										
+3	'C'	'D'																																																																										
+4	'E'	'6'																																																																										
+5	'7'	'8'																																																																										
+0	0	5																																																																										
+1	0	0																																																																										
+2	'A'	'B'																																																																										
+3	'C'	'D'																																																																										
+4	'E'	00h																																																																										
+5	00h	00h																																																																										
+0	0	5																																																																										
+1	0	0																																																																										
+2	'A'	'B'																																																																										
+3	'C'	'D'																																																																										
+4	'E'	20h																																																																										
+5	20h	20h																																																																										
Remote PC Access Input				<p>Set the input device for operation of the server screen from the display.</p> <p>☞ "36.4.2 System Settings [Input Equipment Settings] - [Remote PC Access Input] Settings Guide" (page 36-27)</p>																																																																								

16.5 Restrictions

16.5.1 Bar Code Restrictions

- If the [Save Data in] is set to [Internal Device] and [Read Completion Bit] is set, turn OFF the [Read Completion Bit] when input is complete. The GP will not read code data without turning the read completion bit OFF.
- When the [Parity Bit] is [None] and the communication speed settings for the barcode reader are different from those of the GP, the system may read invalid data because it cannot detect errors. Use the same communication settings for both the devices.
- When you do not use the [Input Complete Bit Address] setting, reading in data continuously will overwrite previous code data.
- If switching between screens while entering data, the switching process takes priority and the data being input is ignored.
- If [Input Barcode] is not set in the [Data Entry] tab for the Data Display part, the read code data is not written to the Data Display part.
- If the number of the read code data exceeds the [Display Characters] set for a Data Display part, the data cannot be properly displayed on the Data Display part. The maximum number of display characters that can be set in a Data Display part is 100 (single-byte) characters.
- One barcode reader can be connected to each the COM1 and USB port, but when connecting two barcode readers at the same time and storing the code data in the Data Display parts or the internal device from both barcodes, the system may not work properly. 1 barcode reader should be set up to read data from the Data Display part and the other barcode reader set up to store data to the internal device.

16.5.2 Restrictions for using a Two-dimensional Code Reader

- The IPC series is only compatible with COM1.

16.5.3 USB Keyboard Restrictions

- USB keyboard restrictions include all the barcode restrictions described in previous sections.
- You can use the USB keyboard to enter data in the Data Display parts setup to allow barcode inputs. You cannot use the keyboard to enter passwords or other types of data.
- When reading BackSpace, ESC, Delete, Left Arrow, and Right Arrow key codes from the barcode reader, the control keys are processed the same as if they are input from the USB Keyboard.
- Japanese kanji characters are not supported.
- When using WinGP, you can use a PS/2 Keyboard to enter data to a Data Display part. In the [System Settings], set [Port] to [USB].
- When using Remote PC Access with a USB Keyboard, you cannot use the USB keyboard feature.

