



Flexi Soft Driver

1	System Configuration.....	3
2	External Device Selection	7
3	Communication Settings	8
4	Setup Items	10
5	Cable Diagrams	16
6	Supported Device.....	17
7	Device Code and Address Code.....	22
8	Error Messages	23

Introduction

This manual describes how to connect the Display and the External Device (target PLC).

In this manual, the connection procedure is described in the sections identified below.

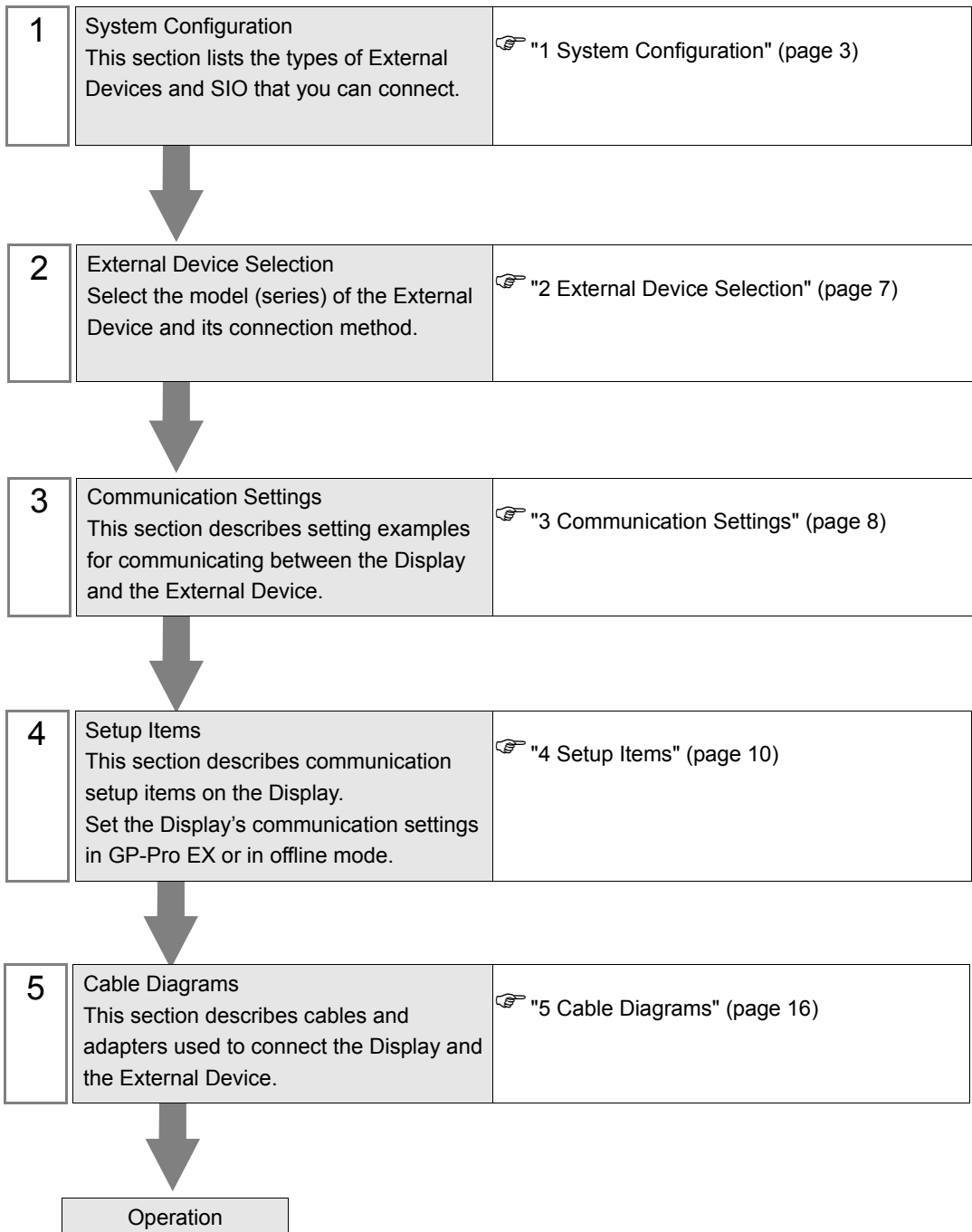

1 System Configuration

The system configuration when the External Device of SICK AG and the Display are connected is shown.

Series	CPU	Link I/F	SIO Type	Setting Example	Cable Diagram
Flexi Soft	FX3-CPU0 FX3-CPU1	Port 1 on CPU unit	RS-232C	Setting Example 1 (page 8)	Cable Diagram 1 (page 16)

■ Connection Configuration

- 1:1 Connection



- 1:n Connection

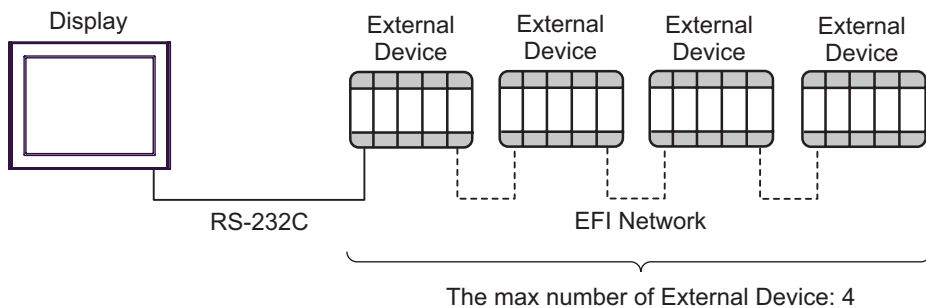

-
- NOTE** • Ladder software from SICK AG (Flexi Soft Designer) and a Display cannot be used simultaneously with External Devices in 1:n connection.
-

■ IPC COM Port

When connecting IPC with an External Device, the COM port used depends on the series and SIO type. Please refer to the IPC manual for details.

Usable port

Series	Usable Port		
	RS-232C	RS-422/485(4 wire)	RS-422/485(2 wire)
PS-2000B	COM1 ^{*1} , COM2, COM3 ^{*1} , COM4	-	-
PS-3450A, PS-3451A, PS3000-BA, PS3001-BD	COM1, COM2 ^{*1*2}	COM2 ^{*1*2}	COM2 ^{*1*2}
PS-3650A (T41 model), PS-3651A (T41 model)	COM1 ^{*1}	-	-
PS-3650A (T42 model), PS-3651A (T42 model)	COM1 ^{*1*2} , COM2	COM1 ^{*1*2}	COM1 ^{*1*2}
PS-3700A (Pentium®4-M) PS-3710A	COM1 ^{*1} , COM2 ^{*1} , COM3 ^{*2} , COM4	COM3 ^{*2}	COM3 ^{*2}
PS-3711A	COM1 ^{*1} , COM2 ^{*2}	COM2 ^{*2}	COM2 ^{*2}
PS4000 ^{*3}	COM1, COM2	-	-
PL3000	COM1 ^{*1*2} , COM2 ^{*1} , COM3, COM4	COM1 ^{*1*2}	COM1 ^{*1*2}
PE-4000B Atom N270	COM1, COM2	-	-
PE-4000B Atom N2600	COM1, COM2	COM3 ^{*4} , COM4 ^{*4} , COM5 ^{*4} , COM6 ^{*4}	COM3 ^{*4} , COM4 ^{*4} , COM5 ^{*4} , COM6 ^{*4}
PS5000 (Slim Panel Type Core i3 Model) ^{*5*6}	COM1, COM2 ^{*4}	COM2 ^{*4}	COM2 ^{*4}
PS5000 (Slim Panel Type Atom Model) ^{*5*6}	COM1, COM2 ^{*7}	COM2 ^{*7}	COM2 ^{*7}
PS5000 (Enclosed Panel Type) ^{*8}	COM1	-	-
PS5000 (Modular Type PFXPU/PFXPP) ^{*5*6} PS5000 (Modular Type PFXPL2B5-6)	COM1 ^{*7}	COM1 ^{*7}	COM1 ^{*7}
PS5000 (Modular Type PFXPL2B1-4)	COM1, COM2 ^{*7}	COM2 ^{*7}	COM2 ^{*7}
PS6000	COM1 ^{*9}	^{*10}	^{*10}

*1 The RI/5V can be switched. Use the IPC's switch to change if necessary.

*2 Set up the SIO type with the DIP Switch. Please set up as follows according to SIO type to be used.

*3 When making communication between an External Device and COM port on the Expansion slot, only RS-232C is supported. However, ER (DTR/CTS) control cannot be executed because of the specification of COM port.

For connection with External Device, use user-created cables and disable Pin Nos. 1, 4, 6 and 9. Please refer to the IPC manual for details of pin layout.

*4 Set up the SIO type with the BIOS. Please refer to the IPC manual for details of BIOS.

- *5 When setting up communication between an External Device and the RS-232C/422/485 interface module, use the IPC (RS-232C) or PS5000 (RS-422/485) cable diagrams. However, when using PFXZPBMPR42P2 in a RS-422/485 (4-wire) configuration with no flow control, connect 7.RTS+ and 8.CTS+, and connect 6.RTS- and 9.CTS-.
When using RS-422/485 communication with External Devices, you may need to reduce the transmission speed and increase the TX Wait time.
- *6 To use RS-422/485 communication on the RS-232C/422/485 interface module, the DIP Switch setting is required. Please refer to "Knowledge Base" (FAQs) on the support site. (<http://www.pro-face.com/trans/en/manual/1001.html>)

Settings	FAQ ID
PFXZPBMPR42P2, RS422/485 change method	FA263858
PFXZPBMPR42P2 termination resistor setting	FA263974
PFXZPBMPR44P2, RS422/485 change method	FA264087
PFXZPBMPR44P2 termination resistor setting	FA264088

- *7 Set up the SIO type with the DIP Switch. Please refer to the IPC manual for details of DIP Switch. The BOX Atom has not a switch to set the RS-232C, RS-422/485 mode. Use the BIOS for the setting.
- *8 For the connection with the External Device, on the user-created cable read as if the connector on the Display-side is a M12 A-coding 8 pin socket. The pin assignment is the same as described in the cable diagram. For the M12 A-coding connector, use PFXZPSCNM122.
- *9 In addition to COM1, you can also use the RS-232C COM port on the optional interface.
- *10 Install the optional interface in the expansion slot.

DIP Switch settings (PL3000 / PS3000 Series)

RS-232C

DIP Switch	Setting	Description
1	OFF*1	Reserved (always OFF)
2	OFF	SIO type: RS-232C
3	OFF	
4	OFF	Output mode of SD (TXD) data: Always output
5	OFF	Terminal resistance (220Ω) insertion to SD (TXD): None
6	OFF	Terminal resistance (220Ω) insertion to RD (RXD): None
7	OFF	Short-circuit of SDA (TXA) and RDA (RXA): Not available
8	OFF	Short-circuit of SDB (TXB) and RDB (RXB): Not available
9	OFF	RS (RTS) Auto control mode: Disabled
10	OFF	

*1 When using PS-3450A, PS-3451A, PS3000-BA and PS3001-BD, turn ON the set value.

RS-422/485 (4 wire)

DIP Switch	Setting	Description
1	OFF	Reserved (always OFF)
2	ON	SIO type: RS-422/485
3	ON	
4	OFF	Output mode of SD (TXD) data: Always output
5	OFF	Terminal resistance (220Ω) insertion to SD (TXD): None
6	OFF	Terminal resistance (220Ω) insertion to RD (RXD): None
7	OFF	Short-circuit of SDA (TXA) and RDA (RXA): Not available
8	OFF	Short-circuit of SDB (TXB) and RDB (RXB): Not available
9	OFF	RS (RTS) Auto control mode: Disabled
10	OFF	

RS-422/485 (2 wire)

DIP Switch	Setting	Description
1	OFF	Reserved (always OFF)
2	ON	SIO type: RS-422/485
3	ON	
4	OFF	Output mode of SD (TXD) data: Always output
5	OFF	Terminal resistance (220Ω) insertion to SD (TXD): None
6	OFF	Terminal resistance (220Ω) insertion to RD (RXD): None
7	ON	Short-circuit of SDA (TXA) and RDA (RXA): Available
8	ON	Short-circuit of SDB (TXB) and RDB (RXB): Available
9	ON	RS (RTS) Auto control mode: Enabled
10	ON	

2 External Device Selection

Select the External Device to connect to the Display.

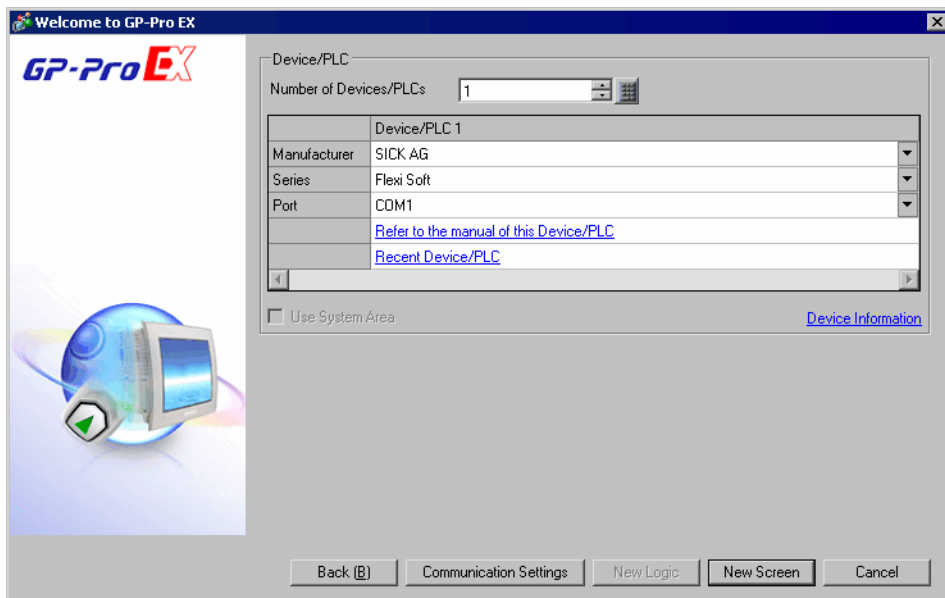

Setup Items	Setup Description
Number of Devices/PLCs	Enter an integer from 1 to 4 to define the number of Devices/PLCs to connect to the display.
Manufacturer	Select the manufacturer of the External Device to connect. Select "SICK AG".
Series	Select the External Device model (series) and the connection method. Select "Flexi Soft". In System configuration, make sure the External Device you are connecting is supported by "Flexi Soft". ☞ "1 System Configuration" (page 3)
Port	Select the Display port to connect to the External Device.
Use System Area	Check this option to synchronize the system data area of the Display and the device (memory) of the External Device. When synchronized, you can use the External Device's ladder program to switch the display or display the window on the Display. Cf. GP-Pro EX Reference Manual "LS Area (Direct Access Method Area)" This feature can also be set in GP-Pro EX or in the Display's offline mode. Cf. GP-Pro EX Reference Manual "System Settings [Display Unit] - [System Area] Settings Guide" Cf. Maintenance/Troubleshooting Guide "Main Unit - System Area Settings"

3 Communication Settings

This section provides examples of communication settings recommended by Pro-face for the Display and the External Device.

3.1 Setting Example 1

■ GP-Pro EX Settings

◆ Communication Settings

To display the setup screen, from the [Project] menu, point to [System Settings] and select [Device/PLC].

Device/PLC 1

Summary [Change Device/PLC](#)

Manufacturer Series Port

Text Data Mode [Change](#)

Communication Settings

SIO Type RS232C RS422/485(2wire) RS422/485(4wire)

Speed Auto Baudrate

Data Length 7 8

Parity NONE EVEN ODD

Stop Bit 1 2

Flow Control NONE ER(DTR/CTS) XON/XOFF

Timeout (sec)

Retry

Wait To Send (ms)

Data Refresh Cycle (sec)

Client ID

RI / VCC RI VCC

In the case of RS232C, you can select the 9th pin to RI (Input) or VCC (5V Power Supply). If you use the Digital's RS232C Isolation Unit, please select it to VCC.

[Default](#)

Device-Specific Settings

Allowable Number of Devices/PLCs [Add Device](#)

No.	Device Name	Settings	Add Indirect Device
<input type="text" value="1"/>	<input type="text" value="PLC1"/>	<input type="text" value="Station Address=Direct"/>	<input type="button" value="+"/>

NOTE

- Set Timeout to 2 (sec) or more.

◆ Device Setting

To display the [Individual Device Settings] dialog box, from [Device-Specific Settings] in the [Device/PLC] window, select the external device and click [Settings] .

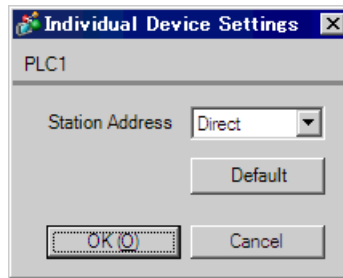

■ External Device Settings

Use Flexi Soft Designer to perform communication settings for the External Device. Refer to your External Device manual for details.

- 1 Start Flexi Soft Designer.
- 2 Select [New] from the [Project] menu, and select [Standalone station project] for a 1:1 connection and [Flexi Link system project] for a 1:n connection.
- 3 In the [Hardware configuration] screen, select the CPU to use.

NOTE

- For a 1:n connection, click the [Adds a new station] icon in the [System overview] screen to display the [Hardware configuration] screen. For hardware configuration, it is necessary to perform settings for the number of External Devices connected.

- 4 To display the [Settings] dialog box, click the [Settings] icon.
- 5 Select the [General] tab and place a check next to [Enable RS232 routing for the CPU].
- 6 After clicking [Connect], click [Network settings].
- 7 Drag each of the displayed devices to allocate a station address from A to D.

NOTE

- In the PLC communication settings, the following parameter settings are fixed.

Speed	115200
Data Length	8
Parity	OFF
EVEN/ODD	NONE
Stop Bit	1
Flow Control	NONE

4 Setup Items

Set up the Display's communication settings in GP-Pro EX or in the Display's offline mode.

The setting of each parameter must match that of the External Device.

 "3 Communication Settings" (page 8)

4.1 Setup Items in GP-Pro EX

■ Communication Settings

To display the setup screen, from the [Project] menu, point to [System Settings] and select [Device/PLC].

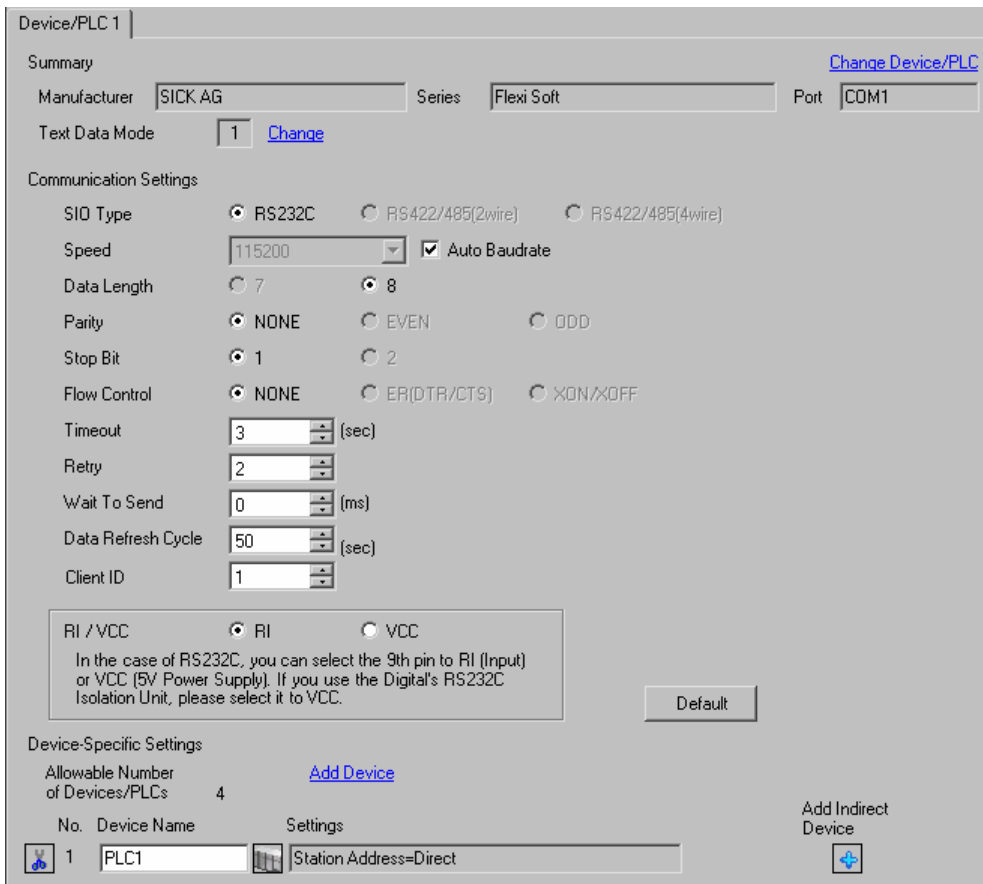

Device/PLC 1

Summary [Change Device/PLC](#)

Manufacturer Series Port

Text Data Mode [Change](#)

Communication Settings

SIO Type RS232C RS422/485(2wire) RS422/485(4wire)

Speed Auto Baudrate

Data Length 7 8

Parity NONE EVEN ODD

Stop Bit 1 2

Flow Control NONE ER(DTR/CTS) XON/XOFF

Timeout (sec)

Retry

Wait To Send (ms)

Data Refresh Cycle (sec)

Client ID

RI / VCC RI VCC

In the case of RS232C, you can select the 9th pin to RI (Input) or VCC (5V Power Supply). If you use the Digital's RS232C Isolation Unit, please select it to VCC.

Device-Specific Settings

Allowable Number of Devices/PLCs [Add Device](#)

No.	Device Name	Settings
<input type="button" value="1"/>	<input type="text" value="PLC1"/>	<input type="text" value="Station Address=Direct"/>

Setup Items	Setup Description
SIO Type	Display the SIO type for communicating with the External Device.
Speed	Select the communication speed between the External Device and the Display. To detect the speed automatically, place a check [Auto Baudrate].
Data Length	Data length is displayed.
Parity	The parity check method is displayed.
Stop Bit	Stop bit length is displayed.

Continues to the next page.

Setup Items	Setup Description
Flow Control	The communication control method to prevent overflow of transmission and reception data.
Timeout	Enter the time (sec) for which the Display waits for the response from the External Device, from "1 to 127".
Retry	In case of no response from the External Device, enter how many times the Display retransmits the command, from "0 to 255".
Wait To Send	Enter the standby time (ms) from when the Display receives packets until it transmits the next command, from "0 to 255".
Data Refresh Cycle	Enter the Data Refresh Cycle for retaining written values, from "10 to 59". Normally, this is set at the default setting of "50". NOTE <ul style="list-style-type: none"> The External Device resets the data in RS-232 to Flexi Soft automatically as soon as one minute has elapsed since the last writing. To prevent the written data from being reset, the Display executes writing cyclically.
Client ID	Enter the Display number, from "0 to 255". Normally, this is set at the default setting of "1". NOTE <ul style="list-style-type: none"> An error may occur if Client ID is changed while writing is being performed.
RI/VCC	You can switch RI/VCC of the 9th pin when you select RS232C for SIO type. It is necessary to change RI/5V by changeover switch of IPC when connect with IPC. Please refer to the manual of the IPC for more detail.

NOTE • Refer to the GP-Pro EX Reference Manual for Indirect Device.

Cf. GP-Pro EX Reference Manual "Changing the Device/PLC at Runtime (Indirect Device)"

■ Device Setting

To display the [Individual Device Settings] dialog box, from [Device-Specific Settings] in the [Device/PLC] window, select the external device and click [Settings] . To connect multiple External Devices, from [Device-Specific Settings] in the [Device/PLC] window, click [Add Device] to add another External Device.

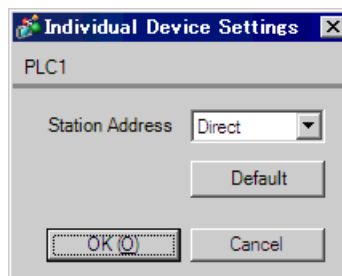

Setup Items	Setup Description
Station Address	Select "Direct", "A", "B", "C", or "D".

4.2 Setup Items in Offline Mode

NOTE

- Refer to the Maintenance/Troubleshooting guide for information on how to enter offline mode or about the operation.

Cf. Maintenance/Troubleshooting Guide "Offline Mode"

- The number of the setup items to be displayed for 1 page in the offline mode depends on the Display in use. Please refer to the Reference manual for details.

■ Communication Settings

To display the setting screen, touch [Device/PLC Settings] from [Peripheral Settings] in offline mode. Touch the External Device you want to set from the displayed list.

Comm.	Device	Option		
Flexi Soft			[COM1]	Page 1/1
SIO Type		RS232C		
Speed		115200		
Auto Baudrate		<input checked="" type="radio"/> Yes <input type="radio"/> No		
Data Length		8		
Parity		NONE		
Stop Bit		1		
Flow Control		NONE		
Timeout(s)		3		
Retry		2		
Wait To Send(ms)		0		
Data Refresh(s)		50		
Client ID		1		
	Exit		Back	2011/10/05 19:13:32

Setup Items	Setup Description
SIO Type	The SIO type for communicating with the External Device is displayed.
Speed	Select the communication speed between the External Device and the Display. When "auto" is selected, it is not used.
Auto Baudrate	Select whether to automatically detect the communication speed.
Data Length	Data length is displayed.
Parity	The parity check method is displayed.

Continues to the next page.

Setup Items	Setup Description
Stop Bit	Stop bit length is displayed.
Flow Control	The communication control method to prevent overflow of transmission and reception data.
Timeout	Enter the time (sec) for which the Display waits for the response from the External Device, from "1 to 127".
Retry	In case of no response from the External Device, enter how many times the Display retransmits the command, from "0 to 255".
Wait To Send	Enter the standby time (ms) from when the Display receives packets until it transmits the next command, from "0 to 255".
Data Refresh	<p>Enter the Data Refresh Cycle for retaining written values, from "10 to 59". Normally, this is set at the default setting of "50".</p> <p>NOTE</p> <ul style="list-style-type: none"> The External Device resets the data in RS-232 to Flexi Soft automatically as soon as one minute has elapsed since the last writing. To prevent the written data from being reset, the Display executes writing cyclically.
Client ID	<p>Enter the Display number, from "0 to 255". Normally, this is set at the default setting of "1".</p> <p>NOTE</p> <ul style="list-style-type: none"> An error may occur if Client ID is changed while writing is being performed.

■ Device Setting

To display the setting screen, touch [Device/PLC Settings] from [Peripheral Settings]. Touch the External Device you want to set from the list that appears, and touch [Device].

Comm.	Device	Option		
Flexi Soft			[COM1]	Page 1/1
Device/PLC Name	PLC1 <input type="button" value="v"/>			
Station Address	Direct <input type="button" value="v"/>			
	Exit		Back	2011/10/05 19:13:38

Setup Items	Setup Description
Device/PLC Name	Select the External Device to set. Device/PLC Name is the title of the External Device set with GP-Pro EX. (Initial value [PLC1])
Station Address	Select "Direct", "A", "B", "C", or "D".

■ Option

To display the setting screen, touch [Device/PLC Settings] from [Peripheral Settings]. Touch the External Device you want to set from the list that appears, and touch [Option].

Comm.	Device	Option		
Flexi Soft			[COM1]	Page 1/1
RI / VCC <input checked="" type="radio"/> RI <input type="radio"/> VCC In the case of RS232C, you can select the 9th pin to RI(Input) or VCC(5V Power Supply). If you use the Digital's RS232C Isolation Unit, please select it to VCC.				
	Exit		Back	2011/10/05 19:13:41

Setup Items	Setup Description
RI/VCC	You can switch between RI/VCC for the 9th pin when you select RS-232C for SIO type. To connect to the IPC, you need to switch between RI/5V using the IPC selector switch. Refer to your IPC manual for details.

NOTE

- GP-4100 series, GP-4*01TM and GP-Rear Module do not have the [Option] setting in the offline mode.

5 Cable Diagrams

The cable diagrams shown below may be different from the cable diagrams recommended by SICK AG. Please be assured there is no operational problem in applying the cable diagrams shown in this manual.

- The FG pin on the External Device must be D-class grounded. Refer to your External Device manual for details.
- The SG and FG are connected inside the Display. If you connect the External Device to the SG, do not form any short-circuit loop in the system design.
- If the communication is not stable because of noise or other factors, connect an isolation unit.
- The Display-side of the SICK AG cable requires a modification. Connect the 7 and 8 pins on the Display-side connector.

Cable Diagram 1

Display (Connection Port)	Cable		Remarks
GP3000 (COM1) GP4000* ¹ (COM1) SP5000* ² (COM1/2) SP-5B00 (COM1) ST3000 (COM1) ST6000 (COM1) STM6000 (COM1) LT3000 (COM1) IPC* ³ PC/AT	1A	SICK part no. 2027649 (10m) or SICK part no. 6021195 (2m)	
GP-4105 (COM1) GP-4115T (COM1) GP-4115T3 (COM1)	1B	User-created cable + SICK part no. 2027649 (10m) or SICK part no. 6021195 (2m)	Cable length: 15m or less

*1 All GP4000 models except GP-4100 Series and GP-4203T

*2 Except SP-5B00

*3 Only the COM port which can communicate by RS-232C can be used.

☞ ■ IPC COM Port (page 4)

1A)

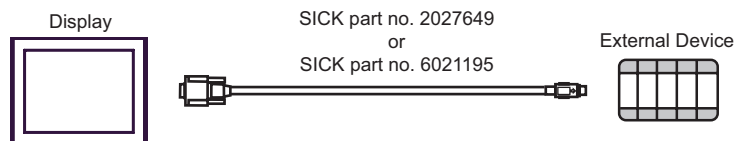

1B)

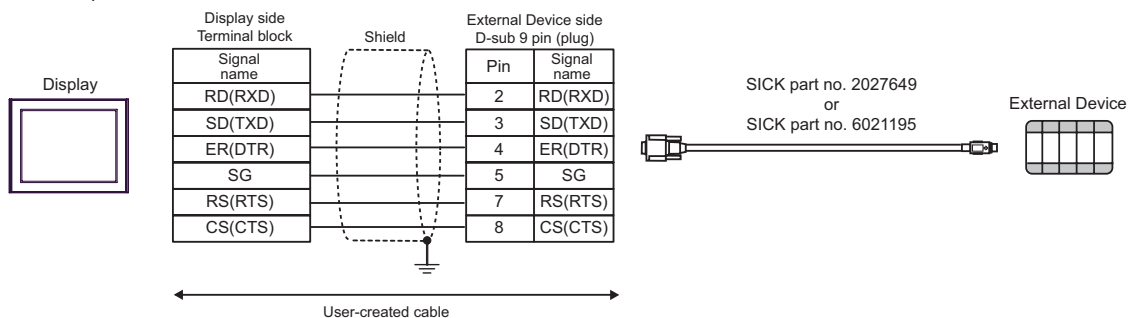







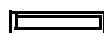



6 Supported Device

The range of supported device addresses is shown in the table below.

Refer to your External Device manual for information on terminology and features related to the External Device.





 : This address can be specified as system data area.

■ Basic devices

Device	Bit Address	Word Address	32 bits	Remarks
RS-232 to Flexi Soft	0.0 - 3.7	0 - 2		 
Flexi Soft to RS-232	00.0 - 99.7	00 - 98		  *1
Module Status Bit Array	00.0 - 59.7	00 - 58		  *1
Operating Data Block	0.0 - 9.7	0 - 8		  *1
Configuration CRCs	00.0 - 19.7	00 - 18		  *1

*1 Write disable

■ Advanced devices

Device	Bit Address	Word Address	32 bits	Remarks
CPU Module Type Key	00.0 - 17.7	00 - 16		  *1 *2
Extension Modules Type Key Array	000.0 - 335.7	000 - 334		  *1 *2

*1 Write disable

*2 This device can be used by creating the empty file "adv.dat" inside the "\\Protocol\SCKFLEXI" folder located in the folder where GP-Pro EX was installed.

NOTE

- Refer to the GP-Pro EX Reference Manual for system data area.

Cf. GP-Pro EX Reference Manual "LS Area (Direct Access Method Area)"

- Refer to the precautions on manual notation for icons in the table.

 "Manual Symbols and Terminology"

RS-232 to Flexi Soft

The RS-232 to Flexi Soft device (R2F) allows writing 4 bytes to the Flexi Soft for use in the Flexi Soft logic.

Flexi Soft to RS-232

The Flexi Soft to RS-232 device (F2R) allows access to 100 byte process and status data. It can be compiled using the Flexi Soft Designer tool. The following table gives an overview which bytes are assigned to the default configuration.

Bit Address	Module Status Bit Array FX3-CPU0	Module Status Bit Array FX3-CPU1
F2R00.0 - F2R00.7	Input values module 1	Input values module 1
F2R01.0 - F2R01.7	Input values module 2	Input values module 2
:	:	:
F2R11.0 - F2R11.7	Input value module 12	Input value module 12
F2R12.0 - F2R12.7	Output value module 1	Output value module 1
F2R13.0 - F2R13.7	Output value module 2	Output value module 2
:	:	:
F2R23.0 - F2R23.7	Output value module 12	Output value module 12
F2R24.0 - F2R24.7	Logic result 0	Logic result 0
F2R25.0 - F2R25.7	Logic result 1	Logic result 1
F2R26.0 - F2R26.7	Logic result 2	Logic result 2
F2R27.0 - F2R27.7	Logic result 3	Logic result 3
F2R28.0 - F2R31.7	Not assigned	EFI 1, Device 1 Input
F2R32.0 - F2R35.7	Not assigned	EFI 1, Device 2 Input
F2R36.0 - F2R39.7	Not assigned	EFI 1, Device 3 Input
F2R40.0 - F2R43.7	Not assigned	EFI 2, Device 1 Input
F2R44.0 - F2R47.7	Not assigned	EFI 2, Device 2 Input
F2R48.0 - F2R51.7	Not assigned	EFI 2, Device 3 Input
F2R52.0 - F2R55.7	Not assigned	EFI 1, Device 1 Output
F2R56.0 - F2R59.7	Not assigned	EFI 2, Device 1 Output
F2R60.0 - F2R99.7	Not assigned	Not assigned

Module Status Bit Array

The Module Status Bit Array device (STAT) returns 60 bytes of data containing the individual module status and diagnostics data with four (4) bytes per module.

Refer to your External Device manual for details on status and diagnostics data.

Module Status Bit Array	Word Address
CPU Module	STAT00 - STAT02
Extension Module 1	STAT04 - STAT06
Extension Module 2	STAT08 - STAT10
:	:
Extension Module 12	STAT48 - STAT50
Gateway 1	STAT52 - STAT54
Gateway 2	STAT56 - STAT58

Operating Data Block

The Operating Data Block device (OBD) returns various time information of the external device

Operating Data Block	Word Address	Remarks
Operating Time	ODB0 - ODB2	Total operating time in seconds
Power On time	ODB4 - ODB6	Time expired since last power-up cycle
Power Cycles	ODB8	Number of power up cycles

Configuration CRCs

The Flexi Soft provides various checksums to validate that the configuration within the Flexi Soft was not altered or manipulated.

Operating Data Block	Word Address	Remarks
Overall CRC	CRC00 - CRC02	The overall CRC is the checksum displayed in the Flexi Soft Designer report.
SCID	CRC04 - CRC06	System CRC - For the Flexi Soft external device the SCID and the Overall CRC have the same value.
CRC 2	CRC08 - CRC10	Reserved.
Verified Configuration CRC	CRC12 - CRC14	If this value is identical to the System CRC (SCID) the configuration is verified. Otherwise the configuration is not verified. Refer to your External Device manual for details on verification. (Requires Flexi Soft firmware V2.00 or higher)
CRC 3	CRC16 - CRC18	Reserved.

CPU Modules Type Key

The CPU Module Type Key device (CTYP) returns the type information for the connected Flexi Soft CPU. The serial number is equivalent to date of manufacture listed on the type label in the S/N field in the format yywwnnnn (yy = year, ww = calendar week, nnnn = continuous serial number in the calendar week).

CPU Module Type Key	Word Address	Remarks
Flexi Soft Family	CTYP00.0 - CTYP00.3	Members of the Flexi Soft family returns "7".
Safety Level	CTYP00.4 - CTYP00.7	0: Standard 3: Safety
Module Type	CTYP01.0 - CTYP01.7	00: FX3-CPU0 01: FX3-CPU1
Module Diagnose ID	CTYP07.0 - CTYP07.7	Reserved
Serial Number - Year	CTYP14.0 - CTYP14.7	yy (e.g. 10 = year 2010)
Serial Number - Calendar Week	CTYP15.0 - CTYP15.7	ww
Serial Number - Continuous number in Calendar Week	CTYP16.0 - CTYP17.0	nnnn

Extension Modules Type Key Array

The Extension Modules Type Key Array device (MTYP) returns a list of the module type key of the modules currently connected to external device. The list includes extension modules and gateway modules. Each individual module type key is 24 bytes in length.

Refer to your External Device manual for details on device information.

Extension Modules Type Key Array	Word Address	Remarks
Extension Module 1	MTYP000 - MTYP022	Type Key of Extension Module 1
Extension Module 2	MTYP024 - MTYP046	Type Key of Extension Module 2
Extension Module 3	MTYP048 - MTYP070	Type Key of Extension Module 3
:	:	:
Extension Module 12	MTYP264 - MTYP286	Type Key of Extension Module 12
Gateway 1	MTYP288 - MTYP310	Type Key of Gateway 1
Gateway 2	MTYP312 - MTYP324	Type Key of Gateway 2

The following table provides a description of the 24 bytes type key.

The serial number is equivalent to date of manufacture listed on the type label in the S/N field in the format yywwnnnn (yy = year, ww = calendar week, nnnn = continuous serial number in the calendar week).

Extension Modules Type Key Array	Byte	Remarks
Flexi Soft Family	Byte 0, Bit 0...3	Members of the Flexi Soft family returns "7".
Safety Level	Byte 0, Bit 4...7	0: Standard 3: Safety
Module Type	Byte 1	04: FX3-XTDI 06: FX3-XTIO 07: FX0-GPRO 08: FX0-GDEV 09: FX0-GCAN 0A: FX-GENT 0B: FX-GMOD 0C: FX-GPNT 16: FX-GECT
Module Diagnose ID	Byte 7	Reserved
Serial Number - Year	Byte 8	yy (e.g. 10 = year 2010)
Serial Number - Calendar Week	Byte 9	ww
Serial Number - Continuous number in Calendar Week	Byte 10 - Byte 11	nnnn

7 Device Code and Address Code

Use device code and address code if you select "Device Type & Address" for the address type in Data displays.

Device	Device Name	Device Code (HEX)	Address Code
RS-232 to Flexi Soft	R2F	0081	Value of word address divided by 2
Flexi Soft to RS-232	F2R	0080	Value of word address divided by 2
Module Status Bit Array	STAT	0082	Value of word address divided by 2
CPU Module Type Key	CTYP	0083	Value of word address divided by 2
Extension Modules Type Key Array	MTYP	0084	Value of word address divided by 2
Operating Data Block	ODB	0086	Value of word address divided by 2
Configuration CRCs	CRC	0088	Value of word address divided by 2

8 Error Messages

Error messages are displayed on the Display screen as follows: "No.: Device Name: Error Message (Error Occurrence Area)". Each description is shown below.

Item	Description
No.	Error No.
Device Name	Name of the External Device where an error has occurred. Device name is a title of the External Device set with GP-Pro EX. (Initial value [PLC1])
Error Message	Displays messages related to an error that has occurred.
Error Occurrence Area	<p>Displays the IP address or device address of the External Device where an error has occurred, or error codes received from the External Device.</p> <p>NOTE</p> <ul style="list-style-type: none"> • IP address is displayed as "IP address (Decimal): MAC address (Hex)". • Device address is displayed as "Address: Device address". • Received error codes are displayed as "Decimal [Hex]".

Display Examples of Error Messages

"RHAA035: PLC1: Error has been responded for device write command (Error Code: 1 [01H])"

NOTE

- Refer to your External Device manual for details on received error codes.
- Refer to "Display-related errors" in "Maintenance/Troubleshooting Manual" for details on the error messages common to the driver.

■ Error Codes Specific to the External Device

Error Code (HEX)	Error Description
08	RK512 handler is busy, RK512 request cannot be processed.
0A	Source/destination parameter invalid or timeout occurred.

NOTE

- The error codes shown above may display in cases when a Display and Flexi Soft Designer are connected concurrently or when multiple Displays are connected.

■ Error Messages Specific to the External Device

Message ID	Error Message	Description
RHxx128	Automatic baud rate detection has failed.	This will display when the baud rate cannot be detected. Check that the cable is connected.
RHxx129	Writing to R2F area did not complete properly.	This will display when processing stops during writing to the RS232 Flexi Soft device. Check whether communication can be correctly performed.
RHxx130	R2F data refresh has failed. (Error Code: (Decimal))[(Hex))	This displays when data refresh in the RS232 to Flexi Soft device has failed. There is a possibility that data will be reset, so write data as necessary.
RHxx131	R2F data refresh has failed.	This displays when data refresh in the RS232 to Flexi Soft device has failed. There is a possibility that data will be reset, so write data as necessary.