



# SAPHIR SIO Driver

1	System Configuration.....	3
2	External Device Selection .....	7
3	Communication Settings .....	8
4	Setup Items .....	10
5	Cable Diagrams .....	15
6	Supported Devices.....	18
7	Device Code and Address Code.....	30
8	Error Messages.....	31

## Introduction

This manual describes how to connect the Display and the External Device.

In this manual, the connection procedure is described in the sections identified below:

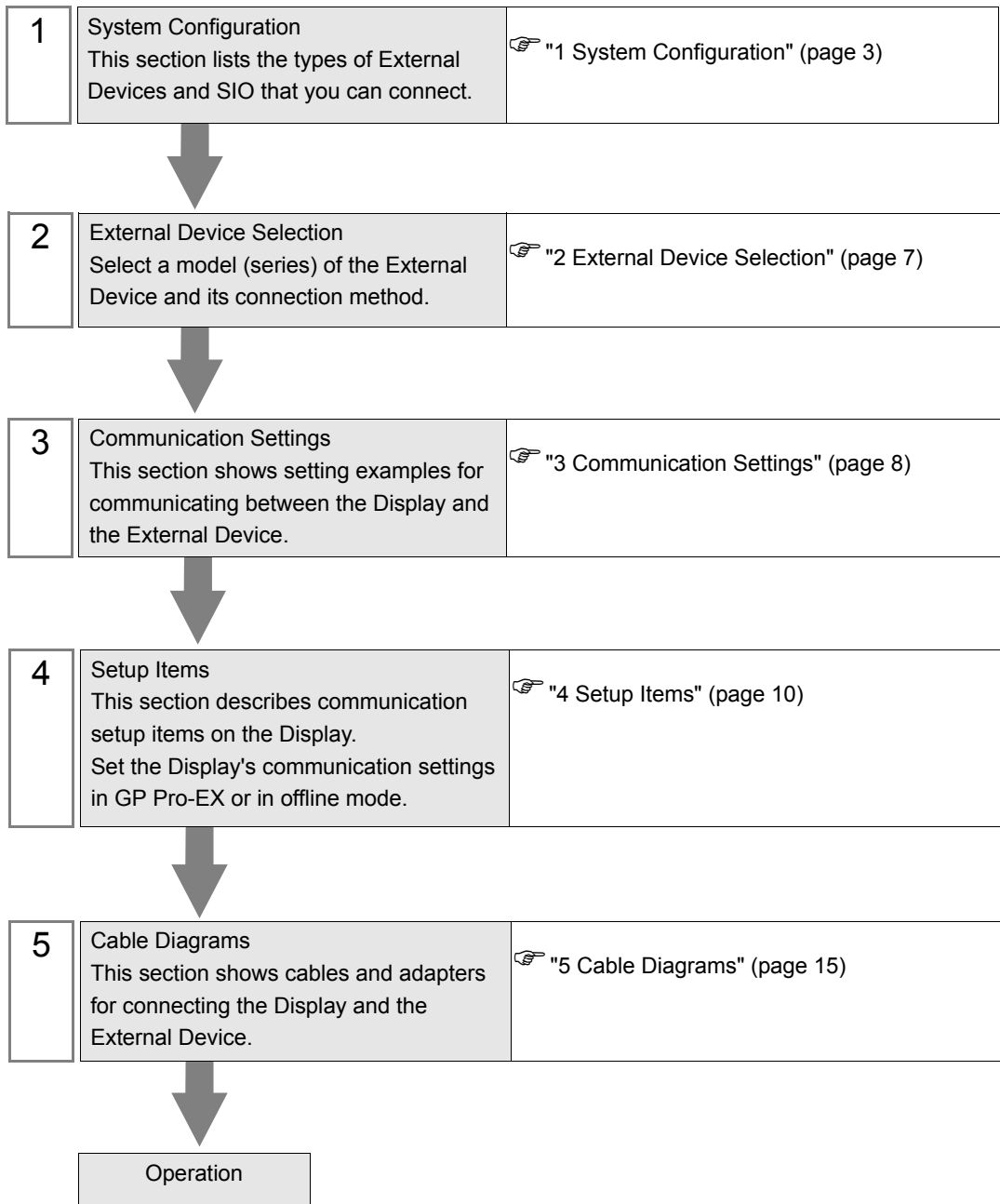

# 1 System Configuration

The following section shows system configurations for connecting Siemens Building Technologies External Devices and the Display.

Series	CPU	Link I/F	SIO Type	Setting Example	Cable Diagram
SAPHIR	ACC88	CPU Service Interface	RS-232C	Setting Example 1 (page 8)	Cable Diagram 1 (page 15)
	ACX32				
	ACX34				
	ACX36				
	ACX38				
	HRC3.1				
	HRC3.2				
	RBX-Core				
	RCX34.2				

**NOTE**

- Set the execution time of the logic functions in the Display to "100 ms" or less. If the longer time is set, an error may occur in the communication with the external device.

## ■ Connection Configuration

### ◆ 1:1 Connection

**NOTE**

- Connecting External Devices to multiple COM ports on IPC Series will degrade performance. Please use a 1:1 connection.

## ■ IPC COM Port

When connecting IPC with an External Device, the COM port used depends on the series and SIO type. Please refer to the IPC manual for details.

### Usable port

Series	Usable Port		
	RS-232C	RS-422/485(4 wire)	RS-422/485(2 wire)
PS-2000B	COM1 <sup>*1</sup> , COM2, COM3 <sup>*1</sup> , COM4	-	-
PS-3450A, PS-3451A, PS3000-BA, PS3001-BD	COM1, COM2 <sup>*1*2</sup>	COM2 <sup>*1*2</sup>	COM2 <sup>*1*2</sup>
PS-3650A (T41 model), PS-3651A (T41 model)	COM1 <sup>*1</sup>	-	-
PS-3650A (T42 model), PS-3651A (T42 model)	COM1 <sup>*1*2</sup> , COM2	COM1 <sup>*1*2</sup>	COM1 <sup>*1*2</sup>
PS-3700A (Pentium®4-M) PS-3710A	COM1 <sup>*1</sup> , COM2 <sup>*1</sup> , COM3 <sup>*2</sup> , COM4	COM3 <sup>*2</sup>	COM3 <sup>*2</sup>
PS-3711A	COM1 <sup>*1</sup> , COM2 <sup>*2</sup>	COM2 <sup>*2</sup>	COM2 <sup>*2</sup>
PS4000 <sup>*3</sup>	COM1, COM2	-	-
PL3000	COM1 <sup>*1*2</sup> , COM2 <sup>*1</sup> , COM3, COM4	COM1 <sup>*1*2</sup>	COM1 <sup>*1*2</sup>
PE-4000B Atom N270	COM1, COM2	-	-
PE-4000B Atom N2600	COM1, COM2	COM3 <sup>*4</sup> , COM4 <sup>*4</sup> , COM5 <sup>*4</sup> , COM6 <sup>*4</sup>	COM3 <sup>*4</sup> , COM4 <sup>*4</sup> , COM5 <sup>*4</sup> , COM6 <sup>*4</sup>
PS5000 (Slim Panel Type Core i3 Model) <sup>*5*6</sup>	COM1, COM2 <sup>*4</sup>	COM2 <sup>*4</sup>	COM2 <sup>*4</sup>
PS5000 (Slim Panel Type Atom Model) <sup>*5*6</sup>	COM1, COM2 <sup>*7</sup>	COM2 <sup>*7</sup>	COM2 <sup>*7</sup>
PS5000 (Enclosed Panel Type) <sup>*8</sup>	COM1	-	-
PS5000 (Modular Type PFXPU/PFXPP) <sup>*5*6</sup> PS5000 (Modular Type PFXPL2B5-6)	COM1 <sup>*7</sup>	COM1 <sup>*7</sup>	COM1 <sup>*7</sup>
PS5000 (Modular Type PFXPL2B1-4)	COM1, COM2 <sup>*7</sup>	COM2 <sup>*7</sup>	COM2 <sup>*7</sup>
PS6000	COM1 <sup>*9</sup>	<sup>*10</sup>	<sup>*10</sup>

\*1 The RI/5V can be switched. Use the IPC's switch to change if necessary.

\*2 Set up the SIO type with the DIP Switch. Please set up as follows according to SIO type to be used.

\*3 When making communication between an External Device and COM port on the Expansion slot, only RS-232C is supported. However, ER (DTR/CTS) control cannot be executed because of the specification of COM port.

For connection with External Device, use user-created cables and disable Pin Nos. 1, 4, 6 and 9. Please refer to the IPC manual for details of pin layout.

\*4 Set up the SIO type with the BIOS. Please refer to the IPC manual for details of BIOS.

- \*5 When setting up communication between an External Device and the RS-232C/422/485 interface module, use the IPC (RS-232C) or PS5000 (RS-422/485) cable diagrams. However, when using PFXZPBMPR42P2 in a RS-422/485 (4-wire) configuration with no flow control, connect 7.RTS+ and 8.CTS+, and connect 6.RTS- and 9.CTS-.  
When using RS-422/485 communication with External Devices, you may need to reduce the transmission speed and increase the TX Wait time.
- \*6 To use RS-422/485 communication on the RS-232C/422/485 interface module, the DIP Switch setting is required. Please refer to "Knowledge Base" (FAQs) on the support site. (<http://www.pro-face.com/trans/en/manual/1001.html>)

Settings	FAQ ID
PFXZPBMPR42P2, RS422/485 change method	FA263858
PFXZPBMPR42P2 termination resistor setting	FA263974
PFXZPBMPR44P2, RS422/485 change method	FA264087
PFXZPBMPR44P2 termination resistor setting	FA264088

- \*7 Set up the SIO type with the DIP Switch. Please refer to the IPC manual for details of DIP Switch. The BOX Atom has not a switch to set the RS-232C, RS-422/485 mode. Use the BIOS for the setting.
- \*8 For the connection with the External Device, on the user-created cable read as if the connector on the Display-side is a M12 A-coding 8 pin socket. The pin assignment is the same as described in the cable diagram. For the M12 A-coding connector, use PFXZPSCNM122.
- \*9 In addition to COM1, you can also use the RS-232C COM port on the optional interface.
- \*10 Install the optional interface in the expansion slot.

## DIP Switch settings (PL3000 / PS3000 Series)

### RS-232C

DIP Switch	Setting	Description
1	OFF*1	Reserved (always OFF)
2	OFF	SIO type: RS-232C
3	OFF	
4	OFF	Output mode of SD (TXD) data: Always output
5	OFF	Terminal resistance (220Ω) insertion to SD (TXD): None
6	OFF	Terminal resistance (220Ω) insertion to RD (RXD): None
7	OFF	Short-circuit of SDA (TXA) and RDA (RXA): Not available
8	OFF	Short-circuit of SDB (TXB) and RDB (RXB): Not available
9	OFF	RS (RTS) Auto control mode: Disabled
10	OFF	

\*1 When using PS-3450A, PS-3451A, PS3000-BA and PS3001-BD, turn ON the set value.

## RS-422/485 (4 wire)

DIP Switch	Setting	Description
1	OFF	Reserved (always OFF)
2	ON	SIO type: RS-422/485
3	ON	
4	OFF	Output mode of SD (TXD) data: Always output
5	OFF	Terminal resistance (220Ω) insertion to SD (TXD): None
6	OFF	Terminal resistance (220Ω) insertion to RD (RXD): None
7	OFF	Short-circuit of SDA (TXA) and RDA (RXA): Not available
8	OFF	Short-circuit of SDB (TXB) and RDB (RXB): Not available
9	OFF	RS (RTS) Auto control mode: Disabled
10	OFF	

## RS-422/485 (2 wire)

DIP Switch	Setting	Description
1	OFF	Reserved (always OFF)
2	ON	SIO type: RS-422/485
3	ON	
4	OFF	Output mode of SD (TXD) data: Always output
5	OFF	Terminal resistance (220Ω) insertion to SD (TXD): None
6	OFF	Terminal resistance (220Ω) insertion to RD (RXD): None
7	ON	Short-circuit of SDA (TXA) and RDA (RXA): Available
8	ON	Short-circuit of SDB (TXB) and RDB (RXB): Available
9	ON	RS (RTS) Auto control mode: Enabled
10	ON	

## 2 External Device Selection

Select the External Device to be connected to the Display.

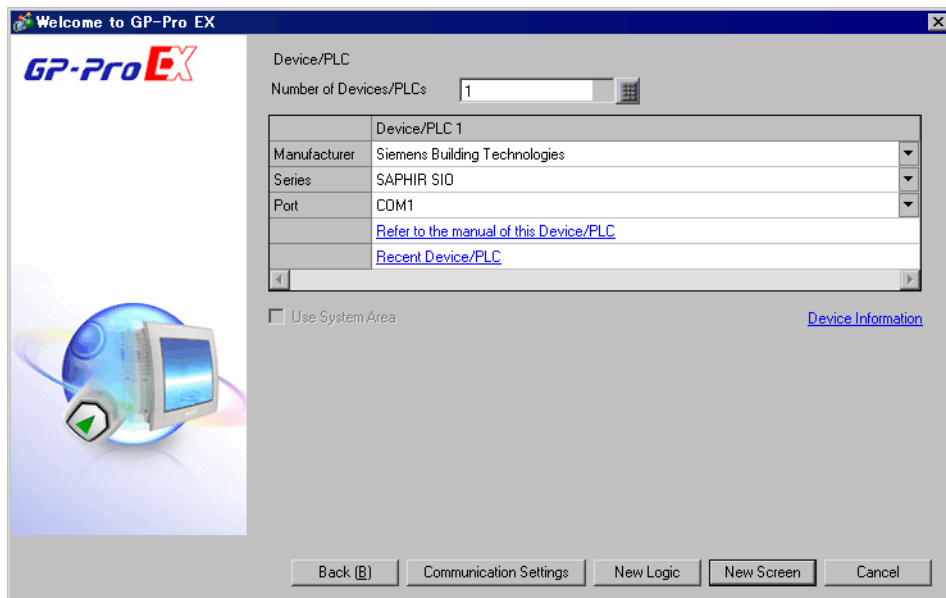

Setup Items	Setup Description
Number of Devices/PLCs	Use an integer from 1 to 4 to enter the number of Devices/PLCs to connect to the display.
Manufacturer	Select the manufacturer of the External Device to be connected. Select "Siemens Building Technologies".
Series	Select a model (series) of the External Device and its connection method. Select "SAPHIR SIO". In System configuration, check to make sure the External Device to which you are connecting is supported by the "SAPHIR SIO" driver. ☞ "1 System Configuration" (page 3)
Port	Select the Display port to be connected to the External Device.
Use System Area	Not available for this driver.

## 3 Communication Settings

This section provides examples of communication settings recommended by Pro-face for the Display and the External Device.

### 3.1 Setting Example 1

#### ■ GP-Pro EX Settings

#### ◆ Communication Settings

To display the setup screen, from the [Project] menu, point to [System Settings] and select [Device/PLC].

Device/PLC 1

Summary [Change Device/PLC](#)

Manufacturer  Series  Port

Text Data Mode  [Change](#)

Communication Settings

SIO Type  RS232C  RS422/485(2wire)  RS422/485(4wire)

Speed

Data Length  7  8

Parity  NONE  EVEN  ODD

Stop Bit  1  2

Flow Control  NONE  ER(DTR/CTS)  XON/XOFF

Timeout  (sec)

Retry

Wait To Send  (ms)

RI / VCC  RI  VCC

In the case of RS232C, you can select the 9th pin to RI (Input) or VCC (5V Power Supply). If you use the Digital's RS232C Isolation Unit, please select it to VCC.

Device-Specific Settings

Allowable Number of Devices/PLCs  [Add Device](#)

No.	Device Name	Settings	<a href="#">Add Indirect Device</a>
1	PLC1	Data Point Name=, Target=ACX 32/ACX 34	<input type="button" value="+"/>



## ◆ Device Setting

To display the [Individual Device Settings] dialog box, from [Device-Specific Settings] in the [Device/PLC] window, select the external device and click [Settings] .

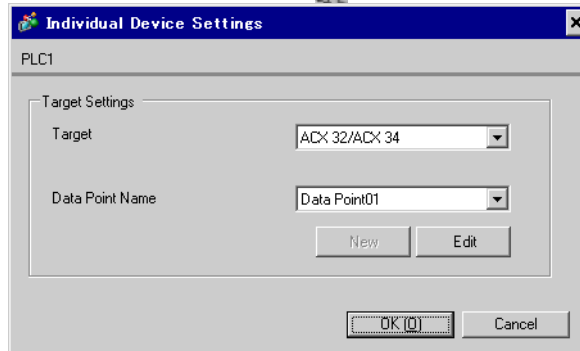

### NOTE

- To configure the data point, you can create a new data point or import a CSV file.

 " ■ Creating New Data Points" (page 27)

 " ■ Importing Data Points" (page 21)

## ■ External Device Settings

External Device communication settings are fixed as indicated below.

Setup Items	Setting Value
Baud Rate	57600
Character Length	8
Parity Bit	NONE
Stop Bit	1
Flow Control	NONE

## 4 Setup Items

Set up the Display's communication settings in GP Pro-EX or in the Display's offline mode.

The setting of each parameter must match that of the External Device.

 "3 Communication Settings" (page 8)

### 4.1 Setup Items in GP Pro-EX

#### ■ Communication

To display the setup screen, from the [Project] menu, point to [System Settings] and select [Device/PLC].

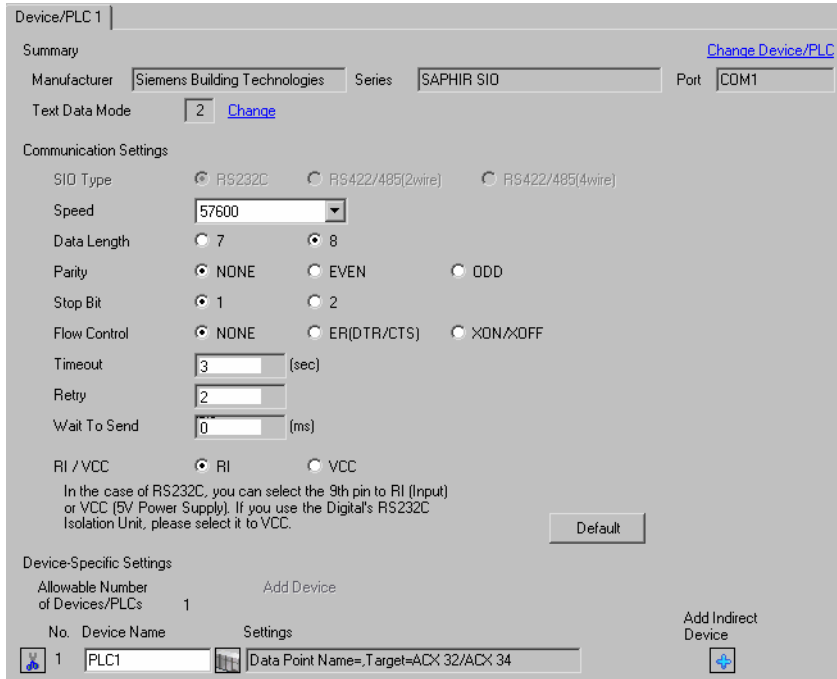

Device/PLC 1

Summary [Change Device/PLC](#)

Manufacturer  Series  Port

Text Data Mode  [Change](#)

Communication Settings

SIO Type  RS232C  RS422/485(2wire)  RS422/485(4wire)

Speed

Data Length  7  8

Parity  NONE  EVEN  ODD

Stop Bit  1  2

Flow Control  NONE  ER(DTR/CTS)  XON/XOFF

Timeout  (sec)

Retry

Wait To Send  (ms)

RI / VCC  RI  VCC

In the case of RS232C, you can select the 9th pin to RI (Input) or VCC (5V Power Supply). If you use the Digital's RS232C Isolation Unit, please select it to VCC.

Device-Specific Settings

Allowable Number of Devices/PLCs  [Add Device](#)

No.	Device Name	Settings
<input type="button" value="1"/>	<input type="text" value="PLC1"/>	<input type="text" value="Data Point Name=,Target=ACX 32/ACX 34"/>

[Add Indirect Device](#)

Setup Items	Setup Description
SIO Type	Displays the SIO type to communicate with the External Device.
Speed	Select the communication speed between the External Device and the Display.
Data Length	Select the data length.
Parity	Select how to check parity.
Stop Bit	Select stop bit length.
Flow Control	Select the communication control method to prevent overflow of transmission and reception data.
Timeout	Enter the time (seconds) for which the Display waits for the response from the External Device, from "1 to 127".
Retry	In case of no response from the External Device, enter how many times the Display retransmits the command, from "0 to 255".
Wait To Send	Enter the standby time (milliseconds) from when the Display receives packets until it transmits the next command, from "0 to 255".

Continues to the next page.

Setup Items	Setup Description
RI/VCC	Switches the 9th pin between RI and VCC. When connecting to the IPC, to change between RI and 5V you need to use the IPC's changeover switch. Please refer to the IPC manual for details.

**NOTE**

- Refer to the GP-Pro EX Reference Manual for Indirect Device.

Cf. GP-Pro EX Reference Manual "Changing the Device/PLC at Runtime (Indirect Device)"

## ■ Device Setting

To display the [Individual Device Settings] dialog box, from [Device-Specific Settings] in the [Device/PLC] window, select the external device and click [Settings] .

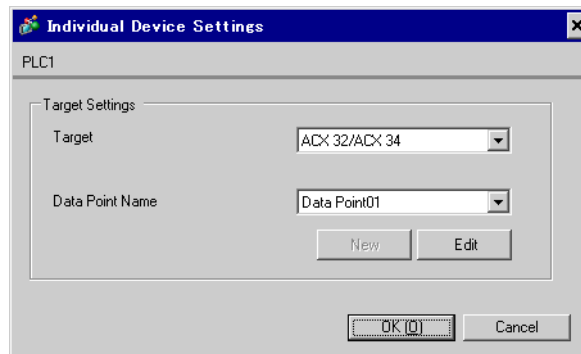

Setup Items	Setup Description
Target	Select the CPU of the External Device.
Data Point Name	Select the data point.  "6 Supported Devices" (page 18)

## 4.2 Setup Items in Offline Mode

**NOTE**

- Refer to the Maintenance/Troubleshooting guide for information on how to enter offline mode or about operation.

Cf. Maintenance/Troubleshooting Guide "Offline Mode"

- The number of the setup items to be displayed for 1 page in the offline mode depends on the Display in use. Please refer to the Reference manual for details.

### ■ Communication

To display the setting screen, from [Peripheral Settings] in offline mode, touch [Device/PLC Settings]. Touch the External Device you want to set from the displayed list.

Comm.	Device	Option		
SAPHIR SIO			[COM1]	Page 1/1
SIO Type		RS232C		
Speed		57600		
Data Length		<input type="radio"/> 7 <input checked="" type="radio"/> 8		
Parity		<input checked="" type="radio"/> NONE <input type="radio"/> EVEN <input type="radio"/> ODD		
Stop Bit		<input checked="" type="radio"/> 1 <input type="radio"/> 2		
Flow Control		NONE		
Timeout(s)			3	▼ ▲
Retry			2	▼ ▲
Wait To Send(ms)			0	▼ ▲
	Exit		Back	2010/09/17 16:11:34

Setup Items	Setup Description
SIO Type	Displays the SIO type to communicate with the External Device.
Speed	Select the communication speed between the External Device and the Display.
Data Length	Select the data length.
Parity	Select how to check parity.
Stop Bit	Select stop bit length.
Flow Control	Select the communication control method to prevent overflow of transmission and reception data.
Timeout	Enter the time (seconds) for which the Display waits for the response from the External Device, from "1 to 127".
Retry	In case of no response from the External Device, enter how many times the Display retransmits the command, from "0 to 255".
Wait To Send	Enter the standby time (milliseconds) from when the Display receives packets until it transmits the next command, from "0 to 255".

## ■ Device

To display the setting screen, touch [Device/PLC Settings] from [Peripheral Settings]. Touch the External Device you want to set from the displayed list, and touch [Device].

Comm.	Device	Option		
SAPHIR SIO		[COM1]	Page 1/1	
Device/PLC Name		[PLC1]		
Target ID		6		
Exit		Back		2010/09/17 16:11:42

Setup Items	Setup Description
Device/PLC Name	Select the External Device to set. Device/PLC name is the title of the External Device set with GP-Pro EX. (Initial value [PLC1])
Target ID	Displays the External Device target ID.

## ■ Option

To display the setting screen, touch [Device/PLC Settings] from [Peripheral Settings]. Touch the External Device you want to set from the displayed list, and touch [Option].

Comm.	Device	Option		
SAPHIR SIO			[COM1]	Page 1/1
RI / VCC <input checked="" type="radio"/> RI <input type="radio"/> VCC In the case of RS232C, you can select the 9th pin to RI(Input) or VCC(5V Power Supply). If you use the Digital's RS232C Isolation Unit, please select it to VCC.				
	Exit		Back	2010/09/17 16:11:47

Setup Items	Setup Description
RI/VCC	Switches the 9th pin between RI and VCC. When connecting to the IPC, to change between RI and 5V you need to use the IPC's changeover switch. Please refer to the IPC manual for details.

### NOTE

- GP-4100 series, GP-4\*01TM, GP-Rear Module, LT-4\*01TM and LT-Rear Module do not have the [Option] setting in the offline mode.

## 5 Cable Diagrams

The following cable diagrams may be different from cable diagrams recommended by Siemens Building Technologies. Please be assured there is no operational problem in applying the cable diagrams shown in this manual.

- The FG pin of the External Device body must be grounded according to your country's applicable standard. Refer to your External Device manual for details.
- SG and FG are connected inside the Display. When connecting the External Device to SG, design your system to avoid short-circuit loops.
- Connect an isolation unit if the communication is not stable due to noise or other factors.

Cable Diagram 1

Display (Connection Port)	Cable		Notes
GP3000 (COM1) GP4000* <sup>1</sup> (COM1) SP5000* <sup>2</sup> (COM1/2) SP-5B00 (COM1) ST (COM1) LT3000 (COM1) IPC* <sup>3</sup> PC/AT	1A	User-created cable	Cable length: 15m or less
GP-4105 (COM1) GP-4115T (COM1) GP-4115T3 (COM1)	1B	User-created cable	Cable length: 15m or less
LT-4*01TM (COM1) LT-Rear Module (COM1)	1C	RJ45 RS-232C Cable (5m) by Pro-face PFXZLMCBJR21	Cable length: 5m or less

\*1 All GP4000 models except GP-4100 Series and GP-4203T

\*2 Except SP-5B00

\*3 You can only use COM ports that can communicate using RS-232C.  
 ■ IPC COM Port (page 4)

1A)

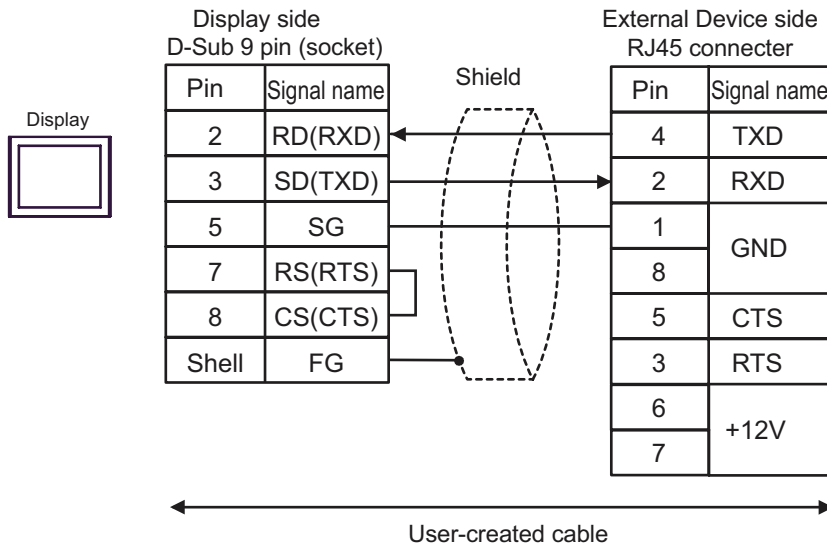
**NOTE**

- Pins 1 and 8 are connected inside the External Device.
- Do not connect anything to pins 6 and 7 on the External Device.

1B)

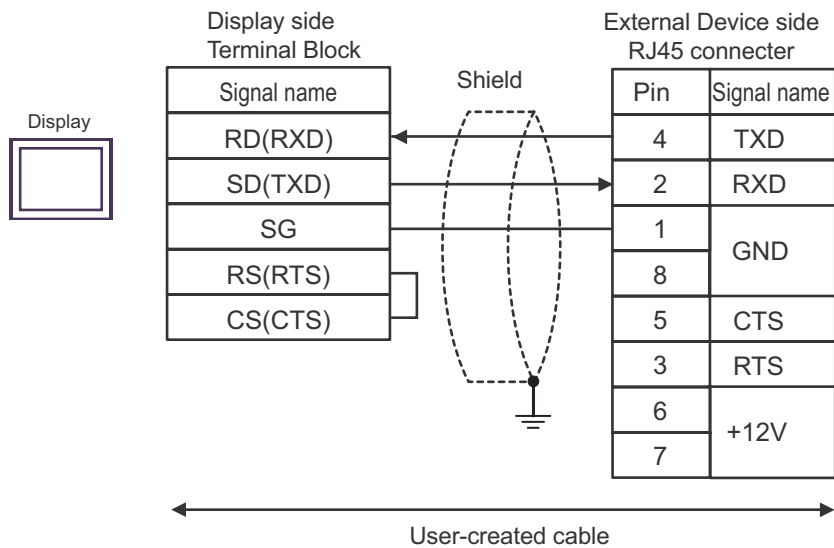
**NOTE**

- Pins 1 and 8 are connected inside the External Device.
- Do not connect anything to pins 6 and 7 on the External Device.



1C)

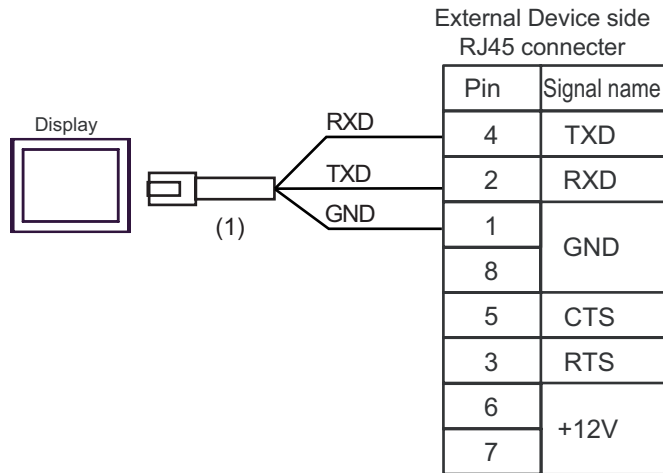

Legend	Name	Notes
(1)	RJ45 RS-232C Cable (5m) by Pro-face PFXZLMCBJR21	

**NOTE**

- Pins 1 and 8 are connected inside the External Device.
- Do not connect anything to pins 6 and 7 on the External Device.

## 6 Supported Devices

The following table shows the range of supported device addresses. Please note that the actual supported range of the devices varies depending on the External Device to be used. Please check the actual range in the manual of your External Device.

Enter the External Device address in the dialog box below.

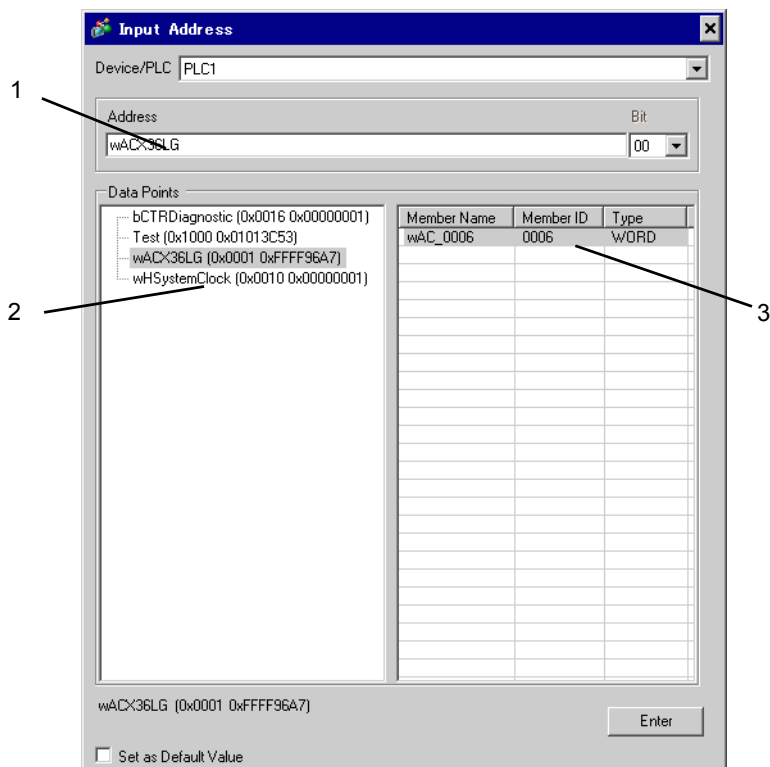

- |            |   |
|------------|---|
| 1. Address | The address is populated when you select a member. You can also input the address directly. |
| 2. Object  | Select the object with the member you want to use.  |
| 3. Member  | Select the member to use.   |

**NOTE**

- When the [Set as Default Value] check box is selected, the defined value is used as the initial value when entering a new address.

## 6.1 SAPHIR Series

Data Type	Bit Address	Word Address	32 bit	Notes
BOOL	Object Name.Member Name	-	-	*1
ACCESS	-	Object Name.Member Name		*1
WORD15	-	Object Name.Member Name		*1
INT	Object Name.Member Name.00 - Object Name.Member Name.15	Object Name.Member Name		*1
WORD	Object Name.Member Name.00 - Object Name.Member Name.15	Object Name.Member Name		*1
FLOAT	-	Object Name.Member Name	L / H	*1
LONG	Object Name.Member Name.00 - Object Name.Member Name.31	Object Name.Member Name		*1
ULONG	Object Name.Member Name.00 - Object Name.Member Name.31	Object Name.Member Name		*1
DOUBLE	-	Object Name.Member Name		*1 *2
STR6	-	Object Name.Member Name	-	*1
STR16	-	Object Name.Member Name		*1
STR20	-	Object Name.Member Name		*1
STR40	-	Object Name.Member Name		*1
STR80	-	Object Name.Member Name		*1

\*1 Including delimiters and the bit number, the length of the address must be 255 single-byte characters or less. When used in D-Script, the length must be 54 single-byte characters or less.

- You cannot start names with any of the following text:  
LS, USR, SCR, PRT

\*2 When using 64 bit devices in GP-Pro EX, values in the top 32 bits are ignored.

**NOTE**

- You can set only Read Area Size for the system area available to use in the External Device. Please refer to the GP-Pro EX Reference Manual for Read Area Size.  
Cf. GP-Pro EX Reference Manual "LS Area (Direct Access Method Area)"
- Please refer to the precautions on manual notation for icons in the table.

 "Manual Symbols and Terminology"

## ■ Data Points Dialog Box Settings

To display the [Data Points] dialog box in GP-Pro EX, in the [Individual Device Settings] dialog box click either [New] or [Edit].

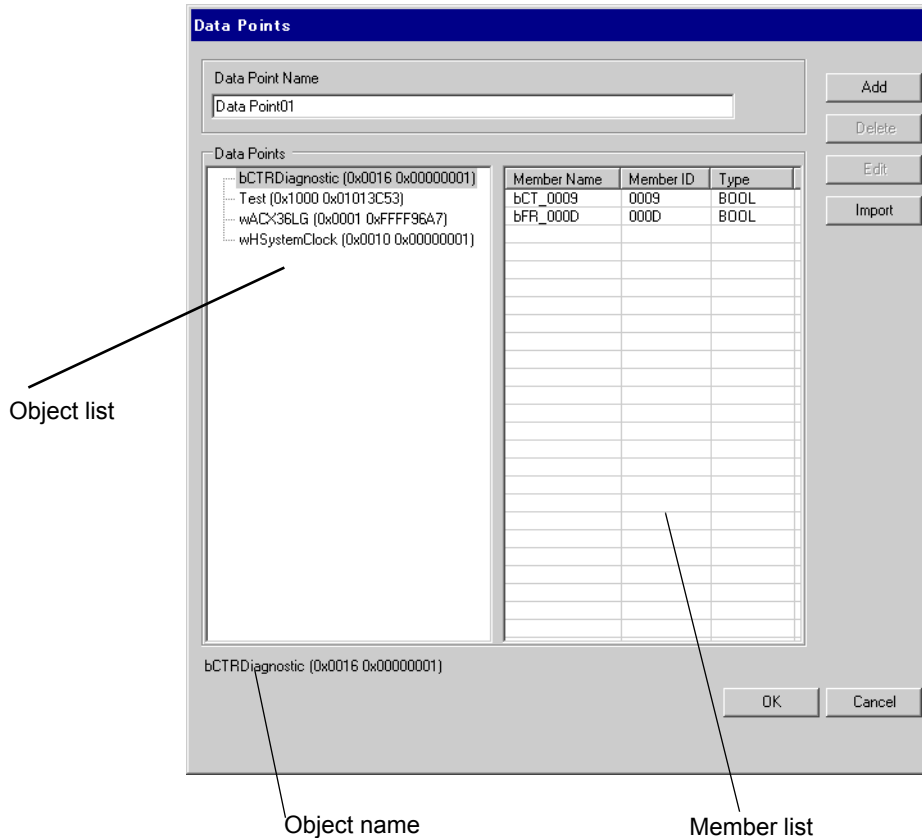

Setup Items	Setup Description
Data Point Name	Enter the Data Point name.
Object list	Displays the objects in the data point.
Member list	Displays the members in the object.
Add	Add an object and a member. ☞ " ■ Creating New Data Points" (page 27)
Delete	Delete the selected member. If you delete all members, the object is also deleted.
Edit	Edit the selected member.
Import	Import a Data Point file (.csv). ☞ " ■ Importing Data Points" (page 21)
Object name	Displays the name of the object selected in the object list.

### ■ Importing Data Points

1 In GP-Pro EX, open the [Individual Device Settings] dialog box, and from [Target] select the External Device.

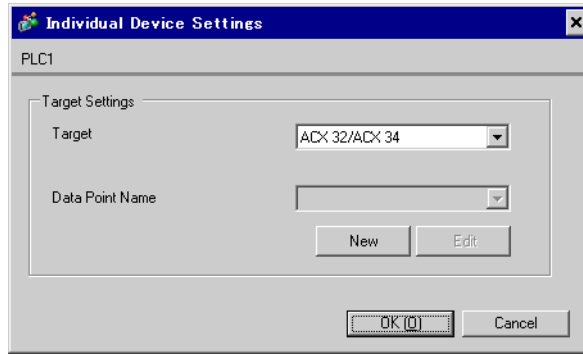

2 Click [New] to display the [Data Points] dialog box.

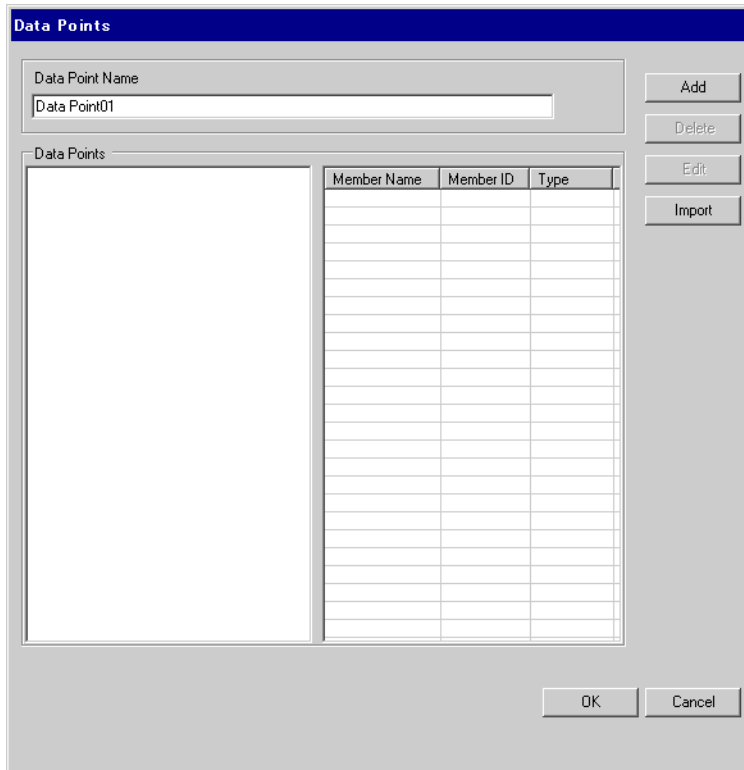

3 Click [Import] to display the [Select Data Points] dialog box.

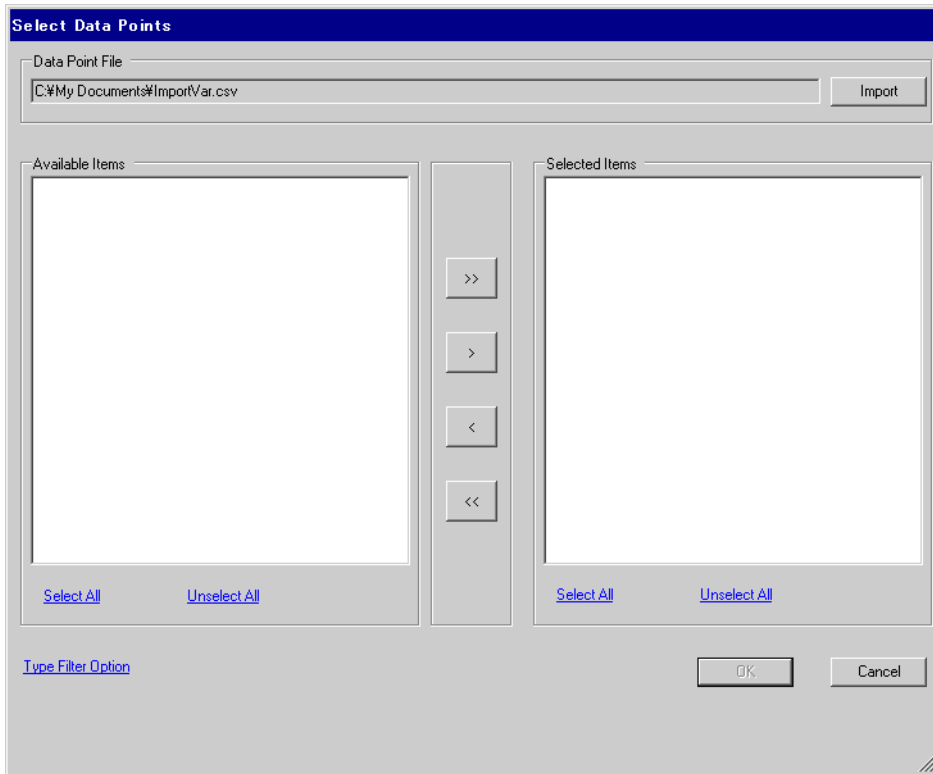

- 4 Click [Import] to import the data point file (in \*.CSV format). Objects in the data point file display in the [Available Items] area.

Refer to the following section that describes the data point file format you will be importing.

☞ " ■ Data Point File Format" (page 26)

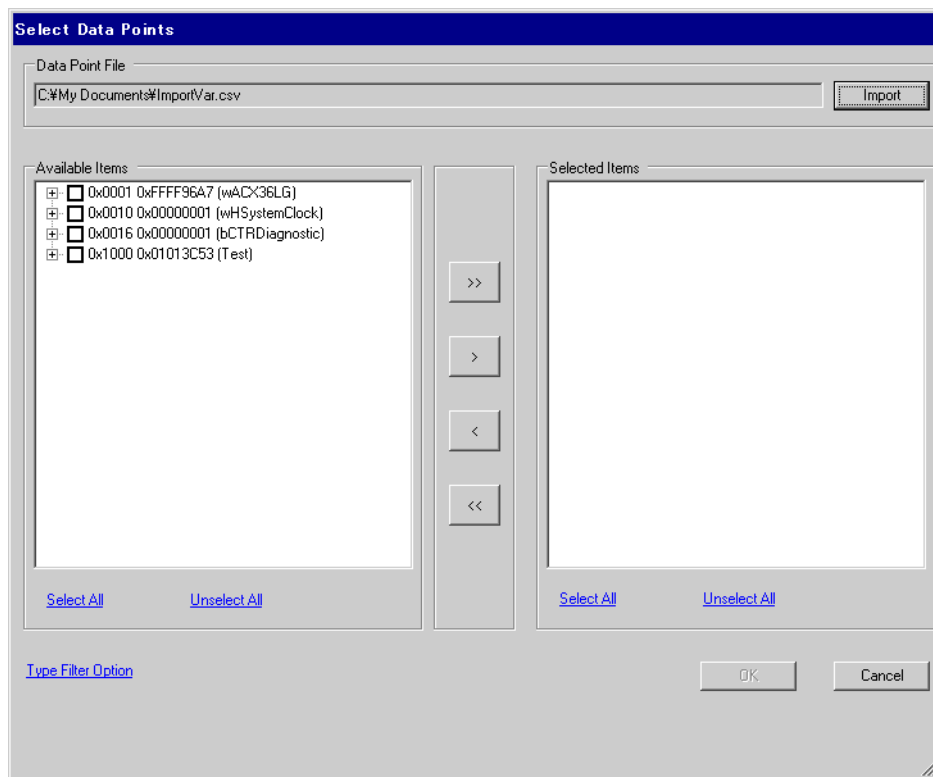

5 Move the objects you want to use to [Selected Items] and click [OK].

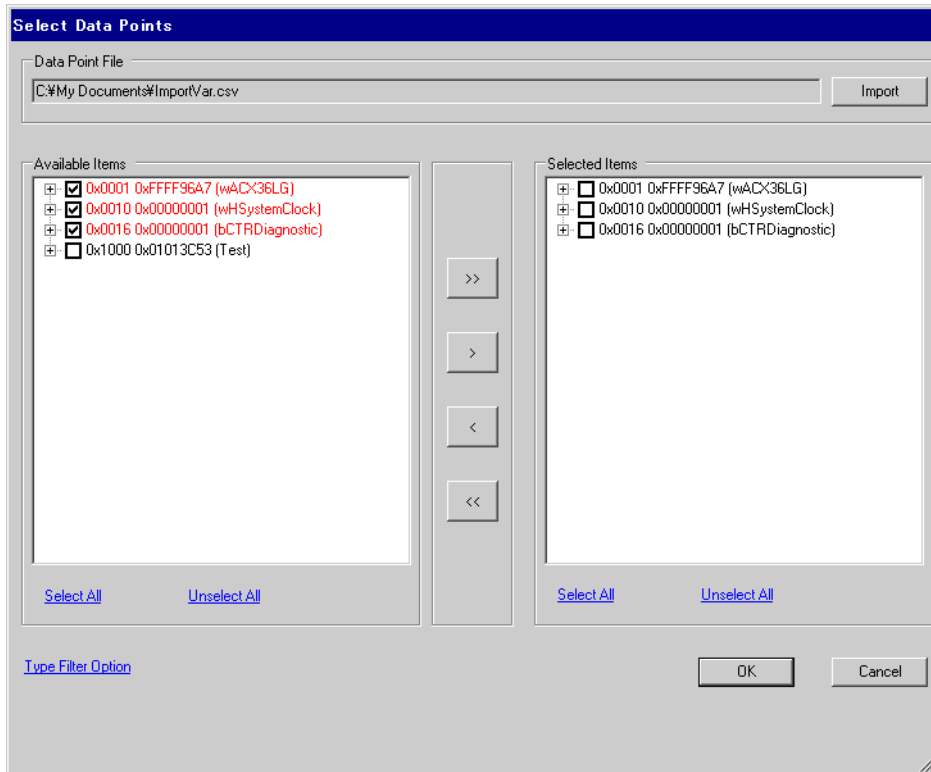

**NOTE**

- Use the following buttons to assist with setting up the objects.
  - [ >>> ] moves all objects to [Selected Items].
  - [ > ] moves selected objects to [Selected Items].
  - [ < ] removes selected objects from [Selected Items].
  - [ <<< ] removes all objects from [Selected Items].
- When all members of an object are selected, the object name displays in red. When only some of the members of an object are selected, the object name displays in blue.
- Click [Type Filter Option] to filter the object display. Select the check boxes of data types you want to display.

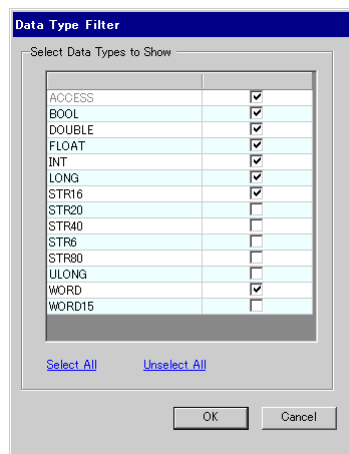



## 6 Imports the file and generates data points.

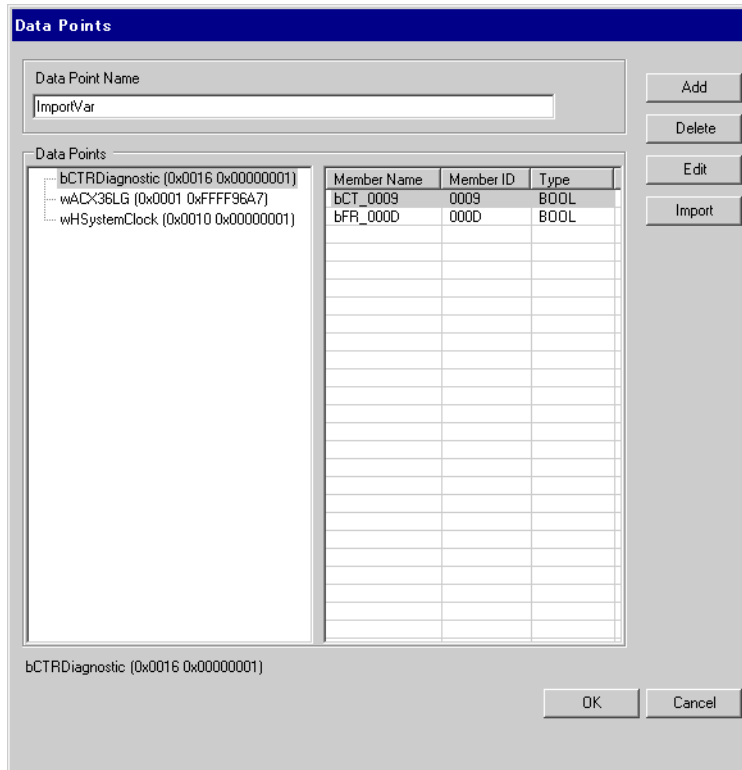

### NOTE

- When the Data point file has an object or a member that cannot be imported, a message box prompts for a log output.
- After importing, displays member names with 3 letters from the object name plus the member ID. Depending on the object name length, conversion is as follows.
  - Object name is 3 characters or less  
When the object name is "ABC" and the member ID is "0x0002", the member name after import is "Mem\_0002".
  - Object name is 4 characters or more  
When the object name is "DEFG" and the member ID is "0x0004", the member name after import is "DEF\_0004".

## ■ Data Point File Format

The data point file (in \*.CSV format) imported to GP-Pro EX will have the following format:

object name,object type,object ID,member ID,member type

Example Data Point File:

```
ACX36,0x0001,0xFFFF96A7,0x0010,WORD
ACX36,0x0001,0xFFFF96A7,0x0011,WORD
ACX36,0x0001,0xFFFF96A7,0x0012,WORD
EnableObjects,0x001A,0x0000B9AB,0x1000,WORD
EnableObjects,0x001A,0x0000B9AB,0x1001,WORD
EnableObjects,0x001A,0x0000B9AB,0x1100,STR16
HMIConfig,0x0012,0x00000001,0x1000,WORD
HMIConfig,0x0012,0x00000001,0x1001,WORD
```

## ■ Creating New Data Points

- 1 From GP-Pro EX, open the [Individual Device Settings] dialog box, and from [Target] select the External Device.

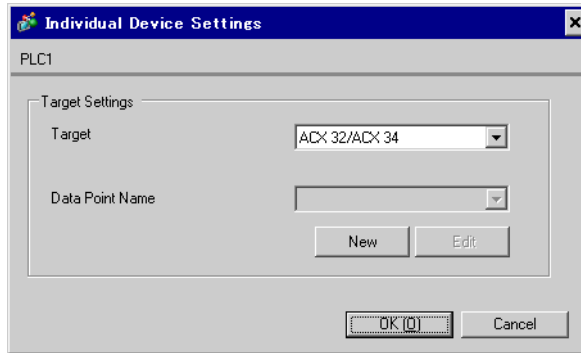

- 2 Click [New] to display the [Data Points] dialog box. Enter the Data Point name.

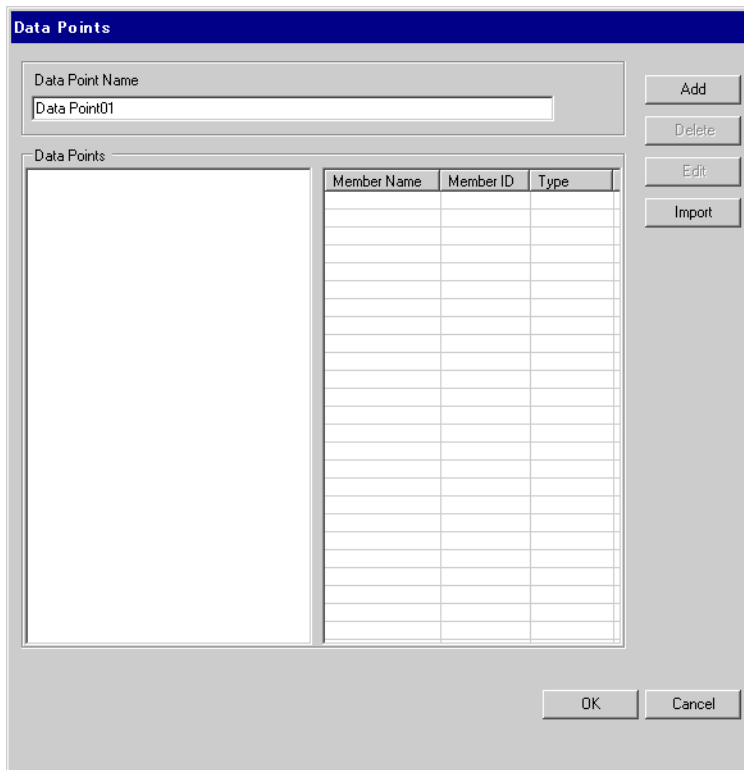

- 3 Click [Add] to display the [Data Point - Add] dialog box.

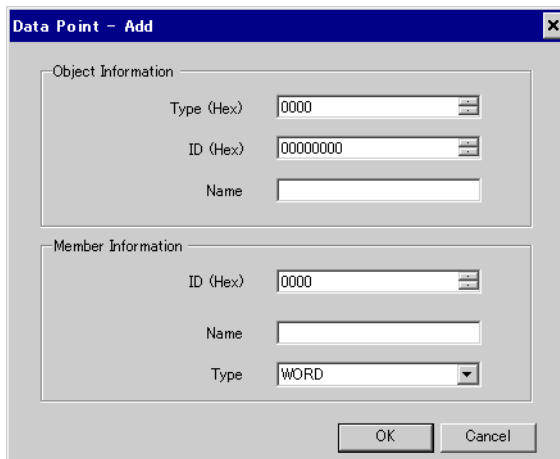

**Data Point - Add**

Object Information

Type (Hex) 0000

ID (Hex) 00000000

Name

Member Information

ID (Hex) 0000

Name

Type WORD

OK Cancel

- 4 Set up the object and member. The settings must be the same as the External Device's data point settings.

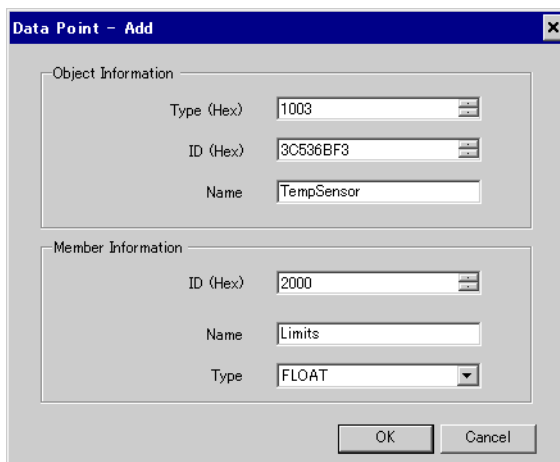

**Data Point - Add**

Object Information

Type (Hex) 1003

ID (Hex) 3C536BF3

Name TempSensor

Member Information

ID (Hex) 2000

Name Limits

Type FLOAT

OK Cancel

The created object and member appear in the list.

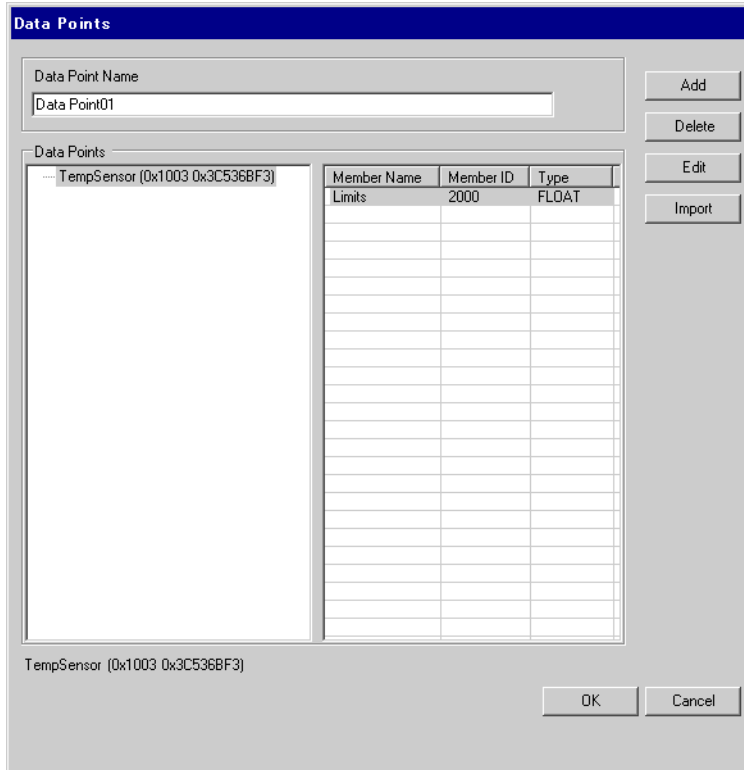

The screenshot shows a software window titled "Data Points". At the top, there is a text input field labeled "Data Point Name" containing the text "Data Point01". To the right of this field are four buttons: "Add", "Delete", "Edit", and "Import". Below the input field is a section titled "Data Points" containing a list of data points. The first entry is "TempSensor (0x1003 0x3C536BF3)". To the right of this list is a table with three columns: "Member Name", "Member ID", and "Type". The table contains one row with the following data:

Member Name	Member ID	Type
Limits	2000	FLOAT

At the bottom of the window, there is a label "TempSensor (0x1003 0x3C536BF3)" and two buttons: "OK" and "Cancel".

---

## 7 Device Code and Address Code

Device and address codes are not available.

## 8 Error Messages

Error messages are displayed on the Display screen as follows: "No. : Device Name: Error Message (Error Occurrence Area)". Each description is shown below.

Item	Description
No.	Error number
Device Name	Name of the External Device where an error has occurred. Device/PLC name is the title of the External Device set with GP-Pro EX. (Initial value [PLC1])
Error Message	Displays messages related to an error that has occurred.
Error Occurrence Area	Displays the IP address or device address of the External Device where an error has occurred, or error codes received from the External Device. <div style="border: 1px solid black; padding: 2px; display: inline-block; margin-top: 5px;"><b>NOTE</b></div> <ul style="list-style-type: none"> <li>IP address is displayed as "IP address (Decimal): MAC address (Hex)".</li> <li>Device address is displayed as "Address: Device address".</li> <li>Received error codes are displayed as "Decimal [Hex]".</li> </ul>

Example Error Message

"RHAA035:PLC1: Error has been responded for device write command (Error Code: 2 [02H])"

**NOTE**

- Refer to your External Device manual for details on received error codes.
- Refer to "Display-related errors" in "Maintenance/Troubleshooting Guide" for details on the error messages common to the driver.

### ■ Error Messages Unique to External Device

Error number	Error Message	Description
RHxx128	(Node name): Target does not match. Configured: (Decimal), Connected: (Decimal)	ID of the configured External Device does not match the ID of the connected External Device. Please select a valid External Device.

