



QUTE Series CPU Direct Driver

1	System Configuration.....	3
2	Selection of External Device	7
3	Example of Communication Setting.....	8
4	Setup Items.....	9
5	Cable Diagram	13
6	Supported Device.....	15
7	Device Code and Address Code.....	17
8	Error Messages.....	18

Introduction

This manual describes how to connect the Display and the External Device (target PLC).

In this manual, the connection procedure will be described by following the below sections:

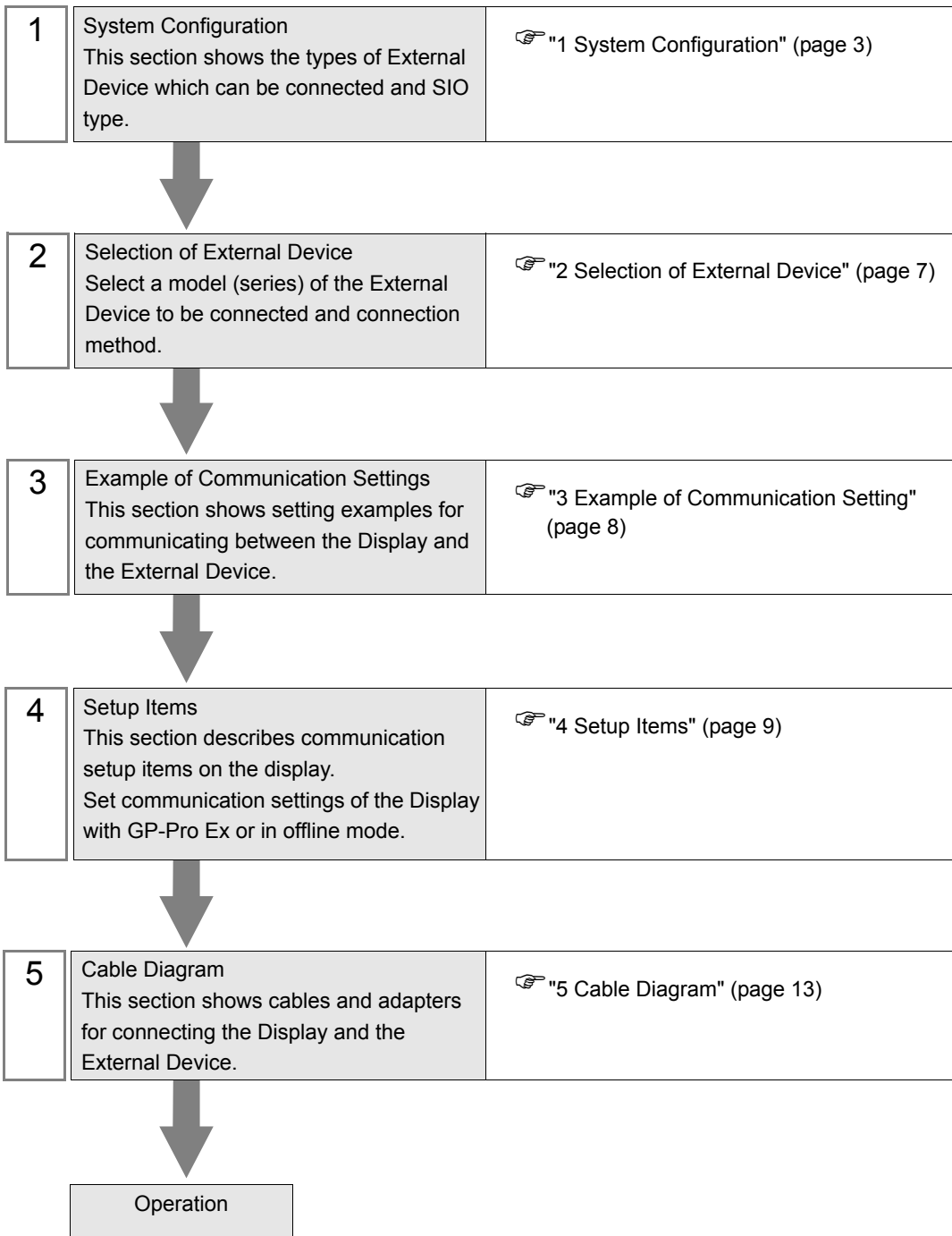

1 System Configuration

The system configuration in the case when the External Device of Mitsubishi Electric Corporation and the Display are connected is shown.

Series	CPU	Link I/F	SIO Type	Setting Example	Cable Diagram
MELSEC Q Series	Q00JCPU Q00CPU Q01CPU	RS-232C connector on CPU	RS-232C	Setting Example 1 (page 8)	Cable Diagram 1 (page 13)

■ IPC COM Port

When connecting IPC with an External Device, the COM port used depends on the series and SIO type. Please refer to the IPC manual for details.

Usable port

Series	Usable Port		
	RS-232C	RS-422/485(4 wire)	RS-422/485(2 wire)
PS-2000B	COM1 ^{*1} , COM2, COM3 ^{*1} , COM4	-	-
PS-3450A, PS-3451A, PS3000-BA, PS3001-BD	COM1, COM2 ^{*1*2}	COM2 ^{*1*2}	COM2 ^{*1*2}
PS-3650A (T41 model), PS-3651A (T41 model)	COM1 ^{*1}	-	-
PS-3650A (T42 model), PS-3651A (T42 model)	COM1 ^{*1*2} , COM2	COM1 ^{*1*2}	COM1 ^{*1*2}
PS-3700A (Pentium®4-M) PS-3710A	COM1 ^{*1} , COM2 ^{*1} , COM3 ^{*2} , COM4	COM3 ^{*2}	COM3 ^{*2}
PS-3711A	COM1 ^{*1} , COM2 ^{*2}	COM2 ^{*2}	COM2 ^{*2}
PS4000 ^{*3}	COM1, COM2	-	-
PL3000	COM1 ^{*1*2} , COM2 ^{*1} , COM3, COM4	COM1 ^{*1*2}	COM1 ^{*1*2}
PE-4000B Atom N270	COM1, COM2	-	-
PE-4000B Atom N2600	COM1, COM2	COM3 ^{*4} , COM4 ^{*4} , COM5 ^{*4} , COM6 ^{*4}	COM3 ^{*4} , COM4 ^{*4} , COM5 ^{*4} , COM6 ^{*4}
PS5000 (Slim Panel Type Core i3 Model) ^{*5*6}	COM1, COM2 ^{*4}	COM2 ^{*4}	COM2 ^{*4}
PS5000 (Slim Panel Type Atom Model) ^{*5*6}	COM1, COM2 ^{*7}	COM2 ^{*7}	COM2 ^{*7}
PS5000 (Enclosed Panel Type) ^{*8}	COM1	-	-
PS5000 (Modular Type PFXPU/PFXPP) ^{*5*6} PS5000 (Modular Type PFXPL2B5-6)	COM1 ^{*7}	COM1 ^{*7}	COM1 ^{*7}
PS5000 (Modular Type PFXPL2B1-4)	COM1, COM2 ^{*7}	COM2 ^{*7}	COM2 ^{*7}
PS6000	COM1 ^{*9}	^{*10}	^{*10}

*1 The RI/5V can be switched. Use the IPC's switch to change if necessary.

*2 Set up the SIO type with the DIP Switch. Please set up as follows according to SIO type to be used.

*3 When making communication between an External Device and COM port on the Expansion slot, only RS-232C is supported. However, ER (DTR/CTS) control cannot be executed because of the specification of COM port.

For connection with External Device, use user-created cables and disable Pin Nos. 1, 4, 6 and 9. Please refer to the IPC manual for details of pin layout.

*4 Set up the SIO type with the BIOS. Please refer to the IPC manual for details of BIOS.

- *5 When setting up communication between an External Device and the RS-232C/422/485 interface module, use the IPC (RS-232C) or PS5000 (RS-422/485) cable diagrams. However, when using PFXZPBMPR42P2 in a RS-422/485 (4-wire) configuration with no flow control, connect 7.RTS+ and 8.CTS+, and connect 6.RTS- and 9.CTS-.
When using RS-422/485 communication with External Devices, you may need to reduce the transmission speed and increase the TX Wait time.
- *6 To use RS-422/485 communication on the RS-232C/422/485 interface module, the DIP Switch setting is required. Please refer to "Knowledge Base" (FAQs) on the support site. (<http://www.pro-face.com/trans/en/manual/1001.html>)

Settings	FAQ ID
PFXZPBMPR42P2, RS422/485 change method	FA263858
PFXZPBMPR42P2 termination resistor setting	FA263974
PFXZPBMPR44P2, RS422/485 change method	FA264087
PFXZPBMPR44P2 termination resistor setting	FA264088

- *7 Set up the SIO type with the DIP Switch. Please refer to the IPC manual for details of DIP Switch. The BOX Atom has not a switch to set the RS-232C, RS-422/485 mode. Use the BIOS for the setting.
- *8 For the connection with the External Device, on the user-created cable read as if the connector on the Display-side is a M12 A-coding 8 pin socket. The pin assignment is the same as described in the cable diagram. For the M12 A-coding connector, use PFXZPSCNM122.
- *9 In addition to COM1, you can also use the RS-232C COM port on the optional interface.
- *10 Install the optional interface in the expansion slot.

DIP Switch settings (PL3000 / PS3000 Series)

RS-232C

DIP Switch	Setting	Description
1	OFF*1	Reserved (always OFF)
2	OFF	SIO type: RS-232C
3	OFF	
4	OFF	Output mode of SD (TXD) data: Always output
5	OFF	Terminal resistance (220Ω) insertion to SD (TXD): None
6	OFF	Terminal resistance (220Ω) insertion to RD (RXD): None
7	OFF	Short-circuit of SDA (TXA) and RDA (RXA): Not available
8	OFF	Short-circuit of SDB (TXB) and RDB (RXB): Not available
9	OFF	RS (RTS) Auto control mode: Disabled
10	OFF	

*1 When using PS-3450A, PS-3451A, PS3000-BA and PS3001-BD, turn ON the set value.

RS-422/485 (4 wire)

DIP Switch	Setting	Description
1	OFF	Reserved (always OFF)
2	ON	SIO type: RS-422/485
3	ON	
4	OFF	Output mode of SD (TXD) data: Always output
5	OFF	Terminal resistance (220Ω) insertion to SD (TXD): None
6	OFF	Terminal resistance (220Ω) insertion to RD (RXD): None
7	OFF	Short-circuit of SDA (TXA) and RDA (RXA): Not available
8	OFF	Short-circuit of SDB (TXB) and RDB (RXB): Not available
9	OFF	RS (RTS) Auto control mode: Disabled
10	OFF	

RS-422/485 (2 wire)

DIP Switch	Setting	Description
1	OFF	Reserved (always OFF)
2	ON	SIO type: RS-422/485
3	ON	
4	OFF	Output mode of SD (TXD) data: Always output
5	OFF	Terminal resistance (220Ω) insertion to SD (TXD): None
6	OFF	Terminal resistance (220Ω) insertion to RD (RXD): None
7	ON	Short-circuit of SDA (TXA) and RDA (RXA): Available
8	ON	Short-circuit of SDB (TXB) and RDB (RXB): Available
9	ON	RS (RTS) Auto control mode: Enabled
10	ON	

2 Selection of External Device

Select the External Device to be connected to the Display.

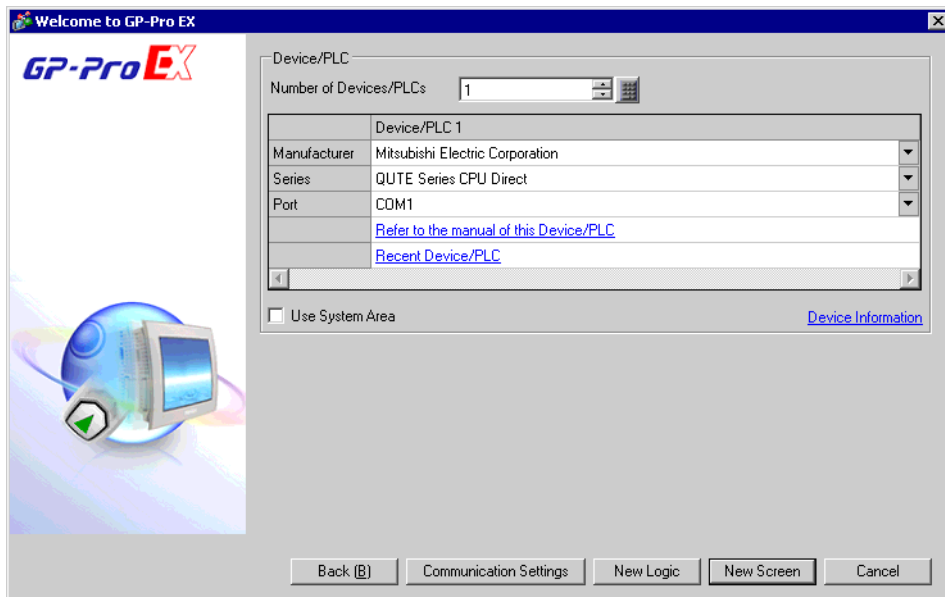

Setup Items	Setup Description
Number of Devices/PLCs	Enter an integer from 1 to 4 to define the number of Devices/PLCs to connect to the display.
Manufacturer	Select the manufacturer of the External Device to connect. Select "Mitsubishi Electric Corporation".
Series	Select the External Device model (series) and the connection method. Select "QUTE Series CPU Direct". In System configuration, make sure the External Device you are connecting is supported by "QUTE Series CPU Direct". ☞ "1 System Configuration" (page 3)
Port	Select the Display port to connect to the External Device.
Use System Area	Check this option to synchronize the system data area of the Display and the device (memory) of the External Device. When synchronized, you can use the External Device's ladder program to switch the display or display the window on the Display. Cf. GP-Pro EX Reference Manual "LS Area (Direct Access Method Area)" This feature can also be set in GP-Pro EX or in the Display's offline mode. Cf. GP-Pro EX Reference Manual "System Settings [Display Unit] - [System Area] Settings Guide" Cf. Maintenance/Troubleshooting Guide "Main Unit - System Area Settings"

3 Example of Communication Setting

Examples of communication settings of the Display and the External Device, recommended by Pro-face, are shown.

3.1 Setting Example 1

■ Settings of GP-Pro EX

◆ Communication Settings

To display the setup screen, from the [Project] menu, point to [System Settings] and select [Device/PLC].

Device/PLC 1

Summary [Change Device/PLC](#)

Manufacturer Series Port

Text Data Mode [Change](#)

Communication Settings

SIO Type RS232C RS422/485(2wire) RS422/485(4wire)

Speed

Data Length 7 8

Parity NONE EVEN ODD

Stop Bit 1 2

Flow Control NONE ER(DTR/DS) XON/XOFF

Timeout (sec)

Retry

Wait To Send (ms)

RI / VCC RI VCC

In the case of RS232C, you can select the 9th pin to RI (Input) or VCC (5V Power Supply). If you use the Digital's RS232C Isolation Unit, please select it to VCC.

[Default](#)

Device-Specific Settings

Allowable Number of Devices/PLCs [Add Device](#)

No.	Device Name	Settings
<input type="text" value="1"/>	<input type="text" value="PLC1"/>	<input type="text"/>

[Add Indirect Device](#)

■ Settings of External Device

There is no setting on the External Device. The speed automatically switches according to the Display setting.

NOTE • When connecting to Q00CPU and Q01CPU, disable to use the serial communication function.

4 Setup Items

Set communication settings of the Display with GP-Pro EX or in offline mode of the Display.

The setting of each parameter must be identical to that of External Device.

☞ "3 Example of Communication Setting" (page 8)

4.1 Setup Items in GP-Pro EX

■ Communication Settings

To display the setup screen, from the [Project] menu, point to [System Settings] and select [Device/PLC].

Setup Items	Setup Description
SIO Type	SIO type to communicate with the External Device is displayed.
Speed	Select speed between the External Device and the Display.
Data Length	Data length is displayed.
Parity	The parity check method is displayed.
Stop Bit	Stop bit length is displayed.
Flow Control	The communication control method to prevent overflow of transmission and reception data is displayed.
Timeout	Use an integer from 1 to 127 to enter the time (s) for which the Display waits for the response from the External Device.
Retry	In case of no response from the External Device, use an integer from 0 to 255 to enter how many times the Display retransmits the command.

continued to next page

Setup Items	Setup Description
Wait To Send	Use an integer from 0 to 255 to enter standby time (ms) for the Display from receiving packets to transmitting next commands.
RI/VCC	Switches RI/VCC of the 9th pin. It is necessary to change RI/5V by changeover switch of IPC when connect with IPC. Please refer to the manual of the IPC for more detail.

NOTE

- Refer to the GP-Pro EX Reference Manual for Indirect Device.
Cf. GP-Pro EX Reference Manual "Changing the Device/PLC at Runtime (Indirect Device)"
-

4.2 Setup Items in Offline Mode

- NOTE** • Refer to the Maintenance/Troubleshooting guide for information on how to enter offline mode or about the operation.

Cf. Maintenance/Troubleshooting Guide "Offline Mode"

- The number of the setup items to be displayed for 1 page in the offline mode depends on the Display in use. Please refer to the Reference manual for details.

■ Communication Settings

To display the setting screen, touch [Device/PLC Settings] from [Peripheral Settings] in offline mode. Touch the External Device you want to set from the displayed list.

Comm.	Option			
QUTE Series CPU Direct		[COM1]	Page 1/1	
SIO Type	RS232C			
Speed	19200			
Data Length	8			
Parity	ODD			
Stop Bit	1			
Flow Control	ER(DTR/CTS)			
Timeout(s)		3	▼	▲
Retry		2	▼	▲
Wait To Sendt(ms)		0	▼	▲
Exit		Back		2005/12/16 16:53:03

Setup Items	Setup Description
SIO Type	Select the SIO type to communicate with the External Device. IMPORTANT To make the communication settings correctly, confirm the serial interface specifications of Display unit for [SIO Type]. We cannot guarantee the operation if a communication type that the serial interface does not support is specified. For details concerning the serial interface specifications, refer to the manual for Display unit.
Speed	Select speed between the External Device and the Display.
Data Length	Data length is displayed.
Parity	The parity check method is displayed.
Stop Bit	Stop bit length is displayed.
Flow Control	The communication control method to prevent overflow of transmission and reception data is displayed.

Setup Items	Setup Description
Timeout	Use an integer from 1 to 127 to enter the time (s) for which the Display waits for the response from the External Device.
Retry	In case of no response from the External Device, use an integer from 0 to 255 to enter how many times the Display retransmits the command.
Wait To Send	Use an integer from 0 to 255 to enter standby time (ms) for the Display from receiving packets to transmitting next commands.

■ Option

To display the setting screen, touch [Device/PLC Settings] from [Peripheral Settings]. Touch the External Device you want to set from the displayed list, and touch [Option].

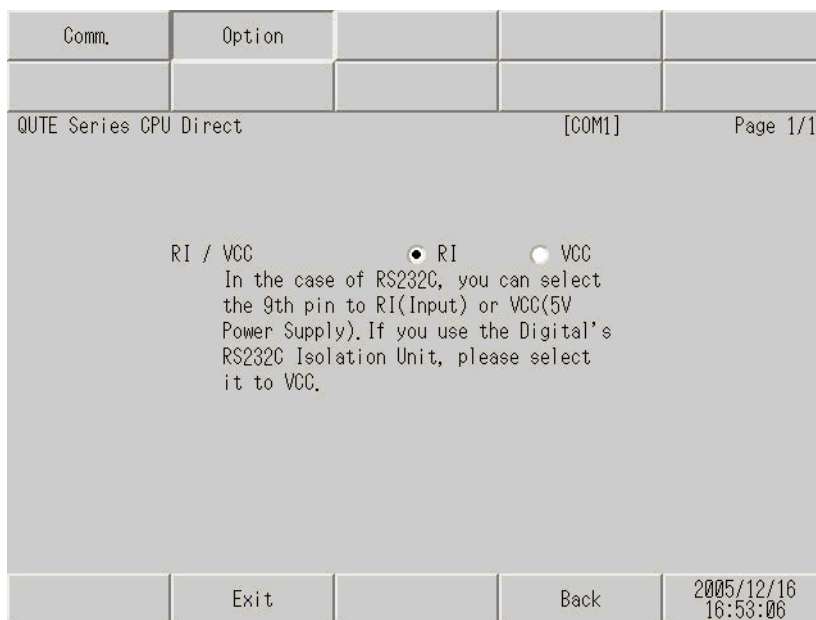

Setup Items	Setup Description
RI/VCC	Switches RI/VCC of the 9th pin. It is necessary to change RI/5V by changeover switch of IPC when connect with IPC. Please refer to the manual of the IPC for more detail.

NOTE

- GP-4100 series, GP-4*01TM and GP-Rear Module do not have the [Option] setting in the offline mode.

5 Cable Diagram

The cable diagram shown below may be different from the cable diagram recommended by Mitsubishi Electric Corporation. Please be assured there is no operational problem in applying the cable diagram shown in this manual.

- The FG pin of the main body of the External Device must be D-class grounded. Please refer to the manual of the External Device for more details.
- SG and FG are connected inside the Display. When connecting SG to the External Device, design the system not to form short-circuit loop.
- Connect the isolation unit, when communication is not stabilized under the influence of a noise etc..

Cable Diagram 1

Display (Connection Port)		Cable	Notes
GP3000 (COM1) GP4000* ¹ (COM1) SP5000* ² (COM1/2) SP-5B00 (COM1) ST3000 (COM1) ST6000 (COM1) STM6000 (COM1) LT3000 (COM1) IPC* ³ PC/AT	1A	Mitsubishi PLC Q-Series Connection Cable by Pro-face CA3-CBLQ-01(5m) or RS-232C cable by Mitsubishi Electric Corp. QC30R2 (3m) or RS-232C cable for RS-232C cable by Diatrend Corp. DQCABR2V-H	Available to order the length of DQCABR2V-H by Diatrend Corp. up to 15m.
GP-4105 (COM1) GP-4115T (COM1) GP-4115T3 (COM1)	1B	Mitsubishi PLC Q Series CPU I/F Cable by Pro-face ZC9CBQ31(3m)	

*1 All GP4000 models except GP-4100 Series and GP-4203T

*2 Except SP-5B00

*3 Only the COM port which can communicate by RS-232C can be used.

 ■ IPC COM Port (page 4)

1A)

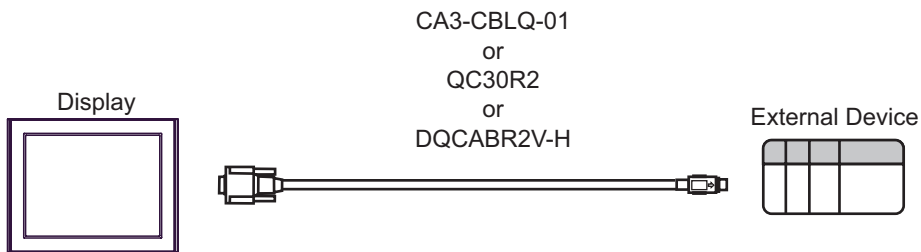

1B)

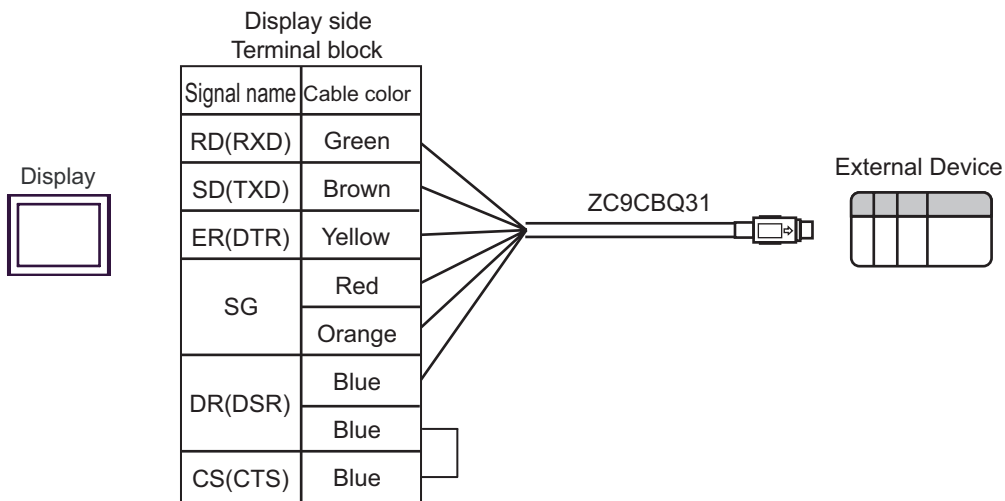



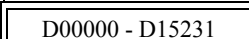

6 Supported Device

Range of supported device address is shown in the table below. Please note that the actually supported range of the devices varies depending on the External Device to be used. Please check the actual range in the manual of your External Device.

 This address can be specified as system data area.

Device	Bit Address	Word Address	32 bits	Notes
Input Relay	X000 - X7FF	X000 - X7F0	L / H	
Output Relay	Y000 - Y7FF	Y000 - Y7F0		
Internal Relay	M00000 - M32767	M00000 - M32752		
Special Relay	SM0000 - SM1023	SM0000 - SM1008		
Latch Relay	L00000 - L32767	L00000 - L32752		
Annunciator	F00000 - F32767	F00000 - F32752		
Edge Relay	V00000 - V32767	V00000 - V32752		
Step Relay	S0000 - S2047	S0000 - S2032		
Link Relay	B0000 - B7FFF	B0000 - B7FF0		
Special Link Relay	SB000 - SB3FF	SB000 - SB3F0		
Timer (Contact)	TS00000 - TS13535	-----		
Timer (Coil)	TC00000 - TC13535	-----		
Retentive Timer (Contact)	SS00000 - SS13535	-----		
Retentive Timer (Coil)	SC00000 - SC13535	-----		
Counter (Contact)	CS00000 - CS13535	-----		
Counter (Coil)	CC00000 - CC13535	-----		
Timer (Current Value)	-----	TN00000 - TN13535		
Retentive Timer (Current Value)	-----	SN00000 - SN13535		
Counter (Current Value)	-----	CN00000 - CN13535		
Data Register	-----	 D00000 - D15231		
Special Register	-----	SD0000 - SD1023		
Link Register	-----	W0000 - W3B7F		
Special Link Register	-----	SW000 - SW3FF		
File Register (Normal)	-----	R00000 - R32767		*1

continued to next page

Device	Bit Address	Word Address	32 bits	Notes
File Register (Block switching is not necessary)	-----	ZR00000 - ZR65535		 *1
File Register (0R-1R)	-----	0R00000 - 0R32767		 *1 *2 *3
	-----	1R00000 - 1R32767		 *1 *2 *3

- *1 Only Q00CPU and Q01CPU are available to use. Q00JCPU cannot be used.
- *2 Set the block No. on the head of device name. This is the device name for conversion with GP-Pro/PB III for Windows. When you newly specify the device, we recommend that you should use the file register (Block switching is not necessary).
- *3 PLC does not have the description of this device, which is supported by this driver for the compatibility with GP-Pro/PB III for Windows.

NOTE

- Please refer to the GP-Pro EX Reference Manual for system data area.
Cf. GP-Pro EX Reference Manual "LS Area (Direct Access Method Area)"
- Please refer to the precautions on manual notation for icons in the table.
 "Manual Symbols and Terminology"
- Even when the inexistent address is used, the reading error might not be displayed. In this case, "0" is retained for the read data. Note that the writing error is displayed.

7 Device Code and Address Code

Use device code and address code when you select "Device Type & Address" for the address type in data displays.

Device	Device Name	Device Code (HEX)	Address Code
Input Relay	X	0080	Value of word address divided by 0x10
Output Relay	Y	0081	Value of word address divided by 0x10
Internal Relay	M	0082	Value of word address divided by 16
Special Relay	SM	0083	Value of word address divided by 16
Latch Relay	L	0084	Value of word address divided by 16
Annunciator	F	0085	Value of word address divided by 16
Edge Relay	V	0086	Value of word address divided by 16
Step Relay	S	0087	Value of word address divided by 16
Link Relay	B	0088	Value of word address divided by 0x10
Special Link Relay	SB	0089	Value of word address divided by 0x10
Timer (Current Value)	TN	0060	Word Address
Retentive Timer (Current Value)	SN	0062	Word Address
Counter (Current Value)	CN	0061	Word Address
Data Register	D	0000	Word Address
Special Register	SD	0001	Word Address
Link Register	W	0002	Word Address
Special Link Register	SW	0003	Word Address
File Register (Normal)	R	000F	Word Address
File Register (Block switching is not necessary)	ZR	000E	Word Address
File Register (0R-31R)	0R	0010	Word Address
	1R	0011	Word Address

8 Error Messages

Error messages are displayed on the screen of Display as follows: "No.: Device Name: Error Message (Error Occurrence Area)". Each description is shown below.

Item	Description
No.	Error No.
Device Name	Name of External Device where error occurs. Name of External Device is a title of External Device set with GP-Pro EX.((Initial value[PLC1])
Error Message	Displays messages related to the error which occurs.
Error Occurrence Area	Displays IP address or device address of External Device where error occurs, or error codes received from External Device. <div style="border: 1px solid black; padding: 2px; display: inline-block;">NOTE</div> <ul style="list-style-type: none"> • IP address is displayed such as "IP address(Decimal): MAC address (Hex)". • Device address is displayed such as "Address: Device address". • Received error codes are displayed such as "Decimal[Hex]".

Display Examples of Error Messages

"RHAA035: PLC1: Error has been responded for device write command (Error Code: 2 [02H])"

NOTE

- Refer to your External Device manual for details on received error codes.
- Refer to "Display-related errors" in "Maintenance/Troubleshooting Guide" for details on the error messages common to the driver.