



# A Series CPU Direct Driver

1	System Configuration.....	3
2	Selection of External Device .....	8
3	Example of Communication Setting.....	9
4	Setup Items .....	12
5	Cable Diagram .....	17
6	Supported Device.....	27
7	Device Code and Address Code.....	30
8	Error Messages .....	32

## Introduction

This manual describes how to connect the Display and the External Device (target PLC).

In this manual, the connection procedure will be described by following the below sections:

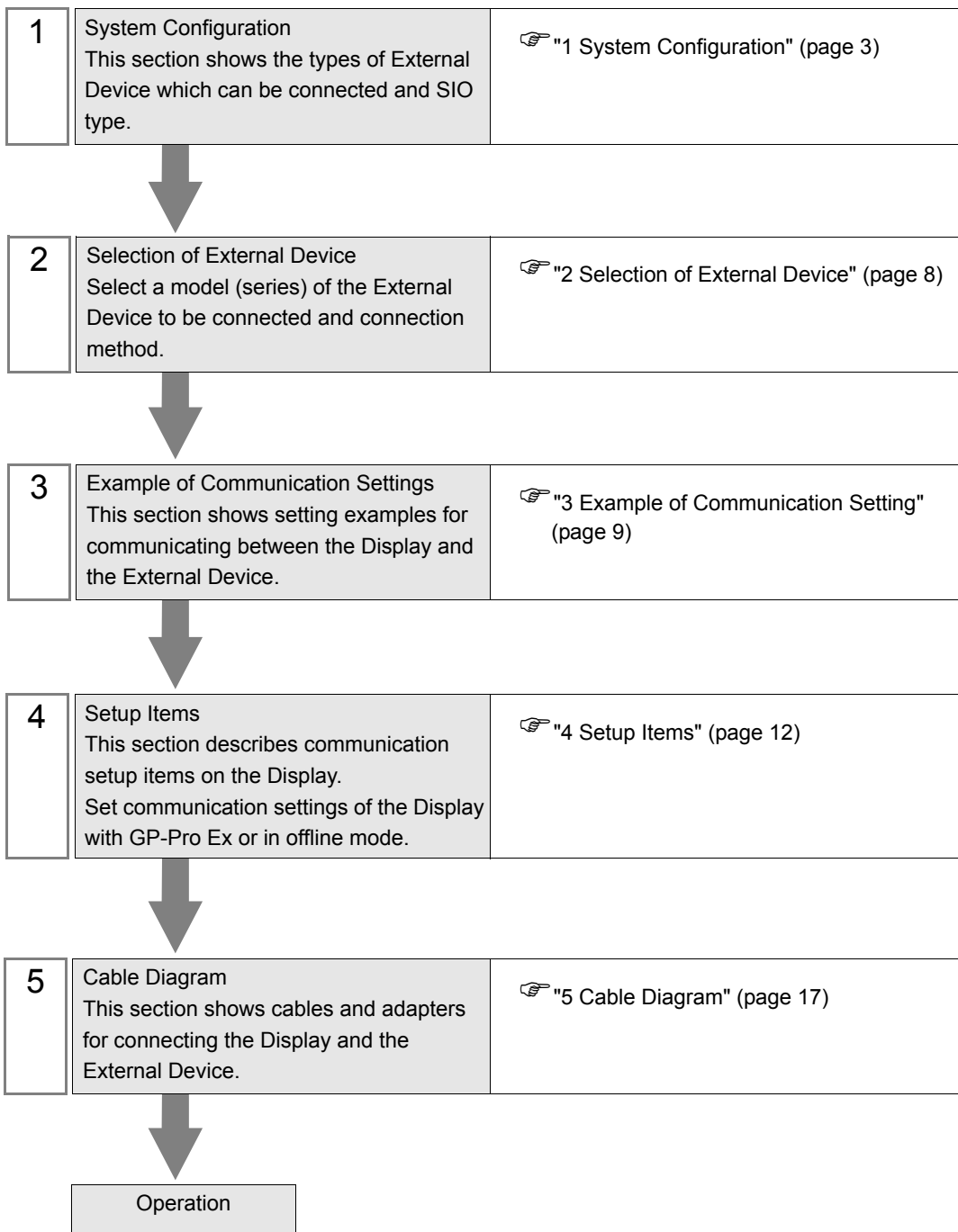

# 1 System Configuration

The system configuration in the case when the External Device of Mitsubishi Electric Corporation and the Display are connected is shown.

Series	CPU	Link I/F	SIO Type	Setting Example	Cable Diagram
MELSEC AnA Series	A2A A3A A2U A2US A2U-S1 A2US-S1 A2USH-S1 A3U A4U	CPU Direct	RS232C	Setting Example 1 (page 9)	Cable Diagram 1 (page 17)
	RS422 (4wire)		Setting Example 2 (page 10)	Cable Diagram 2 (page 18)	
	A2A A3A A2US A2U-S1 A2USH-S1 A4U	2-port adapter II by Pro-face (Model: GP070-MD11)	RS422 (4wire)	Setting Example 3 (page 11)	Cable Diagram 3 (page 21)

continued to next page

Series	CPU	Link I/F	SIO Type	Setting Example	Cable Diagram
MELSEC AnN Series	A2CCPU24	CPU Direct	RS232C	Setting Example 1 (page 9)	Cable Diagram 1 (page 17)
	A2CJ-S3				
	A3H				
	A0J2H				
	A1N				
	A2N				
	A3N				
	A1S				
	A1SH				
	A2SH				
	A1SJ				
	A2CJ-S3	2-port adapter II by Pro-face (Model: GP070-MD11)	RS422 (4wire)	Setting Example 3 (page 11)	Cable Diagram 3 (page 21)
	A3H				
	A0J2H				
A2N					
A3N					
A2SH					
A1SH					
A1S					
A1SJ					
MELSEC Q Series A Mode	Q02CPU-A Q02HCPU-A Q06HCPU-A	CPU Direct	RS232C	Setting Example 1 (page 9)	Cable Diagram 4 (page 25)

## ■ IPC COM Port

When connecting IPC with an External Device, the COM port used depends on the series and SIO type. Please refer to the IPC manual for details.

### Usable port

Series	Usable Port		
	RS-232C	RS-422/485(4 wire)	RS-422/485(2 wire)
PS-2000B	COM1 <sup>*1</sup> , COM2, COM3 <sup>*1</sup> , COM4	-	-
PS-3450A, PS-3451A, PS3000-BA, PS3001-BD	COM1, COM2 <sup>*1*2</sup>	COM2 <sup>*1*2</sup>	COM2 <sup>*1*2</sup>
PS-3650A (T41 model), PS-3651A (T41 model)	COM1 <sup>*1</sup>	-	-
PS-3650A (T42 model), PS-3651A (T42 model)	COM1 <sup>*1*2</sup> , COM2	COM1 <sup>*1*2</sup>	COM1 <sup>*1*2</sup>
PS-3700A (Pentium®4-M) PS-3710A	COM1 <sup>*1</sup> , COM2 <sup>*1</sup> , COM3 <sup>*2</sup> , COM4	COM3 <sup>*2</sup>	COM3 <sup>*2</sup>
PS-3711A	COM1 <sup>*1</sup> , COM2 <sup>*2</sup>	COM2 <sup>*2</sup>	COM2 <sup>*2</sup>
PS4000 <sup>*3</sup>	COM1, COM2	-	-
PL3000	COM1 <sup>*1*2</sup> , COM2 <sup>*1</sup> , COM3, COM4	COM1 <sup>*1*2</sup>	COM1 <sup>*1*2</sup>
PE-4000B Atom N270	COM1, COM2	-	-
PE-4000B Atom N2600	COM1, COM2	COM3 <sup>*4</sup> , COM4 <sup>*4</sup> , COM5 <sup>*4</sup> , COM6 <sup>*4</sup>	COM3 <sup>*4</sup> , COM4 <sup>*4</sup> , COM5 <sup>*4</sup> , COM6 <sup>*4</sup>
PS5000 (Slim Panel Type Core i3 Model) <sup>*5*6</sup>	COM1, COM2 <sup>*4</sup>	COM2 <sup>*4</sup>	COM2 <sup>*4</sup>
PS5000 (Slim Panel Type Atom Model) <sup>*5*6</sup>	COM1, COM2 <sup>*7</sup>	COM2 <sup>*7</sup>	COM2 <sup>*7</sup>
PS5000 (Enclosed Panel Type) <sup>*8</sup>	COM1	-	-
PS5000 (Modular Type PFXPU/PFXPP) <sup>*5*6</sup> PS5000 (Modular Type PFXPL2B5-6)	COM1 <sup>*7</sup>	COM1 <sup>*7</sup>	COM1 <sup>*7</sup>
PS5000 (Modular Type PFXPL2B1-4)	COM1, COM2 <sup>*7</sup>	COM2 <sup>*7</sup>	COM2 <sup>*7</sup>
PS6000	COM1 <sup>*9</sup>	<sup>*10</sup>	<sup>*10</sup>

\*1 The RI/5V can be switched. Use the IPC's switch to change if necessary.

\*2 Set up the SIO type with the DIP Switch. Please set up as follows according to SIO type to be used.

\*3 When making communication between an External Device and COM port on the Expansion slot, only RS-232C is supported. However, ER (DTR/CTS) control cannot be executed because of the specification of COM port.

For connection with External Device, use user-created cables and disable Pin Nos. 1, 4, 6 and 9. Please refer to the IPC manual for details of pin layout.

\*4 Set up the SIO type with the BIOS. Please refer to the IPC manual for details of BIOS.

- \*5 When setting up communication between an External Device and the RS-232C/422/485 interface module, use the IPC (RS-232C) or PS5000 (RS-422/485) cable diagrams. However, when using PFXZPBMPR42P2 in a RS-422/485 (4-wire) configuration with no flow control, connect 7.RTS+ and 8.CTS+, and connect 6.RTS- and 9.CTS-.  
When using RS-422/485 communication with External Devices, you may need to reduce the transmission speed and increase the TX Wait time.
- \*6 To use RS-422/485 communication on the RS-232C/422/485 interface module, the DIP Switch setting is required. Please refer to "Knowledge Base" (FAQs) on the support site. (<http://www.pro-face.com/trans/en/manual/1001.html>)

Settings	FAQ ID
PFXZPBMPR42P2, RS422/485 change method	FA263858
PFXZPBMPR42P2 termination resistor setting	FA263974
PFXZPBMPR44P2, RS422/485 change method	FA264087
PFXZPBMPR44P2 termination resistor setting	FA264088

- \*7 Set up the SIO type with the DIP Switch. Please refer to the IPC manual for details of DIP Switch. The BOX Atom has not a switch to set the RS-232C, RS-422/485 mode. Use the BIOS for the setting.
- \*8 For the connection with the External Device, on the user-created cable read as if the connector on the Display-side is a M12 A-coding 8 pin socket. The pin assignment is the same as described in the cable diagram. For the M12 A-coding connector, use PFXZPSCNM122.
- \*9 In addition to COM1, you can also use the RS-232C COM port on the optional interface.
- \*10 Install the optional interface in the expansion slot.

## DIP Switch settings (PL3000 / PS3000 Series)

### RS-232C

DIP Switch	Setting	Description
1	OFF*1	Reserved (always OFF)
2	OFF	SIO type: RS-232C
3	OFF	
4	OFF	Output mode of SD (TXD) data: Always output
5	OFF	Terminal resistance (220Ω) insertion to SD (TXD): None
6	OFF	Terminal resistance (220Ω) insertion to RD (RXD): None
7	OFF	Short-circuit of SDA (TXA) and RDA (RXA): Not available
8	OFF	Short-circuit of SDB (TXB) and RDB (RXB): Not available
9	OFF	RS (RTS) Auto control mode: Disabled
10	OFF	

\*1 When using PS-3450A, PS-3451A, PS3000-BA and PS3001-BD, turn ON the set value.

## RS-422/485 (4 wire)

DIP Switch	Setting	Description
1	OFF	Reserved (always OFF)
2	ON	SIO type: RS-422/485
3	ON	
4	OFF	Output mode of SD (TXD) data: Always output
5	OFF	Terminal resistance (220Ω) insertion to SD (TXD): None
6	OFF	Terminal resistance (220Ω) insertion to RD (RXD): None
7	OFF	Short-circuit of SDA (TXA) and RDA (RXA): Not available
8	OFF	Short-circuit of SDB (TXB) and RDB (RXB): Not available
9	OFF	RS (RTS) Auto control mode: Disabled
10	OFF	

## RS-422/485 (2 wire)

DIP Switch	Setting	Description
1	OFF	Reserved (always OFF)
2	ON	SIO type: RS-422/485
3	ON	
4	OFF	Output mode of SD (TXD) data: Always output
5	OFF	Terminal resistance (220Ω) insertion to SD (TXD): None
6	OFF	Terminal resistance (220Ω) insertion to RD (RXD): None
7	ON	Short-circuit of SDA (TXA) and RDA (RXA): Available
8	ON	Short-circuit of SDB (TXB) and RDB (RXB): Available
9	ON	RS (RTS) Auto control mode: Enabled
10	ON	

## 2 Selection of External Device

Select External Device to connect to the display.

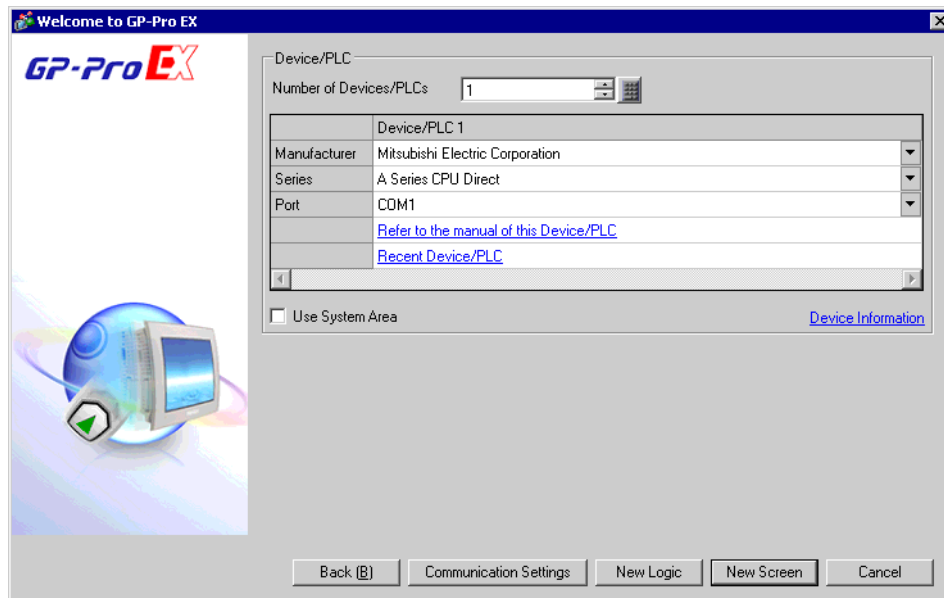

Setup Items	Setup Description
Number of Devices/PLCs	Enter an integer from 1 to 4 to define the number of Devices/PLCs to connect to the display.
Manufacturer	Select the manufacturer of the External Device to connect. Select "Mitsubishi Electric Corporation".
Series	Select the External Device model (series) and the connection method. Select "A Series CPU Direct". In System configuration, make sure the External Device you are connecting is supported by "A Series CPU Direct". ☞ "1 System Configuration" (page 3)
Port	Select the Display port to connect to the External Device.
Use System Area	Check this option to synchronize the system data area of the Display and the device (memory) of the External Device. When synchronized, you can use the External Device's ladder program to switch the display or display the window on the Display. Cf. GP-Pro EX Reference Manual "LS Area (Direct Access Method Area)" This feature can also be set in GP-Pro EX or in the Display's offline mode. Cf. GP-Pro EX Reference Manual "System Settings [Display Unit] - [System Area] Settings Guide" Cf. Maintenance/Troubleshooting Guide "Main Unit - System Area Settings"



### 3 Example of Communication Setting

Examples of communication settings of the Display and the External Device, recommended by Pro-face, are shown.

#### 3.1 Setting Example 1

##### ■ Settings of GP-Pro EX

##### ◆ Communication Settings

To display the setup screen, from the [Project] menu, point to [System Settings] and select [Device/PLC].

Device/PLC 1

Summary [Change Device/PLC](#)

Manufacturer: Mitsubishi Electric Corporation Series: A Series CPU Direct Port: COM1

Text Data Mode: 2 [Change](#)

Communication Settings

SI0 Type:  RS232C  RS422/485(2wire)  RS422/485(4wire)

Speed: 9600

Data Length:  7  8

Parity:  NONE  EVEN  ODD

Stop Bit:  1  2

Flow Control:  NONE  ER(DTR/DSR)  XON/XOFF

Timeout: 3 (sec)

Retry: 2

Wait To Send: 0 (ms)

Adapter: Direct

RI / VCC:  RI  VCC

In the case of RS232C, you can select the 9th pin to RI (Input) or VCC (5V Power Supply). If you use the Digital's RS232C Isolation Unit or CPU I/F Cable for Mitsubishi PLC A Series (Digital's:GP430-IP10-0), please select it to VCC.

Default

Device-Specific Settings

Allowable Number of Devices/PLCs: 1 [Add Device](#)

No.	Device Name	Settings	<a href="#">Add Indirect Device</a>
1	PLC1	Series=AnA Series	<a href="#">+</a>

##### ◆ Device Setting

To display the [Individual Device Settings] dialog box, from [Device-Specific Settings] in the [Device/PLC] window, select the external device and click [Settings] .

Individual Device Settings

PLC1

Series:  AnA Series  AnN Series

The range of the address is different according to the series.  
Please reconfirm all of address settings that you are using if you have changed the series.

Default

OK Cancel

- NOTE**
- Set Series according to your External Device.
  - Set [AnA Series] when you use Q Series A Mode.

##### ■ Settings of External Device

There is no setting on the External Device.

## 3.2 Setting Example 2

### ■ Settings of GP-Pro EX

#### ◆ Communication Settings

To display the setup screen, from the [Project] menu, point to [System Settings] and select [Device/PLC].

Device/PLC 1

Summary [Change Device/PLC](#)

Manufacturer  Series  Port

Text Data Mode  [Change](#)

Communication Settings

SI0 Type  RS232C  RS422/485(2wire)  RS422/485(4wire)

Speed

Data Length  7  8

Parity  NONE  EVEN  ODD

Stop Bit  1  2

Flow Control  NONE  ER(DTR/CTS)  XON/XOFF

Timeout  (sec)

Retry

Wait To Send  (ms)

Adapter

RI / VCC  RI  VCC

In the case of RS232C, you can select the 9th pin to RI (Input) or VCC (5V Power Supply). If you use the Digital's RS232C Isolation Unit or CPU I/F Cable for Mitsubishi PLC A Series (Digital:GP430-IP10-0), please select it to VCC.

[Default](#)

Device-Specific Settings

Allowable Number of Devices/PLCs  [Add Device](#)

No.	Device Name	Settings	<a href="#">Add Indirect Device</a>
1	<input type="text" value="PLC1"/>	<input type="text" value="Series=AnA Series"/>	<a href="#">+</a>

#### ◆ Device Setting

To display the [Individual Device Settings] dialog box, from [Device-Specific Settings] in the [Device/PLC] window, select the external device and click [Settings]  .

Individual Device Settings

PLC1

Series  AnA Series  AnN Series

The range of the address is different according to the series.  
Please reconfirm all of address settings that you are using  
if you have changed the series.

[Default](#)

[OK \(O\)](#) [Cancel](#)

**NOTE** • Set Series according to your External Device.

### ■ Settings of External Device

There is no setting on the External Device.

### 3.3 Setting Example 3

#### ■ Settings of GP-Pro EX

##### ◆ Communication Settings

To display the setup screen, from the [Project] menu, point to [System Settings] and select [Device/PLC].

##### ◆ Device Setting

To display the [Individual Device Settings] dialog box, from [Device-Specific Settings] in the [Device/PLC] window, select the external device and click [Settings] .

**NOTE** • Set Series according to your External Device.

#### ■ Settings of External Device

There is no setting on the External Device.

## 4 Setup Items

Set communication settings of the Display with GP-Pro EX or in offline mode of the Display.

The setting of each parameter must be identical to that of External Device.

☞ "3 Example of Communication Setting" (page 9)

### 4.1 Setup Items in GP-Pro EX

#### ■ Communication Settings

To display the setup screen, from the [Project] menu, point to [System Settings] and select [Device/PLC].

Device/PLC 1

Summary [Change Device/PLC](#)

Manufacturer  Series  Port

Text Data Mode  [Change](#)

Communication Settings

SIO Type  RS232C  RS422/485(2wire)  RS422/485(4wire)

Speed

Data Length  7  8

Parity  NONE  EVEN  ODD

Stop Bit  1  2

Flow Control  NONE  ER(DTR/CTS)  XON/XOFF

Timeout  (sec)

Retry

Wait To Send  (ms)

Adapter

RI / VCC  RI  VCC

In the case of RS232C, you can select the 9th pin to RI (Input) or VCC (5V Power Supply). If you use the Digital's RS232C Isolation Unit or CPU I/F Cable for Mitsubishi PLC A Series (Digital:GP430-IP10-0), please select it to VCC.

Device-Specific Settings

Allowable Number of Devices/PLCs  [Add Device](#)

No.	Device Name	Settings	Add Indirect Device
<input type="button" value="1"/>	<input type="text" value="PLC1"/>	<input type="text" value="Series=AnA Series"/>	<input type="button" value="+"/>

Setup Items	Setup Description
SIO Type	Select the SIO type to communicate with the External Device.
Speed	Select speed between the External Device and the Display.
Data Length	Select data length.
Parity	Select how to check parity.
Stop Bit	Select stop bit length.
Flow Control	Select the communication control method to prevent overflow of transmission and reception data.
Timeout	Use an integer from 1 to 127 to enter the time (s) for which the Display waits for the response from the External Device.
Retry	In case of no response from the External Device, use an integer from 0 to 255 to enter how many times the Display retransmits the command.

continued to next page

Setup Items	Setup Description
Wait To Send	Use an integer from 0 to 255 to enter standby time (ms) for the Display from receiving packets to transmitting next commands.
Adapter	When using adapter, select either "Direct" or "2 Port". When using 2-port adapter II, select "2 Port".
RI/VCC	You can switch RI/VCC of the 9th pin when you select RS232C for SIO type. It is necessary to change RI/5V by changeover switch of IPC when connect with IPC. Please refer to the manual of the IPC for more detail.

**NOTE** • Refer to the GP-Pro EX Reference Manual for Indirect Device.

Cf. GP-Pro EX Reference Manual "Changing the Device/PLC at Runtime (Indirect Device)"

## ■ Device Setting

To display the [Individual Device Settings] dialog box, from [Device-Specific Settings] in the [Device/PLC] window, select the external device and click [Settings] .

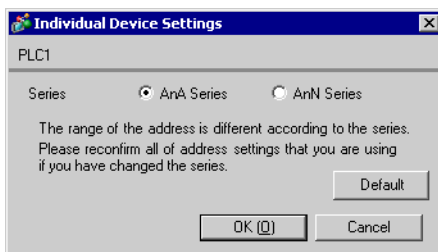

Setup Items	Setup Description
Series	Select either "AnA Series" or "AnN Series" for the driver series name. Set "AnA Series" when you use Q Series A Mode.

## 4.2 Setup Items in Offline Mode

- NOTE** • Refer to the Maintenance/Troubleshooting guide for information on how to enter offline mode or about the operation.

Cf. Maintenance/Troubleshooting Guide "Offline Mode"

- The number of the setup items to be displayed for 1 page in the offline mode depends on the Display in use. Please refer to the Reference manual for details.

### ■ Communication Settings

To display the setting screen, touch [Device/PLC Settings] from [Peripheral Settings] in offline mode. Touch the External Device you want to set from the displayed list.

(Page 1/2)

Comm.	Device			
A Series CPU Direct		[COM1]	Page 1/2	
SIO Type	RS232C			
Speed	9600			
Data Length	8			
Parity	ODD			
Stop Bit	1			
Flow Control	NONE			
Timeout(s)	3			
Retry	2			
Wait To Send(ms)	0			
Adapter	2 Port			
				➔
Exit		Back		2005/09/02 12:25:52

Setup Items	Setup Description
SIO Type	Select the SIO type to communicate with the External Device. <b>IMPORTANT</b> To make the communication settings correctly, confirm the serial interface specifications of Display unit for [SIO Type]. We cannot guarantee the operation if a communication type that the serial interface does not support is specified. For details concerning the serial interface specifications, refer to the manual for Display unit.
Speed	Speed between the External Device and the Display is shown.
Data Length	Data length is displayed.
Parity	The parity check method is displayed.
Stop Bit	Stop bit length is displayed.
Flow Control	The communication control method to prevent overflow of transmission and reception data is displayed.

Setup Items	Setup Description
Timeout	Use an integer from 1 to 127 to enter the time (s) for which the Display waits for the response from the External Device.
Retry	In case of no response from the External Device, use an integer from 0 to 255 to enter how many times the Display retransmits the command.
Wait To Send	Use an integer from 0 to 255 to enter standby time (ms) for the Display from receiving packets to transmitting next commands.
Adapter	When using adapter, select either "Direct" or "2 Port". When using 2-port adapter II, select "2 Port".

(Page 2/2)

Comm.	Device			
A Series CPU Direct			[COM1]	Page 2/2
RI / VCC <input checked="" type="radio"/> RI <input type="radio"/> VCC In the case of RS232C, if you use the Digital's RS232C Isolation Unit or CPU I/F Cable for Mitsubishi PLC A Series (Digital's:GP430-IP10-0), please select it to VCC.				
				←
Exit		Back		2005/09/02 12:25:54

Setup Items	Setup Description
RI/VCC	You can switch RI/VCC of the 9th pin when you select RS232C for SIO type. It is necessary to change RI/5V by changeover switch of IPC when connect with IPC. Please refer to the manual of the IPC for more detail.

**NOTE**

- GP-4100 series, GP-4\*01TM and GP-Rear Module do not have the [Option] setting in the offline mode.

## ■ Device Setting

To display the setting screen, touch [Device/PLC Settings] from [Peripheral Settings]. Touch the External Device you want to set from the displayed list, and touch [Device].

Comm.	Device			
A Series CPU Direct		[COM1]	Page 1/1	
Device/PLC Name		[PLC1] ▼		
Series		AnA Series		
Exit		Back		2005/09/02 12:25:56

Setup Items	Setup Description
Device/PLC Name	Select the External Device for device setting. Device name is a title of External Device set with GP-Pro EX.(Initial value [PLC1])
Series	The driver series name "AnA Series" or "AnN Series" is displayed. You cannot change Series in [Device Setting] in offline mode.



## 5 Cable Diagram

The cable diagram shown below may be different from the cable diagram recommended by Mitsubishi Electric Corporation. Please be assured there is no operational problem in applying the cable diagram shown in this manual.

- The FG pin of the main body of the External Device must be D-class grounded. Please refer to the manual of the External Device for more details.
- SG and FG are connected inside the Display. When connecting SG to the External Device, design the system not to form short-circuit loop.
- Connect the isolation unit, when communication is not stabilized under the influence of a noise etc..

Cable Diagram 1

Display (Connection Port)	Cable	Notes
GP3000 (COM1) GP4000* <sup>1</sup> (COM1) SP5000* <sup>2</sup> (COM1/2) SP-5B00 (COM1) ST3000 (COM1) ST6000 (COM1) STM6000 (COM1) LT3000 (COM1) IPC* <sup>3</sup> PC/AT	1A  Interface internal cable for Mitsubishi FA equipments by Diatrend Corp. DAFXIH-CABV (3m)	Available to order the length up to 15 m
GP-4105 (COM1) GP-4115T (COM1) GP-4115T3 (COM1)	1B  User-created cable + Interface internal cable for Mitsubishi FA equipments by Diatrend Corp. DAFXIH-CABV (3m)	Available to order the length up to 15 m

\*1 All GP4000 models except GP-4100 Series and GP-4203T

\*2 Except SP-5B00

\*3 Only the COM port which can communicate by RS-232C can be used.

☞ ■ IPC COM Port (page 5)

1A)

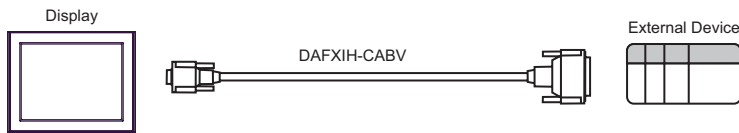

1B)

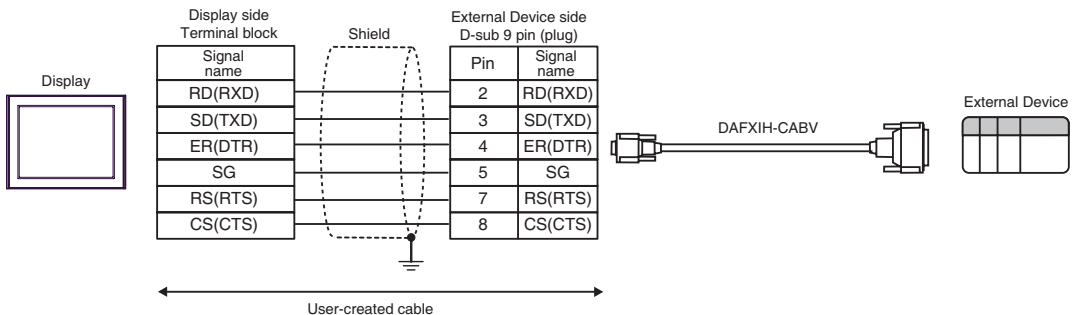

Cable Diagram 2

Display (Connection Port)	Cable		Notes
GP3000* <sup>1</sup> (COM1) AGP-3302B (COM2) GP4000* <sup>2</sup> (COM2) GP-4*01TM (COM1) GP-Rear Module (COM1) GP-4201T (COM1) SP5000* <sup>3</sup> (COM1/2) SP-5B00 (COM2) ST3000* <sup>4</sup> (COM2) ST6000* <sup>5</sup> (COM2) ST-6200 (COM1) STM6000 (COM1) LT3000 (COM1) IPC* <sup>6</sup>	2A	Mitsubishi A connection cable by Pro-face CA3-CBLA-01 (5m)	
	2B	User-created cable	The cable length must be 500m or less.
GP-4106 (COM1) GP-4116T (COM1)	2C	Mitsubishi PLC A Series Cable by Pro-face ZC9CBA51(5m)	
	2D	User-created cable	The cable length must be 500m or less.

- \*1 All GP3000 models except AGP-3302B
- \*2 All GP4000 models except GP-4100 series, GP-4\*01TM, GP-Rear Module, GP-4201T and GP-4\*03T
- \*3 Except SP-5B00
- \*4 Except AST-3211A and AST-3302B
- \*5 Except ST-6200
- \*6 Only the COM port which can communicate by RS-422/485 (4 wire) can be used. (Except PE-4000B, and PS6000)  
When using PS5000 series, PFXZPBMPR42P2 is required. Use a user-created cable for connection. You cannot use CA-3-CBLA-01.  
 ■ IPC COM Port (page 5)

2A)

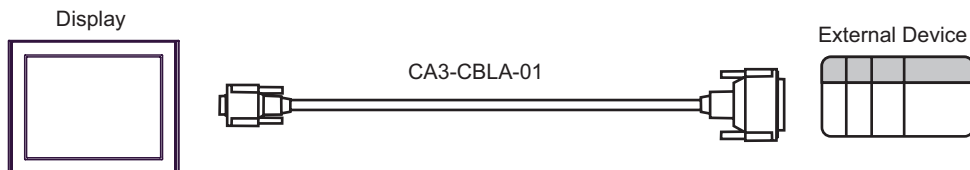

2B)

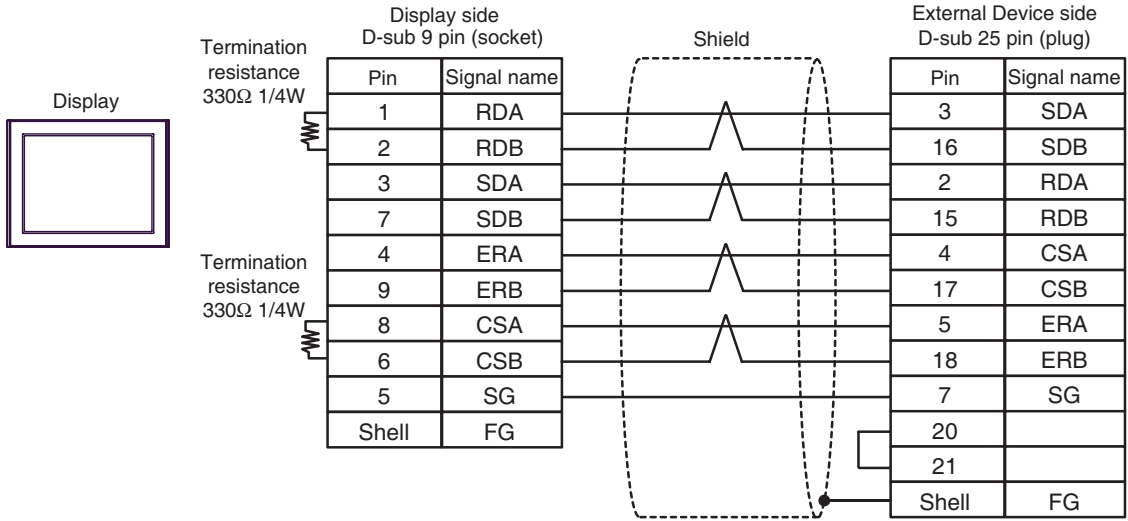

**NOTE** • When using PFXZPBMPR42P2 to connect with PS5000 series, replace signals as follows.

Cable diagram pin number, signal name	PFXZPBMPR42P2 pin number, signal name
1.RDA	3.RxD+
2.RDB	4.RxD-
3.SDA	2.TxD+
7.SDB	1.TxD-
5.SG	5.GND
4.ERA	7.RTS+
9.ERB	6.RTS-
8.CSA	8.CTS+
6.CSB	9.CTS-

2C)

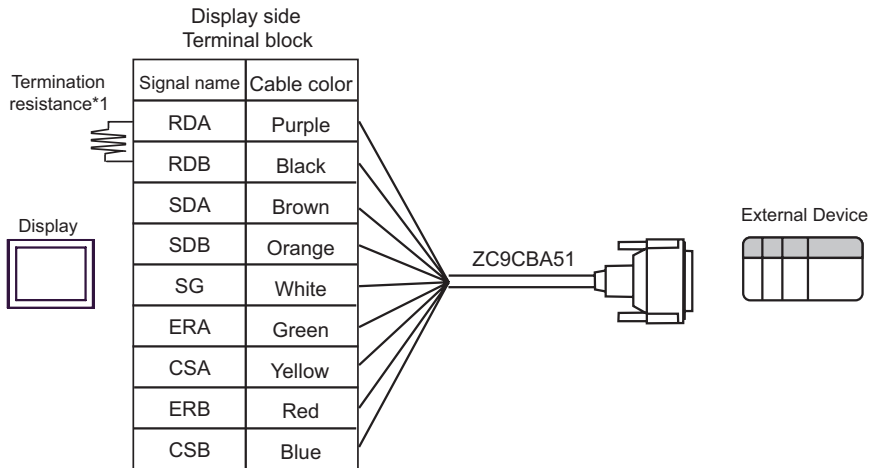

\*1 The resistance in the Display is used as the termination resistance. Set the value of the DIP Switch on the rear of the Display as shown in the table below.

DIP Switch No.	Set Value
1	OFF
2	OFF
3	ON
4	OFF

2D)

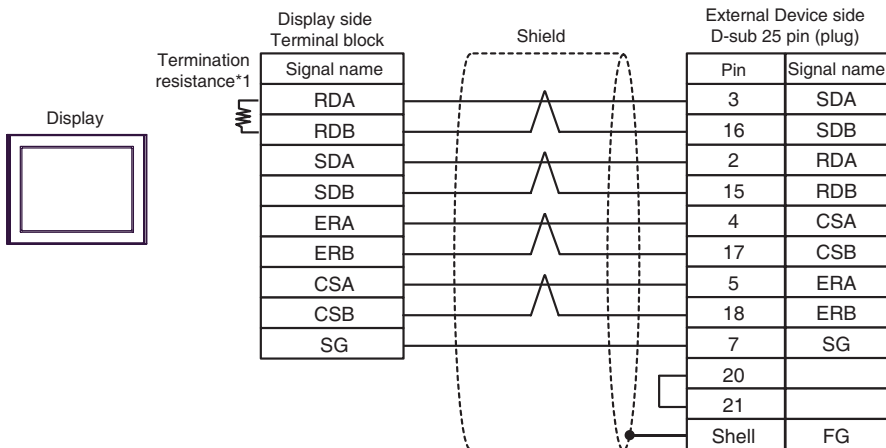

\*1 The resistance in the Display is used as the termination resistance. Set the value of the DIP Switch on the rear of the Display as shown in the table below.

DIP Switch No.	Set Value
1	OFF
2	OFF
3	ON
4	OFF

Cable Diagram 3

Display (Connection Port)	Cable		Notes
GP3000* <sup>1</sup> (COM1) AGP-3302B (COM2) GP-4*01TM (COM1) GP-Rear Module (COM1) ST3000* <sup>2</sup> (COM2) LT3000 (COM1) IPC* <sup>3</sup>	3A	COM port conversion adapter by Pro-face CA3-ADPCOM-01 + 2-port adapter cable for AGP by Pro-face CA3-MDCB11 (5m) + 2-port adapter II by Pro-face GP070-MD11	
	3B	User-created cable + 2-port adapter II by Pro-face GP070-MD11	The cable length must be 600m or less.
GP3000* <sup>4</sup> (COM2)	3C	Online adapter by Pro-face CA4-ADPONL-01 + 2-port adapter cable for AGP by Pro-face CA3-MDCB11 (5m) + 2-port adapter II by Pro-face GP070-MD11	
	3D	Online adapter by Pro-face CA4-ADPONL-01 + User-created cable + 2-port adapter II by Pro-face GP070-MD11	The cable length must be 600m or less.
GP-4106 (COM1) GP-4116T (COM1)	3E	User-created cable + 2-port adapter II by Pro-face GP070-MD11	The cable length must be 600m or less.
GP4000* <sup>5</sup> (COM2) GP-4201T (COM1) SP5000* <sup>6</sup> (COM1/2) SP-5B00 (COM2) ST6000* <sup>7</sup> (COM2) ST-6200 (COM1) STM6000 (COM1)	3F	2-port adapter cable by Pro-face PFXZCBCBMD1* <sup>8</sup> + 2-port adapter II by Pro-face GP070-MD11	
	3B	User-created cable + 2-port adapter II by Pro-face GP070-MD11	The cable length must be 600m or less.
PE-4000B* <sup>9</sup> PS5000* <sup>9</sup> PS6000* <sup>9</sup>	3G	User-created cable + 2-port adapter II by Pro-face GP070-MD11	The cable length must be 600m or less.

\*1 All GP3000 models except AGP-3302B

\*2 Except AST-3211A and AST-3302B

- \*3 Only the COM port which can communicate by RS-422/485 (4 wire) can be used. (Except PE-4000B, PS5000, and PS6000)  
☞ ■ IPC COM Port (page 5)
- \*4 All GP3000 models except GP-3200 series and AGP-3302B
- \*5 All GP4000 models except GP-4100 series, GP-4\*01TM, GP-Rear Module, GP-4201T and GP-4\*03T
- \*6 Except SP-5B00
- \*7 Except ST-6200
- \*8 When using a 2-port Adapter Cable (CA3-MDCB11) instead of the 2-port Adapter Cable, refer to Cable Diagram 3A.
- \*9 Only the COM port which can communicate by RS-422/485 (4 wire) can be used.  
☞ ■ IPC COM Port (page 5)

3A)

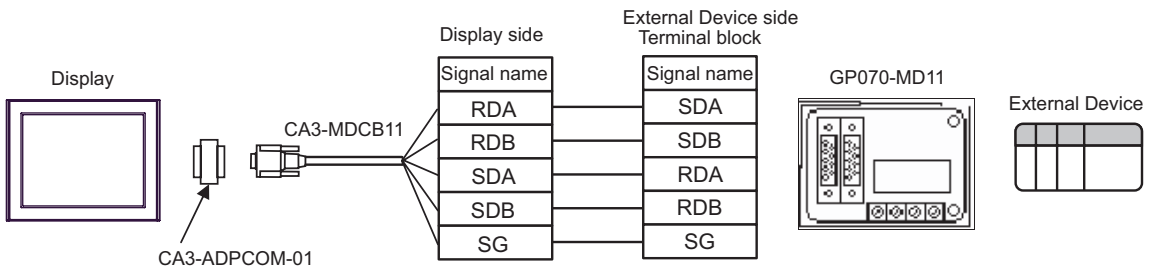

3B)

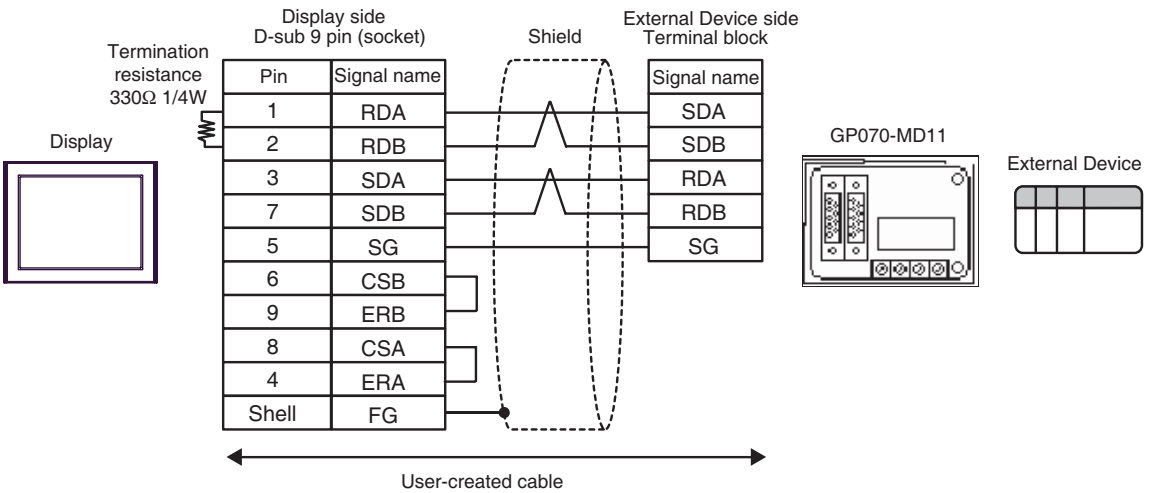

3C)

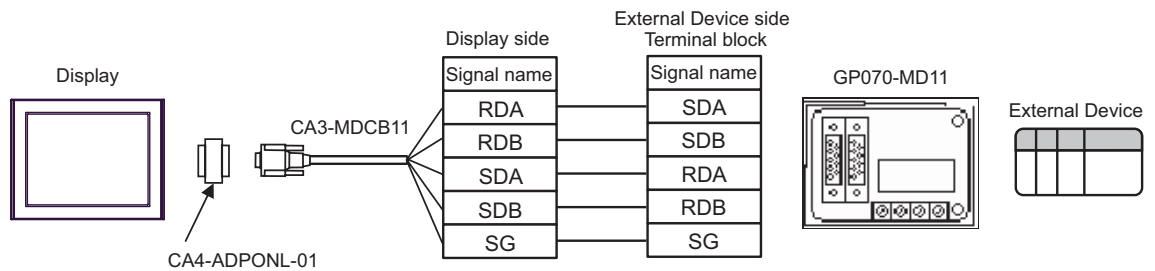

3D)

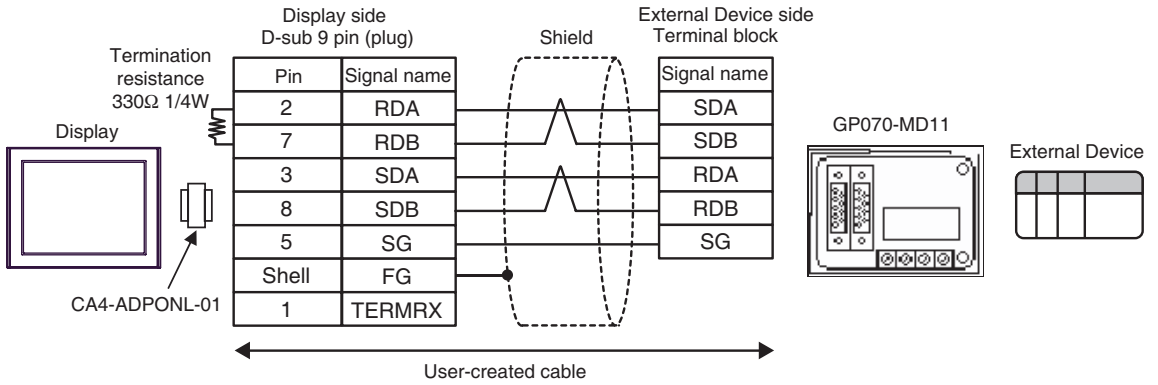

3E)

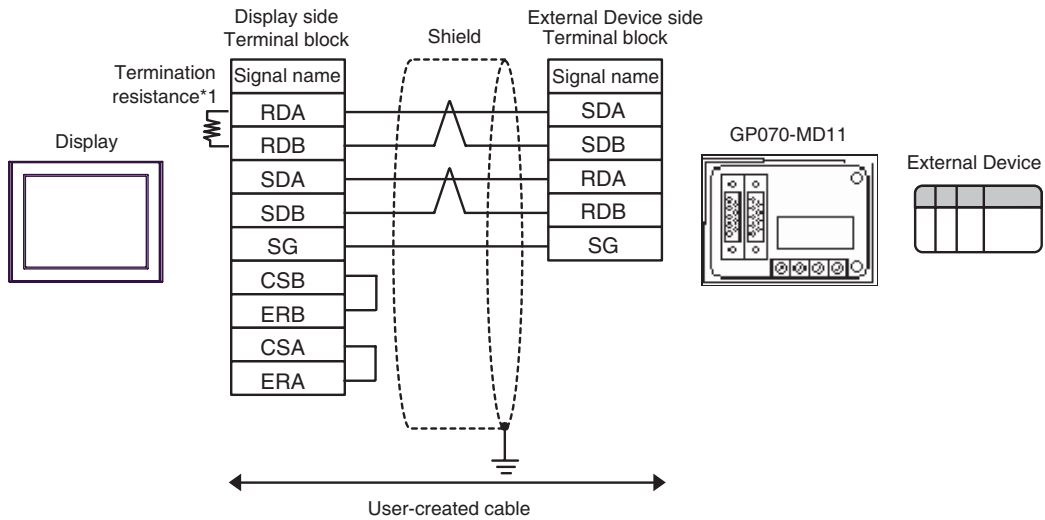

\*1 The resistance in the Display is used as the termination resistance. Set the value of the DIP Switch on the rear of the Display as shown in the table below.

DIP Switch No.	Set Value
1	OFF
2	OFF
3	ON
4	OFF

3F)

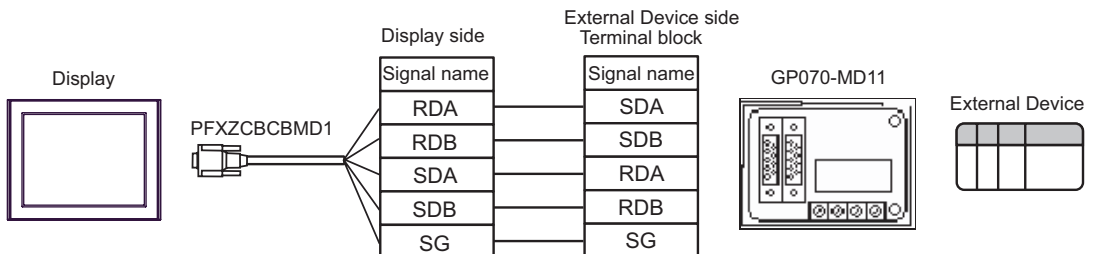

3G)

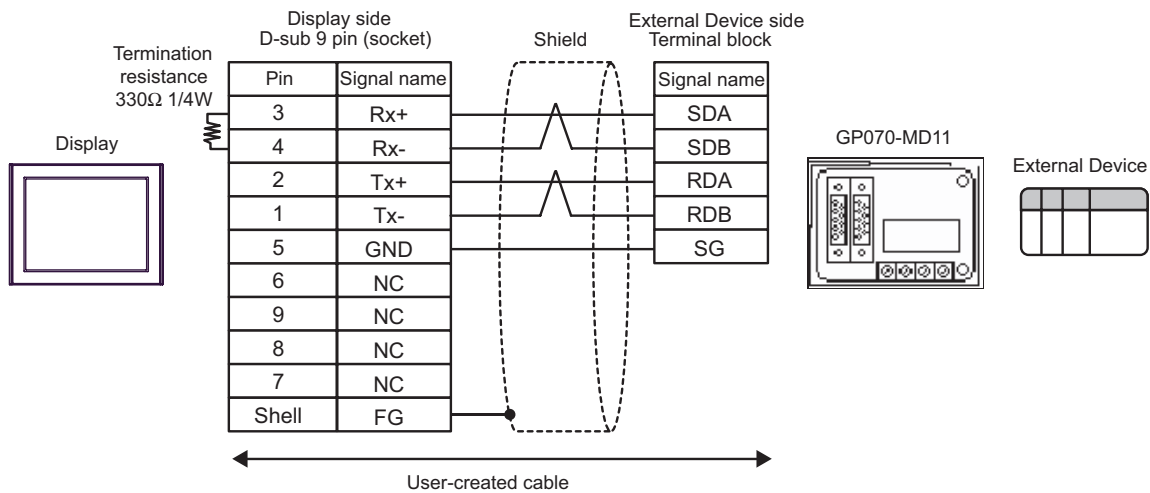



Cable Diagram 4

Display (Connection Port)	Cable		Notes
GP3000 (COM1) GP4000* <sup>1</sup> (COM1) SP5000* <sup>2</sup> (COM1/2) SP-5B00 (COM1) ST3000 (COM1) ST6000 (COM1) STM6000 (COM1) LT3000 (COM1) IPC* <sup>3</sup> PC/AT	4A	Mitsubishi Q connection cable by Pro-face CA3-CBLQ-01 (5m) or QC30R2 (3m) by Mitsubishi Electric Corp. or DQCABR2V-H (3m)* <sup>4</sup> by Diatrend Corp.	
GP-4105 (COM1) GP-4115T (COM1) GP-4115T3 (COM1)	4B	Mitsubishi PLC Q Series CPU I/F Cable by Pro-face ZC9CBQ31(3m)	

\*1 All GP4000 models except GP-4100 Series and GP-4203T

\*2 Except SP-5B00

\*3 Only the COM port which can communicate by RS-232C can be used.

☞ ■ IPC COM Port (page 5)

\*4 Specify the cable length with (\*m) Please contact Diatrend Corp. for available specified cable length.

4A)

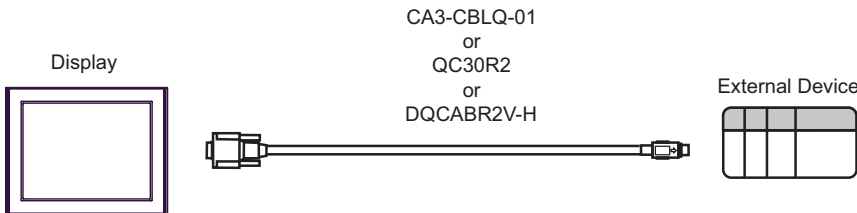

**IMPORTANT**

- We recommend that ferrite core should be attached to your cable for improving noise tolerance.
- Attach ferrite core to the closest position to the connector on both ends of the cable. Also, wind the cable around ferrite core (1 turn) to expect more noise tolerance as shown below.

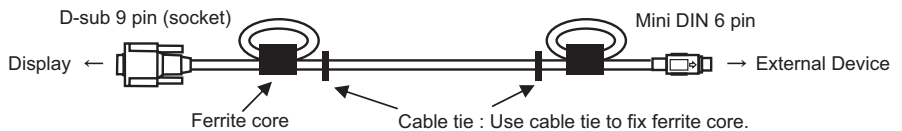

- The cable length must be 15 meters or less.

<Ferrite core recommended>

Maker: Seiwa Electric MFG. Co., Ltd.

Model: E04SR301334

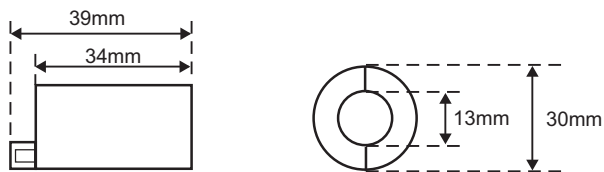

- You can use the ferrite core by other companies if it has same size as shown above.

4B)

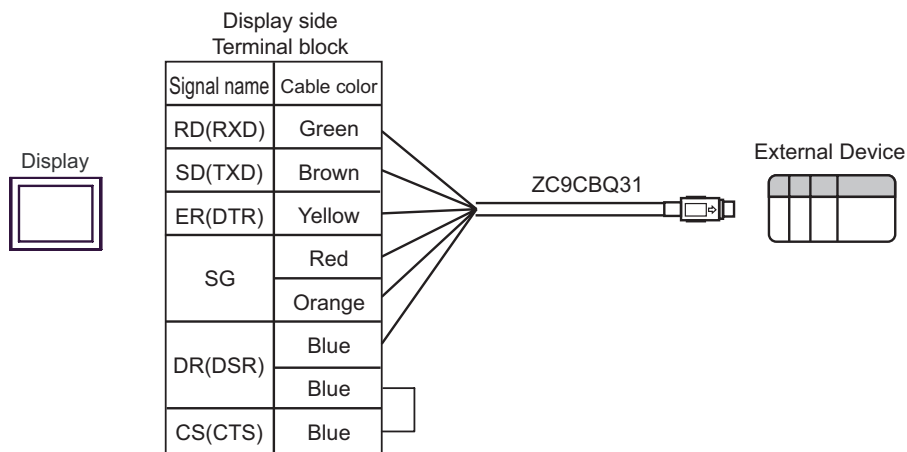











## 6 Supported Device

Range of supported device address is shown in the table below. Please note that the actually supported range of the devices varies depending on the External Device to be used. Please check the actual range in the manual of your External Device.

### 6.1 MELSEC AnA Series, Q Series A Mode

 This address can be specified as system data area.

Device	Bit Address	Word Address	32 bits	Notes
Input	X0000 - X1FFF	X0000 - X1FF0	<b>[L/H]</b>	
Output	Y0000 - Y1FFF	Y0000 - Y1FF0		
Internal Relay	M0000 - M8191	M0000 - M8176		
Latch Relay	L0000 - L8191	L0000 - L8176		
Special Relay	M9000 - M9255	M9000 - M9240		
Annunciator	F0000 - F2047	F0000 - F2032		
Link Relay	B0000 - B1FFF	-----		
Timer (Contact)	TS0000 - TS2047	-----		
Timer (Coil)	TC0000 - TC2047	-----		
Counter (Contact)	CS0000 - CS1023	-----		
Counter (Coil)	CC0000 - CC1023	-----		
Timer (Current Value)	-----	TN0000 - TN2047		
Counter (Current Value)	-----	CN0000 - CN1023		
Data Register	-----	 D0000 - D8191		
Special Register	-----	D9000 - D9255		
Link Register	-----	W0000 - W1FFF		
File Register	-----	R0000 - R8191	 *1	

\*1 When you use the file register in AnA, AnU, AnN and A3H, use the user memory area in the memory cassettes below.

·A3NMCA-0    ·A3NMCA-2    ·A3NMCA-4    ·A3NMCA-8    ·A3NMCA-16  
 ·A3NMCA-24    ·A3NMCA-40    ·A3NMCA-56    ·A4UMCA-8E

When you set the file register without using the memory cassette, error occurs during communication. Note that you may not use the file register when you set ROM to the ladder program.

**NOTE**











- Please refer to the GP-Pro EX Reference Manual for system data area.  
Cf. GP-Pro EX Reference Manual "LS Area (Direct Access Method Area)"
- Please refer to the precautions on manual notation for icons in the table.

 "Manual Symbols and Terminology"

---

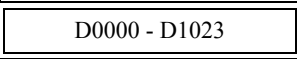
## 6.2 MELSEC AnN Series

 This address can be specified as system data area.

Device	Bit Address	Word Address	32 bits	Notes
Input	X0000 - X07FF	X0000 - X07F0		
Output	Y0000 - Y07FF	Y0000 - Y07F0		 *1
Internal Relay	M0000 - M2047	M0000 - M2032		
Latch Relay	L0000 - L2047	L0000 - L2032		
Special Relay	M9000 - M9255	M9000 - M9240		 *2
Annunciator	F000 - F255	F000 - F240		
Link Relay	B0000 - B03FF	-----		
Timer (Contact)	TS000 - TS255	-----		
Timer (Coil)	TC000 - TC255	-----		
Counter (Contact)	CS000 - CS255	-----		
Counter (Coil)	CC000 - CC255	-----		
Timer (Current Value)	-----	TN000 - TN255		
Counter (Current Value)	-----	CN000 - CN255		
Data Register	-----	 D0000 - D1023		
Link Register	-----	W0000 - W03FF		
File Register	-----	R0000 - R8191	 *3	

\*1 In case of using A2C, you cannot set the output relay Y01F0 - Y01FF (word: Y01F0) because they are used on the External Device.

\*2 You cannot combine AnN and AJ71C24-S3 for use.

\*3 When you use the file register in AnA, AnU, AnN and A3H, use the user memory area in the memory cassettes below.

·A3NMCA-0    ·A3NMCA-2    ·A3NMCA-4    ·A3NMCA-8    ·A3NMCA-16  
 ·A3NMCA-24    ·A3NMCA-40    ·A3NMCA-56    ·A4UMCA-8E

When you set the file register without using the memory cassette, error occurs during communication. Note that you may not use the file register when you set ROM to the ladder program.

**NOTE**

- Please refer to the GP-Pro EX Reference Manual for system data area.  
Cf. GP-Pro EX Reference Manual "LS Area (Direct Access Method Area)"
- Please refer to the precautions on manual notation for icons in the table.

 "Manual Symbols and Terminology"

## 7 Device Code and Address Code

Use device code and address code when you select "Device Type & Address" for the address type in data displays.

### 7.1 MELSEC AnA Series, Q Series A Mode

Device	Device Name	Device Code (HEX)	Address Code
Input	X	0080	Value of word address divided by 16
Output	Y	0081	Value of word address divided by 16
Internal Relay	M	0082	Value of word address divided by 16
Latch Relay	L	0084	Value of word address divided by 16
Special Relay	M	0083	Value of (word address - 9000) divided by 16
Annunciator	F	0085	Value of word address divided by 16
Timer (Current Value)	TN	0060	Word Address
Counter (Current Value)	CN	0061	Word Address
Data Register	D	0000	Word Address
Special Register	D	0001	Value of word address from which 9000 is deducted
Link Register	W	0002	Word Address
File Register	R	000F	Word Address

## 7.2 MELSEC AnN Series

Device	Device Name	Device Code (HEX)	Address Code
Input	X	0080	Value of word address divided by 16
Output	Y	0081	Value of word address divided by 16
Internal Relay	M	0082	Value of word address divided by 16
Latch Relay	L	0084	Value of word address divided by 16
Special Relay	M	0083	Value of (word address - 9000) divided by 16
Annunciator	F	0085	Value of word address divided by 16
Timer (Current Value)	TN	0060	Word Address
Counter (Current Value)	CN	0061	Word Address
Data Register	D	0000	Word Address
Link Register	W	0002	Word Address
File Register	R	000F	Word Address

## 8 Error Messages

Error messages are displayed on the Display screen as follows: "No.: Device Name: Error Message (Error Occurrence Area)". Each description is shown below.

Item	Description
No.	Error No.
Device Name	Name of the External Device where error occurs. Device name is a title of the External Device set with GP-Pro EX. (Initial value [PLC1])
Error Message	Displays messages related to the error which occurs.
Error Occurrence Area	<p>Displays IP address or device address of the External Device where error occurs, or error codes received from the External Device.</p> <p><b>NOTE</b></p> <ul style="list-style-type: none"> <li>• IP address is displayed such as "IP address(Decimal): MAC address( Hex)".</li> <li>• Device address is displayed such as "Address: Device address".</li> <li>• Received error codes are displayed such as "Decimal[Hex]".</li> </ul>

Display Examples of Error Messages

"RHAA035: PLC1: Error has been responded for device write command (Error Code: 2 [02H])"

**NOTE**

- Refer to your External Device manual for details on received error codes.
- Refer to "Display-related errors" in "Maintenance/Troubleshooting Guide" for details on the error messages common to the driver.