

Pro-face®

ST Series

User Manual

Preface

Thank you for purchasing the Pro-face ST Series programmable operator interface (hereafter referred to as the "ST unit"). ST Series units are small-sized, low-cost operator interfaces equipped with high-resolution 3.8 inch QVGA displays.

Now, a compact, full-graphic display is available for you.

Please read this manual carefully as it explains, step by step, how to use the ST correctly and safely.

Also, in this manual's examples, the Mitsubishi MELSEC-AnA Series PLC is referred to, whenever possible, in a point-to-point connection.

Note

1. It is forbidden to copy the contents of this manual, in whole or in part, except for the user's personal use, without the express permission of Digital Electronics Corporation of Japan.
2. The information provided in this manual is subject to change without notice.
3. This manual has been written with care and attention to detail; however, should you find any errors or omissions, please contact Digital Electronics Corporation and inform them of your findings.
4. Please be aware that Digital Electronics Corporation shall not be held liable by the user for any damages, losses, or third party claims arising from any uses of this product.

© Copyright 2005 Digital Electronics Corporation. All rights reserved.

All Company/Manufacturer names used in this manual are the registered trademarks of those companies.

Essential Safety Precautions

This manual includes procedures that must be followed to operate the ST correctly and safely. Be sure to read this manual and any related materials thoroughly to understand the correct operation and functions of this unit.

Safety Icons

Throughout this manual the following icons are provided next to ST operation procedures requiring special attention, and provide essential safety information. These icons indicate the following levels of danger:





warning: Indicates situations where severe bodily injury, death or major equipment damage can occur.

 WARNING	Indicates situations where severe bodily injury, death or major equipment damage can occur.
--	---

 CAUTION	Indicates situations where slight bodily injury or machine damage can occur.
--	--

System Design

WARNING

-  Do not create ST touch panel switches that could possibly endanger the safety of equipment and personnel. Damage to the ST, its I/O unit(s), cable(s), and other related equipment can cause an output signal to remain continuously ON or OFF and possibly cause a major accident. Therefore, design all monitoring circuits using limit switches, etc. to detect incorrect device movement. To prevent accidents related to incorrect signal output or operation, design all switches used to control vital machine operations so they are operated via a separate control system.
-  Please design your system so that equipment will not malfunction due to a communication fault between the ST and its host controller. This is to prevent any possibility of bodily injury or material damage.
-  Do not use the ST unit as a warning device for critical alarms that can cause serious operator injury, machine damage or production stoppage. Critical alarm indicators and their control/activator units must be designed using stand-alone hardware and/or mechanical interlocks.
-  The ST is not appropriate for use with aircraft control devices, aerospace equipment, central trunk data transmission (communication) devices, nuclear power control devices, or medical life support equipment, due to these devices' inherent requirements of extremely high levels of safety and reliability.
-  Do not create switches used to control machine safety operations, such as an emergency stop switch, or a ST touch screen icon. Be sure to install these switches as separate hardware switches, otherwise severe bodily injury or equipment damage can occur.

- ❗ When using the ST with : transportation vehicles (trains, cars and ships), disaster and crime prevention devices, various types of safety equipment, non-life support related medical devices, etc., redundant and/or failsafe system designs should be used to ensure the proper degree of reliability and safety.

Touch Panel

WARNING

- ❗ After the ST's backlight burns out, unlike the ST's "Standby Mode", the touch panel is still active. If the operator fails to notice that the backlight is burned out and touches the panel, a potentially dangerous machine operation error can occur.

If your ST's backlight suddenly turns OFF, use the following steps to determine if the backlight is actually burned out.

- 1) If your ST is not set to "Standby Mode" and the screen has gone blank, your backlight is burned out.
- 2) Or, if your ST is set to Standby Mode, but touching the screen does not cause the display to reappear, your backlight is burned out.

Wiring

WARNING

- ⊘ To prevent electrical shock or equipment damage, unplug the ST unit's power cord from the power supply prior to installing or wiring the ST.
- ⊘ Be sure to replace the ST's plastic terminal block cover after wiring is completed, since operating the ST without the cover may lead to an electric shock.
- ⊘ Do not use power beyond the ST's specified voltage range. Doing so may cause a fire or an electric shock.

Battery Replacement

WARNING

- ⊘ The ST uses a lithium battery for backing up its internal clock data. If the battery is incorrectly replaced, the battery may explode. To prevent this, please do not replace the battery yourself. When the battery needs to be replaced, please contact your local ST distributor.

Installation/Maintenance

WARNING

- ⊘ High voltage runs through the ST. Except for replacing the backlight, never take apart the ST, otherwise an electrical shock can occur.
- ⊘ Do not modify the ST unit. Doing so may cause a fire or an electric shock.
- ⊘ Do not use the ST in an environment where flammable gasses are present, since operating the ST may cause an explosion.

Installation/Maintenance

CAUTION

- ⊘ Be sure to securely connect all cable connectors to the ST. A loose connection may cause incorrect input or output.

Wiring

CAUTION

- ⊘ Ground the ST's FG line separately from other units' FG lines. Putting these FG lines too close may cause an electric shock or unit malfunction. Be sure to use a grounding resistance of 100W or less and a 2mm² or thicker wire, or your country's applicable standard.

- ⊘ Be sure the ST's rated voltage is within the designated range, and that the power terminal lines are correctly attached. If the voltage supplied differs from the rated voltage, or incorrect wiring or grounding is performed, it may cause a fire or unit malfunction.
- ⊘ Use only the designated torque to tighten the ST's terminal block screws. If these screws are not tightened firmly, it may cause a short-circuit, fire, or ST malfunction.
- ⊘ Be careful that metal filings and wiring debris do not fall inside the ST, since they can cause a fire, ST malfunction, or incorrect unit operation.

Display Device

CAUTION

- ⊘ The liquid crystal panel contains a powerful irritant and if for any reason the panel is damaged and this liquid contacts any part of your body, be sure to wash that area with running water for 15 minutes. If any of this liquid enters your eye, flush your eye for 15 minutes with running water and contact a physician.

Unit Disposal

CAUTION

- ⊘ When this unit is disposed of, it should be done so according to your country's regulations for similar types of industrial waste.



廢電池請回收 This mark is applicable only in Taiwan.

General Safety Precautions

About the Operation Environment

- Do not strike the touch panel with a hard or pointed object, or press on the touch panel with too much force, since it may damage the touch panel or the display.
- Do not install the ST where the ambient temperature can exceed the allowed range. Doing so may cause the ST to malfunction or shorten its operation life.
- Do not restrict or limit the ST's naturally occurring rear-face ventilation, or store or use the ST in an environment that is too hot.
- Do not use this unit in areas where large, sudden temperature changes can occur. These changes can cause condensation to form inside the unit., possibly causing the unit to malfunction.
- Do not allow water, liquids, metal or charged particles to enter inside the ST's case, since they can cause either a ST malfunction or an electrical shock.
- Do not use or store the ST in direct sunlight, or in excessively dusty or dirty environments.
- Do not store or use the unit where strong jolting or excessive vibration can occur.
- Do not store or use the ST where chemicals (such as organic solvents, etc.) and acids can evaporate, or where chemicals and acids are present in the air.

Corrosive chemicals:Acids, alkalines, liquids containing salt

Flammable chemicalsOrganic Solvents

- Do not use paint thinner or organic solvents to clean the ST, since they can cause either discoloration or a ST malfunction.
- Do not store or operate the LCD display in areas receiving direct sunlight, since the sun's UV rays may cause the LCD display quality to deteriorate.
- Storing this unit in areas at a temperature lower than is recommended in this manual specifications may cause the LCD display liquid to congeal, which may damage the panel. Conversely, if the storage area temperature becomes higher than the allowed level, the LCD liquid will become isotropic, causing irreversible damage to the LCD. Therefore, be sure to store the panel only in areas where temperatures are within those specified in this manual.
- Do not connect or disconnect the communication cable between the ST and the host during power-ups.

About the Screen Data

IMPORTANT

- Due to the possibility of unexpected accidents, be sure to back up the ST's screen data regularly.

About the ST's Display Panel

- The ST's currently displayed data, its voltage^{*1} and brightness setting each affect the intensity of Contouring. (i.e., when some parts of the screen are brighter than others, creating a wavelike pattern)
- There are minute grid-points (dark and light) on the Display Panel's surface. This is part of the ST's design and not a defect.
- Extended shadows, or "Crosstalk" may appear on the sides of screen images. This is normal for an LCD display.
- Sometimes the display area may look as if the display colors have changed. This is a common attribute of LCD's and is not a defect.
- Displaying a single image for long periods can cause an afterimage to remain when the display is changed to another screen.

To prevent this effect:

- Use the ST's "Stand-by Mode", which automatically turns the screen OFF when there is no input for a specified period of time.

SEE → 6.3.1 System Setup (Page 6-4)

- Write "FFFh" to the System Data Area's "Screen Display Off" address^{*2} to turn the screen display OFF when the following actions are not performed for the user's designated period of time.
 - Change Screen
 - Touch Screen
 - Alarm Display
- Do not display any single screen for a long period of time. Try to periodically change the screen display.

*1 If the ST's voltage is at the very low end of its allowable range, it may effect the intensity of contouring.

*2 The following addresses assume all System Data Area settings are entered. If they are not all entered, the correct word address may be different from those given here.

With the Direct Access Method use System Data Area word address +9

With the Memory Link Method use System Data Area word address +12

SEE → GP-PRO/PB III for Windows Device/PLC Connection Manual

ST Series Model Names

The ST Series refers to the following ST model numbers:

Series	Model Name	Model Type	Comments	GP Type in Screen Editor
ST Series	ST400	ST400-AG41-24V	UL/c-UL Approved, CE Marked	ST400
	ST401	ST401-AG41-24V		ST401
	ST402	ST402-AG41-24V		ST402
	ST403	ST403-AG41-24V		ST403

Package Contents

The ST's packing box contains the items listed below. Please check to confirm that all items shown below have been included.

ST Unit (1)

ST400-AG41-24V

ST401-AG41-24V

ST402-AG41-24V

ST403-AG41-24V

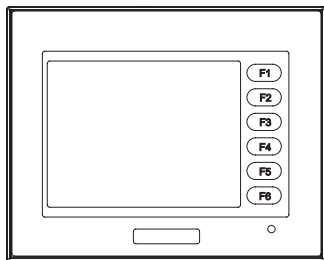

Installation Guide (1)

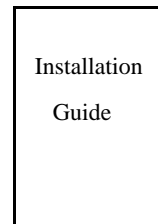

Installation Gasket (1)

<pre-installed>



Installation Fasteners (4/set)

(4/set)

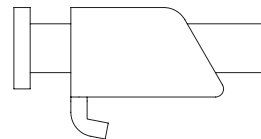

Power Plug (1) <pre-installed>

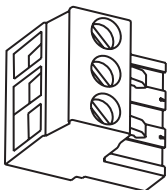

This unit has been carefully packed, with special attention to quality. However, should you find anything damaged or missing, please contact your local ST distributor immediately for prompt service.

UL/c-UL Application Notes

The ST400-AG41-24V/ST401-AG41-24V/ST402-AG41-24V/ST403-AG41-24V units are UL/c-UL listed product.
(UL File No.E220851)

ST400-AG41-24V (UL Registration Model: 3180053-02)

ST401-AG41-24V (UL Registration Model: 3180053-03)

ST402-AG41-24V (UL Registration Model: 3180053-04)

ST403-AG41-24V (UL Registration Model: 3383102-01)

The ST unit conform to the following standards.

- UL508 Industrial Control Equipment
- C22.2 No.142 (c-UL Approval) Process Control Equipment

Installation Precautions

- The ST unit must be used indoors only.
- The ST unit should be installed in the front face of a metal panel.
- If the ST unit is mounted so as to cool itself naturally, please mount it on a vertical panel. Also, ensure that the ST unit is mounted at least 100 mm away from any other adjacent structures or machine parts. If these conditions are not met, the heat generated by the ST unit internal components may cause it to fail to meet UL standards.
- The ST's FACE section is evaluated as an Enclosure, and all other areas are evaluated as an Open Enclosure.
- For use on a flat surface of a Type 4X (Indoor Use Only) and/or Type 12 Enclosure(UL50 (NEMA#250)).
- The ST's rear is not qualified as an Enclosure. Build the ST unit into an end-use product and make up an Enclosure which conforms with standards as the entire equipment.
- Be sure to supply power(DC24V) from a Class 2 circuit.

UL1604 for UL hazardous locations ends on July 31, 2012. As a result, for models produced from August 1, 2012 onward, UL1604 will not apply.

Please refer to the Pro-face home page for more details.

URL

<http://www.pro-face.com/worldwide/safety/ul.html>

CE Marking Notes

The ST400-AG41-24V, ST401-AG41-24V, ST402-AG41-24V and ST403-AG41-24V are CE marked products that conform to EMC directives.

For the detailed information on CE Marked, be downloaded and refer the Declaration of Conformity from Pro-face Home Page.

Home Page URL

<http://www.pro-face.com/>

Revision Information

Use the metallic label attached to the rear of the ST to identify your unit revision code. This code is at the bottom of the label, to the right of EV. In this example, the asterisk mark (*) is in the position, which means this unit revision code is "D".

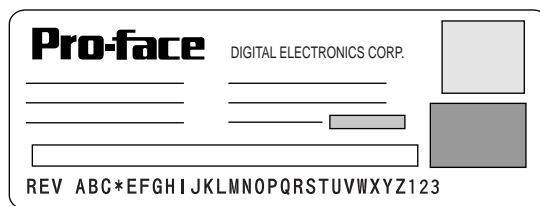

Documentation Conventions

The list below describes the documentation conventions used in this manual.

IMPORTANT	Indicates important information or procedures that must be followed for correct and risk-free software/device operation.
screen editor	Indicates the GP-PRO/PBIII for Windows screen editor software (version 6.30 or higher). For information on how to confirm the version, refer to the "GP-PRO/PB for Windows Operation Manual", which is supplied with the screen editor software.
PLC	Abbreviation for Programmable Logic Controller.
*	Indicates useful or important supplemental information.
(1), (2)	Indicates steps in a procedure. Be sure to perform these steps in the order given.
NOTE	Provides useful or important supplemental information.
SEE →	Refers to useful or important supplemental information.

Memo

CONTENTS

Preface.....	1
Note.....	1
Essential Safety Precautions	2
ST Series Model Names.....	8
Package Contents	8
UL/c-UL Application Notes.....	9
CE Marking Notes	10
Revision Information	10
Documentation Conventions.....	11

CHAPTER 1 Introduction

1.1 Prior to Operating the ST.....	1-2
1.2 System Design	1-3
1.2.1 ST Series System Design.....	1-3
1.3 Accessories	1-9

CHAPTER 2 Specifications

2.1 General Specifications	2-2
2.1.1 Electrical.....	2-2
2.1.2 Environmental.....	2-2
2.1.3 Structural.....	2-3
2.2 Functional Specifications.....	2-4
2.2.1 Display.....	2-4
2.2.2 Memory.....	2-5
2.2.3 Touch Panel and Clock	2-5
2.2.4 Touch Panel and Function keys	2-5
2.2.5 Interfaces.....	2-6
2.3 Interface Specifications.....	2-8
2.3.1 ST400-AG41-24V	2-8
2.3.2 ST401-AG41-24V	2-8
2.3.3 ST402-AG41-24V	2-9
2.3.4 ST403-AG41-24V	2-11
2.4 Part Names and Functions	2-12
2.5 Dimensions	2-13
2.5.1 ST Series External Dimensions	2-13
2.5.2 Panel Cut Dimensions.....	2-14
2.5.3 Installation Fasteners	2-14

CHAPTER 3 Installation and Wiring

3.1	Installation.....	3-2
3.1.1	Installation Procedures.....	3-2
3.2	Wiring Precautions.....	3-7
3.2.1	Connecting the Power Cord.....	3-7
3.2.2	Connecting the Power Supply.....	3-9
3.2.3	Grounding.....	3-10
3.2.4	I/O Signal Line Placement.....	3-11
3.3	Tool Connector.....	3-11
3.4	Ethernet Cable Connector.....	3-12

CHAPTER 4 Data Transfer

4.1	Serial Data Transfer.....	4-2
4.2	Ethernet Data Transfer.....	4-5

CHAPTER 5 OFFLINE Mode

5.1	Entering OFFLINE Mode.....	5-2
5.1.1	After Plugging in the Power Cord.....	5-2
5.1.2	From the Menu Bar.....	5-3
5.2	OFFLINE Mode Main Menu.....	5-4
5.3	Initialization.....	5-5
5.4	Self-Diagnosis.....	5-7

CHAPTER 6 Initializing the ST

6.1	Initialization Screen.....	6-2
6.2	Initialization Items.....	6-3
6.3	System Environment Setup.....	6-4
6.3.1	System Setup.....	6-4
6.3.2	System Area Setup.....	6-5
6.3.3	Global Window Setup.....	6-7
6.3.4	Character String Data Setup.....	6-8
6.4	Set Up I/O.....	6-11
6.4.1	SET UP SIO.....	6-11
6.4.2	Communication Setup.....	6-13
6.4.3	Set Up Touch Panel.....	6-13
6.4.4	Display Setup.....	6-16
6.4.5	Printer Setup.....	6-16
6.4.6	Expansion Serial Setup.....	6-17
6.4.7	Expansion Serial Environment Setup.....	6-18
6.4.8	COMMUNICATION PORT SETUP.....	6-18

6.5	PLC Setup	6-19
6.5.1	SET UP OPERATION SURROUNDINGS (1:1/n:1)	6-19
6.5.2	Station Setup (n:1)	6-20
6.5.3	Customize Setup (n:1)	6-22
6.5.4	Ethernet Setup	6-24
6.5.5	SYSLOG Setup	6-25
6.5.6	Others Setup	6-26
6.5.7	Self-Diagnosis	6-26
6.6	Initialize Internal Memory	6-27
6.6.1	Initialize ST Memory	6-27
6.7	Set Up Time	6-28
6.8	Set Up Screen	6-29
6.9	Font Setting	6-30

CHAPTER 7 RUN Mode and Errors

7.1	RUN Mode	7-2
7.1.1	After Connecting the Power Cord	7-2
7.1.2	Via OFFLINE Mode	7-3
7.2	Self-Diagnosis	7-4
7.2.1	Self-Diagnosis Item List	7-4
7.2.2	Self-Diagnosis - Details	7-5
7.3	Troubleshooting	7-8
7.3.1	Possible Types of Trouble	7-8
7.3.2	No Display	7-9
7.3.3	No ST/Host Communication	7-11
7.3.4	Touch Panel Does Not Respond	7-13
7.3.5	Buzzer Sounds when ST power is turned ON	7-14
7.3.6	Clock Settings Cannot be Entered	7-14
7.3.7	Error Screens	7-14
7.4	Error Messages	7-15
7.4.1	Error Message List	7-15
7.5	Error Message Details	7-17
7.5.1	System Errors	7-17
7.5.2	Illegal Address in Screen Data	7-19
7.5.3	PLC Com. Error	7-20
7.5.4	Clock Setup Error	7-21
7.5.5	Screen Tag Limit Exceeded (max. of 384)	7-22
7.5.6	OBJ. PLC Has Not Been Setup	7-22
7.5.7	D-Script and Global D-Script Errors	7-22
7.5.8	Extended SIO Script Error	7-23

CHAPTER 8 Maintenance

8.1 Regular Cleaning	8-2
8.1.1 Cleaning the Display	8-2
8.1.2 Installation Gasket Check/Replacement	8-2
8.2 Periodic Check Points	8-4
8.3 Changing the Backlight.....	8-4

Index

1



Introduction

- 1.1 Prior to Operating the ST
- 1.2 System Design
- 1.3 Accessories

1.1 Prior to Operating the ST

Be sure to follow these steps when creating projects for the ST unit.

(1) Preparation

Before using the GP, check that all required hardware is present and read all specification, wiring, and installation information.

SEE → *Specifications (Page 2-1) and Installation and Wiring (Page 3-1)*

(2) Select and the PLC types

Using the input areas provided, select the ST PLC types and the PLC types to be used.

SEE → *GP-PRO/PBIII for Windows Operation Manual and Tag Reference Manua*

(3) Create Screen/ Run Screen Setup

Setup the screen and tags in your screen editing software according to your Screen Design.

SEE → *GP-PRO/PBIII for Windows Operation Manual and Tag Reference Manual*

(4) Transfer Screen Data

Transfer the data from the Screen editor software on your PC to the ST unit using the Data Transfer Cable.

(5) GP/Host Connection

Set up the ST so that it can receive data from the Host (PLC).

SEE → *Initializing the ST (Page 6-1), and GP-PRO/ PBIII for Windows Device/PLC Connection Manual*

(6) Connect the ST

Link the ST with the host (PLC) using the appropriate connection cable (different cables may be necessary for different hosts), and then operate the unit.

SEE → *GP-PRO/PBIII for Windows Device/PLC Connection Manual*

1.2 System Design

1.2.1 ST Series System Design

The following diagram represents the standard items connected to the ST Series unit.

■ST RUN Mode Peripherals

◆ST400-AG41-24V

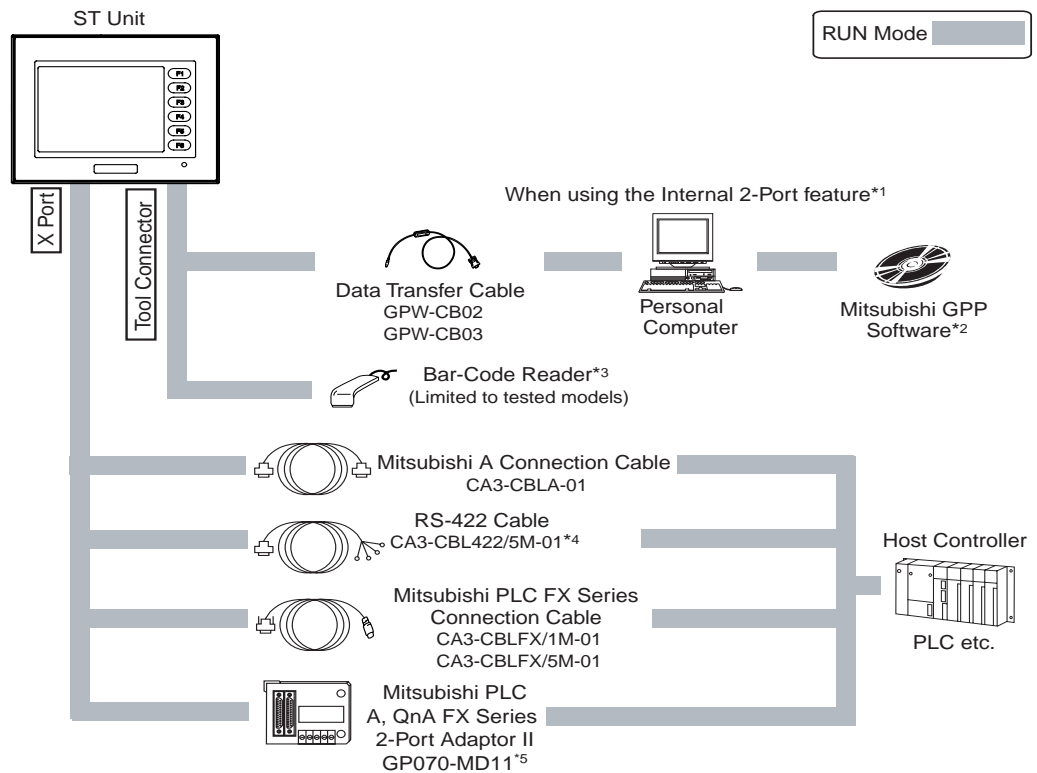

*1 This feature can only be used with Mitsubishi A, QnA and FX Series PLCs. For a list of compatible units,

SEE → *GP-PRO/PBIII for Windows Device/PLC Connection Manual (included with the screen editor software)*

*2 For a list of compatible software,

SEE → *GP-PRO/PBIII for Windows Device/PLC Connection Manual (included with the screen editor software)*

*3 For recommended units,

SEE → *Recommended Units (Page 1-8)*

*4 Certain types and models of PLCs cannot be connected.

SEE → *GP-PRO/PBIII for Windows Operation Manual (included with the screen editor software)*

*5 For details about connecting,

SEE → *GP-PRO/PBIII for Windows Device/PLC Connection Manual (included with the screen editor software)*

◆ST401-AG41-24V

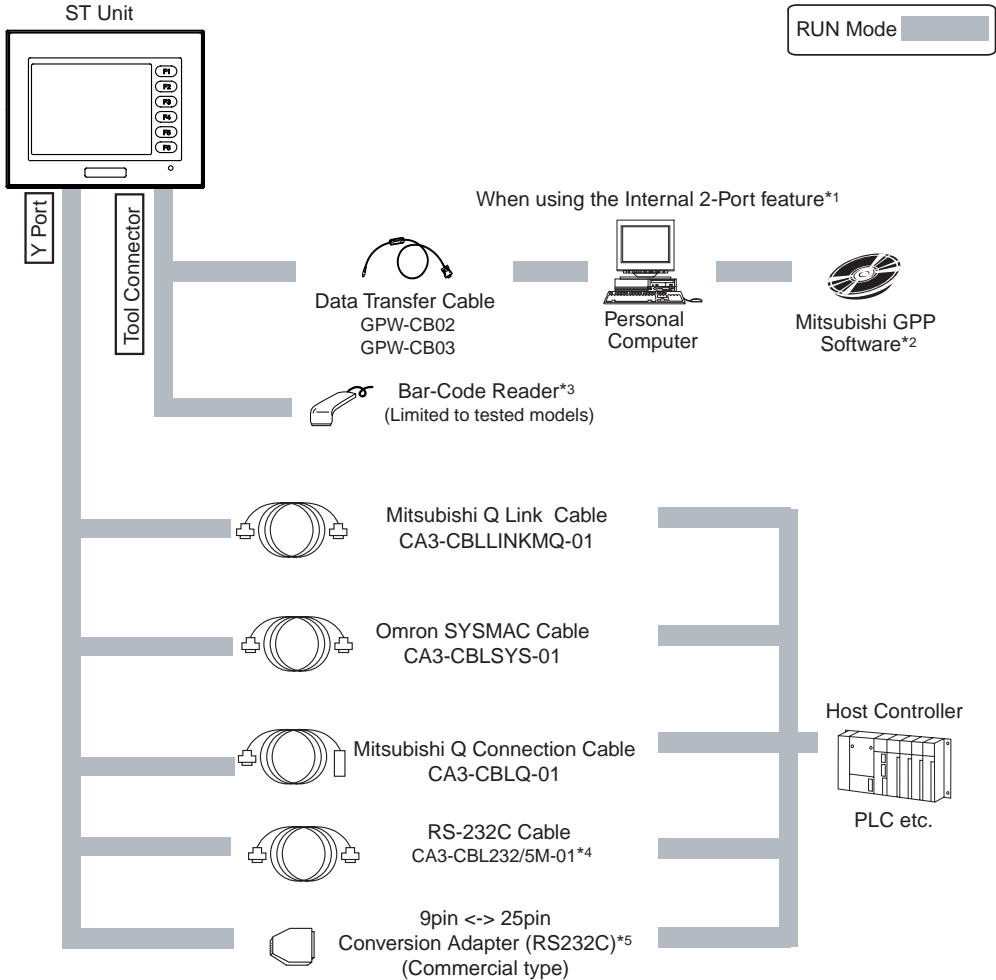

*1 This feature can only be used with Mitsubishi Q Series PLCs. For a list of compatible units,

SEE → *GP-PRO/PBIII for Windows Device/PLC Connection Manual (included with the screen editor software)*

*2 For a list of compatible software,

SEE → *GP-PRO/PBIII for Windows Device/PLC Connection Manual (included with the screen editor software)*

*3 For recommended units,

SEE → *Recommended Units (Page 1-8)*

*4 Certain types and models of PLCs cannot be connected.

SEE → *GP-PRO/PBIII for Windows Operation Manual (included with the screen editor software)*

*5 When the ST side of the cable uses a D-sub 25-pin connector, a 9pin <-> 25pin adaptor is required.

SEE → *GP-PRO/PBIII for Windows Device/PLC Connection Manual (included with the screen editor software)*

◆ST402-AG41-24V

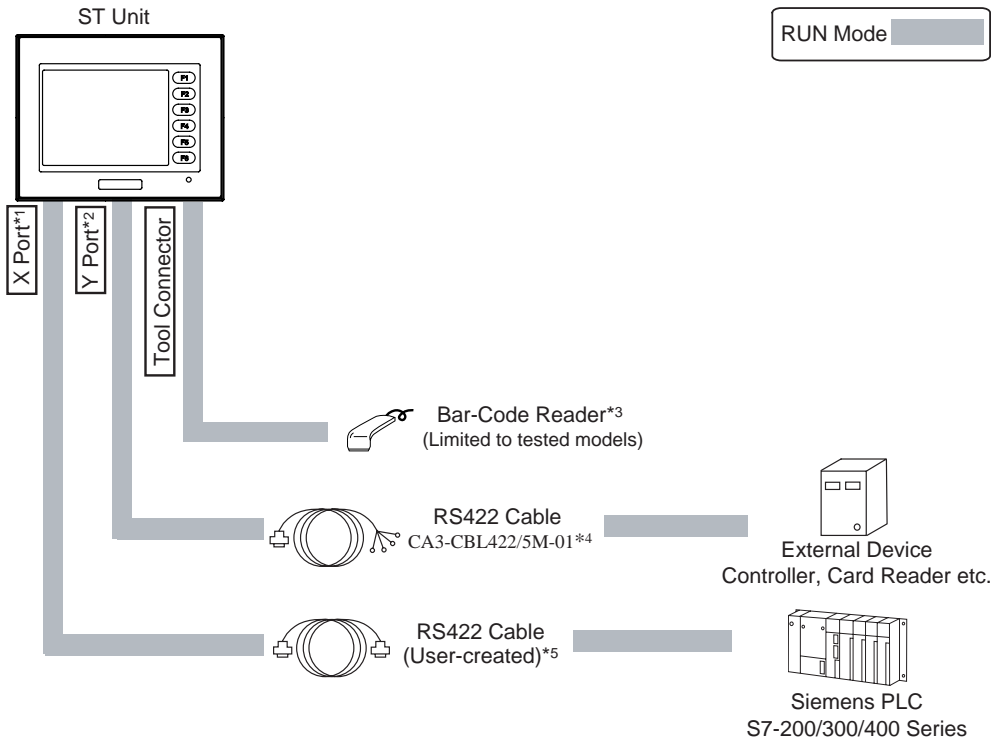

*1 This communication port is designed exclusively to be used for an MPI Direct Connection with Seimens Corporation S7-200/300/400 Series PLCs.

*2 This communication port is used exclusively for Extended SIO Scripts. To use this port, an Extended SIO Script is required.

SEE → *GP-PRO/PBIII for Windows Device/PLC Connection Manual (included with the screen editor software)*

*3 For recommended units,

SEE → *Recommended Units (Page 1-8)*

*4 Certain types and models of devices cannot be connected.

SEE → *GP-PRO/PBIII for Windows Operation Manual (included with the screen editor software)*

*5 For details about connecting,

SEE → *GP-PRO/PBIII for Windows Device/PLC Connection Manual (included with the screen editor software)*

◆ST403-AG41-24V

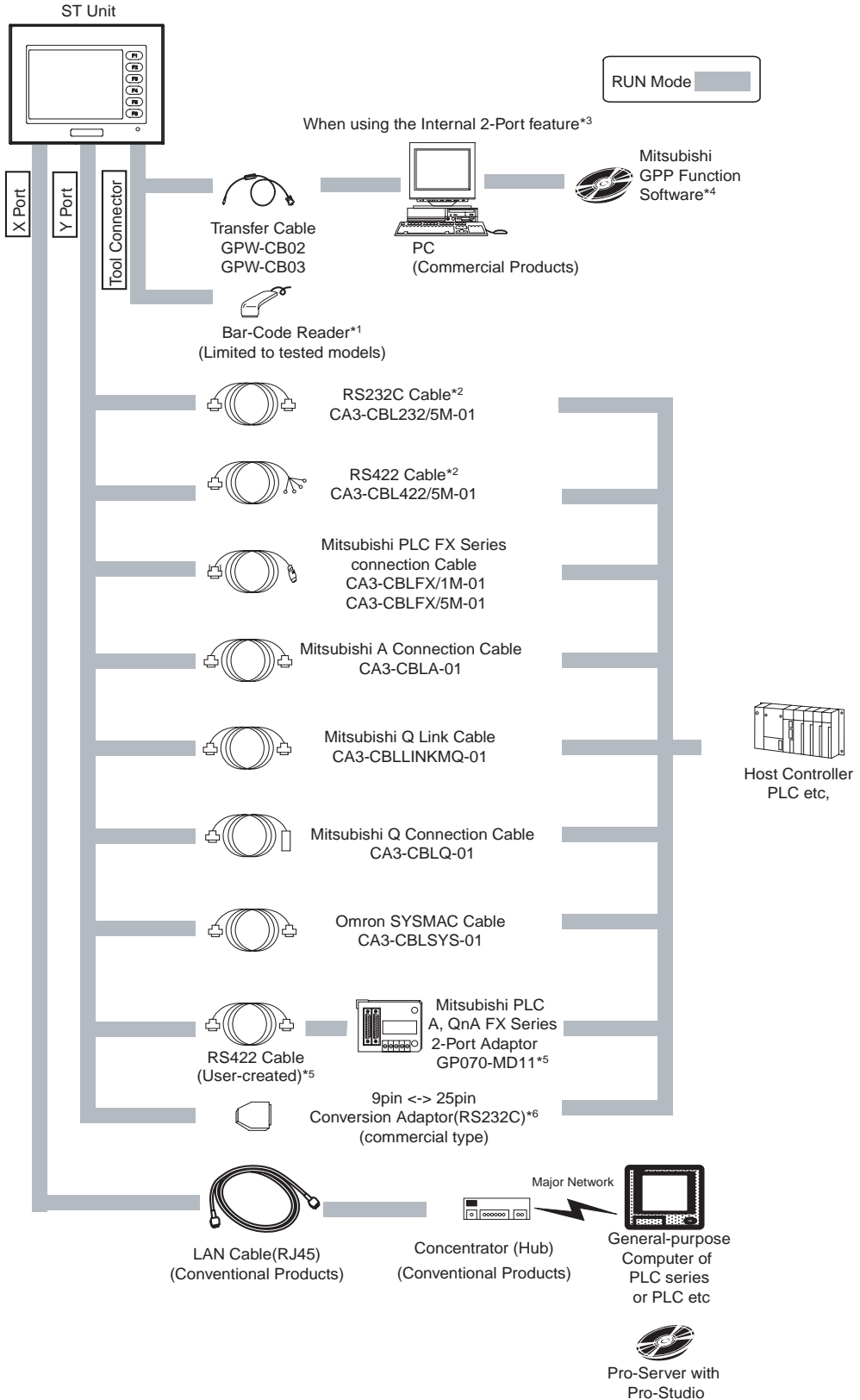

*1 For recommended units,

SEE → *Recommended Units (Page 1-8)*

*2 Certain types and models of devices cannot be connected.

SEE → *GP-PRO/PBIII for Windows Device/PLC Connection Manual (included with the screen editor software)*

*3 This feature can only be used with Mitsubishi A, QnA and FX Series PLCs. For a list of compatible units,

SEE → *GP-PRO/PBIII for Windows Device/PLC Connection Manual (included with the screen editor software)*

*4 For a list of compatible software,

SEE → *GP-PRO/PBIII for Windows Device/PLC Connection Manual (included with the screen editor software)*

*5 Certain types and models of PLCs cannot be connected.

SEE → *GP-PRO/PBIII for Windows Operation Manual (included with the screen editor software)*

*6 When the ST side of the cable uses a D-sub 25-pin connector, a 9pin <-> 25pin adaptor is required.

SEE → *GP-PRO/PBIII for Windows Device/PLC Connection Manual (included with the screen editor software)*

■ ST Edit Mode Peripherals

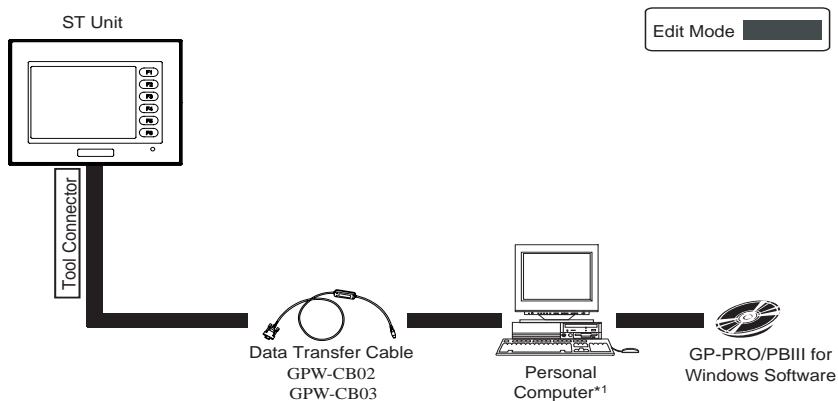

*1 Certain type of PCs cannot be used.

SEE → *GP-PRO/PBIII for Windows Operation Manual (included with the screen editor software)*

■ Recommended Units

The following tables list I/O devices that have been confirmed to be compatible with the ST. If you connect a device other than those listed below, be sure to confirm that the connection functions correctly using an actual unit.

IMPORTANT • Recommended units are subject to change without notice.

◆ Bar Code Readers (Connected to Tool Connector)

Manufacturer	Model	Type
Aimex Corporation	BR-331 PC2	Pen
OPT Electronics	OPT-1105-RSK 98 Set	Touch Scanner (Read Width: 60mm)
	OPT-5105-RSK 98 Set	Touch Scanner (Read Width: 80mm)
	OPL-6735-RSK 98 Set	Touch Scanner (Read Width: 100mm)
Tohken	TCD-5510M	Touch Scanner (Read Width: 65mm)
	TCD-5510L	Touch Scanner (Read Width: 82mm)
	TCD-5510W	Touch Scanner (Read Width: 105mm)
NEC Infrontia	BCK5435-STA	Touch Scanner (Read Width: 56mm) ^{*1 *2}
	BCK5535-STA	Touch Scanner (Read Width: 85mm) ^{*1 *2}

*1 Be sure to use the Y cable included with the unit and connect it between ST unit and a bar code reader. Data cannot be read correctly, if a non-"Y" cable is used, or if the bar code reader is connected directly to the ST unit.

*2 The following settings must be entered prior to using the bar code reader with a ST unit.

- 1) Set the CAPS.
- 2) Add the Carriage Return (CR) in the Postamble's settings.

For the details about these settings, please refer to the Installation Guide included with the bar cord unit.

1.3 Accessories

All optional equipment listed here is produced by Digital Electronics Corporation.

■ Available Software

Product Name	Model No.	Description
GP-PROPB III C-Package02 (GP-PRO/PB III for Windows Ver. 6.30 or higher ^{*1})* ²	GPPRO-CNT01W-P02	Software to be used to create the ST's screen data. Installed in a personal computer.

*1 Certain types of PLCs cannot be connected.

*2 The ST403 unit requires GP-PRO/PB III C-Package03 Service Pack2 (GP-PRO/PB III for Windows Ver. 7.20) or higher.

■ Tool Connector

Product Name	Model No.	Description
Screen Data Transfer Cable	GPW-CB02	Connects the ST to a personal computer. Transfers screen data and user program(s).
Screen Data Transfer Cable (USB type)	GPW-CB03	

■ Serial Interfaces

Product Name	Model No.	Description
RS-232C cable ^{*1}	CA-CBL232/5M-01 (5m)	Interface cables between the host (PLC) and the ST.
RS-422 cable ^{*1}	CA-CBL422/5M-01 (5m)	
Mitsubishi FX Series Connection Cable	CA-CBLFX/1M-01 (1m)	Connects directly to Mitsubishi PLC FX Series Device connector I/F. Simultaneous use of programming panel, however, is not possible.
	CA-CBLFX/5M-01 (5m)	
Mitsubishi Q Link Cable	CA3-CBLLINKMQ-01	An interface cable which is able to connect directly to a Mitsubishi PLC-Q.
Omron SYSMAC Cable	CA3-CBLSYS-01	An interface cable which is able to connect directly to an Omron PLC-SYSMAC.
Mitsubishi Q Connection Cable	CA3-CBLQ-01	An interface cable which is able to connect directly to a programming console of Mitsubishi PLC-Q products.
Mitsubishi A Connection Cable	CA3-CBLA-01	An interface cable which is able to connect directly to a programming console of Mitsubishi PLC-A products.

*1 Certain types of PLCs cannot be connected.

■ Option

Product Name	Model No.	Description
Screen Protection Sheet (Hard Type)	ST400-DF01	Disposable, dirt-resistant sheet for the ST's screen. The ST's touch panel can be operated with this cover sheet attached. (5 sheets/set)
Attachment	CA4-ATMST-01	When replacing from GP-230/250/270 Series, can be the spacer for the panel face clearance.

■ Maintenance Options

They are available separately as optional maintenance items.

Product Name	Model No.	Description
Installation Fastener	CA3-ATFALL-01	Fasteners to attach the ST to a panel. (4 fasteners/set)
Installation Gasket	ST400-WP01	Provides a moisture resistant seal when installing the ST. Same as the seal included in the ST's original equipment package.

2



Specifications

- 2.1 General Specifications
- 2.2 Functional Specifications
- 2.3 Interface Specifications
- 2.4 Part Names and Functions
- 2.5 Dimensions

2.1 General Specifications

2.1.1 Electrical

Rated Voltage	DC24V
Rated Voltage Range	DC19.2V to 28.8V
Allowable Voltage Drop	2ms or less
Power Consumption	7W or less
In-Rush Current	50A or less *1
Voltage Endurance	AC500V 20mA for 1 minute (between charging and FG terminals)
Insulation Resistance	20MΩ or higher at DC500V (between charging and FG terminals)

*1 The FWHM (Full-width, half maximum) value is approximately 50μs. (When exceeding 25A)

2.1.2 Environmental

Ambient Operating Temperature (Cabinet Interior) (Panel Face)	0°C to +50°C*1
Storage Temperature	-20°C to +60°C
Operating Humidity	10%RH to 90%RH (Non condensing, wet bulb temperature: 39°C or less)
Storage Humidity	10%RH to 90%RH (Non condensing, wet bulb temperature: 39°C or less)
Air Purity (Dust)	0.1mg/m ³ or less (non-conductive levels)
Pollution Degree	Pollution Degree 2
Corrosive Gasses	Free of corrosive gasses
Atmospheric Endurance (ST Operation Altitude)	800hPa to 1,114hPa (2,000 meters or lower)
Vibration Resistance	IEC61131-2 compliant <u>When vibration is NOT continuous</u> 10Hz to 57Hz 0.075mm, 57Hz to 150Hz 9.8m/s ² <u>When vibration is continuous</u> 10Hz to 57Hz 0.035mm, 57Hz to 150Hz 4.9m/s ² X, Y, Z directions for 10 times (80min.)
Noise Immunity (via noise simulator)	Noise Voltage: 1,000Vp-p Pulse Duration: 1μs Rise Time: 1ns
Electrostatic Discharge Immunity	6kV (complies with EN 61000-4-2 Level 3)

*1 The LCD displays of ST may occasionally blur when they are used for hours at over 40°C ambient operating temperature. This is a temporal phenomenon. After the temperature returns to normal, the normal display will be restored. The ST's operation will not be affected even though the display is blurred.

2.1.3 Structural

Grounding	100Ω or less, or your country's applicable standard
Ratings *1 (For front panel of installed unit)	Equivalent to IP65 (JEM 1030), NEMA#250 Type4X/12
External Dimensions	W130 mm [5.12 in] x H104 mm [4.09 in] x D41 mm [1.61 in]
Weight	0.4Kg (0.9lb) or less
Cooling Method	Natural air circulation

*1 The front face of the ST unit, installed in a solid panel, has been tested using conditions equivalent to the standards shown in the specification.

Therefore, prior to installing the ST be sure to confirm the type of conditions that will be present in the ST's operating environment. If the installation gasket is used for a long period of time, or if the unit and its gasket are removed from the panel, the original level of the protection cannot be guaranteed. To maintain the original protection level, be sure to replace the installation gasket regularly.

2.2 Functional Specifications

2.2.1 Display

Type	Monochrome LCD	
Resolution	320 x 240 pixels	
Active Display Area	W76.7 mm [3.02in.] x H57.5 mm [2.26in.]	
Colors	Black and White, 2 levels of gray/Black and White, 8 levels of gray ^{*1} (Color switching is done via software)	
Backlight	ST400-AG41-24V ST401-AG41-24V ST402-AG41-24V	LED Backlight (Color: Amber ^{*2} ; Service life: Ave. 50,000 hrs. [half of original brightness])
	ST403-AG41-24V	LED Backlight (Color: Amber ^{*2} ; Service life: Ave. 50,000 hrs. [half of original brightness]) (Color: Red ^{*2} ; Service life: Ave. 10,000 hrs. [half of original brightness])
Contrast Adjustment	8 levels of adjustment available via touch panel.	
Brightness Adjustment	2 levels of adjustment available via touch panel.	
Language Fonts	ASCII: (Code page 850) Alphanumeric (incl. Eur. characters) Chinese: (GB2312-80 codes) simplified Chinese fonts Japanese: ANK 158, Kanji : 6,962 (JIS Standards 1 & 2) (including 607 non-kanji characters) Korean: (KSC5601 - 1992 codes) Hangul fonts Taiwanese: (Big 5 codes) traditional Chinese fonts	
Character	Character Sizes ^{*3}	8X8, 8X16, 16X16 and 32X32 dot fonts
	Font Sizes	Width can be expanded 1 to 8 times. Height can be expanded 1/2 and 1 to 8 times.
Text	8x8 dots	40 Char. x 30 rows
	8x16 dots	40 Char. x 15 rows
	16x16 dots	20 Char. x15 rows
	32x32 dots	10 Char. x 7 rows

*1 Depending on the color used, selecting MONOCHROME 8 HUES may cause the ST unit's screen to flicker and make it difficult to distinguish colors. Confirm that all colors display as expected prior to using this mode.

*2 Among backlight units there may be slight variations in illumination color, however, this does not effect the performance or quality of the ST unit.

*3 The display font will differ depending on which (language) character, or which size you select. Also, if GP-PRO/PBIII Ver. 5.0 or later software is used, high quality fonts are available with 16x16 or larger characters.

SEE → 6.9 Font Setting (Page 6-30)

2.2.2 Memory

Application	User screen area: 640KB Approx. 200 screens at 3.2KB/screen
Data Backup	96KB User backup memory
	Uses a rechargeable lithium battery ^{*1}

*1 A Lithium battery's lifetime is:

10 years when the battery's ambient temperature is 40°C or less.

10 years when the unit's ambient temperature is 25°C or less.

When used for backup:(without main power)

Approximately 60 days, with a fully charged battery

Approximately 6 days, with a 10% charged battery

2.2.3 Touch Panel and Clock

Clock Accuracy	±65 seconds/ month (at room temperature)
----------------	--

NOTE

- The ST's internal clock has a slight error. At normal operating temperatures and conditions, with the ST operating from its lithium battery, the degree of error is 65 seconds per month. Variations in operating conditions and battery life can cause this error to vary from -380 to +90 seconds per month. For systems where this degree of error will be a problem, the user should be sure to monitor this error and make adjustments when required.

SEE → 6.7 Set Up Time (Page 6-28)

2.2.4 Touch Panel and Function keys

Touch Panel Resolution	8 x 6 keys/screen 1 or 2 point push - selectable
Function keys	Switches: 6

2.2.5 Interfaces

■ST400-AG41-24V

Serial I/F (X)	Asynchronous Transmission : RS-422 (4-wire or 2-wire) Data Length: 7 or 8 bits Stop Bit: 1 or 2 bits Parity: None, Odd or Even Data Transmission Speed: 2,400bps to 115,200bps
Tool Connector (TOOL)	Asynchronous TTL level nonprocedural command I/F <During screen file development> Used for transferring data to and from the GP application software and the ST. <During Operation> Used for data transfer with the Internal 2-Port feature. Used for a variety of devices, including a bar-code reader.

■ST401-AG41-24V

Serial I/F(Y)	Asynchronous Transmission : RS-232C Data Length: 7 or 8 bits Stop Bit: 1 or 2 bits Parity: None, Odd or Even Data Transmission Speed: 2,400bps to 115,200bps
Tool Connector (TOOL)	Asynchronous TTL level nonprocedural command I/F <During screen file development> Used for transferring data to and from the GP application software and the ST. <During Operation> Used for data transfer with the Internal 2-Port feature. Used for a variety of devices, including a bar-code reader.

■ST402-AG41-24V

Serial Interface (X)	Asynchronous Transmission : RS-485 (Siemens MPI Direct Connection) Data Length: 7 or 8 bits Stop Bit: 1 or 2 bits Parity: None, Odd or Even Data Transmission Speed: 2,400bps to 187.5Kbps
Expansion Serial Interface (Y)	Asynchronous Transmission: RS-422 (4-wire or 2-wire) Data Length: 7 or 8 bits Stop Bit: 1 or 2 bits Parity: None, Odd or Even Data Transmission Speed: 2,400bps to 38,400bps
Tool Connector (TOOL)	Asynchronous TTL level nonprocedural command I/F <During screen file development> Used for transferring data to and from the GP application software and the ST. <During Operation> Used for a variety of devices, including a bar-code reader.

■ST403-AG41-24V

Network Interface (X)	Ethernet(IEEE802.3) 10BASE-T
Serial I/F(Y)	Asynchronous Transmission: RS-232C/RS-422 Data Length: 7 or 8 bits Stop Bit: 1 or 2 bits Parity: None, Odd or Even Data Transmission Speed: 2,400bps to 115,200bps
Tool Connector (TOOL)	Asynchronous TTL level nonprocedural command I/F <During screen file development> Used for transferring data to and from the GP application software and the ST. <During Operation> Used for a variety of devices, including a bar-code reader.

2.3 Interface Specifications

2.3.1 ST400-AG41-24V

■Serial Interface

RS-422 Interface (X)

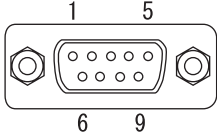
Pin Connection	Pin No.	Signal	Signal Name	Direction
	1	RDA	Receive data A	Input
	2	RDB	Receive data B	Input
	3	SDA	Send data A	Output
	4	ERA	Enable receive A	Output
	5	SG	Ground	-
	6	CSB	Clear send B	Input
	7	SDB	Send data B	Output
	8	CSA	Clear send A	Input
	9	ERB	Enable receive B	Output

Recommended Connector : Dsub 9 pin socket-type XM2D-0901 <made by OMRON Corp.>

Recommended Cover : Dsub 9 pin cover XM2S-0913 <made by OMRON Corp.>

NOTE

- RS-422 (4-wire or 2-wire) can be used to connect the ST with Devices/PLCs.
- Use inch type screw (#4-40UNC) as set screws.
- The following pairs of pin #'s must be connected to each other.
 #6(CSB) <-> #9(ERB)
 #8(CSA) <-> #4(ERA)
- This unit is not equipped internally with termination resistance. Attach termination resistance to the cable. If there is no designation on the PLC/Device side, attach 100Ω1/2W.

2.3.2 ST401-AG41-24V

■Serial Interface

RS-232C Interface (Y)

Pin Connection	Pin No.	Signal	Signal Name	Direction
	1	CD	Carrier detect	Input
	2	RD	Receive data	Input
	3	SD	Send data	Output
	4	ER	Enable receive	Output
	5	SG	Ground	-
	6	DR	Data set ready	Input
	7	RS	Request send	Output
	8	CS	Clear send	Input
	9	RI	Ring indicate	Input

Recommended Connector : Dsub 9 pin socket-type XM2D-0901 <made by OMRON Corp.>

Recommended Cover : Dsub 9 pin cover XM2S-0913 <made by OMRON Corp.>

NOTE

- RS-232C can be used to connect the ST with Devices/PLCs.
- Use inch type screw (#4-40UNC) as set screws.

2.3.3 ST402-AG41-24V

■Serial Interface

RS-485 (MPI) Interface (X)

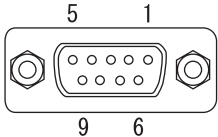
Pin Connection	Pin No.	Signal	Signal Name	Direction
 <p>*1</p>	1	NC	No connection	-
	2	NC	No connection	-
	3	LINE(+)	Line (+)	In/Output
	4	RTS	Request Send	Output
	5	SG	Ground	-
	6	5V	5V External Output ^{*2}	Output
	7	NC	No connection	-
	8	LINE(-)	Line (-)	In/Output
	9	NC	No connection	-

*1 The connector of the ST side is socket type.

*2 When providing power via the Seimens Corporation Profibus connector, power cannot be connected to the Device/PLC.

Recommended Connector : Dsub 9 pin **pin-type XM2A-0901** <made by OMRON Corp.>

Recommended Cover : Dsub 9 pin cover XM2S-0913 <made by OMRON Corp.>

NOTE

- This communication port is designed exclusively to be used for an MPI Direct Connection with Seimens Corporation S7-200/300/400 Series PLCs.
- Use inch type screw (#4-40UNC) as set screws.
- This unit is not equipped internally with termination resistance. Attach termination resistance to the cable. If there is no designation on the PLC side, attach 100Ω1/2W.

Expansion Serial Interface

RS-422 Interface (Y)

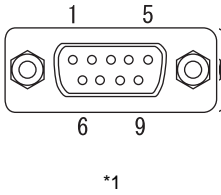
Pin Connection	Pin No.	Signal	Signal Name	Direction
 <p style="text-align: center;">*1</p>	1	RDA	Receive data A	Input
	2	RDB	Receive data B	Input
	3	SDA	Send data A	Output
	4	ERA	Enable receive A	Output
	5	SG	Ground	-
	6	CSB	Clear send B	Input
	7	SDB	Send data B	Output
	8	CSA	Clear send A	Input
	9	ERB	Enable receive B	Output

*1 The connector of the ST side is pin type.

Recommended Connector : Dsub 9 pin **socket-type XM2D-0901** <made by OMRON Corp.>
 Recommended Cover : Dsub 9 pin cover XM2S-0913 <made by OMRON Corp.>

NOTE

- This communication port is used exclusively for Extended SIO Scripts. To use this port, an Extended SIO Script is required.
SEE → *GP-PRO/PBIII for Windows Device/PLC Connection Manual (included with the screen editor software)*
- Use inch type screw (#4-40UNC) as set screws.
- The following pairs of pin #'s must be connected to each other.
 #6(CSB) <-> #9(ERB)
 #8(CSA) <-> #4(ERA)
- This unit is not equipped internally with termination resistance. Attach termination resistance to the cable. If there is no designation on the PLC/Device side, attach 100Ω/2W.

2.3.4 ST403-AG41-24V

■ Ethernet Interface (X)

This is the Ethernet Interface of 10 BASE-T. LED lights up or blinks according to the status.

LED	Contents
Orange	When the power supply is on, LED lights up. When sending or receiving, LED blinks.
Green	When linking, LED lights up.

■ Serial Interface

RS-232C/RS-422 Interface (Y)^{*1}

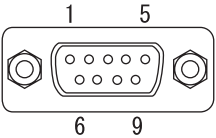
Pin Connection	Pin No.	Signal	Signal Name	Direction
	1	CD/RDA	Carrier detect /Receive data A	Input /Input
	2	RD/RDB	Receive data /Receive data B	Input /Input
	3	SD/SDA	Send data/Send data A	Output /Output
	4	ER/ERA	Enable receive /Enable receive A	Output /Output
	5	SG/SG	Ground/Ground	-
	6	DR/CSB	Data set ready/Clear send B	Input /Input
	7	RS/SDB	Request send /Send data B	Output /Output
	8	CS/CSA	Clear send/Clear send A	Input /Input
	9	RI/ERB	Ring indicate /Enable receive B	Input /Output

Recommended Connector : Dsub 9 pin socket-type XM2D-0901 <made by OMRON Corp.>

Recommended Cover : Dsub 9 pin cover XM2S-0913 <made by OMRON Corp.>

NOTE

- Use inch type screw (#4-40UNC) as set screws.
- RS-422 is not equipped internally with termination resistance. Attach termination resistance to the cable.

^{*1} Transmission method is used by changing in the screen editor software or in the setting at the ST unit.

2.4 Part Names and Functions

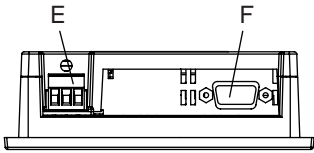
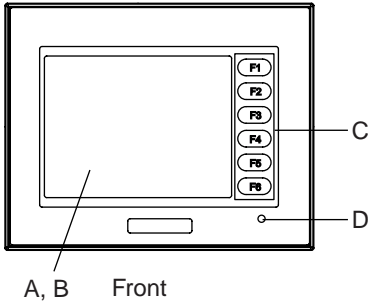

ST400-AG41-24V Bottom

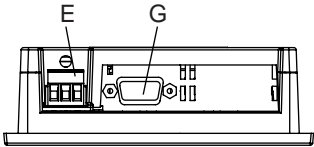

ST401-AG41-24V Bottom

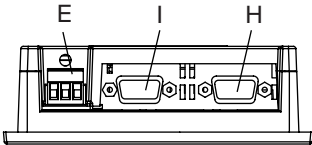

ST402-AG41-24V Bottom

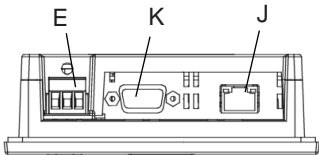

ST403-AG41-24V Bottom

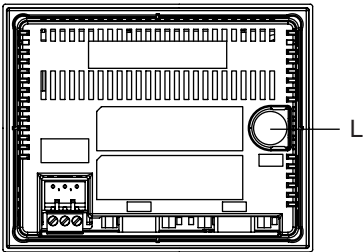

Rear

- A: Display
- B: Touch Panel
- C: Function Switch (F1 to F6)
- D: Power Lamp
- E: Power Plug
- F: RS-422 Interface (X)
- G: RS-232C Interface (Y)
- H: RS-485(MPI) Interface (X)
- I: RS-422 Interface (Y)
- J: Ethernet Interface (X)
- K: RS-232C/RS-422 Interface (Y)
- L: Tool Connector (TOOL)

2.5 Dimensions

2.5.1 ST Series External Dimensions

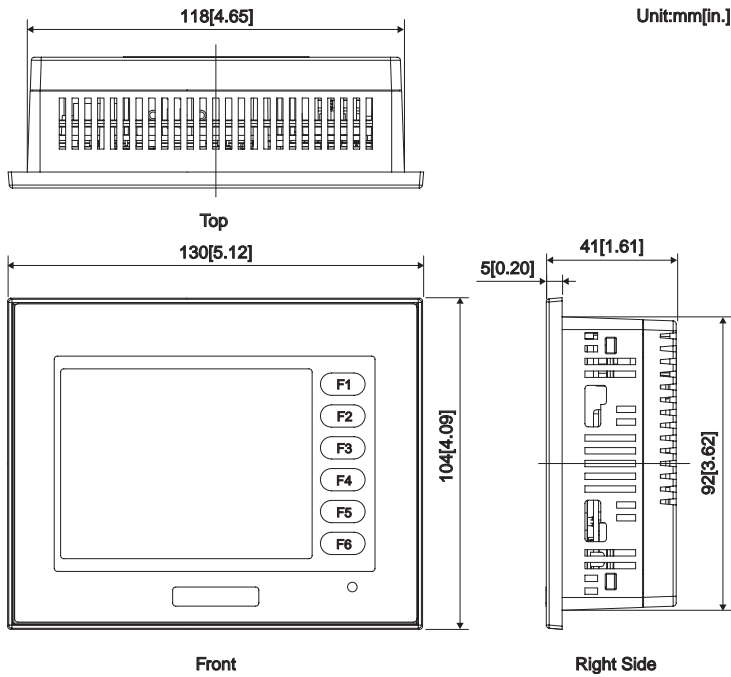

The following drawing shows the ST Series unit with installation fasteners.

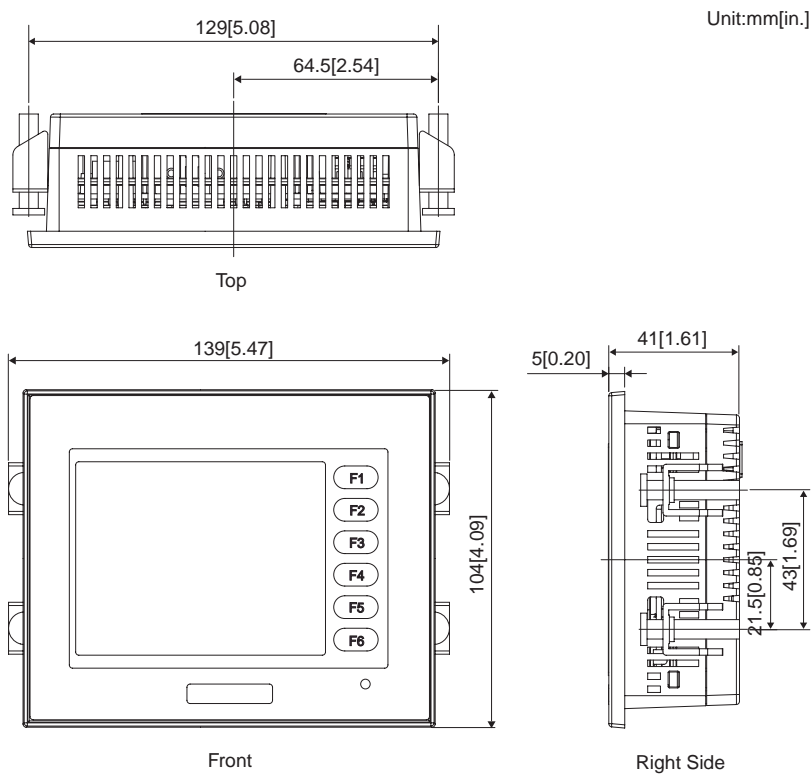

2.5.2 Panel Cut Dimensions

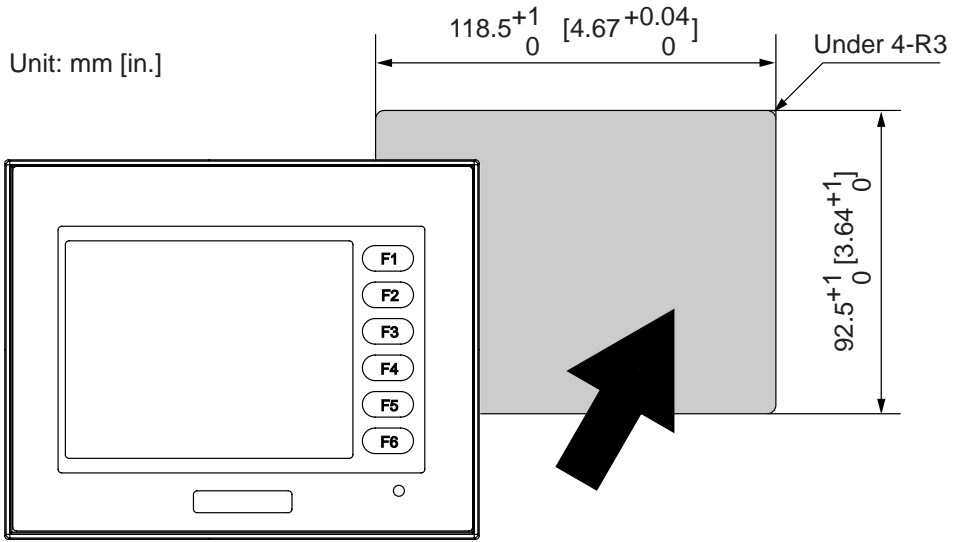

2.5.3 Installation Fasteners

Unit:mm[in]

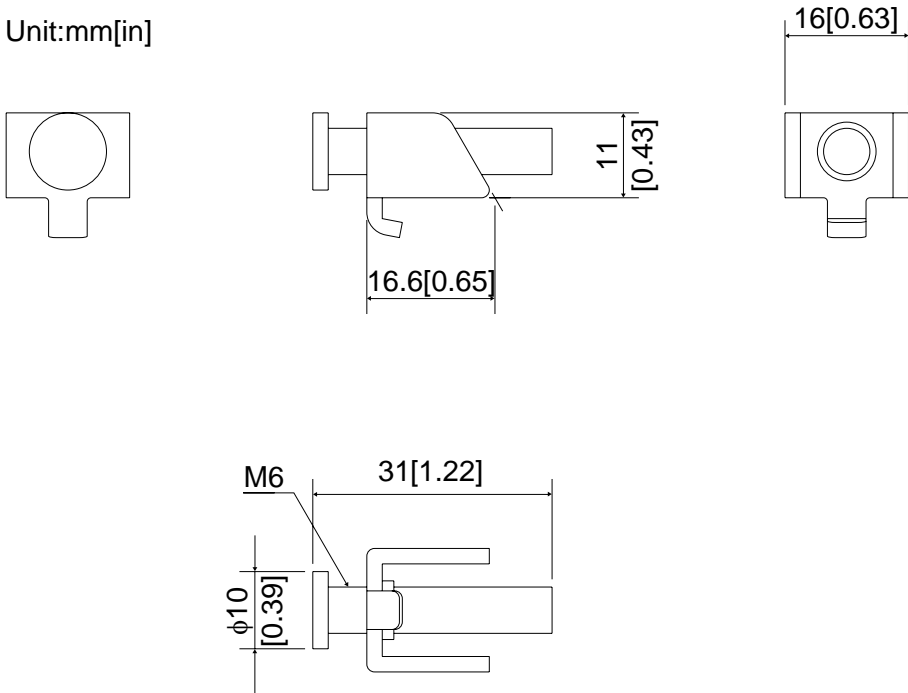

3

Installation and Wiring

- 3.1 Installation
- 3.2 Wiring Precautions
- 3.3 Tool Connector
- 3.4 Ethernet Cable Connector

3.1 Installation

3.1.1 Installation Procedures

Follow the steps given below when installing the ST.

■ Check the Installation Gasket's Seating

It is strongly recommended that you use the installation gasket, since it absorbs vibration in addition to repelling water.

Place the ST on a level surface with the display panel facing downward. Check that the ST's installation gasket is seated securely into the gasket's groove, which runs around the perimeter of the panel's frame. For details about installing the gasket, refer to

SEE → 8.1.2 *Installation Gasket Check/Replacement (Page 8-2)*

IMPORTANT

- Before installing the ST into a cabinet or panel, check that the installation gasket is securely attached to the unit.
- A gasket which has been used for a long period of time may have scratches or dirt on it, and could have lost much of its dust and drip resistance. Be sure to change the gasket periodically (or when scratches or dirt become visible).
- Be sure to use gasket model ST400-WP01
- Be sure the gasket's seam is not inserted into any of the unit's corners, only in the straight sections of the groove. Inserting it into a corner may lead to its eventually tearing.
- To ensure the installation gasket's maximum level of moisture resistance, be sure the gasket's seam instead as shown into the panel's bottom face.

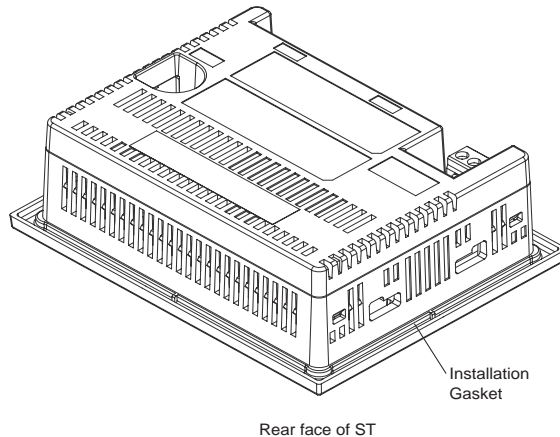

■ Creating a Panel Cut

Create the correct sized opening required to install the ST, using the installation dimensions given.

SEE → 2.5.2 Panel Cut Dimensions (Page 2-14)

The installation gasket, installation brackets and attachment screws are all required when installing the ST.

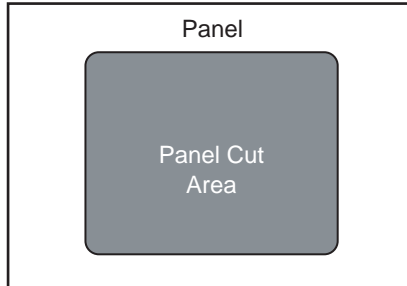

NOTE

- Check that the installation panel or cabinet's surface is flat, in good condition and has no jagged edges. Also, if desired, metal reinforcing strips can be attached to the inside of the panel, near the Panel Cut, to increase the panel's strength.

IMPORTANT

- Panel thickness should be from 1.6mm [0.06in.] to 10mm [0.4in.]. Decide the panel's thickness based on the level of panel strength required.

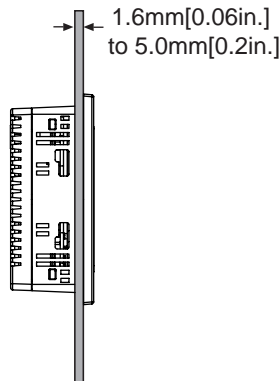

- For easier maintenance, operation, and improved ventilation, be sure to install the ST at least 100 mm [3.94 in.] away from adjacent structures and other equipment.

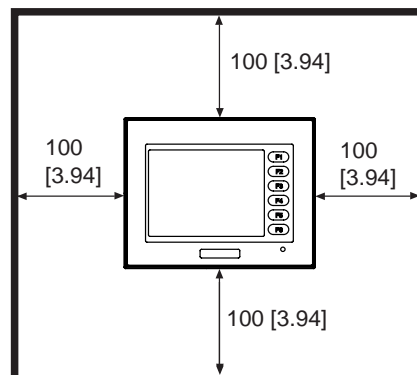
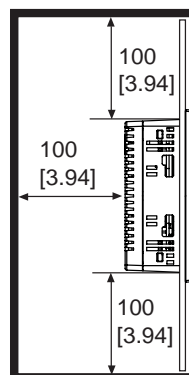

Unit: mm [in.]

IMPORTANT

- Be sure that the ambient operation temperature and the ambient humidity are within their designated ranges. (When installing the ST in a cabinet or enclosure, the term “ambient operation temperature” indicates the cabinet or enclosure’s internal temperature.)

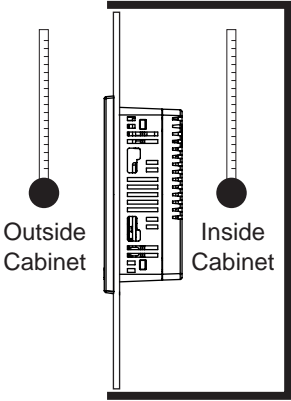

- Be sure that heat from surrounding equipment does not cause the ST to exceed its standard operating temperature.
- When installing the ST in a slanted panel, the panel face should not incline more than 30°.

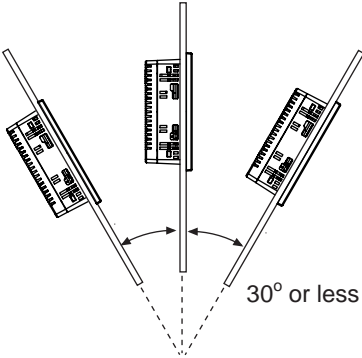

- When installing the ST in a slanted panel, and the panel face inclines more than 30°, the ambient temperature must not exceed 40°C.
- When installing the ST vertically, position the unit so that the Power Input Terminal Block is also vertical.

■ Installing the ST

- (1) Insert the ST into the panel cut out, as shown here.

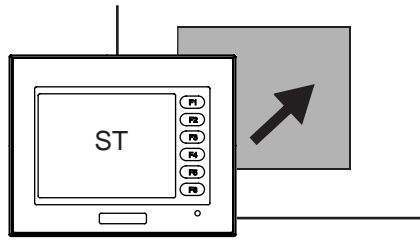

- (2) Insert the installation fasteners into the ST's insertion slots, on the right and left side of the unit.

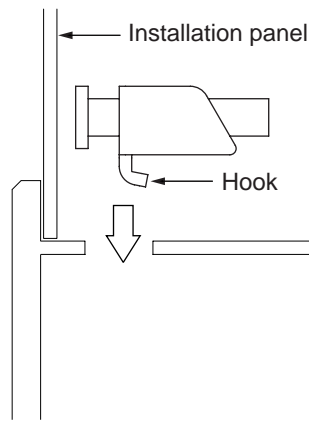
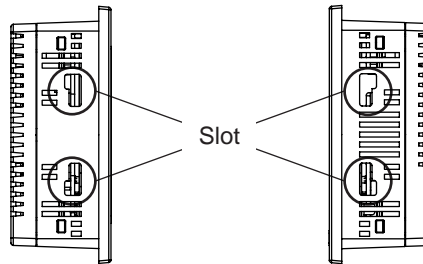

IMPORTANT

- Be sure to insert installation fasteners in the recessed portion of a installation fasteners hole. (Refer to the following figure) If the fasteners are not correctly attached, the ST unit may shift or fall out of the panel.

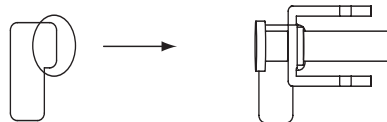

- (3) Installation fasteners are made to slide to a back side.

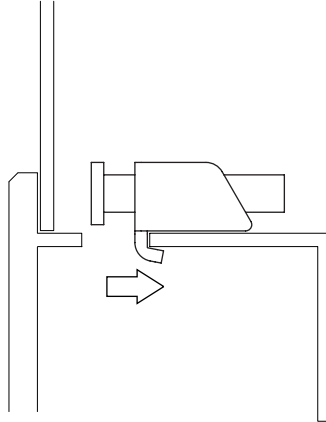

- (4) Use a Phillips screwdriver to tighten each fastener screw and secure the ST in place.

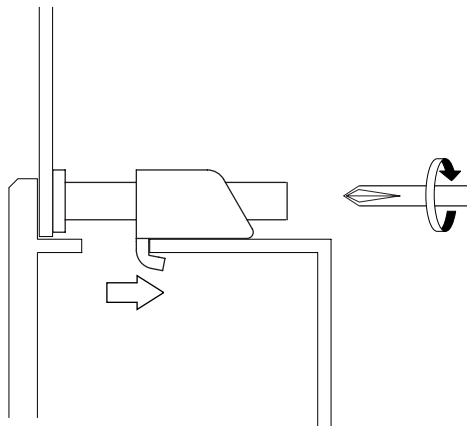

IMPORTANT

- A torque of only 0.5 N·m is sufficient to tighten these screws. Do not use too much force, since it may damage the ST unit.

3.2 Wiring Precautions

3.2.1 Connecting the Power Cord

⚠ WARNING

- ⊘ To avoid an electric shock, be sure the power cord is unplugged from the power outlet when connecting the power terminals to the ST unit.
- ⊘ The ST400-AG41-24V, ST401-AG41-24V, ST402-AG41-24V and ST403-AG41-24V are designed to use only DC24V power. Using any other level of power can damage both the power supply and the ST unit.
- ⊘ Since the ST is not equipped with the power switch, be sure to connect a breaker type power switch to the ST's power cord.
- ⊘ Be sure to ground the ST's FG terminal. Failure to do so can lead to an electrical shock or ST malfunction.
- ⊘ If the power cord is pulled strongly, the power plug may fall out.

IMPORTANT

- When the FG terminal is connected, be sure the wire is grounded. Not grounding the ST unit will result in excessive noise. Use your country's applicable standard for grounding.
 - (SEE →) 3.2.3 Grounding (Page 3-10)
- The SG and FG terminals are connected internally in the ST unit.

■ Wiring

When connecting the Power Cord, Use the following items when performing wiring. (Items are made by Phoenix Contact.*1)

Recommended Driver	SZF 1-0.6x3.5 (1204517)
Recommended Pin Terminals	AI 0.25-6BU (3201291) AI 0.34-8TQ (3200865) AI 0.5-8WH (3200014) AI 0.75-8GY (3200519) AI 1-8RD (3200030) AI 1.5-8BK (3200043) AI 2.5-8BU (3200522)
Recommended Pin Terminal Crimp Tool	CRIMPFOX ZA3 (1201882)

*1 For details, please contact your local Phoenix Contact distributor.

NOTE • Power Cord Specifications

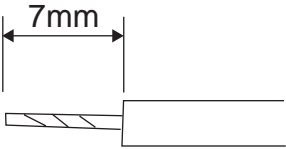
Power Cord Diameter	0.2 to 2.5 mm ² (0.0001 to 0.0097 inch ²) (24 to 12 AWG)
Conductor Type	Simple or Twisted Wire
Conductor Length	

IMPORTANT • If the Conductor's end (individual) wires are not twisted correctly, the end wires may either short against each other, or against an electrode.

■ Power Plug Specifications

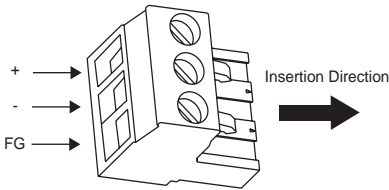
	+	24V
	-	0V
	FG	Grounding Terminal connected to the ST.

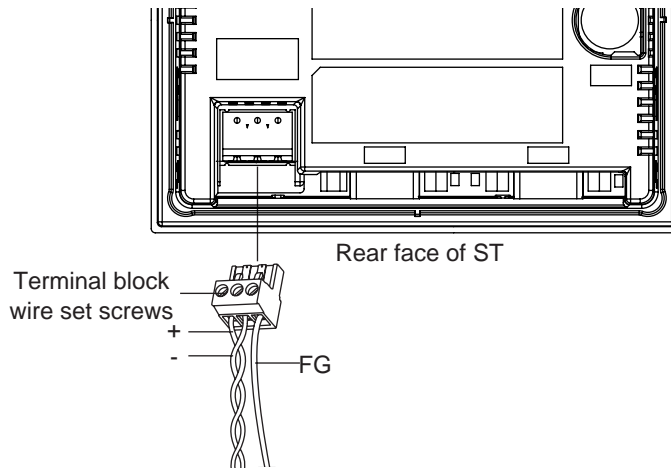

- (1) Be sure that the ST's power cord is not plugged in to the power supply.
- (2) Remove the power plug from the ST unit.
- (3) Insert each wire into the power plug's wire hole.
- (4) Replace the power plug.

IMPORTANT

- Use flat screwdriver (SIZE 0.6 x 3.5) to tighten the terminal block wire set screws. The torque required to tighten these screws is 0.5 to 0.6 N·m.
- Do not solder the wire itself.

NOTE

- The power supply cord should be equivalent to the specification shown above. Be sure to twist the power cords together, up to the power plug. (See illustration as shown below)
- The power supply plug MSTB2,5/3-ST-5,08 is made by Phoenix Contact.

3.2.2 Connecting the Power Supply

Notes when the power supply is supplied. Please connect the power cable with the power supply connector on the main body side with a power plug of the attachment.

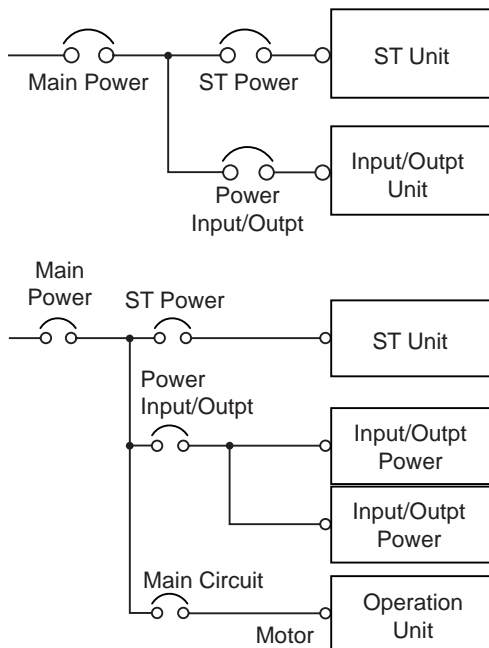

- When supplying power to the ST unit, please separate the input/output and operation unit lines, as shown.
- To increase the noise resistance quality of the power cord, simply twist each power wire before attaching the Ring Terminal.
- The power supply cord must not be bundled or positioned close to main circuit lines (high voltage, high current), or input/output signal lines.
- Connect a lightning surge absorber, as shown in the diagram, to deal with power surges.
- To avoid excess noise, make the power cord as short as possible.

IMPORTANT

- Be sure to ground the surge absorber (E1) separately from the ST unit (E2).
- Select a surge absorber that has a maximum circuit voltage greater than that of the peak voltage of the power supply.

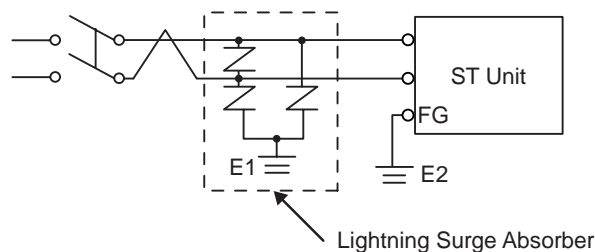

3.2.3 Grounding

⊘ Do not use common grounding, since it can lead to an accident or machine breakdown.

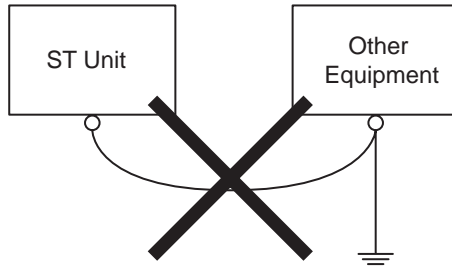

IMPORTANT

- When connecting an FG ground wire to the Power Plug's FG terminal, be sure to create an exclusive ground. Check that the grounding resistance is less than 100Ω.
- Inside the ST400-AG41-24V/ST401-AG41-24V/ST402-AG41-24V/ST403-AG41-24V unit, the SG (Signal Ground) and FG (Frame Ground) terminal are connected to each other.
- When connecting the SG line to another device, be sure that the design of the system/connection does not produce a shorting loop.
- The grounding wire should have a cross sectional area greater than 2mm². Create the connection point as close to the ST unit as possible, and make the wire as short, as possible. When using a long grounding wire, replace the thin wire with a thicker wire, and place it in a duct.

(a) Exclusive Grounding (BEST)^{*1}

- Connect the FG terminal found at the Power Plug to an exclusive ground. [diagram (a)].

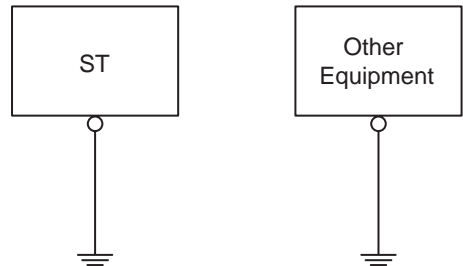

(b) Common Grounding (OK)^{*1}

- If exclusive grounding is not possible, use a common connection point. [diagram (b)]

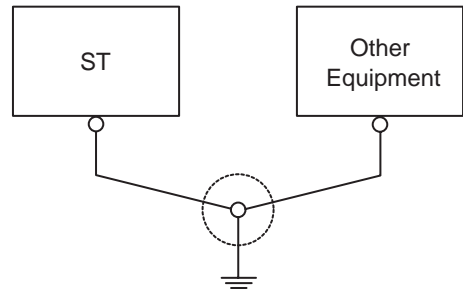

NOTE

- If the equipment does not function properly when grounded, disconnect the ground wire from the FG terminal.

^{*1} Use a grounding resistance of less than 100Ω and a 2mm² or greater thickness wire, or your country's applicable standard. For details, contact your local GP distributor.

3.2.4 I/O Signal Line Placement

- Input and output signal lines must be separated from the power control cables for operating circuits.
- If this is not possible, use a shielded cable and connect the shield to the ST's frame.

3.3 Tool Connector

The ST's Data Transfer Cable, Memory Loader, or the Bar Code Reader can be attached to the ST unit's Tool Connector.

⚠ WARNING

- ⊘ To prevent an electric shock, unplug the ST unit's power cord from the main power supply prior to attaching or detaching any connector(s) to or from the ST.

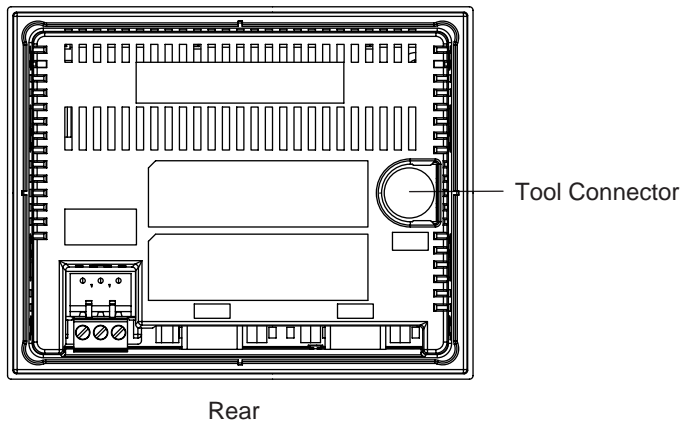

When the Bar Code Reader uses a separate power supply:

- Turn the Bar Code Reader ON before turning the ST ON.
- Turn the ST OFF before turning the Bar Code Reader OFF.

About Connectable Bar Code Reader,

SEE → *Recommended Units (page 1-8)*

3.4 Ethernet Cable Connector

Use the following drawing to locate your ST unit's Ethernet connector. The ST Ethernet interface is IEEE802.3 compatible, and transmits data at 10Mbps. (The Ethernet I/F is equipped on only the ST.)

Ethernet Interface (10BASE-T)

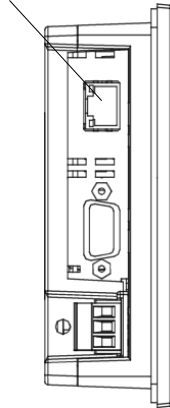

Bottom
(ST403 unit)

NOTE

- It is strongly recommended that your Ethernet network is installed by a trained engineer.
- 1:1 connections using a cross cable may not be possible depending on the type of personal computer and network card you are using. Make sure to use a hub for connection.

4



Data Transfer

4.1 Serial Data Transfer

4.2 Ethernet Data Transfer

4.1 Serial Data Transfer

The following explains how to connect Pro-face's data transfer cable to your PC and to the ST.

IMPORTANT

- Please connect it at an angle correct so as not to push it forcibly with the connector when you install the cable. The main body and the connector might break down.

■ Connection of data transfer cable

◆ When using data transfer cable (GPW-CB02)

The tool connector in the back of the main body is connected with the serial port of the personal computer with the data transfer cable.

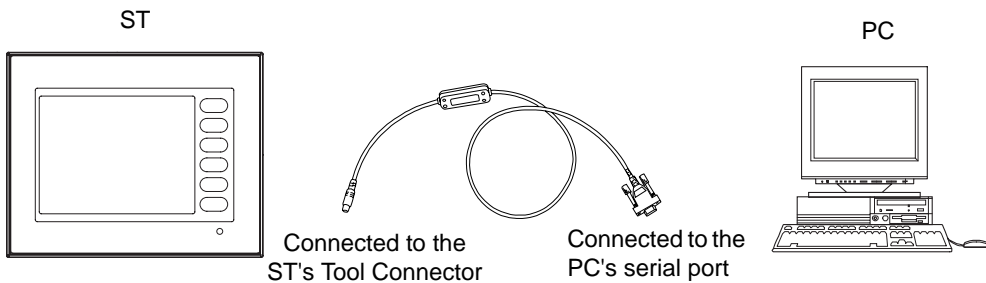

NOTE

- Pro-face's transfer cable (GPW-CB02) is sold separately. The transfer cable package does not include the PC's interface converting adapter.
- When using the PC with the Dsub 25pin socket side interface, a connector conversion adapter is required. Use the straight line type conversion adapter.

Recommended units:

- Arvel AA833
- SANWA SUPPLY INC. D09-9F25F

- When using a PC equipped with a half-pitch 14pin socket interface, a conversion adapter is required.

Recommended unit:

- LOAS Co. Ltd. ZR01-024

◆When using USB transfer cable (GPW-CB03)

Please install the USB connector of the USB transfer cable in the USB port of the personal computer.

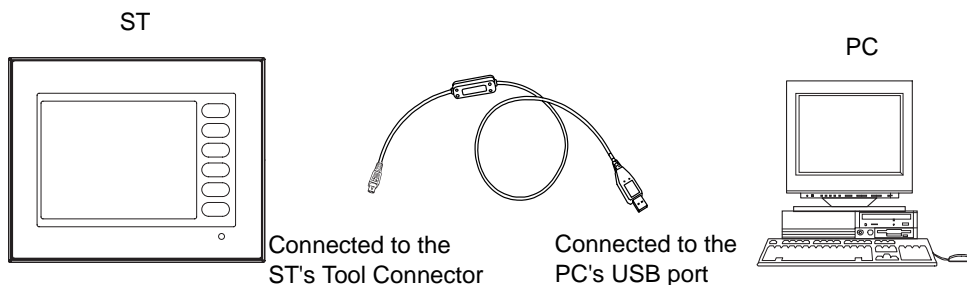

NOTE

- USB transfer cable (GPW-CB03) is an optional. When USB transfer cable is used, it is necessary to install the driver by setting up the cable bundle CD. Please see the manual of USB transfer cable for details.

Transfer screen data from your PC, via the screen editor software.

For details about the screen editor software,



GP-PRO/PBIII for Windows Operation Manual (included in the screen editor software)

■ To Transfer Data to a Completely New ST

Connect the ST to your PC via the data transfer cable, and then turn the ST ON. The “Initial Start Mode” screen will appear on the ST and you can transfer screen from your PC. The screen will change to the “Transfer” screen automatically.

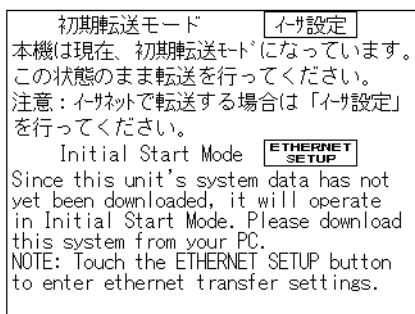

S1403

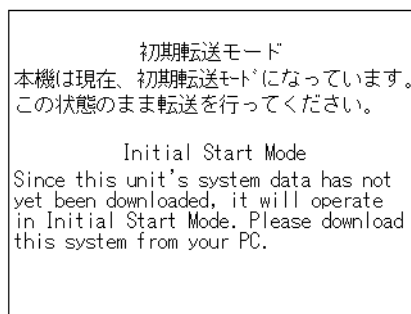

S1400/S1401/S1402

■ After Completing Data Transfer using ST setup*1

Transfer screen data from the screen editor software, and select the “Transfer” mode.

Please switch from an off-line mode to “Transmission of the screen data” mode by hand power when not changing. For more information about OFFLINE MODE,

SEE → 5 OFFLINE Mode (Page 5-1)

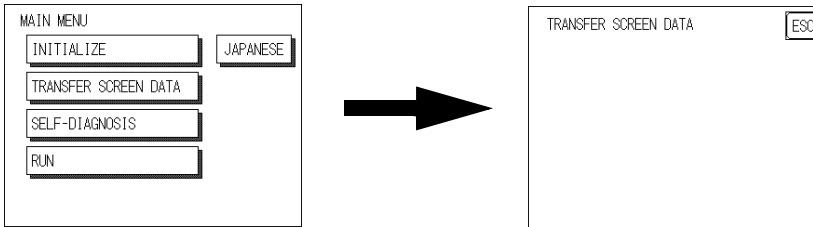

During data transfer, the “SETUP Transfer” and “Now Transferring - Please Wait” messages will appear.

When these messages disappear, screen data transfer is completed.

If you wish to stop data transfer, simply cancel it from your PC’s screen editor software.

If you try to set up the ST after data transfer, the OFFLINE mode’s “Main Menu” will appear. If you do NOT set up the ST, the screen designated in “INITIAL SETTINGS/SCREEN SETUP/INITIAL SCREEN FILE NO.” will appear and the screen will change to operation (RUN) mode.

IMPORTANT

- Do NOT disconnect the ST’s power supply, turn OFF the PC, or disconnect the ST’s transfer cable during the data transfer. If you do, an error may occur when the ST is started.

NOTE

- If the screen editor software’s “GP SYSTEM SETTINGS” data is transferred to the ST, the OFFLINE mode “INITIAL SETTINGS” data will be overwritten.

*1 Here, the term “Set up” refers to the process of sending system program and protocol program information to the ST via the screen editor software, so that the ST can be used as an operator interface.

4.2 Ethernet Data Transfer

The ST403 unit is equipped with the Ethernet I/F which allows you to setup the ST via an Ethernet network, as well as transfer ST screen data. (Unlike ST403 the other units are not equipped with the Ethernet I/F.)

IMPORTANT

- When using the Ethernet communication protocol, you must specify the port number for the protocol as +10 or higher than the value specified in this section. Otherwise, the setup or screen data transfer via Ethernet is disabled.

After you connect an Ethernet cable to the ST's Ethernet I/F, the ST will appear on the Ethernet network.

■ Transferring Data to a Completely New ST

- ◆ Setting Up the IP Address Manually and sending data to a ST Touch the “Ethernet Setup” button on the ST403 Initial Start Mode screen.

SEE →

6.5.4 Ethernet Setup (page 6-24)

Use this method if the ST has been previously set up and data transferred to it.

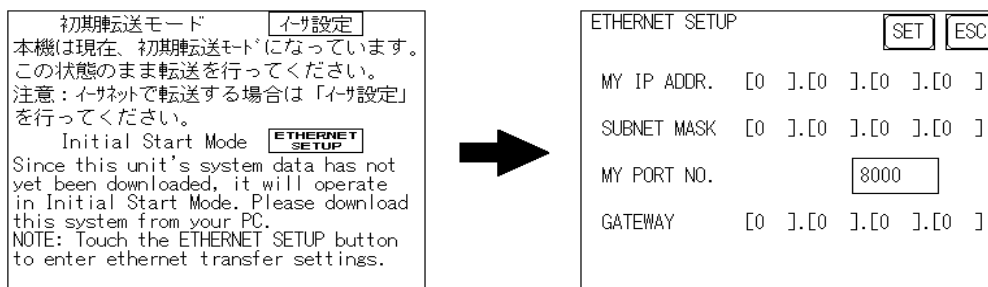

- ◆ Using a previously set up IP Address to send data*¹

When the settings in the “Ethernet Setup” screen are not specified and data is sent, the ST unit’s factory-set IP Address settings are used.

If you choose to use the factory-set IP address, be sure to designate the PC’s IP Address from “10.255.255.1” to “10.255.255.254” and the subnet mask as “255.0.0.0”.

Use the GP-PRO/PBIII for Windows software to transfer the data.

SEE →

“GP-PRO/PBIII for Windows Operation Manual” (included in the screen editor software package)

*1 Be sure to use 2-Way2000 version 3.10 or higher. This version data can be seen in the bottom left-hand corner of the [Initial Start Mode] screen.

■ When transferring data using the ST setup*1 is completed

◆ How to manually set an IP address and transfer data

Set an IP address in the OFFLINE mode “INITIAL SETTING / OPERATING ENVIRONMENT SETTING / EXTENSION SETTING / ETHERNET INFORMATION SETTING”. However, in case that an IP address is preset in the PC’s screen editor software, the IP address is set in the ST. If the transferred IP address is used, setting the ST’s IP address again in the OFFLINE mode is not needed.

Set an IP address in the ST’s through “INITIAL SETTING / OPERATING ENVIRONMENT SETTING / EXTENSION SETTING / ETHERNET INFORMATION SETTING” menu.

When you transfer screen data from your PC to the ST while the ST is in RUN mode, the screen will change automatically to “Ethernet Mode”. If it does not, you will need to manually change the ST screen to Ethernet Mode, via the following screen.

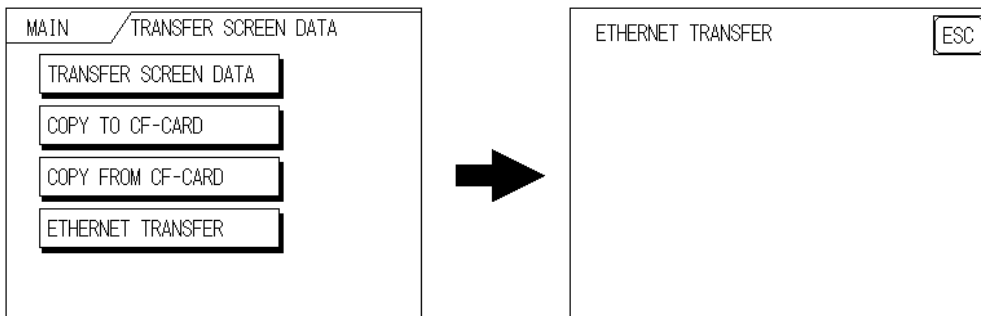

You can now transfer data from your PC’s screen editor software.

SEE → “GP-PRO/PBIII for Windows Operation Manual”

◆ How to transfer data using a previously-set IP address*2

When transferring data without first setting up an IP address in the screen editor software, your ST unit’s factory-set IP address is used.

When transferring data using your ST unit’s factory-set IP address, be sure to set “10.255.255.1” to “10.255.255.254” as your PC’s IP address, and “255.0.0.0” for your PC’s subnet mask.

The data transfer method is the same as when the IP address was manually set.

*1 Here, the term “Set up” refers to the process of sending ST screen, system program and protocol program information to the ST via the screen editor software, so that the ST can be used as an operator interface.

*2 Be sure to use 2-Way2000 version 3.10 or higher. This version data can be seen in the bottom left-hand corner of the [Initial Start Mode] screen.

■Checking the IP Address

Use the following procedure to check the IP Address assigned to the ST and some consideration/precautions.

1) Display the menu bar. For instructions on how to display the menu bar,

SEE → 6.4.3 Set Up Touch Panel (page 6-13)

2) Click on the left-side  cell of the menu bar to display the next menu.

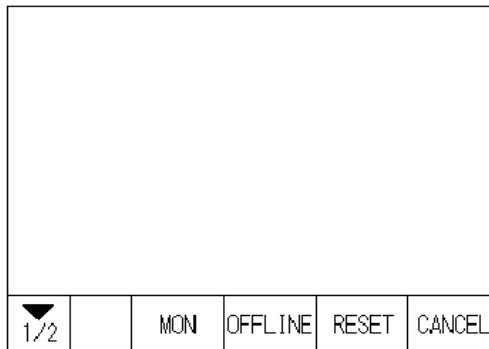

3) The IP Address assigned to the ST will appear in the menu bar.



NOTE

- The IP Address will not be reflected unless ST was reset or power cord was reconnected. After changing “Ethernet Setup” settings, the ST must then be reset or power cord must be reconnected.

Memo

5

OFFLINE Mode

- 5.1 Entering OFFLINE Mode
- 5.2 OFFLINE Mode Main Menu
- 5.3 Initialization
- 5.4 Self-Diagnosis

5.1 Entering OFFLINE Mode

To initialize your ST or perform self-diagnosis, you must first switch the ST to OFFLINE mode. There are two ways to enter OFFLINE mode. First, is immediately after plugging in the ST's power cord, and second, by using the Forced Reset feature.

IMPORTANT

- If the system is not forwarded from the screen editor software to ST when ST is used for the first time after it buys it, it does not put it in an offline mode (initialization).

For more information about DATA TRANSFER

SEE → 4 Data Transfer (Page 4-1) or GP-PRO/PBIII for Windows Device/PLC Connection with the screen editor software).

It is necessary to shift to an offline mode for initialization with ST, and the self-diagnosis, etc. It is possible to enter an offline mode by the following two methods.

5.1.1 After Plugging in the Power Cord

Touch the upper left-hand corner of the ST screen within 10 seconds of plugging in the ST's power cord and the ST will change to OFFLINE mode.

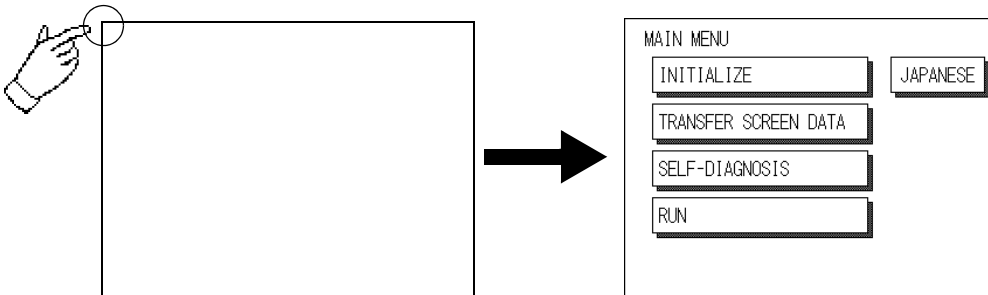

5.1.2 From the Menu Bar

From the ST unit's Menu Bar, touch the OFFLINE square and the OFFLINE mode Main Menu will appear

SEE → 6.4.3 Set Up Touch Panel ■ SYSTEM RESET MODE (Page 6-14)

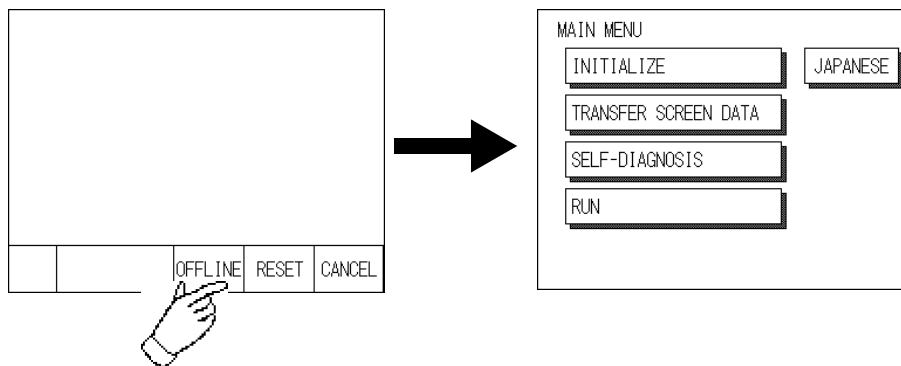

SEE → GP-PRO/PBIII for Windows Device/PLC Connection Manual (included with the screen editor software)

If a Password has been entered in the Initialize/ Set Up System area, before entering the OFFLINE mode, the following screen appears.

Here, enter the password, then touch Set to enter OFFLINE mode.

When Passwords setting

SEE → 6.3.1 System Setup ■ PASSWORD SETUP (Page 6-5)

For more information about ENTERING NUMBER

SEE → 5.3 Initialization ■ Entering Numbers (Page 5-5)

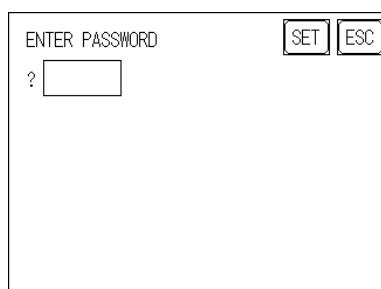

5.2 OFFLINE Mode Main Menu

Each menu item shown below has different settings that must be set to match the corresponding PLC in order for the ST to communicate properly.

Entering OFFLINE mode calls up the following screen.

Select the desired menu item by touching the corresponding screen item bar.

Each Main Menu item is used as follows.

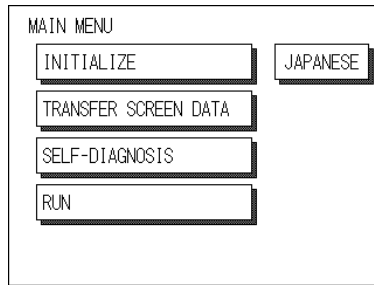

■ INITIALIZE

The setup items contained in this menu are used to control the ST unit.

■ SCREEN DATA TRANSFER

Select to transfer screen data to and from the screen editor software.

■ SELF-DIAGNOSIS

Checks to see if there are any problems with the ST System or Interface (I/F).

■ RUN

Starts ST operation.

■ LANGUAGE CHANGEOVER FUNCTION

When in Japanese display mode, touch the [ENGLISH] button to change to the English display. Similarly, in English display mode, touch the [JAPANESE] button to change to the Japanese display. Default display mode is English.

For more information about INITIALIZE

SEE → 6 *Initializing the ST (Page 6-1)*

For more information about TRANSFER SCREEN DATA

SEE → 4 *Data Transfer (Page 4-1) or GP-PRO/PBIII for Windows Operation Manual (included with the screen editor software)*

For more information about SELF-DIAGNOSIS and RUN

SEE → 7 *RUN Mode and Errors (Page 7-1)*

5.3 Initialization

■ Selecting A Menu

Touch the menu item, or input field to select it.

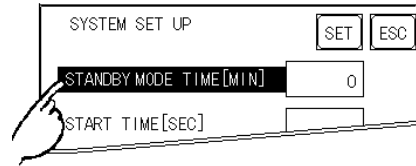
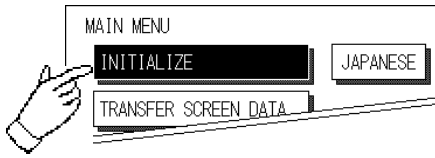

■ Entering Numbers

After selecting an input field by touching it, use the numeric touch keys located at the bottom of the screen to enter numeric values. After inputting each value, touch the [SET] key to define the value.

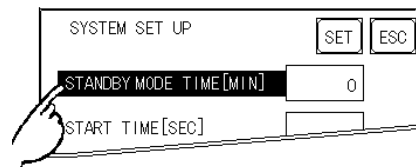
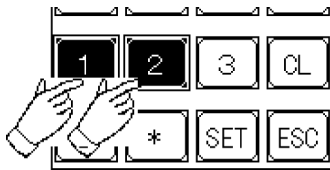

■ Selecting Setup Conditions

After selecting a menu item and entering that area, touch the option you would like to setup. The selected item becomes highlighted. In this example, the TOUCH BUZZER SOUND has been set Off.

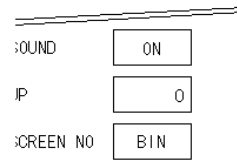
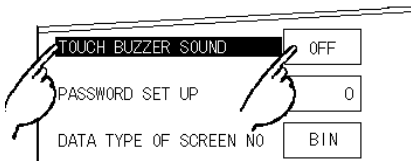

■After All Setting Data is Entered

Touch the top-right [SET] button.

If you wish to exit the screen without saving the changes, touch the CANCEL button.

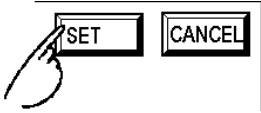

- Press the [SET] key to write the Setup conditions onto the Internal FEPROM, which may take some time, causing a delay in returning to the previous screen. Therefore, do not touch the screen until the previous menu display returns.
- Press the [SET] key to write the Setup conditions onto the Internal FEPROM, and Press the [CANCEL] key to not write the Setup conditions onto the Internal FEPROM and return to the previous menu.

■Return To Previous Screen

Touch the title of the screen you would like to return to.

E.g. To return to the MAIN MENU from the SYS.ENVIRONMENT screen, simply touch the MAIN MENU title.

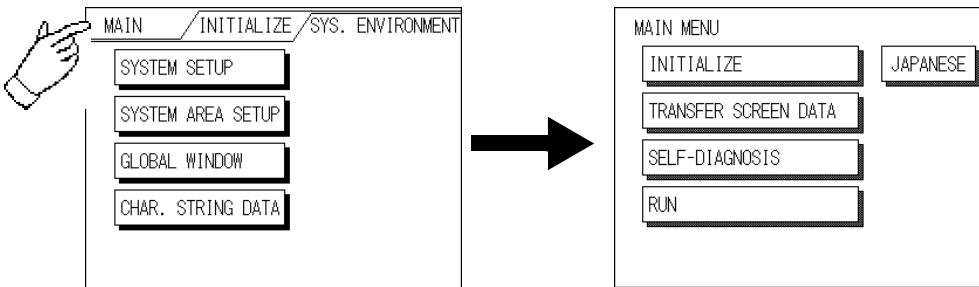

5.4 Self-Diagnosis

■Selecting a Sub-Display

Touch the desired the menu item and that sub-display will appear.

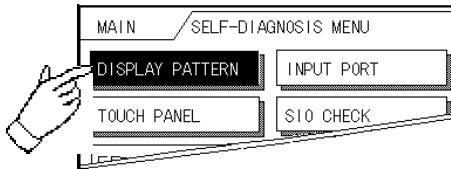

■[SET], [ESC] Keys

After selecting the Self Diagnosis item, the [SET], and [ESC] keys may appear at different times at the top of the screen.

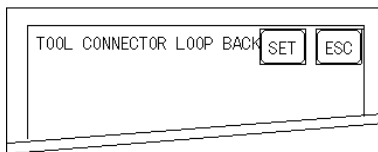

◆[SET] Key

When this key is pressed, your selected Self-Diagnosis test begins.

◆[ESC] Key

When this key is pressed, the selected Self-Diagnosis test is cancelled, and you are returned to the SELF-DIAGNOSIS menu.

■After Check To Return To Self-Diagnosis Menu

◆When OK displays,

Pressing once anywhere on the display screen returns you to the Self-Diagnosis menu.

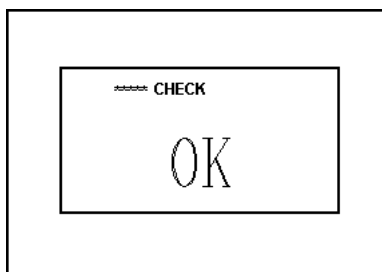

◆When an Error Message displays

To return to the self-diagnosis menu screen when the error message is displayed by the self-diagnosis, it pushes in order in the lower left corner of the displayed screen (1) and the lower right corner (2).

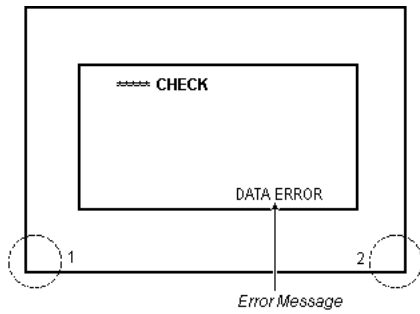

NOTE When the lower left corner is pushed while pushing the lower right corner of the screen (2), the brilliance control is displayed.

SEE → 6.4.3 Set Up Touch Panel ■ BRIGHTNESS ADJUSTMENT (Page 6-15)

■Return To Main Menu

Touch the MAIN Key in the top right corner of the SELF-DIAGNOSIS menu to return to the MAIN MENU.

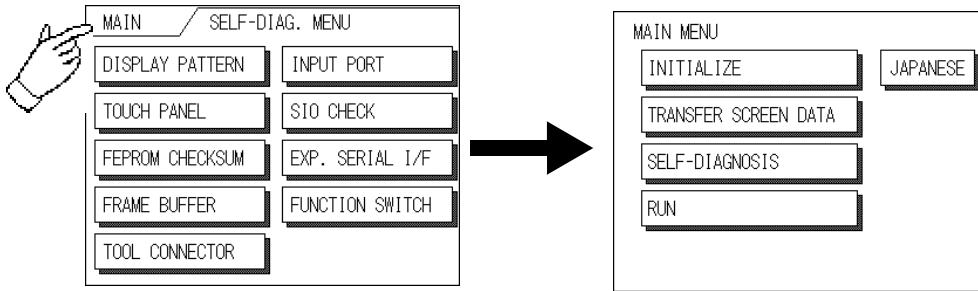

6

Initializing the ST

- 6.1 Initialization Screen
- 6.2 Initialization Items
- 6.3 System Environment Setup
- 6.4 Set Up I/O
- 6.5 PLC Setup
- 6.6 Initialize Internal Memory
- 6.7 Set Up Time
- 6.8 Set Up Screen
- 6.9 Font Setting

6.1 Initialization Screen

Occasionally, you may want to change your ST's general operation settings. The settings used for this are found in the INITIALIZE option in the ST OFFLINE mode's MAIN MENU.

*1 This chapter explains each of the OFFLINE mode's INITIALIZE items. However, there are 2 types of INITIALIZE settings, those for the 1:1 connection and those for the n:1 (multi-link) connection^{*1}.

The n:1 mark appears on original menu items related to n:1 multi-link connection items. If there is no mark, the menu item is common to both 1:1 and n:1 connections.

1:1 A single (1) ST is connected with a single (1) PLC.

n:1 Multiple STs are connected with a single PLC. The STs successively pass a PLC Access Token (exclusive PLC interaction key) among themselves to designate which unit can communicate with the PLC.

NOTE

- If you transfer the ST's system file data to the ST via your screen editor software^{*2}, the ST operates using that data. If the ST System file has been correctly setup and transferred, the setting of INITIALIZE items become unnecessary.

For more information about ST System files,

SEE → *"GP-PRO/PB III for Windows Operation Manual" (included with the screen editor software)*

*1 PLC's that support the n:1 (multi-link) connection are limited.

SEE → *GP-PRO/PB III for Windows Device/PLC Connection Manual" (included with the screen editor software)*

*2 Refer to the screen editor software's "SYSTEM SETTINGS" area.

6.2 Initialization Items

This chapter explains the contents of the Initialize setup items listed below. For information about screen operations and numeric input.

SEE → 5 OFFLINE Mode (Page 5-1)

The INITIALIZE menu includes the following items.

SYSTEM ENVIRONMENT SETUP
SYSTEM SETUP
 System Area SETUP
 Global Window
 CHAR. STRING DATA

INITIALIZE MEMORY
INITIALIZE MEMORY

SET UP I/O
SET UP SIO
 COMM. SETUP
 Set Up I/O
DISPLAY SETUP
PRINTER SETUP
 EXP. SERIAL SETUP
 EXP. SERIAL ENVI.
 COM. PORT SET UP

SETUP TIME

SETUP SCREEN

PLC SETUP MENU*1
 1:1/n:1
PLC SETUP
 STATION SETUP
 CUSTOMIZE SETUP

FONT SETTING

*1 Note that, depending on the Device/PLC type selected, the screens that appear in your screen editor software will vary.

6.3 System Environment Setup

These settings allow you to adjust the ST's operation environment. System Environment SETUP includes the SYSTEM SETUP, SYSTEM DATA AREA, GLOBAL WINDOW SETUP, and CHARACTER STRING DATA SETUP screens.

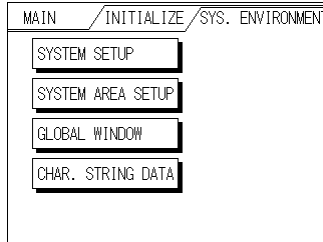

6.3.1 System Setup

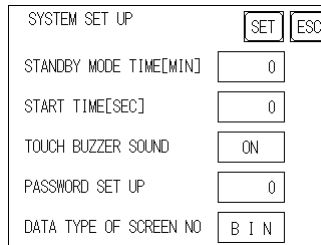

■STAND-BY MODE TIME [MIN]

To extend the life of the ST's backlight, the ST is equipped with a screen saver function that automatically turns the unit's backlight (s) OFF when no operations have occurred for a designated period of time. A "0" entered in this field causes a normal display, i.e. the screen is cleared after the ST's standard default time elapses.

When SYSTEM DATA AREA's SCREEN DISPLAY OFF*1 data is 0000h, and the following operations are not performed on the screen for the User's designated period of time, the ST's current display is turned OFF. (Reference : "GP-PRO/PBIII for Windows Device/PLC Connection Manual" - included with the screen editor software)

- Change Screen
- Touch Screen
- Alarm Messages (scrolling display)
- Error Message Display
- Menu Bar (for forced reset) display

*1 When using the Direct Access or the Memory Link formats, the object address becomes +9 or +12, respectively. (Only when all items are set within the System Data Area.)

SEE → "GP-PRO/PBIII for Windows Device/PLC Connection Manual" (included with the screen creation software)

■ START TIME [SEC]

This setup determines the start-up time of the ST. Use this setup to adjust the power up sequence so that the ST starts up after the PLC.

■ TOUCH BUZZER SOUND

Setup whether or not the ST beeps when pressed.

■ PASSWORD SETUP

The password setting is used when changing to the Initialize Memory or Initialize (OFFLINE mode) Screens. The password (from 0 to 9999) ensures protection of the ST settings, since the use of OFFLINE mode is controlled. If you do not wish to use this feature, enter the default value, 0.

■ DATA TYPE OF SCREEN NO.

This setup controls whether BIN or BCD format numbers are used when making screen changes. Screen numbers 1 to 8999 are available for binary format; screen numbers 1 to 1999 are available for BCD format.

6.3.2 System Area Setup

SYSTEM AREA SETUP is necessary for the PLC to control its ST-related data, and prepares the PLC internal Data Memory (DM) and Data Register (D)*1. Use this setup to prepare the desired SYSTEM DATA AREA items. SYSTEM DATA AREA is located in the LS area of the ST's internal area.

SEE → *GP-PRO/PB III for Windows Device/PLC Connection Manual (included with the screen editor software)*

When using the Memory Link format, this setting is unnecessary.

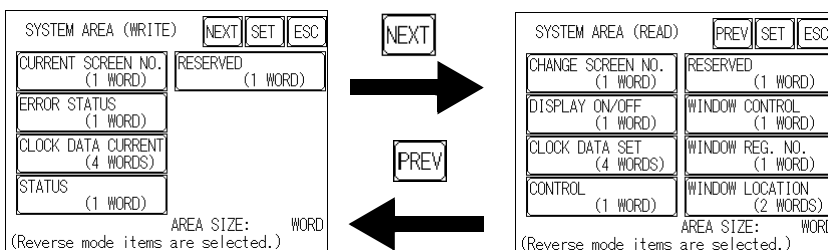

Press the item, and when the item is highlighted, it has been selected.

When you press the Confirm key, the System Area Contents screen appears to confirm the selected items.

◆ System Area Size

This field displays the total number of words used for the items selected from the SYSTEM AREA SETUP (Write and Read).

NOTE

- The setup shown is enabled only when using the Direct Access format.
- The selected System Area items, as displayed on the screen, become the System Data Area.

When these five items, "Current Screen Number", "Error Status", "Clock Data (Current)", "Change Screen Number", and "Display ON/Off", have been selected, word addresses are assigned to each item, in order, as shown here.

SYSTEM AREA CONTENTS		SET	ESC
WORD		WORD	
+0	CURRENT SCREEN NO.	+10	
+1	ERROR STATUS	+11	
+2	CLOCK DATA CURRENT	+12	
+3	CLOCK DATA CURRENT	+13	
+4	CLOCK DATA CURRENT	+14	
+5	CLOCK DATA CURRENT	+15	
+6	CHANGE SCREEN NO.	+16	
+7	DISPLAY ON/OFF	+17	
+8		+18	
+9		+19	

The System DataArea selection process follows this formula [System Data Start Address + n]. For example, if the System Area Start Address was D00200, and the Change Screen Number option had been selected if you refer to the System Area Contents screen displayed above because Change Screen No's address is +6, its word address would be $D00200+6=D00206$.

For information about how to use the System Start Address and Start Address

SEE → 6.5.1 SET UP OPERATION SURROUNDINGS (1:1/n:1) (Page 6-19)

6.3.3 Global Window Setup

The ST unit can display three screens at any one time, one Global Window and two Local Windows. The Global Window is common to all the display screens. The Local Window displays exclusively on the corresponding base screen. The GLOBAL WINDOW SETUP is described here.

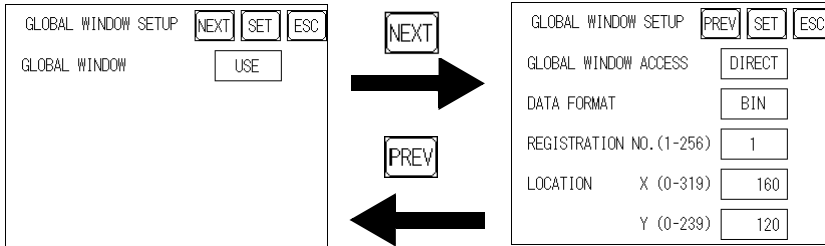

■ GLOBAL WINDOW

There are two options here: Use and Do Not Use. If you select Do Not Use, ignore the items described below. Selecting Use enables these options.

■ GLOBAL WINDOW ACCESS

Use this feature to designate whether a value used is DIRECT or INDIRECT, i.e. the REGISTRATION NO. and the LOCATION values.

When set as Direct, the REGISTRATION NO. and LOCATION selections are fixed to the values entered here. When set to Indirect, the WINDOW REG. NO.'s word address, as prepared in the System Area, is a variable. This means it can have the REGISTRATION NO. written to it and, as a result, multiple window screens can be used as Global windows. You can use this method to adjust the Global window position by writing the X,Y coordinates to the SYSTEM AREA's LOCATION word addresses.

■ DATA FORMAT

Setup whether the REGISTRATION NO. and the LOCATION values are BIN or BCD values. This field is related only to indirect values.

■ REGISTRATION NO. (1-256)

Enter the Window Screen Number used by the Global Window. This field is enabled only when GLOBAL WINDOW ACCESS is set to direct.

NOTE

- The screen editor software allows you to set a window number from 1 to 2000. If you wish to use a number that is 257 or higher, be sure to use the screen editor software to enter this value.

■LOCATION

Enter the value used for the (Global WINDOW) LOCATION. This field is enabled only when GLOBAL WINDOW ACCESS is set to direct.

6.3.4 Character String Data Setup

Character String Data ordering varies from manufacturer to manufacturer. Setup the Character String Data order here to match the corresponding PLC.

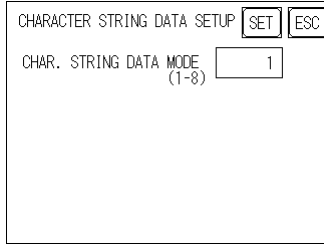

IMPORTANT

- Setup the Character String Data mode to match the PLC type. Device type and Tag settings are unavailable.

■CHARACTER STRING DATA MODE (1-8)

Find the data storage order for your PLC in the table, down below, and setup the CHARACTER STRING DATA MODE.

- (I) Data Device Storage Order
- (II) Internal Word Byte LH/HL Storage Order
- (III) Internal Double-word Word LH/HL Storage Order

◆Character String Data Mode List

(I) Data Device Storage Order	(II) Internal Word, Byte LH/HL Storage Order	(III) Double-word Internal Word LH/HL Storage Order	Character String Data Mode
Storage from Initial data	LH order	LH order	4
		HL order	2
	HL order	LH order	5
		HL order	1
Storage from End data	LH order	LH order	6
		HL order	7
	HL order	LH order	8
		HL order	3

I) Data Device Storage Order

E.g. Characters A B C D E F G H
 □ □ □ □
 ① ② ③ ④

Storage from Start Data

①	D0100
②	D0101
③	D0102
④	D0103

Storage from End Data

④	D0100
③	D0101
②	D0102
①	D0103

II) Word Byte LH/HL Order

E.g. Characters A B C D
 □ □ □ □
 ① ② ③ ④

16 bit Device LH Order

②	①	D0100
④	③	D0101

16 bit Device HL Order

①	②	D0100
③	④	D0101

32 bit Device LH Order

②	①	④	③	D0100
---	---	---	---	-------

32 bit Device HL Order

①	②	③	④	D0100
---	---	---	---	-------

III) Double-word Word LH/HL Order

E.g. Characters A B C D E F G H I J
 □ □ □ □ □ □ □ □
 ① ② ③ ④ ⑤

16 bit Device LH Order

②	D0100
①	D0101
④	D0102
③	D0103
⑤	D0104

16 bit Device HL Order

①	D0100
②	D0101
③	D0102
④	D0103
⑤	D0104

E.g. Characters A B C D E F G H I J K L M N O P Q R S T
 □ □ □ □ □ □ □ □ □ □ □ □ □ □ □ □
 ① ② ③ ④ ⑤ ⑥ ⑦ ⑧ ⑨ ⑩

16 bit Device LH Order

②	①	D0100
④	③	D0101
⑥	⑤	D0102
⑧	⑦	D0103
⑩	⑨	D0104

16 bit Device HL Order

①	②	D0100
③	④	D0101
⑤	⑥	D0102
⑦	⑧	D0103
⑨	⑩	D0104

■ Relationship between K-tag Write Character Value and PLC Device

◆ 16 bit Devices

ST stores the character string from the start, as groups of 2, into 1 PLC Device.

When there are nine characters, they are arranged as shown below.

1 2 3 4 5 6 7 8 9 NULL
└─┘ └─┘ └─┘ └─┘ └─┘

NOTE • When the characters do not divide into 2 evenly, NULL is added at the end.

◆ 32 bit Devices

ST stores the character string from the start, as groups of 4, into 1 PLC Device.

When there are nine characters, they are arranged as shown below.

1 2 3 4 5 6 7 8 9 NULL
└─┘ └─┘ └─┘

NOTE • When the characters do not divide into 4 evenly, NULL is added at the end.

6.4 Set Up I/O

This section describes the communication setup with the Host (PLC) and the setup for any peripheral equipment. The SET UP I/O menu includes the SET UP SIO, COMMUNICATION SETUP, SETUP I/O, DISPLAY SETUP, PRINTER SETUP, EXPANSION SERIAL SETUP, EXPANSION SERIAL ENVIRONMENT SETUP, SET UP CAPTURE OPERATION, FUNCTION SETUP and COMMUNICATION PORT SET UP menus.

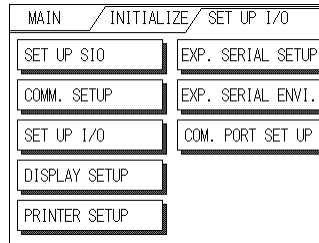

6.4.1 SET UP SIO

This menu runs the settings related to PLC communication. Be sure to match the settings listed below with the SIO setup on the PLC host, if not, an error may occur.



GP-PRO/PBIII for Windows Device/PLC Connection Manual (included with the screen editor software) GP-PRO/PBIII for Windows

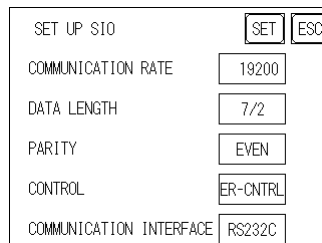

NOTE

- If you have selected "YES" for the [SERIAL I/F CHANGE] on the [COMMUNICATION PORT SETUP] screen, or "Yes" for the [Serial I/F Switch] settings in the [Change Extend SIO Type] command, in the Screen Editor's [Project] menu, do not enter all of the settings related to device communication using the Extended SIO Script Protocol here. ([SET UP SIO] screen) These settings are required to set using the [EXPANSION SERIAL COMMUNICATION SETUP] screen.



6.4.6 Expansion Serial Setup (Page 6-17)

■ COMMUNICATION RATE

The COMMUNICATION RATE (baud rate) is the data communication speed, measured in bits per second (bps), between the ST and PLC. Match the COMMUNICATION RATE values in both the PLC and ST.

Depending on the rate selected, certain PLCs may not be able to be used.

SEE → *GP-PRO/PBIII for Windows Device/PLC Connection Manual (included with the screen editor software)*

■ DATA LENGTH

For data communications, the DATA LENGTH must be set up as 7-bit or 8-bit data, and set up also the STOP BIT as either a 1-bit or 2-bit value.

■ PARITY

Set up whether no parity check, or an odd or even number parity check will take place during communication.

■ CONTROL

Data flow CONTROL prevents the overflow of data sent back and forth. Select either X-CNTRL or ER-CNTRL.

■ COMMUNICATION INTERFACE

These settings are used for data communication.

When using the ST400 unit, select either RS-422 (2-wire) or RS-422 (4-wire).

When using the ST401 unit, the data communication method is fixed at RS-232C. This setting cannot be changed.

When using the ST402 unit, the PLC's protocol setting screen is displayed.

When using the ST403 unit, select one from RS-232C, RS-422 (2-wire) and RS-422 (4-wire).

NOTE

- When using an RS422 cable and the Memory Link format, be sure to select the 4-line option.

SEE → *GP-PRO/PBIII for Windows Device/PLC Connection Manual (included with the screen editor software)*

- If you have selected "Yes" for the [Serial I/F Switch] settings in the [Change Extend SIO Type] command, in the Screen Editor's [Project] menu, be sure to select RS-232C.

6.4.2 Communication Setup

COMMUNICATION SETUP		SET	ESC
RECEIVE TIMEOUT (1-127)	10	SEC	
RETRY COUNT (0-255)	2		

■ RECEIVE TIMEOUT (1-127)

PLC sets the value used for the data reception timeout (PLC-ST).

If the cable is not connected, data communication will Timeout in one second, regardless of this setting's value. The default is "10" seconds.

NOTE

- If you transfer screens when a PLC communication error has occurred and the error is not yet cleared, and the RECEIVE TIMEOUT value is set to 30 seconds or more, an error message may appear on your personal computer.

■ RETRY COUNT (0-255)

Designates how many times the ST tries to send data to the PLC when a PLC communication error occurs.

An Error Message will appear on the ST after the ST tries to send data to the PLC the number of times set by this option. The default is "2".

6.4.3 Set Up Touch Panel

Touch operation and Force Reset setup, and Display Device adjustments are made here. There may be differences on these settings depending of the ST type.

SET UP I/O		SET	ESC
TOUCH OPERATION MODE	2 POINT		
SYSTEM RESET MODE	ON		
CONTRAST SETTING	ON		
BRIGHTNESS SETTING	ON		
SET UP LCD	NORMAL		

■ TOUCH OPERATION MODE

Designates either One Point, Two Point or No Slide. When No Slide is selected, dragging one's finger across the touch screen will elicit no screen response, and only individually selected points will register.

■ SYSTEM RESET MODE

Designates whether to display or hide the Menu Bar. The Menu Bar can be displayed using the following procedure when "ON" is selected

◆ Steps to run SYSTEM RESET

While pressing down on the bottom right corner (1) of the screen, press the upper right corner (2). At the same time, press the bottom left corner (3) to enter the FORCE RESET Operation. To activate Reset, press the RESET button, to transfer to OFFLINE Mode, press OFFLINE.

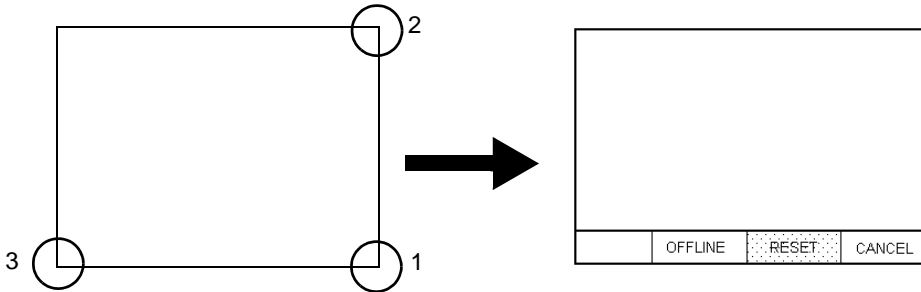

IMPORTANT

- FORCE RESET can occur during either RUN mode or OFFLINE mode.

NOTE

- The SYSTEM RESET mode cannot be entered while the ST is starting up.
- Entering SYSTEM RESET is possible even when RUN operations (PLC <—> ST communication) are not being performed.

■ CONTRAST ADJUSTMENT

When this option is set ON, CONTRAST ADJUSTMENTS can be made through touch input.

NOTE

- Be sure to press the ST corners in the order shown. If only corner (2) is pressed OFFLINE mode will start.

While pressing the upper right hand corner (1) of the screen, press the upper left corner (2) to enter CONTRAST ADJUSTMENT mode. Press the desired setting and the screen's contrast will change accordingly.

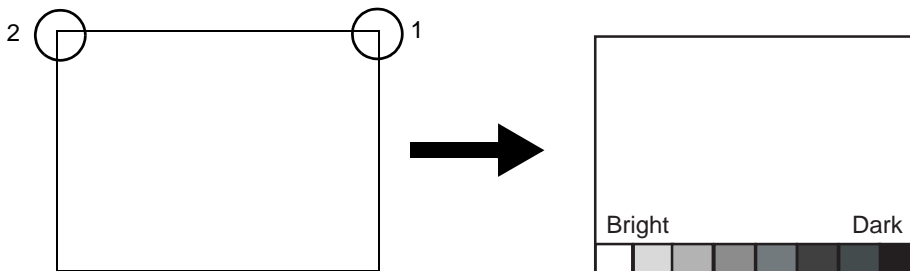

NOTE

- To end CONTRAST ADJUSTMENT mode, touch anywhere on the screen, except the bottom section.
- CONTRAST ADJUSTMENT mode cannot be entered while waiting for ST to start up.
- CONTRAST ADJUSTMENTS can be made even in the middle of RUN mode (PLC<—>ST communication).
- Regardless of a normal and reversed display, the left side of the contrast adjustment bar, displayed at the bottom area of the screen, is always "Bright".

■ BRIGHTNESS ADJUSTMENT

When set to ON, brightness ADJUSTMENT can be performed via touch input. Press the bottom left corner (2) of the screen while holding down the bottom right corner (1) to enter brightness ADJUSTMENT mode. Touch the left-side of the bar to brighten the display; touch the right-side of the bar to dim the display. This unit has two levels of adjustment.

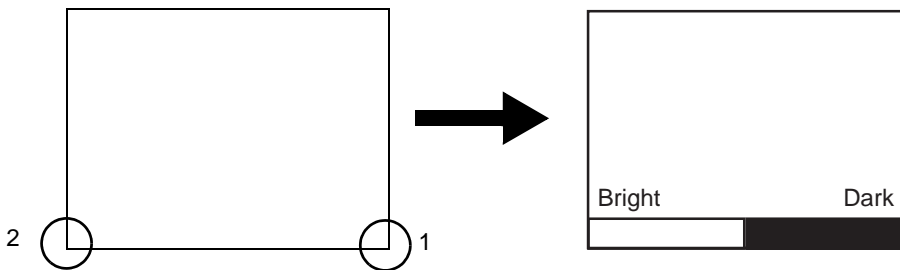
**NOTE**

- With the ST units, reducing the display brightness may cause flicker. Adjust it by changing the display device settings.
SEE → 6.4.4 Display Setup (Page 6-16)
- To end brightness ADJUSTMENT mode, touch anywhere on the screen, except the bottom section.
- Brightness ADJUSTMENT mode cannot be entered while the ST is starting up.
- Brightness ADJUSTMENT can be used even during RUN mode (PLC<-->ST communication).
- Regardless of a normal and reversed display, the left side of the contrast adjustment bar, displayed at the bottom area of the screen, is always "Bright".
- Brightness of red in ST403 cannot be adjusted.

■SET UP LCD

To reverse the screen display colors, touch SET UP LCD on the SET UP I/O screen to change the setting from "NORMAL" to "REVERSE", and then touch the "SET" key. The display color will be reversed and the previous screen will reappear.

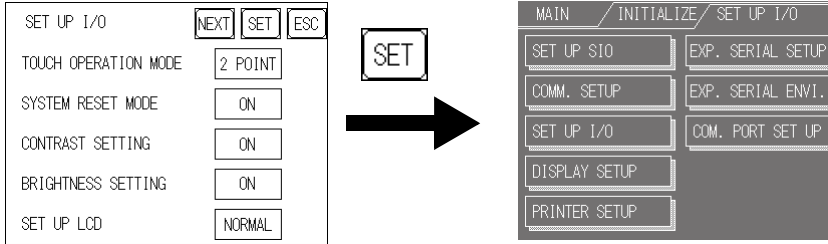

6.4.4 Display Setup

The ST unit's screen may flicker, or there may be shadows appearing on extended display lines on the LCD surface. In the case where the ST unit's ambient temperature becomes high, and its current brightness level is set to low, this effect may be more pronounced. This phenomenon is however, a common attribute of LCDs and is not a defect. To solve this, use this setting for adjusting the ST unit's brightness.

Monochrome LCD

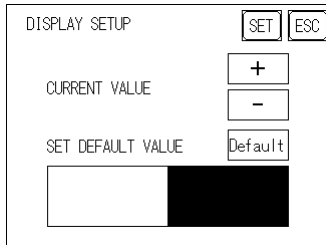

<When using Black and White>

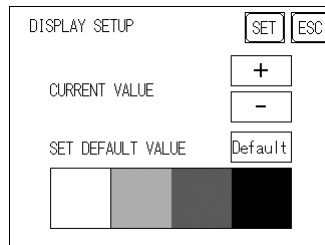

<When using 8 levels of gray>

■CURRENT VALUE

To solve the above problem, touch "+" or "-" to adjust the brightness. You can check the actual brightness in the preview field at the bottom of the screen. From the default value of "0" there are 18 "+" levels and 2 "-" levels available.

■SET DEFAULT VALUE

If you touch "Default", the setting returns to "0".

6.4.5 Printer Setup

This feature is not available.

6.4.6 Expansion Serial Setup

The following explains the setup for communicating with a device connected to the Expansion Serial Interface. This setup screen will not display unless the communication protocol for the Expansion Serial Interface (specified with “SET UP EXPANSION SIO” of the screen editor software) is transferred to the ST.

EXP. SERIAL SETUP	<input type="button" value="SET"/>	<input type="button" value="ESC"/>
COMMUNICATION RATE	<input type="text"/>	
DATA LENGTH	<input type="text"/>	
PARITY	<input type="text"/>	
RI/VCC (COM2)	<input type="text"/>	
COMMUNICATION FORMAT	<input type="text"/>	

■ COMMUNICATION RATE

The COMMUNICATION RATE refers to the data communication speed, measured in bits per second (bps), between the ST and the device connected to the Expansion Serial Interface.

The supported communication rates vary depending on the connected device. Refer to the instruction manual of the connected device for more information. The initial setting varies depending on the communication protocol for the Expansion Serial Interface being transferred.

■ DATA LENGTH

Set the DATA LENGTH to 7-bit or 8-bit data, and set up also the STOP BIT as either a 1-bit or 2-bit value.

■ PARITY

Set the parity to no parity (OFF), to ODD or to EVEN parity check.

■ RI/VCC (COM2)

This setting is fixed at RI and cannot be changed.

■ COMMUNICATION FORMAT

Set the communication format. When using ST402 unit, select either RS-422 (4 line) or RS-422 (2 line).

6.4.7 Expansion Serial Environment Setup

Can only display the setting data entered in the screen editor software. This data cannot be changed.

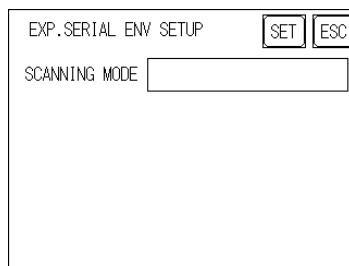

The screenshot shows a terminal window titled "EXP. SERIAL ENV SETUP". In the top right corner, there are two buttons labeled "SET" and "ESC". Below the title, the text "SCANNING MODE" is followed by a rectangular input field that is currently empty.

6.4.8 COMMUNICATION PORT SETUP

This feature is not available.

6.5 PLC Setup

Set up the ST System Area and the Unit number in this screen. Because 1:1 and n:1 ST connections utilize different settings, confirm your connection's needs before using any settings.

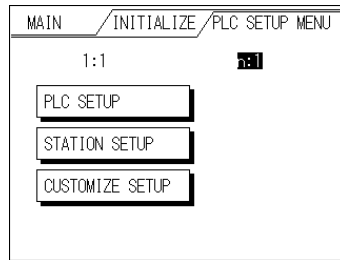

NOTE

- The screens that appear will depend on the PLC type you selected in the screen editor software.
SEE → *GP-PRO/PBIII for Windows Device/PLC Connection Manual (included with the screen editor software)*
- When the GP-PRO/PBIII for Windows Ver 3.0 "Simulation" feature is used, the SET UP OPERATION SURROUNDINGS menu cannot be used.

6.5.1 SET UP OPERATION SURROUNDINGS (1:1/n:1)

Enter the PLC System Data Area and the Unit Number settings here. The same options are available for both 1:1 and n:1 (Multi-link) connections.

For an n:1 (Multi-link) Connection, System Data Area settings must be setup for each ST connected to the PLC.

SEE →

GP-PRO/PBIII for Windows PLC Connection Manual (included with the screen editor software)

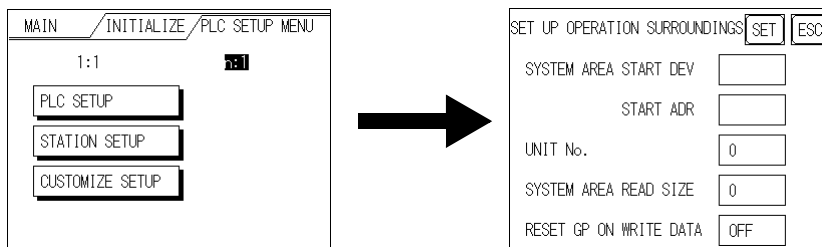

■ SYSTEM AREA START DEV/START ADR

Setup the System Data Area's Start Address. Device addresses that can be allocated will differ depending on the type of PLC used.

SEE →

GP-PRO/PBIII for Windows Device/PLC Connection Manual (included with the screen editor software)

■UNIT No.

Enter the PLC Unit number here. Check that it matches the one set up in the PLC.

■SYSTEM AREA READING

When using a Block Display Trend Graph, setup the Reading Area Size (in word units) to match the Trend Graph's data size. Use this feature when you wish to allocate the Reading Area in the PLC Data Register (D), or Data Memory (DM).

NOTE

- If you are not using the Reading Area, leave the 0 default values intact. This will allow you to perform high speed data communication.

■RESET ST ON WRITE DATA

Designates the mode which enables you to cancel the error from the error display when the Write error occurs.

6.5.2 Station Setup (n:1)

The STATION SETUP, necessary for the n:1 (Multi-link) setup, checks whether correct communications run with the connected ST System configuration.

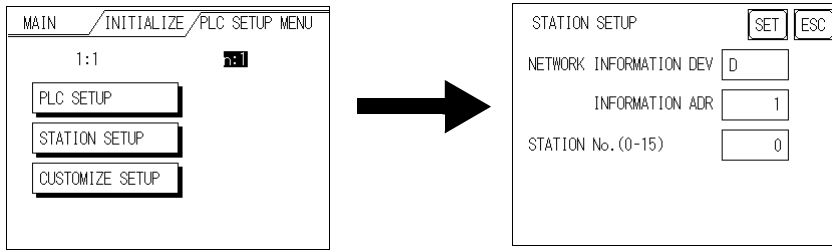

■NETWORK INFORMATION (DEV/ADR)

In the n:1 (multi-link) connection, the Network Information uses 2 words in its correspondences. These two (2) words consist of a Connection List and a Validation List (described later in this section). These areas are automatically allocated in the PLC's Data Register (D) or Data Memory (DM). The devices that can be allocated will vary depending on the type of PLC.

SEE →

GP-PRO/PBIII for Windows Device/PLC Connection Manual (included with the screen editor software)

PLC Data Register		
+0	Connection List	PLC → ST
+1	Validation List	ST → PLC

IMPORTANT

- In the NETWORK INFORMATION ADR, setup the same address to all the ST's connected to the same link unit. Furthermore, when there are 2 ports in the connected link unit, do not make them the same address.

■ STATION NO. (0-15)

This is the setup for the ST Station Number mentioned above. The setup range is from 0 to 15, and the only other restriction is the ST STATION NO. must be unique in the system. If STATION NO.'s are repeated, a COMMUNICATION ERROR occurs.

NOTE

- The STATION NO. is the number allocated to the particular ST unit. This number is not related to the Link Unit Machine number.

6.5.3 Customize Setup (n:1)

The Customize function modifies the n:1 (Multi-link) connection's communication method to make it more effective. To run communication efficiently, the user should first determine whether they wish to have Operation or Display priority set for the ST. Based on this, the communication response speed can be upgraded. (However, this also depends on the screen information displayed.)

■ PLC PRIORITY

According to how the ST is used, select either Operation priority (OPE.) or Display priority.

• iOperation

Setup the ST to this option when using the ST mainly as an operation panel. As a result, the ST will command better touch panel numeric input and switch response times.

Leaving the ST in this mode does not drastically influence the touch panel operation response time of other STs. The screen display renewal cycle, however, will slow.

• iDisplay

Setup the ST to this option when using the ST mainly as a monitor screen.

The ST will command a higher display speed as a result; however, the response time for the touch panel's operations will slow.

IMPORTANT

- In a standard network setup, use the same setup for all connected ST's.
- To increase the display speed, be sure the addresses used are consecutive addresses. When bit addresses are used, use consecutive to the word units.
- Speed Difference between Display Priority and Operation Priority
When using the Mitsubishi Electric Corp. A3A PLC, with a scan time of 20ms with consecutive addresses (80 words, not including in the System Area), the difference in reading speed is as shown in the following graphs.

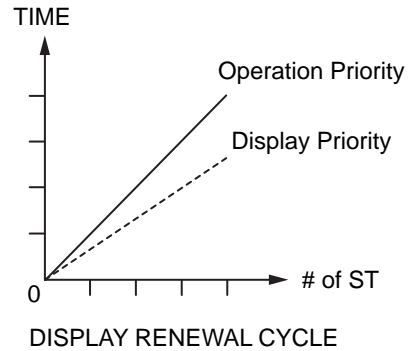
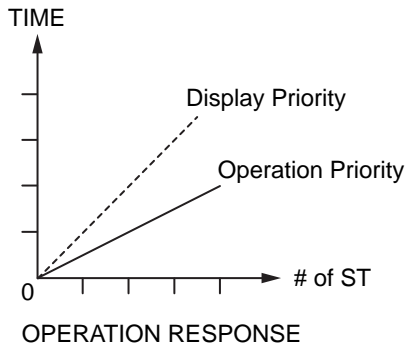

■ ST TOUCH MONOPOLIZE

The monopolizing of touch panel use can be set ON or OFF. When you want to use the PLC exclusively with a Momentary operation setup on the touch panel, turn ST TOUCH MONOPOLIZE ON.

When this setup is ON, the touch panel uses the PLC exclusively whenever the momentary operation setup on the panel is pressed. In this way, you can use the inching operation with a momentary switch. When you stop pressing the panel, exclusive use ends.

For more information about PLC exclusively

SEE → *GP-PRO/PBIII for Windows Device/PLC Connection Manual (included with the screen editor software)*

■ MONOPOLIZE TIME (0 to 2550s)

This field controls the length of time for the monopolize process when no other touch panel operations are performed. The Monopolize process begins when the System Data Area's 7th bit of word address LS14 turns ON, and ends either when the bit turns OFF, or when the time set here elapses.

NOTE

- Pressing the touch panel in the middle of the monopolize process interrupts the MONOPOLIZE TIME function, and ends exclusive use.
- When MONOPOLIZE TIME is set to 0, the monopolize function does not end automatically.

For further information about the contents of System Data Area LS6 (status) and LS14 (control),

SEE → *GP-PRO/PBIII for Windows Device/PLC Connection Manual (included with the screen editor software)*

6.5.4 Ethernet Setup

This menu is for Ethernet settings. This information is used as setting data during ST setup or screen transfer, or, if the Pro-Server software is used, for the 2-Way Driver.

(Only ST403 unit.)

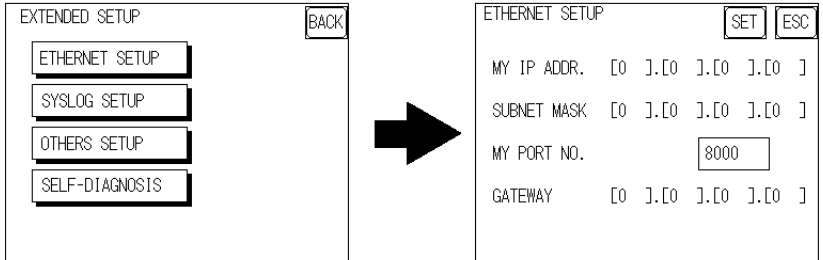

IMPORTANT

- Enter the “ETHERNET SETUP” settings after receiving information from your network’s system administrator.
- Be sure to enter a unique IP address, not one used for other STs or by the host.

■ MY IP ADDRESS

Sets up the ST’s IP address. The IP address is 32 bits and designated in four 8-bit units, entered in decimal.

NOTE

- To use Ethernet networking, click on [Initial Settings], [PLC Setup], [PLC Setup] and [Ethernet Setup].

■ SUBNET MASK

Sets the subnet mask. If you are not using a subnet mask, designate “0”.

NOTE

- To use Ethernet networking, click on [Initial Settings], [PLC Setup], [PLC Setup] and [Ethernet Setup].

■ MY PORT NO.

Sets the 2-Way Driver Port No. using a value from 1025 to 65526. Starting from the value entered here, a total of 10 consecutive ports can be used. The default setting is [8000].

NOTE

- To use Ethernet networking, click on [Initial Settings], [PLC Setup], [PLC Setup] and [Ethernet Setup] and select the corresponding Ethernet protocol Port No.

■ GATEWAY

Sets up the gateway's IP address. Only a single gateway can be set up. If you are not using a gateway, enter "0".

NOTE

- To use Ethernet networking, click on [Initial Settings], [PLC Setup], [PLC Setup] and [Ethernet Setup].

6.5.5 SYSLOG Setup

These settings are used for outputting 2-Way driver's operation logs. Therefore, if you are not using the Pro-Server software, these settings are not necessary. (Only ST unit.)

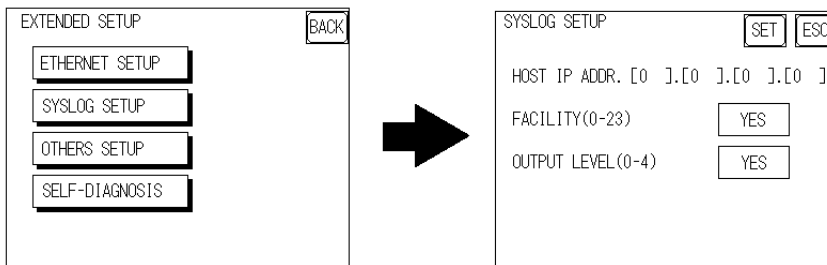

■ HOST IP ADDRESS

Sets up the IP address of the host computer, where the 2-Way driver's operation logs will be output.

■ FACILITY (0-23)

Sets up the facility.

■ OUTPUT LEVEL (0-4)

Sets up the output level.

For details about Pro-Server and SYSLOG,

SEE →

Pro-Server with Pro-Studio for Windows Operation Manual (included in the Pro-Server with Pro-Studio for Windows software package)

6.5.6 Others Setup

Designates the ST operation performed when a 2-Way driver error occurs.

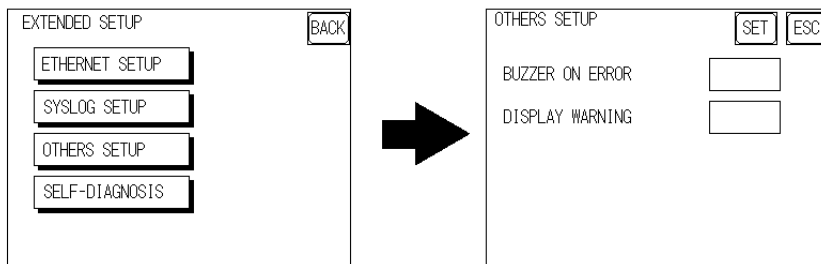

■BUZZER ON ERROR

Enables/disables the buzzer sound output produced when an error related to the 2-Way driver operation occurs.

■DISPLAY WARNING

Enables/disables the warning message display used when an error related to the 2-Way driver operation occurs.

6.5.7 Self-Diagnosis

Runs the Self Diagnosis program for the Ethernet operation. The ST must be connected to the Ethernet network prior to running this program. (Only ST403 unit.)

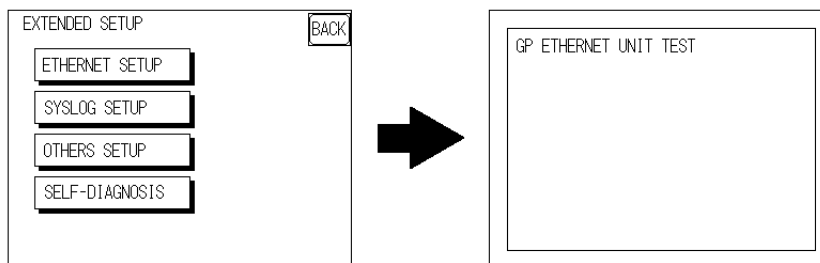

When there is no error detected, the message "OK" will appear. If an error is detected, the message "NG" will appear.

Be sure that this Self Diagnosis program is used only for the Ethernet operation. If you wish to run the general Self Diagnosis program, use [Main Menu]'s [Self Diagnosis] feature.

SEE → 7.2 Self-Diagnosis (Page 7-4)

6.6 Initialize Internal Memory

This section explains how to initialize the ST's internal data.

6.6.1 Initialize ST Memory

This command erases all the ST screen data and initializes the ST's SRAM.

IMPORTANT

- You cannot cancel the Initialization procedure after pressing the Start key.
- All backed up data in SRAM is lost.
- Initialization does not erase the SYSTEM SET UP, the SIO protocol, or the internal clock settings.

```
INITIALIZE MEMORY [ESC]
WARNING : PREVIOUS DATA WILL
                BE OVERWRITTEN !
ENTER PASSWORD AND PRESS
START KEY    ? [ ]
                [START]
```

To initialize the ST internal memory, enter the common password 1101, or the password entered in the SYSTEM SET UP screen.

For details about entering password numeric values,

SEE →

5.3 Initialization (Page 5-5)

NOTE

- The time required for Initialization is between 10 and 20 seconds.

6.7 Set Up Time

Sets the ST's internal clock.

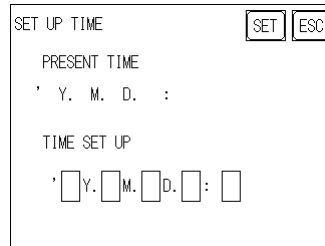

SET UP TIME [SET] [ESC]

PRESENT TIME
' Y. M. D. :

TIME SET UP
' [] Y. [] M. [] D. [] : []

■ SET UP TIME

Enter date and time corrections to the date and time displayed in the PRESENT TIME.

NOTE

- The ST's internal clock has a slight error. At normal operating temperatures and conditions, with the ST operating from its lithium battery, the degree of error is 65 seconds per month. Variations in operating conditions and battery life can cause this error to vary from +65 to -350 seconds per month. For systems where this degree of error will be a problem, the user should be sure to monitor this error and make adjustments when required.

6.8 Set Up Screen

The initial screen display upon powering up, the character size when in RUN mode, and other general screen items are setup here.

SET UP SCREEN		SET	ESC
INITIAL SCREEN NO.	B	1	
ALARM MESSAGE V SIZE		1	
H SIZE		1	
ONLINE ERROR DISPLAY		ON	

■ INITIAL SCREEN NO.

Set up the screen file number that will display first upon powering up. If the BIN option for DATA TYPE OF SCREEN NO in SYSTEM SET UP had been selected, enter a number from 1 to 8999. Or, if BCD was the option set up, then input a number from 1 to 1999.

■ ALARM MESSAGE

Set up the character size of the Alarm Message when the Alarm Bulletin is activated.

<When using syngle-byte characters>

1	2	4
V size=1; H size=1 16 x 8 pixels	V size=2; H size=2 32 x 16 pixels	V size=4; H size=4 64 x 32 pixels

<When using double-byte characters>

V size=1; H size=1 16 x 16 pixels	V size=2; H size=2 32 x 32 pixels	V size=4; H size=4 64 x 64 pixels
--------------------------------------	--------------------------------------	--------------------------------------

■ ONLINE ERROR DISPLAY

Set up whether or not error messages display during RUN mode.

6.9 Font Setting

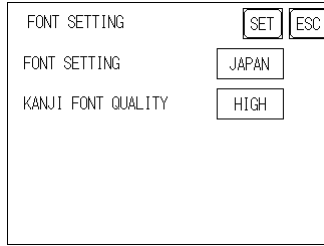

■FONT SETTING

Selects the font type displayed on the ST screen during operation.

■KANJI FONT QUALITY

Designates the font display quality for enlarged characters.

◆When [FONT SETTING] is set to [JAPAN]

Single-byte characters will remain 8x16-dot characters when they are enlarged. Double-byte characters are displayed as:

[Standard]	Here, characters are displayed using 16x16-dot "blocks". When enlarged, this font will remain a 16x16-dot character.
[HIGH(1)]	When enlarged to double size, Level 1 JIS Kanji Code characters are displayed as 32x32-dot characters. Level 2 JIS Kanji Code characters remain 16x16-dot characters.
[HIGH(1,2)]	When enlarged to double size, both Level 1 and Level 2 JIS Kanji Code characters are displayed as 32x32-dot characters.

◆When [FONT SETTING] is set to any other type (i.e. CHINESE, I-ASCII, KOREA or TAIWAN)

[Standard]	Half-size (single-byte) characters are displayed as 16x8-dot characters. Full-size characters, regardless of the display size used, will always be displayed as 16x16-dot characters. When enlarged, this font will stay as 16x16-dot character.
[HIGH(1)]	All half-size (single-byte) characters (ASCII code: 21h to 7Dh, i.e. alphanumeric characters) except " ^ " and " ' " will display as high quality characters. -16x16-dot or larger characters will display as high quality 16x16 fonts. -32x32 or larger characters will display as high quality 32x32 fonts. Full-sized (double-byte) characters will display as 16x16-dot characters and remain 16x16-dot characters when enlarged.
[HIGH(1,2)]	All single-byte characters (ASCII code: 21h to 7Dh, i.e. alphanumeric characters) except " ^ " and " ' " will display as high quality characters. When 16x16 dots are used for a character, it will display as a high quality 16x16 character. -When 32x32 or larger dots are used for a character, the character will display as a high quality 32x32-character. Full-sized (double-byte) characters (i.e. [KOREA], [TAIWANESE] and [CHINESE]) will display as 32x32-dot characters when enlarged to 32x32-dot or larger characters.

7

RUN Mode and Errors

- 7.1 RUN Mode
- 7.2 Self-Diagnosis
- 7.3 Troubleshooting
- 7.4 Error Messages
- 7.5 Error Message Details

7.1 RUN Mode

There are two ways of entering the ST's RUN mode; immediately after plugging in the unit's power cord, or from the ST's OFFLINE mode.

7.1.1 After Connecting the Power Cord

The method of ST startup will vary, depending on the "START TIME" setting in the "Initialization Settings" / "System Setup" area.

■ When START TIME is set to "0"

When the ST's power cord is connected, the version information screen shown below will appear. Next, the screen designated by the initialization screen file number ("Initialization Settings" / "System Setup" area) will appear, and the ST will start to communicate with the PLC.

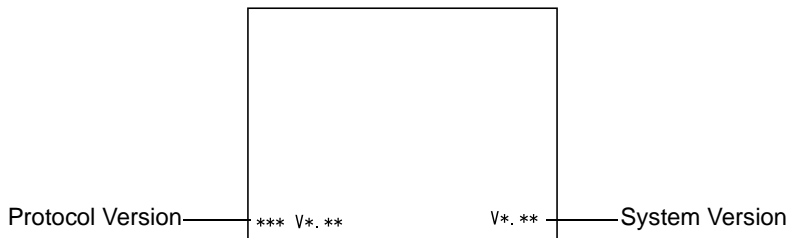

■ When START TIME is set to any value other than "0"

In this case, when the ST's power cord is connected, the following version information screen will appear. In the top right corner of the screen, a value will appear and count down the number of seconds designated by the "START TIME" setting. Next, the screen designated by the initialization screen file number ("Initialization Settings" / "System Setup" area) will appear, and the ST will start to communicate with the PLC.

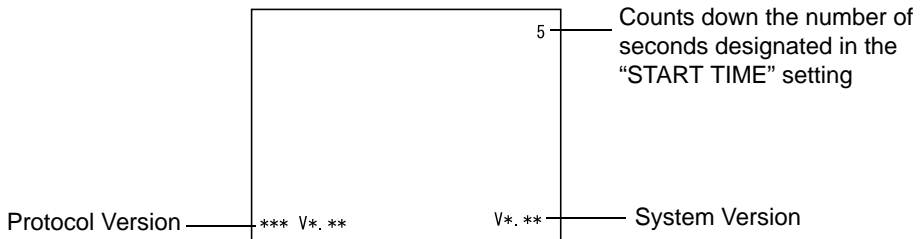

If the initialization screen's file number is not designated, or a number is designated that does not exist, the version information screen will remain.

- NOTE**
- There is a possibility that the screens shown above may not display in the beginning depending on the display device's start-up time.

7.1.2 Via OFFLINE Mode

Touch the MAIN MENU's RUN selection to start your downloaded "project". The INITIALIZE area's SET UP SCREEN feature designates the first screen that appears in RUN mode, and, after this screen appears, communication with the PLC begins. If, however, the designated initial screen has not been created, or does not exist, the above display will remain.

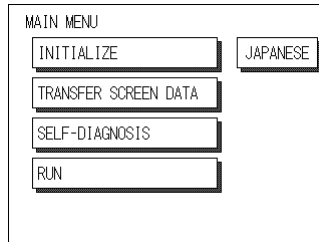

NOTE

- To enter OFFLINE Mode, simply touch the top left corner of the ST's screen within 10 seconds after connecting the ST's power cord.

IMPORTANT

- After powering up the ST, the initial screen that appears is equipped with a built-in (invisible) switch in the top left corner. Touch this switch within 10 seconds to change the ST from RUN to OFFLINE mode.

E.g.

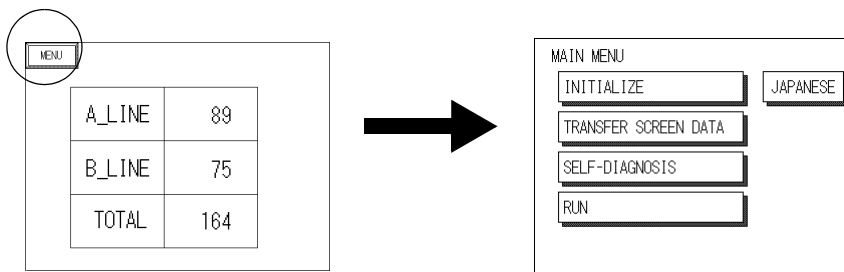

7.2 Self-Diagnosis

The ST unit is equipped with a number of self-diagnosis features used to check its System and Interfaces for any problems.

7.2.1 Self-Diagnosis Item List

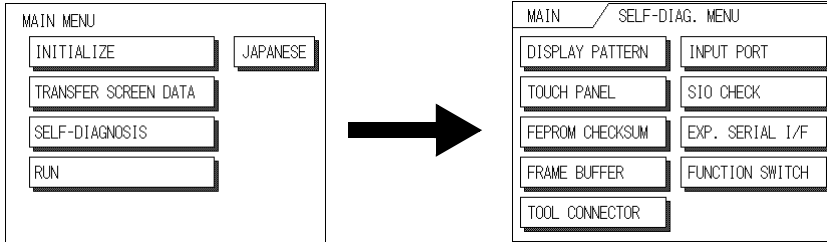

- Checks all the figures and tiling patterns.
- Checks each ST touch panel square.
- Checks the System and Protocol of the ST Internal Memory (FEPRM).
- Checks the internal display memory (Frame Buffer).
- Checks the Tool Connector control lines and send/receive lines. *1
- Checks the Input Port (for Digital's maintenance use only).
- Checks the RS-232C and RS-422 send/receive lines. *1
- Checks the status of the Expansion Serial I/F. (Only for ST402) *1
- Checks the Function Switch.

The following pages explain each item's details.

*1 This item requires the use of special equipment (cable, connector, etc.).

7.2.2 Self-Diagnosis - Details

This section explains the contents of SELF-DIAGNOSIS.

For information on how to operate the Screen,

SEE → 5 OFFLINE Mode (Page 5-1)

for information about how to set up the Special Tools,

SEE → 3 Installation and Wiring (Page 3-1)

■ DISPLAY PATTERN

Used when the buzzer will not sound and when the device contents will not display correctly to check the drawing function. It does this by running checks on the various screen pattern displays (8 screens), the ON/OFF Display, and KANJIROM CHECKSUM. When the ON/OFF Display is checked, the Buzzer ON/OFF check is run simultaneously. If KANJIROM CHECKSUM is normal, **OK** displays; if there is a problem, **NG** displays.

■ TOUCH PANEL

Touch Panel check. Checks if each touch cell highlights when pressed.

■ INTERNAL FEPRM CHECKSUM (System + Protocol)

The Internal FEPRM System and Protocol check searches for any problems that may arise during operations. When running the check, the screen will change as follows.

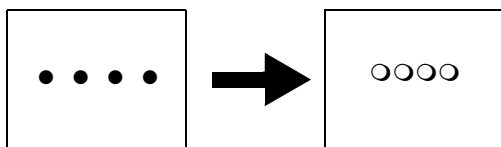

When the FEPRM is normal, **OK** displays; if there is a problem, the screen stops in the middle of operation.

This check does not erase the System or Protocol.

■ FRAME BUFFER

The Frame Buffer (display memory) Check looks for any display problems that may develop. When everything is normal, **OK** displays; when there is a problem, an error message displays.

■ TOOL CONNECTOR LOOP BACK

Use the Tool Connector Control line and Send/Receive line check when the ST cannot send and receive data from the PC. To run the check, connecting a Tool Connector Check Loop Back Cable (Dsub9 pin, pin-side) mounted to the Transfer Cable (GPW-CB02) is necessary.

When everything is normal, OK displays; when there is a problem, an error message displays.

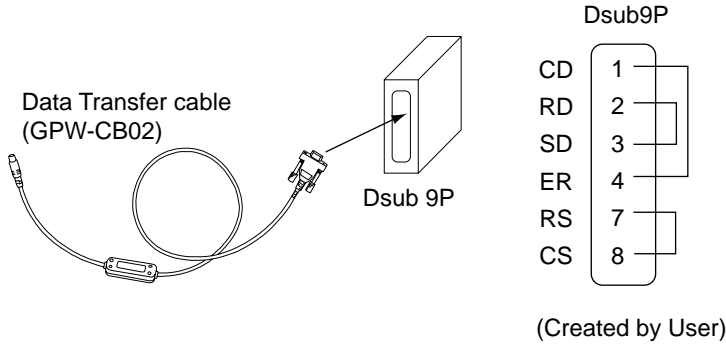

IMPORTANT • This check cannot be performed using the Transfer Cable(GPW-CB03).

■ INPUT PORT

Used for Digital's maintenance.

■ SIO CHECK

Checks the RS-232C and RS-422 SIO lines for areas where communication problems develop. In the menu, select which check to run. To run the check, connecting the SIO cable is necessary. If all is normal, OK displays; if there is a problem, an error message appears.

The SIO cable wiring is as shown below. (RS-232C, RS-422 common)

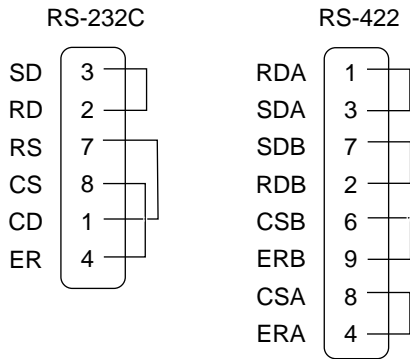

IMPORTANT • This check cannot be done with RS-485(MPI).

■ EXPANSION SERIAL I/F

Checks the Send/Receive line of the Expansion Serial Interface when an abnormality occurs. To run the check, you must connect the SIO cable. If all is normal, the message [OK] appears. If there is a problem, an error message appears.

(Only ST402 unit have this feature.)

The SIO cable wiring is as shown below.

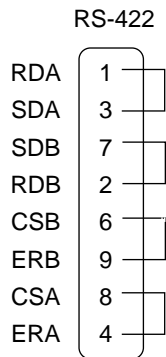

■ FUNCTION SWITCH

Check the Function key. Check that each self-diagnosis button's screen area lights correctly.

7.3 Troubleshooting

This section describes how to find and resolve problems that may occur on the ST. If there is a problem with the PLC, please refer to the corresponding PLC manual.

7.3.1 Possible Types of Trouble

The following items are problems that may occur while using this unit.

(1) No Display

The screen will not display even when the unit is powered ON. Also, during RUN mode, the screen display disappears.

(2) No ST/Host Communication

The ST unit cannot read data from the host. An error message may appear on the screen as a result.

SEE → 7.4 Error Messages (Page 7-15)

(3) Touch Panel Does Not Respond

The touch panel does not react when pressed, or the reaction time is very slow.

(4) Buzzer Sounds when ST power is turned ON

The ST goes to the OFFLINE mode unexpectedly while operating, or the ST automatically goes to the OFFLINE mode when the power is turned ON.

(5) Clock Settings Cannot be Entered

Even after clock settings are entered, the ST unit's clock settings remain eg.00/01/01.

(6) OFFLINE displays During RUN Mode

The ST's buzzer will sound intermittently after power is first turned ON.

For these first five problems, see the troubleshooting tables on the following pages.

For the last problem (6), a SYSTEM ERROR may have developed while displaying the OFFLINE mode screen.

SEE → 7.5 Error Message Details (Page 7-17)

Be sure that no object has touched the screen accidentally if the ST goes to the OFFLINE mode without displaying an error message when the power turned ON. If any object may have possibly touched the top left corner of the screen within 10 seconds after the power turned ON, that may cause the ST to go OFFLINE.

7.3.2 No Display

Follow the flowchart below when the screen does not display when powering up, or the screen turns OFF by itself during RUN mode, to find an appropriate solution.

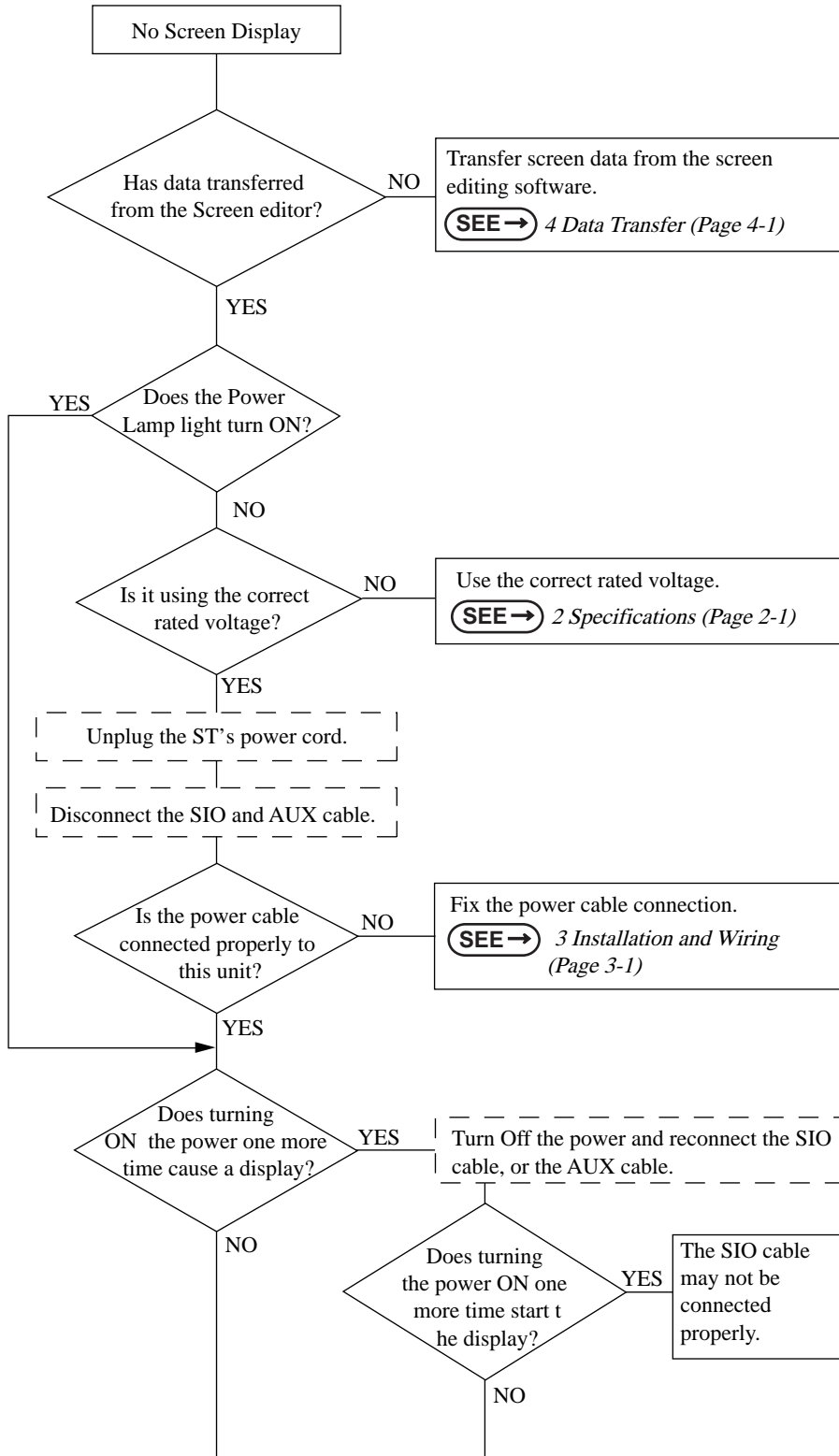

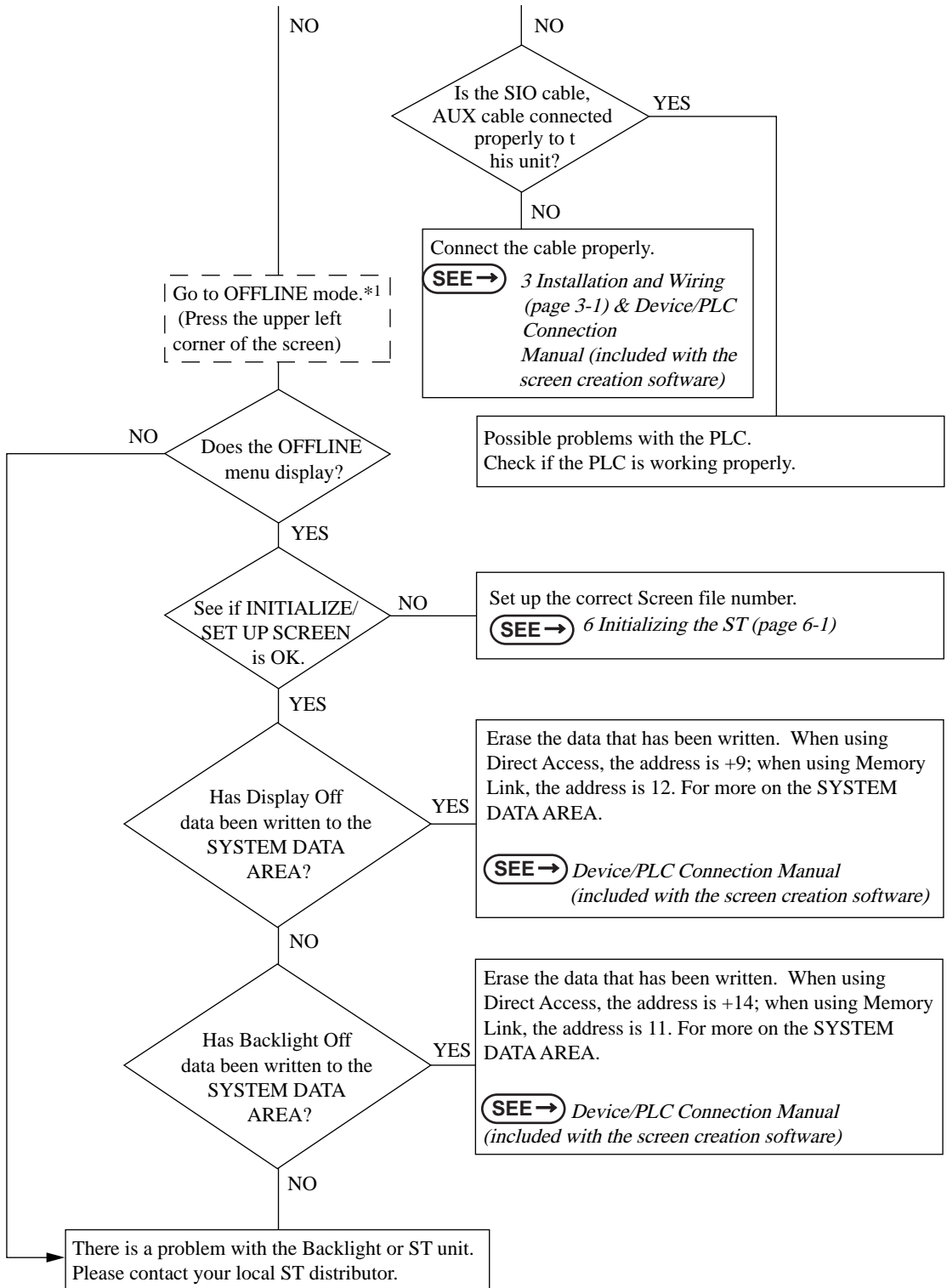

*1 To make the OFFLINE screen appear, turn the power OFF, then ON, and press the upper left corner of the screen within 10 seconds.

7.3.3 No ST/Host Communication

When the ST will not communicate with the host PLC, follow the flowchart below to find both the cause of the problem and a suitable response.

Or, if an error message displays on the screen, check the error code to find the appropriate solution.

SEE → 7.4 Error Messages (Page 7-15)

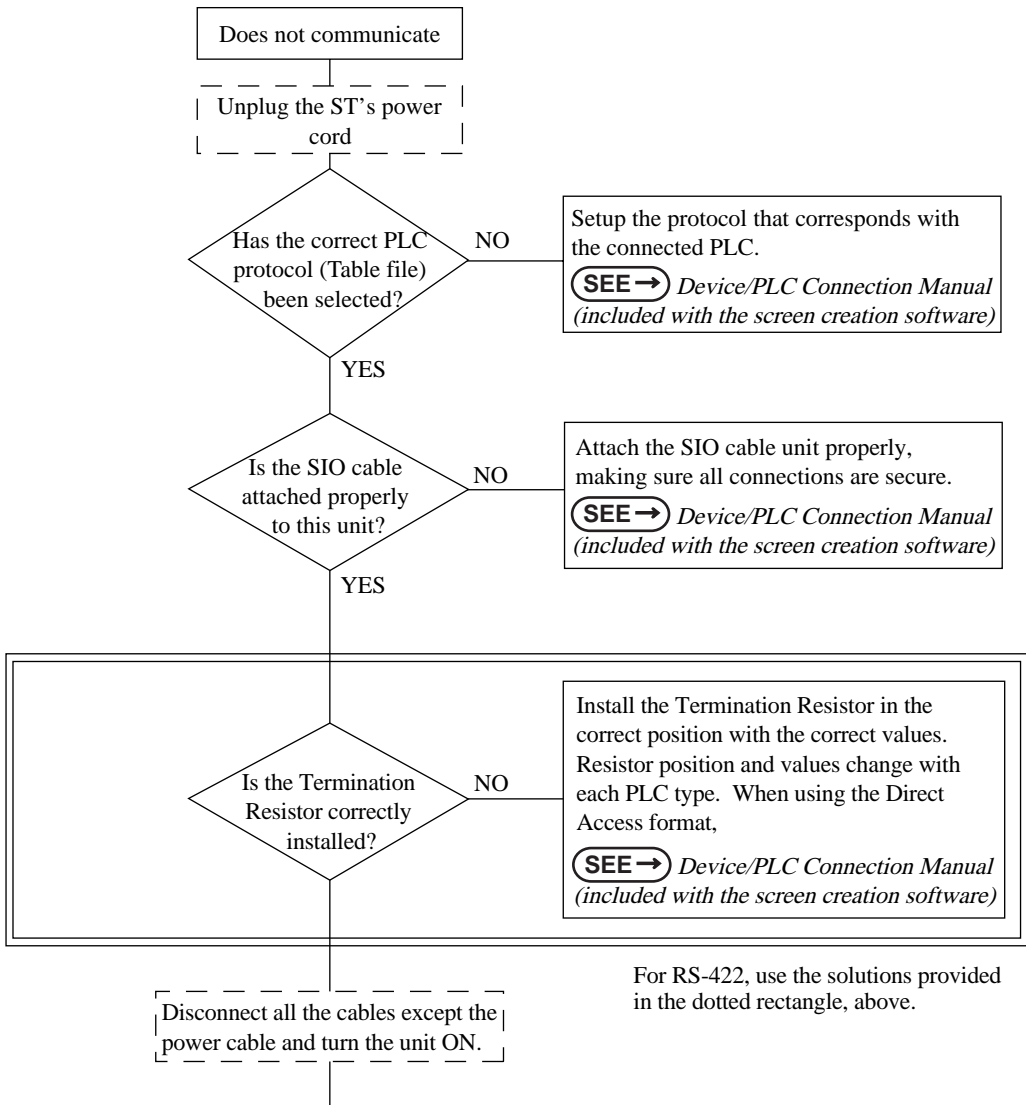

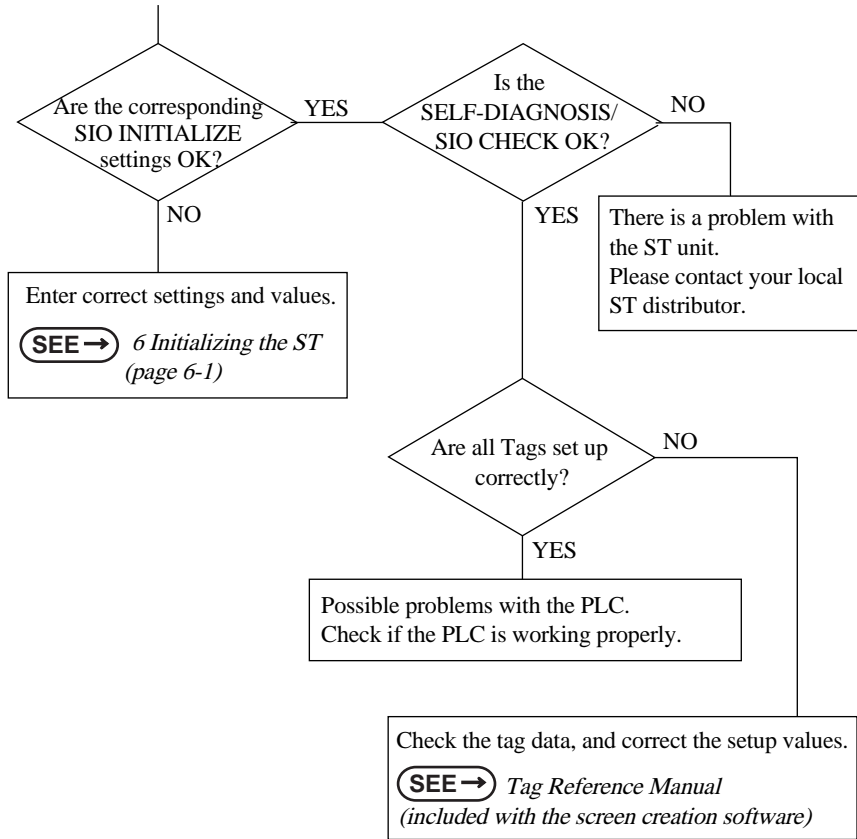

7.3.4 Touch Panel Does Not Respond

When the touch panel does not respond, or its response time is very slow after it is pressed, please use the flowchart below to find the origin of the problem, and the appropriate solution.

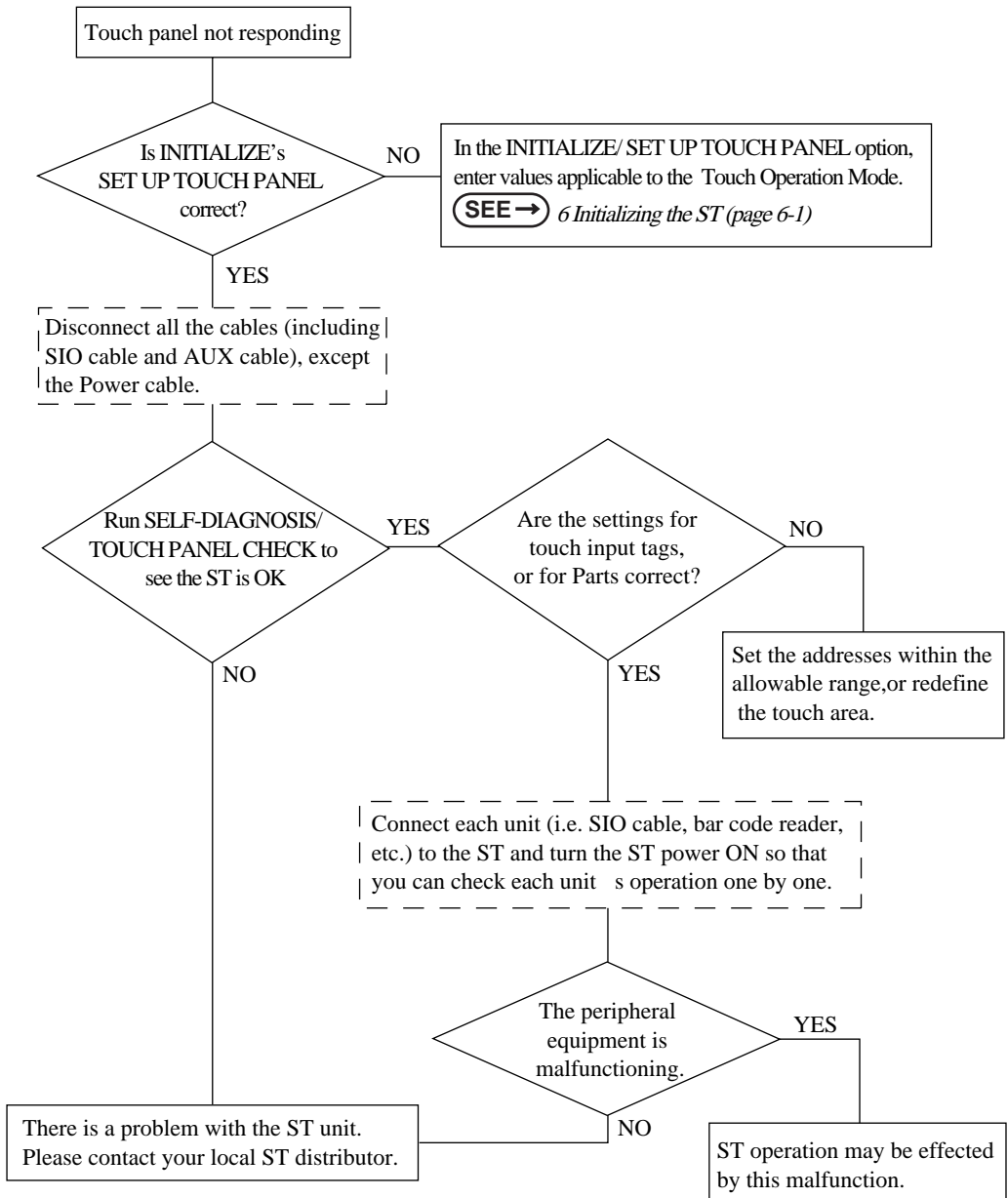

7.3.5 Buzzer Sounds when ST power is turned ON

If you start the ST unit and the internal buzzer sounds, use the following chart to find the reason and the appropriate solution.

Buzzer Sound	Timing	Reason	Solution
Continous beep (approx. 1 sec. intervals)	When power to the ST is turned ON	The ST's system program is destroyed.	Send the correct ST system program from the screen editor software to the ST, via the Transfer screen's "Forced Setup" feature.
Two beeps - Repeating (approx. 1 sec. intervals)	When power to the ST is turned ON	A different ST unit's system program has been accidentally installed in this ST.	Send the correct ST system program from the screen editor software to the ST, via the Transfer screen's "Forced Setup" feature. At this time an error will appear on the screen editor software's screen, however, simply turn the ST's power supply OFF and then ON, and data transfer will automatically start.

7.3.6 Clock Settings Cannot be Entered

This problem occurs when the lithium backup battery's voltage, used for the internal clock, runs out. To enter the clock settings, please read the CLOCK SET UP ERROR directions.

SEE → 7.5.4 Clock Setup Error (Page 7-21)

7.3.7 Error Screens

If the following error screen appears when you start the ST, it indicates an error has occurred and the ST is not set up correctly. Be sure to perform screen transfer (Force System Setup) again.

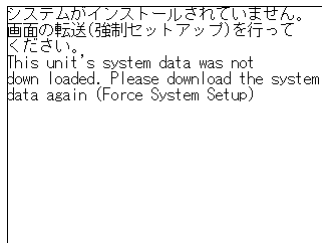

7.4 Error Messages



This section explains the messages that appear when an error has occurred in the ST unit during RUN mode.







The problem causing the error message and its related countermeasure are explained in the table below.

After a problem has been solved, unplug the ST's power cord and then reattach it.

(Only the latest error message will appear on the ST screen)

7.4.1 Error Message List

Error Message	Problem	Counter Measure
SYSTEM ERROR (03 : **)	During screen data transfer, an unrecoverable error occurred.	 7.5 Error Message Details (Page 7-17)
SYSTEM ERROR (*** : *** : ***)	During screen data transfer, an unrecoverable error occurred.	 7.5 Error Message Details (Page 7-17)
ILLEGAL ADDRESS IN SCREEN DATA	Settings are used that overlap addresses.	Set the addresses correctly after checking the screen data.
UNSUPPORTED TAG IN SCREEN DATA	The ST currently in use does not support the desired Tag.	Set the Tag correctly after checking the screen data.
PLC NOT CONNECTED (02 : FF) and (02 : F7)	The communication cable is not connected correctly.	Re-connect the communication cable correctly.
PLC NOT RESPONDING (02 : FE)	PLC's power is not turned ON.	Turn ON the PLC's power.
	ST unit INITIALIZE settings (Setup I/O, PLC Setting) are incorrect.	Check the INITIALIZE settings and make any necessary corrections.
	The ST unit is turned ON before the PLC's power is ON.	Turn ON the PLC's power and wait for 2-3 seconds, then turn ON the ST's power.
	The communication cable is not connected properly.	Check the communication cable and connect it correctly.
RECEIVE DATA ERROR (02 : FD)	The communication cable was disconnected while the ST was ON.	Turn the ST OFF and then ON again.
	"The ST is powered OFF, then ON during communication with PLC."	Turn the ST OFF and then ON again.
	Noise occurred in the communication cable.	Check the communication cable and connect it correctly.
GP STATION NO. DUPLICATION ERROR (02 : F9)	This ST's station number is same as another ST.	Check all ST station numbers, and set them so they are all unique.
	PLC is powered OFF, then ON during communication with ST.	Turn the ST OFF and then ON again.
NETWORK ADDRESS ERROR (02 : F8)	The SIO address used for this ST is different from other ST's. (Only for the Multi-Link connection)	Check all ST's SIO address settings, and correct any that are incorrect.

Error Message	Problem	Counter Measure
PLC COM. ERROR (02 : **)	Specific PLC related error, or an error has occurred with the PLC.	 7.5 Error Message Details (Page 7-17)
SCREEN MEMORY DATA IS CORRUPT (nnnn:mmmm)	ScreenData is corrupted: *nnnn indicates the Screen Number that has an error. *mmmm indicates the number of screens that have errors.(Decimal)	Check the screens that have errors, correct all errors, and then transfer the screen data again.
CLOCK SETUP ERROR	The backup battery for the internal clock is running low.	 7.5 Error Message Details (Page 7-17)
SCREEN TRANSFER ERROR	An error occurred in the data transmission from the screen editor to the STpanel.	Re-transfer the screen data.
SCREEN TAG LIMIT EXCEEDED	Tags are setup beyond the tag limit (max. of 385.)	 7.5 Error Message Details (Page 7-17)
OBJ. PLC HAS NOT BEEN SETUP (**)	The host PLC set up in the Editor program does not match the PLC in use.	 7.5 Error Message Details (Page 7-17)
D-SCRIPT ERROR (***)	D-Script settings (data) are incorrect.	 7.5 Error Message Details (Page 7-17)
GLOBAL D-SCRIPT ERROR (***)	Global D-Script settings (data) are incorrect.	 7.5 Error Message Details (Page 7-17)
EXTENDED SIO SCRIPT ERROR (***)	Extended SIO script settings (data) are incorrect.	 7.5 Error Message Details (Page 7-17)

7.5 Error Message Details

7.5.1 System Errors

Indicates a fault in the basic operations of the ST.

Following the error message, an error code, as shown below, will appear. Report the error number and details on how the error developed to your local ST distributor.

◆ SYSTEM ERROR (03 : x x)

An unrecoverable error occurred during screen data transfer.

03 : X X
 | |
 Constant Value Error No.

◆ SYSTEM ERROR (x x x : x x x : x x x)

An unrecoverable error occurred during screen data transfer.

X X X : X X X : X X X
 | | |
 Error No.1 Error No.2 Error No.3

Possible Solutions

- Check if the ST's Power Cord and the Input signal line have been wired separately from each other.
- Check that the FG line has been grounded correctly, according to your country's standards.
- Re-send the screen data from the PC to the ST.
- If other types of communication errors, such as [RECIEVE DATA ERROR], [PLC COM. ERROR], have also occurred, try to correct those problems also.

SEE → 7.4.1 Error Message List (Page 7-15)

If the above mentioned methods do not solve the problem, please contact your local ST distributor.

◆ When the ST changes to OFFLINE mode during RUN mode

When the ST changes to OFFLINE mode without the user first pressing the screen, there is a possibility that the screen data has been damaged. In this case, after the SYSTEM ERROR displays, the screen automatically reverts to OFFLINE mode after about 10 seconds. Run the INITIALIZE MEMORY command and transfer the ST screen data again from your PC.

In most cases, system errors are related to the problems mentioned below.

- Environment Related Problems

If an error occurs which has no apparent connection to the ST's current operation, the error may be due to the condition of ST's operating environment. This can include noise or electrostatic interference in the power code or the communication line. In this case you need to check if the power code and the communication line wiring and FG grounding are correct.

- Screen Data or Project Data Related Problems

If an error seems to be caused by a particular ST operation, the error may be related to the screen or project data transferred to the ST. In this case, try sending screen data via the FORCE SYSTEM SETUP feature, which will transfer both the screen data and the project data to the ST.

For details about the FORCE SYSTEM SETUP feature,

SEE → *GP-PRO/PBIII for Windows Operation Manual, Transfer Settings section.*

- ST Unit Related Problems

If disconnecting and then reconnecting the power code corrects an error, the problem may not be related to the ST unit itself. However, to identify if the ST unit has any problems, run the OFFLINE mode's SELF-DIAGNOSIS program.

- When a communication error occurs continuously (When using the Direct Access method)

If a communication error occurs continuously, the ST may define the error as a system error. In this case you need to solve the problem causing the original communication error.

7.5.2 Illegal Address in Screen Data

Caused by an overlap of addresses.

After the error message, error codes, as listed below, will appear. If the error cannot be fixed, please report the error code and details on how the error developed to your local ST distributor.

ILLEGAL ADDRESS IN SCREEN AREA (00B:XXX:XXX)

Error No.1 (Refer to Table below)

◆ Overlapping Addresses

Error 1	Error 2	Meaning
0C1	191	All or part of the T-tag ^{*1} or S-tag address range overlap the addresses of System Data Area.
	192	
	193	
0C2	194	All or part of the System Data Area address, A-tag, or S-tag address range overlap the addresses setup in a T-tag. ^{*1}
	195	
	196	
0C3	197	All or part of a T-tag ^{*1} , S-tag or K-tag address range overlap the address range set in an A-tag (Alarm Message.)
	198	
	199	
0C9	19B	All or part of a T-tag ^{*1} , S-tag or K-tag address range overlap the address range set in an A-tag (Log alarm.)

*1 For details about the T-tag (trend graph) and A-tag (alarm messages),

SEE → *GP-PRO/PBIII for Windows Tag Reference Manual (included with the screen editor software)*

NOTE

- The address becomes an address repetition error when there is a problem in how to come in succession (repetition range over time etc.), except for the above-mentioned.

E.g. When the starting address of the System Data Area is set to 100, and the tag below is setup:

Tag Name/ Part ID No.	Word Address	Tag Format
N1	99	BCD32

Starting from addresses 99, two(2) words are used, which causes it to overlap address 100.

7.5.3 PLC Com. Error

Appears when the address setup for tags exceeds the address range used in the host (PLC.) Check the Error Number that appears and use the following table to solve the problem.

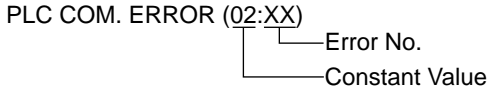

Error #	Problem	Countermeasure
FC	The communication settings for this unit and the host do not match.	* For Memory Link type, check the data or settings the host sends. For the PLC communication, check the communication speed.
FB	The address set on a tag, the address used for storing data for Trend graph, or the address set by an alarm message is out of a set range. (address range error) * Memory to Memory Link type. * Siemen's PLC Series.	* When using Memory Link type: Set the addresses within the set range of the System Data Area (0 to 2047), and re-send correct data. * When using a Toyoda Machine Works PLC: Set the addresses within the set range of the devices. * When using a Yaskawa PLC: Set the addresses within the set range of the devices.
FA	Address range error	Set the addresses within the allowable range.
53	When using a Matsushita Electronics PLC, and there are too many screen tags, the PLC will not receive data.	Decrease the number of tags on the screen.
51	The tag addresses, Trend graph data storage address, Alarm message Registry address, do not exist in the PLC's internal memory.	* When using a Fuji Electric PLC: Setup the addresses in a device range that exists.
Others	The Error code for each PLC can be found in the table on the last page of this chapter. Then, look up the Error Number in the indicated PLC manual. Or, report the Error Number to the PLC manufacturer.	

NOTE

- In Hitachi Industrial Equipment System's HIDIC H (HIZAC H) Series, the error code is divided into 2 bytes, whereas the ST Error Number is composed of 1 byte codes.

E.g.

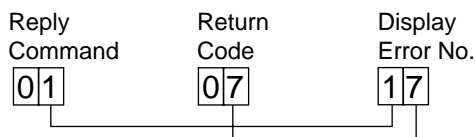

When the Display Error Number is 8*, or 5*, use only the left column as the error number.

- In Toshiba's PROSEC T Series, the Error Code is 4 characters long; on the ST, Error Numbers are changed to and displayed in Hexadecimal.
- With the Allen-Bradley PLC-5 and SLC-500 Series, the EXT/STS error codes have been re-mapped to start at D0 HEX, so they will not conflict with other error codes. When looking up the error number in the PLC manual, subtract D0 h from the ST error code to find its error value.

E.g.

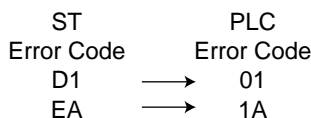

7.5.4 Clock Setup Error

This message displays when the lithium backup battery's voltage for the internal clock runs out. To reset the error, you need to turn the ST's power OFF and then ON again. Leave the ST ON continuously and the battery's charge will become sufficient for backup after 24 hours, and will be fully charged in approximately 96 hours. If the battery is incorrectly replaced, the battery may explode. To avoid the danger, please do not replace the battery yourself. When the battery needs a replacement, please consult with your local ST distributor.

After changing the backup battery, set up the internal clock.

SEE → 6 *Initializing the ST (Page 6-1)*

NOTE

- The lifetime of the backup battery depends on the ambient temperature and the amount of current being charged and used. The table below gives a general indication of how long the battery will last.

Battery Ambient Temperature	40°C or lower	Unit Ambient Temperature	25°C or lower
Expected Lifetime	10 years or longer	Expected Lifetime	10 years or longer

7.5.5 Screen Tag Limit Exceeded (max. of 384)

When tags are setup beyond the tag limit, all tags in excess of number 384 will be disabled. Plus, when tags involve registered Windows and loaded screens, they are disabled in this order: Window Registry, Load Screen.

1. Disabled registered windows start from the last screen used.
2. Disabled loaded screens start from the last screen used.

To correct this problem, reduce the number of tags to within the allowed limit.

7.5.6 OBJ. PLC Has Not Been Setup

The host PLC setup in the Editor program (i.e. the .prw file) does not match the PLC in use. Use the Error Code that follows the error message to select the proper PLC type and correct the ST's INITIALIZE setup data so that it matches this.

OBJ. PLC HAS NOT BEEN SETUP (xx)
|
 The PLC number (Hexadecimal)
 written to the ST's System File

7.5.7 D-Script and Global D-Script Errors

The following error messages are displayed when D-Scripts and Global D-Scripts are not configured properly. The ST Series unit displays the error message on the bottom at the ST screen.

	Error Message
D-Script	D-Script Error (***)
Global D-Script	Global D-Script Error (***)

The following table lists the numbers assigned to (***) in the above error messages. Error Nos. "001" and "002" are displayed at power-on, and Error Nos. "003" and "004" are displayed when an error occurs during the function processing.

No.	Description	Applicable Script
001	The total number of Global D-Scripts exceeds the limit. The maximum number of Global D-Scripts is 32. Note that functions are included in the counts.	Global D-Script
002	The total of all devices in the Global D-Script exceeds the limit of 255 devices.	Global D-Script
003	Either the function being called does not exist, or that function has caused an error.	D-Script Global D-Script
004	Function cannot be nested more than 10 levels.	D-Script Global D-Script

7.5.8 Extended SIO Script Error

The following error message is displayed when an Extended SIO Script is not configured properly. The ST Series unit displays the error message on the bottom at the ST screen.

	Error Message
Extended SIO Script	Extended SIO Script Error (***)

The following table lists the numbers assigned to (***) in the above error message. Error No. 001 is displayed at power-on, and Error Nos. 003 and 004 are displayed when an error occurs during the function processing.

No.	Description
001	The total number of the Functions of Extended SIO Scripts exceeds the limit. The maximum number of Functions of Extended SIO Scripts is 254.
002	Reserved
003	The function that is being called does not exist.
004	Functions cannot be nested more than 10 levels.
005	An old Extended SIO Script protocol is being used for the ST system. Extended SIO Script cannot be run when this error occurs. Be sure to install and run a new Extended SIO protocol (Version 1.12 or later).
006	An incompatible function was found in the screen data's Extended SIO Script. Be sure to install and run a new ST system.

Memo

8

Maintenance

8.1 Regular Cleaning

8.2 Periodic Check Points

8.3 Changing the Backlight

8.1 Regular Cleaning

8.1.1 Cleaning the Display

When the surface or the frame of the display gets dirty, soak a soft cloth in water with a neutral detergent, wring the cloth tightly, and wipe the display.

IMPORTANT

- Do not use paint thinner, organic solvents, or a strong acid compound to clean the unit.
- Do not use hard or pointed objects to operate the touch-screen panel, since it can damage the panel surface

8.1.2 Installation Gasket Check/Replacement

The installation gasket protects the ST and improves its water resistance. For instructions on installing the ST's gasket, refer to

SEE → 3 *Installation and Wiring (Page 3-1)*

IMPORTANT

- A gasket which has been used for a long period of time may have scratches or dirt on it, and could have lost much of its water resistance. Be sure to change the gasket at least once a year, or when scratches or dirt become visible.

■ Installation Gasket Replacement Procedure

- (1) Place the ST on a flat, level surface with the display facing downwards.
- (2) Remove the old gasket from the ST.

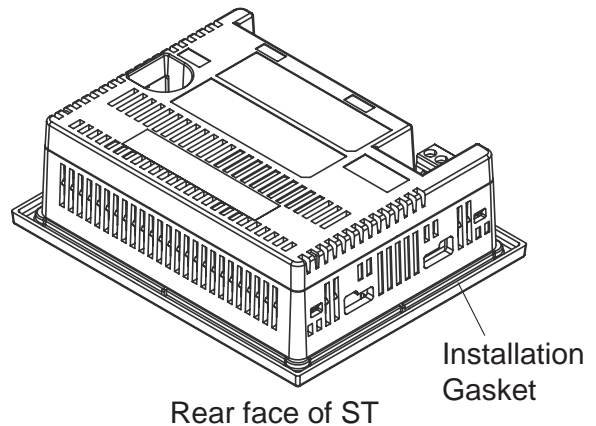

- (3) Attach the new gasket to the ST. Be sure to insert the gasket into the ST's groove so that the gasket's groove sides are vertical.
- (4) Check if the gasket is attached to the ST correctly.

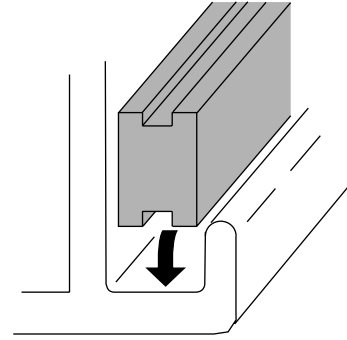
**IMPORTANT**

- The gasket must be inserted correctly into the groove for the ST's moisture resistance to be equivalent to IP65.
- Be sure the gasket's seam is not inserted into any of the unit's corners, only in the straight sections of the groove. Inserting it into a corner may lead to its eventually tearing.
- To ensure the installation gasket's maximum level of moisture resistance, be sure the gasket's seam instead as shown into the panel's button face.
- The upper surface of the gasket should protrude approximately 2mm out from the groove. Be sure to check that the gasket is correctly inserted before installing the ST into a panel.

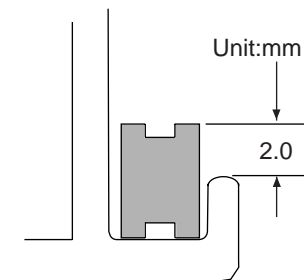
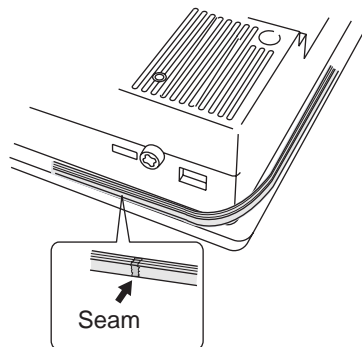

8.2 Periodic Check Points

To keep your ST unit in its best condition, please inspect the following points periodically.

■ ST Operation Environment

- Is the operating temperature within the allowable range (0°C to 50°C)?
- Is the operating humidity within the specified range (10%RH to 90%RH, dry bulb temperature of 39°C or less)?
- Is the operating atmosphere free of corrosive gasses?

■ Electrical Specifications

- Is the input voltage appropriate? DC19.2V to DC28.8V

■ Related Items

- Are all power cords and cables connected properly? Have any become loose?
- Are all mounting brackets holding the unit securely?
- Are there many scratches or traces of dirt on the installation gasket?

8.3 Changing the Backlight

The ST unit's backlights cannot be replaced by the customer. When the backlights need to be replaced, please contact your local ST distributor.

Index

A

Accessories	1-9
Active Display Area.....	2-4
After All Setting Data is Entered	5-6
After Connecting the Power Cord.....	7-2
Air Purity (Dust)	2-2
ALARM MESSAGE	6-29
Allowable Voltage Drop.....	2-2
Ambient Operating Temperature	2-2
Application.....	2-5
Atmospheric Endurance.....	2-2
Available Software.....	1-9

B

Backlight	2-4, 8-4
Bar Code Readers	1-8
Battery Replacement.....	4
BRIGHTNESS ADJUSTMENT.....	6-15
Brightness Adjustment.....	2-4
BUZZER ON ERROR.....	6-26
Buzzer Sounds when ST power is turned ON	7-8, 7-14

C

CE Marking Notes	10
Changing the Backlight.....	8-4
Character	2-4
Character Sizes.....	2-4
CHARACTER STRING DATA MODE.....	6-8
Character String Data Setup.....	6-8
Check the Installation Gasket's Seating.....	3-2
Checks all the figures and tiling patterns.....	7-4
Checks each ST touch panel square.....	7-4
Checks the Function Switch.....	7-4
Checks the Input Port.....	7-4
Checks the internal display memory.....	7-4
Checks the RS-232C and RS-422 send/receive lines ..	7-4
Checks the status of the Expansion Serial I/F.....	7-4
Checks the System and Protocol of the ST Internal Mem- ory	7-4
Checks the Tool Connector control lines and send/receive lines	7-4
Cleaning the Display.....	8-2
Clock Accuracy.....	2-5
Clock Settings Cannot be Entered	7-8, 7-14

Clock Setup Error	7-21
Colors.....	2-4
COMMUNICATION FORMAT.....	6-17
COMMUNICATION PORT SETUP.....	6-18
COMMUNICATION RATE.....	6-12, 6-17
Communication Setup	6-13
Connecting the Power Cord.....	3-7
Connecting the Power Supply	3-9
Connection List.....	6-21
CONTENTS	1-13
CONTRAST ADJUSTMENT	6-14
Contrast Adjustment	2-4
CONTROL	6-12
Cooling Method	2-3
Corrosive Gasses.....	2-2
Creating a Panel Cut	3-3
Customize Setup	6-22

D

Data Backup.....	2-5
DATA FORMAT.....	6-7
DATA LENGTH	6-12, 6-17
Data Transfer	4-1
DATA TYPE OF SCREEN NO.....	6-5
Dimensions	2-13
Display	2-12
Display Device.....	5
DISPLAY PATTERN	7-5
Display Setup.....	6-16
Display Specifications	2-4
DISPLAY WARNING	6-26
Documentation Conventions	11
D-Script Error	7-22

E

Electrical Specifications	2-2, 8-4
Electrostatic Discharge Immunity	2-2
Entering Numbers	5-5
Entering OFFLINE Mode.....	5-2
Environmental Specifications	2-2
Error Message Details.....	7-17
Error Message List.....	7-15
Error Messages	7-15
Error Screens.....	7-14
Errors	7-1

Essential Safety Precautions.....	2
Ethernet Cable Connector.....	3-12
Ethernet Data Transfer.....	4-5
Ethernet Interface	2-11, 2-12
Ethernet Setup	6-24
Expansion Serial Environment Setup.....	6-18
EXPANSION SERIAL I/F	7-7
Expansion Serial Interface.....	2-10
Expansion Serial Setup.....	6-17
Extended SIO Script Error.....	7-23
External Dimensions	2-3, 2-13

F

FACILITY	6-25
FONT SETTING	6-3, 6-30
Font Setting	6-30
Font Sizes	2-4
FRAME BUFFER	7-5
Function keys.....	2-5
FUNCTION SWITCH.....	7-7
Function Switch.....	2-12
Functional Specifications	2-4

G

GATEWAY	6-25
General Safety Precautions.....	6
General Specifications.....	2-2
Global D-Script Error	7-22
GLOBAL WINDOW	6-7
GLOBAL WINDOW ACCESS	6-7
Global Window Setup	6-7
GP Screen Editor	11
GP-PROPB III C-Package02.....	1-9
Grounding.....	2-3, 3-10

H

HOST IP ADDRESS	6-25
-----------------------	------

I

I/O Signal Line Placement.....	3-11
Illegal Address in Screen Data	7-19
INITIAL SCREEN NO.	6-29
Initialization.....	5-5
Initialization Items.....	6-3
Initialization Screen.....	6-2
INITIALIZE	5-4
Initialize Internal Memory.....	6-27
INITIALIZE MEMORY	6-3

Initialize ST Memory	6-27
Initializing the ST	6-1
INPUT PORT	7-6
In-Rush Current.....	2-2
Installation.....	3-1, 3-2
Installation Fastener	1-10
Installation Fasteners.....	2-14
Installation Gasket.....	1-10
Installation Gasket Check/Replacement.....	8-2
Installation Procedures	3-2
Installation/Maintenance	4
Installing the ST	3-5
Insulation Resistance.....	2-2
Interface Specifications	2-8
Interfaces	2-6
INTERNAL FEPROM CHECKSUM.....	7-5
Introduction	1-1

K

KANJI FONT QUALITY	6-30
Key	5-7

L

LANGUAGE CHANGEOVER FUNCTION	5-4
Language Fonts	2-4
LOCATION.....	6-8

M

Maintenance	8-1
Maintenance options	1-10
Memory	2-5
Mitsubishi A Connection Cable	1-9
Mitsubishi FX Series Connection Cable	1-9
Mitsubishi Q Connection Cable	1-9
Mitsubishi Q Link Cable	1-9
MONOPOLIZE TIME	6-23
Multi-link	6-19, 6-22
MY IP ADDRESS.....	6-24
MY PORT NO.....	6-24

N

NETWORK INFORMATION (DEV/ADR).....	6-20
No Display.....	7-8, 7-9
No ST/HOST Communication	7-8
No ST/Host Communication.....	7-11
Noise Immunity.....	2-2

O

OBJ. PLC Has Not Been Setup.....	7-22
OFFLINE displays During RUN Mode.....	7-8
OFFLINE Mode.....	5-1
OFFLINE Mode Main Menu.....	5-4
Omron SYSMAC Cable.....	1-9
ONLINE ERROR DISPLAY.....	6-29
Operating Humidity.....	2-2
Option.....	1-10
Others Setup.....	6-26
OUTPUT LEVEL.....	6-25

P

Package Contents.....	8
Panel Cut Dimensions.....	2-14
PARITY.....	6-12, 6-17
Part Names.....	2-12
PASSWORD SETUP.....	6-5
Periodic Check Points.....	8-4
PLC.....	11
PLC Com. Error.....	7-20
PLC PRIORITY.....	6-22
PLC Setup.....	6-19
PLC SETUP MENU.....	6-3
Pollution Degree.....	2-2
Possible Types of Trouble.....	7-8
Power Consumption.....	2-2
Power Lamp.....	2-12
Power Plug.....	2-12
Power Plug Specifications.....	3-8
Prior to Operating the ST.....	1-2

R

Rated Voltage.....	2-2
Rated Voltage Range.....	2-2
Ratings.....	2-3
RECEIVE TIMEOUT.....	6-13
Recommended Units.....	1-8
REGISTRATION NO.....	6-7
Regular Cleaning.....	8-2
Related Items.....	8-4
RESET GP ON WRITE DATA.....	6-20
Resolution.....	2-4
RETRY COUNT.....	6-13
Return To Main Menu.....	5-8
Return To Previous Screen.....	5-6
Revision Information.....	10
RI/VCC.....	6-17
RS-232C cable.....	1-9

RS-422 cable.....	1-9
RUN.....	5-4
RUN Mode.....	7-1, 7-2

S

Safety Icons.....	2
Screen.....	1-9
SCREEN DATA TRANSFER.....	5-4
Screen Data Transfer Cable.....	1-9
Screen Protection Sheet.....	1-10
Screen Tag Limit Exceeded.....	7-22
Selecting A Menu.....	5-5
Selecting Setup Conditions.....	5-5
SELF-DIAGNOSIS.....	5-4
Self-Diagnosis.....	5-7, 6-26, 7-4
Self-Diagnosis - Details.....	7-5
Self-Diagnosis Item List.....	7-4
Serial Data Transfer.....	4-2
Serial Interface.....	2-8, 2-9, 2-11
Serial Interfaces.....	1-9
.....	5-7
Set up.....	4-4
SET UP I/O.....	6-3
Set Up I/O.....	6-11
SET UP LCD.....	6-16
SET UP OPERATION SURROUNDINGS.....	6-19
Set Up Screen.....	6-29
SET UP SIO.....	6-11
SET UP TIME.....	6-28
Set Up Time.....	6-28
Set Up Touch Panel.....	6-13
SETUP SCREEN.....	6-3
SETUP TIME.....	6-3
SIO CHECK.....	7-6
Specifications.....	2-1
ST.....	1
ST Edit Mode Peripherals.....	1-7
ST Operation Environment.....	8-4
ST RUN Mode Peripherals.....	1-3
ST Series Model Names.....	8
ST TOUCH MONOPOLIZE.....	6-23
STAND-BY MODE TIME.....	6-4
START TIME.....	6-5
STATION NO.....	6-22
Station Setup.....	6-20
Storage Humidity.....	2-2
Storage Temperature.....	2-2
Structural Specifications.....	2-3

SUBNET MASK	6-24
SYSLOG Setup	6-25
SYSTEM AREA READING	6-20
System Area Setup	6-5
System Area Size.....	6-5
SYSTEM AREA START ADR.....	6-19
SYSTEM AREA START DEV	6-19
System Design	2, 1-3
SYSTEM ENVIRONMENT SETUP.....	6-3
System Environment Setup	6-4
System Errors	7-17
SYSTEM RESET MODE	6-14
System Setup	6-4

T

Text	2-4
Tool Connector	1-9, 2-12, 3-11
TOOL CONNECTOR LOOP BACK.....	7-6
TOUCH BUZZER SOUND	6-5
TOUCH OPERATION MODE	6-13
TOUCH PANEL.....	7-5
Touch Panel	3, 2-5, 2-12
Touch Panel Does Not Respond	7-8, 7-13
Troubleshooting.....	7-8
Type	2-4

U

UL/c-UL (CSA) Application Notes.....	9
Unit Disposal	5
UNIT No.....	6-20

V

Validation List	6-21
Via OFFLINE Mode.....	7-3
Vibration Resistance.....	2-2
Voltage Endurance.....	2-2

W

Weight.....	2-3
When an Error Message displays	5-8
Wiring.....	3, 4, 3-1
Wiring Precautions	3-7