

19



Sending Data between Devices

19.1	Try to Send Data between Devices.....	19-2
19.2	Setting Guide	19-35
19.3	Restrictions	19-47

19.1 Try to Send Data between Devices

There are two types of methods for exchanging data between devices: the distribution type and the collection type.

- Distribute Type

Transfers data from the node where the trigger condition has been satisfied to the other node.  "19.1.1 Distributing Data"

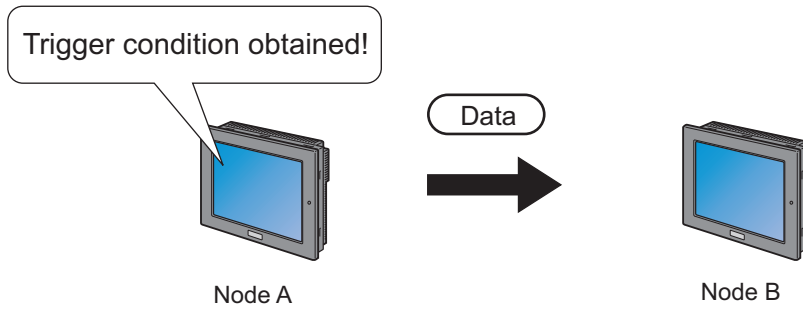

- Collection Type

Collects data from the other node to the node where the trigger condition has been satisfied.  "19.1.2 Collecting Data"

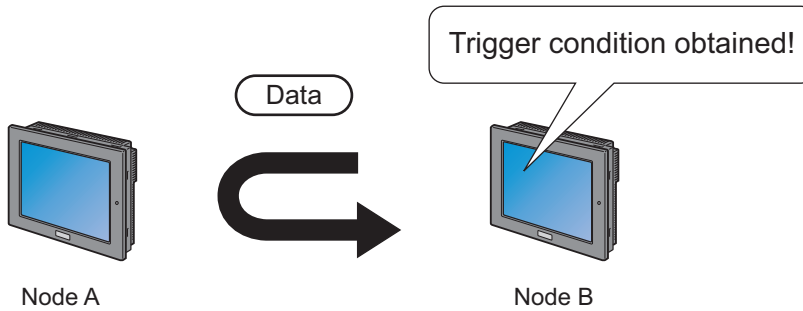

19.1.1 Distributing Data

[Action Example 1]

Detect the rising of the device of the Device/PLC (PLC1) (bit device: address "M01") and transfer the data of the device of the Device/PLC (PLC1) (word device: addresses "M50" to "M54") to the other two Device/PLCs (PLC2 and PLC3) (word device: addresses "DM50" to "DM54", and addresses "BD50" to "BD54").

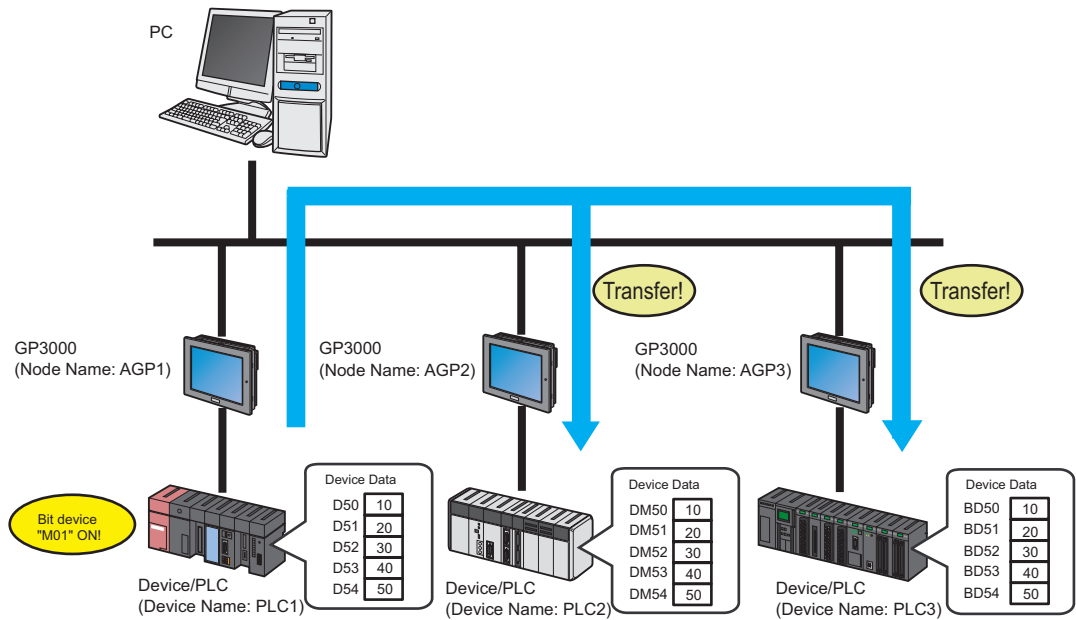

This section describes the setting procedures for executing the above action as an example.

NOTE

- After the transfer of the network project is completed, it is not necessary to use the PC in providing data.
- Refer to [Action Example 2] for the action example of "Collection Type".

☞ "19.1.2 Collecting Data"

- When [NPX ID] is selected under [Compare NPX Project on Connection] on the [Option Settings] screen, you need to transfer the network project to all nodes, including those which are not affected by the changes. When [NPX changes] is selected, you can transfer the network project only to nodes that are affected by the changes, unless the changes of the network project affect target items for comparison. This makes the transfer procedure easier in large-scale systems. Refer to the following section for more details on [Compare NPX Project on Connection].
- When you change selection of [Compare NPX Project on Connection] on the [Option Settings] screen, execute the transfer to all nodes.

[Setting Procedure]

1	Starting 'Pro-Studio EX'	This step starts 'Pro-Studio EX'.
↓		
2	Registering Entry Nodes	This step registers the PC and the GPs as entry nodes.
↓		
3	Registering Symbols	This step registers as a symbol the device of Device/PLC which serves as a trigger condition (trigger), a data transfer source, and a data transfer destination.
↓		
4	Setting Data Transfer Type	This step sets a type of data transfer (Distribution Type).
↓		
5	Setting Trigger Conditions	This step sets conditions for transferring data.
↓		
6	Setting Transfer Data (Transfer source/ Transfer destination)	This step executes data settings of transfer source and transfer destination.
↓		
7	Verifying Setting Result	This step verifies setting results on the setting content list screen.
↓		
8	Saving a Network Project File	This step saves the current settings as a network project file.
↓		
9	Transferring a Network Project File	This step transfers a saved network project file to the GP.
↓		
10	Executing Data Transfer	This step verifies that the data of the transfer source is transferred to the preset transfer destination device after the preset trigger condition has become effective.

■ Starting 'Pro-Studio EX'

This step starts 'Pro-Studio EX'.

Refer to "3 Trial of Pro-Server EX" for details about starting method.

■ Registering Entry Nodes

This step registers the GPs connected with a network as nodes.

Refer to "31 Node Registration" for details about entry nodes.



Node Name :AGP1
 IP Address :192.168.0.100
 Device/PLC Information

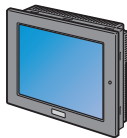

Node Name :AGP2
 IP Address :192.168.0.101
 Device/PLC Information

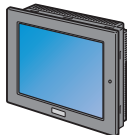

Node Name :AGP3
 IP Address :192.168.0.102
 Device/PLC Information

Ex.

GP (Transfer Source)

- GP : GP3000 series
- Node Name : AGP1
- IP Address : 192.168.0.100

GP (Transfer Destination 1)

- GP : GP3000 series
- Node Name : AGP2
- IP Address : 192.168.0.101

GP (Transfer Destination 2)

- GP : GP3000 series
- Node Name : AGP3
- IP Address : 192.168.0.102

■ Registering Symbols

This step registers as a symbol the device of Device/PLC which serves as a trigger condition (trigger), a data transfer source, and a data transfer destination.

Refer to "32 Symbol Registration" for details about symbols.

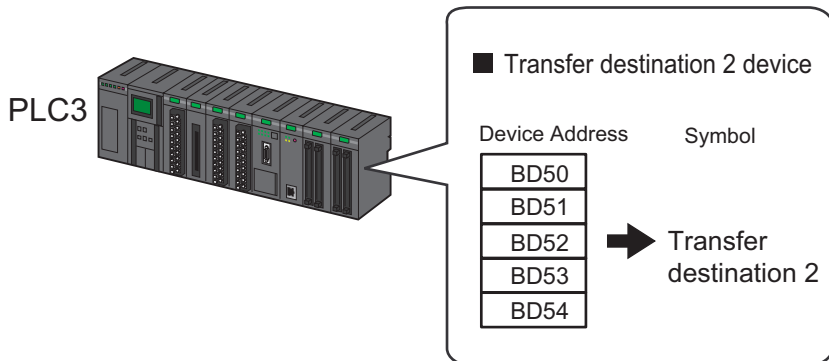
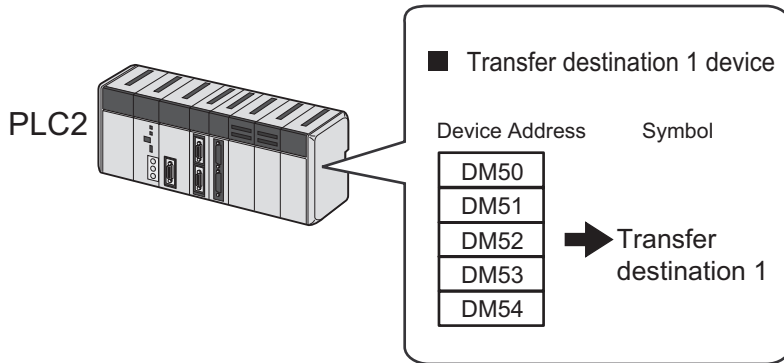
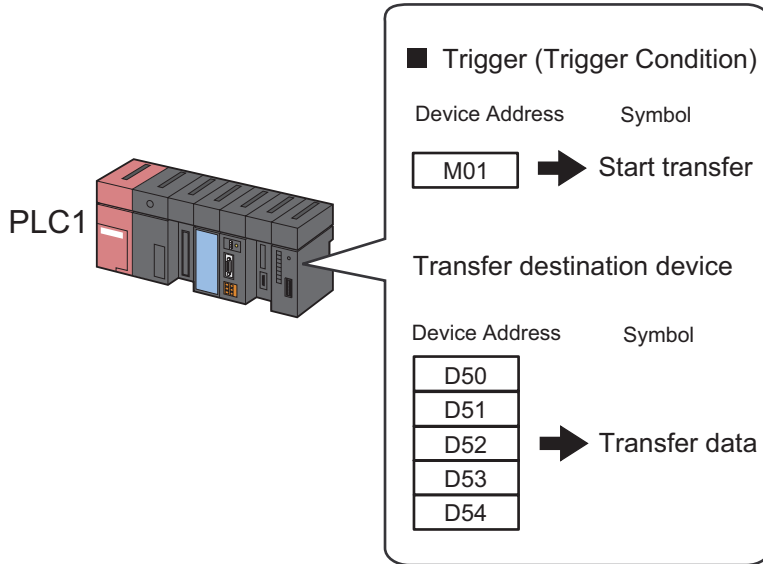

Ex.

- Trigger (trigger condition)

Setting item	Setting content
Symbol Name	Start transfer
Data Type	Bit
Device address for symbol registration	"M01" of Device/PLC (PLC1)
No. of Devices	1

- Transfer Source Device

Setting item	Setting content
Symbol Name	Transfer data
Data Type	16Bit (Signed)
Device address for symbol registration	"D50" to "D54" of Device/PLC (PLC1)
No. of Devices	5

- Transfer Destination Device

Setting item	Setting content	
Symbol Name	Transfer Destination 1	Transfer Destination 2
Data Type	16Bit (Signed)	
Device address for symbol registration	"DM50" to "DM54" of Device/PLC (PLC2)	"BD50" to "BD54" of Device/PLC (PLC3)
No. of Devices	5	5

■ Setting Data Transfer Type

This step sets a type of data transfer (Distribute Type).

Ex.

Setting item	Setting content
Data Transfer Name	Data transfer
Transfer Type	Distribute type

1 Click the [Feature] icon on the status bar.

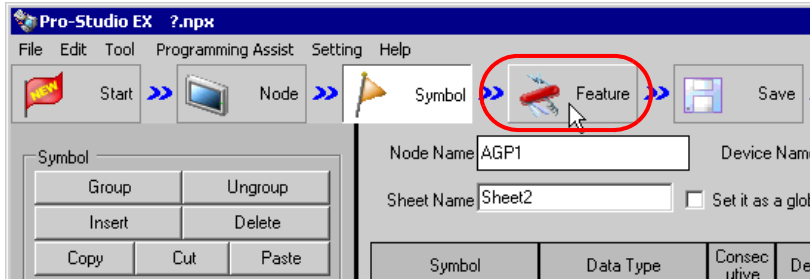

2 Select [Data Transfer] from the tree display on the left of the screen, then click the [Add] button.

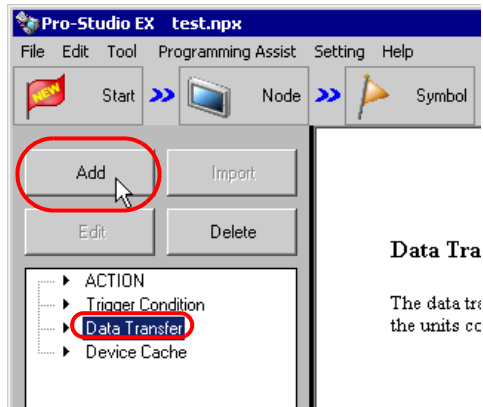

3 Enter "Data Transfer" in [Data Transfer Name] as a data transfer name to set, and then check [Distribute Type].

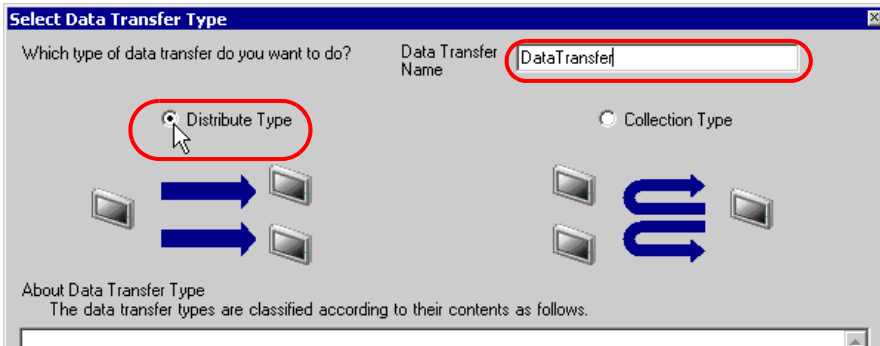

This is the end of data transfer type settings.

■ Setting Trigger Conditions

This step sets conditions (trigger bit ON) for transferring data.

Refer to "33 Trigger Conditions" for details about trigger conditions.

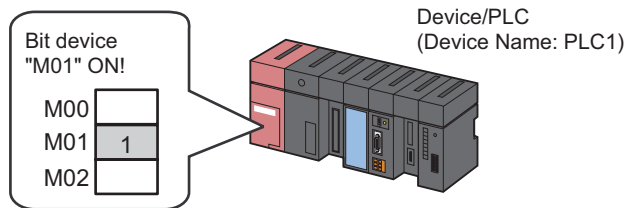

Ex.

- Trigger Condition Name: Turn on data transfer bit
- Trigger Condition: When "Transfer start" (M01) is ON

1 On the "Select Data Transfer Type" screen, click the [Next] button.

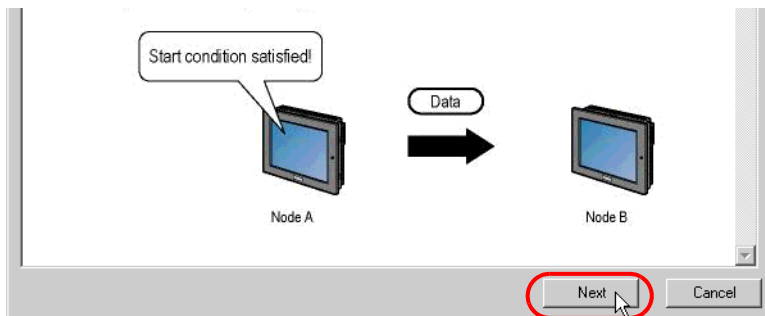

2 Click the [New Trigger Condition] button.

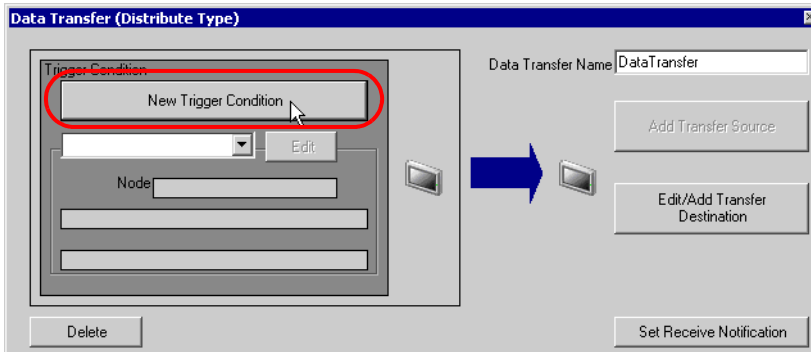

3 Enter the trigger condition name "TurnOnDataTransferBit" in [Trigger Condition Name], and select "AGP1" in [Node Name] which has the device to serve as the trigger condition (trigger).

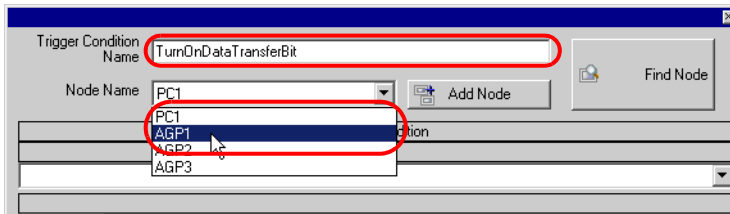

NOTE • Here, you are to specify the node having the device to be the trigger condition.
 ☞ "33 Trigger Conditions"

4 Click the [When Device ON] button in the [Condition 1] tab and select "PLC1" for the device name.

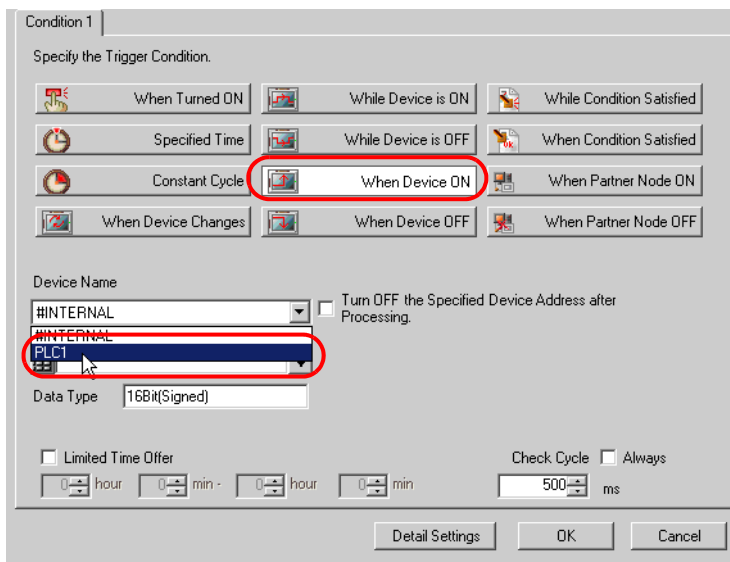

- Click the [Device Address] list button and select "StartTransfer" for the symbol name of the device which serves as the trigger.

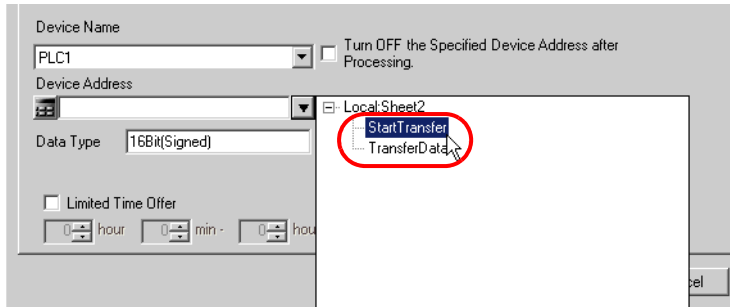

NOTE • You can also set trigger conditions by combining 2 different types of conditions ("And" condition or "Or" condition).

☞ "33 Trigger Conditions"

- Click the [OK] button.

This is the end of trigger condition settings.

■ Setting Transfer Data (Transfer source/Transfer destination)

This step sets data of transfer source and transfer destination.

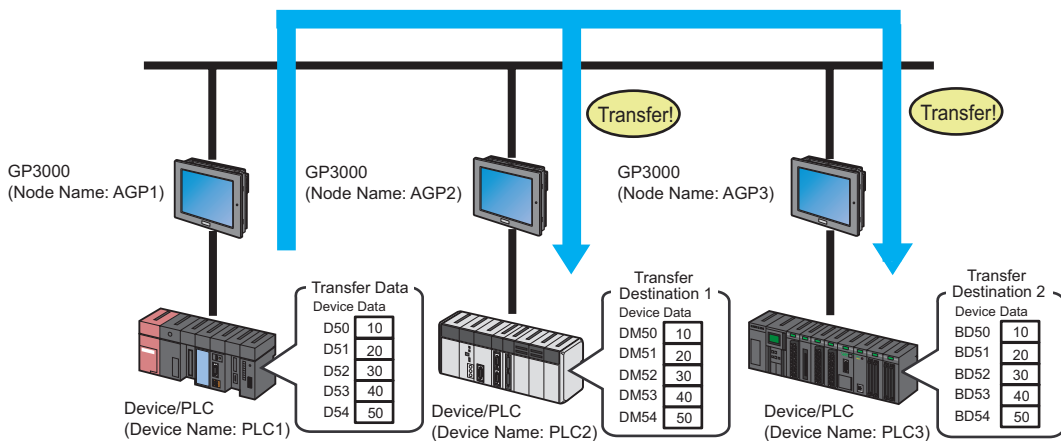

Ex.

- Transfer Source
 Device Name : PLC1
 Device : Transfer Data
- Transfer Destination 1
 Entry Node : AGP2
 Device Name : PLC2
 Device : Transfer Destination 1
- Transfer Destination 2
 Entry Node : AGP3
 Device Name : PLC3
 Device : Transfer Destination 2

1 On the "Data Transfer (Distribute Type)" screen, click the [Add Transfer Source] button.

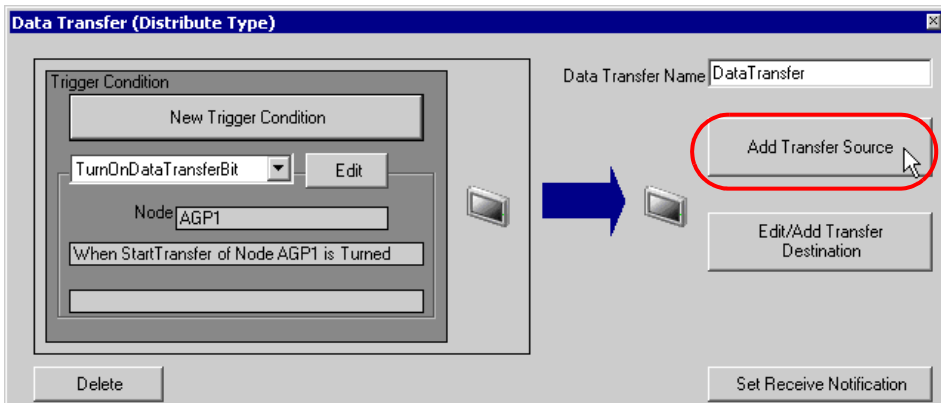

2 In [Transfer Source], click the list button of [Device Name] and select "PLC1" as a Device/PLC to be a data transfer source.

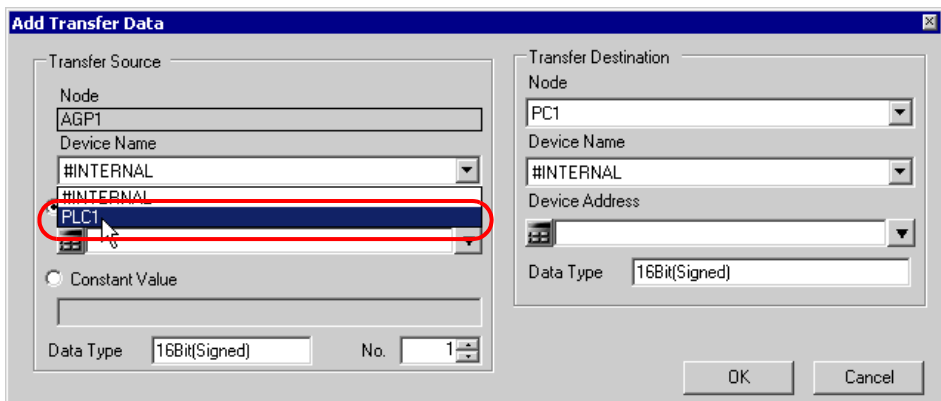

- Click [Device Address] and then click the list button. Select "Transfer Data" as a symbol name of a device to be a transfer source.

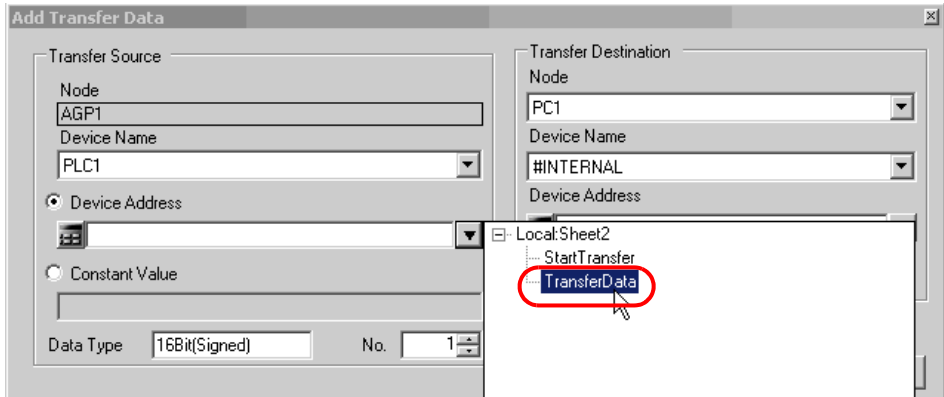

This is the end of the data settings of a transfer source.
 Proceed to the data settings of transfer destination 1.

- In [Transfer Destination], click the list button of [Node] and then select "AGP2" as an entry node to be a data transfer destination.

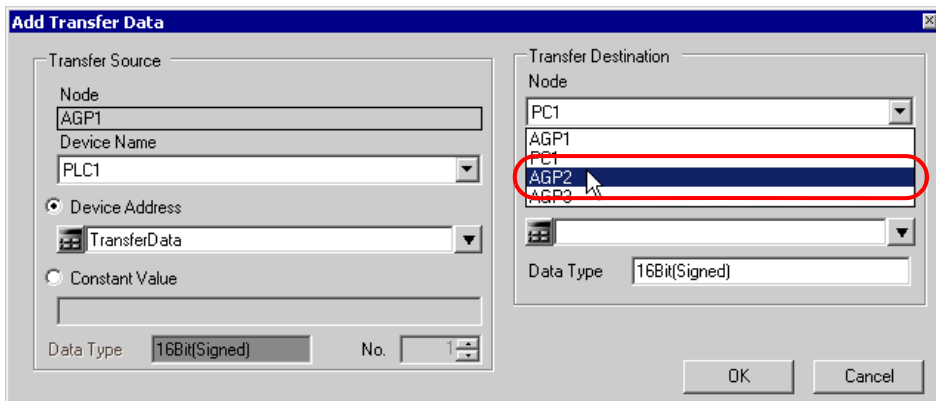

- 5 Click the list button of [Device Name] and select "PLC2" as a Device/PLC to be a data transfer destination.

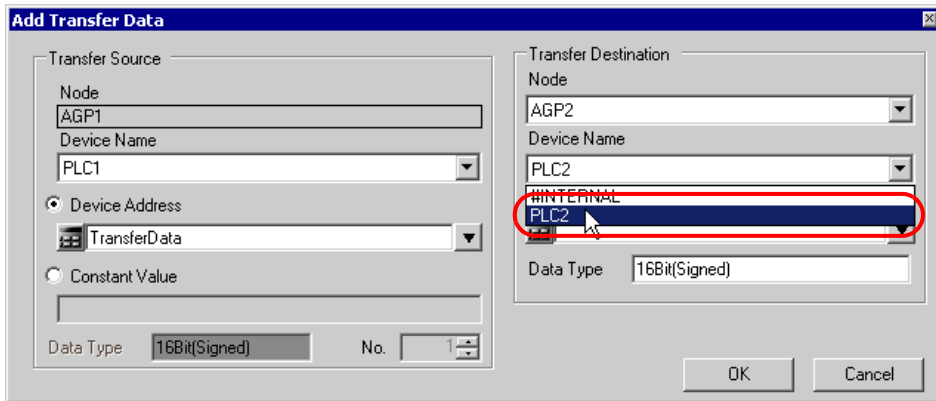

- 6 Click the list button of [Device Address] and select "Transfer Destination 1" as a symbol name of a device to be a transfer destination.

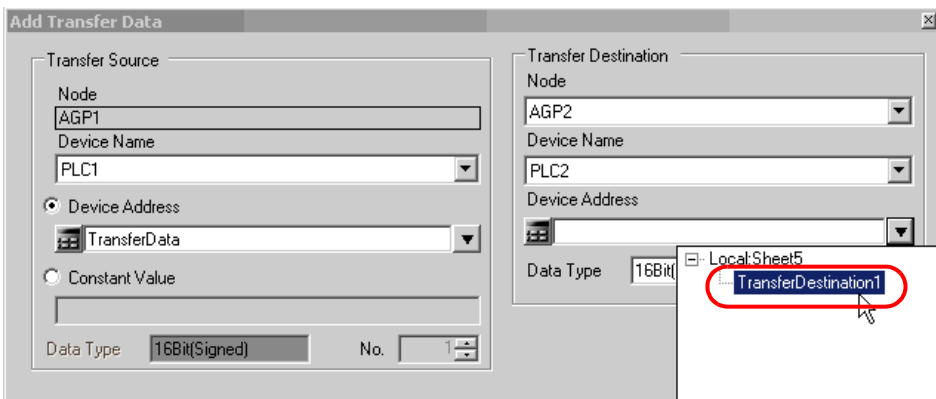

- 7 Click the [OK] button.

This is the end of the data settings of transfer destination 1.

Proceed to the data settings of transfer destination 2.

8 Click the [Edit/Add Transfer Destination] button.

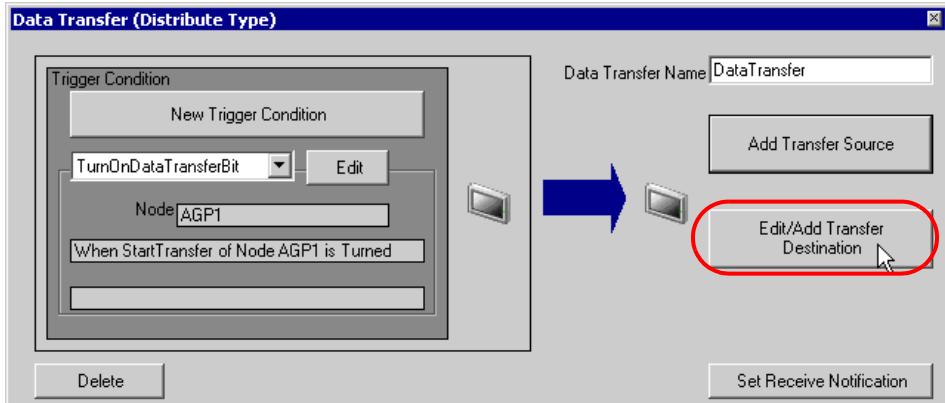

9 On the "Edit Transfer Data" screen, enter the following contents of transfer destination 2 in the fields to set a new transfer destination, and then click the [OK] button.

- Entry node of transfer destination: AGP3
- Device name of transfer destination: PLC3
- Device of transfer destination: Transfer Destination 2

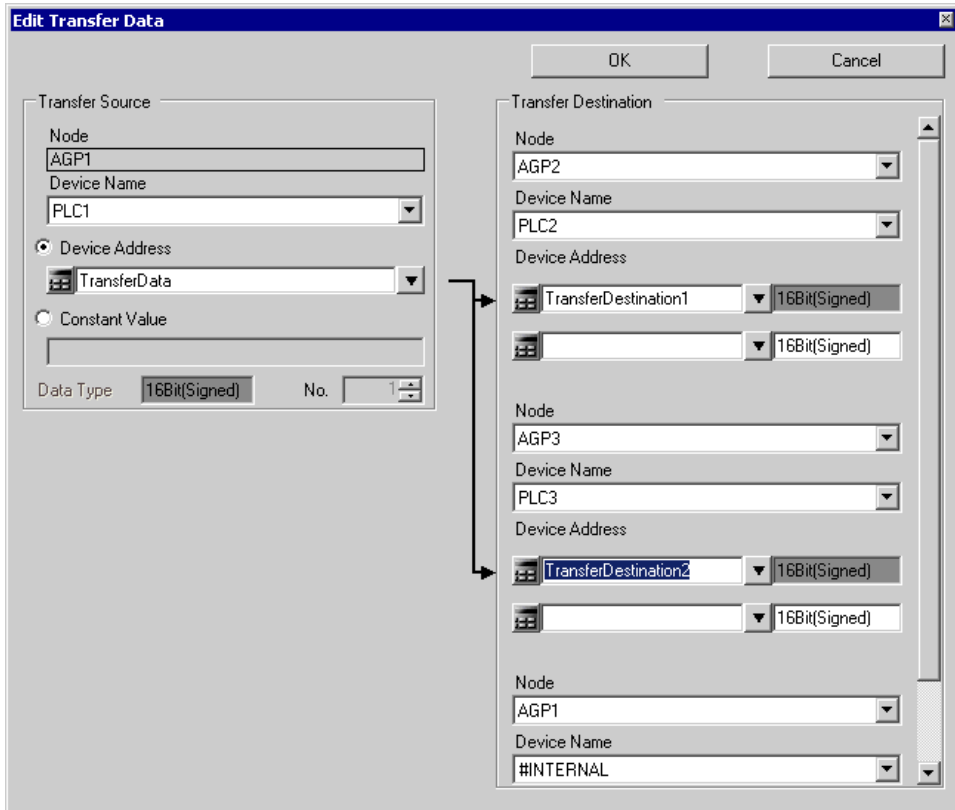

10 Click the [OK] button.

This is the end of the transfer data settings.

■ Verifying Setting Result

This step verifies setting results on the setting content list screen.

- 1 Select "Data Transfer" as a data transfer name from the tree display on the left of the screen.

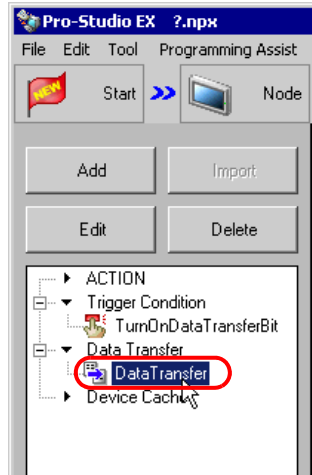

Confirm that the setting content appears on the right of the screen.

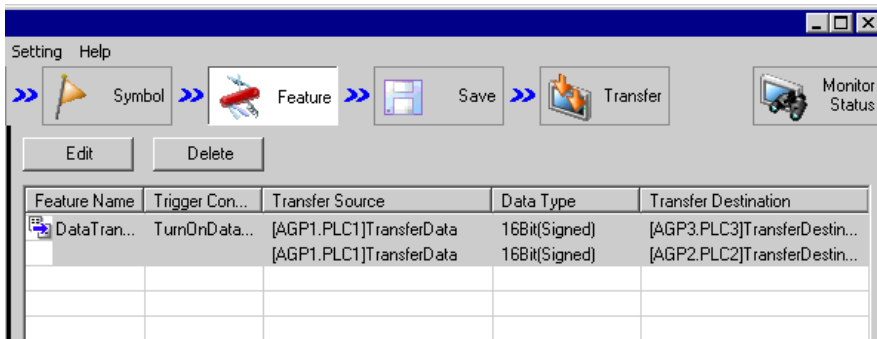

This is the end of the verification of the settings.

■ Saving a Network Project File

This step saves the current settings as a network project file.

Refer to "25 Saving" for details about saving a network project file.

IMPORTANT

- 'Pro-Server EX' reads a created network project file, and then executes data transfer according to the settings in the file. The settings therefore need be saved in the network project file.
-

Ex.

- Path of network project file : Desktop\Datatrans_delivery.npx
- Title : Data Transfer

■ Transferring a Network Project File

This step transfers a saved network project file to entry nodes.

Refer to "26 Transferring" for details about transferring a network project file.

NOTE

- Be sure to transfer a network project file. If not, the data transfer feature will not work.
 - It is not necessary to reload the network project file during data transfer since the PC is not active then.
 - When [NPX ID] is selected under [Compare NPX Project on Connection] on the [Option Settings] screen, you need to transfer the network project to all nodes, including those which are not affected by the changes. When [NPX changes] is selected, you can transfer the network project only to nodes that are affected by the changes, unless the changes of the network project affect target items for comparison. This makes the transfer procedure easier in large-scale systems. Refer to the following section for more details on [Compare NPX Project on Connection].
 - When you change selection of [Compare NPX Project on Connection] on the [Option Settings] screen, execute the transfer to all nodes.
-

■ Executing Data Transfer

This step verifies that the data of the transfer source is transferred to the preset transfer destination device after the preset trigger condition has become effective.

The screenshot shows the 'Symbol - Monitor of Pro-Server EX' window. The 'Node' is set to 'AGP1', 'Device/PLC' to 'PLC1', and 'Device Address' to 'Sheet3'. The 'Polling time' is 1000ms, 'Time expended for read' is 3047ms, and 'Time expended for write' is empty. A 'Start' button is visible. The data table below shows the following information:

Symbol	Data type	Address	Count	+00	+01	+02	+03	+04
TransferDestination1	16Bit<Signed>	DM0050	5	10	20	30	40	50

The screenshot shows the 'Symbol - Monitor of Pro-Server EX' window with the same settings as above. The data table below shows the following information:

Symbol	Data type	Address	Count	+00	+01	+02	+03	+04
TransferDestination2	16Bit<Signed>	BD0050	5	60	70	80	90	100

NOTE

- Check the actually written values with such function as monitor of rudder creation software.

This is the end of the explanation of data transfer (distribution type).

19.1.2 Collecting Data

[Action Example 2]

Detect the rising of the device of the Device/PLC (PLC2) (bit device: address "01"), collect the data of the device of the Device/PLCs (PLC1 and PLC 3) (word device: addresses "D50" to "D54" and addresses "BD50" to "BD54"), and then write the collected data in the device of the Device/PLC (PLC 2) (word device: addresses "DM50" to "DM59").

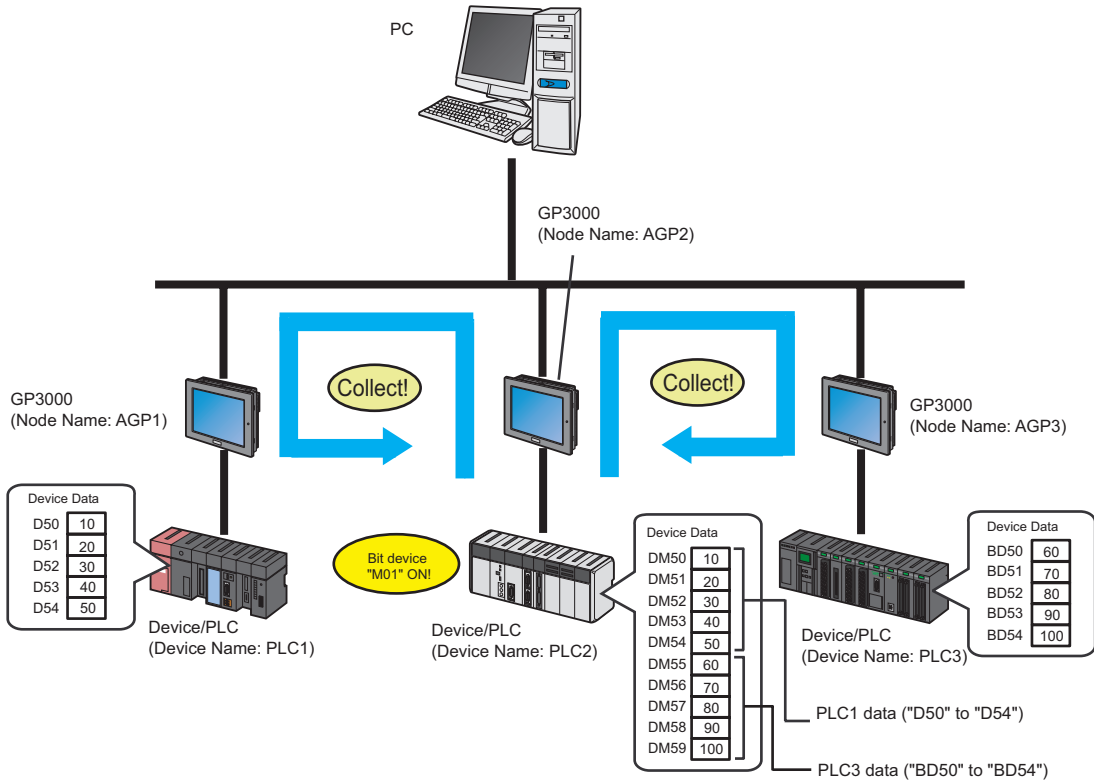

This section describes the setting procedures for executing the above action as an example.

- NOTE**
- When the transfer of the network project is completed, the PC is not necessary for operation.
 - Refer to [Action Example 1] for the action example of "Distribution Type".

👉 "19.1.1 Distributing Data"

[Setting Procedure]

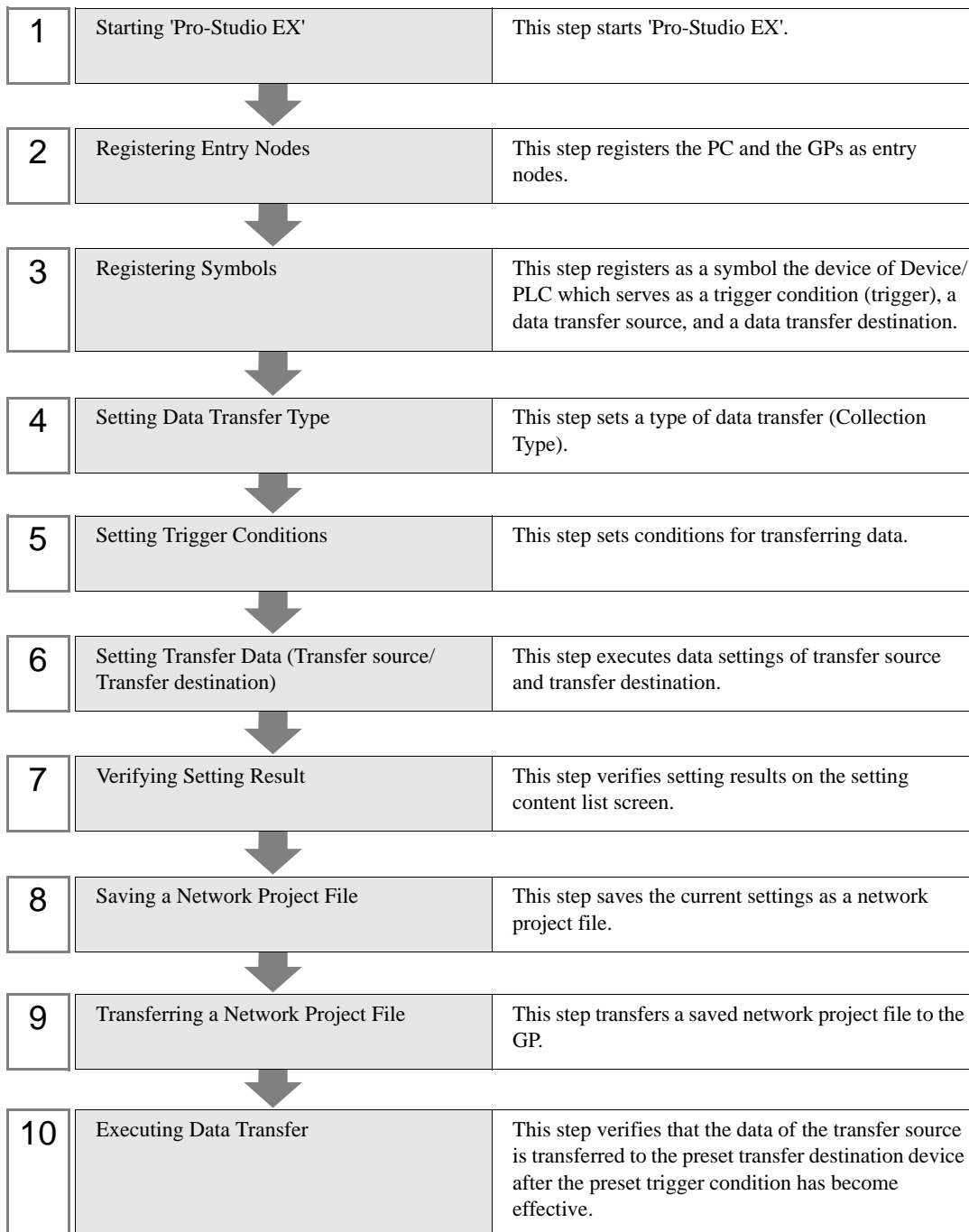

■ Starting 'Pro-Studio EX'

This step starts 'Pro-Studio EX'.

Refer to "3 Trial of Pro-Server EX" for details about starting method.

■ Registering Entry Nodes

This step registers the GPs connected with a network as nodes.

Refer to "31 Node Registration" for details about entry nodes.



Node Name :AGP1
 IP Address :192.168.0.100
 Device/PLC Information

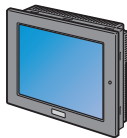

Node Name :AGP2
 IP Address :192.168.0.101
 Device/PLC Information

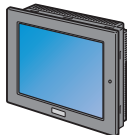

Node Name :AGP3
 IP Address :192.168.0.102
 Device/PLC Information

Ex.

GP (Transfer Source 1)

- GP : GP3000 series
- Node Name : AGP1
- IP Address : 192.168.0.100

GP (Transfer Destination)

- GP : GP3000 series
- Node Name : AGP2
- IP Address : 192.168.0.101

GP (Transfer Source 2)

- GP : GP3000 series
- Node Name : AGP3
- IP Address : 192.168.0.102

■ Registering Symbols

This step registers as a symbol the device of Device/PLC which serves as a trigger condition (trigger), a data transfer source, and a data transfer destination.

Refer to "32 Symbol Registration" for details about symbols.

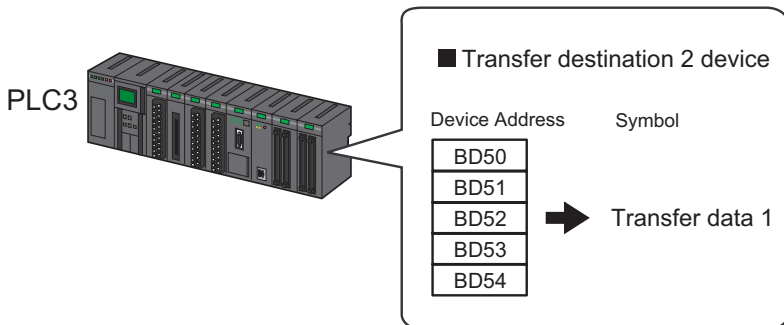
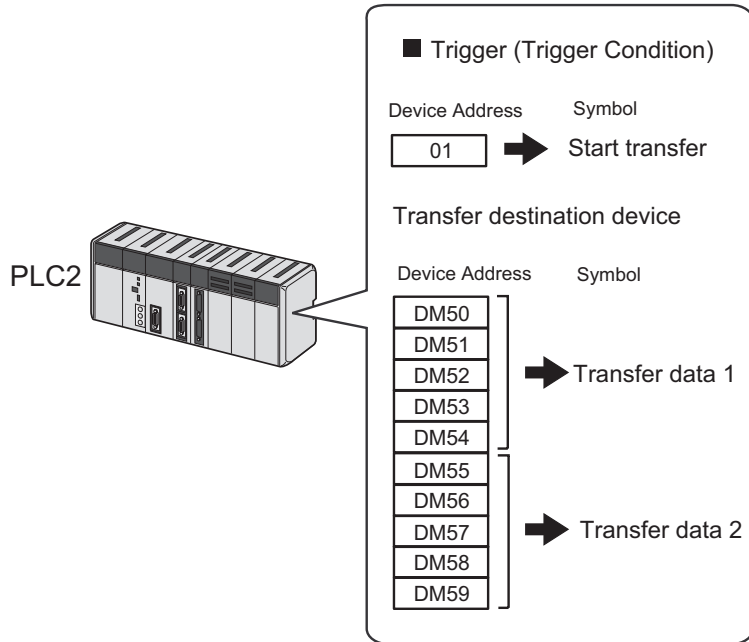
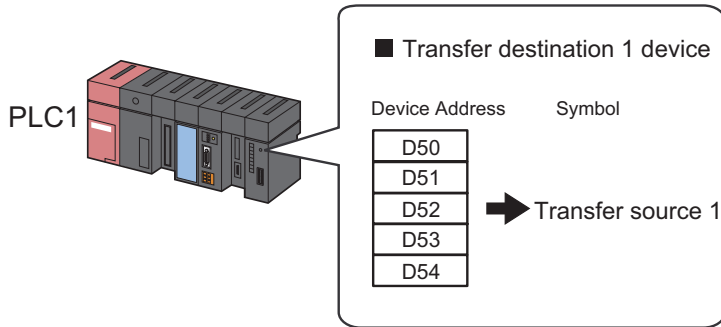

Ex.

- Trigger (trigger condition)

Setting item	Setting content
Symbol Name	Start transfer
Data Type	Bit
Device address for symbol registration	"01" of Device/PLC (PLC2)
No. of Devices	1

- Transfer Source Device

Setting item	Setting content	
Symbol Name	Transfer Source 1	Transfer Source 2
Data Type	16Bit (Signed)	
Device address for symbol registration	"DM50" to "DM54" of Device/PLC (PLC1)	"BD50" to "BD54" of Device/PLC (PLC3)
No. of Devices	5	5

- Transfer Destination Device

Setting item	Setting content	
Symbol Name	Transfer Data 1	Transfer Data 2
Data Type	16Bit (Signed)	
Device address for symbol registration	"DM50" to "DM54" of Device/PLC (PLC2)	"DM55" to "DM59" of Device/PLC (PLC2)
No. of Devices	5	5

■ Setting Data Transfer Type

This step sets a type of data transfer (Collection Type).

Ex.

Setting item	Setting content
Data Transfer Name	Data transfer
Transfer Type	Collection type

1 Click the [Feature] icon on the status bar.

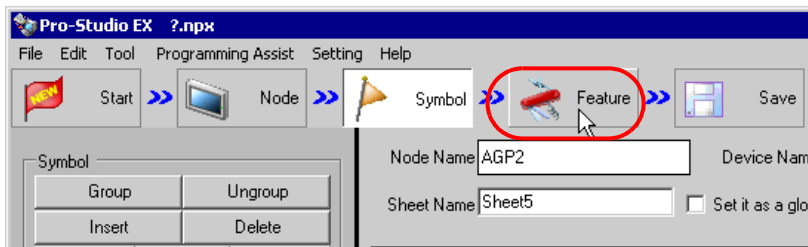

2 Select [Data Transfer] from the tree display on the left of the screen, then click the [Add] button.

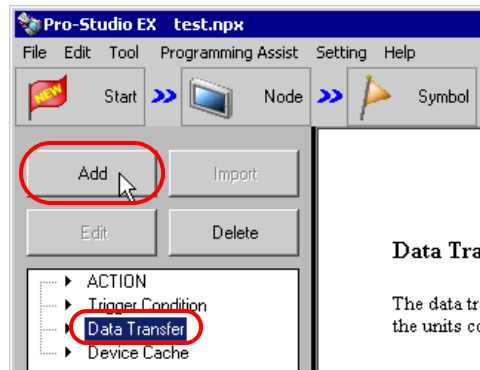

3 Enter "Data Transfer" in [Data Transfer Name] as a data transfer name to set, and then check [Collection Type].

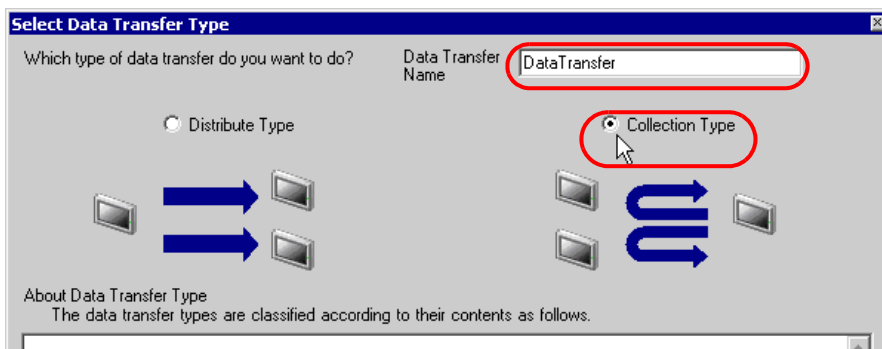

This is the end of data transfer type settings.

■ Setting Trigger Conditions

This step sets conditions (trigger bit ON) for transferring data.

Refer to "33 Trigger Conditions" for details about trigger conditions.

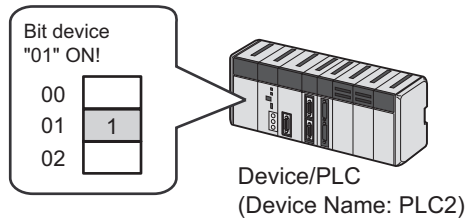

Ex.

- Trigger Condition Name: Turn on data transfer bit
- Trigger Condition: When "Transfer start" (01) is ON

1 On the "Select Data Transfer Type" screen, click the [Next] button.

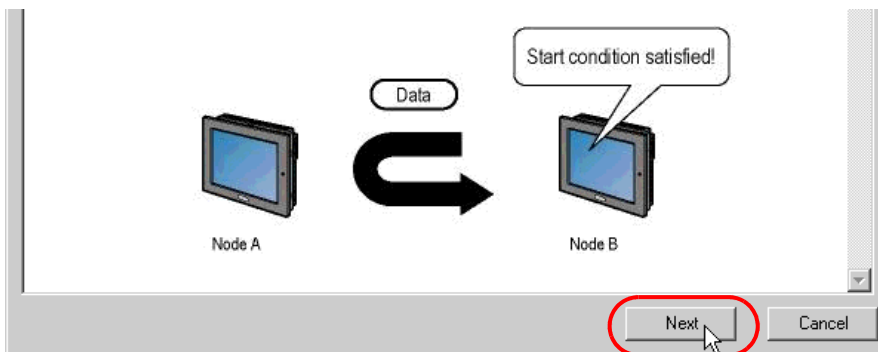

2 Click the [New Trigger Condition] button.

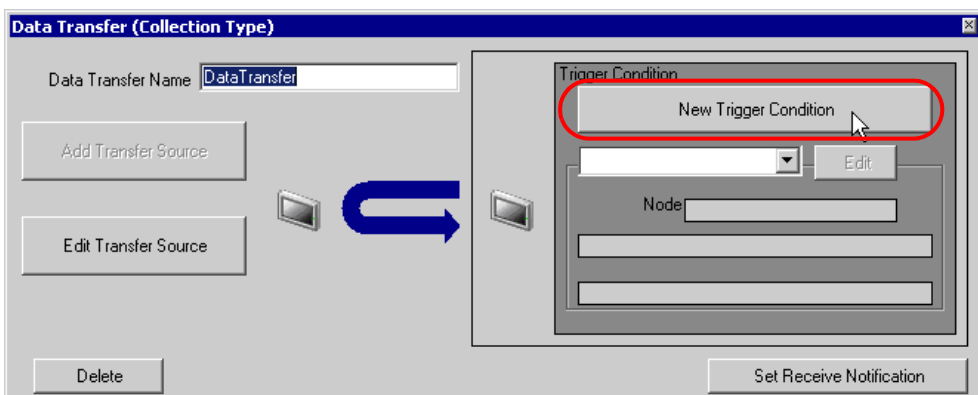

- Enter the trigger condition name "TurnOnDataTransferBit" in [Trigger Condition Name], and select "AGP2" in [Node Name] which has the device to serve as the trigger condition (trigger).

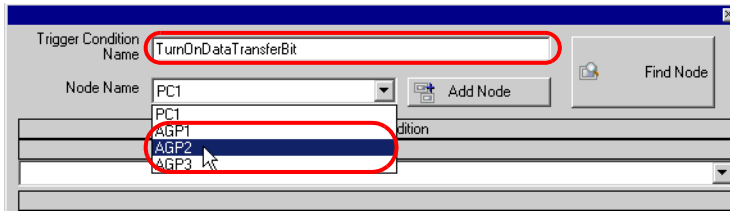

NOTE • Here, you are to specify the node having the device to be the trigger condition.
 ☞ "33 Trigger Conditions"

- Click the [When Device ON] button in the [Condition 1] tab and select "PLC2" for the device name.

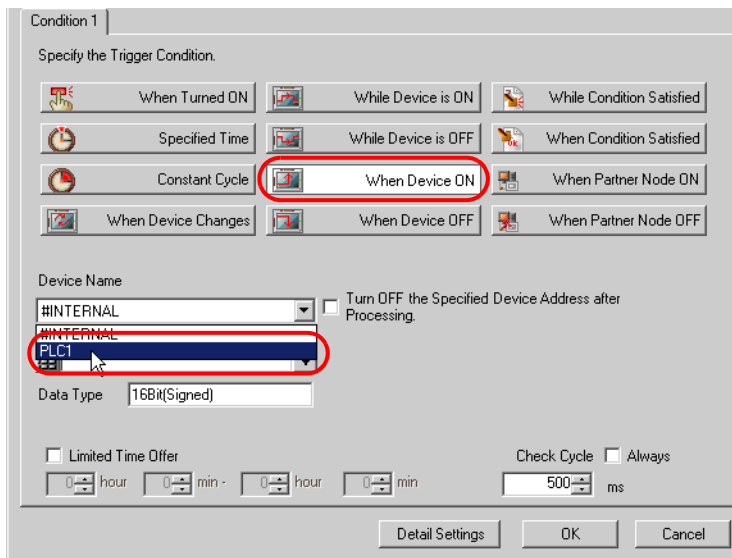

- 5 Click the [Device Address] list button and select "StartTransfer" for the symbol name of the device which serves as the trigger.

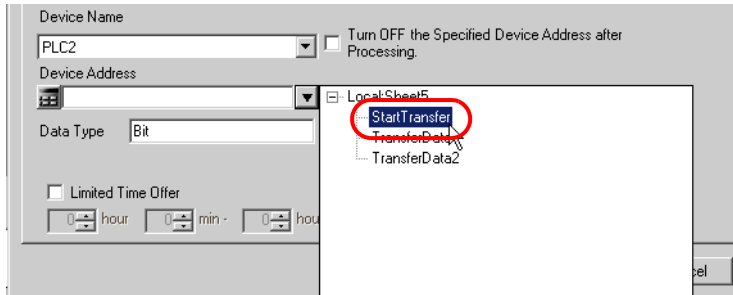

NOTE

- You can also set trigger conditions by combining 2 different types of conditions ("And" condition or "Or" condition).

 "33 Trigger Conditions"

- 6 Click the [OK] button.

This is the end of trigger condition settings.

■ Setting Transfer Data (Transfer source/Transfer destination)

This step sets data of transfer source and transfer destination.

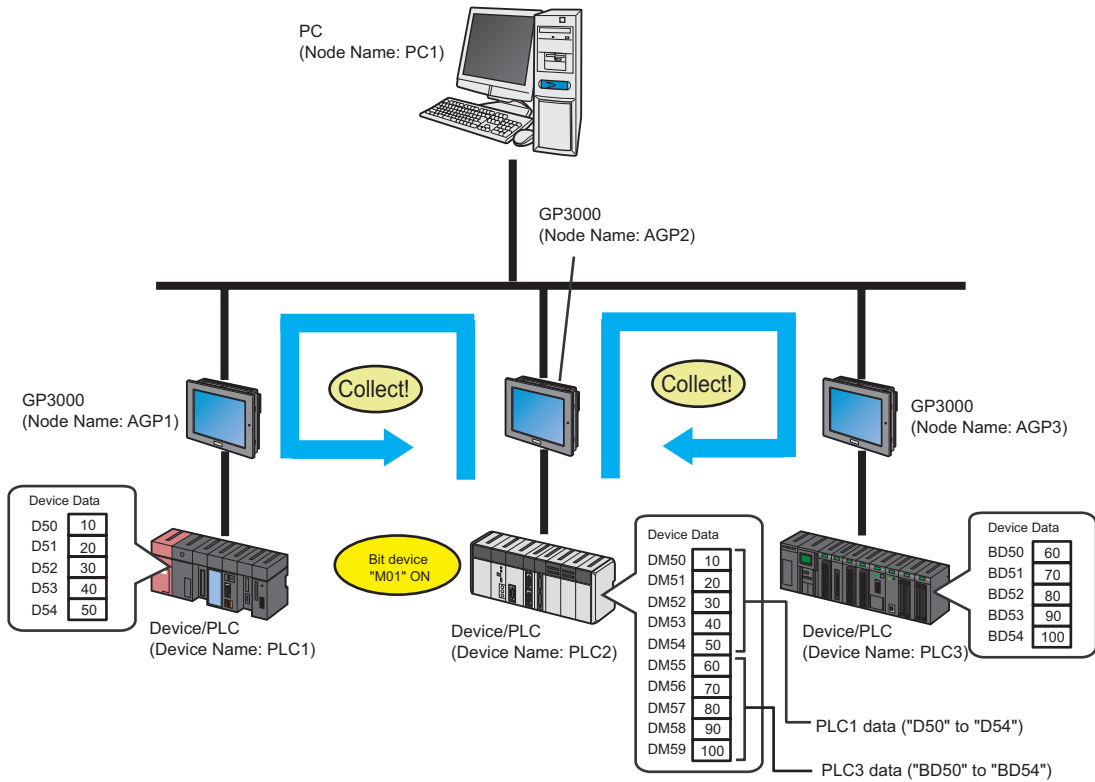

Ex.

- Transfer Source 1
Entry Node : AGP1
Device Name : PLC1
Device : Transfer Source 1
- Transfer Source 2
Entry Node : AGP3
Device Name : PLC3
Device : Transfer Source 2
- Transfer Destination 1
Entry Node : AGP2
Device Name : PLC2
Device : Transfer Data 1
- Transfer Destination 2
Entry Node : AGP2
Device Name : PLC2
Device : Transfer Data 2

- 1 On the "Data Transfer (Collection Type)" screen, click the [Add Transfer Source] button.

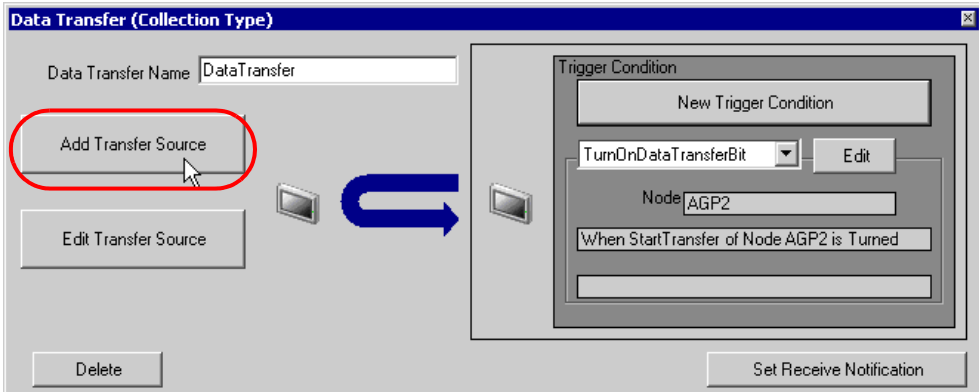

- 2 In [Transfer Source], click the list button of [Node] and then select "AGP1" as an entry node to be a data transfer source.

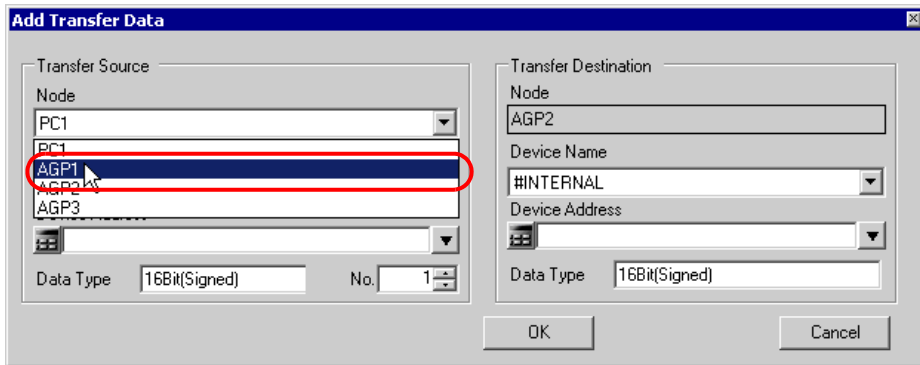

- 3 Click the list button of [Device Name] and select "PLC1" as a Device/PLC to be a data transfer source.

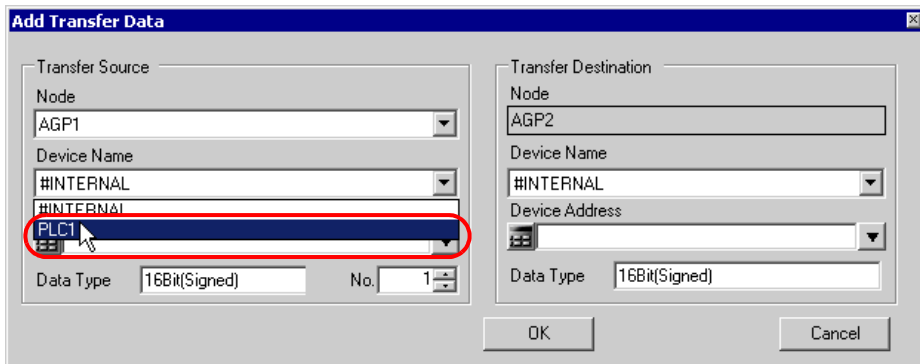

- Click [Device Address] and then click the list button. Select "Transfer Source 1" as a symbol name of a device to be a transfer source.

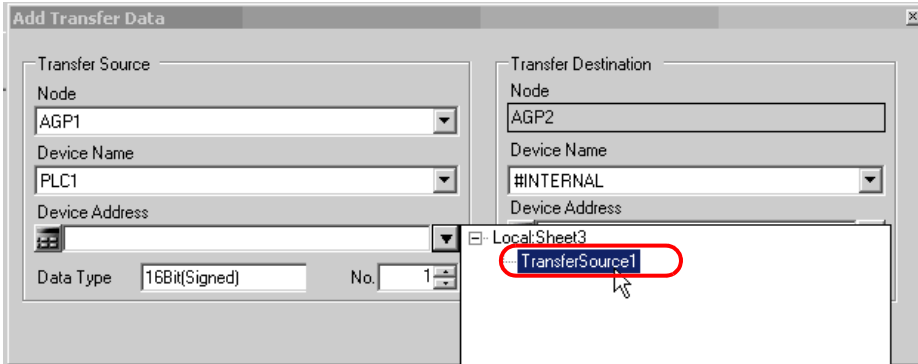

This is the end of the data settings of transfer source 1.
 Proceed to the data settings of transfer destination 1.

- Click the list button of [Device Name] and select "PLC2" as a Device/PLC to be a data transfer destination.

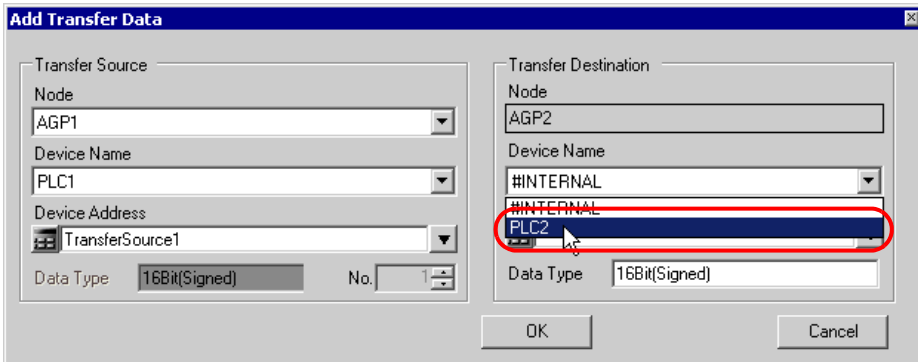

- Click the list button of [Device Address] and select "Transfer Data 1" as a symbol name of a device to be a transfer destination.

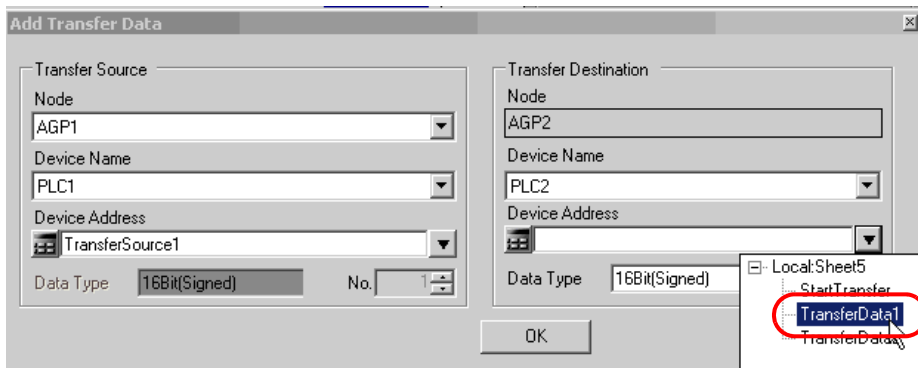

7 Click the [OK] button.

This is the end of the data settings of transfer destination 1.

Proceed to the data settings of transfer source 2 and transfer destination 2.

8 Click the [Add Transfer Source] button.

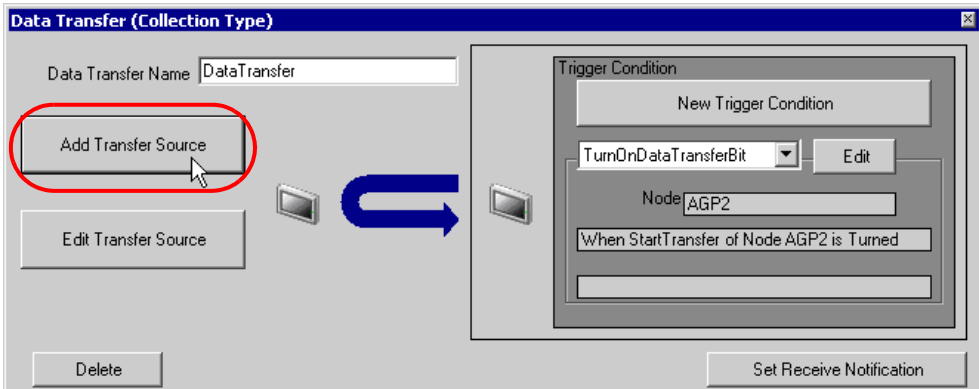

9 Set the items below in the same way as transfer source 1 and click the [OK] button.

Entry node of transfer source: AGP3

Device name of transfer source: PLC3

Device of transfer source: Transfer Source 2

Entry node of transfer destination: AGP2

Device name of transfer destination: PLC2

Device of transfer destination: Transfer Data 2

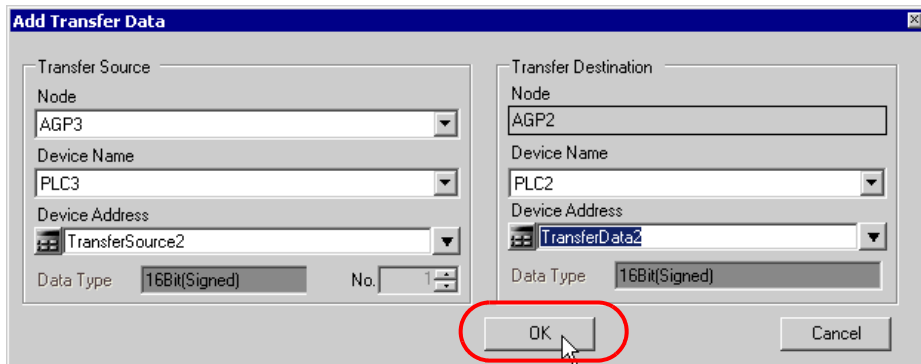

10 Click the [OK] button.

This is the end of the transfer data settings.

■ Verifying Setting Result

This step verifies setting results on the setting content list screen.

- 1 Select "Data Transfer" as a data transfer name from the tree display on the left of the screen.

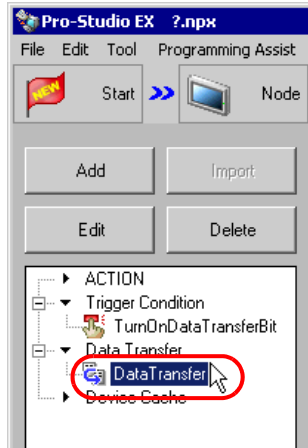

Confirm that the setting content appears on the right of the screen.

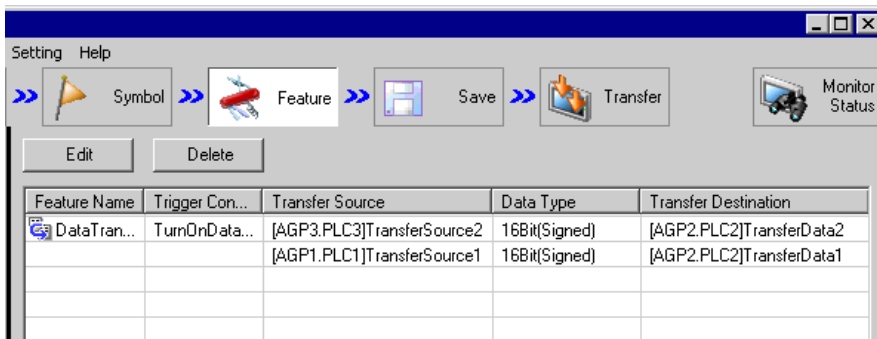

This is the end of the verification of the settings.

■ Saving a Network Project File

This step saves the current settings as a network project file.

Refer to "25 Saving" for details about saving a network project file.

IMPORTANT

- 'Pro-Server EX' reads a created network project file, and then executes data transfer according to the settings in the file. The settings therefore need be saved in the network project file.
-

Ex.

- Path of network project file : Desktop\Datatrans_collect.npx
- Title : Data Transfer

■ Transferring a Network Project File

This step transfers a saved network project file to entry nodes.

Refer to "26 Transferring" for details about transferring a network project file.

NOTE

- Be sure to transfer a network project file. If not, the data transfer feature will not work.
 - It is not necessary to reload the network project file during data transfer since the PC is not active then.
 - When [NPX ID] is selected under [Compare NPX Project on Connection] on the [Option Settings] screen, you need to transfer the network project to all nodes, including those which are not affected by the changes. When [NPX changes] is selected, you can transfer the network project only to nodes that are affected by the changes, unless the changes of the network project affect target items for comparison. This makes the transfer procedure easier in large-scale systems. Refer to the following section for more details on [Compare NPX Project on Connection].
 - When you change selection of [Compare NPX Project on Connection] on the [Option Settings] screen, execute the transfer to all nodes.
-

■ Executing Data Transfer

This step verifies that the data of the transfer source is transferred to the preset transfer destination device after the preset trigger condition has become effective.

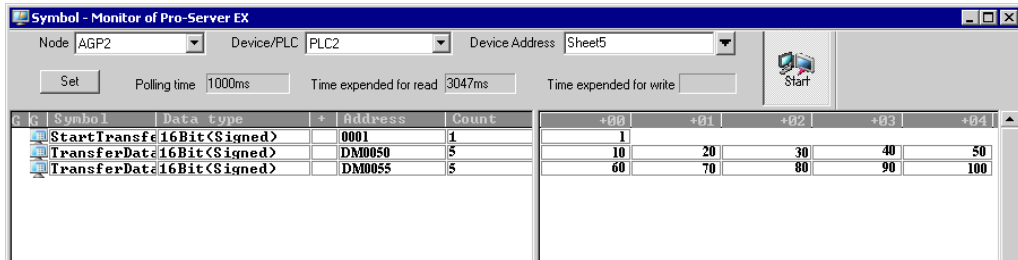

NOTE

- Check the actually written values with such function as monitor of rudder creation software.
- If you want to achieve faster communication during ACTION, refer to "29 Tips for Faster Communication".

This is the end of the explanation of data transfer (collection type).

19.2 Setting Guide

This section explains how to set each setting screen in detail.

19.2.1 Distribute Type

■ "Data Transfer (Distribute Type)" Screen

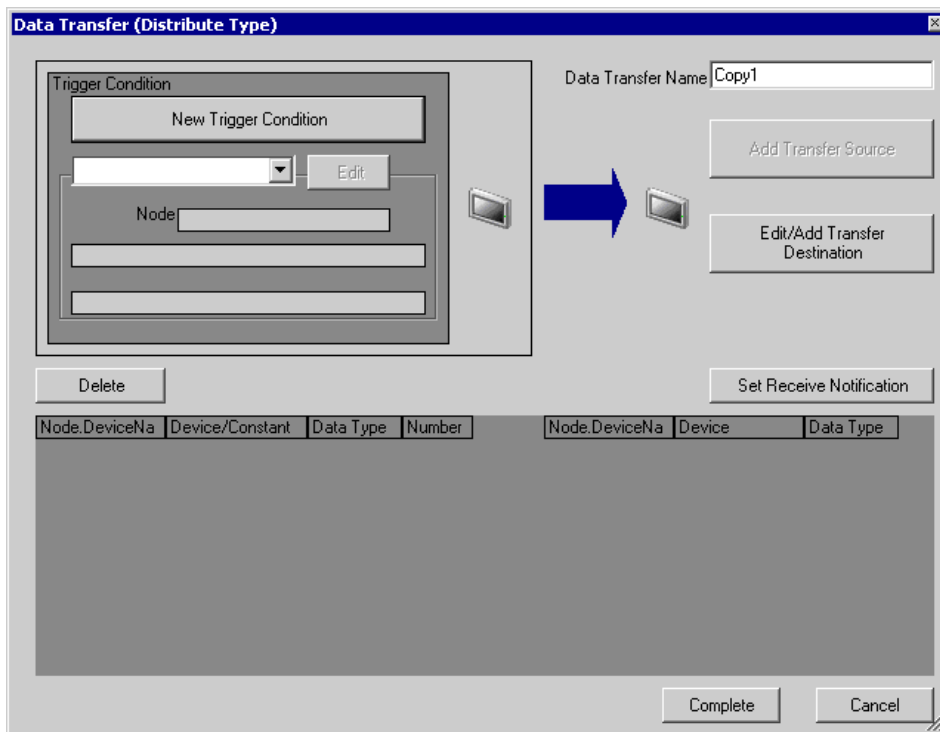

Setting item	Setting content
Trigger Condition	Click the [New Trigger Condition] button and enter a new trigger condition (trigger) for transferring data. Alternatively, click the list button and specify an existing trigger condition. ☞ "33 Trigger Conditions"
Data Transfer Name	Displays the name of the data transfer that you set on the "Select Data Transfer Type" screen.
Add Transfer Source	Displays the "Add Data Transfer" screen. Refer to "■"Add Transfer Data" Screen (Distribution Type)" for more details.
Edit/Add Transfer Destination	Displays the "Edit Data Transfer" screen. Refer to "■"Edit Transfer Data" Screen (Distribution Type)" for more details.
Set Receive Notification	Displays the receive notification settings screen. Refer to "■ Receive Notification Settings Screen" for more details.
Setting Content Display Window	Displays information of transfer source on the left side, and information of transfer destination on the right side.
Delete	Deletes selected contents.

■ "Add Transfer Data" Screen (Distribution Type)

Add Transfer Data

Transfer Source

Node: PC1

Device Name: #INTERNAL

Device Address

Constant Value

Data Type: 16Bit(Signed) No. 1

Transfer Destination

Node: PC1



Device Name: #INTERNAL

Device Address: [Selection Icon]

Data Type: 16Bit(Signed)

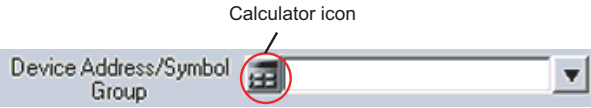
OK Cancel

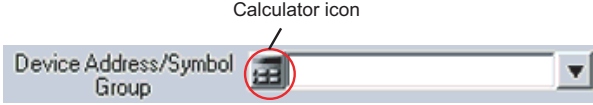

Setting item	Setting content
Transfer Source	<p>Node</p> <p>Displays an entry node (recognized automatically as a transfer source) that includes a device to cause a trigger condition (trigger) that you set in the step of trigger condition settings.</p>
	<p>Device Name</p> <p>Specify a Device/PLC to be a data transfer source.</p>
	<p>Device Address</p> <p>Check this to transfer device values.</p> <ul style="list-style-type: none"> When specifying a device address: Enter directly from the Calculator icon.  <p style="text-align: right;">List button</p> <ul style="list-style-type: none"> When specifying a symbol: Select the symbol by clicking the list button.  <p style="text-align: center;">Calculator icon</p>
<p>Constant Value</p> <p>Check this to transfer a constant value. Type the constant value in the text box.</p> <p>NOTE</p> <ul style="list-style-type: none"> (1) Specifying a numeral: Specify the numeral itself. Insert a space to specify two or more numerals. (Example) 10 11 12 13 14 15 (2) Specifying a character string: Specify the string itself if typable from the keyboard (except for []). (Example) When specifying ABC: ABC <p>Specify an untypable string such as a control code by representing its character code in hexadecimal notation, and enclosing it in parentheses []. (Example) When specifying ABC followed by Carriage return and Line field: ABC[0C][0A]</p> <p>Specify [by enclosing it in parentheses []. (Example) When specifying ABC followed by [: ABC[[]</p>	

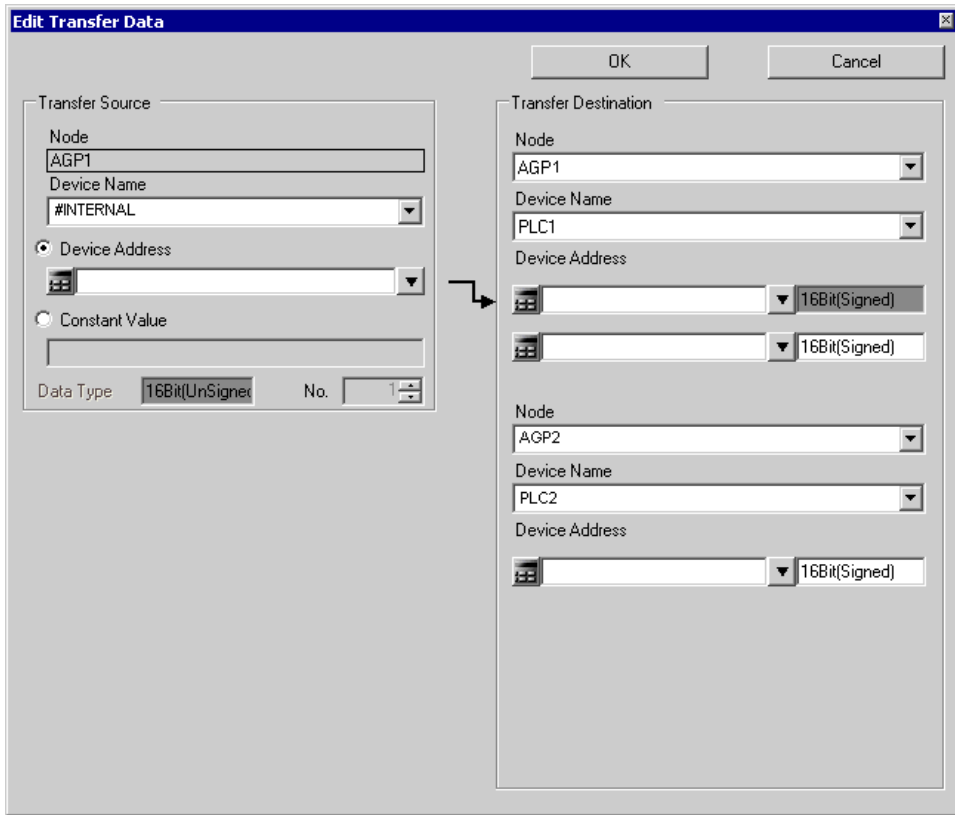

Setting item		Setting content
Transfer Source	Data Type	<p>Displayed automatically according to the device (symbol) entered in the Device Address.</p> <p>NOTE</p> <ul style="list-style-type: none"> When the symbol has been imported from 'GP-Pro EX', it is necessary to specify the data type.
	No.	<p>Displayed automatically according to the device (symbol) entered in the Device Address.</p> <p>NOTE</p> <ul style="list-style-type: none"> When the symbol has been imported from 'GP-Pro EX', or when created in 'Pro-Server V4.X', it is necessary to specify the number.
Transfer Destination	Node	Selects an entry node to be a data transfer destination.
	Device Name	Selects a Device/PLC to be a data transfer destination.
	Device Address	<ul style="list-style-type: none"> When specifying a device address: Enter directly from the Calculator icon.  <ul style="list-style-type: none"> When specifying a symbol: Select the symbol by clicking the list button. 
Data Type	<p>Displayed automatically according to the device (symbol) entered in the Device Address.</p> <p>NOTE</p> <ul style="list-style-type: none"> When the symbol has been imported from 'GP-Pro EX', it is necessary to specify the data type. 	

■ "Edit Transfer Data" Screen (Distribution Type)

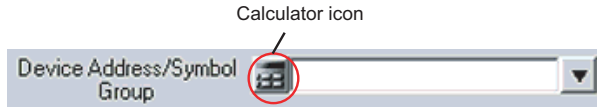

Setting item		Setting content
Transfer Source	Node	Displays an entry node (recognized automatically as a transfer source) that includes a device to cause a trigger condition (trigger) that you set in the step of trigger condition settings.
	Device Name	Specify a Device/PLC to be a data transfer source.

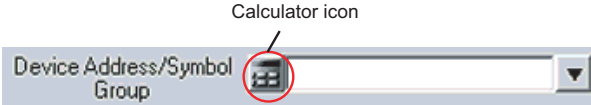
Setting item		Setting content
Transfer Source	Device Address	<p>Check this to transfer device values.</p> <ul style="list-style-type: none"> When specifying a device address: Enter directly from the Calculator icon.  <ul style="list-style-type: none"> When specifying a symbol: Select the symbol by clicking the list button. 
	Constant Value	<p>Check this to transfer a constant value. Type the constant value in the text box.</p> <p>NOTE</p> <ul style="list-style-type: none"> Specifying a numeral: Specify the numeral itself. Insert a space to specify two or more numerals. (Example) 10 11 12 13 14 15 Specifying a character string: Specify the string itself if typable from the keyboard (except for []). (Example) When specifying ABC: ABC <p>Specify an untypable string such as a control code by representing its character code in hexadecimal notation, and enclosing it in parentheses []. (Example) When specifying ABC followed by Carriage return and Line field: ABC[0C][0A]</p> <p>Specify [by enclosing it in parentheses []. (Example) When specifying ABC followed by [: ABC[]</p>
	Data Type	<p>Displayed automatically according to the device (symbol) entered in the Device Address.</p> <p>NOTE</p> <ul style="list-style-type: none"> When the symbol has been imported from 'GP-Pro EX', it is necessary to specify the data type.
	No.	<p>Displayed automatically according to the device (symbol) entered in the Device Address.</p> <p>NOTE</p> <ul style="list-style-type: none"> When the symbol has been imported from 'GP-Pro EX', or when created in 'Pro-Server V4.X', it is necessary to specify the number.

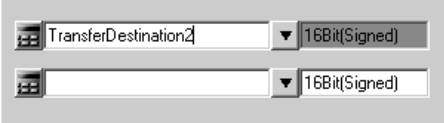
	Setting item	Setting content
Transfer Destination	Node	Selects an entry node to be a data transfer destination.
	Device Name	Selects a Device/PLC to be a data transfer destination.
	Device Address	<ul style="list-style-type: none"> When specifying a device address: Enter directly from the Calculator icon.  <ul style="list-style-type: none"> When specifying a symbol: Select the symbol by clicking the list button. 
Device Address (Add)	<p>To add a device to be a transfer destination, enter the address or symbol of the device to add in the blank field below.</p> 	

Setting item		Setting content
Transfer Destination (Add)	Node Device Name Device Address	<p>To add a new entry node or Device/PLC in the Transfer Destination, enter the address or symbol of the transfer destination to add in the blank field below.</p> <div style="border: 1px solid gray; padding: 10px; margin: 10px auto; width: fit-content;"> <p>Transfer Destination</p> <p>Node <input type="text" value="AGP1"/></p> <p>Device Name <input type="text" value="PLC1"/></p> <p>Device Address <input type="text" value="TransferData1"/> <input type="text" value="16Bit(Signed)"/> <input type="text" value=""/> <input type="text" value="16Bit(Signed)"/></p> <p>Node <input type="text" value="AGP2"/></p> <p>Device Name <input type="text" value="PLC2"/></p> <p>Device Address <input type="text" value="TransferData2"/> <input type="text" value="16Bit(Signed)"/> <input type="text" value=""/> <input type="text" value="16Bit(Signed)"/></p> </div>

19.2.2 Collection Type

■ "Data Transfer (Collection Type)" Screen

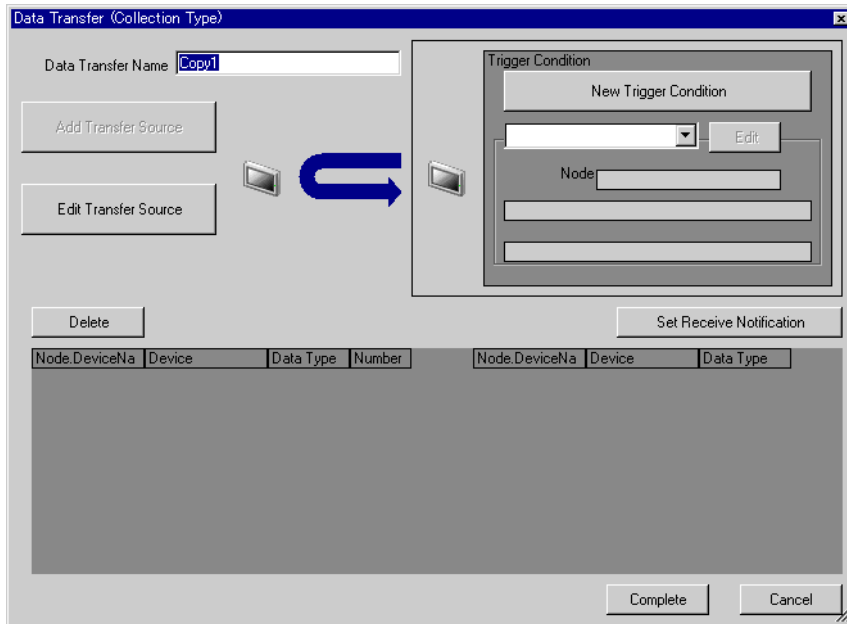

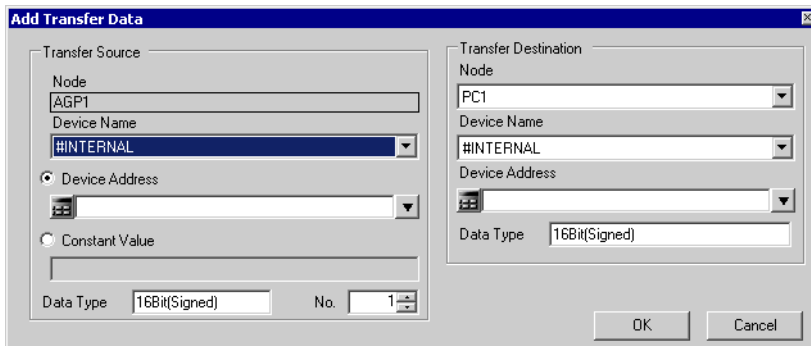

Setting item	Setting content
Trigger Condition	Click the [New Trigger Condition] button and enter a new trigger condition (trigger) for transferring data. Alternatively, click the list button and specify an existing trigger condition. ☞ "33 Trigger Conditions"
Data Transfer Name	Displays the name of the data transfer that you set on the "Select Data Transfer Type" screen.
Add Transfer Source	Displays the "Add Data Transfer" screen. Refer to "■"Add Transfer Data" Screen / "Edit Transfer Data" Screen (Collection Type)" for more details.
Edit Transfer Source	Displays the "Edit Data Transfer" screen. Refer to "■"Add Transfer Data" Screen / "Edit Transfer Data" Screen (Collection Type)" for more details.
Set Receive Notification	Displays the receive notification settings screen. Refer to "■ Receive Notification Settings Screen" for more details.
Setting Content Display Window	Displays information of transfer source on the left side, and information of transfer destination on the right side.
Delete	Deletes selected contents.

■ "Add Transfer Data" Screen / "Edit Transfer Data" Screen (Collection Type)

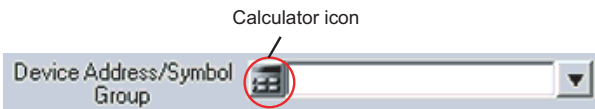

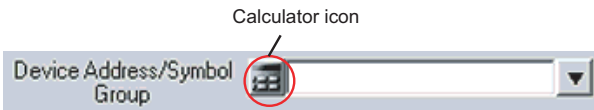
Setting item		Setting content
Transfer Source	Node	Selects an entry node to be a data transfer source.
	Device Name	Selects a Device/PLC to be a data transfer source.
	Device Address	<ul style="list-style-type: none"> When specifying a device address: Enter directly from the Calculator icon.  <ul style="list-style-type: none"> When specifying a symbol: Select the symbol by clicking the list button. 
	Data Type	Displayed automatically according to the device (symbol) entered in the Device Address. NOTE <ul style="list-style-type: none"> When the symbol has been imported from 'GP-Pro EX', it is necessary to specify the data type.
Transfer Destination	Node	Displays the entry node (recognized automatically as a transfer destination) that you set in the step of trigger condition settings.
	Device Name	Selects a Device/PLC to be a data transfer destination.

Setting item		Setting content
Transfer Destination	Device Address	<ul style="list-style-type: none"> When specifying a device address: Enter directly from the Calculator icon.  <ul style="list-style-type: none"> When specifying a symbol: Select the symbol by clicking the list button. 
	Data Type	<p>Displayed automatically according to the device (symbol) entered in the Device Address.</p> <p>NOTE</p> <ul style="list-style-type: none"> When the symbol has been imported from 'GP-Pro EX', it is necessary to specify the data type.

■ Receive Notification Settings Screen

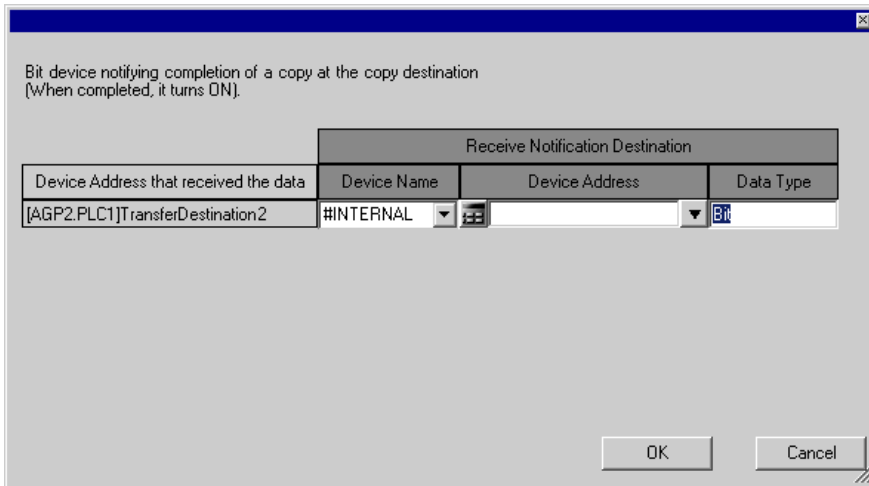

Setting item		Setting content
Device Address that received the data		<p>Displays the device address (symbol) you set.</p>
Receive Notification Destination	Device Name	Selects a Device/PLC to be a receive notification destination.
	Device Address	<p>When the "Receive Notification" is turned on, the specified bit device will be turned on when data transfer is completed. Enter a device address itself of the Device/PLC, or alternatively, click the list button to select a symbol.</p> <p>NOTE</p> <ul style="list-style-type: none"> To execute ACTION sequentially after the data transfer is completed, this can be used as a trigger condition (trigger) of the subsequent ACTION.

19.3 Restrictions

■ Restrictions on Data Transfer

- (1) In the case of data transfer of collection type, the transfer destination must not be the one selected from GP Series nodes.
- (2) If the transfer source node or transfer destination node is a GP Series node, you cannot specify a group as the device address.
- (3) When General Broadcast is set, you cannot transfer to the WinGP node.
- (4) A GP Series node can process up to three times of transfer and reception operations when one trigger condition has been satisfied. Consequently the maximum registration number is three when you specify the same GP Series node as transfer source nodes or transfer destination nodes.
- (5) In the case when the transfer source and the transfer destination are the ones selected from GP Series nodes and the devices are the ones with physical size of 32 bits, the data type must not be of 16 bits width.
- (6) In the case when the specified transfer source and the specified transfer destination of transfer data are of BCD type, BCD conversion will not be executed. The BCD data will be handled as binary data.
In the case when BCD code is used for trigger conditions (trigger) or for the computing equation of trigger conditions (trigger), it will be recognized after the conversion of BCD code to binary code. In the case of access via Pro-Easy API, BCD conversion will be executed.
 "37.2 Restrictions on Pro-Server EX"
- (7) In the case when the number of data of the specified symbols is different between the transfer source and the transfer destination, the number of data equal to that of the transfer source will be transferred.
- (8) Maximum registerable number of data transfer, the total number of data transfer destination plus ACTION, must be 3000.
- (9) To transfer the data from the GP2000 Series to the WinGP node, update the 2Way driver version to 4.55 or later.
- (10) When [NPX ID] is selected under [Compare NPX Project on Connection] on the [Option Settings] screen, you need to transfer the network project to all nodes, including those which are not affected by the changes. When [NPX changes] is selected, you can transfer the network project only to nodes that are affected by the changes, unless the changes of the network project affect target items for comparison. This makes the transfer procedure easier in large-scale systems. Refer to the following section for more details on [Compare NPX Project on Connection].
- (11) When you change selection of [Compare NPX Project on Connection] on the [Option Settings] screen, execute the transfer to all nodes.

(12) The transferable data type depends on the type of entry node. The following shows combination of the transferable data types and entry nodes.

Data transfer is possible even between different types of data. The explanation about data conversion rule and restrictions in this case is given below.

- Data Transfer between: GP3000 Series node and GP Series node; WinGP node and GP Series node; GP Series node and GP Series node; and GP Series node and Pro-Server EX node

Transferable only when the transfer source and the transfer destination are of same data type.

- Data Transfer between: GP3000 Series node and GP 3000 Series node; GP 3000 Series node and Pro-Server EX node; WinGP node and WinGP node; WinGP node and Pro-Server EX node; and Pro-Server EX node and Pro-Server EX node

		The data type of transfer destination											
		Bit	16Bit(Signed)	16Bit(Unsigned)	16Bit(HEX)	16Bit(BCD)	32Bit(Signed)	3216Bit(Unsigned)	32Bit(HEX)	32Bit(BCD)	Float	Double	String
The data type of transfer source	Bit	○	○ Ex.1				○ Ex.2			×	×	○ *1	×
	16Bit (Signed)	○ Ex.1	○		○ *2	○ Ex.3		○ *3	×	×	○ *4	○ Ex.4	
	16Bit (Unsigned)				○			○ *5					○ *6
	16Bit(HEX)		○	○		○	○						
	16Bit(BCD)				○			○			○		○
	32Bit (Signed)	○ Ex.2	○ Ex.5			○ *7	○		○ *8	×		×	
	32Bit (Unsigned)				○	○ *10			○ *11		○		○
	32Bit(HEX)		○	○			○	○					
	32Bit(BCD)				○	○			○		○		○
	Float	×	×				×			○		×	
	Double	×	×				×			×	○	×	×
	String	○ *12	○ Ex.7		×	○ Ex.8		×	×	×	×	○ *13	×
	Group	×	○ Ex.4				○ Ex.6			×	×	×	○ Ex.9

○: Transferable
 X: Not Transferable

- *1 Expands each bit of the bit string to 8 bits. For example, writes 0 if 0, writes 0xff if 1.
- *2 In 16-bit unit, converts binary code to BCD code and writes.
- *3 Converts two 16-bit data from binary code to BCD code and copies them as a BCD data of 32 bits.
- *4 Copies 16-bit data without conversion.
- *5 In 16-bit unit, converts BCD code to binary code and writes.
- *6 In 16-bit unit, converts BCD code to binary code and copies two 16-bit data as a 32-bit data.
- *7 In 32-bit unit, converts binary code to BCD code and writes a 32-bit data as two 16-bit data.
- *8 In 32-bit unit, converts binary code to BCD code and writes.
- *9 Copies 32-bit data without conversion.
- *10 In 32-bit unit, converts BCD code to binary code and copies a 32-bit data as two 16-bit data.
- *11 In 32-bit unit, converts BCD code to binary code and writes.
- *12 In 8-bit unit, writes 0 if 0, and creates and writes one-bit string if not 0. (Conversion in character string mode not executed)
- *13 Converts data in character string mode both in the transfer source and the transfer destination, and copies. Refer to "Data Conversion Example" for explanations about Example 1 to Example 9.

Data Conversion Example

1) In the case of transferring data of bit symbol or bit device itself and of each data type.

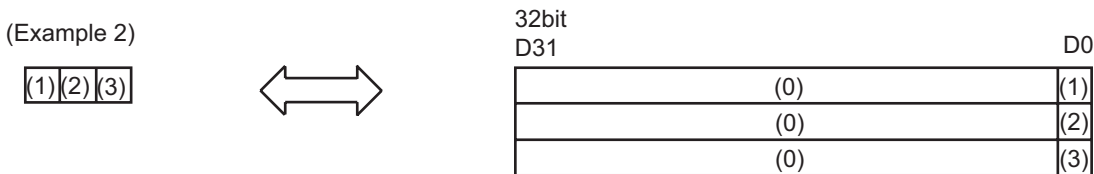
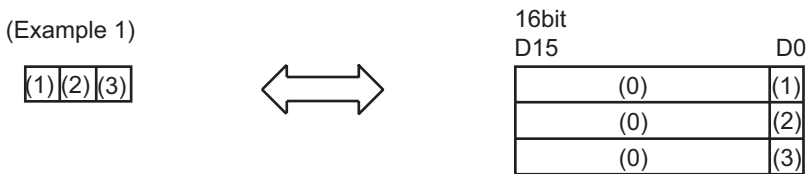

- 2) In the case of transferring data using the group symbol with the following structure (A combination of bit symbol, word symbol and bit symbol; the number of data of which are 1, 1, and 3, respectively).

(Example 4)

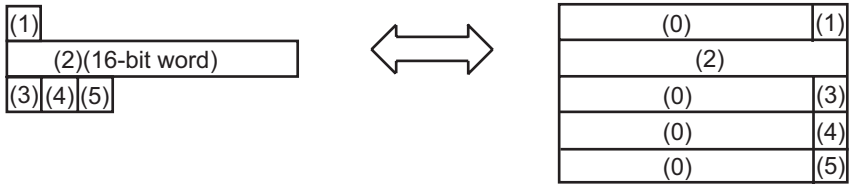

(Example 6)

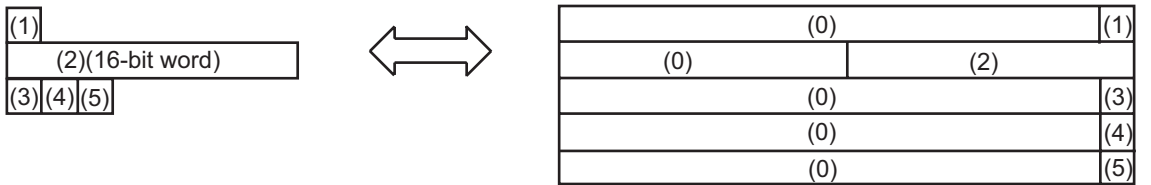

(Example 9)

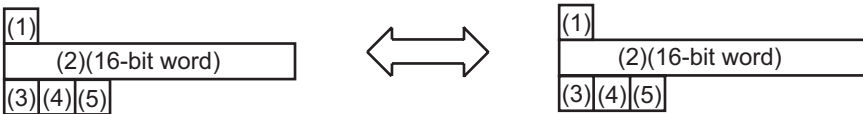

- 3) In the case of transferring 16-bit data

(Example 3)

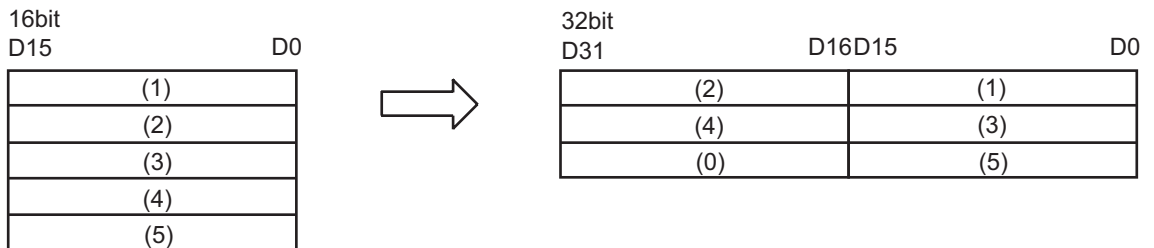

4) In the case of transferring 32-bit data

(Example 5)

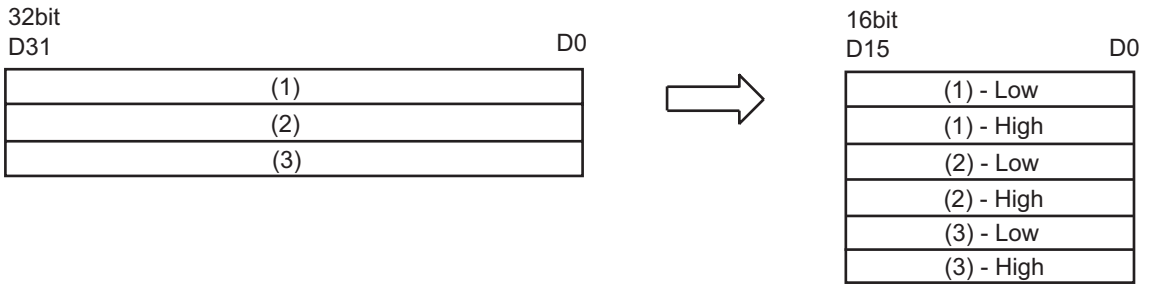

NOTE • The order of Low and High on the 16-bit side depends on the type of the Device/PLC. Refer to 'GP-Pro EX Device/PLC Connection Manual' for more details.

5) In the case of transferring character string data

(Example 7)

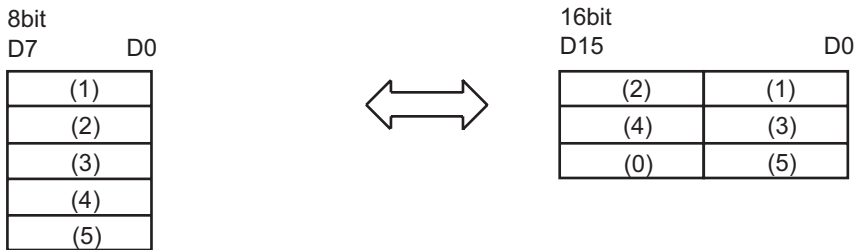

(Example 8)

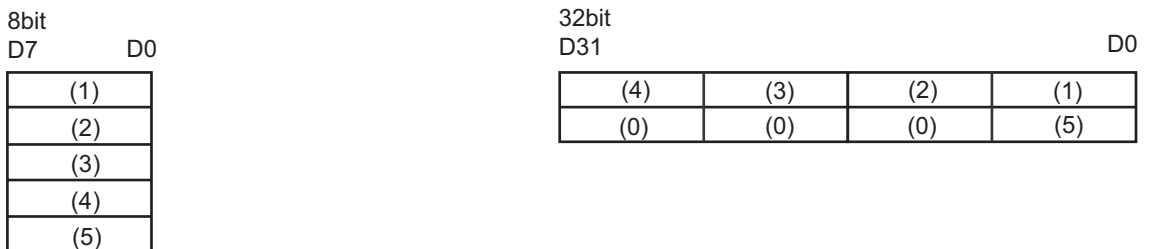

NOTE • When the transfer destination is of character string, the conversion method depends on the physical size of the transfer destination; 16 bits or 32 bits.
 • The order of the character string depends on the character string mode.