

# 32



# Trigger Conditions

32.1	What is a Trigger Condition?.....	32-2
32.2	Editing Trigger Conditions.....	32-36
32.3	Deleting Trigger Conditions.....	32-38
32.4	Sequential Execution of Multiple Data Transfers and ACTIONS with One Trigger Condition.....	32-39
32.5	Executing ACTION under Multiple Trigger Conditions.....	32-49

## 32.1 What is a Trigger Condition?

'Pro-Server EX' performs many operations such as data transfer and ACTION at various timings and cycles. This timing or cycle is called as a "Trigger condition".

You can set multiple trigger conditions at one time, set new conditions and use them in combination with the existing ones.

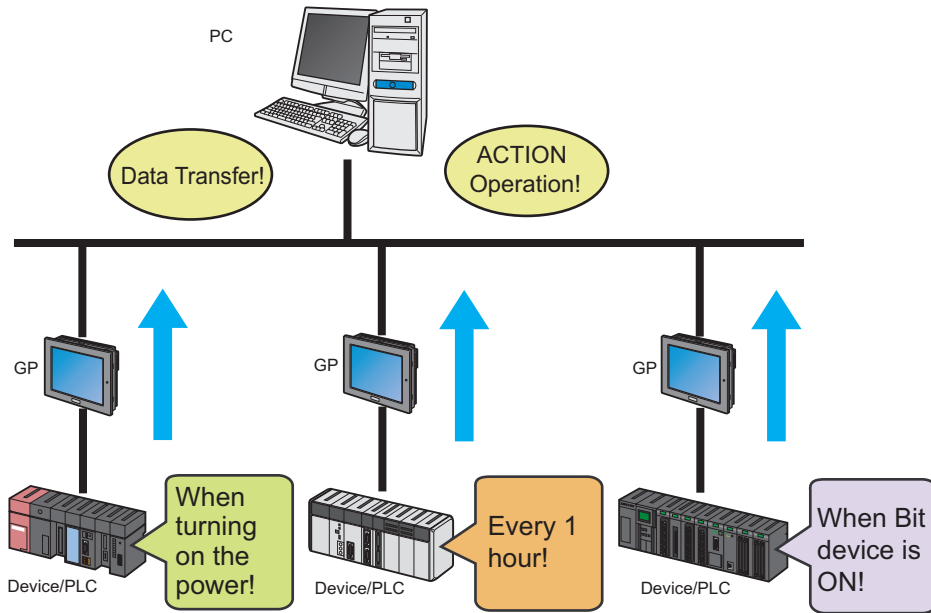

The set contents of "Trigger conditions" to be specified on 'Pro-Server EX' are as follows:

< For data transfer >

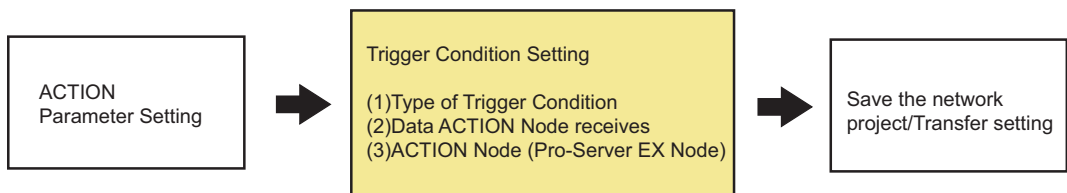

< For ACTION >

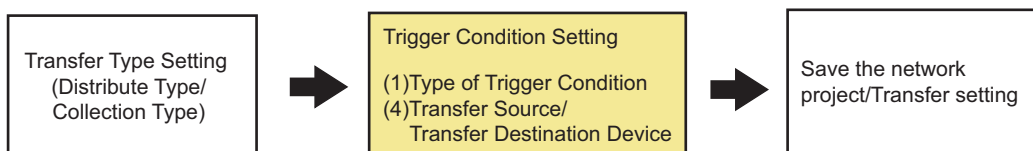

### ■ Types of trigger conditions

Specify the timing or cycle for data transfer and ACTION execution.

Trigger conditions are available of 12 types for 'Pro-Server EX' (8 types for GP Series).

☞ "32.1.1 Types of Trigger Conditions"

### ■ Data received by ACTION (ACTION)

Specify the device data or fixed number received from the transfer source when the trigger conditions become effective.

☞ "32.1.2 Data Received by ACTION"

### ■ Action operating node/Implementation notice (ACTION)

Specify the entry node operating the specified ACTION (normally a personal computer). When the ACTION is implemented, moreover, it is possible to notify the ACTION implementation by setting the notified destination (Bit on).

☞ "32.1.3 ACTION Nodes"

### ■ Device of Transfer source/Transfer destination (Data transfer)

Specify the device of the data transfer source and destination when the trigger conditions become effective.

☞ "18.1.1 Distributing Data"

☞ "18.1.2 Collecting Data"

Normally, trigger conditions are to be set in the process of setting data transfer and ACTION, but you can set the trigger conditions separately for the ACTION and data transfer setting. In addition, it is possible to register multiple trigger conditions, change these conditions (See the next step.) and use them in combination with other conditions.

As a result, one trigger condition allows multiple data transfer and multiple ACTION execution, and multiple trigger conditions perform one ACTION execution easily.

### Execute Multiple Data Transfer by One Trigger Condition/ACTION

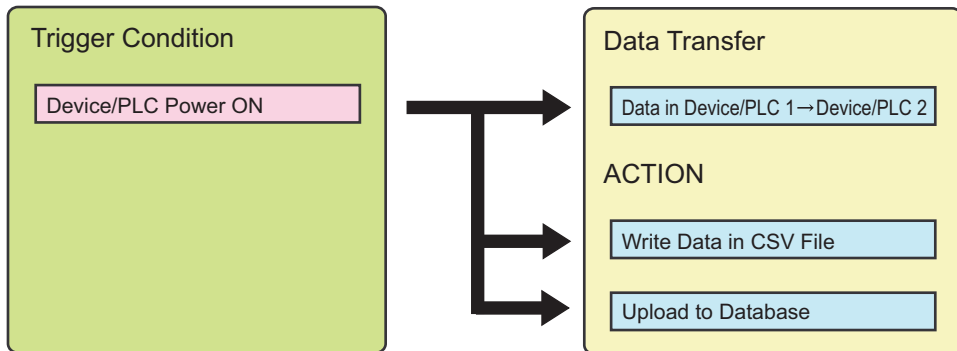

### Execute One ACTION by Multiple Trigger Conditions

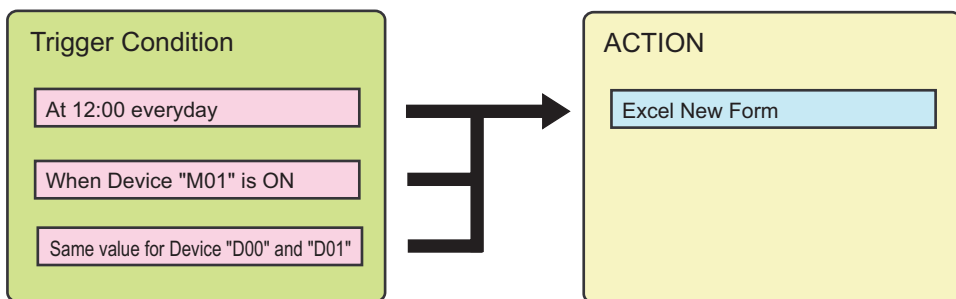

---

**NOTE** • As for the data transfer, specification of multiple trigger conditions is not available.

---

### 32.1.1 Types of Trigger Conditions

On 'Pro-Studio EX', you can specify the following trigger conditions:

Trigger condition	Description
Power ON	Provides only once when the power of provider node is turned ON.
ON Time	Provides only once at the specified time.
Constant Cycle	Provides at the specified cycle.
At Device Change	Provides when the device data of the specified symbol is changed.
While Device On/Off	Provides while the device of the specified symbol is On or Off. You can also specify the execution timing and check cycle.
At Device On/Off	Provides when the device of the specified symbol turns On or Off. You can also specify the execution timing and check cycle.
While/When conditional expression satisfied (Excluding the case that the node is GP Series)	Provides while the conditional expression that has been specified is satisfied between 2 devices. (Ex.: Device A and B have the same data value.) You can also specify the execution timing and check cycle.
When partner node turned On/Off (Excluding the case that the node is GP Series)	Provides only once when the specified partner node is turned On or Off. You can also specify the execution timing and check cycle.

■ Power ON

Provides only once when the power of provider node is turned ON.

**NOTE**

- Provides also when:
  - 'Pro-Server EX' is executed and loaded;
  - A network project file is reloaded; and
  - The provider is changed to online mode from offline mode.

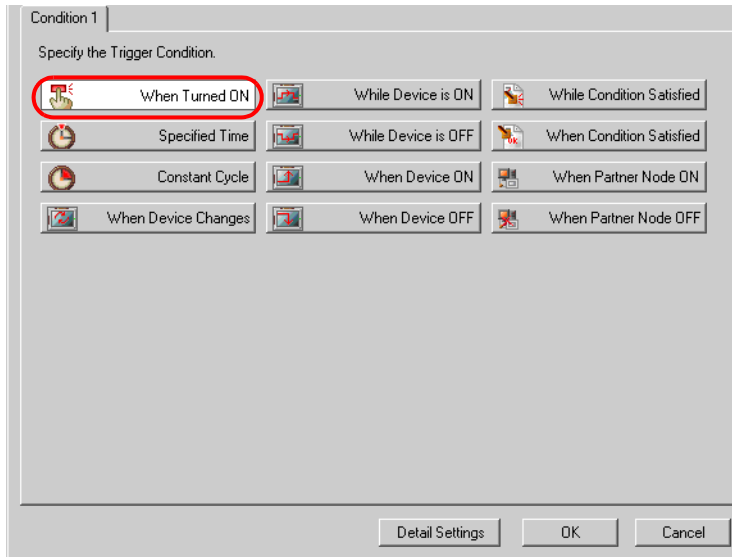

Setting item	Setting content
No items to be specified.	
Detail Settings	The "Set Trigger Condition Details" screen appears. Specify the methods of completion notification and communication. Refer to "◆ "Set Trigger Condition Details" Screen" for more details.

■ ON Time

Provides only once at the specified time.

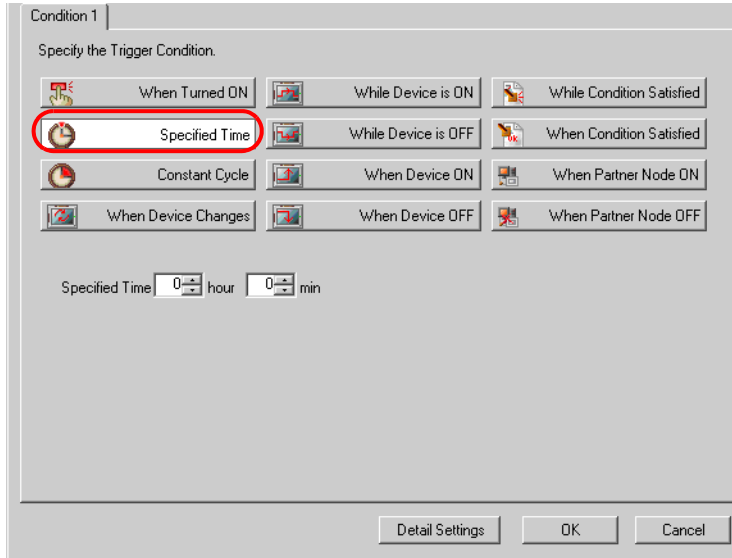

Setting item	Setting content
Specified Time	Specify the executing timing.
Detail Settings	The "Set Trigger Condition Details" screen appears. Specify the methods of completion notification and communication. Refer to "◆ "Set Trigger Condition Details" Screen" for more details.

■ Constant Cycle

Provides at the specified cycle.

You can also specify the period for execution.

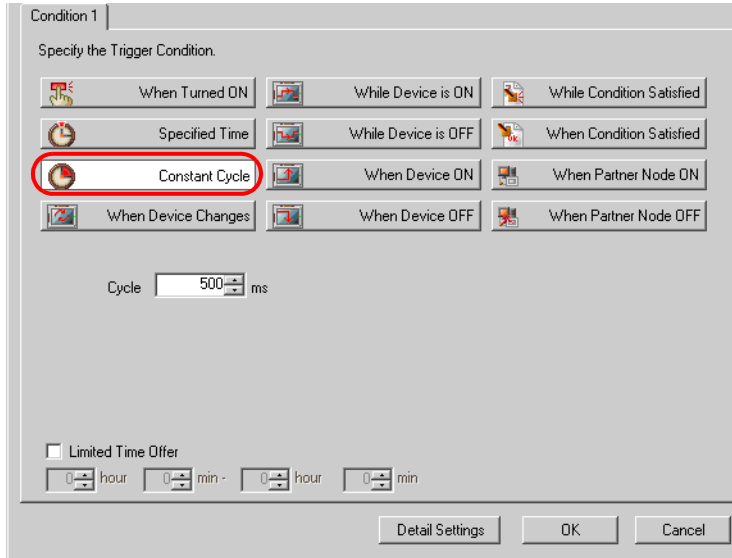

Setting item	Setting content
Cycle	Enter the providing cycle (ms). You can specify the cycle in the range from 0 to 86400000 (24 hours).
Limited Time Offer	If you wish to limit the period, check this and specify the period (hr/min).
Detail Settings	The "Set Trigger Condition Details" screen appears. Specify the methods of completion notification and communication. Refer to "◆ "Set Trigger Condition Details" Screen" for more details.





### ■ At Device Change

Provides when the device data of the specified symbol is changed.

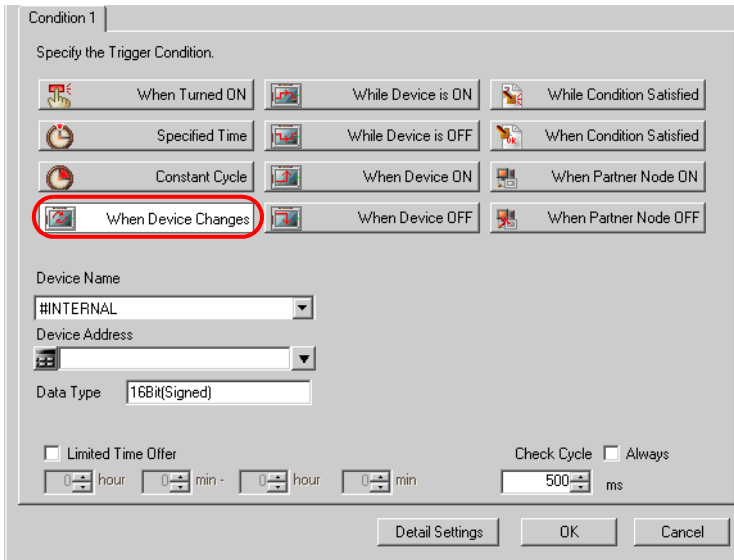
You can also specify the execution timing and check cycle.



Setting item	Setting content
Device Name	Select the device name having the subjected device.
Device Address	<p>Sets the device address or symbol to be used.</p> <ul style="list-style-type: none"> <li>When specifying a device address: Enter directly from the Calculator icon.</li> </ul> <div style="text-align: center;">  <p>Calculator icon</p> </div> <ul style="list-style-type: none"> <li>When specifying a symbol: Select the symbol by clicking the list button.</li> </ul> <div style="text-align: center;">  <p>List button</p> </div>

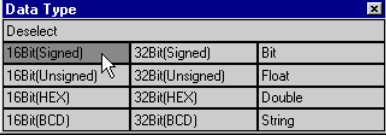

Setting item	Setting content
Data Type	<ul style="list-style-type: none"> <li>When specifying a device address: Specify the data type.</li> </ul>  <ul style="list-style-type: none"> <li>When specifying a symbol: Data type automatically appears.</li> </ul>
Limited Time Offer	If you wish to limit the period, check this and specify the period (hr/min).
Check Cycle	<p>Specify the cycle to check change of the device data (ms). You can specify the cycle in the range from 0 to 86400000 (24 hours). For constant check, check [Always].</p> <p><b>NOTE</b></p> <ul style="list-style-type: none"> <li>When there are many trigger conditions, of which check cycle is specified as [Always], in one node, entire system performance may drop down.</li> </ul>
Detail Settings	<p>The "Set Trigger Condition Details" screen appears. Specify the methods of completion notification and communication. Refer to "◆ "Set Trigger Condition Details" Screen" for more details.</p>

■ While Device On

Provides while the device of the specified symbol is On.

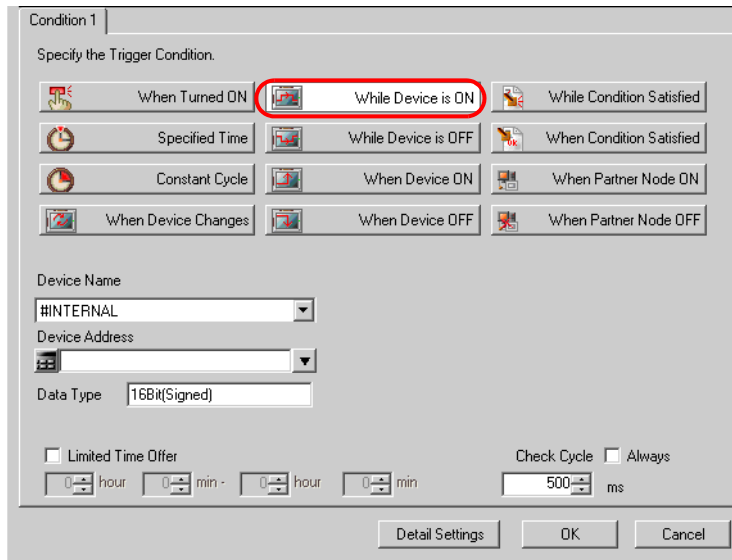
You can also specify the execution timing and check cycle.



Setting item	Setting content
Device Name	Select the device name having the subjected device.
Device Address	<p>Sets the device address or symbol to be used.</p> <ul style="list-style-type: none"> <li>When specifying a device address: Enter directly from the Calculator icon.</li> </ul> <p style="text-align: center;">Calculator icon</p>  <ul style="list-style-type: none"> <li>When specifying a symbol: Select the symbol by clicking the list button.</li> </ul> <p style="text-align: right;">List button</p> 

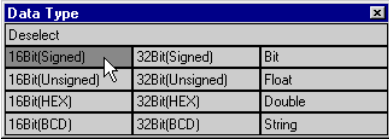

Setting item	Setting content
Data Type	<ul style="list-style-type: none"> <li>When specifying a device address: Specify the data type.</li> </ul>  <ul style="list-style-type: none"> <li>When specifying a symbol: Data type automatically appears.</li> </ul>
Limited Time Offer	If you wish to limit the period, check this and specify the period (hr/min).
Check Cycle	<p>Specify the cycle to check change of the device data (ms). You can specify the cycle in the range from 0 to 86400000 (24 hours). For constant check, check [Always].</p> <p><b>NOTE</b></p> <ul style="list-style-type: none"> <li>When there are many trigger conditions, of which check cycle is specified as [Always], in one node, entire system performance may drop down.</li> </ul>
Detail Settings	<p>The "Set Trigger Condition Details" screen appears. Specify the methods of completion notification and communication. Refer to "◆ "Set Trigger Condition Details" Screen" for more details.</p>

■ While Device OFF

Provides while the device of the specified symbol is Off.

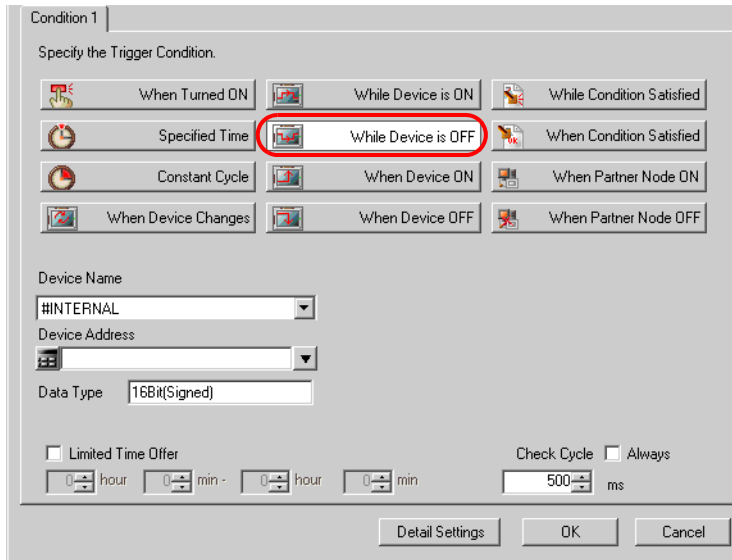
You can also specify the execution timing and check cycle.

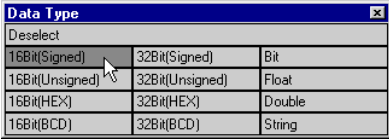

Setting item	Setting content
Device Name	Select the device name having the subjected device.
Device Address	<p>Sets the device address or symbol to be used.</p> <ul style="list-style-type: none"> <li>When specifying a device address: Enter directly from the Calculator icon.</li> </ul> <div style="text-align: center;">  <p>Calculator icon</p> </div> <ul style="list-style-type: none"> <li>When specifying a symbol: Select the symbol by clicking the list button.</li> </ul> <div style="text-align: center;">  <p>List button</p> </div>

Setting item	Setting content
Data Type	<ul style="list-style-type: none"> <li>When specifying a device address: Specify the data type.</li> </ul>  <ul style="list-style-type: none"> <li>When specifying a symbol: Data type automatically appears.</li> </ul>
Limited Time Offer	If you wish to limit the period, check this and specify the period (hr/min).
Check Cycle	<p>Specify the cycle to check change of the device data (ms). You can specify the cycle in the range from 0 to 86400000 (24 hours). For constant check, check [Always].</p> <p><b>NOTE</b></p> <ul style="list-style-type: none"> <li>When there are many trigger conditions, of which check cycle is specified as [Always], in one node, entire system performance may drop down.</li> </ul>
Detail Settings	<p>The "Set Trigger Condition Details" screen appears. Specify the methods of completion notification and communication. Refer to "◆ "Set Trigger Condition Details" Screen" for more details.</p>

■ At Device On

Provides when the device of the specified symbol turns On.

You can also specify the execution timing and check cycle.

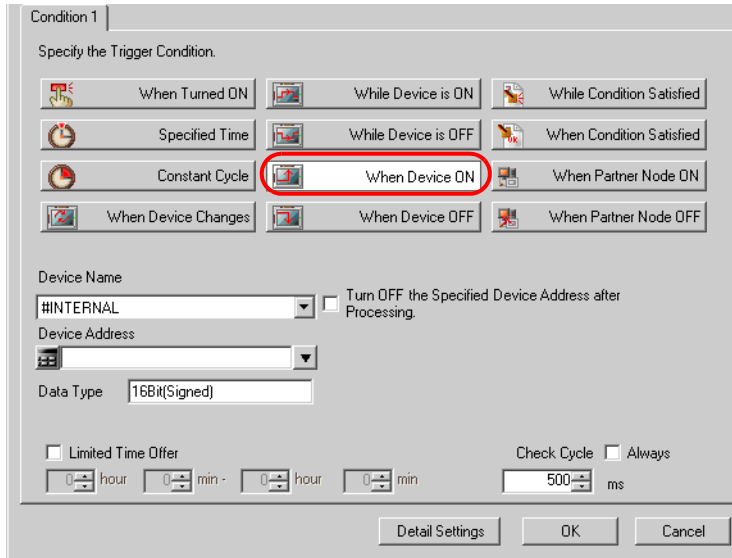

Setting item	Setting content
Device Name	Select the device name having the subjected device.
Device Address	<p>Specify the subjected device address or symbol.</p> <ul style="list-style-type: none"> <li>When specifying a device address: Enter directly from the Calculator icon.</li> </ul> <div style="text-align: center;"> </div> <ul style="list-style-type: none"> <li>When specifying a symbol: Select the symbol by clicking the list button.</li> </ul> <div style="text-align: center;"> </div>

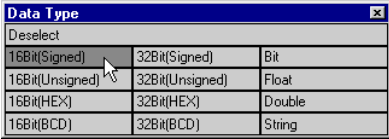
Setting item	Setting content
Data Type	<ul style="list-style-type: none"> <li>When specifying a device address: Specify the data type.</li> </ul>  <ul style="list-style-type: none"> <li>When specifying a symbol: Data type automatically appears.</li> </ul>
Turn OFF the Specified Device Address after Processing.	Check this to turn off the subjected device or symbol after processing.
Limited Time Offer	Check this and specify the period (hr/min) to limit the period.
Check Cycle	<p>Specify the cycle to check change of the device data (ms). You can specify the cycle in the range from 0 to 86400000 (24 hours). For constant check, check [Always].</p> <p><b>NOTE</b></p> <ul style="list-style-type: none"> <li>When there are many trigger conditions, of which check cycle is specified as [Always], in one node, entire system performance may drop down.</li> </ul>
Detail Settings	<p>The "Set Trigger Condition Details" screen appears. Specify the methods of completion notification and communication. Refer to "◆ "Set Trigger Condition Details" Screen" for more details.</p>



■ At Device OFF

Provides when the device of the specified symbol turns Off.

You can also specify the execution timing and check cycle.

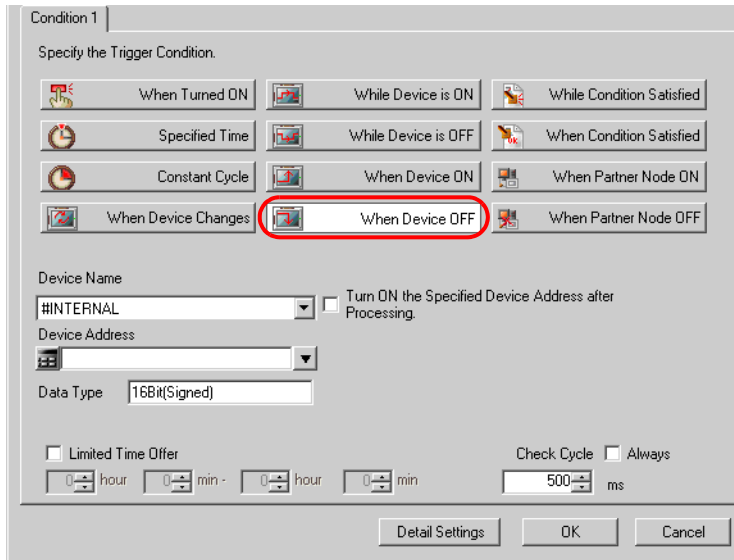

Setting item	Setting content
Device Name	Select the device name having the subjected device.
Device Address	<p>Specify the subjected device address or symbol.</p> <ul style="list-style-type: none"> <li>When specifying a device address: Enter directly from the Calculator icon.</li> </ul> <div style="text-align: center;"> </div> <ul style="list-style-type: none"> <li>When specifying a symbol: Select the symbol by clicking the list button.</li> </ul> <div style="text-align: center;"> </div>

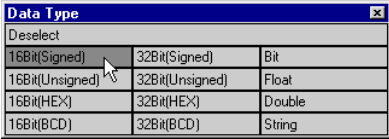

Setting item	Setting content
Data Type	<ul style="list-style-type: none"> <li>When specifying a device address: Specify the data type.</li> </ul>  <ul style="list-style-type: none"> <li>When specifying a symbol: Data type automatically appears.</li> </ul>
Turn ON the Specified Device Address after Processing.	Check this to turn on the subjected device or symbol after processing.
Limited Time Offer	To limit the period, check this and specify the period (hr/min.).
Check Cycle	<p>Specify the cycle to check change of the device data (ms). You can specify the cycle in the range from 0 to 86400000 (24 hours). For constant check, check [Always].</p> <p><b>NOTE</b></p> <ul style="list-style-type: none"> <li>When there are many trigger conditions, of which check cycle is specified as [Always], in one node, entire system performance may drop down.</li> </ul>
Detail Settings	<p>The "Set Trigger Condition Details" screen appears. Specify the methods of completion notification and communication. Refer to "◆ "Set Trigger Condition Details" Screen" for more details.</p>

■ While conditional expression satisfied (excluding the case that the node is GP Series)

Provides while the conditional expression that has been specified is satisfied between 2 devices. (Ex.: Device A and B have the same data value.)

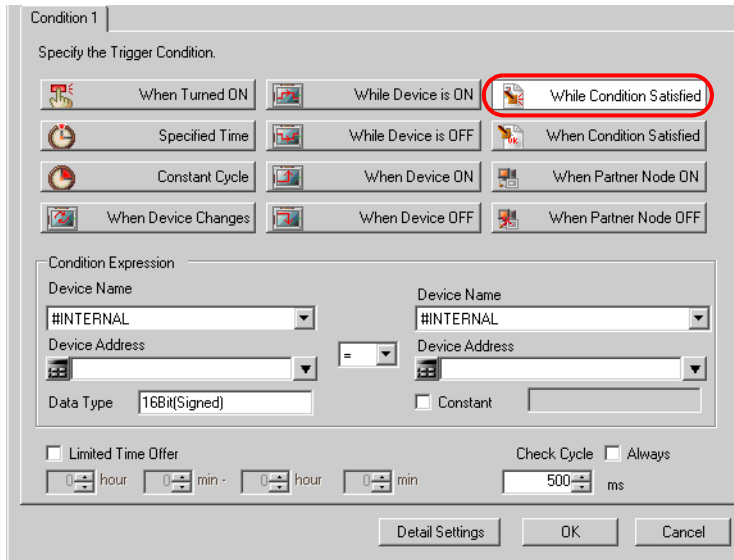
You can also specify the execution timing and check cycle.

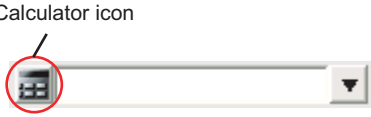

Setting item		Setting content
Condition Expression	Device Name	Select the device name having the subjected device.
	Device Address	<p>Specify the subjected device address or symbol.</p> <ul style="list-style-type: none"> <li>When specifying a device address: Enter directly from the Calculator icon.</li> </ul> <div style="text-align: center;">  <p>Calculator icon</p> </div> <ul style="list-style-type: none"> <li>When specifying a symbol: Select the symbol by clicking the list button.</li> </ul> <div style="text-align: center;">  <p>List button</p> </div>

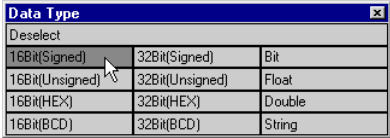

Setting item		Setting content
Condition Expression	Data Type	<ul style="list-style-type: none"> <li>When specifying a device address: Specify the data type.</li> </ul>  <ul style="list-style-type: none"> <li>When specifying a symbol: Data type automatically appears.</li> </ul> <p><b>NOTE</b></p> <ul style="list-style-type: none"> <li>When the data type is "Character String", the character string to be compared is 1 character.</li> </ul>
	Constant	To set a constant in the trigger condition, check this and specify the value.
	Expression Symbol	Select the symbols of the specified conditional expression. You can select "=", "<=", ">=", "<", ">" or "<>".
Limited Time Offer		To limit the period, check this and specify the period (hr/min.).
Check Cycle		Specify the cycle to check change of the device data (ms). You can specify the cycle in the range from 0 to 86400000 (24 hours). For constant check, check [Always].
Detail Settings		The "Set Trigger Condition Details" screen appears. Specify the methods of completion notification and communication. Refer to "◆ "Set Trigger Condition Details" Screen" for more details.

■ When conditional expression satisfied (excluding the case that the node is GP Series)

Provides when the conditional expression that has been specified is satisfied between 2 devices.

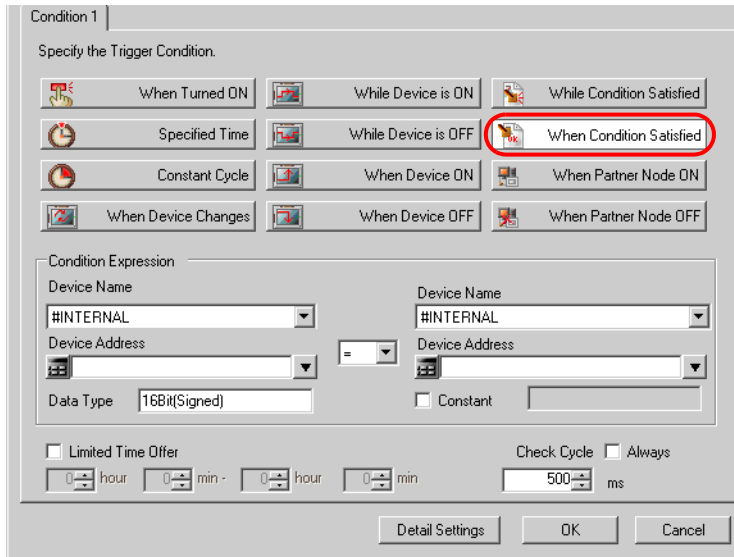
You can also specify the execution timing and check cycle.

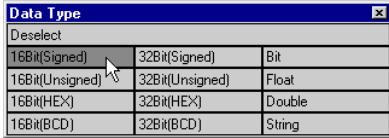

Setting item		Setting content
Condition Expression	Device Name	Select the device name having the subjected device.
	Device Address	<p>Specify the subjected device address or symbol.</p> <ul style="list-style-type: none"> <li>When specifying a device address: Enter directly from the Calculator icon.</li> </ul> <p style="text-align: center;">Calculator icon</p>  <ul style="list-style-type: none"> <li>When specifying a symbol: Select the symbol by clicking the list button.</li> </ul> <p style="text-align: center;">List button</p> 

Setting item		Setting content
Condition Expression	Data Type	<ul style="list-style-type: none"> <li>When specifying a device address: Specify the data type.</li> </ul>  <ul style="list-style-type: none"> <li>When specifying a symbol: Data type automatically appears.</li> </ul> <p><b>NOTE</b></p> <ul style="list-style-type: none"> <li>When the data type is "Character String", the character string to be compared is 1 character.</li> </ul>
	Constant	To set a constant in the trigger condition, check this and specify the value.
	Expression Symbol	Select the symbols of the specified conditional expression. You can select "=", "<=", ">=", "<", ">" or "<>".
Limited Time Offer		To limit the period, check this and specify the period (hr/min.).
Check Cycle		<p>Specify the cycle to check change of the device data (ms). You can specify the cycle in the range from 0 to 86400000 (24 hours). For constant check, check [Always].</p> <p><b>NOTE</b></p> <ul style="list-style-type: none"> <li>When there are many trigger conditions, of which check cycle is specified as [Always], in one node, entire system performance may drop down.</li> </ul>
Detail Settings		The "Set Trigger Condition Details" screen appears. Specify the methods of completion notification and communication. Refer to "◆ "Set Trigger Condition Details" Screen" for more details.

■ When partner node turned On (excluding the case that the node is GP Series)

Provides only once when the power of the specified partner node is turned on.

**NOTE** • When the partner node is turned on, operation may slightly delay due to time lag occurrence.

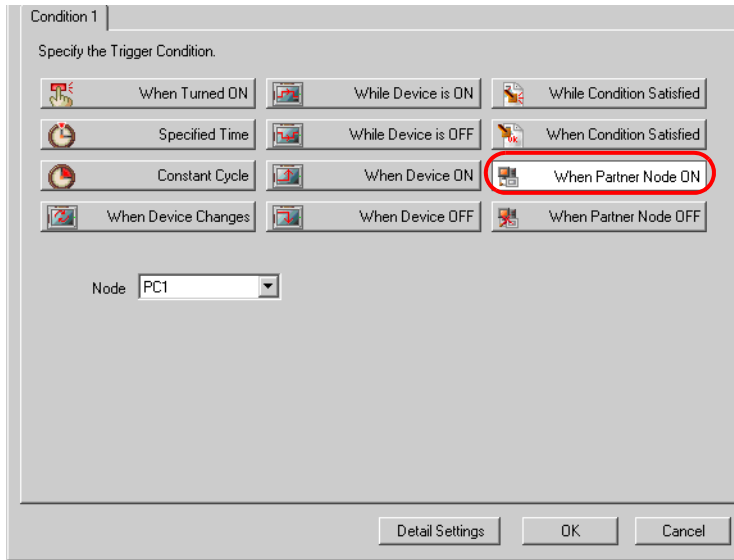

Setting item	Setting content
Node	Select the name of the subjected node.
Limited Time Offer	To limit the period, check this and specify the period (hr/min.).
Check Cycle	Specify the cycle to check the power status of the partner node (ms). You can specify the cycle in the range from 0 to 86400000 (24 hours). For constant check, check [Always].  <b>NOTE</b> • When there are many trigger conditions, of which check cycle is specified as [Always], in one node, entire system performance may drop down.
Detail Settings	The "Set Trigger Condition Details" screen appears. Specify the methods of completion notification and communication. Refer to "◆ "Set Trigger Condition Details" Screen" for more details.

■ When partner node turned Off (excluding the case that the node is GP Series)

Provides only once when the power of the specified partner node is turned off.

**NOTE** • When the partner node is turned off, operation may slightly delay due to time lag occurrence.

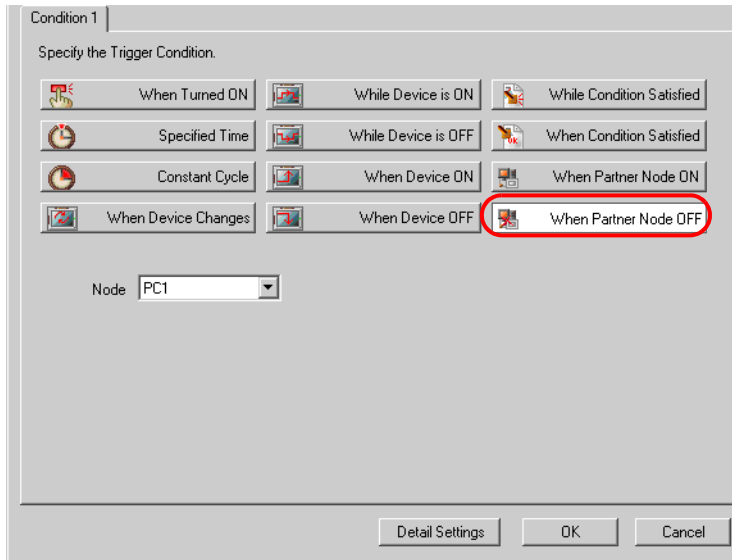

Setting item	Setting content
Node	Select the name of the subjected node.
Limited Time Offer	To limit the period, check this and specify the period (hr/min.).
Check Cycle	Specify the cycle to check the power status of the partner node (ms). You can specify the cycle in the range from 0 to 86400000 (24 hours). For constant check, check [Always]. <b>NOTE</b> • When there are many trigger conditions, of which check cycle is specified as [Always], in one node, entire system performance may drop down.
Detail Settings	The "Set Trigger Condition Details" screen appears. Specify the methods of completion notification and communication. Refer to "◆ "Set Trigger Condition Details" Screen" for more details.



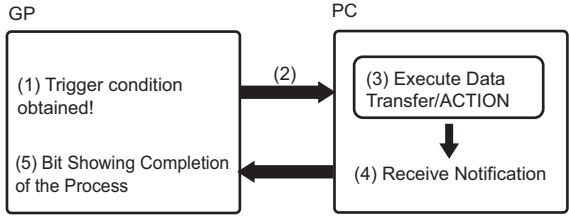

Setting item		Setting content
Completion Notification	Bit Showing Completion of the Process	<p>Sets "0" or "1" to the specified device when data transfer or ACTION has completed. Select the device name, device and symbol, and check either [Set "1"] or [Set "0"].</p>  <pre> graph LR     GP[GP] -- (1) Trigger condition obtained! --&gt; PC[PC]     subgraph PC_Box [PC]         direction TB         P3["(3) Execute Data Transfer/ACTION"]         P4["(4) Receive Notification"]         P3 --&gt; P4     end     PC -- (2) --&gt; GP     PC -- (4) --&gt; GP     GP -- (5) Bit Showing Completion of the Process --&gt; GP     </pre> <p><b>NOTE</b></p> <ul style="list-style-type: none"> <li>• This setting should be effective under the conditions that: [At Device On] or [AT Device Off] is included in Condition 1 or Condition 2, and [Turn OFF (or ON) the Specified Symbol after Processing] is unchecked.</li> <li>• You cannot specify the grouped symbol. Refer to "28.2 Grouping Symbols" for details about group symbols.</li> </ul>
	Auto Reset after Trigger Condition Reset	<p>Check this to reset the device indicating the process completion when the trigger condition is reset.</p> <p><b>NOTE</b></p> <ul style="list-style-type: none"> <li>• This setting should be effective under the conditions that: Trigger condition is [Device On] and [Turn OFF the Specified Symbol after Processing] is unchecked, or trigger condition is [Device Off] and [Turn ON the Specified Symbol after Processing] is unchecked.</li> </ul>
	Bit Showing Processing Result (Success/Failure)	<p>Check this to indicate the processing results on the device. Specify the device name, device and symbol. Sets "0" if processing result is normal, and "1" if not.</p> <p><b>NOTE</b></p> <ul style="list-style-type: none"> <li>• This setting is available only for device (or symbols) with "Bit" format. You cannot specify the grouped symbol.</li> <li>• Processing is made for 1 address (data type) when the symbol is specified.</li> </ul>
	Error Code Storage Location	<p>Specify the error code storage location when the network related error code is stored in the device in the case that error is found in the processing results.</p> <p><b>NOTE</b></p> <ul style="list-style-type: none"> <li>• You can set only devices (symbols) with the "16 bits" or the "32 bits" format. You cannot specify the grouped symbol.</li> <li>• Processing is made for 1 address (data type) when the symbol is specified.</li> <li>• When you use a symbol imported from 'GP-Pro EX', enter the symbol name directly into the text box.</li> </ul>

Setting item		Setting content
Completion Notification	Abnormal Device IP Address Storage Location	<p>Stores the IP address of the provider destination when a provider error occurs.</p> <p><b>NOTE</b></p> <ul style="list-style-type: none"> <li>• This setting is available only for devices (symbols) with the "32 bits" format. You cannot specify the grouped symbol.</li> <li>• Processing is made for 1 address (data type) when the symbol is specified.</li> <li>• When you use a symbol imported from 'GP-Pro EX', enter the symbol name directly into the text box.</li> </ul>
Communication Method	General Broadcast/ Individual Communication	<p>Select general broadcast or individual communication for data transfer and ACTION data transfer.</p> <p><b>NOTE</b></p> <ul style="list-style-type: none"> <li>• Response check is not available because the transfer is performed on broadcast.</li> </ul>
	Response Check	<p>Check this to see the response under the individual communication. If checked, specify the number of retry times of response check in [No. of Retry Times].</p> <p><b>NOTE</b></p> <ul style="list-style-type: none"> <li>• This setting is available for the communication with GP Series and broadcast communication. The retry times specified on the "Setup for Pro-Server EX/GP3000/WinGP/LT3000" screen on the "Network setup" screen are applied to other communication.</li> </ul>
	Enable Data Transfer Timeout in the Network Settings	<p>Check this to adopt the timeout span specified on the "Network setup" screen. If not adopted, specify the timeout span (ms) in [Data Transfer Timeout Span] that is to be used.</p> <p><b>NOTE</b></p> <ul style="list-style-type: none"> <li>• This setting is available for the communication with GP Series and broadcast communication. The retry times specified on the "Setup for Pro-Server EX/GP3000/WinGP/LT3000" screen on the "Network setup" screen are applied to other communication.</li> </ul>

◆ Combining two trigger conditions

You can combine 2 trigger conditions at maximum by using "And" / "Or" when specifying the trigger condition. First, specify a trigger condition. Then click the list button of [Trigger Condition] to select [AND] or [OR], and specify the second trigger condition in the [Condition 2] tab.

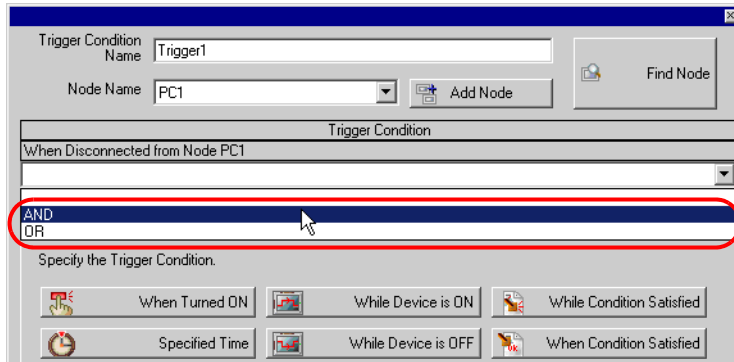

◆ Operation timing with the trigger conditions given below

There are 4 types of trigger conditions that you can specify by using "At Device On" and "At Device Off", and the examples of timing chart with each condition are as follows:

<Example 1: When you set "While Device is ON" or "While Device is OFF" as follows:>

While Device is ON	Turn OFF the specified device address after processing.	Checked
While Device is OFF	Turn ON the specified device address after processing.	Checked

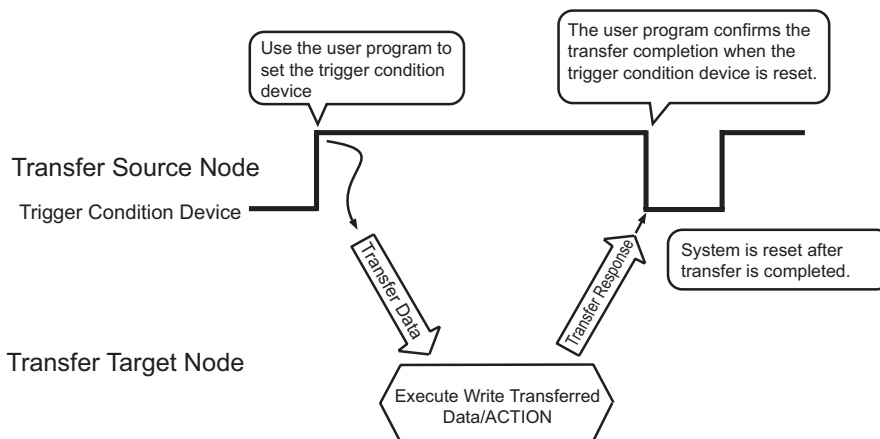

<Example 2: When you set "While Device is ON" or "While Device is OFF" as follows:>

While Device is ON	Turn OFF the specified device address after processing.	Unchecked
While Device is OFF	Turn ON the specified device address after processing.	Unchecked

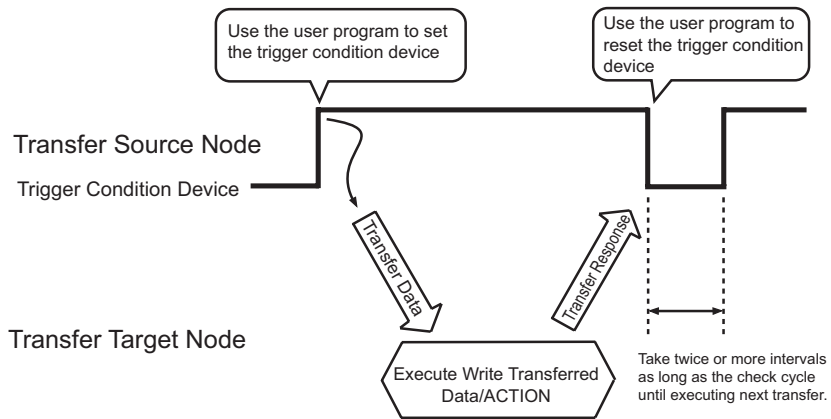

<Example 3: When you set "While Device is ON" or "While Device is OFF" as follows:>

While Device is ON	Bit Showing Completion of the Process	With
	Auto-Reset after Resetting Trigger Condition	Unchecked
While Device is OFF	Bit Showing Completion of the Process	With
	Auto-Reset after Resetting Trigger Condition	Unchecked

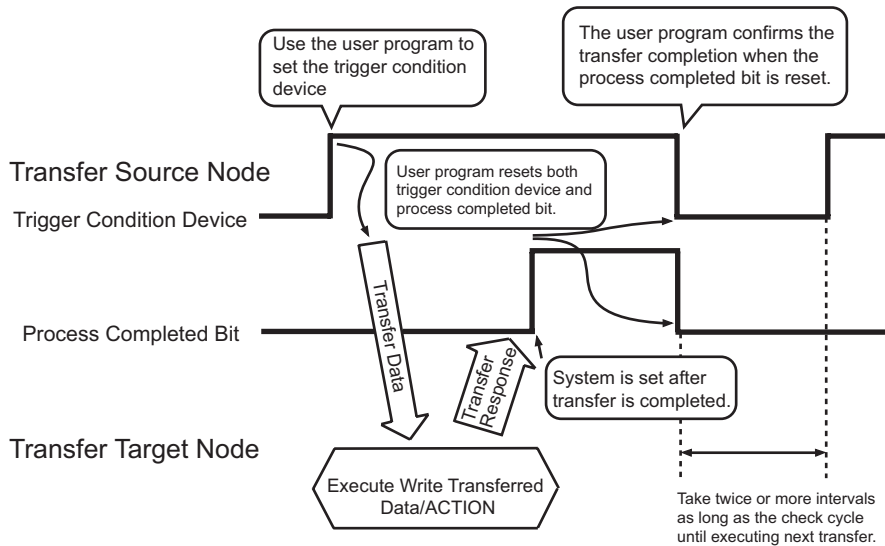

<Example 4: When you set "While Device is ON" or "While Device is OFF" as follows:>

While Device is ON	Bit Showing Completion of the Process	With
	Auto-Reset after Resetting Trigger Condition	Checked
While Device is OFF	Bit Showing Completion of the Process	With
	Auto-Reset after Resetting Trigger Condition	Checked

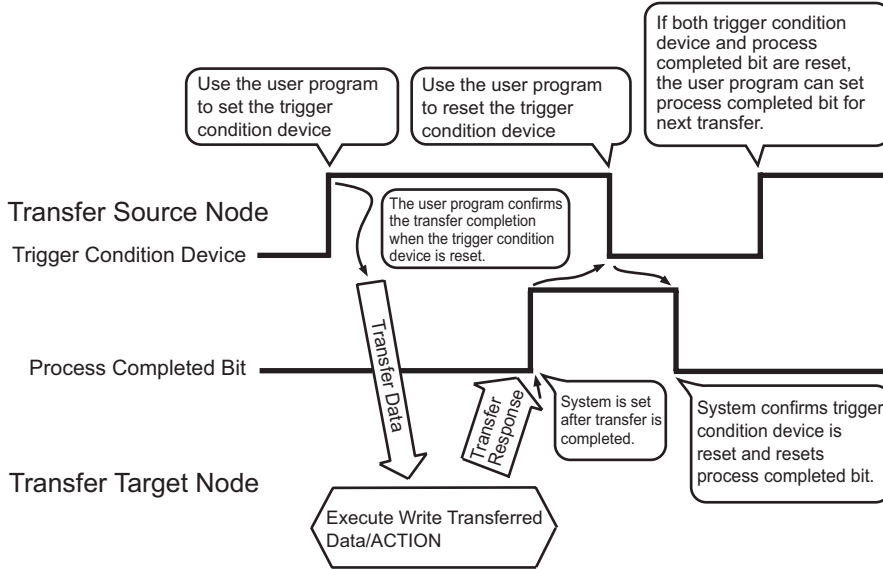

The following chart describes the summary of the trigger condition device, [Bit Showing Completion of the Process], [Bit Showing Processing Result (Success/Failure)], [Error Code Storage Location], [Abnormal Device IP Address Storage Location] and the timing to set the receipt notification device described later.

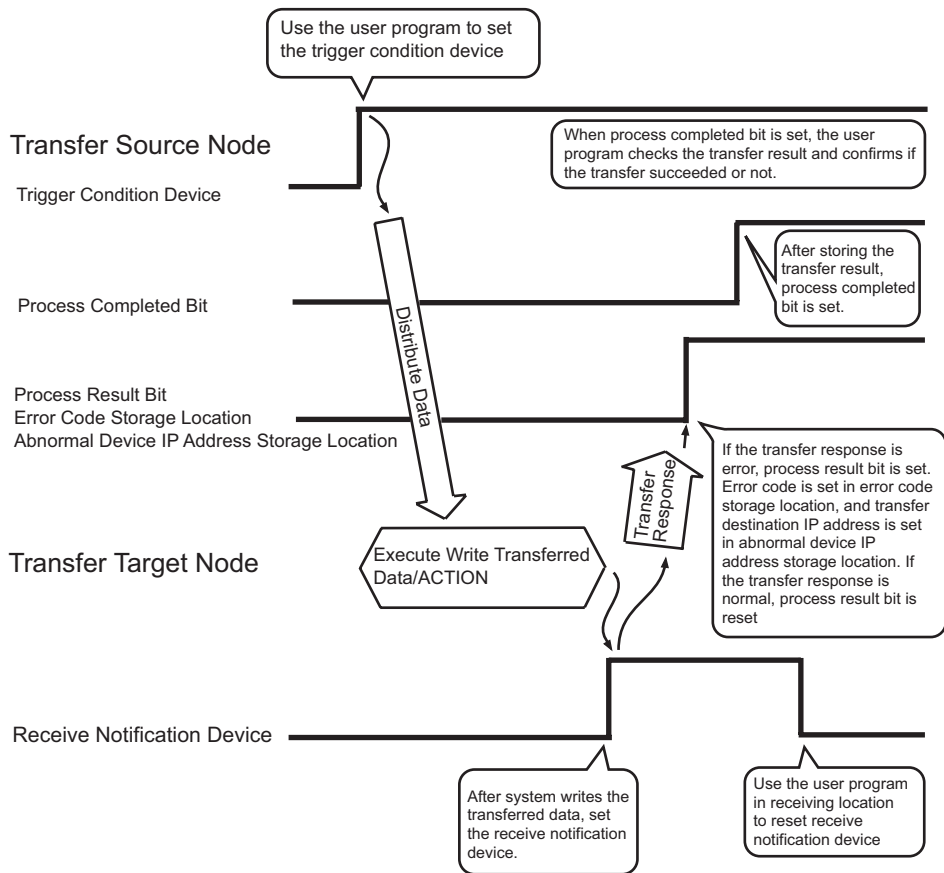

### 32.1.2 Data Received by ACTION

- NOTE** • This section describes the setting procedures when the ACTION is performed.  
This setting is not effective for the case of data transfer.

When the trigger conditions become effective, the device data and constant number specified here are transferred to ACTION node (Normally PC) from the transfer source node.

ACTION node receives such data, displays them on application software and controls these data.

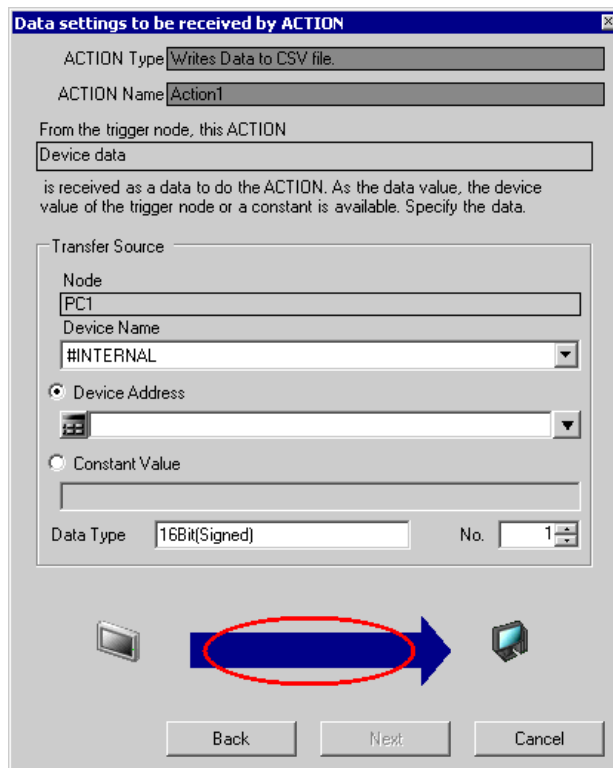

ACTION data is specified on the "Data settings to be received by ACTION" screen.



- NOTE** • Some ACTIONS use the data specified in the above screen for start notification, and optional symbol or constant value need to be specified.  
You may find that "1" is specified in the setting procedures in the corresponding chapter.

Setting item	Setting content
ACTION Type	Displays the ACTION type selected on the "Set ACTION Name/Parameter" screen.
ACTION Name	Displays the ACTION name selected on the "Set ACTION Name/Parameter" screen.
From the trigger node, this ACTION	Displays the argument name received from the transfer source during the ACTION operation.

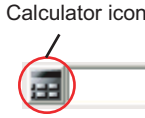

Setting item		Setting content
Transfer Source	Node	Displays the node name specified on the "Trigger Condition Settings" screen.
	Device Name	Select Device/PLC as a transfer source of ACTION data.
	Device Address	<p>Click this to specify the device address (or symbol) when the device is set as a transfer source of ACTION data.</p> <ul style="list-style-type: none"> <li>When specifying a device address: Enter directly from the Calculator icon.</li> </ul> <div style="text-align: center;">  <p>Calculator icon</p> </div> <ul style="list-style-type: none"> <li>When specifying a symbol: Select the symbol by clicking the list button.</li> </ul> <div style="text-align: center;">  <p>List button</p> </div> <p><b>NOTE</b></p> <ul style="list-style-type: none"> <li>When the next item [Constant Value] is specified, this device address setting is not effective.</li> </ul>
	Constant Value	<p>Click this to enter the number when the constant value is to be set as ACTION data.</p> <p><b>NOTE</b></p> <ul style="list-style-type: none"> <li>When the above item [Device Address] is specified, this setting is not effective.</li> </ul>
	Data Type	Displays automatically the data type of the device specified as a transfer source.
No.	Specifies the number of device when such a device is set as a transfer source.	

### 32.1.3 ACTION Nodes

**NOTE** • This section describes the setting procedures when the ACTION is performed.  
This setting is not effective for the case of data transfer.

The entry node where the ACTION works practically is called an "ACTION node".



Since ACTION utilizes application software like Excel, a personal computer (Pro-Server EX) is normally set as an ACTION node.

Specify the ACTION node on the "Set ACTION Node/Process Completion Notification" screen when multiple PCs are registered as entry nodes on the network.

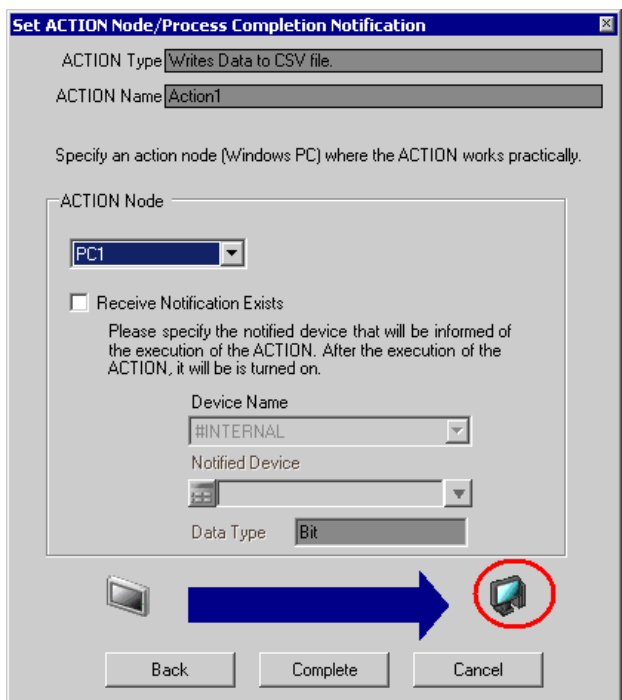
You can also set the ACTION completion notification on this screen.

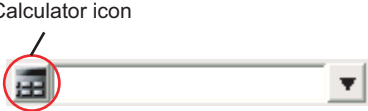

Setting item		Setting content
ACTION Type		Displays the ACTION type selected on the [Set ACTION Name/Parameter] screen.
ACTION Name		Displays the ACTION name selected on the [Set ACTION Name/Parameter] screen.
ACTION Node	Node	Select the node name to be specified as an ACTION node.
	Receive Notification Exists	Check this to receive a notification indicating the ACTION completion.
	Device Name	Select the name of device having address to be a notification destination of ACTION execution.

Setting item		Setting content
ACTION Node	Notified Device	<p>Specify the device address (or symbol) that is set to be a notification destination of ACTION execution.</p> <ul style="list-style-type: none"> <li>When specifying a device address: Enter directly from the Calculator icon.</li> </ul>  <ul style="list-style-type: none"> <li>When specifying a symbol: Select the symbol by clicking the list button.</li> </ul> 
	Data Type	Displays automatically the data type of the device specified as a notification destination of ACTION execution.

## 32.2 Editing Trigger Conditions

Edit the contents of trigger conditions already specified.

- 1 Select the trigger condition to edit, and click the [Edit] button on the "ACTION-Specific Trigger Condition/Process List" screen.

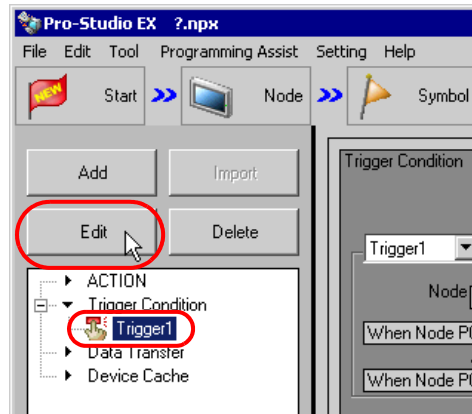

The trigger condition settings screen appears.

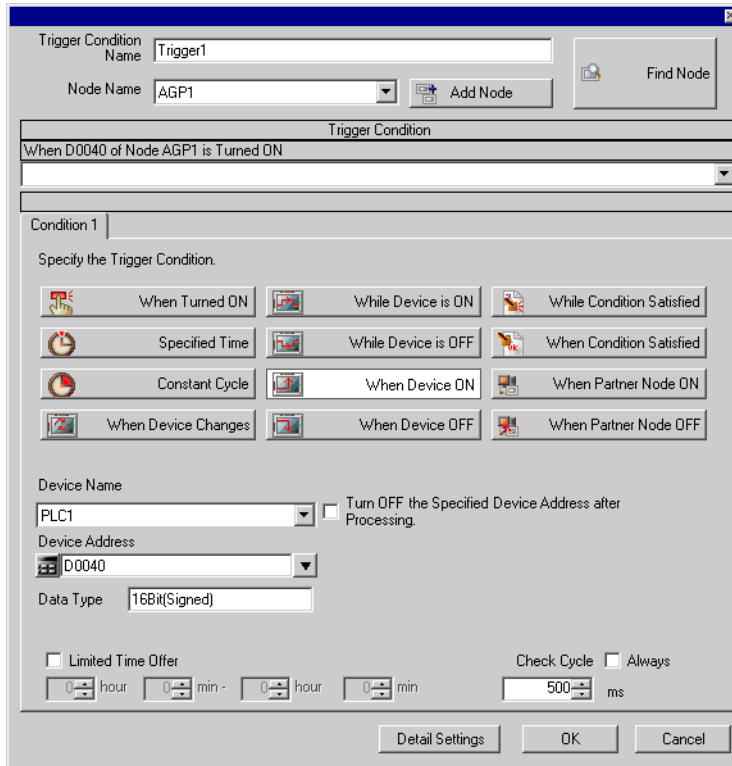

2 Edit the contents and click the [OK] button.

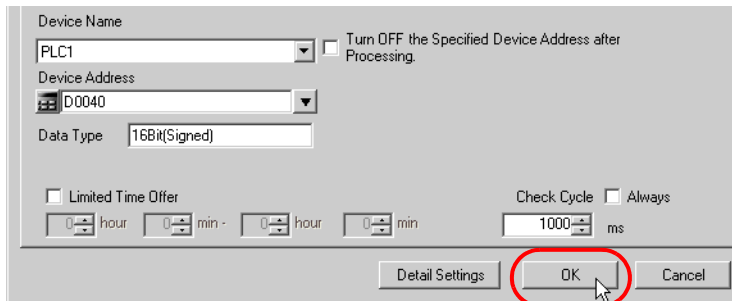

**NOTE**

- You can also edit the trigger condition from the [Edit] button on the "Sequence Diagram by Trigger Condition" screen.

👉 "32.4.3 Setting Guide"

## 32.3 Deleting Trigger Conditions

Delete the contents of trigger conditions already specified.

- 1 Select the trigger condition you wish to delete, and click the [Delete] button on the "ACTION-Specific Trigger Condition/Process List" screen.

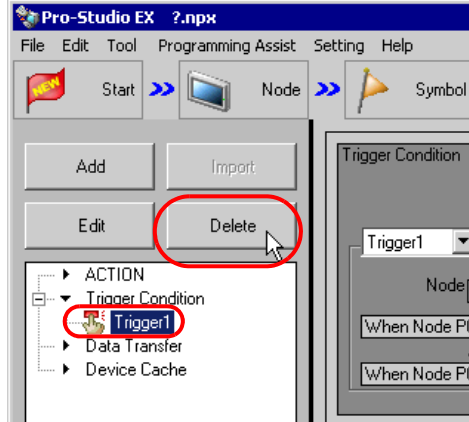

The "Trigger1 will be deleted. Is that OK?" message appears.

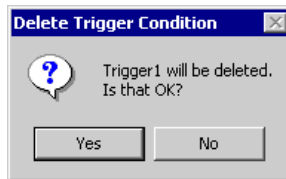

- 2 Click the [Yes] button.

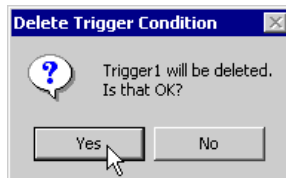

The selected trigger condition is deleted.

## 32.4 Sequential Execution of Multiple Data Transfers and ACTIONS with One Trigger Condition

You can perform multiple data transfers and ACTIONS sequentially by registering them in one trigger condition. Register the first data transfer/ACTION, and add the second data transfer/ACTION with assigning the same trigger conditions.

### 32.4.1 Registering Multiple Data Transfers and ACTIONS in One Trigger Condition

#### Ex.

Detect the rising of PLC1 device (Bit device: Address "M01");

(1) Collect the data of PLC2 device (Word device: Address "DM50" to "DM54") and then write them to PLC1 device (Word device: Address "D50" to "D54") (Data Transfer);

(2) Write the PLC1 device data that is transferred (Word device: Address "D50" to "D54") to a CSV file (ACTION).

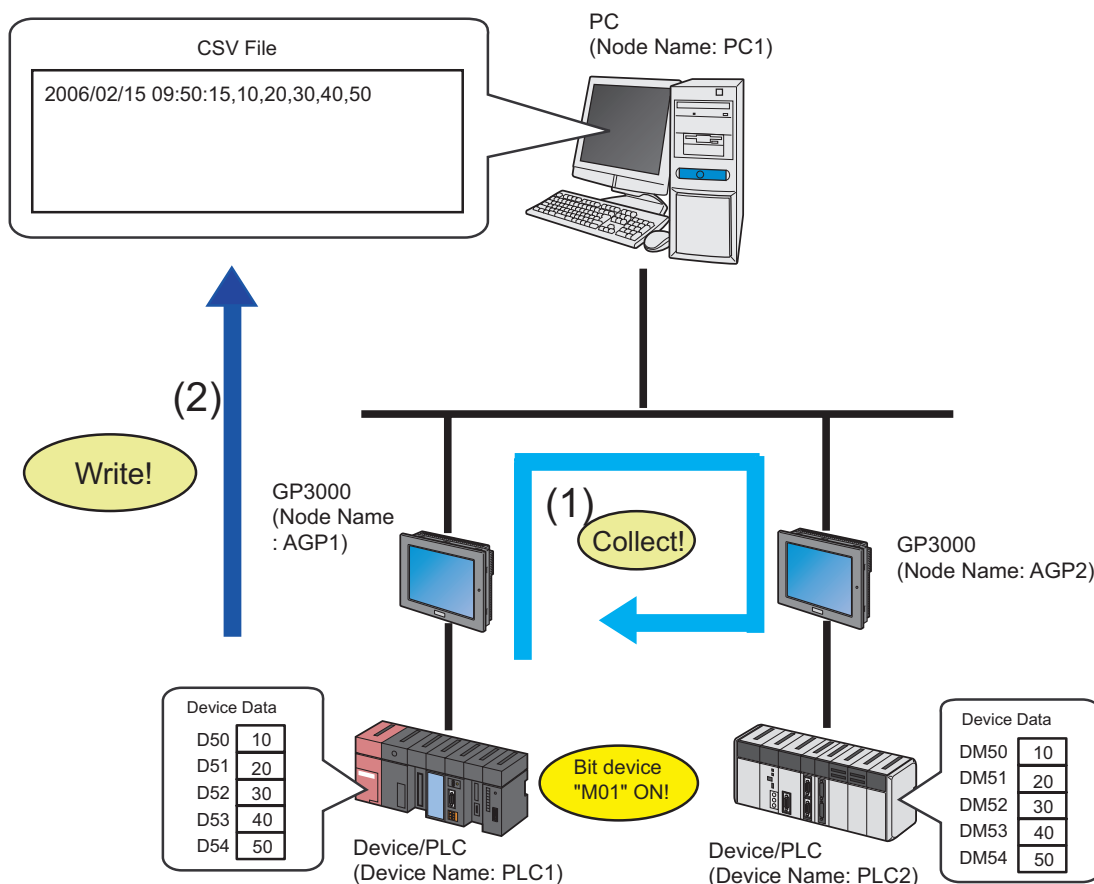

## [Set contents of (1) Data Transfer]

Setting item		Setting content
Data Transfer Type		Collection type
Data Transfer Name		Data transfer
Trigger Condition Name		Turn on operation start bit
Trigger Condition		When "Operation start" (M01) is ON
Transfer Source	Node	AGP2
	Device Name	PLC2
	Device	PLC2 symbol "Transfer source" (DM50 to DM54)
Transfer Destination	Node	AGP1
	Device Name	PLC1
	Device	PLC1 symbol "Transfer destination" (D50 to D54)

## [Set contents of (2) ACTION]

Setting item	Setting content
ACTION Name	CSV upload
Trigger Condition Name	Turn on operation start bit
Trigger Condition	When "Operation start" (M01) is ON
Transfer Destination Device Name	PLC1
Transfer Destination Device	PLC1 symbol "PLC1 Data" (D50 to D54)
ACTION Node	PC1
Receive Notification	OFF



1 First, register the setting contents of (1) Data Transfer in "TurnOnOperationStartBit" of the trigger condition.

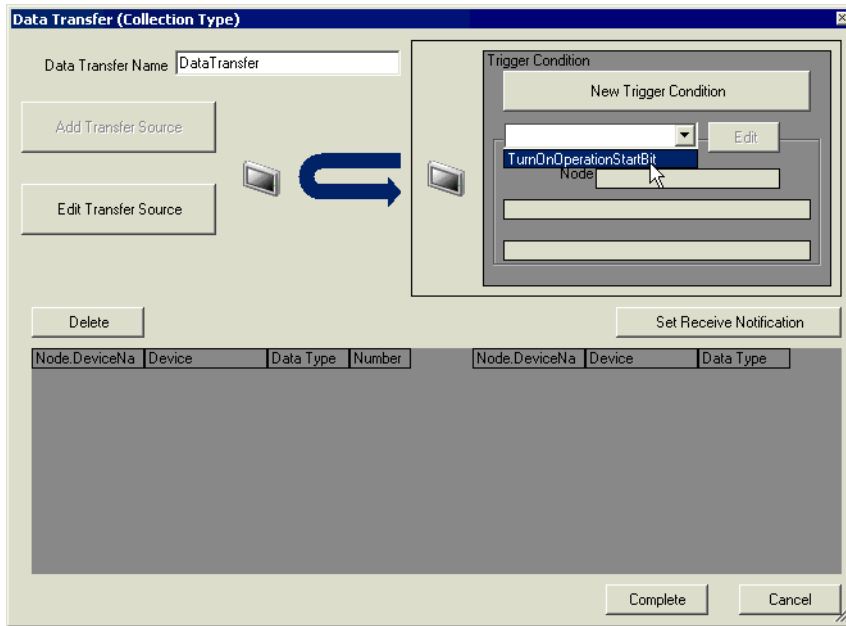

**NOTE** • For the data transfer setting, please refer to "18 Sending Data between Devices".

2 Click the [Complete] button.

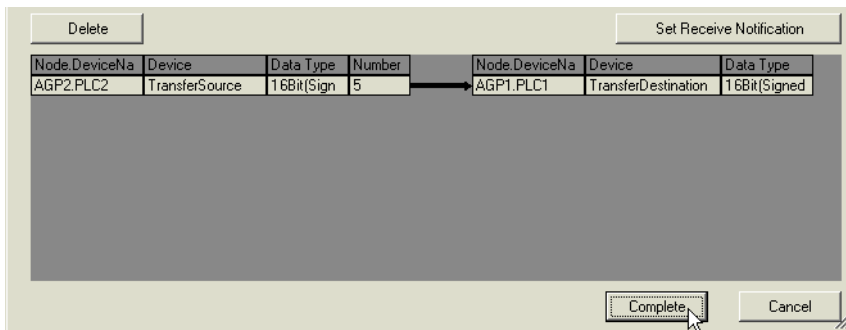

3 Select [ACTION] from the tree display on the left of the screen, then click the [Add] button.

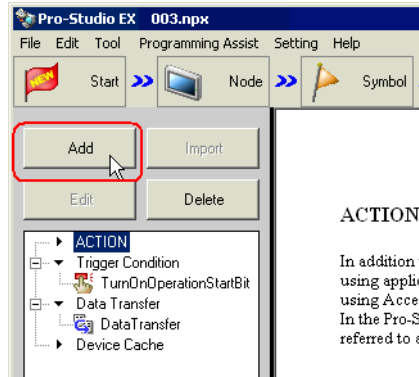

The "Set ACTION Name/Parameter" screen appears.

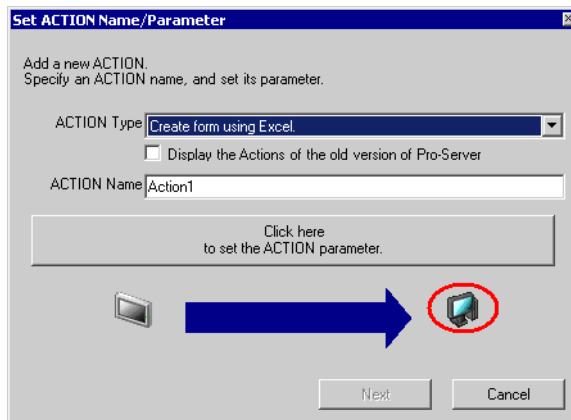

4 Click the list button of [ACTION Type] and select the contents of (2) "Create form using Excel.". Then, enter "CSV Upload" in [ACTION Name] and click the [Click here to set the ACTION parameter] button.

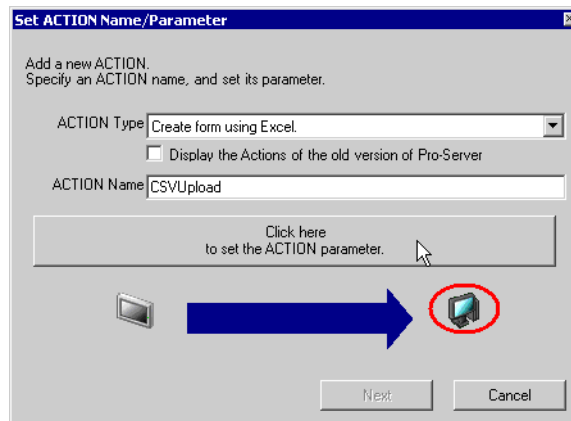

- 5 Set the parameter of the ACTION "CSV Upload" and click the [OK] button. Then click the [Next] button on the "Set ACTION Name/Parameter" screen.

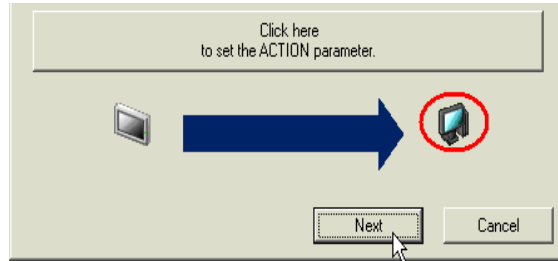

**NOTE** • For the setting procedures of the ACTION "CSV Upload", please refer to "7 Writing Device/PLC Data in CSV File".

- 6 Click the list button of [Trigger Condition] and select "TurnOnOperationStartBit" that is to be assigned. Then click the [Next] button.

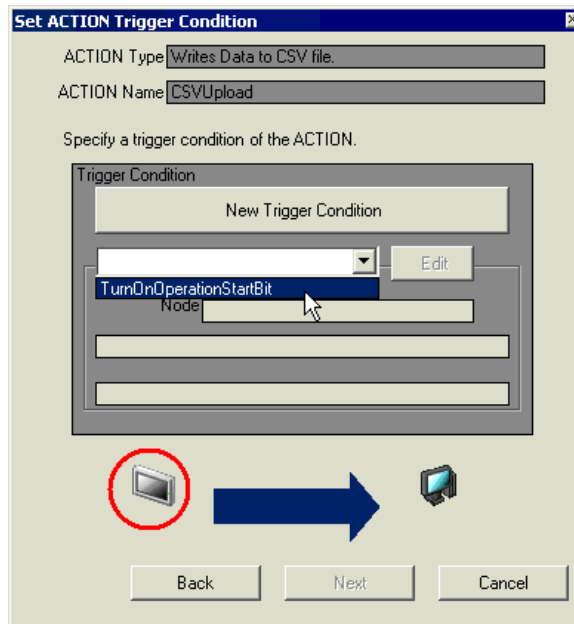

7 Specify the ACTION data of "CSV Upload", and click the [Next] button.

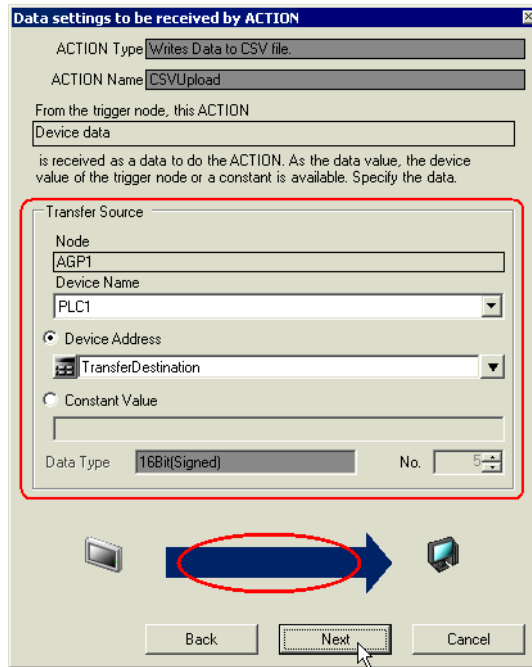

8 Specify ACTION Node and Completion Notification of the additional trigger condition, then click the [Complete] button.

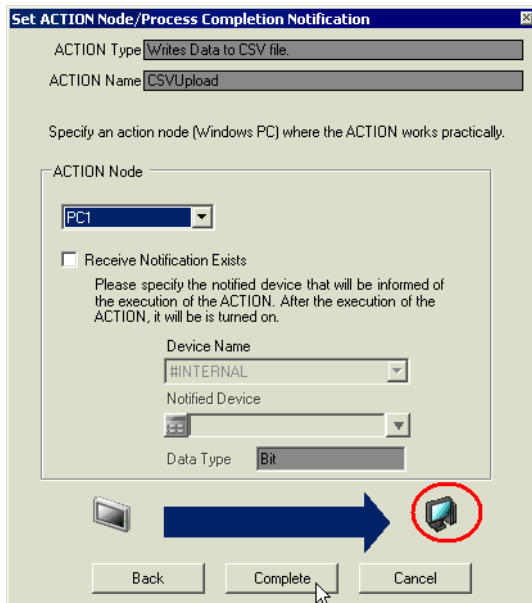

One data transfer and one ACTION have been now assigned to one trigger condition.

- Click the trigger condition name to which data transfer and ACTION have been assigned from the list on the left of the screen.

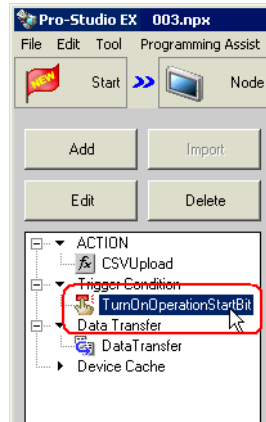

Specified data transfer and ACTION are now displayed on the "Sequence Diagram by Trigger Condition" screen.

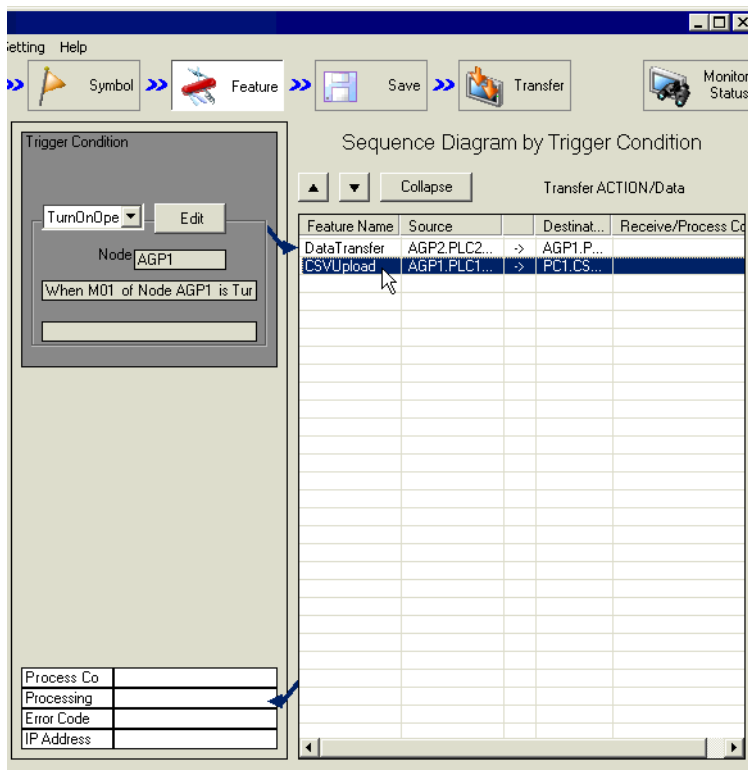

**NOTE** • To register additional data transfers and ACTIONS, repeat the above steps.

### 32.4.2 Changing Operation Order of Data Transfer and ACTION

You can change the operation order of data transfer and ACTION specified collectively.

- 1 Click the name of data transfer and ACTION whose operation order you wish to change on the "Sequence Diagram by Trigger Condition" screen.

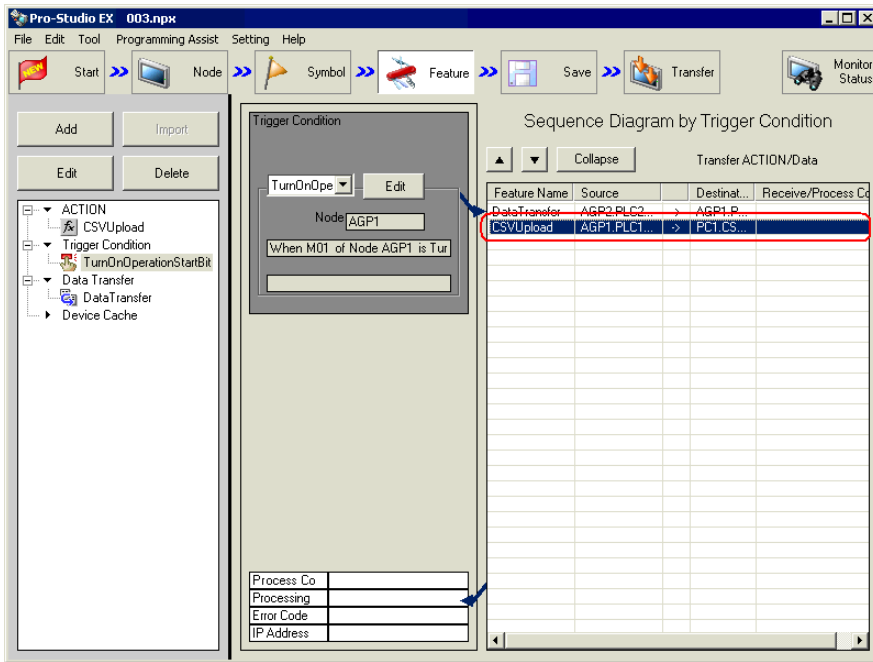

- 2 Click the [▲] or [▼] button.

[▲]: Move the operation upward by one row.

[▼]: Move the operation downward by one row.

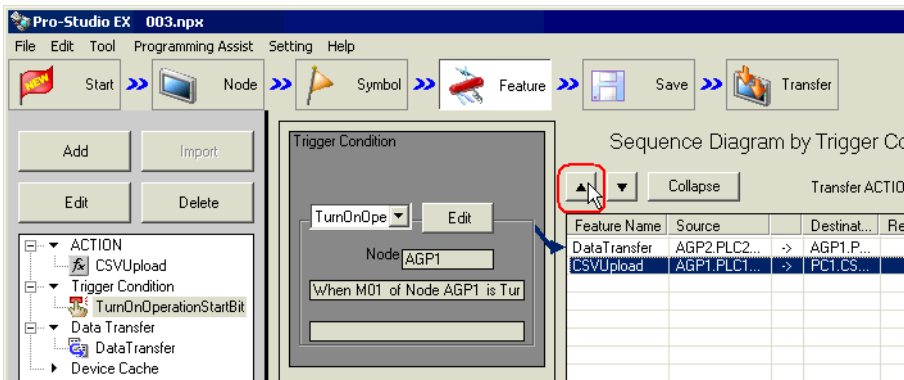

### 32.4.3 Setting Guide

This section describes the contents on the "Sequence Diagram by Trigger Condition" screen.

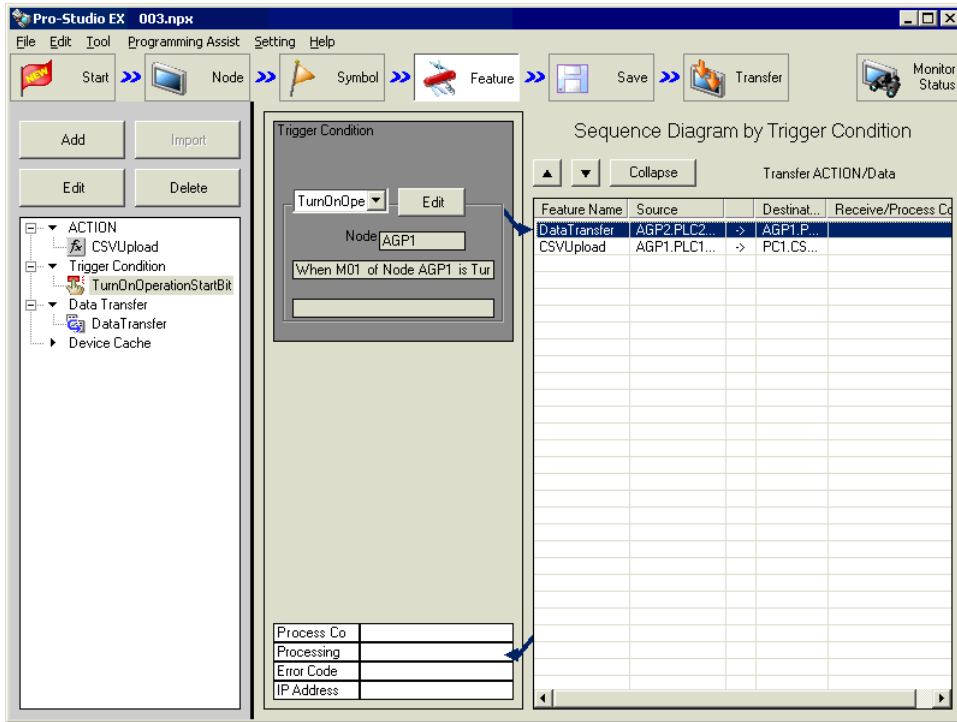

Setting item		Setting content
Trigger Condition Display	Trigger Condition Name	Displays the name of the trigger condition. Select the name by clicking the list button when you wish to change the trigger condition.
	Edit	Edits the displayed trigger condition. Edit the set contents on the trigger condition settings screen to be displayed.
	Node	Displays the node name having device (or symbol) to be a trigger condition.
	Trigger Condition	Displays the contents of the trigger conditions.
Sequence Diagram	▲ / ▼	Moves the operation order of the specified ACTION upward (or downward) by one row.
	Reduced Display / Expanded Display	Change the display format of ACTION. <ul style="list-style-type: none"> <li>• Reduced display Displays only [Feature Name].</li> <li>• Expanded display Displays all information of ACTION processing in details.</li> </ul>
	Feature Name	Displays the ACTION name.
	Source	Displays the node name, device name and data-transferring device of the data transfer source.
	Destination	Displays the node name, device name and data-receiving device of the data transfer destination.

Setting item		Setting content
Sequence Diagram	Receive/Process Completion Notification	Displays the node name, device name and device notifying the receipt and process completion.
Processing Results	Process Completed	Displays the device notifying process completion.
	Processing Results	Displays the device notifying the processing results.
	Error Code	Displays the device where error code is stored in the case of error occurrence.
	IP Address	Displays the device where IP address of processing destination is stored in the case of error occurrence.



## 32.5 Executing ACTION under Multiple Trigger Conditions

Specified contents of ACTION are displayed on the "ACTION-Specific Trigger Condition/Process List" screen. Though this screen displays the contents of the existing ACTION, you can add trigger conditions on this screen when you wish to execute one ACTION under multiple trigger conditions.

It is also possible to edit and delete the set contents of trigger condition and ACTION.

Refer to "32.5.2 Setting Guide" for more details about the screen.

**NOTE** • As for the data transfer, specification of multiple trigger conditions is not available.

### 32.5.1 Adding Trigger Conditions

Ex.

Add a new trigger condition "Turn on write start bit" to "At 17:00 Everyday" already registered to the ACTION "Write data in CSV file".

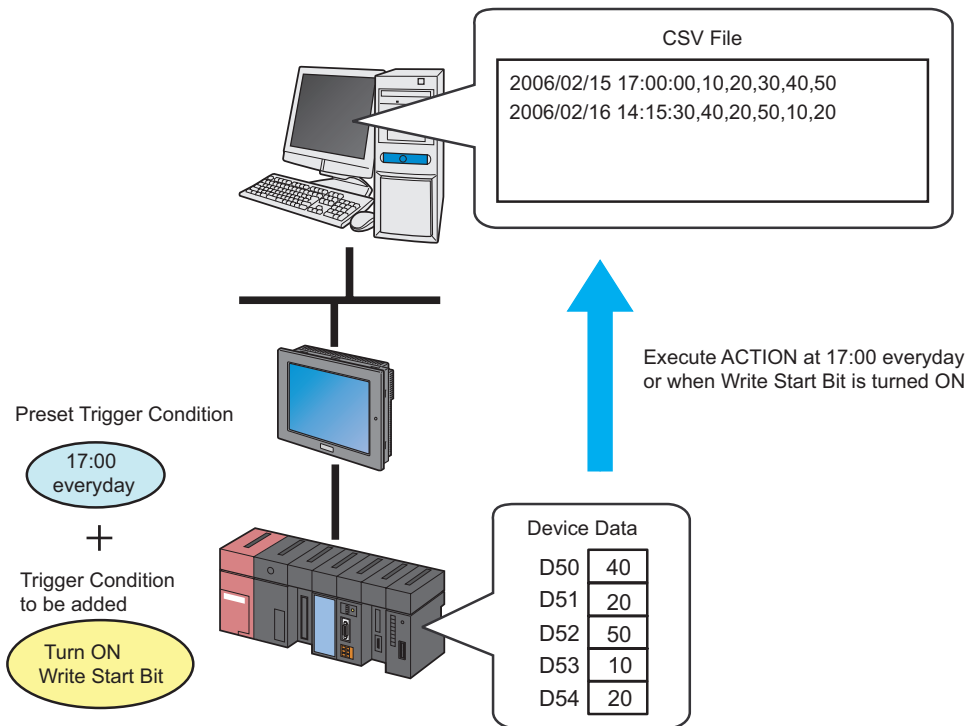

[Set contents already specified]

Setting item	Setting content
ACTION Name	CSV upload
Trigger Condition Name	17:00 everyday
Trigger Condition	Specified time: 17:00
Transfer Destination Device Name	PLC1
Transfer Destination Device	PLC1 symbol "PLC1 Data" (D50 to D54)
ACTION Node	PC1
Receive Notification	OFF

[Set contents to be newly added]

Setting item	Setting content
Trigger Condition Name	Turn on write start bit
Trigger Condition	When "Start writing" (M01) is ON
Transfer Destination Device Name	PLC1
Transfer Destination Device	PLC1 symbol "PLC1 Data" (D50 to D54)
ACTION Node	PC1
Receive Notification	OFF

1 Click the [Add] button on the "ACTION-Specific Trigger Condition/Process List" screen.

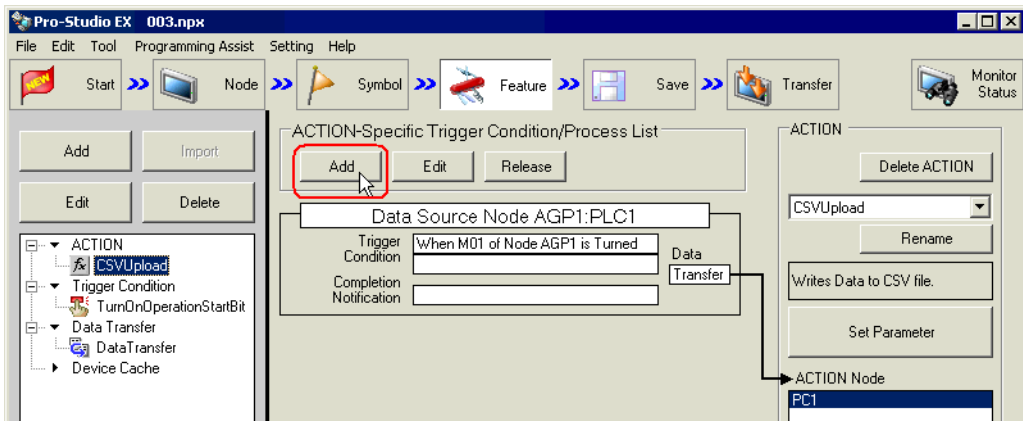

2 Click the [New Trigger Condition] button.

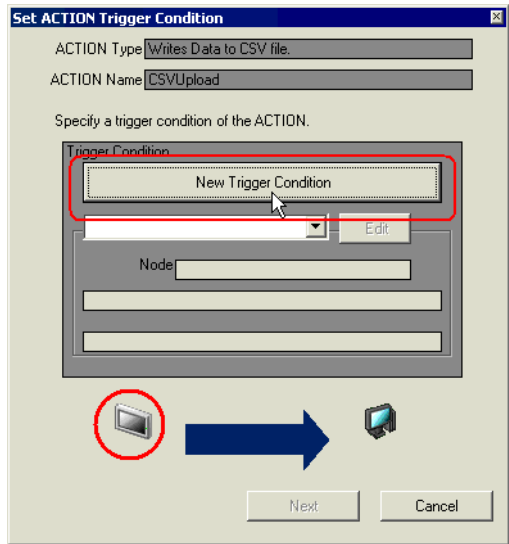

3 Enter "TurnOnWriteStartBit" in [Trigger Condition Name] as the name of newly added trigger condition and select "AGP1" in [Node Name].

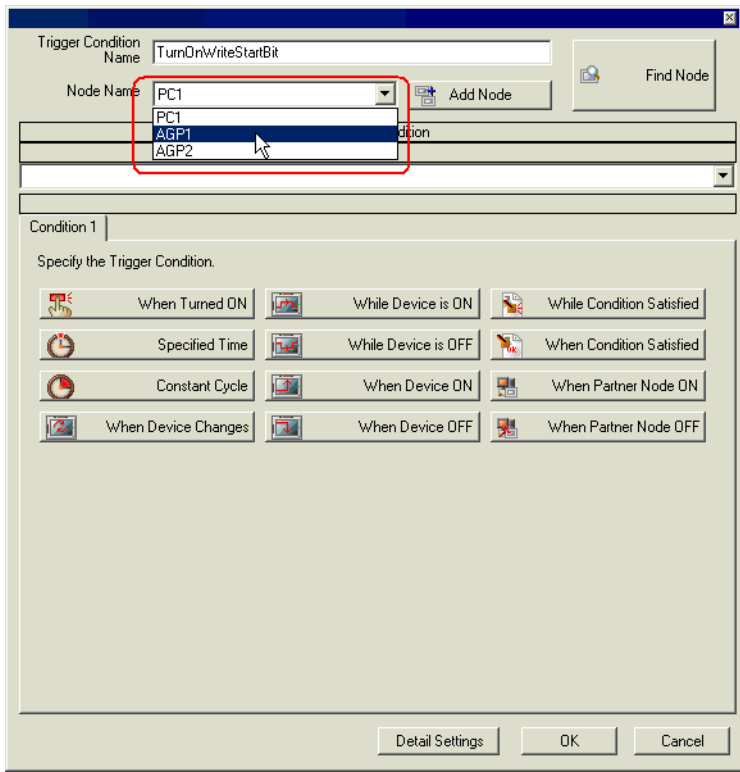

- Click the [When Device On] button in the [Condition 1] tab, and select "PLC1" as a device name and then "Start Write" as a device symbol name to be a trigger. Then click the [OK] button.

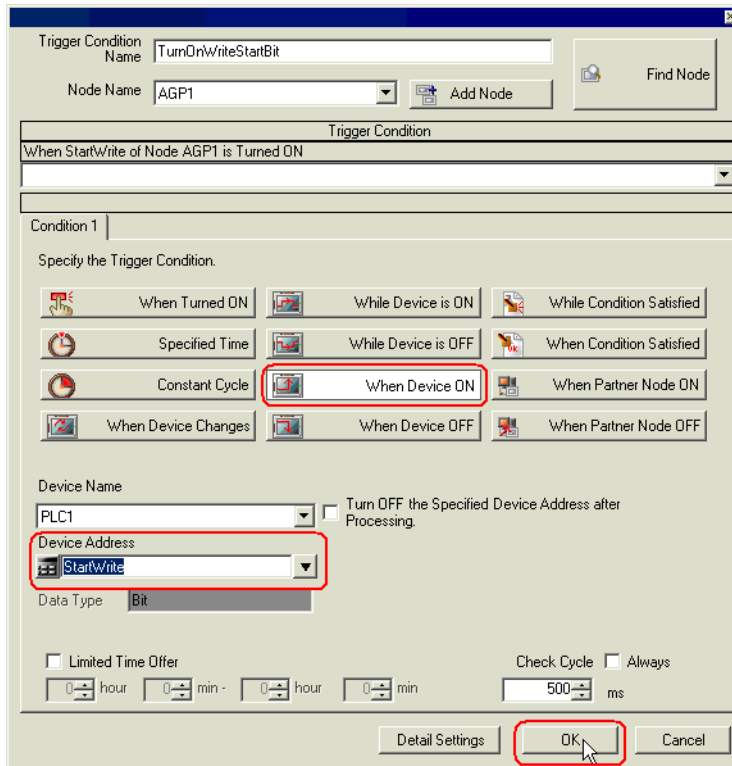

- On the "Set ACTION Trigger Condition" screen, click the [Next] button.

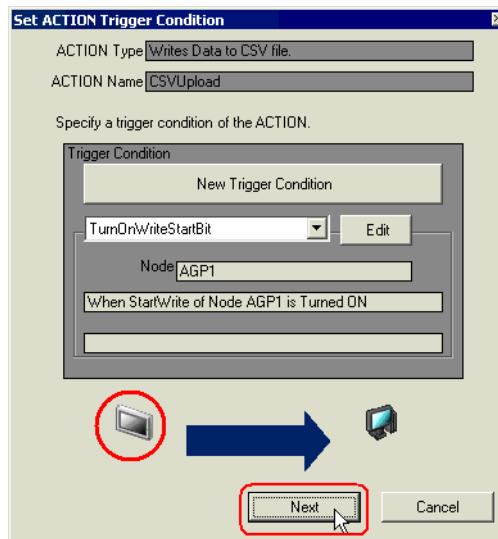

6 Click the list button of [Device Name] and select "PLC1" as a Device/PLC to read data from.

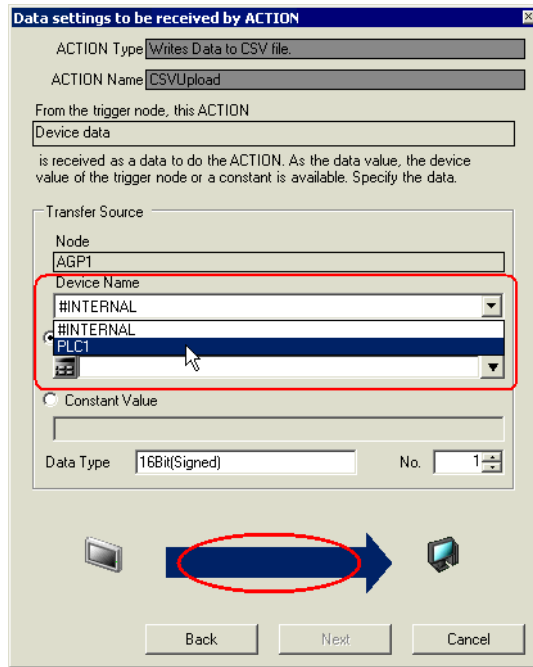

7 Click [Device Address] and then the list button to select "PLC1 Data" as a symbol name of the Device/PLC "PLC1" to read data from.

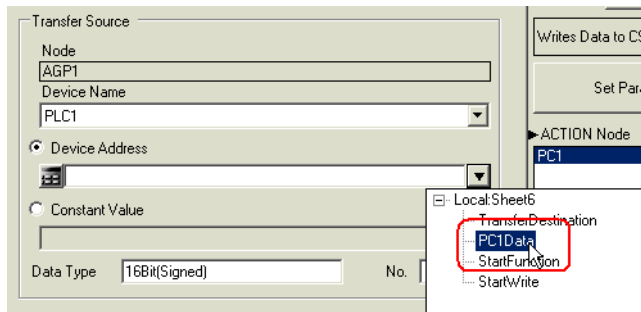

8 Click the [Next] button.

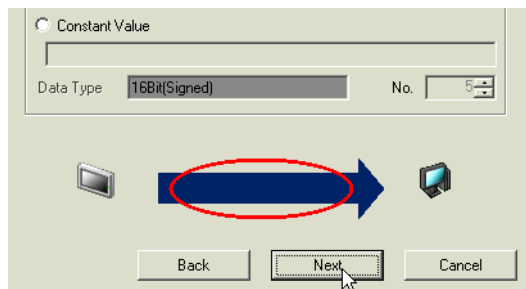

- 9 Click the list button of [ACTION Node] on the "Set ACTION Node/Process Completion Notification" screen, and select "PC1" as a node name where ACTION works.

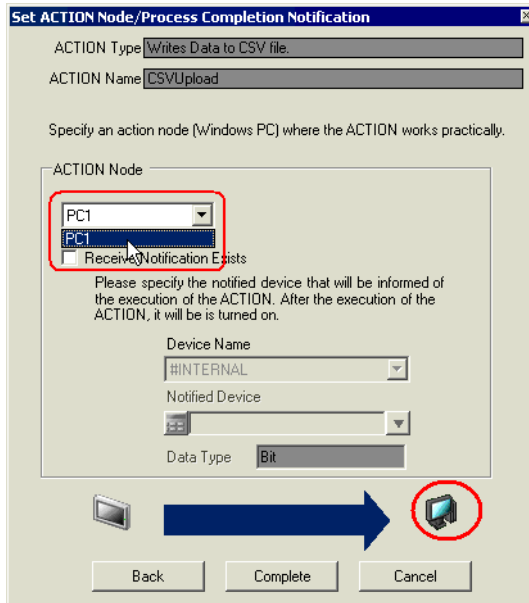

- 10 Turn off the check box of [Receive Notification Exists], if checked.

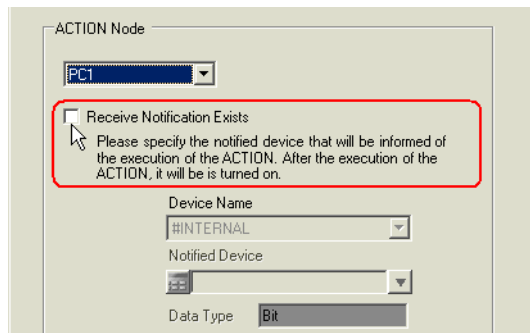

- 11 Click the [Complete] button.

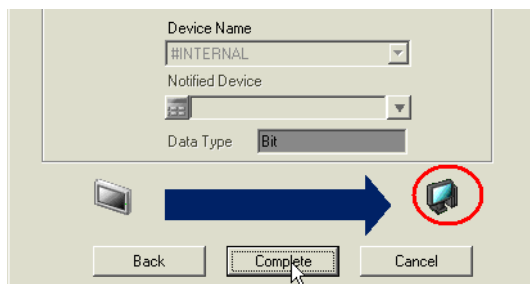

12 Click the ACTION name where the trigger conditions are added, from the list on the left of the screen.

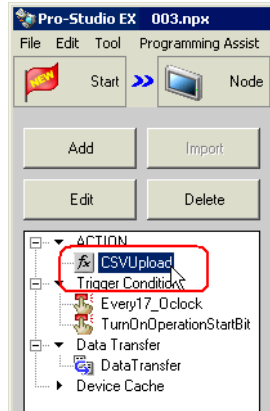

Added trigger conditions are now displayed on the "ACTION-Specific Trigger Condition/Process List" screen.

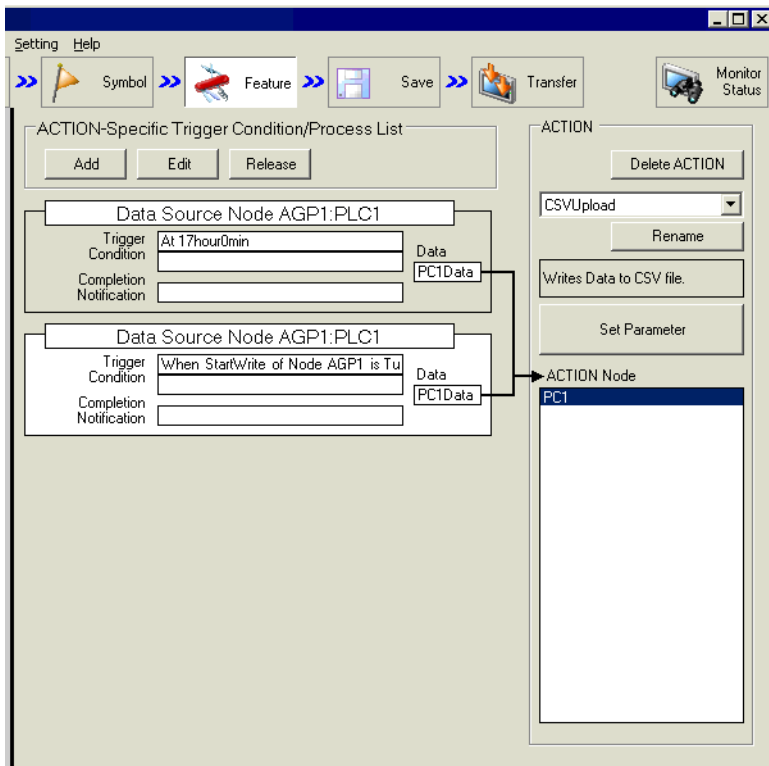

### 32.5.2 Setting Guide

This section describes the contents on the "ACTION-Specific Trigger Condition/Process List" screen.

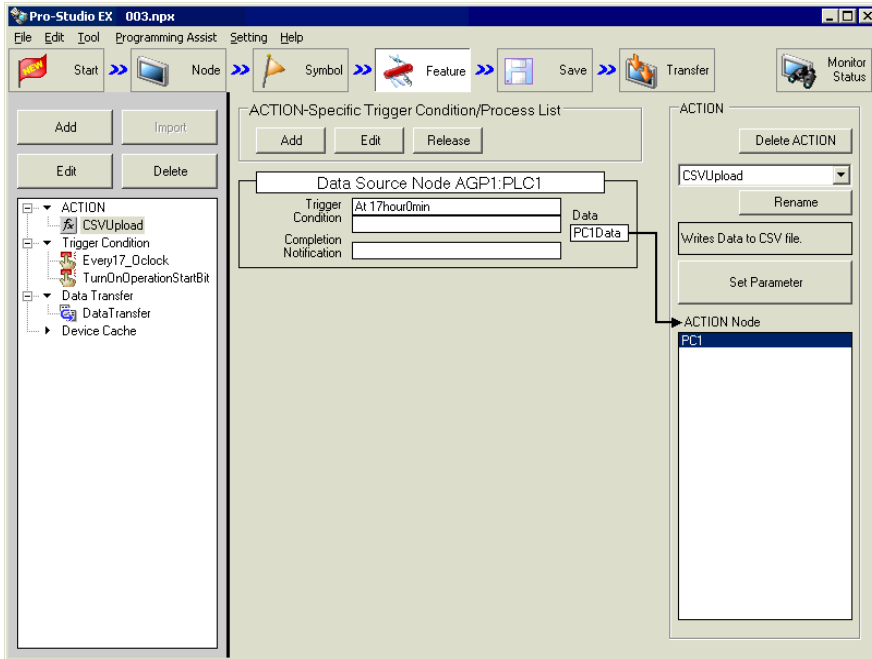

Setting item		Setting content
ACTION-Specific Trigger Condition/Process List	Add	The "Set ACTION Trigger Condition" screen appears. Specifies trigger conditions to be added on the following screens.
	Edit	The "Set ACTION" screen appears. Edits the contents of trigger conditions on this screen.
	Delete	Deletes the specified trigger conditions.
Trigger Condition Display	Data Source Node	Displays the name of the node and device to be the data source node of ACTION.
	Trigger Condition	Displays the contents of the trigger conditions.
	Data	Displays the contents of ACTION data.
	Completion Notification	Displays the device (or symbol) notifying the processing completion.
ACTION Display	Delete ACTION	Deletes the displayed ACTION.
	Trigger Condition Name	Selects an ACTION to change the displayed ACTION.
	Rename	Changes the displayed ACTION name. Change the name on the "Edit ACTION Name" screen.
	Set Parameter	Edits the parameter of ACTION. Displays the parameter setting screen corresponding to each ACTION. Edit the set contents on this screen.
	ACTION Node	Displays the ACTION nodes.