



X-SEL Controller Driver

1	System Configuration.....	3
2	Selection of External Device	7
3	Example of Communication Setting.....	8
4	Setup Items.....	10
5	Cable Diagram	15
6	Supported Device.....	18
7	Device Code and Address Code.....	35
8	Error Messages.....	37

Introduction

This manual describes how to connect the Display and the External Device.

In this manual, the connection procedure will be described by following the sections below.

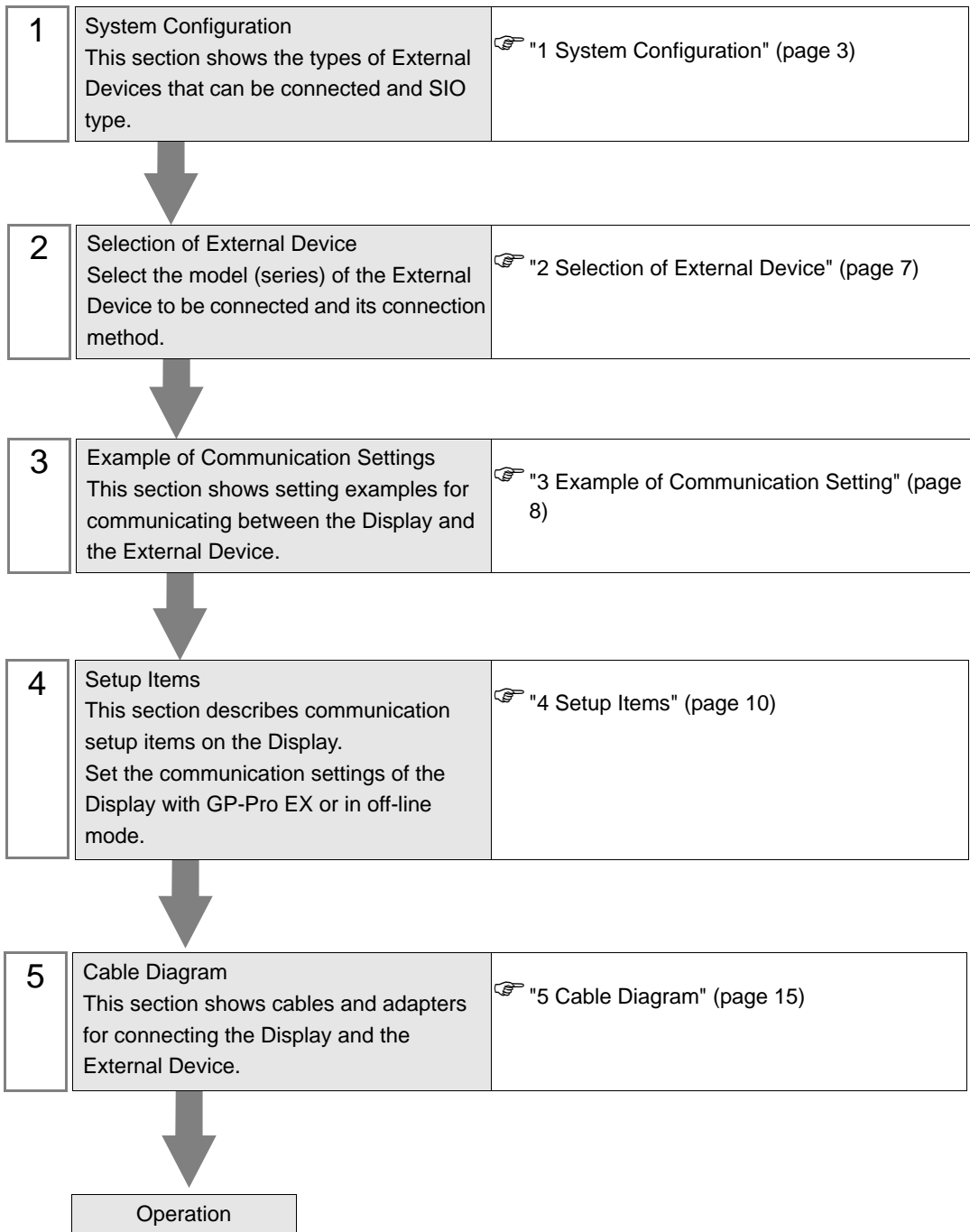

1 System Configuration

The following shows the system configuration in which the External Device of IAI Corporation and the Display are connected.

Series	CPU	Link I/F	SIO Type	Setting Example	Cable Diagram
X-SEL (Linear Actuator Controller)	XSEL-J	Serial port on the CPU unit (Teaching connector)	RS232C	Setting Example 1 (page 8)	Cable Diagram 1 (page 15)
	XSEL-K XSEL-KE XSEL-KT XSEL-KET	Serial port on the CPU unit (PC connector)	RS232C	Setting Example 1 (page 8)	Cable Diagram 2 (page 16)
	XSEL-P XSEL-Q	Serial port on the CPU unit (Teaching connector)	RS232C	Setting Example 1 (page 8)	Cable Diagram 1 (page 15)
X-SEL (SCARA Robot Controller)	XSEL-JX	Serial port on the CPU unit (Teaching connector)	RS232C	Setting Example 1 (page 8)	Cable Diagram 1 (page 15)
	XSEL-KX XSEL-KTX	Serial port on the CPU unit (PC connector)	RS232C	Setting Example 1 (page 8)	Cable Diagram 2 (page 16)
	XSEL-PX XSEL-QX	Serial port on the CPU unit (Teaching connector)	RS232C	Setting Example 1 (page 8)	Cable Diagram 1 (page 15)
SSEL	SSEL	Serial port on the CPU unit (Teaching connector)	RS232C	Setting Example 1 (page 8)	Cable Diagram 3 (page 17)
ASEL	ASEL	Serial port on the CPU unit (Teaching connector)	RS232C	Setting Example 1 (page 8)	Cable Diagram 3 (page 17)
PSEL	PSEL	Serial port on the CPU unit (Teaching connector)	RS232C	Setting Example 1 (page 8)	Cable Diagram 3 (page 17)
Table-Top Actuator	TT	Serial port on the CPU unit (Teaching connector)	RS232C	Setting Example 1 (page 8)	Cable Diagram 1 (page 15)

■ Connection Configuration

- 1:1 Connection



■ IPC COM Port

When connecting IPC with an External Device, the COM port used depends on the series and SIO type. Please refer to the IPC manual for details.

Usable port

Series	Usable Port		
	RS-232C	RS-422/485(4 wire)	RS-422/485(2 wire)
PS-2000B	COM1 ^{*1} , COM2, COM3 ^{*1} , COM4	-	-
PS-3450A, PS-3451A, PS3000-BA, PS3001-BD	COM1, COM2 ^{*1*2}	COM2 ^{*1*2}	COM2 ^{*1*2}
PS-3650A, PS-3651A	COM1 ^{*1}	-	-
PS-3700A (Pentium®4-M) PS-3710A	COM1 ^{*1} , COM2 ^{*1} , COM3 ^{*2} , COM4	COM3 ^{*2}	COM3 ^{*2}
PS-3711A	COM1 ^{*1} , COM2 ^{*2}	COM2 ^{*2}	COM2 ^{*2}
PL-3000B, PL-3600T, PL-3600K, PL-3700T, PL-3700K, PL-3900T	COM1 ^{*1*2} , COM2 ^{*1} , COM3, COM4	COM1 ^{*1*2}	COM1 ^{*1*2}

*1 The RI/5V can be switched. Use the IPC's switch to change if necessary.

*2 Set up the SIO type with the DIP switch. Please set up as follows according to SIO type to be used.

DIP switch setting: RS-232C

DIP switch	Setting	Description
1	OFF ^{*1}	Reserved (always OFF)
2	OFF	SIO type: RS-232C
3	OFF	
4	OFF	Output mode of SD (TXD) data: Always output
5	OFF	Terminal resistance (220Ω) insertion to SD (TXD): None
6	OFF	Terminal resistance (220Ω) insertion to RD (RXD): None
7	OFF	Short-circuit of SDA (TXA) and RDA (RXA): Not available
8	OFF	Short-circuit of SDB (TXB) and RDB (RXB): Not available
9	OFF	RS (RTS) Auto control mode: Disabled
10	OFF	

*1 When using PS-3450A, PS-3451A, PS3000-BA and PS3001-BD, turn ON the set value.

DIP switch setting: RS-422/485 (4 wire)

DIP switch	Setting	Description
1	OFF	Reserved (always OFF)
2	ON	SIO type: RS-422/485
3	ON	
4	OFF	Output mode of SD (TXD) data: Always output
5	OFF	Terminal resistance (220Ω) insertion to SD (TXD): None
6	OFF	Terminal resistance (220Ω) insertion to RD (RXD): None
7	OFF	Short-circuit of SDA (TXA) and RDA (RXA): Not available
8	OFF	Short-circuit of SDB (TXB) and RDB (RXB): Not available
9	OFF	RS (RTS) Auto control mode: Disabled
10	OFF	

DIP switch setting: RS-422/485 (2 wire)

DIP switch	Setting	Description
1	OFF	Reserved (always OFF)
2	ON	SIO type: RS-422/485
3	ON	
4	OFF	Output mode of SD (TXD) data: Always output
5	OFF	Terminal resistance (220Ω) insertion to SD (TXD): None
6	OFF	Terminal resistance (220Ω) insertion to RD (RXD): None
7	ON	Short-circuit of SDA (TXA) and RDA (RXA): Available
8	ON	Short-circuit of SDB (TXB) and RDB (RXB): Available
9	ON	RS (RTS) Auto control mode: Enabled
10	ON	

2 Selection of External Device

Select the External Device to be connected to the Display.

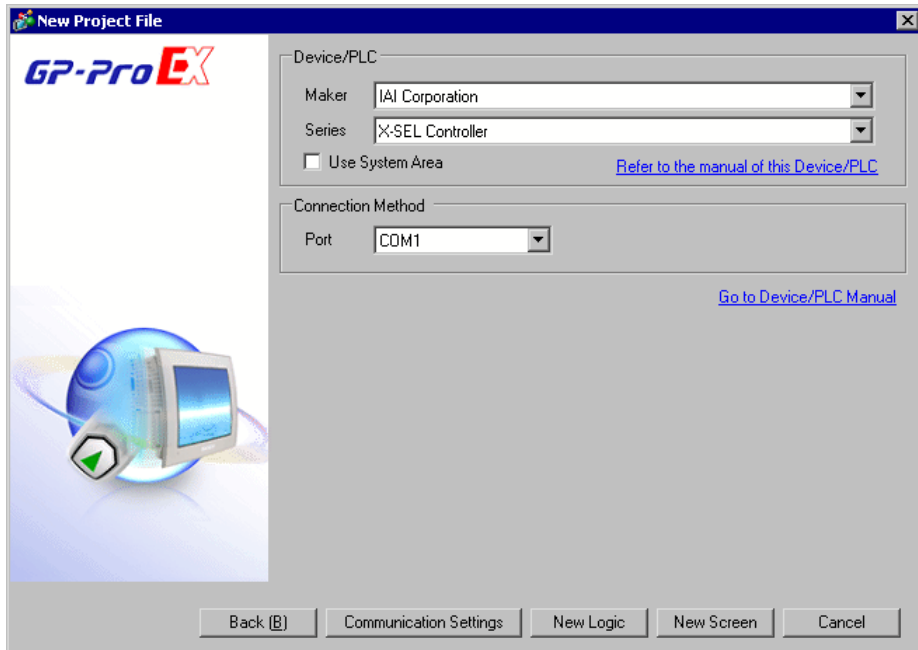

Setup Items	Setup Description
Maker	Select the maker of the External Device to be connected. Select "IAI Corporation".
Series	Select the model (series) of the External Device to be connected and its connection method. Select "X-SEL Controller". Check the External Device that can be connected in "X-SEL Controller" in system configuration.  "1 System Configuration" (page 3)
Use System Area	Check this option when you synchronize the system data area of Display and the device (memory) of External Device. When synchronized, you can use the ladder program of External Device to switch the display or display the window on the display. Cf. GP-Pro EX Reference Manual "LS Area (Direct Access Method Area)" This can also be set in GP-Pro EX or in the Display's off-line mode. Cf. GP-Pro EX Reference Manual "Display Unit (System Area) Settings Guide" Cf. Maintenance/Troubleshooting Manual "Main Unit - System Area Settings"
Port	Select the port of the Display to be connected to the External Device.

3 Example of Communication Setting

The following shows examples of communication settings for the Display and the External Device, which are recommended by Pro-face.

3.1 Setting Example 1

■ Settings of GP-Pro EX

◆ Communication Settings

To display the setting screen, select [Device/PLC Settings] from [System setting window] in workspace.

Device/PLC 1

Summary [Change Device/PLC](#)

Maker IAI Corporation Series X-SEL Controller Port COM1

Text Data Mode 1 [Change](#)

Communication Settings

SID Type RS232C RS422/485(2wire) RS422/485(4wire)

Speed 9600

Data Length 7 8

Parity NONE EVEN ODD

Stop Bit 1 2

Flow Control NONE ER(DTR/CTS) XON/XOFF

Timeout 3 (sec)

Retry 2

Wait To Send 0 (ms)

RI / VCC RI VCC

In the case of RS232C, you can select the 9th pin to RI (Input) or VCC (5V Power Supply). If you use the Digital's RS232C Isolation Unit, please select it to VCC.

Default

Device-Specific Settings

Allowable Number of Devices/PLCs 1

Number	Device Name	Settings
1	PLC1	Station Code=153

◆ Device Setting

To display the setting screen, click ([Setting]) of the External Device you want to set from [Device-Specific Settings] of [Device/PLC Settings].

To connect multiple External Devices, click from [Device-Specific Settings] of [Device/PLC Settings] to add External Devices.

Individual Device Settings

PLC1

Station Code 153

Default

OK (O) Cancel

■ Settings of External Device

Use the mode switch and the ladder software (PC Software for X-SEL) to configure communication settings for the External Device. Refer to your External Device manual for details.

- 1 Set the mode switch to "MANU", and turn on the power.
- 2 Start up the ladder software.
- 3 From the [Parameter] menu, select [Edit] to display the [Edit Parameter] dialog box.
- 4 Click the [I/O] tab and set the following parameters.

No	Parameter Name	Setting Value
90	Usage of SIO channel 1 opened to user (AUTO mode)	2
91	Station code of SIO channel 1 opened to user	153
92	Baud rate type of SIO channel 1 opened to user	0
93	Data length of SIO channel 1 opened to user	8
94	Stop bit length of SIO channel 1 opened to user	1
95	Parity type of SIO channel 1 opened to user	0

- 5 Click the [Transfer to Controller] button and transfer the communication settings.
- 6 Set the mode switch to "AUTO".
The communication settings are completed.

4 Setup Items

Set the communication settings of the Display with GP-Pro Ex or in off-line mode of the Display.

The setting of each parameter must match that of the External Device.

 "3 Example of Communication Setting" (page 8)

4.1 Setup Items in GP-Pro EX

■ Communication Settings

To display the setting screen, select [Device/PLC Settings] from [System setting window] in workspace.

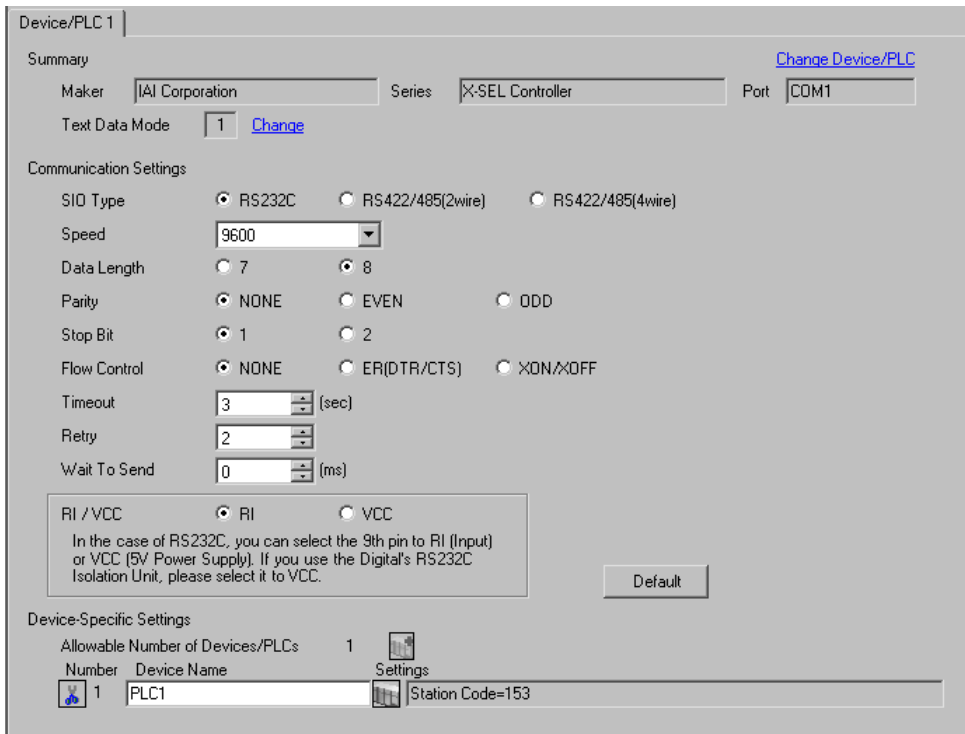

Device/PLC 1

Summary [Change Device/PLC](#)

Maker Series Port

Text Data Mode [Change](#)

Communication Settings

SIO Type RS232C RS422/485(2wire) RS422/485(4wire)

Speed

Data Length 7 8

Parity NONE EVEN ODD

Stop Bit 1 2

Flow Control NONE ER(DTR/CTS) XON/XOFF

Timeout (sec)

Retry



Wait To Send (ms)

RI / VCC RI VCC

In the case of RS232C, you can select the 9th pin to RI (Input) or VCC (5V Power Supply). If you use the Digital's RS232C Isolation Unit, please select it to VCC.

Device-Specific Settings

Allowable Number of Devices/PLCs 

Number	Device Name	Settings
 1	PLC1	 Station Code=153

Setup Items	Setup Description
SIO Type	Select the SIO type for communicating with the External Device.
Speed	Select the communication speed between the External Device and the Display.
Data Length	Select a data length.
Parity	Select how to check parity.
Stop Bit	Select a stop bit length.
Flow Control	Select the communication control method to prevent overflow of transmission and reception data.
Timeout	Use an integer from 1 to 127 to enter the time (s) for which the Display waits for the response from the External Device.

Continued to next page.

Setup Items	Setup Description
Retry	In case of no response from the External Device, enter how many times the Display retransmits the command, from "0 to 255".
Wait To Send	Enter the standby time (ms) from when the Display receives packets until it transmits the next command, from "0 to 255".
RI/VCC	You can switch between RI/VCC of the 9th pin when you select RS232C for the SIO type. To connect to the IPC, you need to use the IPC selector switch to switch RI/5V. Refer to your IPC manual for details.

■ Device Setting

To display the setting screen, click  ([Setting]) of the External Device you want to set from [Device-Specific Settings] of [Device/PLC Settings].

To connect multiple External Devices, click  from [Device-Specific Settings] of [Device/PLC Settings] to add External Devices.

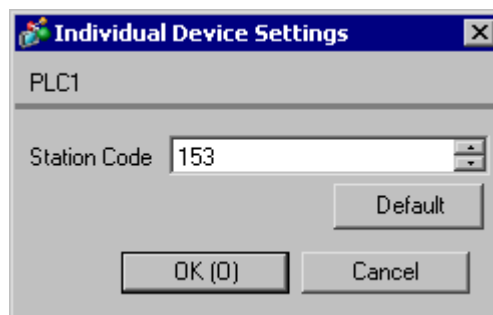

Setup Items	Setup Description
Station Code	Use an integer from 0 to 255 to enter the station code of the External Device.

4.2 Settings in Off-Line Mode

NOTE

- Refer to the Maintenance/Troubleshooting manual for information on how to enter off-line mode or about the operation.

Cf. Maintenance/Troubleshooting Manual "Off-line Mode"

- The number of the setup items to be displayed for 1 page in the off-line mode depends on the Display in use. Please refer to the Reference manual for details.

■ Communication Settings

To display the setting screen, touch [Device/PLC Settings] from [Peripheral Equipment Settings] in off-line mode. Touch the External Device you want to set from the list that appears.

Comm.	Device	Option		
X-SEL Controller			[COM1]	Page 1/1
SIO Type		RS232C		
Speed		9600		
Data Length		<input type="radio"/> 7 <input checked="" type="radio"/> 8		
Parity		<input checked="" type="radio"/> NONE <input type="radio"/> EVEN <input type="radio"/> ODD		
Stop Bit		<input checked="" type="radio"/> 1 <input type="radio"/> 2		
Flow Control		NONE		
Timeout(s)		3	▼ ▲	
Retry		2	▼ ▲	
Wait to Send(ms)		0	▼ ▲	
	Exit		Back	2008/02/21 02:02:58

Setup Items	Setup Description
SIO Type	Select the SIO type for communicating with the External Device. IMPORTANT In the communication settings, set [SIO Type] correctly according to the serial interface specifications of the Display. If you select an SIO type that the serial interface does not support, proper operation cannot be guaranteed. Refer to your Display manual for details on the serial interface specifications.
Speed	Select the communication speed between the External Device and the Display.
Data Length	Select a data length.
Parity	Select how to check parity.

Continued to next page.

Setup Items	Setup Description
Stop Bit	Select a stop bit length.
Flow Control	Select the communication control method to prevent overflow of transmission and reception data.
Timeout	Use an integer from 1 to 127 to enter the time (s) for which the Display waits for the response from the External Device.
Retry	In case of no response from the External Device, enter how many times the Display retransmits the command, from "0 to 255".
Wait To Send	Enter the standby time (ms) from when the Display receives packets until it transmits the next command, from "0 to 255".

■ Device Setting

To display the setting screen, touch [Device/PLC Settings] from [Peripheral Equipment Settings]. Touch the External Device you want to set from the list that appears, and touch [Device].

Comm.	Device	Option		
X-SEL Controller			[COM1]	Page 1/1
Device/PLC Name	PLC1			
Station Code	153			
Exit	Back	2008/02/21 02:03:01		

Setup Items	Setup Description
Device/PLC Name	Select the External Device to set. The device name is the title of the External Device set with GP-Pro EX. (Initial value [PLC1])
Station Code	Use an integer from 0 to 255 to enter the station code of the External Device.

■ Option

To display the setting screen, touch [Device/PLC Settings] from [Peripheral Equipment Settings]. Touch the External Device you want to set from the list that appears, and touch [Option].

Comm.	Device	Option		
X-SEL Controller			[COM1]	Page 1/1
RI / VCC <input checked="" type="radio"/> RI <input type="radio"/> VCC In the case of RS232C, you can select the 9th pin to RI(Input) or VCC(5V Power Supply). If you use the Digital's RS232C Isolation Unit, please select it to VCC.				
	Exit		Back	2008/02/21 02:03:07

Setup Items	Setup Description
RI/VCC	You can switch between RI/VCC of the 9th pin when you select RS232C for the SIO type. To connect to the IPC, you need to use the IPC selector switch to switch RI/5V. Refer to your IPC manual for details.

NOTE

- GP-4100 series do not have the [Option] setting in the off-line mode.

5 Cable Diagram

The cable diagram shown below may be different from the cable diagram recommended by IAI Corporation. Please be assured there is no operational problem in applying the cable diagram shown in this manual.

- The FG pin on the External Device must be D-class grounded. Refer to your External Device manual for details.
- The SG and FG are connected inside the Display. If you connect the External Device to the SG, do not form any short-circuit loop in the system design.
- If the communication is not stable because of noise or other factors, connect an isolation unit.

Cable Diagram 1

Display (Connection Port)	Cable		Remarks
GP3000 (COM1) ST (COM1) LT (COM1) IPC*1 PC/AT	1A	Connection cable by IAI Corporation CB-ST-E1MW050	
GP-4105 (COM1)	1B	User-created cable + Connection cable by IAI Corporation CB-ST-E1MW050	The cable length must be 10m or less.

*1 Available only with a COM port that supports RS232C.

☞ ■ IPC COM Port (page 5)

1A)

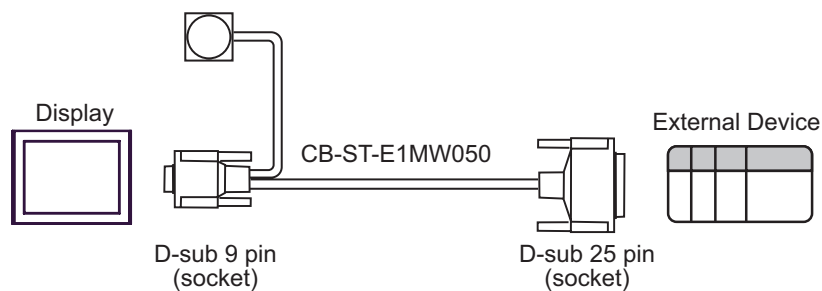

1B)

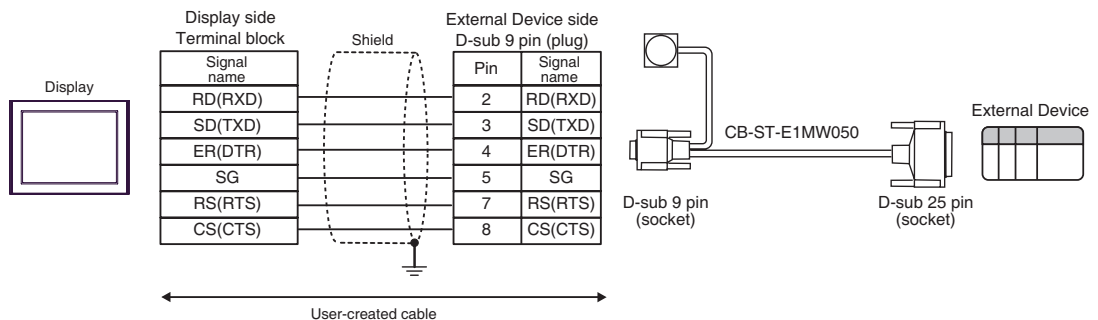

Cable Diagram 2

Display (Connection Port)	Cable		Remarks
GP3000 (COM1) ST (COM1) LT (COM1) IPC*1 PC/AT	2A	User-created cable	The cable length must be 10m or less.
GP-4105 (COM1)	2B	User-created cable	

*1 Available only with a COM port that supports RS232C.

 ■ IPC COM Port (page 5)

2A)

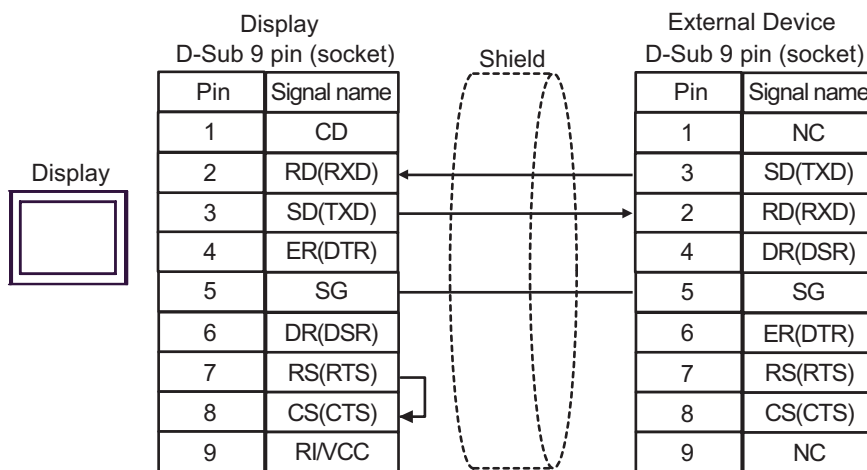

2B)

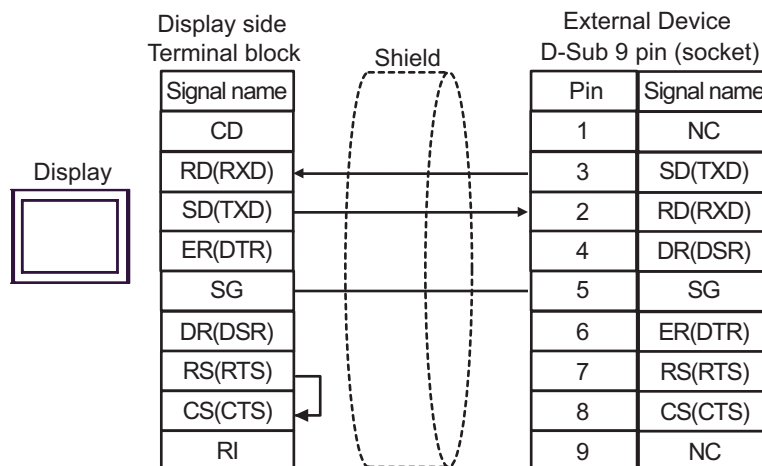

Cable Diagram 3

Display (Connection Port)	Cable		Remarks
GP3000 (COM1) ST (COM1) LT (COM1) IPC*1 PC/AT	3A	Connection cable by IAI Corporation CB-ST-E1MW050 + Connector conversion cable by IAI Corporation CB-SEL-SJ002	
GP-4105 (COM1)	3B	User-created cable + Connection cable by IAI Corporation CB-ST-E1MW050 + Connector conversion cable by IAI Corporation CB-SEL-SJ002	

*1 Available only with a COM port that supports RS232C.

 ■ IPC COM Port (page 5)

3A)

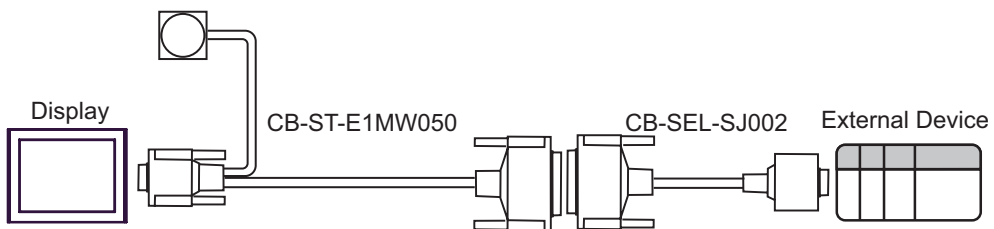

3B)

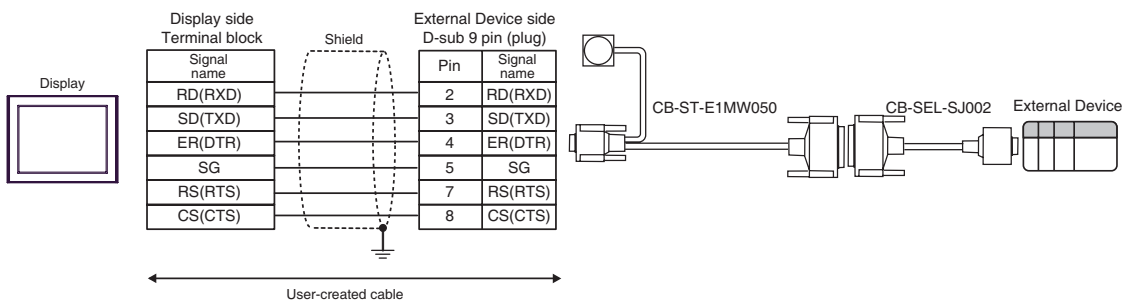





6 Supported Device

The following table shows the range of supported device addresses. Available type and range of device may vary depending on the CPU. Consult the appropriate CPU manual before use.

To avoid the External Device malfunction, do not access an out-of-range address.

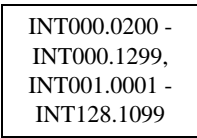
 : This address can be specified as system data area.

Device	Bit Address	Word Address	Double Word Address	32 bits	Remarks
Input Port	IP000 - IP299	IP000 - IP272	-----	L / H	 *1
Output Port	OP300 - OP599	OP300 - OP572	-----		
Flag	FG000.600 - FG000.899 FG001.900 - FG128.999	FG000.600 - FG000.872 FG001.900 - FG128.980	-----		 *2
Point Data Total Count	-----	PDT0	-----	-----	*1
Integer	-----	-----	 INT000.0200 - INT000.1299, INT001.0001 - INT128.1099	L / H	*3
Real	-----	-----	RL000.0300 - RL000.1399, RL001.0100 - RL128.1199		*4
String	-----	STR000.300 - STR000.998 STR001.001 - STR128.299	-----		 *5
Axis Status	-----	AXST00 - AXST47	-----		*1 *6
Scara Axis Status	-----	SAXS000 - SAXS3FF	-----		*1 *7
Version	-----	VR000 - VR3FF	-----		*1 *8
Error Detail 0	-----	-----	ER00000000 - ER0FFFFFFF		*1 *9
Error Detail 1	-----	-----	ER10000000 - ER1FFFFFFF		*1 *9
Error Detail 2	-----	-----	ER20000000 - ER2FFFFFFF		*1 *9
Error Detail 3	-----	-----	ER30000000 - ER3FFFFFFF		*1 *9

Continued to next page.

Device	Bit Address	Word Address	Double Word Address	32 bits	Remarks
Error Detail 4	-----	-----	ER40000000 - ER4FFFFFFF	[L/H]	*1 *9
Error Detail 5	-----	-----	ER50000000 - ER5FFFFFFF		*1 *9
Error Detail 6	-----	-----	ER60000000 - ER6FFFFFFF		*1 *9
Error Detail 7	-----	-----	ER70000000 - ER7FFFFFFF		*1 *9
Program Status	-----	PGST000 - PGST511	-----		*1 *10
System Status	-----	SYST0 - SYST6	-----		*1 *11
Program Control	-----	PRG000 - PRG128	-----		*12 *13
Alarm Reset	-----	AR0	-----	-----	*12
Software Reset	-----	SR0	-----		*12 *14
Drive-Source Recovery	-----	DSR0	-----		*12
Operation-Pause Reset	-----	OPR0	-----		*12
Point Data Clear	PCLR001 - PCLRFA0 PCLR0001 - PCLR4E20	PCLR001 - PCLRF91 PCLR0001 - PCLR4E11	-----	[L/H]	*12 *15
Absolute Coordinate Movement	-----	-----	ACM0 - ACMC		*16
Relative Coordinate Movement	-----	-----	RCM0 - RCMC		*17
Jogging/Inching Movement	-----	-----	JIM0 - JIM6		*18
Point Number Movement	-----	PNM0 - PNM5	-----		*19
Point Data	-----	-----	PD00 - PD9E		*20
Servo	-----	SV0 - SV2	-----		*21
Return to Origin	-----	RO0 - RO3	-----		*22
Operation Stop/Cancel	-----	OSC0 - OSC2	-----		*23
Coordinate Affiliate Data	-----	-----	CD0000 - CD1FFF		*1 *24
Simple Interference Check Zone Data	-----	-----	SD010 - SDFFF	*1 *25	

Continued to next page.

Device	Bit Address	Word Address	Double Word Address	32 bits	Remarks
Scara Absolute Coordinate Movement	-----	-----	SACM0 - SACMD	[L / H]	*26
Scara Relative Coordinate Movement	-----	-----	SRCM0 - SRCMD		*27
Scara Point Number Movement	-----	SPNM0 - SPNM6	-----		*28
Feedback Current *29	-----	FC0 - FCA	-----		*1 *30
Task Status	-----	TAST00 - TAST80	-----		[Bit 15] *1 *31
Flash ROM	-----	FR0	-----		[Bit 15] *12*32

*1 Write disable

*2 The flag device descriptions are shown below.

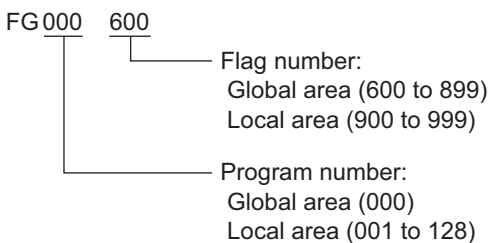

*3 The integer valuables device descriptions are shown below.

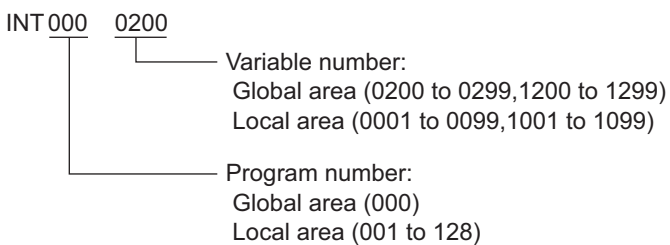

*4 The real valuables device descriptions are shown below.

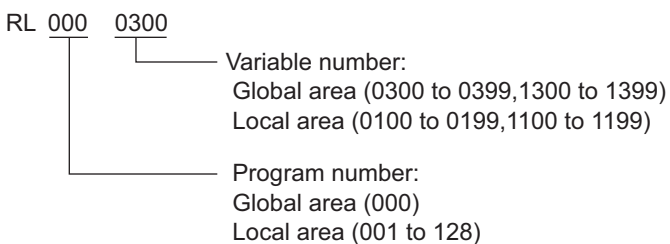

*5 The string valuables device descriptions are shown below.

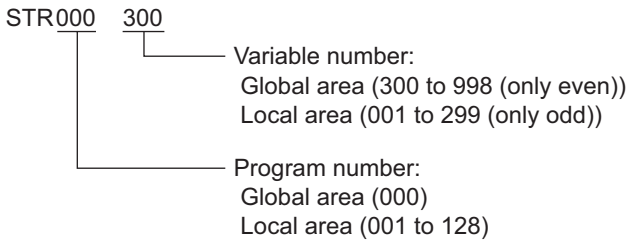

*6 The axis status device descriptions are shown below.

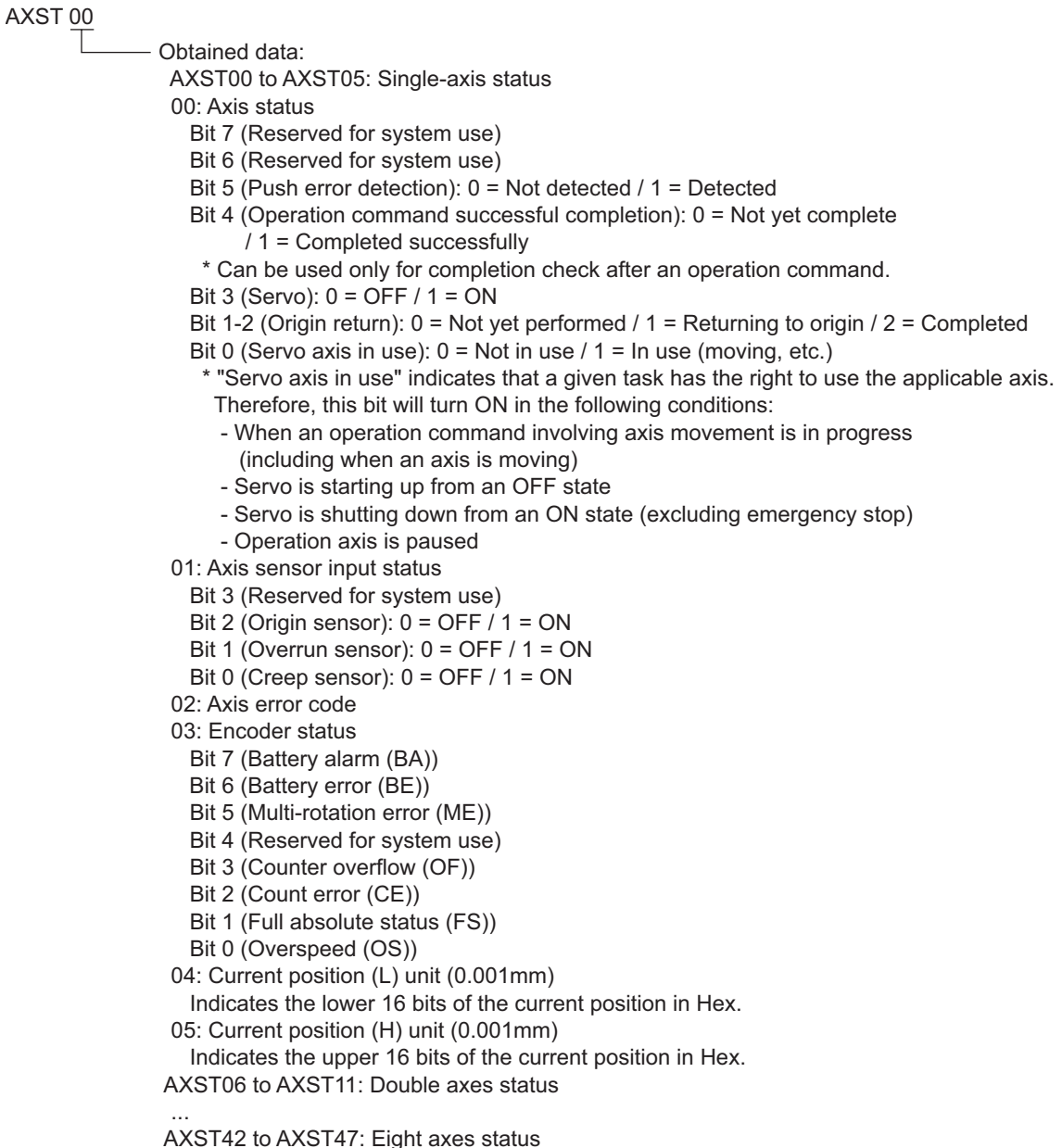

*7 The Scara axis status device descriptions are shown below.

SAXS 0 00

Obtained data:

00: Work coordinate system selection number

01: Tool coordinate system selection number

02: Common axis status

Bit 7 (Reserved for system use)

Bit 6 (Reserved for system use)

Bit 5 (Reserved for system use)

Bit 4 (Reserved for system use)

Bit 2-3 (Scara axis current position coordinate system type): 0 = Base coordinate system

/ 1 = Selected work coordinate system / 2 = Reserved for system use / 3 = Each axis system

Bit 0-1: (Scara axis current arm system): 0 = Right arm system / 1 = Left arm system

/ 2 = Indeterminable / 3 = Reserved for system use

03: Axis pattern

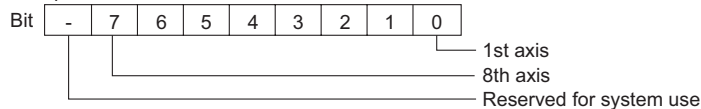

04 to 09: Single-axis status

04: Axis status

Bit 7 (Reserved for system use)

Bit 6 (Reserved for system use)

Bit 5 (Push error detection): 0 = Not detected / 1 = Detected

Bit 4 (Operation command successful completion):

0 = Not yet complete / 1 = Completed successfully

* Can be used only for completion check after an operation command.

(For positioning that includes any of the X, Y and R axes, be sure to check completion for all of the X, Y and R axes.)

Bit 3 (Servo): 0 = OFF / 1 = ON

Bit 1-2 (Origin return): 0 = Not yet performed / 1 = Returning to origin / 2 = Completed

Bit 0 (Servo axis in use): 0 = Not in use / 1 = In use (moving, etc.)

* "Servo axis in use" indicates that a given task has the right to use the applicable axis.

Therefore, this bit will turn ON in the following conditions:

- When an operation command involving axis movement is in progress (including when an axis is moving)
- Servo is starting up from an OFF state
- Servo is shutting down from an ON state (excluding emergency stop)
- Operation axis is paused

05: Axis sensor input status

Bit 3 (Reserved for system use)

Bit 2 (Origin sensor): 0 = OFF / 1 = ON

Bit 1 (Overrun sensor): 0 = OFF / 1 = ON

Bit 0 (Creep sensor): 0 = OFF / 1 = ON

06: Axis error code

07: Encoder status

Bit 7 (Battery alarm (BA))

Bit 6 (Battery error (BE))

Bit 5 (Multi-rotation error (ME))

Bit 4 (Reserved for system use)

Bit 3 (Counter overflow (OF))

Bit 2 (Count error (CE))

Bit 1 (Full absolute status (FS))

Bit 0 (Overspeed (OS))

08: Current position (L) unit (0.001mm or 0.001deg)

Indicates the lower 16 bits of the current position in Hex.

09: Current position (H) unit (0.001mm or 0.001deg)

Indicates the upper 16 bits of the current position in Hex.

0A to 0E: Double axes status

...

2E to 33: Eight axes status

34 to FF: Reserved for system use

Unit type (0 to F)

Bit 3 (Reserved for system use) Fixed to 0

Bit 2 (Reserved for system use) Fixed to 0

Bit 0-1 (Scara axis current position type): 0 = Base coordinate system

/ 1 = Selected work coordinate system / 2 = Reserved for system use / 3 = Each axis system

*8 The version device descriptions are shown below.

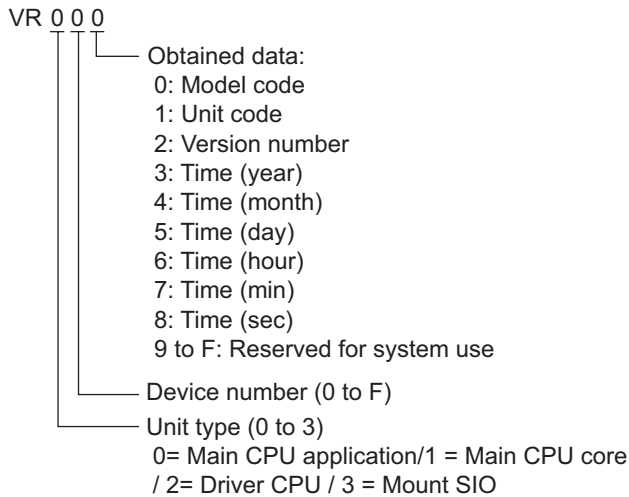

*9 The device descriptions of error detail 0 through error detail 7 are shown below.

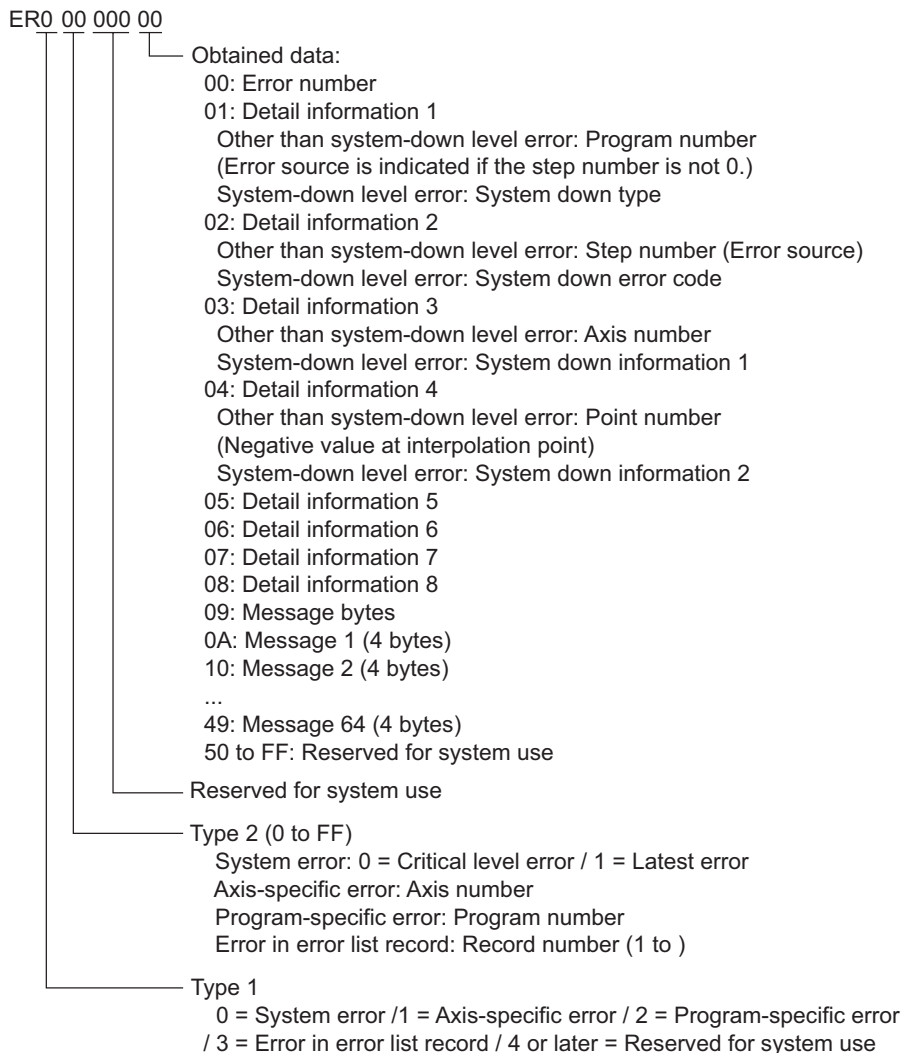

*10 The program status device descriptions are shown below.

PGST 000

Obtained data:
 000 to 003: Program number 1 status
 000: Status
 Bit 3 (Reserved for system use)
 Bit 2 (Reserved for system use)
 Bit 1 (Reserved for system use)
 Bit 0 (Start): 0 = Not started / 1 = Started
 001: Execution program step number
 002: Program-dependent error code
 003: Error occurrence step number
 004 to 007: Program number 2 status
 ...
 508 to 511: Program number 128 status

*11 The system status device descriptions are shown below.

SYST 0

Obtained data:
 0: System mode
 0 = Indeterminable / 1 = AUTO mode / 2 = MANUAL mode
 / 3 = Slave update mode / 4 = Core update mode
 1 Critical level system error number
 2: Latest system error number
 3: System status byte 1
 Bit 7 (Reserved for system use)
 Bit 6 (Battery voltage error status) : 0 = No error / 1 = Error
 Bit 5 (Battery voltage low warning status): 0 = No low / 1 = Low
 Bit 4 (Power error status): 0 = Normal / 1 = Error
 Bit 3 (Emergency stop switch status): 0 = No emergency stop / 1 = Emergency stop
 Bit 2 (Safety gate status): 0 = CLOSE / 1 = OPEN
 * X-SEL (P/Q Series) (Multi axes/Scara)/SSEL/ASEL/PSEL: Enable switch
 (Deadman switch / Enable switch) status is indicated.
 Bit 1 (TP enable switch status): 0 = ON / 1 = OFF
 * X-SEL (P/Q Series) (Multi axes/Scara)/SSEL/ASEL/PSEL: This bit is disabled (fixed to 0).
 Bit 0 (Operation mode switch status): 0 = AUTO / 1 = MANUAL
 4: System status byte 2
 Bit 7 (Reserved for system use)
 Bit 6 (Reserved for system use)
 Bit 5 (Program run status): 0 = Not run / 1 = Running
 Bit 4 (Restart wait status): 0 = Not waiting / 1 = Waiting
 Bit 3 (I/O interlock status): 0 = No interlock / 1 = Interlock
 Bit 2 (Servo interlock status): 0 = No interlock / 1 = Interlock
 Bit 1 (Slave parameter writing status): 0 = Not writing / 1 = Writing
 Bit 0 (Application data flash ROM write status): 0 = Not writing/erasing / 1 = Writing/erasing
 * When the core program is in operation (Application update mode), only Bit 0 is enabled.
 Data for System mode, Critical level system error number, Latest system error number,
 System status byte 1, System status byte 3 and System status byte 4 is disabled.
 5: System status byte 3
 Bit 7 (Reserved for system use)
 Bit 6 (Reserved for system use)
 Bit 5 (Reserved for system use)
 Bit 4 (Operation mode): 0 = Program mode / 1 = Position mode
 Bit 3 (Reserved for system use)
 Bit 2 (System ready status): 0 = Not ready / 1 = Ready
 Bit 1 (System operation status): 0 = Not operating in AUTO mode / 1 = Operating in AUTO mode
 Bit 0 (Drive-source cutoff status): 0 = Not cut off / 1 = Cut off
 6: System status byte 4
 Reserved for system use

- *12 Read disable
- *13 The program control device sends different commands depending to write data.
Other write data than the following is processed as Private Error (0x80) inside the Display.

Write Data 0: Program Execution Command(0x253)
 Write Data 1: Program Exit Command(0x254)
 Write Data 2: Program Pause Command(0x255)
 Write Data 3: Program 1 Step Execution Command(0x256)
 Write Data 4: Program Restart Command(0x257)

For the word addresses from PRG001 to PRG128, the above-shown commands are sent to the program numbers from 1 to 128, respectively.

For PRG000, commands are sent to all the running program numbers. However, "Program Execution Command" and "Program 1 Step Execution Command" cannot be used for PRG000.

- *14 In the event of SR (Software Reset), displays no response error after no communication for 20 seconds, and restarts communication.
- *15 Specifies the word address only for the value of which the last one digit is 1.
- *16 The absolute coordinate movement device descriptions are shown below.

ACM 0

Obtained data:
 0: Command trigger
 1 =Write / 4 =Clear
 1: Axis pattern

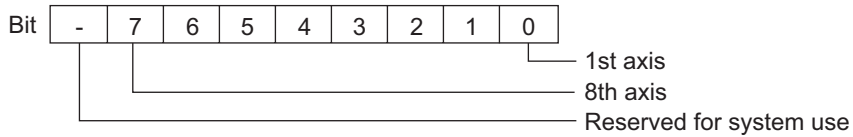

- 2: Acceleration unit (0.01G)
The parameter value becomes enabled when it is zero.
- 3: Deceleration unit (0.01G)
The parameter value becomes enabled when it is zero.
- 4: Speed unit (mm/sec)
The parameter value becomes enabled when it is zero.
(Safety limit is applied depending on the mode.)
- 5 to C: Absolute coordinate data unit (0.001mm)

*17 The relative coordinate movement device descriptions are shown below.

RCM 0

Obtained data:

0: Command trigger
1 =Write / 4 =Clear

1: Axis pattern

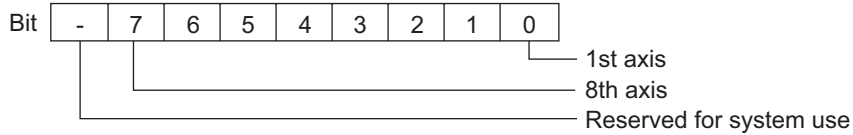

2: Acceleration unit (0.01G)

The parameter value becomes enabled when it is zero.

3: Deceleration unit (0.01G)

The parameter value becomes enabled when it is zero.

4: Speed unit (mm/sec)

The parameter value becomes enabled when it is zero.

(Safety limit is applied depending on the mode.)

5 to C: Relative coordinate data unit (0.001mm)

*18 The jogging/inching movement device descriptions are shown below.

JIM 0

Obtained data:

0: Command trigger
1 =Write / 4 =Clear

1: Axis pattern

Only single Scara axis can be specified for the Scara type
(Multiple axes can be specified).

For the Scara type, a jogging/inching command can be issued only when
none of the servo axes are operating.

X-SEL-PX/QX Series: The Scara and translation axes cannot be specified
simultaneously.

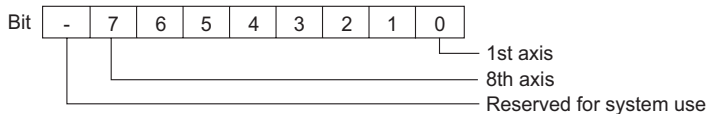

2: Acceleration unit (0.01G [for each axis, in %])

The parameter value becomes enabled when it is zero.

3: Deceleration unit (0.01G [for each axis, in %])

The parameter value becomes enabled when it is zero.

4: Speed unit (mm/sec [for each axis, in %])

The parameter value becomes enabled when it is zero.

(Safety limit is applied depending on the mode.)

5: Inching distance unit (0.001mm [for each axis, in 0.001deg])

Specify with the absolute value. Distance is not specified if it is zero (=jogging).

6: Operation type

Bit 3 (Reserved for system use) Fixed to 0

Bit 1-2 (Jogging/inching coordinate system (Scara only)): 0 = Base coordinate system

/ 1 = Selected work coordinate system / 2 = Selected tool coordinate system / 3 = Each axis system

Bit 0 (Jogging/inching direction): 0 = Negative direction on coordinate axis / 1 = Positive direction on coordinate axis

*19 The point number movement device descriptions are shown below.

PNM 0

Obtained data:

- 0: Command trigger
1 =Write / 4 =Clear
- 1: Axis pattern

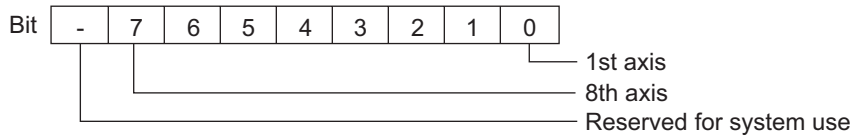

- 2: Acceleration unit (0.01G)

The applicable setting value in the position data becomes enabled when the acceleration setting is zero.

If both above setting values are zero, the parameter setting value is enabled.

- 3: Deceleration unit (0.01G)

The applicable setting value in the position data becomes enabled when the deceleration setting is zero.

If both above setting values are zero, the parameter setting value is enabled.

- 4: Speed unit (mm/sec)

The applicable setting value in the position data becomes enabled when the speed setting is zero.

If both above setting values are zero, the parameter setting is enabled.

(Safety limit is applied depending on the mode.)

- 5: Point number

*20 The point data device descriptions are shown below.

PD 00

Obtained data:

- 00: Command trigger
1 =Write / 2 =Read / 4 =Clear
- 01: Starting point number
- 02: Number of point data
- 03 to 0F: Point data 1
- 03: Point number
- 04: Axis pattern

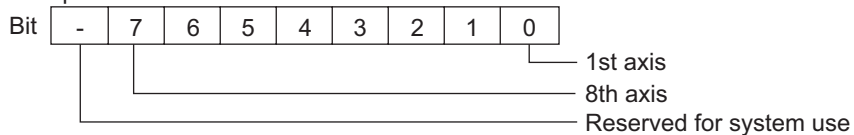

- 05: Acceleration unit (0.01G)

- 06: Deceleration unit (0.01G)

- 07: Speed unit (mm/sec)

- 08 to 0F: Position data unit (0.001 mm)

08: 1st axis position data

...

0F: 8th axis position data

- 10 to 1C: Point data 2

...

- 92 to 9E: Point data 12

*21 The servo device descriptions are shown below.

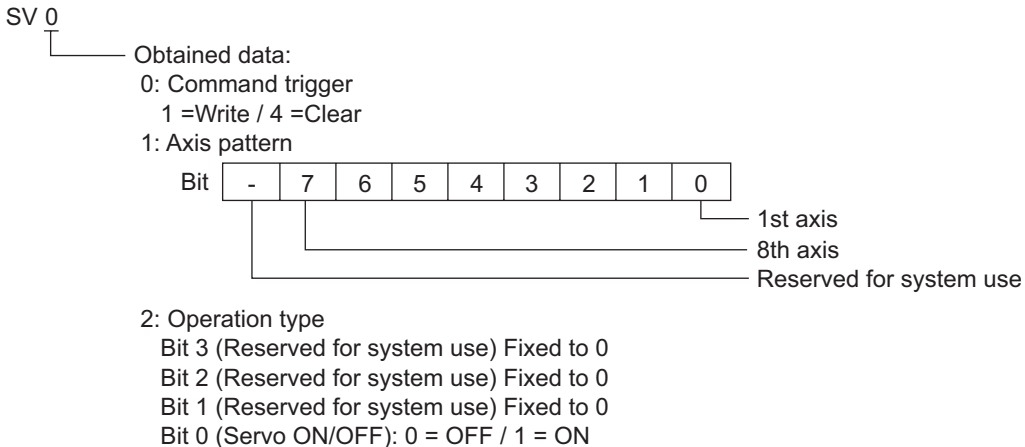

*22 The return to origin device descriptions are shown below.

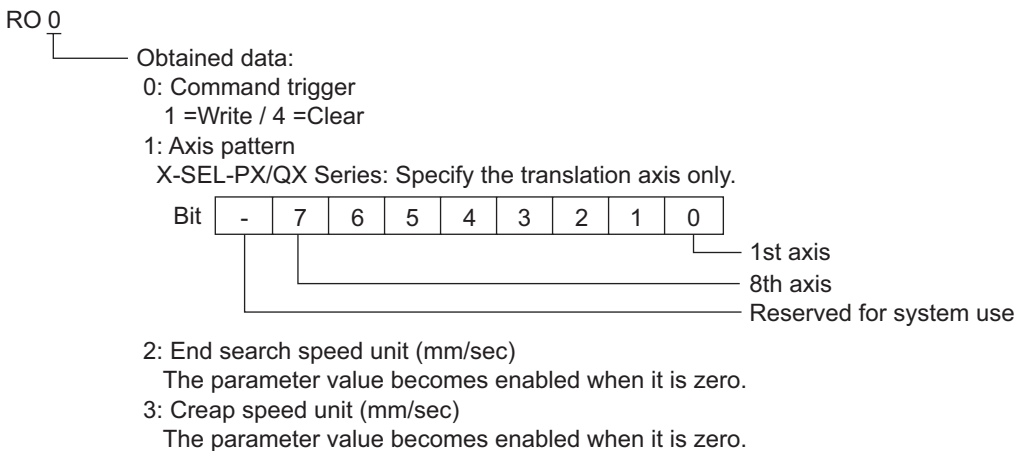

*23 The operation stop/cancel device descriptions are shown below.

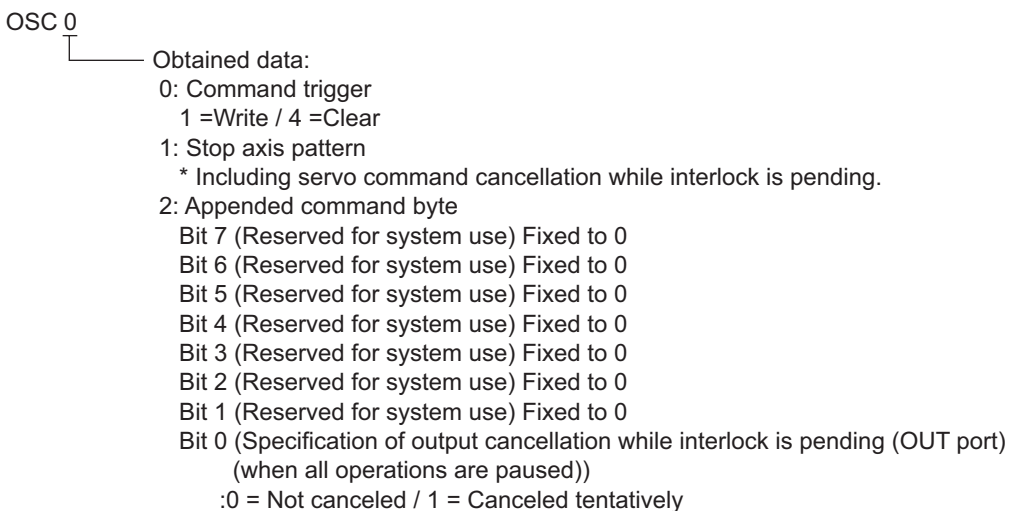

*24 The coordinate affiliate data device descriptions are shown below.

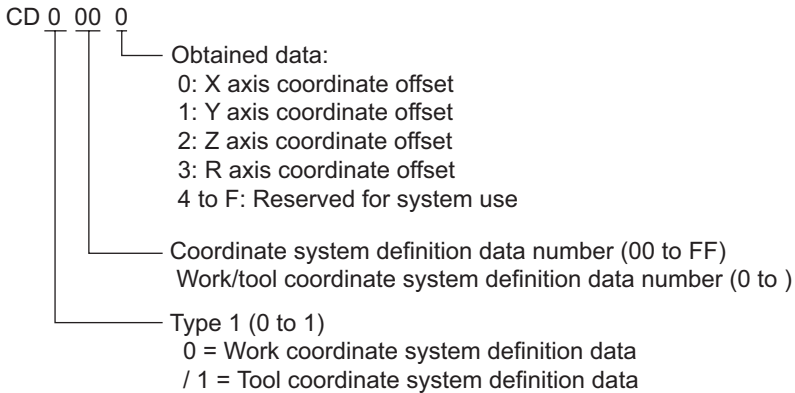

*25 The device descriptions of simple interference check zone data are shown below.

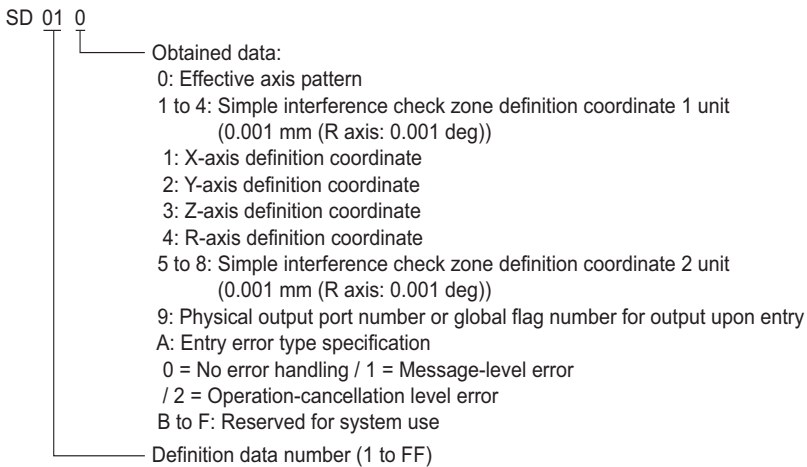

*26 The device descriptions of Scara absolute coordinate movement are shown below.

SACM 0

Obtained data:

0: Command trigger
1 =Write / 4 =Clear

1: Axis pattern

X-SEL-PX/QX Series: The Scara and translation axes cannot be specified simultaneously (the translation axis can be specified).

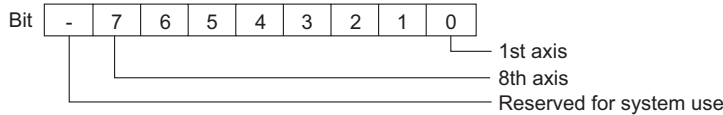

2: Acceleration unit (% or 0.01G)

The parameter value becomes enabled when it is zero.

* Unit: Movement control = PTP: [%] / Movement control = CP: [0.01G]

3: Deceleration unit (% or 0.01G)

The parameter value becomes enabled when it is zero.

* Unit: Movement control = PTP: [%] / Movement control = CP: [0.01G]

4: Speed unit (% or mm/sec)

The parameter value becomes enabled when it is zero.

(Safety limit is applied depending on the mode.)

* Unit: Movement control = PTP: [%] / Movement control = CP: [mm/sec]

5: Positioning operation type (No Scara axis disabled)

Bit 7 (Reserved for system use) Fixed to 0

Bit 6 (Reserved for system use) Fixed to 0

Bit 5 (Reserved for system use) Fixed to 0

Bit 3-4 (PTP target arm system specification type (Always move current arm system if CP))

/ 0 = Current arm system (Movement of opposite arm system prohibited if unfeasible)

/ 1 = Current arm system (Movement of opposite arm system permitted if unfeasible)

/ 2 = Right arm system (Movement of opposite arm system prohibited if unfeasible)

/ 3 = Left arm system (Movement of opposite arm system prohibited if unfeasible)

Bit 1-2 (Movement coordinate system): 0 = Reserved for system use / 1 = Selected work coordinate system

/ 2 = Reserved for system use / 3 = Reserved for system use

Bit 0 (Movement control): 0 = PTP / 1 = CP

6 to D: Absolute coordinate data unit (0.001mm)

*27 The device descriptions of Scara relative coordinate movement are shown below.

SRCM 0

Obtained data:

0: Command trigger
1 =Write / 4 =Clear

1: Axis pattern

X-SEL-PX/QX Series: The Scara and translation axes cannot be specified simultaneously (the translation axis can be specified).

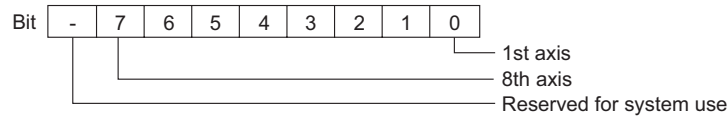

2: Acceleration unit (% or 0.01G)

The parameter value becomes enabled when it is zero.

* Unit: Movement control = PTP: [%] / Movement control = CP: [0.01G]

3: Deceleration unit (% or 0.01G)

The parameter value becomes enabled when it is zero.

* Unit: Movement control = PTP: [%] / Movement control = CP: [0.01G]

4: Speed unit (% or mm/sec)

The parameter value becomes enabled when it is zero. (Safety limit is applied depending on the mode.)

* Unit: Movement control = PTP: [%] / Movement control = CP: [mm/sec]

5: Positioning operation type (No Scara axis disabled)

Bit 7 (Reserved for system use) Fixed to 0

Bit 6 (Reserved for system use) Fixed to 0

Bit 5 (Reserved for system use) Fixed to 0

Bit 3-4 (PTP target arm system specification type (Always move current arm system if CP))

: 0 = Current arm system (Movement of opposite arm system prohibited if unfeasible)

/ 1 = Current arm system (Movement of opposite arm system permitted if unfeasible)

/ 2 = Right arm system (Movement of opposite arm system prohibited if unfeasible)

/ 3 = Left arm system (Movement of opposite arm system prohibited if unfeasible)

Bit 1-2 (Movement coordinate system): 0 = Reserved for system use / 1 = Selected work coordinate system

/ 2 = Reserved for system use / 3 = Reserved for system use

Bit 0 (Movement control): 0 = PTP / 1 = CP

6 to D: Relative coordinate data unit (0.001mm)

*28 The device descriptions of Scara point number movement are shown below.

SPNM 0

Obtained data:

0: Command trigger
1 =Write / 4 =Clear

1: Axis pattern

Used under an AND conditions with the axis pattern of the point number

X-SEL-PX/QX Series: The Scara and translation axes cannot be specified simultaneously (the translation axis can be specified).

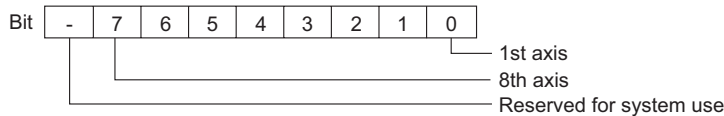

2: Acceleration unit (% or 0.01G)

The applicable setting value in the position data becomes enabled when the acceleration setting is zero.

If both above setting values are zero, the parameter setting is enabled.

* Unit: Movement control = PTP: [%] / Movement control = CP: [0.01G]

3: Deceleration unit (% or 0.01G)

The applicable setting value in the position data becomes enabled when the deceleration setting is zero.

If both above setting values are zero, the parameter setting is enabled.

* Unit: Movement control = PTP: [%] / Movement control = CP: [0.01G]

4: Speed unit (% or mm/sec)

The applicable setting value in the position data becomes enabled when the speed setting is zero.

If both above setting values are zero, the parameter setting is enabled.

(Safety limit is applied depending on the mode.)

* Unit: Movement control = PTP: [%] / Movement control = CP: [mm/sec]

5: Positioning operation type (No Scara axis disabled)

Bit 7 (Reserved for system use) Fixed to 0

Bit 6 (Reserved for system use) Fixed to 0

Bit 5 (Reserved for system use) Fixed to 0

Bit 3-4 (PTP target arm system specification type (Always move current arm system if CP))

: 0 = Current arm system (Movement of opposite arm system prohibited if unfeasible)

/ 1 = Current arm system (Movement of opposite arm system permitted if unfeasible)

/ 2 = Right arm system (Movement of opposite arm system prohibited if unfeasible)

/ 3 = Left arm system (Movement of opposite arm system prohibited if unfeasible)

Bit 1-2 (Movement coordinate system): 0 = Reserved for system use / 1 = Selected work coordinate system

/ 2= Reserved for system use / 3 = Reserved for system use

Bit 0 (Movement control): 0 = PTP / 1 = CP

6: Point number

*29 External Devices that support Feedback Current are shown below:

X-SEL-P/Q Controller (Main Application Ver.0.40 or later)

X-SEL-PX/QX Controller (Main Application Ver.0.17 or later), Axis 5 and 6 of Direct Movement Axis

SSEL Controller (Main Application Ver.0.08 or later)

ASEL Controller (Main Application Ver.0.06 or later)

PSEL Controller (Main Application Ver.0.06 or later)

*30 The device descriptions of Feedback current are shown below

FC 0
 └── Obtained data:
 0: Axis pattern
 1: System TICK (L)
 2: System TICK (H)
 3: Axis-1 Feedback current
 4: Axis-2 Feedback current
 5: Axis-3 Feedback current
 6: Axis-4 Feedback current
 7: Axis-5 Feedback current
 8: Axis-6 Feedback current
 9: Axis-7 Feedback current
 A: Axis-8 Feedback current

*31 The device descriptions of Task status are shown below

TAST 0
 └── Obtained data:
 00: Executed task count
 (01 to 05: Single-task status)
 01: Task status byte
 Bit 7 (Reserved for system use)
 Bit 6 (CANC input status)
 Bit 5 (HOLD input status)
 Bit 4 (WAIT progress)
 Bit 3 (Stopping executed)
 Bit 0-2 (Reserved for system use)
 02: Reserved for system use
 03: Executed No.
 04: Executed step No.
 05: Error generation step No.
 ...
 (76 to 80: 16-task status)
 76: Task status byte
 Bit 7 (Reserved for system use)
 Bit 6 (CANC input status)
 Bit 5 (HOLD input status)
 Bit 4 (WAIT progress)
 Bit 3 (Stopping executed)
 Bit 0-2 (Reserved for system use)
 77: Reserved for system use
 78: Executed No.
 79: Executed step No.
 80: Error generation step No.

- *32 The device descriptions of Flash ROM are shown below
 When "0" is written for an address, the External Device processes Bit0 to Bit3 as "1" (Specified). Be sure to write "0" for an address in the case of Flash ROM8Mbit version. It takes 30 seconds (Max.) in the writing of Flash ROM. Do not turn off the power of the External Device during the writing. The Display does not communicate with the External Device that is in the writing process.
 The unit code value of the VR device is "70H" in the model of the Flash ROM8Mbit version.

FR 0
 └── 0: Data type
 Bit 3 (Parameter) : 0 = Not specified / 1= Specified
 Bit 2 (Point-data, Coordinate system definition data (Scara only)): : 0 = Not specified / 1= Specified
 Bit 1 (Symbol-definition table) : 0 = Not specified / 1= Specified
 Bit 0 (SEL language program) : 0 = Not specified / 1= Specified

NOTE

- Refer to the GP-Pro EX Reference Manual for system data area.
- Cf. GP-Pro EX Reference Manual "LS Area (Direct Access Method)"
- Refer to the precautions on manual notation for icons in the table.
 - ☞ "Manual Symbols and Terminology"

7 Device Code and Address Code

Use device code and address code when you set "Device Type & Address" for the address type of the data display or other devices.

Device	Device Name	Device Code (HEX)	Address Code
Input Port	IP	0080	Value of word address divided by 16
Output Port	OP	0081	Value of (word address - 300) divided by 16
Flag	FG	0082	Global Area Value of (flag number - 600) divided by 16 Local Area Value of (flag number - 900) divided by 16
Point Data Total Count	PDT	0060	Word Address
Integer	INT	0000	Double Word Address
Real	RL	0001	Double Word Address
String	STR	0002	Global Area Value of (variable number - 300) divided by 2 Local Area Value of (variable number - 1) divided by 2
Axis Status	AXST	0061	Word Address
Scara Axis Status	SAXS	0062	Word Address
Version	VR	0063	Word Address
Error Detail 0	ER0	0020	Double Word Address
Error Detail 1	ER1	0021	Double Word Address
Error Detail 2	ER2	0022	Double Word Address
Error Detail 3	ER3	0023	Double Word Address
Error Detail 4	ER4	0024	Double Word Address
Error Detail 5	ER5	0025	Double Word Address
Error Detail 6	ER6	0026	Double Word Address
Error Detail 7	ER7	0027	Double Word Address
Program Status	PGST	0064	Word Address
System Status	SYST	0065	Word Address

Continued to next page.

Device	Device Name	Device Code (HEX)	Address Code
Program Control	PRG	0066	Word Address
Alarm Reset	AR	0067	Word Address
Software Reset	SR	0068	Word Address
Drive-Source Recovery	DSR	0069	Word Address
Operation-Pause Reset	OPR	006A	Word Address
Point Data Clear	PCLR	0083	Value of word address from which 1 is deducted
Absolute Coordinate Movement	ACM	006B	Double Word Address
Relative Coordinate Movement	RCM	006C	Double Word Address
Jogging/Inching Movement	JIM	006D	Double Word Address
Point Number Movement	PNM	006E	Word Address
Point Data	PD	006F	Double Word Address
Servo	SV	0070	Word Address
Return to Origin	RO	0071	Word Address
Operation Stop/Cancel	OSC	0072	Word Address
Coordinate Affiliate Data	CD	0073	Double Word Address
Simple Interference Check Zone Data	SD	0074	Double Word Address
Scara Absolute Coordinate Movement	SACM	0075	Double Word Address
Scara Relative Coordinate Movement	SRCM	0076	Double Word Address
Scara Point Number Movement	SPNM	0077	Word Address
Feedback Current	FC	0078	Word Address
Task Status	TAST	0003	Word Address
Flash ROM	FR	0004	Word Address

8 Error Messages

Error messages are displayed on the Display screen as follows: "No.: Device Name: Error Message (Error Occurrence Area)". Each description is shown below.

Item	Description
No.	Error No.
Device Name	Name of the External Device where an error has occurred. Device name is the title of the External Device set with GP-Pro EX. ((Initial value [PLC1])
Error Message	Displays messages related to an error that has occurred.
Error Occurrence Area	<p>Displays the IP address or device address of the External Device where an error has occurred, or error codes received from the External Device.</p> <p>NOTE</p> <ul style="list-style-type: none"> • IP address is displayed as "IP address (Decimal): MAC address (Hex)". • Device address is displayed as "Address: Device address". • Received error codes are displayed as "Decimal [Hex]".

Display Examples of Error Messages

"RHAA035: PLC1: Error has been responded for device write command (Error Code: 1[01H])"

NOTE

- Refer to your External Device manual for details on received error codes.
- Refer to "When an error is displayed (Error Code List)" in "Maintenance/Troubleshooting manual" for details on the error messages common to the driver.

■ Error Messages Specific to the External Device

Error No.	Message	Description
RHxx128	(Node Name): It was not possible to execute it by out of range data.	Data write beyond the data range was requested.

