

Device/PLC Connection Manuals



About the Device/PLC Connection Manuals

Prior to reading these manuals and setting up your device, be sure to read the "Important: Prior to reading the Device/PLC Connection manual" information. Also, be sure to download the "Preface for Trademark Rights, List of Units Supported, How to Read Manuals and Documentation Conventions" PDF file. Furthermore, be sure to keep all manual-related data in a safe, easy-to-find location.



2.6 Sharp

2.6.1 System Structure

The following describes the system structure for connecting the GP to Sharp PLCs.

Reference The Cable Diagrams mentioned in the following table are listed in the section titled "2.6.2 Cable Diagrams".

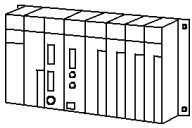
■ New Satellite JW Series (using Link I/F)

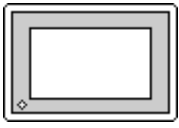
CPU	Link I/F	Cable Diagram	GP
	 Link I/F		
JW20	Link I/F on CPU unit *1	RS-232C (Cable Diagram 1)	GP Series
	JW-21CM	RS-422 4-wire type (Cable Diagram 3) RS-422 2-wire type (Cable Diagram 4)	
JW-32CUH JW-32CUH1 JW-33CUH3	Link I/F on CPU unit	RS-232C Connected to PG/COMM2 port (Cable Diagram 2)	
		RS-422 (4 wire type Connected to PG/COMM1 port or PG/COMM2 port (Cable Diagram 5)	
	JW-21CM	RS-422 4-wire type (Cable Diagram 3)	
JW50	JW-10CM	RS-422 4-wire type (Cable Diagram 3)	
	ZW-10CM	RS-422 4-wire type (Cable Diagram 3) RS-422 2-wire type (Cable Diagram 4)	
JW70, JW100	Link I/F on CPU unit *1	RS-232C (Cable Diagram 1)	
	JW-10CM	RS-422 4-wire type (Cable Diagram 3)	
	ZW-10CM	RS-422 4-wire type (Cable Diagram 3) RS-422 2-wire type (Cable Diagram 4)	

*1 Connect to the CPU Module's (JW-22CU, JW-70CU, JW-100CU) communication port.



Note: Places noted as RS-422 can also use RS-485 on the PLC side.

2.6.2 Cable Diagrams

The cable diagrams illustrated below and the cable diagrams recommended by Sharp may differ, however, using these cables for your PLC operations will not cause any problems.



Ground your PLC's FG terminal according to your country's applicable standard. For details, refer to the corresponding PLC manual.



- **Connect the FG line of the Shield cable to either the GP or PLC, depending on your environment. When using a connector hood and grounding the FG line, be sure to use an electrical conductor. The following connection diagrams show examples for connecting a shielded cable to the PLC.**
- **For the RS-232C connection, use a cable length less than 15m.**
- **If a communications cable is used, it must be connected to the SG (signal ground).**
- **For the RS-422 connection, refer to Sharp's PLC manual for the cable length.**

Cable Diagram 1 (RS-232C)

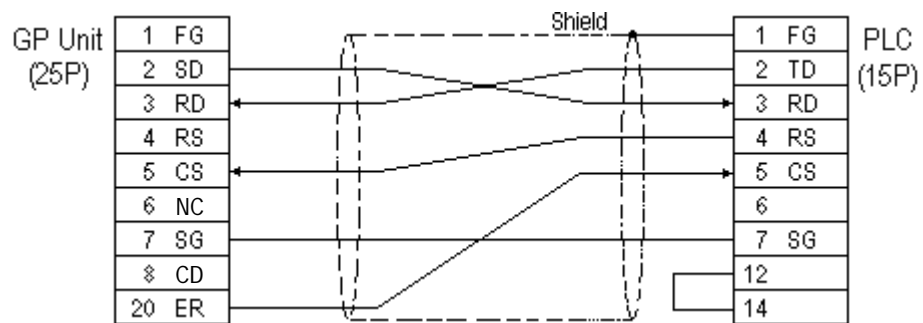

Fujikura Densen's 7P*7/0.18 57VV-SB is recommended for the connection cable.

Cable Diagram 2 (RS-232C)



Do not use pin Nos. 14 and 15 for connection with the GP since their voltage is +5V.

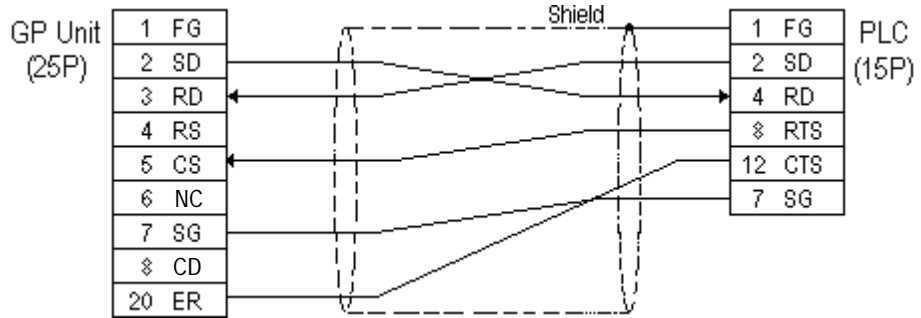

Cable Diagram 3 (RS-422)



Turn on the PLC's Termination Resistor switch.

- When using Digital's RS-422 connector terminal adapter GP070-CN10-0

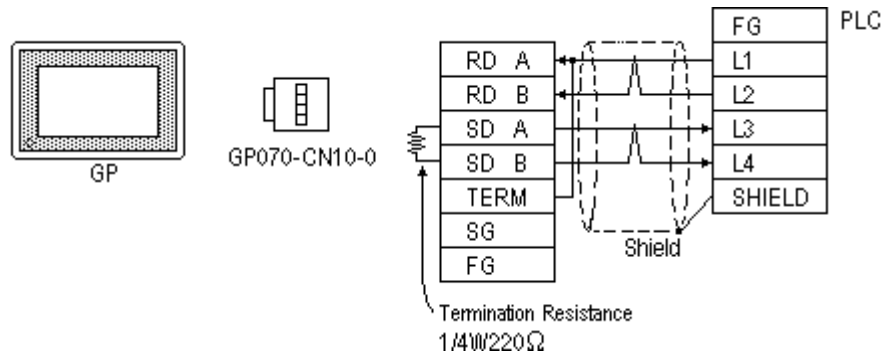

- When using Digital's RS-422 cable, GP230-IS11-0

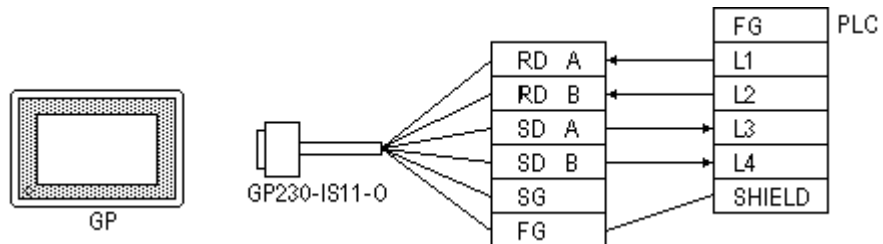

- When making your own cable connections

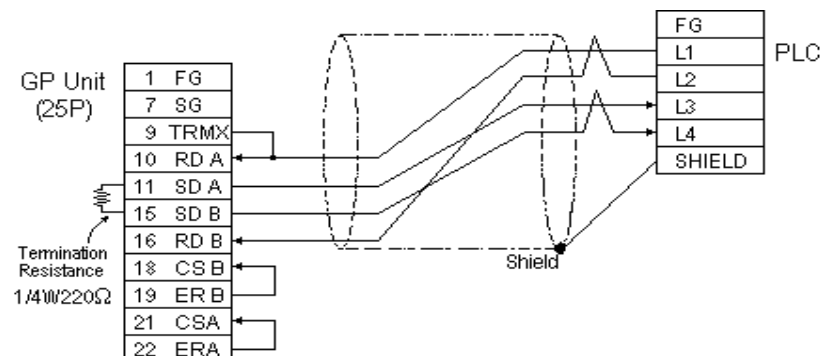



- When making your own cable connections, we recommend using Hitachi Densen's CO-SPEV-SB(A)3P*0.5 cable.
- When connecting the #9 and #10 pins in the GP Serial I/F, a termination resistance of 100Ω is added between RDA and RDB.

Cable Diagram 4 (RS-422)



Turn on the Termination Resistor switch, on the PLC.

- When using Digital's RS-422 connector terminal adapter GP070-CN10-0

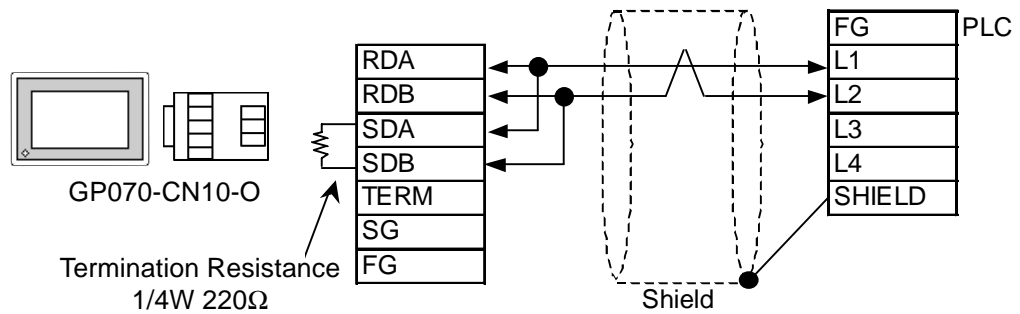

Connect terminals SD A and RD A to terminal base L1, and SD B and RD B to terminal block's L2 line.

- When using Digital's RS-422 cable, GP230-IS11-0

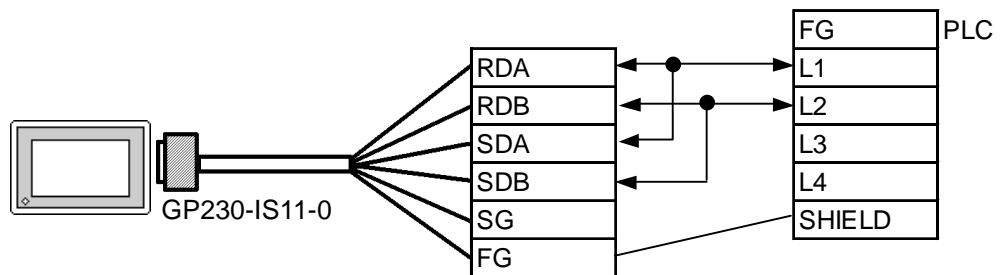

Connect terminals SD A and RD A to terminal base L1, and SD B and RD B to terminal block's L2 line.

- When making your own cable connections

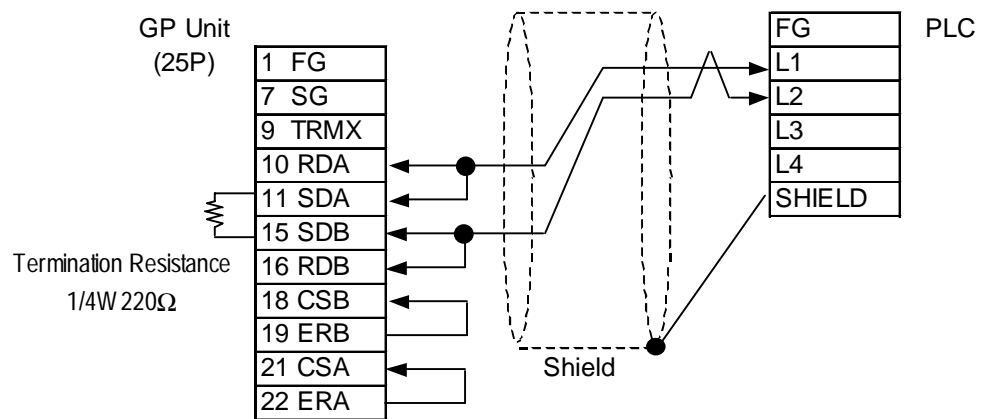

- When making your own cable connections, we recommend using Hitachi Densen's CO-SPEV-SB(A)3P*0.5 cable.
- When connecting the #9 and #10 pins in the GP Serial I/F, a termination resistance of 100Ω is added between RDA and RDB.

Cable Diagram 5 (RS-422)



- Do not connect anything to pin Nos. 2, 4, 8, and 12.
- Do not use pin Nos. 14 and 15 for connection with the GP since their voltage is +5V.

- When using Digital's RS-422 connector terminal adapter GP070-CN10-0

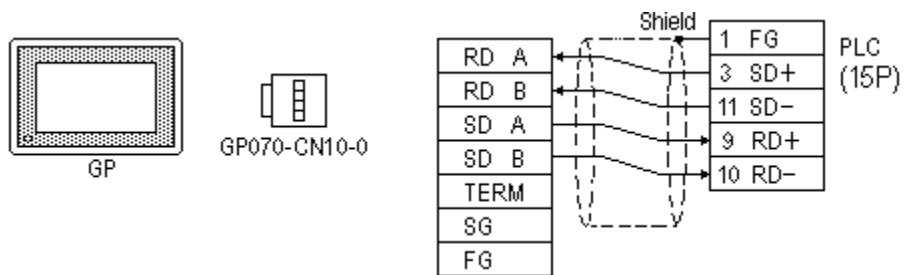

- When using Digital's RS-422 cable, GP230-IS11-0

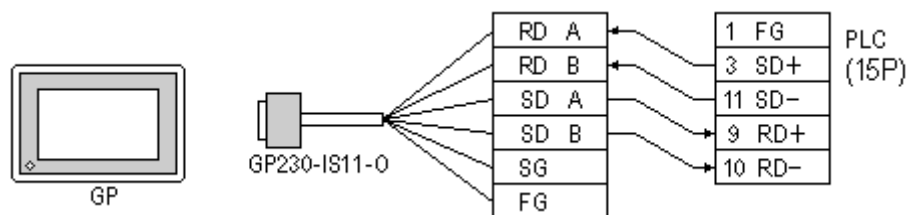

- When making your own cable connections

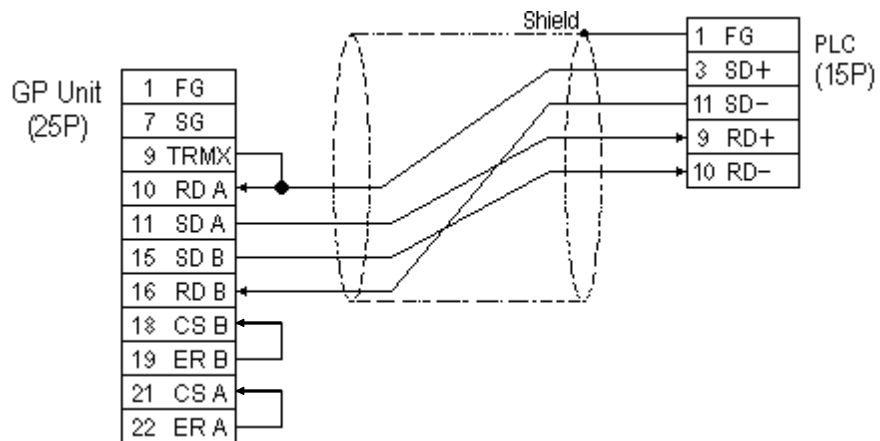









Note: Our recommendation for making your own cable is Hitachi's CO-SPEV-SB(A) 3P0.5mm².

2.6.3 Supported Devices

The following describes the range of devices supported by the GP.

■ New Satellite JW Series

 Setup System Area here.

Device	Bit Address	Word Address	Particulars	
Relay	00000 - 15777	A0000 - A1576 (□0000 - □1576)		L/H
Timer (contact)	T0000 - T0776	---		
Counter (contact)	C0000 - C0776	---		
Timer/Counter (current value)	---	T0000 - T0777		
		B0000 - B3776 (b0000 - b3776)	 	
Register	---	09000 - 09776	 	
		19000 - 19776		
		29000 - 29776		
		39000 - 39776		
		49000 - 49776		
		59000 - 59776		
		69000 - 69776		
		79000 - 79776		
		89000 - 89776		
		99000 - 99776		
File Register	---	1000000 - 717776	  ¹	

* 1 The file register consists of a file number and an address.

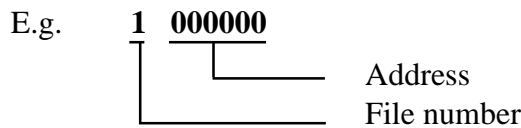

The PLC manual uses the values displayed in brackets for the Relay and Timer/Counter (current value) (B) word addresses; as a result, when entering, be sure to use **AXXXX** or **BXXXX**.



Note: That the range of addresses that can be used will vary depending on the type of PLC.

■ New Satellite JW-32CUH Series

 Setup System Area here.

Device	Bit Address	Word Address	Particulars		
Relay	00000 ~ 15777	A0000 ~ A1576 (□0000 ~ □1576)	÷2		
	20000 ~ 75777	A2000 ~ A7576 (□2000 ~ □7576)			
Timer (contact)	T0000 ~ T1777	---			
Counter (contact)	C0000 ~ C1777	---			
Timer/Counter (current value)	---	B0000 ~ B3776 (b0000 ~ b3776)	÷2		
Register	---	09000 ~ 09776	÷2 [Bit] 5		
	---	19000 ~ 19776			
	---	29000 ~ 29776			
	---	39000 ~ 39776			
	---	49000 ~ 49776			
	---	59000 ~ 59776			
	---	69000 ~ 69776			
	---	79000 ~ 79776			
	---	89000 ~ 89776			
	---	99000 ~ 99776			
	---	E0000 ~ E0776			
	---	E1000 ~ E1776			
	---	E2000 ~ E2776			
	---	E3000 ~ E3776			
	---	E4000 ~ E4776			
	---	E5000 ~ E5776			
	---	E6000 ~ E6776			
	---	E7000 ~ E7776			
	File Register 1	---		1000000 ~ 1037776	÷2 [Bit] 5 ^{*1}
	File Register 2	---		2000000 ~ 2177776	

L/H

* 1 The file register consists of a file number and an address.

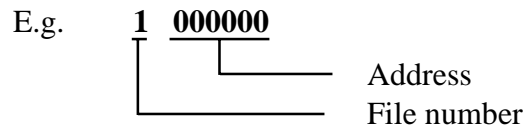

The PLC manual uses the values displayed in brackets for the Relay and Timer/Counter (current value) (B) word addresses; as a result, when entering, be sure to use **AXXXX** or **BXXXX**.



The range of addresses that can be used will vary depending on the type of PLC.

■ New Satellite JW Series (JW-33CUH3)

 Setup System Area here.

Device	Bit Address	Word Address	Particulars
Relay	00000 ~ 15777	A0000 ~ A1576 (□0000 ~ □1576)	÷2
	20000 ~ 75777	A2000 ~ A7576 (□2000 ~ □7576)	
Timer (contact)	T0000 ~ T1777	—	
Counter(contact)	C0000 ~ C1777	—	
Timer/Counter (current value)	—	B0000 ~ B3776 (b0000 ~ b3776)	÷2
Register	—	09000 ~ 09776	÷2 Bit 5
	—	19000 ~ 19776	
	—	29000 ~ 29776	
	—	39000 ~ 39776	
	—	49000 ~ 49776	
	—	59000 ~ 59776	
	—	69000 ~ 69776	
	—	79000 ~ 79776	
	—	89000 ~ 89776	
	—	99000 ~ 99776	
	—	E0000 ~ E0776	
	—	E1000 ~ E1776	
	—	E2000 ~ E2776	
	—	E3000 ~ E3776	
	—	E4000 ~ E4776	
	—	E5000 ~ E5776	
	—	E6000 ~ E6776	
—	E7000 ~ E7776		
File Register 1	—	1000000 ~ 1037776	÷2 Bit 5
File Register 2	—	2000000 ~ 2177776	
File Register 3	—	3000000 ~ 3037776	
File Register 10-1F	—	F1000000 ~ F1F17776	
File Register 20-2C	—	F2000000 ~ F2C17776	

L/H

* 1

* 1 The file register consists of a file number and an address.

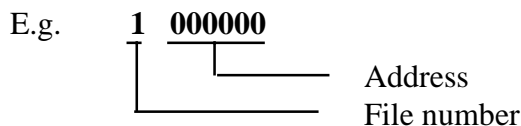

The PLC manual uses the values displayed in brackets for the Relay and Timer/Counter (current value) (B) word addresses; as a result, when entering, be sure to use AXXXX or BXXXX.



The range of addresses that can be used will vary depending on the type of PLC.

2.6.4 Environment Setup

The following lists Digital's recommended PLC and GP communication settings.

■ New Satellite JW Series (Using Link I/F on CPU unit)

GP Setup		Communication Port Setup	
Baud Rate ^{*1}	9600 bps	Baud Rate	9600 bps
Data Length	7 bits	Data Bit	7 bits
Stop Bit	2 bits	Stop Bit	2 bits
Parity Bit	Even	Parity Bit	Even
Data Flow Control	ER Control	---	
Communication Format	RS-232C	---	
Communication Format (4-wire)	4 wire type	---	
Communication Format (2-wire)	2 wire type	---	
Unit No.	1	Station Number	1

■ New Satellite JW Series (Using Link I/F)

GP Setup		Link Unit Setup	
Baud Rate ^{*1}	19200 bps	Baud Rate	19200 bps
Data Length	7 bits (fixed)	Data Bit	7 bits (fixed)
Stop Bit	2 bits (fixed)	Stop Bit	2 bits (fixed)
Parity Bit	Even	Parity Bit	Even
Data Flow Control	ER Control	---	
Communication Format (4-wire)	4 wire type	Comm Mode (SIO Line#) (4-wire type)	4 wire type
Communication Format (2-wire)	2 wire type	Comm Mode (SIO Line#) (4-wire type)	2 wire type
---		Function Setup Switch (S0)	Computer Link
Unit No.	1	Station Number	1

*1 115200bps can be used when the JW-32CUH1 or the JW-33CUH3 is used.