

# Essential Safety Precautions

## WARNING

### ■ System Design

- Do not create PL-7930 series (hereafter referred to as the “PL”) touch panel switches that could possibly endanger the safety of personnel or equipment. A malfunction of the PL unit, its I/O unit(s), cable(s), or other related equipment can cause unexpected output signals, leading to a serious accident. Be sure to design all important machine operation switches so they are operated via a separate control system, and not via the PL.
- Do not create PL touch panel switches to control machine safety operations, such as an emergency stop switch. Install these switches as separate hardware switches, otherwise severe bodily injury or equipment damage can occur.
- Be sure to design your system so that a communication fault between the PL and its host controller will not cause equipment to malfunction. This is to prevent any possibility of bodily injury or equipment damage.
- Do not use the PL as a warning device for critical alarms that can cause serious operator injury, machine damage or can halt system operation. Critical alarm indicators and their control/activator units must be designed using stand-alone hardware and/or mechanical interlocks.
- Do not use the PL with aircraft control devices, aerospace equipment, central trunk data transmission (communication) devices, nuclear power control devices, or medical life support equipment, due to these devices’ inherent requirements of extremely high levels of safety and reliability.
- Be sure to use redundant and/or failsafe system designs to ensure adequate levels of system reliability and safety when using the PL with transportation vehicles (trains, cars and ships), disaster and crime prevention devices, various types of safety equipment, non-life support related medical devices, and other similar equipment.
- After the PL unit’s backlight burns out the touch panel is still active, unlike the PL unit’s “Standby Mode”. If the operator fails to notice that the backlight is burned out and touches the panel, a potentially dangerous machine operation error can occur. Therefore, do not create PL unit touch panel switches that may cause injury and/or equipment damage. If your PL unit’s backlight suddenly turns OFF, use the following steps to determine if the backlight is actually burned out.
  - 1) If the PL unit’s “Backlight Control” is not set and the screen has gone blank, your backlight is burned out.
  - 2) If the PL unit’s “Backlight Control” is set to Standby Mode and the screen has gone blank, and touching the screen or performing another input operation does not cause the display to reappear, your backlight is burned out.

### ■ Handling

- Do not modify the PL unit. Doing so may cause a fire or an electric shock.
- Do not operate the PL in an environment where flammable gases are present, since it may cause an explosion.

### ■ Wiring

- To prevent an electric shock be sure to disconnect your PL unit’s power cord from the power supply before wiring the PL.
- Do not use voltage beyond the PL unit’s specified range. Doing so may cause a fire or an electric shock.

## ■ Maintenance

- Do not connect or disconnect Host and PL unit communication cables while the PL is turned ON.
- The PL uses a lithium battery for backing up its internal clock data and the battery may explode if it is replaced incorrectly. When replacement is required, use a Pro-face-designated product.

---

## CAUTION

---

## ■ Installation

- Be sure all cable connectors are securely attached to the PL unit. A loose connection may cause incorrect input or output signals.

## ■ Wiring

- Be sure to ground the PL unit's FG wire separately from other equipment FG lines. Also, be sure to use a grounding resistance of  $100\Omega$  or less and a  $2\text{mm}^2$  [0.0062inch<sup>2</sup>] or thicker wire, or your country's applicable standard. Otherwise, electric shock or malfunctions may result.
- Be sure to use only the designated torque to tighten the PL unit's terminal block screws. If these screws are not tightened firmly, it may cause a short-circuit, fire or incorrect unit operation.
- Be sure that metal particles and wiring debris do not fall inside the PL unit. They can cause a fire, malfunction or incorrect unit operation.

## ■ Maintenance

- Do not reset or turn the PL OFF, or insert or remove the CF Card while the PL unit's CF Card or hard disk is being accessed. Otherwise, CF Card and the hard disk internal data may be damaged or lost.

## ■ Unit Disposal

- When the product is disposed of, it should be done so according to your country's regulations for similar types of industrial waste.

## ■ General Safety Precautions

- Do not press on the PL unit's display with excessive force or with a hard object, since it can damage the display. Also, do not press on the touch panel with a pointed object, such as the tip of a mechanical pencil or a screwdriver, since doing so can damage the touch panel.
- Do not install the PL where the ambient temperature exceeds the specified range. Doing so may cause a unit malfunction.
- To prevent abnormally high temperatures from occurring inside the PL, do not restrict or block the PL unit's rear-face ventilation slots.
- Do not allow water, liquids or metal fragments to enter inside the PL unit's case, since they can cause either a malfunction or an electric shock. (For use in pollution degree 2 environment.)
- Do not operate or store the PL in locations where it can be exposed to direct sunlight, high temperatures, excessive dust, moisture or vibration.
- Do not operate the PL in areas where large, sudden temperature changes can occur. These changes can cause condensation to form inside the PL, possibly causing it to malfunction.
- Do not operate or store the PL where chemicals evaporate, or where chemicals are present in the air.

Corrosive chemicals: Acids, alkalines, liquids containing salt

Flammable chemicals: Organic Solvents

- Do not use paint thinner or organic solvents to remove dirt or oil from the PL unit's surface. Instead, use a soft cloth moistened with a diluted neutral detergent.
- Do not use or store the PL in areas with direct sunlight, since the sun's ultraviolet rays may cause the LCD's quality to deteriorate.

- Do not store the PL in an area where the temperature is lower than that recommended in the PL unit's specifications. Doing so may cause the LCD display's liquid to congeal, which can damage the LCD. Also, if the storage area's temperature becomes higher than the specified level, the LCD's liquid may become isotropic, causing irreversible damage to the LCD. Therefore, only store the PL in areas where temperatures are within the PL unit's specifications.
- After turning OFF the PL, be sure to wait a few seconds before turning it ON again. The PL may not operate correctly if it is restarted too quickly.
- Due to the possibility of unexpected accidents, be sure to back up the PL unit's data regularly.

#### ■ LCD Panel Usage Precautions

- The LCD panel's liquid contains an irritant. If the panel is damaged and any of this liquid contacts your skin, immediately rinse the area with running water for at least 15 minutes. If the liquid gets in your eyes, immediately rinse your eyes with running water for at least 15 minutes and consult a doctor.
- The PL unit's LCD screen may show unevenness in the brightness of certain images or at some contrast settings. This is an LCD characteristic and not a product defect.
- The PL unit's LCD screen pixels may contain minute black and white-colored spots. This is an LCD characteristic and not a product defect.
- The color displayed on the PL unit's LCD screen may appear different when seen from outside the specified viewing angle. This is an LCD characteristic and not a product defect.
- When the same image is displayed on the PL unit's screen for a long period, an afterimage may appear when the image is changed. If this happens, turn off the PL, wait 10 seconds and then restart the unit. This is an LCD characteristic and not a product defect.
- To prevent an afterimage:
  - \* Set the PL unit's display OFF feature when you plan to display the same screen image for a long period of time.
  - \* Change the screen image periodically and try to not display the same image for a long period of time.

## UL Approval

PL7930-T41, PL7930-T42, PL7931-T41, PL7931-T42 are UL/c-UL listed products (UL File No.E220851).

Product Model No.	UL Registration Model No.
PL7930-T41	3480901-05
PL7930-T42	3480901-06
PL7931-T41	3480901-07
PL7931-T42	3480901-08

This product conforms to the following standards:

- UL508 Standard for Industrial Control Equipment
- CSA-C22.2 No.142-M1987 (c-UL Approval) Standard for Process Control Equipment

### <Cautions>

Be aware of the following items when building the PL into an end-use product:

- The PL unit's rear face is not approved as an enclosure. When building the PL unit into an end-use product, be sure to use an enclosure that satisfies standards as the end-use product's overall enclosure.
- For use on flat surface of a type 1 enclosure.
- The PL unit must be used indoors only.
- Install and operate the PL with its front panel facing outwards.
- If the PL is mounted so as to cool itself naturally, be sure to install it in a vertical panel. Also, insure that the PL is mounted at least 50 mm away from any other adjacent structures or machine parts. If these conditions are not met, the heat generated by the PL unit's internal components may cause it to fail to meet UL standards.

## CE Marking

PL7930-T41, PL7930-T42, PL7931-T41, PL7931-T42 are CE marked product that conforms to EMC directives and Low voltage directive EN55011 Class A, EN61000-6-2 and EN60950.

# Package Contents

The following items are included in the PL unit's package. Before using the PL, please check that all items listed here are present.

PL Unit (1)

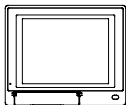

Installation Fasteners (4/set x 3)

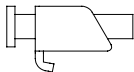

Power Plug (1)



USB Clamp (1 set)  
(USB Clamp (1), Bracket (1), Screw(1))

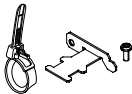

## NOTE

- When you order a PL unit built to your specifications, that PL package should include each optional item's Installation Guide. Please use that guide to check the contents of each optional item's package.

## IMPORTANT

- The power cord is designed only for AC100V use. Under other voltage situation, you should use a different cord in conformity with the voltage.
- The power cord is exclusively for this product and it cannot be used for other electric devices.

This unit has been carefully packed, with special attention to quality. However, should you find anything damaged or missing, please contact your local PL distributor immediately.

Installation Guide <This Guide> (1)



Installation Gasket (1)  
(Attached to the PL unit)



Power Cord(1)



## About the Manual

For the detailed information on PL series, refer to the following manuals.

- PL-6930/PL-7930 Series User Manual
- API Reference Manual

Manual can be downloaded from Pro-face Home Page.

URL

<http://www.pro-face.com/otasuke/>

**NOTE**

- The drivers and utilities for PL can be downloaded from Pro-face Home Page.

# Part Names

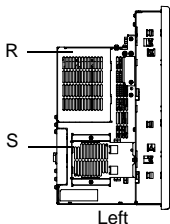
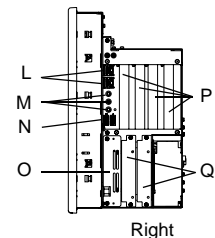
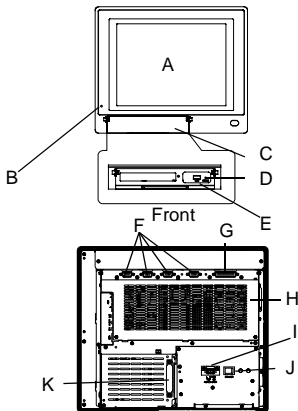

- A: Display/Touch Panel  
 B: Power LED/RAS Status Lamp

LED	PL Status
Green (lit)	Normal operation (power is ON).
Green (blinking)	Soft OFF state.
Orange (lit)	System Monitor Error/ Touch Panel SELF TEST Error
Orange/Red (blinking)	Backlight burnout is detected.
Orange/Green (blinking)	Soft Mirror Disk Alarm
Not lit	Power is OFF.

- C: Front Maintenance Cover  
 D: Hardware Reset Switch (RESET)  
 E: Front USB Interface  
 F: Serial Interface  
 (COM1,COM2,COM3,COM4)  
 G: RAS Interface (RAS)  
 H: Rear Maintenance Cover  
 I: Power Supply Connector  
 J: Power Switch  
 K: IDE Interface  
 L: Ethernet Interface (LAN)  
 M: Sound I/O Interface  
 Used to SPEAKER output, LINE input, and  
 Microphone input from the PL's top.  
 N: USB Interface (USB)  
 O: PCMCIA/CARD BUS Slot  
 P: PCI/ISA Expansion Slots  
 Q: HDD/CF Card Unit Expansion Slots  
 R: Half Cover  
 S: Fan Cover  
 (PL-7931's Fan Cover is in the bottom of  
 unit.)

# Specifications

## ■ Electrical

		PL-7930	PL-7931
Power Supply	Input Voltage	AC100 / 240V	
	Rated Voltage	AC85V to 265V	
	Rated Frequency	50Hz to 60Hz	
	Allowable Voltage Drop	20ms or less	
	Current Consumption	150VA or less	130VA or less
Voltage Endurance		AC1500V 20mA for 1 minute (between charging and FG terminals)	
Insulation Resistance		DC500V 10M $\Omega$ or more (between charging and FG terminals)	

## ■ Environmental

			PL-7930	PL-7931
Physical	Surrounding Air Temperature	Cabinet Interior	The Model Without Fan type(T41):5°C to 40°C (When NOT using HDD:0°C to 40°C) The Model Attached Fan type(T42):5°C to 50°C (When NOT using HDD:0°C to 50°C)	
		Panel Face	0°C to 40°C	
	Storage Temperature		-10°C to +60°C	
	Ambient Humidity		10%RH to 85%RH (Wet bulb temperature: 29°C or less - no condensation.)	
	Storage Humidity		10%RH to 85%RH (Wet bulb temperature: 29°C or less - no condensation.)	
	Dust		Not severely dusty conditions	
	Pollution Degree		Pollution Degree 2	
	Atmosphere		Free of corrosive gases	
Mechanical	Vibration Resistance		4.9m/s <sup>2</sup> 10Hz to 25Hz X, Y, Z directions for 30 minutes	
Electrical	Noise Immunity		Noise Voltage: 1,500Vp-p Pulse Duration: 50ns, 500ns, 1 $\mu$ s Rise Time: 1ns (via noise simulator)	
	Electrostatic Discharge Immunity		4kV (complies with IEC 61000-4-2 Level 3)	
Noise Immunity (First transient burst noise)			Power Line:2kV IEC61000-4-4 COM Port:1kV IEC61000-4-4	



**IMPORTANT**

- When using any of the PL is optional devices, be sure to check that device's specifications for any special conditions or cautions that may apply to its use.
- Be aware that not only does the Hard Disk have a fixed lifetime, but that accidents can always occur. Therefore, be sure to back up your Hard Disk's data regularly, or prepare another Hard Disk unit that can be used for backup.
- The Hard Disk lifetime given here may be reduced due to unforeseen environmental factors, however, generally speaking, the disk should last for 20,000 hours (of operation) or approximately 5 years, whichever comes first at an operating temperature of 20°C and 333 hours of operation per month. (HDD access frequency of 20% or less)
- Using the Hard Disk in an environment that is excessively hot and/or humid will shorten the disk's usage lifetime. A wet bulb temperature of 29°C or less is recommended. This is equivalent to the following data.

Temperature	Humidity
35°C	no higher than 64%RH
40°C	no higher than 44%RH

- In order to extend the lifetime of the hard disk, Pro-face recommends you set the Windows®2000 [Control panel]-[Power Management option]-[Turn off hard disks] selection / the Windows®XP [Control panel]-[Power and Maintenance]-[Power Options]-[Power Schemes]-[Turn off hard disks] selection to turn the hard disk off when the unit is not being operated. A setting of 5 minutes is recommended.

**■ Structural**

		PL-7930	PL-7931
Installation	Grounding	Grounding resistance of 100 Ω, 2mm <sup>2</sup> [0.0062inch <sup>2</sup> ] or thicker wire, or your country's applicable standard. (Same for FG and SG terminals)	
	Structure	Rating <sup>*1</sup> : Equivalent to IP65f (Only when NOT using Front USB) Figuration : Built-in type Installation method : Embedding	
	Cooling Method	The Model Without Fan type :Natural air circulation The Model Attached Fan type :Forced air cooling via electric fan	
	Weight (unit only)	10.5kg or less [23.13 lb.]	9.5kg or less [20.93 lb.]
	External Dimensions(excluding projections)	W374mm [14.72 in.] x H325mm [12.80 in.] x D180mm [7.09 in.]	W374mm [14.72 in.] x H325mm [12.80 in.] x D134mm [5.28 in.]

\*1 The front face of the PL unit, installed in a solid panel, has been tested using conditions equivalent to the standards shown in the specification. Even though the PL unit's level of resistance is equivalent to these standards, oils that should have no effect on the PL can possibly harm the unit. This can occur in areas where either vaporized oils are present, or where low viscosity cutting oils are allowed to adhere to the unit for long periods of time. If the PL's front face protection sheet becomes peeled off, these conditions can lead to the ingress of oil into the PL and separate protection measures are suggested. Also, if non-approved oils are present, it may cause deformation or corrosion of the front panel's plastic cover. Therefore, prior to installing the PL be sure to confirm the type of conditions that will be present in the PL's operating environment. If the installation gasket is used for a long period of time, or if the unit and its gasket are removed from the panel, the original level of the protection cannot be guaranteed. To maintain the original protection level, be sure to replace the installation gasket regularly.

# Interfaces

## ■ Serial Interfaces (COM1,COM2,COM3,COM4)

This interface is used to connect an RS-232C cable. A D-sub 9-pin plug connector is used.

### IMPORTANT

- The PL unit's serial port is not isolated. When the host (PLC) unit is also not isolated, be sure to connect the #5 SG (Signal Ground) terminal to reduce the risk of damaging the RS-232C circuit.
- Inside the PL unit, the SG (Signal Ground) and FG (Frame Ground) terminals are connected.
- When connecting an external device to the PL using the SG terminal, be sure to check that no short-circuit loop is created when you setup the system.

Stacking Metal Fittings	#4-40 inch (UNC)
-------------------------	------------------

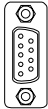
Pin Arrangement	Pin No.	Signal Name	Direction	Meaning
	1	CD	Input	Carrier Detect
	2	RD(RXD)	Input	Receive Data
	3	SD(TXD)	Output	Send Data
	4	ER(DTR)	Output	Data Terminal Ready
	5	SG	-	Signal Ground
	6	DR(DSR)	Input	Data Set Ready
	7	RS(RTS)	Output	Request to Send
	8	CS(CTS)	Input	Send Possible
	9	CI(RI)/ VCC	In/ Output	Called status display / +5V±5% Output <sup>*1</sup>
	Shell	FG	-	Frame Ground (Common with SG)

\*1 Number 9 pin's [RI/+5V]changeover is good only for COM2 and COM3. The factory default setting is [RI]. For COM1 and COM4, [RI] can be available.

### IMPORTANT

- Whenever changing RI/+5V changeover switch, be sure to first turn the PL's power supply OFF, then remove the Rear Maintenance Cover. The switch is on the board.

### SEE →

For how to remove the Rear Maintenance Cover, refer to "PL-6930/PL-7930 Series User Manual".

## ■ RAS Interface

A D-sub 25-pin plug connector is used.

Stacking Metal Fittings	#4-40 inch (UNC)
-------------------------	------------------

Pin Arrangement	Pin No.	Signal Name	Meaning
	1	GND	Ground
	2	+5V	Output Current : Lower than or equal to 100mA (with a total of 2 pin and 15 pin) Output Voltage : $5V \pm 5\%$
	3	+12V	Output Current : Lower than or equal to 100mA Output Voltage : $12V \pm 5\%$
	4	NC	-
	5	RST (+)	Reset Input(+)
	6	DIN0 (+)	Data Input 0(+)
	7	DOUT 2 (-) (UPS Shutdown(-))	Data Output 2(-) (UPS Shutdown(-))
	8	DOUT 2 (+) (UPS Shutdown(+))	Data Output 2(+) (UPS Shutdown(+))
	9	DOUT 0 (-)	Data Output 0(-)
	10	DOUT 0 (+)	Data Output 0(+)
	11	RST (-)	Reset Input(-)
	12	DIN0 (-)	Data Input 0(-)
	13	DIN1 (+)	Data Input 1(+)
	14	GND	Ground
	15	+5V	Output Current : Lower than or equal to 100mA (with a total of 2 pin and 15 pin) Output Voltage : $5V \pm 5\%$
	16	DIN2 (+)	Data Input 2 (+)
	17	DIN2 (-)	Data Input 2 (-)
	18	DIN3 (+)	Data Input 3 (+)
	19	DOUT 1 (-)	Data Output 1(-)
	20	DOUT 1 (+)	Data Output 1(+)
	21	DOUT 3 (-)	Data Output 3(-)
	22	DOUT 3 (+)	Data Output 3(+)
	23	DIN3 (-)	Data Input 3(-)
	24	DIN1 (-)	Data Input 1(-)
	25	NC	-

**SEE →**

For the circuit diagram, refer to the “PL-6930/PL-7930 Series User Manual“.

## ■ Ethernet Interface

The Ethernet transmission interface conforms to IEEE802.3 (10BASE-T/100BASE-TX). An RJ-45 type modular jack connector (8-pole) is used.

## ■ HDD/CF Card Expansion Unit Interface

Used to connect an optional HDD unit, or CF Card unit.

## ■ USB Interface

Connect a USB connectable device here. (TYPE-A conn.) Conforms to USB2.0.

Power supply voltage	5V DC $\pm 5\%$
Output current	500mA(max.)
The maximum communication distance	5m

## ■ Expansion Board Interface

Used to connect a PCI/ISA board.

## ■ PCMCIA/CARD BUS Interface

For inserting a PC Card/Card Bus (VIDEO, ZOOM, and SOUND functions are excluded from CARD BUS).

## ■ Sound I/O Interface

Used to Speaker output, Line input and Microphone input. This interface uses a mini-pin jack-type connector.

# Dimensions

## ■ PL-7930 Dimensions

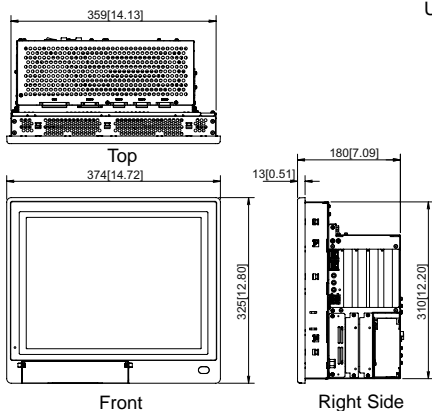

## ■ PL-7931 Dimensions

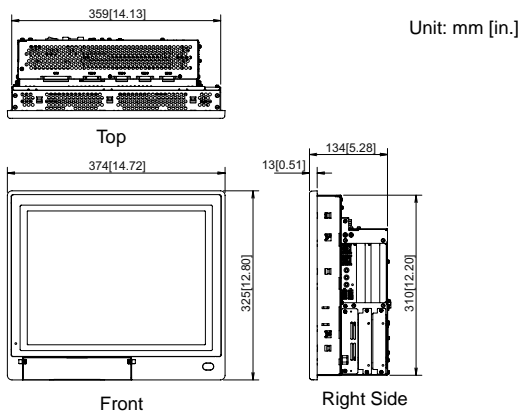

# Installing

## 1 Installation Requirements

- For easier maintenance, operation, and improved ventilation, be sure to install the PL at least 50 mm [1.97 in.] away from adjacent structures and other equipment.

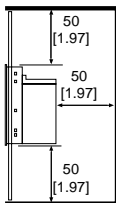
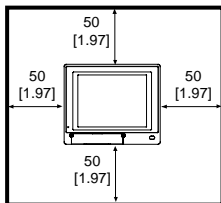

Unit: mm

- Be sure that the surrounding air temperature and the ambient humidity are within their designated ranges. (Surrounding Air Temperature: 0°C to 50°C (0°C to 40°C for the model without Fan, T41 model), Ambient humidity: 10 %RH to 85%RH, Wet bulb temperature: 29°C or less.) When installing the PL on the panel of a cabinet or enclosure, “Ambient operation temperature” indicates both the panel face and cabinet or enclosure’s internal temperature.

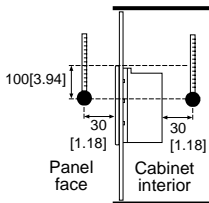

Unit: mm [in.]

- Be sure that heat from surrounding equipment does not cause the PL to exceed its standard operating temperature.
- When installing the PL in a slanted panel, the panel face should not incline more than 30°.

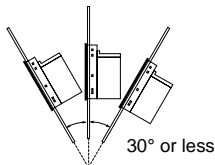

- The PL Series unit does not support longitudinal mounting.

## 2 Installing the PL unit in a Panel

The PL unit is designed to be installed in a Panel. Refer to the following procedure to mount the PL unit.

- (1) Create a Panel Cut on the Panel surface as shown in the panel cut dimensions illustration.

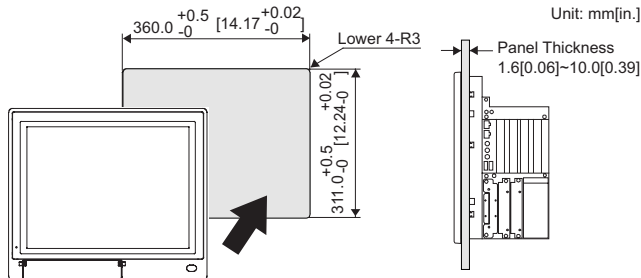

- (2) Confirm that the installation gasket is attached to the PL unit and then place the PL unit into the Panel from the front.

### IMPORTANT

- It is strongly recommended that you use the installation gasket, since it absorbs vibration in addition to repelling water.

### SEE →

For the procedure for replacing the installation gasket, refer to “PL-6930/PL-7930 Series User Manual”.

- (3) Insert the hook of the installation fastener into twelve(12) insertion slots of the PL unit and tighten the back of the installation fastener using a screwdriver. For the position of the insertion slot, refer to the dimension illustration.

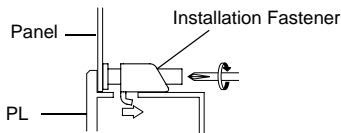

### IMPORTANT

- Tightening the screws with too much force can damage the PL unit's plastic case.
- The torque required to tighten these screws is 0.5 N•m.

# Wiring

## ⚠ WARNING

### ■ Wiring

- To avoid an electric shock, prior to connecting the PL unit's power cord terminals to the power terminal block, confirm that the PL unit's power supply is completely turned OFF, via a breaker, or similar unit.
- Supplying a power voltage other than that specified will damage the power source and the PL unit.
- When the FG terminal is connected, be sure the wire is grounded.

## 1 Wiring for the PL unit

Connect the power cord to the Power Connector using the Power Plug on the Rear of the PL unit.

### ■ Power Cord Specifications

Use copper conductors only.

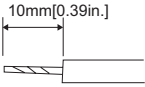
Power Cord Diameter	0.75mm <sup>2</sup> to 2.5mm <sup>2</sup> (18AWG to 12 AWG)
Conductor Type	Simple or Twisted Wire <sup>*1</sup>
Conductor Length	 10mm[0.39in.]

- \*1 If the Conductor's end (individual) wires are not twisted correctly, the end wires may either short against each other, or against an electrode.

### ■ Wiring

When connecting the Power Cord, use the following items when performing wiring. (Items are made by Phoenix Contact.)

Recommended Driver	SZS 0.6X3.5 (1205053)
Recommended Pin Terminals	AI 0.75-10GY(3201288) AI 1-10RD(3200182) AI 1.5-10BK(3200195) AI 2.5-12BU(3200962)
Recommended Pin Terminal Crimp Tool	CRIMPFOX ZA3 (1201882)



## ■ Connecting the Power Cord

When connecting the DC type power cord, be sure to follow the procedures given below.

- (1) Confirm that the power cord is unplugged from the power supply.
- (2) Push the Opening button by a small and flat screw driver to open the desired pin hole.
- (3) Insert each pin terminal into its each hole. Release the Opening button to clamp the pin place.

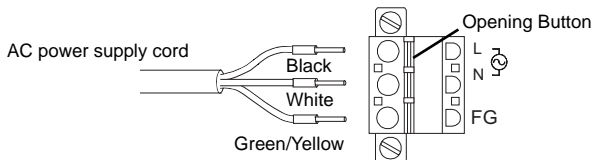

- (4) After inserting all three pins, insert the Power Plug into the Power Connector at PL. Fix the plug with two(2) minus screws.

### **IMPORTANT**

- Confirm that all wires are connected correctly.
- The torque required to tighten these screws is  $0.5\text{N}\cdot\text{m}$  to  $0.6\text{N}\cdot\text{m}$ .
- To prevent the possibility of a terminal short, use a pin terminal that has an insulating sleeve.
- The temperature rating of field installed conductors:  $75^{\circ}\text{C}$  or less.

## 2 Power Supply Cautions

- When supplying power to the PL unit, please separate the input/output and operation unit lines.
- To increase the noise resistance quality of the power cord, simply twist each power wire before attaching the Ring Terminal.
- The power cord must not be bundled or positioned close to main circuit lines (high voltage, high current), or input/output signal lines.
- To avoid excess noise, make the power cord as short as possible.
- If the supplied voltage exceeds the PL unit's range, connect a constant voltage transformer.
- For between the line and ground, select a power supply that is low in noise. If there is an excess amount of noise, connect a noise reducing transformer.

### **IMPORTANT**

- Use constant voltage and insulating transformers with capacities exceeding 200VA.

- Connect a lightning surge absorber, as shown in the diagram, to deal with power surges.

**IMPORTANT**

- Be sure to ground the surge absorber (E1) separately from the PL unit (E2).
- Select a surge absorber that has a maximum circuit voltage greater than that of the peak voltage of the power supply.

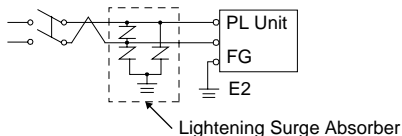

### 3 Grounding Cautions

- Be sure to create an exclusive ground for the power cord's FG terminal. Check that the grounding resistance is less than 100  $\Omega$ .
- Inside the PL unit, the SG (Signal Ground) and FG (Frame Ground) terminals are connected. When connecting an external device to the PL using the SG terminal, be sure to check that no short-circuit loop is created when you setup the system.
- The grounding wire should have a cross sectional area greater than 2mm<sup>2</sup> [0.0062inch<sup>2</sup>]. Create the connection point as close to the PL unit as possible, and make the wire as short, as possible. When using a long grounding wire, replace the thin wire with a thicker wire, and place it in a duct.

Exclusive Grounding (BEST)

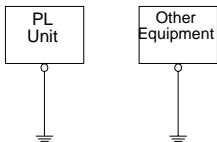

Common Grounding (OK)

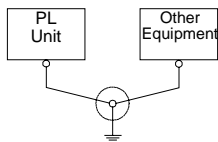

Common Grounding (Not OK)

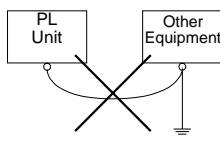

### 4 Input/Output Signal Line Cautions

- Input and output signal lines must be separated from the power control cables for operating circuits.
- If this is not possible, use a shielded cable and connect the shield to the PL unit's frame.
- To improve noise immunity, it is recommended to attach a ferrite core to the power cord.

## Installing the USB Clamp

When using the USB device, attaching the USB Clamp prevents the USB plug from falling out of the unit.

- (1) Attach the bracket to the USB Interface part of the main unit.
- (2) Plug the USB cable into the unit. Tie up the cable and clamp to fix firmly.

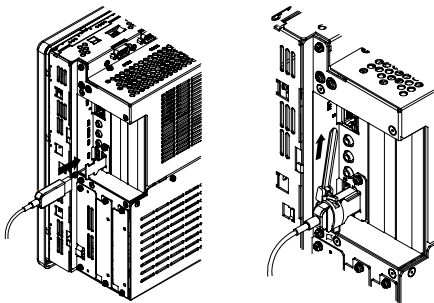

## Replacing the Backlight

The PL's backlight can be replaced after it wears out. For the procedure for replacing the backlight, refer to "PL-6930/PL-7930 Series User Manual".

The backlight's model number is CA3-BLU15-01.

## Replacing the Internal Battery

The PL unit has an internal battery for backup of internal clock data.

For the procedure for replacing the battery, refer to "PL-6930/PL-7930 Series User Manual".

The Lithium Battery CR2032 is made by Hitachi Maxell, Ltd.

### ⚠ CAUTION

- There is a danger of explosion if the PL unit's internal battery is incorrectly replaced. When replacement is required, use a Pro-face-designated product.
- When the battery is replaced, the BIOS settings are initialized. Configure the BIOS setting again after replacing the battery.
- Dispose of used batteries according to the battery manufacturer's instructions.

**Note**

Please be aware that Digital Electronics Corporation shall not be held liable by the user for any damages, losses, or third party claims arising from the uses of this product.

© Copyright 2006 Digital Electronics Corporation. All rights reserved.