

**Pro-face**

by Schneider Electric

# DC Power Supply Adapter for Box Module Installation Guide

---

---

## Safety Information

---

Important Information.....	4
----------------------------	---

---

## Overview

---

Introduction .....	6
Package Contents.....	7

---

## Parts Identification and Dimensions

---

Parts Identification .....	8
External Dimensions .....	10
External Dimensions (with Box Module and DIN Rail).....	11
External Dimensions (with Box Module and Wall Mount Adapter).....	12
Dimensions with Cable (with Box Module).....	13

---

## Specifications

---

Electrical Specifications .....	14
Environmental Specifications.....	15
Structural Specifications .....	17

---

## Installation

---

Installation Procedure .....	18
Installation Requirements .....	20
Box Module Installation.....	22
DIN Rail Installation .....	27
Wall Mount Installation.....	30

---

## Wiring

---

Wiring.....	35
-------------	----

---

## Ethernet Interface Setting

---

Ethernet Interface Setting (Only for SP-5B40).....	42
--	----

---

## Standards

---

Standards.....	44
----------------	----

---

## Important Information

### Notice

Read these instructions carefully, and look at the equipment to become familiar with the device before trying to install, operate, or maintain it. The following special messages may appear throughout this documentation or on the equipment to warn of potential hazards or to call attention to information that clarifies or simplifies a procedure.



The addition of this symbol to a "Danger" or "Warning" safety label indicates that an electrical hazard exists which will result in personal injury if the instructions are not followed.



This is the safety alert symbol. It is used to alert you to potential personal injury hazards. Obey all safety messages that follow this symbol to avoid possible injury or death.

### DANGER

**DANGER** indicates a hazardous situation which, if not avoided, **will result in** death or serious injury.

### WARNING

**WARNING** indicates a hazardous situation which, if not avoided, **could result in** death or serious injury.

### CAUTION

**CAUTION** indicates a hazardous situation which, if not avoided, **could result in** minor or moderate injury.

### NOTICE

**NOTICE** is used to address practices not related to physical injury.

## PLEASE NOTE

Electrical equipment should be installed, operated, serviced, and maintained only by qualified personnel. No responsibility is assumed by Schneider Electric or any of its affiliates or subsidiaries (hereinafter, referred to as Schneider Electric) for any consequences arising out of the use of this material. A qualified person is one who has skills and knowledge related to the construction and operation of electrical equipment and its installation, and has received safety training to recognize and avoid the hazards involved.

## DANGER

### HAZARD OF ELECTRIC SHOCK, EXPLOSION OR ARC FLASH

- Remove all power from the device before removing any covers or elements of the system, and prior to installing or removing any accessories, hardware, or cables.
- Unplug the power cable from both this product and the power supply.
- Always use a properly rated voltage sensing device to confirm power is off.
- Replace and secure all covers or elements of the system before applying power to this product.
- Use only the specified voltage when operating this product. The DC unit is designed to use 12 to 24 Vdc. Always check whether your device is DC powered before applying power.

**Failure to follow these instructions will result in death or serious injury.**

## WARNING

### UNINTENDED EQUIPMENT OPERATION

The application of this product requires expertise in the design and programming of control systems. Only persons with such expertise should be allowed to program, install, alter, and apply this product. Follow all local and national safety standards.

**Failure to follow these instructions can result in death, serious injury, or equipment damage.**

---

## Introduction

---

This product is an adapter that attaches to the SP5000 Series Box Module (hereafter referred to as “Box Module”) to supply power to the Box Module.

By using this product, you can install the SP5000 Series Display Module and Box Module in separate locations.

You can install this product on a DIN rail. You can also install this product on a wall or on the floor using the Wall Mount Adapter accessory, model number PFXZSPADWM1 (see page 30).

**NOTE:** When you attach this product to the SP-5B40, the display on the DVI port side becomes the main display. As changing the configuration of the main display causes the screen to stop displaying on the DVI port side display, do not change its configuration.

## Package Contents

The following items are included in the package. Before using this product, please confirm that all items listed here are present:

1

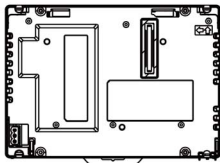

2

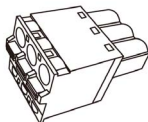

- 1 DC Power Supply Adapter for Box Module (model number: PFXZCDADEXP1): 1
- 2 DC power supply connector (straight type): 1
- 3 DC Power Supply Adapter for Box Module Installation Guide (This guide): 1

This product has been carefully packed, with special attention to quality. However, should you find anything damaged or missing, please contact customer support immediately.

## Parts Identification

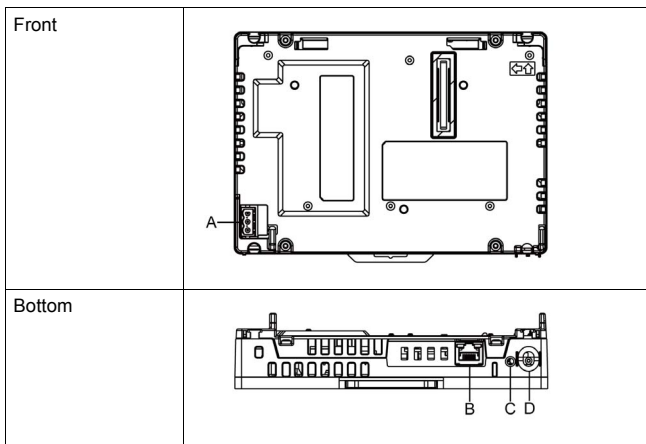

Part	Name	Description
A	Power plug connector	-
B	Ethernet interface (ETHERNET)	Ethernet transmission interface (100BASE-TX) <sup>*1</sup> Connector: Modular jack (RJ-45) x 1 <b>NOTE:</b> When you use this product, which attaches to the SP-5B40, changes to settings are required (see page 42).
C	Status LED (POWER)	Green: Power is turned ON OFF: Power is turned OFF
D	Eject switch for SD card <sup>*2*3</sup> (EJECT)	Push the switch to eject the SD memory card, used for storage. <b>NOTE:</b> The switch is available only when the SP5000 Series Power Box is attached.

<sup>\*1</sup> When the SP5000 Series Power Box or SP-5B40 is attached, 10BASE-T communication is possible.

<sup>\*2</sup> To remove the SD card from the SP5000 Series Open Box, use one of the methods below:

- Turn off the power.
- Use either the Launcher's Eject command or the Windows<sup>®</sup> hardware removal tool.

For the second method, either connect to an external display or use remote monitoring

software. For information on the Launcher, refer to the SP5000 Series Open Box Reference Manual.

\*3 Before removing the SD card used for storage, check the Box Module's Card Access LED to make sure the storage card is not in use. For information on the Box Module's Card Access LED, refer to the SP5000 Series (Box Module) Installation Guide or the SP5000 Series Hardware Manual.

## CAUTION

### LOSS OF COMMUNICATION

- All connections to the communication ports must not put excessive stress on the ports.
- Securely attach communication cables to the panel wall or cabinet.
- Use a RJ-45 connector that has a functional locking tab.

**Failure to follow these instructions can result in injury or equipment damage.**



## External Dimensions

$\frac{\text{mm}}{\text{in}}$

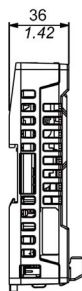
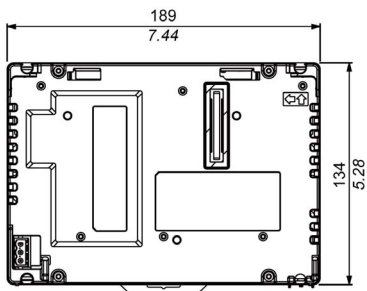

- 1 Front
- 2 Left
- 3 Bottom

## External Dimensions (with Box Module and DIN Rail)

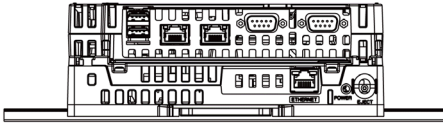
$$\frac{\text{mm}}{\text{in}}$$

(3)

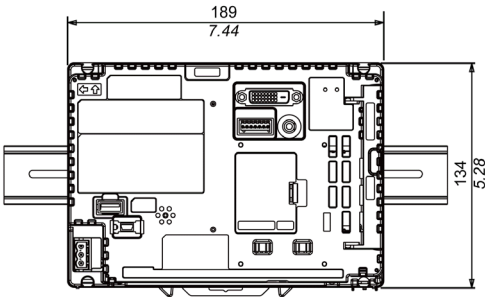

(1)

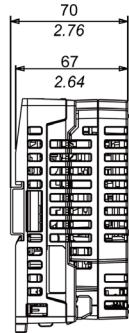

(2)

- 1 Front
- 2 Left
- 3 Bottom

## External Dimensions (with Box Module and Wall Mount Adapter)

mm  
in

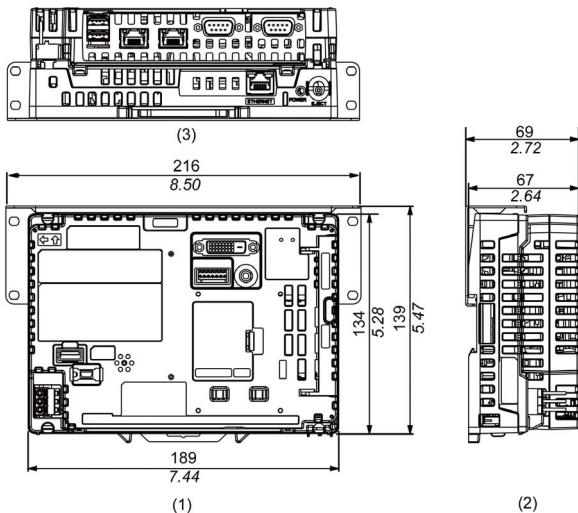

- 1 Front
- 2 Left
- 3 Bottom

## Dimensions with Cable (with Box Module)

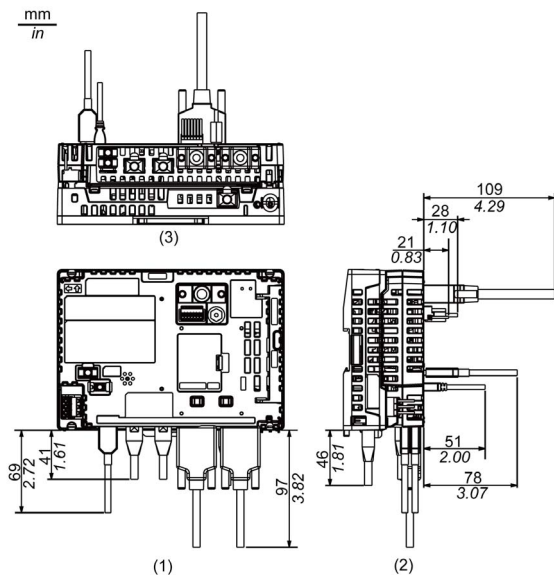

- 1 Front
- 2 Left
- 3 Bottom

## Electrical Specifications

Power supply	Rated input voltage	12...24 Vdc	
	Input voltage limits	10.8...28.8 Vdc	
	Voltage drop	12 Vdc: 1.25 ms or less 24 Vdc: 5 ms or less	
	Power consumption	Max (with Box Module)	37 W or less (when Open Box is attached) 27 W or less (when Power Box is attached)
		Max (this product only)	2.0 W or less
In-rush current	30 A or less		
Voltage endurance		1,000 Vac, 20 mA for 1 minute (between charging and FG terminals)	
Insulation resistance		500 Vdc, 10 M $\Omega$ or more (between charging and FG terminals)	

## Environmental Specifications

Physical environment	Surrounding air temperature	0...60 °C (32...140 °F) (For a floor installation, the designated range for the surrounding air temperature is 0 to 55 °C [32 to 131 °F]) (The UL-listed temperature is 0 to 60 °C [32 to 140 °F]).
	Storage temperature	-20...60 °C (-4...140 °F)
	Surrounding air and storage humidity	10...90% RH (non-condensing, wet bulb temperature 39 °C [102.2 °F] or less)
	Dust	0.1 mg/m <sup>3</sup> (10 <sup>-7</sup> oz/ft <sup>3</sup> ) or less (non-conductive levels)
	Pollution degree	For use in Pollution Degree 2 environment
	Corrosive gases	Free of corrosive gases
	Atmospheric pressure (Operating altitude)	800...1,114 hpa (2,000 m [6,561 ft] or lower)
Mechanical environment	Vibration resistance	IEC/EN 61131-2 compliant 5...9 Hz Single amplitude 3.5 mm (0.14 in) 9...150 Hz Fixed acceleration: 9.8 m/s <sup>2</sup> X, Y, Z directions for 10 cycles (approximately 100 minutes)
	Shock resistance	IEC/EN 61131-2 compliant 147 m/s <sup>2</sup> , X, Y, Z directions for 3 times
Electrical environment	Noise immunity	Noise voltage: 1,000 Vp-p Pulse duration: 1 μs Rise time: 1 ns (via noise simulator)
	Electrostatic discharge immunity	Contact discharge method: 6 kV (IEC/EN 61000-4-2 Level 3)

## Air quality requirements

Do not operate or store this product where chemicals evaporate, or where chemicals are present in the air:

- Corrosive chemicals: Acids, alkalines, liquids containing salt.
- Flammable chemicals: Organic solvents.

# CAUTION

## **INOPERATIVE EQUIPMENT**

Do not allow water, liquids, metal, and wiring fragments to enter this product.

**Failure to follow these instructions can result in injury or equipment damage.**

---

## Structural Specifications

---

Grounding	Functional grounding: Grounding resistance of 100 $\Omega$ , 2 mm <sup>2</sup> (AWG 14) or thicker wire, or your country's applicable standard (same for FG and SG terminals).
Cooling method	Natural air circulation
External dimensions (W x H x D)	189 x 134 x 36 mm (7.44 x 5.28 x 1.42 in)
Weight	0.75 kg (1.65 lb) or less



## Installation Procedure

### Introduction

With the Box Module attached, you can install this product directly to the DIN rail, wall, or floor.

**NOTE:** Use the rail compatible with IEC 60715 TH35-7.5 for this product.

### Installing to DIN rail

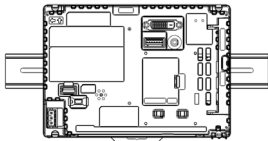

### Installing to wall or floor

The Wall Mount Adapter accessory (model number: PFXZSPADWM1) is required for installation.

#### Wall Installation

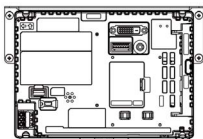

Standard installation  
(landscape)

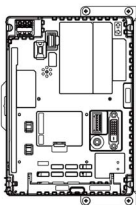

Standard installation  
(portrait)

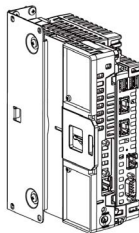

Book installation  
(vertical)

## Floor Installation

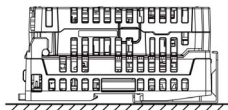

Standard installation (floor)

## Installation Requirements

Check that the installation wall or cabinet surface is flat, in good condition and has no jagged edges. Metal reinforcing strips may be attached to the inside of the wall, near the installation location, to increase its rigidity.

Depending on the panel's material and design, the panel's installation surface may need to be strengthened. If high levels of vibration are expected and the installation surface of this product (such as operation panel door) can move (open or close), due consideration should be given to the weight of this product.

Be sure that the surrounding air temperature and ambient humidity are within their designated ranges. Surrounding air temperature: 0 to 60 °C (32 to 140 °F).<sup>\*1</sup> See the Environment Specifications for this product. Ambient humidity: 10 to 90% RH. Wet bulb temperature: maximum 39 °C (102 °F). When installing this product in a cabinet or enclosure, consider the surrounding air temperature for both the internal temperature and external temperature.

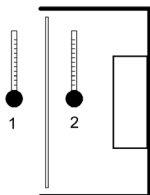

- 1 External temperature
- 2 Internal temperature

<sup>\*1</sup> For a floor installation, the designated range for the surrounding air temperature is 0 to 55 °C (32 to 131 °F) (The UL-listed temperature is 0 to 60 °C [32 to 140 °F]).

Be sure that heat from surrounding equipment does not cause this product to exceed its standard operating temperature.

When installing this product, attach the DC power connector in any of the following positions.

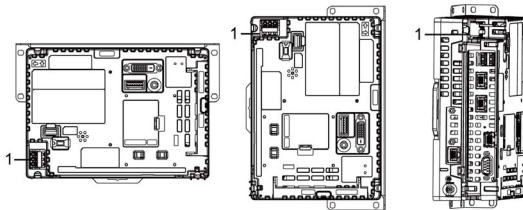

1 Power connector

When installing this product in a slanted position, the product face should not incline more than  $30^\circ$  either vertically or horizontally.

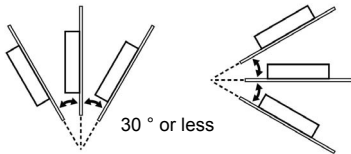

When installing this product in a slanted position with an incline greater than  $30^\circ$ , the ambient temperature must not exceed  $40^\circ\text{C}$  ( $104^\circ\text{F}$ ). You may need to use forced air cooling (such as a fan or A/C) to ensure the ambient operating temperature is  $40^\circ\text{C}$  or less ( $104^\circ\text{F}$  or less).

For easier maintenance, operation, and improved ventilation, install this product at least 100 mm (3.94 in) away from adjacent structures and other equipment as shown in the following diagram.

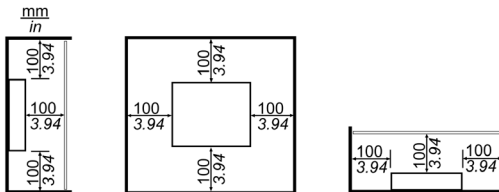

Please ensure you have enough space to insert and remove the storage card.

## Box Module Installation

### **DANGER**

#### **HAZARD OF ELECTRIC SHOCK, EXPLOSION OR ARC FLASH**

- Remove all power from the device before removing any covers or elements of the system, and prior to installing or removing any accessories, hardware, or cables.
- Unplug the power cable from both this product and the power supply.
- Always use a properly rated voltage sensing device to confirm power is off.
- Replace and secure all covers or elements of the system before applying power to this product.

**Failure to follow these instructions will result in death or serious injury.**

### **CAUTION**

#### **RISK OF INJURY**

- Do not drop this product when you mount it to the DIN rail/wall or remove it from the DIN rail/wall.
  - Hold the unit in place after removing the fasteners.
  - Use both hands.
- Do not drop the Box Module when you install Box Module onto this product or remove Box Module from this product.
- Be careful not to injure your fingers when you mount this product to the DIN rail.

**Failure to follow these instructions can result in injury or equipment damage.**

Be aware of the following when building this product into an end-use product:

- The rear face of this product is not approved as an enclosure. When building this product into an end-use product, be sure to use an enclosure that satisfies standards as the end-use product's overall enclosure.
- This product must be used indoors only.

## Installing to Box Module

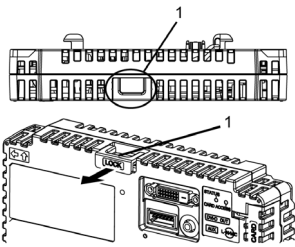
Step	Action
1	<p data-bbox="187 215 905 267">Pull the LOCK forward on the top of the Box Module to release the lock as illustrated.</p>  <p data-bbox="187 594 275 617">1 LOCK</p>

Step	Action
2	Insert the protruding points on the bottom left and right of the Box Module into the two holes on the back of this product to attach the Box Module and this product together.
<p>2 Protruding points 3 Box Module 4 This product 5 Holes for insertion</p>	

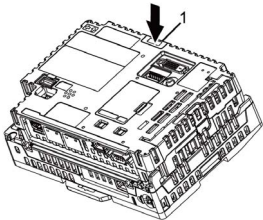
Step	Action
3	<p data-bbox="181 138 927 196">Fully push on the LOCK on the top of the Box Module to mount the Box Module on this product.</p>  <p data-bbox="181 516 274 546">1 LOCK</p>

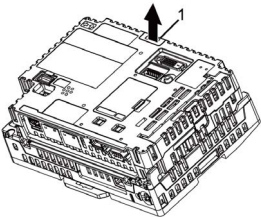
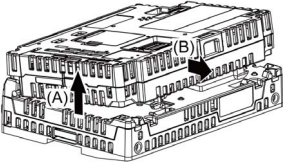

## Removing from Box Module

Step	Action
1	For a standard installation (portrait) or book installation (vertical) remove this product from the panel and place the Box Module face up on a clean and level surface.
2	Release the LOCK on the top of the Box Module as illustrated.  1 LOCK
3	Lift up the Box Module in the direction indicated by arrow (A) in the diagram and remove it by sliding in the direction indicated by arrow (B). 

## DIN Rail Installation

**NOTE:** Use the rail compatible with IEC 60715 TH35-7.5 for this product.

### **DANGER**

#### **HAZARD OF ELECTRIC SHOCK, EXPLOSION OR ARC FLASH**

- Remove all power from the device before removing any covers or elements of the system, and prior to installing or removing any accessories, hardware, or cables.
- Unplug the power cable from both this product and the power supply.
- Always use a properly rated voltage sensing device to confirm power is off.
- Replace and secure all covers or elements of the system before applying power to this product.

**Failure to follow these instructions will result in death or serious injury.**

### **CAUTION**

#### **RISK OF INJURY**

- Do not drop this product when you mount it to the DIN rail/wall or remove it from the DIN rail/wall.
  - Hold the unit in place after removing the fasteners.
  - Use both hands.
- Do not drop the Box Module when you install Box Module onto this product or remove Box Module from this product.
- Be careful not to injure your fingers when you mount this product to the DIN rail.

**Failure to follow these instructions can result in injury or equipment damage.**

## Installing to DIN Rail

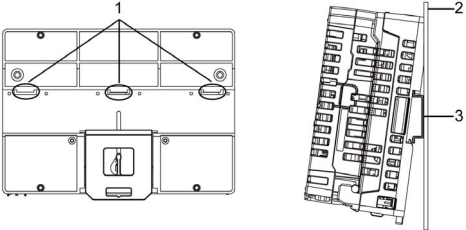
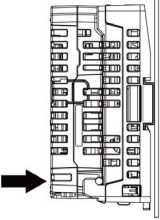
Step	Action
1	<p data-bbox="184 224 844 248">Hook the grooves at the rear of this product onto the DIN rail.</p> <div data-bbox="212 291 818 589"><p>The diagram consists of two parts. On the left is a top-down view of the product's rear panel, showing a central groove labeled '1' and two side grooves. On the right is a side view of the product, showing the panel labeled '2' and the DIN rail labeled '3' that it is designed to fit onto.</p></div> <p data-bbox="184 612 288 690">1 Groove 2 Panel 3 DIN rail</p>
2	<p data-bbox="184 711 780 736">Push the bottom part onto the rail until you hear a click.</p> <div data-bbox="181 749 388 1033"><p>The diagram shows a side view of the product's bottom section being pushed onto the DIN rail. A thick black arrow points from the left towards the bottom section of the product, indicating the direction of force.</p></div>

**NOTE:** In environments where this product will experience extreme vibration and shock, affix this product to the DIN rail with compatible fasteners, as required.

## Removing from DIN Rail

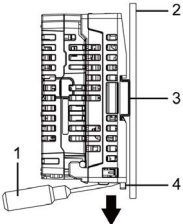
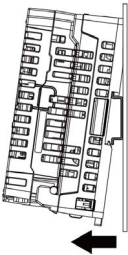
Step	Action
1	<p data-bbox="184 224 895 278">Using a tool, such as a screwdriver, push the hook in the direction indicated by the arrow.</p>  <p data-bbox="184 608 495 717">1 Tool such as a screwdriver 2 Panel 3 DIN rail 4 Hook</p>
2	<p data-bbox="184 739 795 764">Pull the bottom portion of the product forward to remove.</p> 

## Wall Mount Installation

### Wall Mount Adapter

The Wall Mount Adapter accessory (model number PFXZSPADWM1) is required to install this product onto a wall.

The following items come with the Wall Mount Adapter.

- 1 Wall Mount Adapter: 1
- 2 Installation screws (M4 x 10): 8

### Installation Holes

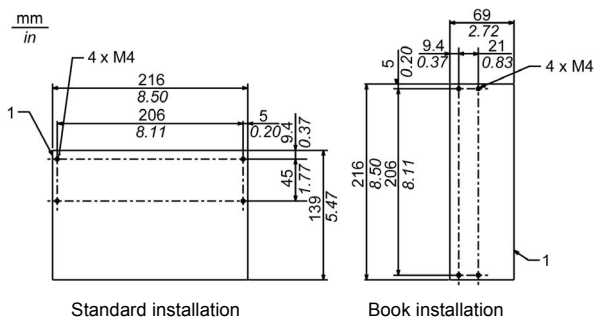

1 Product outline

**⚡ ⚠ DANGER****HAZARD OF ELECTRIC SHOCK, EXPLOSION OR ARC FLASH**

- Remove all power from the device before removing any covers or elements of the system, and prior to installing or removing any accessories, hardware, or cables.
- Unplug the power cable from both this product and the power supply.
- Always use a properly rated voltage sensing device to confirm power is off.
- Replace and secure all covers or elements of the system before applying power to this product.

**Failure to follow these instructions will result in death or serious injury.**

**⚠ CAUTION****RISK OF INJURY**

- Do not drop this product when you mount it to the DIN rail/wall or remove it from the DIN rail/wall.
  - Hold the unit in place after removing the fasteners.
  - Use both hands.
- Do not drop the Box Module when you install Box Module onto this product or remove Box Module from this product.
- Be careful not to injure your fingers when you mount this product to the DIN rail.

**Failure to follow these instructions can result in injury or equipment damage.**

## Installing onto the Wall/Floor

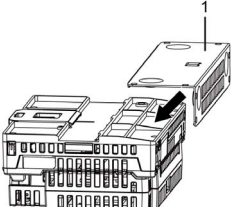
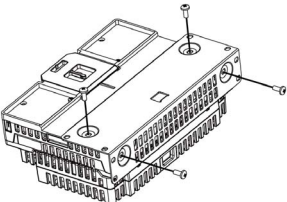
Step	Action
1	For a standard installation (portrait) or book installation (vertical), first attach this product to the Box Module (see page 22).
2	As illustrated in the Installation Holes (see page 30), prepare holes in the wall or floor.
3	As illustrated, align the top of the Wall Mount Adapter to the top of this product.  1 Wall Mount Adapter
4	With a Phillips screwdriver, tighten the screws (M4 x 10) included with the Wall Mount Adapter in two places at the back, and two places at the top. The necessary torque is 1.5 N•m (13.3 lb-in). 

- 5 The position of the installation holes vary depending on your installation.  
Using a Phillips screwdriver, insert the screws included with the Wall Mount Adapter into the four installation holes. The necessary torque is 1.5 N•m (13.3 lb-in).

Standard installation

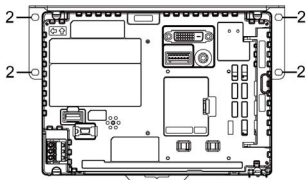

Book installation

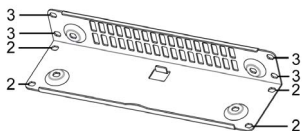
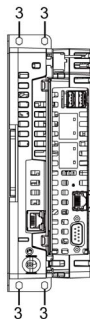

2 Holes for standard installation

3 Holes for book installation

## NOTICE

### BROKEN ENCLOSURE

- Do not exert more than 1.5 N•m (13.3 lb-in) of torque when tightening the fastener's screws.

**Failure to follow these instructions can result in equipment damage.**



---

## Removing from the Wall/Floor

Remove the Wall Mount Adapter in reverse order of installing to the wall/floor.

## Wiring

# DANGER

### HAZARD OF ELECTRIC SHOCK, EXPLOSION OR ARC FLASH

- Remove all power from the device before removing any covers or elements of the system, and prior to installing or removing any accessories, hardware, or cables.
- Remove power before wiring this product's power terminals.
- Always use a properly rated voltage sensing device to confirm power is off.
- Replace and secure all covers or elements of the system before applying power to this product.
- Use only the specified voltage when operating this product. The DC unit is designed to use 12 to 24 Vdc. Always check whether your device is DC powered before applying power.
- Since this product is not equipped with a power switch, be sure to connect a power switch to the power supply.
- Be sure to ground this product's FG terminal.

**Failure to follow these instructions will result in death or serious injury.**

#### NOTE:

- The SG (signal ground) and FG (functional ground) terminals are connected internally in this product.
- When the FG terminal is connected, be sure the wire is grounded. Not grounding this product can result in excessive electromagnetic interference (EMI).

## DC Power Cord Preparation

- Make sure the ground wire is either the same or heavier gauge than the power wires.
- Do not use aluminum wires in the power supply's power cord.
- To prevent the possibility of a terminal short, use a pin terminal that has an insulating sleeve.
- If the ends of the individual wires are not twisted correctly, the wires may create a short circuit.
- The conductor type is solid or stranded wire.
- Use copper wire rated for 75 °C (167 °F) or higher.

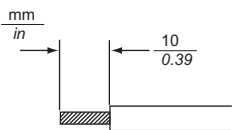
Power cord diameter	0.75...2.5 mm <sup>2</sup> (18...13 AWG) <sup>*1</sup>
Conductor type	Solid or stranded wire
Conductor length	
Recommended driver <sup>*2</sup>	SZS 0.6 x 3.5 (1205053)
Recommended pin terminals <sup>*2</sup>	3201288 Al 0,75 - 10 GY 3200182 Al 1 - 10 RD 3200195 Al 1,5 - 10 BK 3202533 Al 2,5 - 10 BU
Recommended pin terminal crimp tool <sup>*2</sup>	CRIMPFOX6

\*1 For UL compatibility, use AWG 14 or AWG 13.

\*2 Items are made by Phoenix Contact.

## Power Connector Specifications: Spring Clamp Terminal Blocks

This product comes with the straight type power connector.

**NOTE:** Straight type: PFXZCBCNDC1 by Pro-face

Straight type

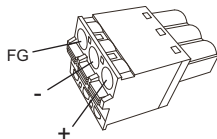

Connection	Wire
+	12...24 Vdc
-	0 Vdc
FG	Grounded terminal connected to the panel chassis.

## How to Connect the DC Power Cord

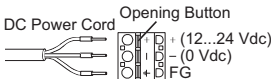
Step	Action
1	Confirm the power cord is not connected to the power supply.
2	Check the rated voltage, and remove the "DC24V" sticker on the DC power supply connector.
3	Connect each wire from the power cable to a pin terminal.
4	Push the Opening button with a small and flat screwdriver to open the desired pin hole.
5	<p>Insert each power cord wire into its corresponding holder. Release the Opening button to clamp the wire in place.</p>  <p>When using stranded wire, do not short with neighboring wires.</p>
6	After inserting all three power cord wires, insert the DC power supply connector into the power connector on this product.

**NOTE:** Do not solder the wire directly to the power crimp pin.

## Wiring Precautions

Excessive stress on the power connection or attempting to install this product with the power cables connected may disconnect or cause damage to the power connections. This can cause short circuits, fire or unintended equipment operation.

# DANGER

## SHORT CIRCUIT, FIRE, OR UNINTENDED EQUIPMENT OPERATION

Avoid excessive force on the power cable to prevent accidental disconnection

- Securely attach power cables to an installation panel or cabinet.
- Install and fasten this product on installation panel or cabinet prior to connecting power supply and communication lines.

**Failure to follow these instructions will result in death or serious injury.**

## Improving Noise/Surge Resistance

- This product's power supply cord should not be bundled with or kept close to main circuit lines (high voltage, high current), power lines, or input/output lines, and their various systems should be kept separate. When power lines cannot be wired via a separate system, use shielded cables for input/output lines.
- Make the power cord as short as possible, and be sure to twist the ends of the wires together (i.e. twisted pair cabling) from close to the power supply unit.
- If there is an excess amount of noise on the power supply line, reduce the noise with a noise filter before turning on the power.
- Connect a surge protection device to handle power surges.
- To increase noise resistance, attach a ferrite core to the power cable.

### Power Supply Connections

- Branch Circuit Protective device shall be used for rating 20 A input device for this product.
- You must use DC input with an isolating source for the this product.
- You must use DC input with a Class 2 power supply for this product.
- The following shows a surge protection device connection:

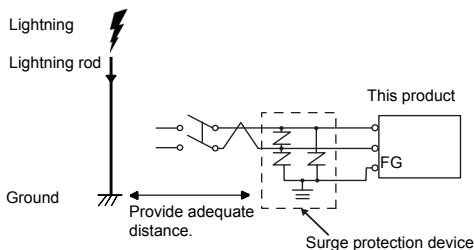

Attach a surge protection device to prevent damage to this product as a result of a lightning-induced power surge from a large electromagnetic field generated from a direct lightning strike. We also strongly recommend to connect the crossover grounding wire of this product to a position close to the ground terminal of the surge protection device.

It is expected that there will be an effect on this product due to fluctuations in grounding potential when there is a large surge flow of electrical energy to the lightning rod ground at the time of a lightning strike. Provide adequate distance between the lightning rod grounding point and the surge protection device grounding point.

## Grounding

- Check that the grounding resistance is  $100\ \Omega$  or less.\*1
- The FG wire should have a cross sectional area greater than  $2\ \text{mm}^2$  (AWG14)\*1. Create the connection point as close to this product as possible, and make the wire as short as possible. When using a long grounding wire, replace the thin wire with a thicker wire, and place it in a duct.

\*1 Observe local codes and standards.

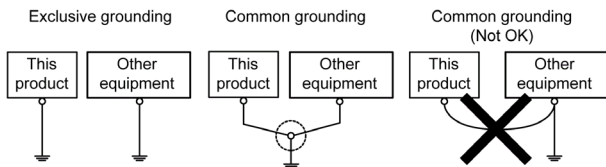

## Short Circuit Prevention

The SG (signal ground) and FG (functional ground) terminals are connected internally in this product. When connecting the SG line to another device, be sure that no ground loop is formed.



## Ethernet Interface Setting (Only for SP-5B40)

When you use this product, which attaches to the SP-5B40, change the Ethernet interface settings as shown in the following steps.

### NOTE:

- When changing the settings, always ensure that the Write Filter on the SP-5B40 is disabled. If the Write Filter is enabled, the setting information will be erased when the operating system is restarted. After you change the settings, we recommend that you re-enable the Write Filter.
- After using this product, and you connect a SP5000 Series Display Module Wireless LAN model to the same SP-5B40, return its settings to the same state as before the change.

Step	Action
1	On the SP-5B40, from the Windows® Control Panel, select <b>Network and Internet</b> → <b>Network and Sharing Center</b> → <b>Change adapter settings</b> .
2	Right-click <b>Local Area Connection</b> for "LAN9500A USB 2.0 to Ethernet 10/100 Adapter (HAL)", and click <b>Properties</b> → <b>Networking</b> tab → <b>Configure</b> → <b>Advanced</b> tab.
3	Set <b>Property</b> to [Auto Mdx], and <b>Value</b> to [ON].

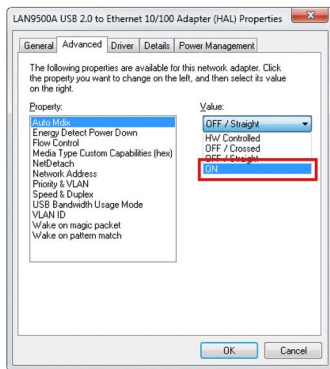

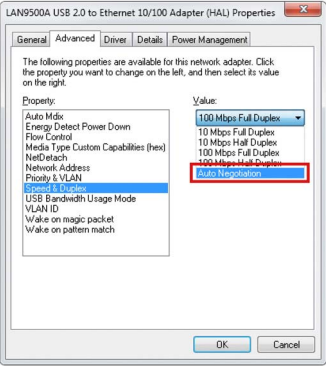
Step	Action
4	<p>Then, set <b>Property</b> to [Speed &amp; Duplex], and <b>Value</b> to [Auto Negotiation].</p> 
5	Click <b>OK</b> .

---

## Standards

---

For information on certifications and standards, such as certified models and certificates, see the product markings or visit our website:

<http://www.pro-face.com/trans/en/manual/1002.html>

# DANGER

## POTENTIAL FOR EXPLOSION

- Suitable for use in Class I, Division 2, Groups A, B, C, and D Hazardous Locations.
- Substitution of any component may impair suitability for Class I, Division 2.
- Do not disconnect equipment unless power has been switched off or the area is known to be non-hazardous.
- Always confirm that this product is suitable for use in hazardous locations by checking that the ANSI/ISA 12.12.01 or CSA C22.2 N°213 certification appears on the product labeling.
- Do not attempt to install, operate, modify, maintain, service, or otherwise alter this product except as permitted in this manual. Unpermitted actions may impair the suitability of this product for Class I, Division 2 operation.

**Failure to follow these instructions will result in death or serious injury.**

# DANGER

## HAZARD OF ELECTRIC SHOCK, EXPLOSION OR ARC FLASH

- Remove all power from the device before removing any covers or elements of the system, and prior to installing or removing any accessories, hardware, or cables.
- Unplug the power cable from both this product and the power supply.
- Always use a properly rated voltage sensing device to confirm power is off.
- Replace and secure all covers or elements of the system before applying power to this product.
- Use only the specified voltage when operating this product. The DC unit is designed to use 12 to 24 Vdc. Always check whether your device is DC powered before applying power.

**Failure to follow these instructions will result in death or serious injury.**

## DANGER

### POTENTIAL FOR EXPLOSION

In addition to the other instructions in this manual, observe the following rules when installing this product in a hazardous location:

- Wire the equipment in accordance with the National Electrical Code article 501.10 (B) for Class I, Division 2 hazardous locations.

**Failure to follow these instructions will result in death or serious injury.**

## WARNING

### ELECTROMAGNETIC/RADIO INTERFERENCE

Electromagnetic radiation may disrupt the operation of this product leading to unintended equipment operation. If electromagnetic interference is detected:

- Increase the distance between this product and the interfering equipment.
- Reorient this product and the interfering equipment.
- Reroute power and communication lines to this product and the interfering equipment.
- Connect this product and the interfering equipment to different power supplies.
- Always use shielded cables when connecting this product to a peripheral device or another computer.

**Failure to follow these instructions can result in death, serious injury, or equipment damage.**

The following message is for UL Hazardous Locations.

## DANGER

### RISQUE D'EXPLOSION

- Le remplacement de n'importe quel composant peut nuire à la conformité à la Classe I, Division 2.
- Avant de déconnecter l'équipement, couper le courant ou s'assurer que l'emplacement est désigné non dangereux.

**Le non-respect de ces instructions provoquera la mort ou des blessures graves.**

## KC Markings

### 사용자안내문

기종별	사 용 자 안 내 문
A급 기기 (업무용 방송통신기자재)	이 기기는 업무용(A급) 전자파적합기기로서 판매자 또는 사용자는 이 점을 주의하시기 바라며, 가정외의 지역에서 사용하는 것을 목적으로 합니다.

### Inquiry/After-sales Service

Do you have any questions about difficulties with your unit?

Please access our site any time that you need help with a solution.

**<http://www.pro-face.com/trans/en/manual/1001.html>**

### Notes

Please be aware that Schneider Electric shall not be held liable by the user for any damages, losses, or third party claims arising from the uses of this product.