

**Pro-face**

by Schneider Electric

# SP5000 Series (Box Module) Installation Guide



Please read the “Warning/Caution Information” on the attached sheet before using the product.

## Safety Information

Important Information .....	5
-----------------------------	---

## Model Numbers

Model Numbers .....	7
---------------------	---

## Overview

Package Contents .....	8
About the Manual .....	9
Global Code.....	9
Language Settings (Only for Open Box).....	9

## Part Numbers and Functions

SP-5B10 .....	10
SP-5B40 / SP-5B41 .....	11
LED Indications .....	12

## Specifications

Electrical Specifications.....	13
Environmental Specifications .....	13

## Interface

Interface Caution .....	14
Serial Interface .....	14
Auxiliary Output/Speaker Output Interface (AUX) .....	18
DVI-D Output Interface (Only for Open Box) .....	19

## Installation

Installation Procedure.....	21
Removal Procedure.....	25

## Connecting to the USB Interface

Connecting to the USB Interface .....	27
Attaching USB Clamp Type A (1 port).....	28

## AUX Connector

AUX Connector.....	30
--------------------	----

---

---

## Maintenance

---

Cleaning This Product.....	31
Replacing the Battery.....	31

---

## Standards

---

Standards.....	33
----------------	----

## Important Information

### Notice

Read these instructions carefully, and look at the equipment to become familiar with the device before trying to install, operate, or maintain it. The following special messages may appear throughout this documentation or on the equipment to warn of potential hazards or to call attention to information that clarifies or simplifies a procedure.



The addition of this symbol to a "Danger" or "Warning" safety label indicates that an electrical hazard exists which will result in personal injury if the instructions are not followed.



This is the safety alert symbol. It is used to alert you to potential personal injury hazards. Obey all safety messages that follow this symbol to avoid possible injury or death.

### **DANGER**

**DANGER** indicates a hazardous situation which, if not avoided, **will result in** death or serious injury.

### **WARNING**

**WARNING** indicates a hazardous situation which, if not avoided, **could result in** death or serious injury.

### **CAUTION**

**CAUTION** indicates a hazardous situation which, if not avoided, **could result in** minor or moderate injury.

### **NOTICE**

**NOTICE** is used to address practices not related to physical injury.

**PLEASE NOTE**

Electrical equipment should be installed, operated, serviced, and maintained only by qualified personnel. No responsibility is assumed by Schneider Electric or any of its affiliates or subsidiaries (hereinafter, referred to as Schneider Electric) for any consequences arising out of the use of this material.

A qualified person is one who has skills and knowledge related to the construction and operation of electrical equipment and its installation, and has received safety training to recognize and avoid the hazards involved.

If the equipment is used in a manner not specified by the manufacturer, the protection provided by the equipment may be impaired.

## Model Numbers

Series		Model Name	Model Number
SP5000 Series	Power Box	SP-5B10	PFXSP5B10
	Open Box	SP-5B40	PFXSP5B40
		SP-5B41	PFXSP5B41

**NOTE :** You can connect these models, except the SP-5B40<sup>\*1</sup>, to all models of SP5000 Series Display Modules. For the model numbers of the Display Module, refer to the SP5000 Series (Display Module) Installation Guide.

Additionally, you can also connect the DC Power Supply Adapter for Box Module (by Pro-face, model number: PFXZCDAEXP1).

\*1 SP-5B40 supports only Display Modules with a resolution of XGA or less.

---

## Package Contents

---

The following items are included in the package. Before using this product, please confirm that all items listed here are present:

1

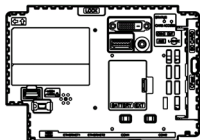

2

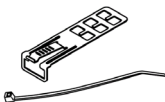

- 1 SP5000 Series Box Module: 1
- 2 USB Clamp Type A (1 port): 2 sets for Power Box, 3 sets for Open Box (1 clip and 1 tie)
- 3 SP5000 Series (Box Module) Installation Guide (this guide): 1
- 4 Warning/Caution Information: 1
- 5 End-user License Agreement (only for Open Box): 2

This product has been carefully packed, with special attention to quality. However, should you find anything damaged or missing, please contact your local distributor immediately.

---

## About the Manual

---

This manual describes wiring and installation procedures. For more detailed information, refer to the SP5000 Series Hardware Manual.

You can download the manual from our website "Otasuke Pro!" at:  
<http://www.pro-face.com/trans/en/manual/1001.html>

---

## Global Code

---

A global code is assigned to every Pro-face product as a universal model number.

For more information on product models and their matching global codes, please refer to the following URL.

<http://www.pro-face.com/trans/en/manual/1003.html>

---

## Language Settings (Only for Open Box)

---

The factory setting of the operating system language is English. Change the operating system language as required.

For details on changing the operating system language, refer to the following URL.

<http://www.pro-face.com/trans/en/product/1017.html>



## SP-5B10

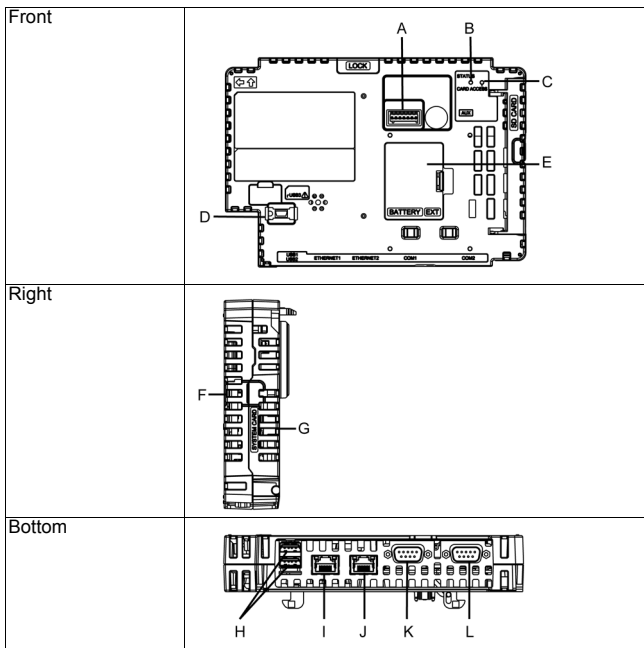

- A: Auxiliary Output/Speaker Output Interface (AUX)
- B: Status LED (See page 12)
- C: Card Access LED (See page 12)
- D: USB (mini-B) Interface
- E: Expansion Unit Interface Cover (EXT)
- F: Storage Card Cover
- G: System Card Cover
- H: USB (Type A) Interface
- I: Ethernet Interface (Ethernet1) \*1
- J: Ethernet Interface (Ethernet2) \*1
- K: Serial Interface (COM1)
- L: Serial Interface (COM2)

\*1 For 1000BASE-T communication, use twisted pair Ethernet cables with a rating of category 5 or higher.

## SP-5B40 / SP-5B41

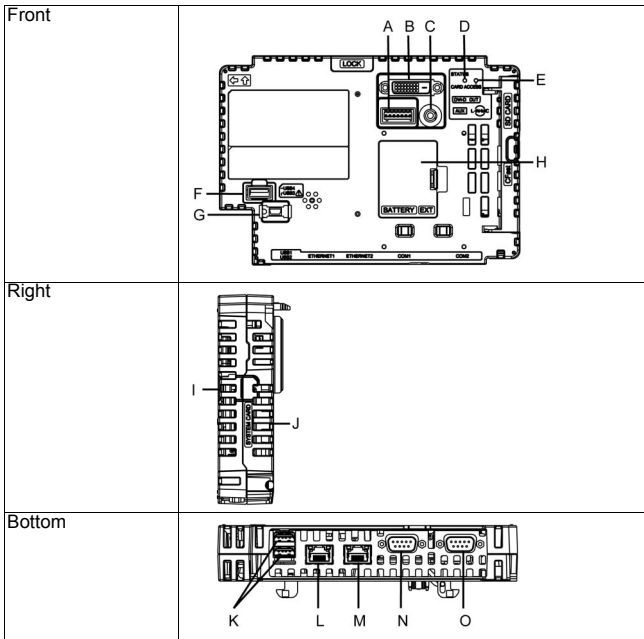

- A: Auxiliary Output/Speaker Output Interface (AUX)
- B: DVI-D Output Interface
- C: AUDIO Input Interface (L-IN/MIC)
- D: Status LED (See page 12)
- E: Card Access LED (See page 12)
- F: USB (Type A) Interface
- G: USB (mini-B) Interface
- H: Expansion Unit Interface Cover (EXT)
- I: Storage Card Cover
- J: System Card Cover
- K: USB (Type A) Interface
- L: Ethernet Interface (Ethernet1) \*1
- M: Ethernet Interface (Ethernet2) \*1
- N: Serial Interface (COM1)
- O: Serial Interface (COM2)

\*1 For 1000BASE-T communication, use twisted pair Ethernet cables with a rating of category 5 or higher.

## LED Indications

### Status LED

Color	Indicator	SP-5B10		SP-5B40 / SP-5B41	
		HMI Operation	Logic Program Operation* <sup>1</sup>	HMI Operation	Logic Program Operation* <sup>1</sup>
Green	ON	Offline	–	Offline	–
		In operation	RUN	In operation	RUN
	Flashing* <sup>1</sup>	In operation	STOP	In operation	STOP
Orange	Flashing	Software starting up			
Red	ON	Power is ON.			
	Flashing* <sup>1</sup>	In operation	Major error	In operation	Major error
Red/Green	Alternating	Display Module connection error			
Orange/Red	Alternating	SD Card boot error		–	
–	OFF	Power is OFF.			

\*<sup>1</sup> Only when your screen editing software supports the Logic Program.

### Card Access LED

Color	Indicator	SP-5B10	SP-5B40 / SP-5B41
Green	ON	Storage Card is being accessed.	Storage Card or System Card (OS) is being accessed.
–	OFF	Storage Card is not inserted or accessed.	Storage Card or System Card (OS) is not accessed.

## Electrical Specifications

Specification		SP-5B10	SP-5B40	SP-5B41
Power Supply Power Consumption (Primary Power Supply)	Rated Input Voltage	12 Vdc (Supply from Display Module or DC Power Supply Adapter for Box Module)* <sup>1</sup>		
	Max	25 W	35 W	25 W
	When power is not supplied to external devices	12.5 W or less	22.5 W or less	15 W or less

\*1 Use SELV (Safety Extra-Low Voltage) circuit and LIM (Limited Energy) circuit for DC input.

## Environmental Specifications

Physical Environment	Ambient Air Temperature	0...60 °C (32...140 °F)
	Storage Temperature	-20...60 °C (-4...140 °F)
	Ambient Air and Storage Humidity	10...90% RH (non-condensing, wet bulb temperature 39 °C [102.2 °F] or less)
	Dust	0.1 mg/m <sup>3</sup> (10 <sup>-7</sup> oz/ft <sup>3</sup> ) or less (non-conductive levels)
	Pollution Degree	For use in Pollution Degree 2 environment
	Atmospheric Pressure (Operating Altitude)	800...1,114 hPa (2,000 m [6,561 ft] or lower)

**NOTE :** When using any of the options for this product, check the specifications for special conditions or cautions that may apply to this product.

## Interface Caution

Use only the SELV (Safety Extra-Low Voltage) circuit to connect the serial, USB and Ethernet interfaces.

### DANGER

#### ELECTRIC SHOCK AND FIRE

When using the SG terminal to connect an external device to this product:

- Verify that a short-circuit loop is not created when you set up the system.
- Connect the SG terminal to remote equipment when the external device is not isolated.
- Connect the SG terminal to a known reliable ground connection to reduce the risk of damaging the circuit.

**Failure to follow these instructions will result in death or serious injury.**

## Serial Interface

For information on how to connect controllers and other types of equipment, refer to the corresponding device driver manual of your screen editing software.

The serial interface is not isolated. The SG (signal ground) and the FG (functional ground) terminals are connected inside this product. When the serial interface connector is D-Sub, connect the FG wire to the shell.

### CAUTION

#### LOSS OF COMMUNICATION

- All connections to the communication ports must not put excessive stress on the ports.
- Securely attach communication cables to the panel wall or cabinet.

**Failure to follow these instructions can result in injury or equipment damage.**

**NOTE :** Use within the rated current.

## Connection for Serial Interface

The Pin configuration of each serial interface is explained on the respective reference page.

	COM1	COM2
SP-5B10/ 5B40/5B41	RS-232C or RS-422/RS-485 (See page 16, 17)	RS-232C or RS-422/RS-485 (See page 16, 17)

The communication method can be switched via the software. The initial setting is RS-422/RS-485.

**RS-232C**

D-Sub 9 pin plug connector.

The communication method can be switched between RS-232C and RS-422/RS-485 via the software.

Pin Number	RS-232C		
	Signal Name	Direction	Meaning
1	CD	Input	Carrier Detect
2	RD(RXD)	Input	Receive Data
3	SD(TXD)	Output	Send Data
4	ER(DTR)	Output	Data Terminal Ready
5	SG	–	Signal Ground
6	DR(DSR)	Input	Data Set Ready
7	RS(RTS)	Output	Request to Send
8	CS(CTS)	Input	Send Possible
9	CI(RI)/VCC	Input/–	Called Status Display +5 Vdc $\pm 5\%$ Output 0.25 A <sup>*1*2</sup>
Shell	FG	–	Functional Ground (Common with SG)

\*1 You can switch pin #9 between CI(RI) and VCC via the software. The VCC output is not protected against overcurrent. To prevent damage or malfunction, use within the rated current only.

\*2 When using Open Box, use external equipment so that the sum of COM1 VCC output and COM2 VCC output totals 0.25 A.

Interfit bracket is #4-40 (UNC).

Recommendations:

- Cable Connector: XM3D-0921 manufactured by OMRON Corporation.
- Cable Cover: XM2S-0913 manufactured by OMRON Corporation.
- Jack Screw (#4-40 UNC): XM2Z-0073 manufactured by OMRON Corporation.

**RS-422/485**

D-Sub 9 pin plug connector.

The communication method can be switched between RS-232C and RS-422/RS-485 via the software.

Pin Number	RS-422/RS-485		
	Signal Name	Direction	Meaning
1	RDA	Input	Receive Data A (+)
2	RDB	Input	Receive Data B (-)
3	SDA	Output	Send Data A (+)
4	ERA	Output	Data Terminal Ready A (+)
5	SG	–	Signal Ground
6	CSB	Input	Send Possible B (-)
7	SDB	Output	Send Data B (-)
8	CSA	Input	Send Possible A (+)
9	ERB	Output	Data Terminal Ready B (-)
Shell	FG	–	Functional Ground (Common with SG)

Interfit bracket is #4-40 (UNC).

Recommendations:

- Cable Connector: XM3D-0921 manufactured by OMRON Corporation.
- Cable Cover: XM2S-0913 manufactured by OMRON Corporation.
- Jack Screw (#4-40 UNC): XM2Z-0073 manufactured by OMRON Corporation.

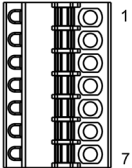

## Auxiliary Output/Speaker Output Interface (AUX)

Cable connection side	Pin Number	Signal Name	Direction	Meaning
	1	LineOut	Output	Line Out
	2	LineOut_GND	Output	Line Out Ground
	3	SP+	Output	Speaker +
	4	SP-	Output	Speaker -
	5	NC	–	No connection
	6	ALARM+/ BUZZER+	Output	(Can be changed via the software)
	7	ALARM-/ BUZZER-	Output	(Can be changed via the software)

AUX Connector: PFXZCDCNAUX1 by Pro-face.

### Output Circuit

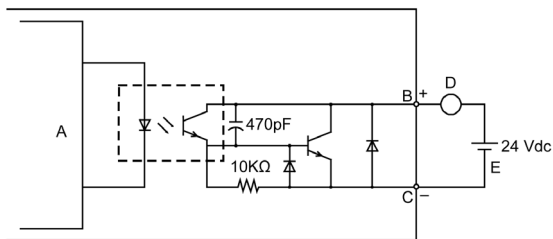

- A Internal Circuit
- B Pin Number 6: ALARM+/BUZZER+
- C Pin Number 7: ALARM-/BUZZER-
- D Load
- E External Power

## DVI-D Output Interface (Only for Open Box)

DVI-D 24 pin socket connector

Product Side	Pin Number	Signal Name	Direction
	1	TMDS DATA 2-	Output
	2	TMDS DATA 2+	Output
	3	TMDS DATA 2 SHIELD	–
	4	NC	–
	5	NC	–
	6	DDC Clock	Output
	7	DDC Data	Input/Output
	8	NC	–
	9	TMDS DATA 1-	Output
	10	TMDS DATA 1+	Output
	11	TMDS DATA 1 SHIELD	–
	12	NC	–
	13	NC	–
	14	+5 Vdc Power	–
	15	GND	Ground
	16	SP-5B40: NC SP-5B41: Hot Plug Detect	SP-5B40: – SP-5B41: Input
	17	TMDS DATA 0-	Output
	18	TMDS DATA 0+	Output
	19	TMDS DATA 0 SHIELD	–
	20	NC	–
	21	NC	–
	22	TMDS CLOCK SHIELD	–
	23	TMDS CLOCK+	Output
	24	TMDS CLOCK -	Output
Shell	FG	Functional Ground	

**Recommendations:**

DVI-D cable by Pro-face (FP-DV01-50 [5 m])

**NOTE :**

- For noise-free operation, use the recommended DVI-D cable.
- The following notes are only for SP-5B40:
  - DVI-D output supports display resolutions up to XGA (1,024 x 768). When the screen output mode is set to clone mode, the maximum display resolution of the display module is the same as the display resolution of DVI-D output, which is XGA (1,024 x 768).
  - DVI-D output does not support Hot Plug Detect (HPD). Even when the main unit power is on while connected to an external display, this product outputs the display signal as XGA. If the external display does not support XGA input, the screen will not display.

## Installation Procedure

### Installing onto Display Module / DC Power Supply Adapter for Box Module

#### **DANGER**

##### **HAZARD OF ELECTRIC SHOCK, EXPLOSION OR ARC FLASH**

- Remove all power from the device before removing any covers or elements of the system, and prior to installing or removing any accessories, hardware, or cables.
- Unplug the power cable from the Display Module or DC Power Supply Adapter for Box Module, and the power supply.
- Always use a properly rated voltage sensing device to confirm power is off.
- Replace and secure all covers or elements of the system before applying power to the Display Module or DC Power Supply Adapter for Box Module.

**Failure to follow these instructions will result in death or serious injury.**

#### **NOTICE**

##### **EQUIPMENT DAMAGE**

- When mounting this product vertically, before attaching to the panel, install the Box Module onto the Display Module or DC Power Supply Adapter for Box Module.
- When installing the Box Module onto the Display Module or DC Power Supply Adapter for Box Module, place the Display Module or DC Power Supply Adapter for Box Module on a clean and level surface with the front screen facing downward.
- Only qualified personnel can change the primary battery.

**Failure to follow these instructions can result in equipment damage.**

Be aware of the following when building this product into an end-use product:

- The rear face of this product is not approved as an enclosure. When building this product into an end-use product, be sure to use an enclosure that satisfies standards as the end-use product's overall enclosure.
- Install this product in an enclosure with mechanical rigidity.
- This product is not designed for outdoor use. UL certification obtained is for indoor use only.

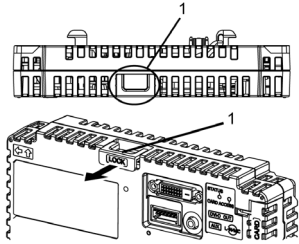
Step	Action
1	<p data-bbox="217 157 927 208">Pull the LOCK forward on the top of the Box Module to release the lock as illustrated.</p>  <p data-bbox="217 535 305 564">1 LOCK</p>

Step	Action
2	Insert the protruding points on the bottom left and right of the Box Module into the two holes on the back of the Display Module or DC Power Supply Adapter for Box Module, to attach the Box Module.
<p>2 Protruding points 3 Box Module 4 Holes for insertion 5 Display Module or DC Power Supply Adapter for Box Module</p>	

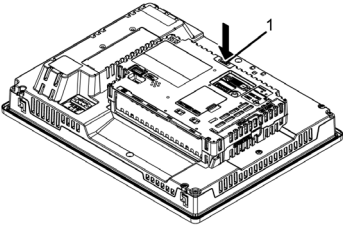
Step	Action
3	<p data-bbox="215 135 927 215">Fully push on the LOCK on the top of the Box Module to mount the Box Module on the Display Module or on the DC Power Supply Adapter for Box Module.</p>  <p data-bbox="215 521 305 546">1 LOCK</p>

**NOTE :** Refer to the SP5000 Series Hardware Manual or the SP5000 Series (Display Module) Installation Guide on how to mount the Display Module to the panel. Refer to the DC Power Supply Adapter for Box Module Installation Guide on how to mount the DC Power Supply Adapter for Box Module to the panel.

## Removal Procedure

### Removing from Display Module / DC Power Supply Adapter for Box Module

#### **DANGER**

#### **HAZARD OF ELECTRIC SHOCK, EXPLOSION OR ARC FLASH**

- Remove all power from the device before removing any covers or elements of the system, and prior to installing or removing any accessories, hardware, or cables.
- Unplug the power cable from the Display Module or DC Power Supply Adapter for Box Module, and the power supply.
- Always use a properly rated voltage sensing device to confirm power is off.
- Replace and secure all covers or elements of the system before applying power to the Display Module or DC Power Supply Adapter for Box Module.

**Failure to follow these instructions will result in death or serious injury.**

#### **NOTICE**

#### **EQUIPMENT DAMAGE**

When this product is mounted vertically, from the panel first remove the Display Module or DC Power Supply Adapter for Box Module, then remove the Box Module from the Display Module or DC Power Supply Adapter for Box Module.

**Failure to follow these instructions can result in equipment damage.**

Step	Action
1	<p>When mounting this product vertically, remove the Display Module or DC Power Supply Adapter for Box Module from the panel, and place the Display Module or DC Power Supply Adapter for Box Module on a clean and level surface with the screen facing down.</p> <p><b>NOTE :</b> Refer to the SP5000 Series Hardware Manual or the SP5000 Series (Display Module) Installation Guide on how to remove the Display Module from the panel. Refer to the DC Power Supply Adapter for Box Module Installation Guide on how to remove the DC Power Supply Adapter for Box Module from the panel.</p>



- 2 Release the LOCK on the top of the Box Module as illustrated.

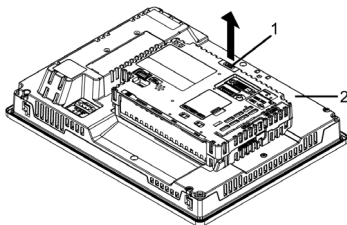

1 LOCK

2 Display Module or DC Power Supply Adapter for Box Module

- 3 Lift the Box Module in the direction indicated by arrow (A) in the diagram and remove it by sliding in the direction indicated by arrow (B).

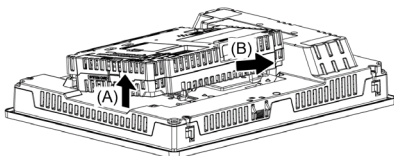

## **⚠ CAUTION**

### **RISK OF INJURY**

Do not drop the Box Module when you remove it from the Display Module or DC Power Supply Adapter for Box Module.

- Hold the unit in place after removing the fasteners.
- Use both hands.

**Failure to follow these instructions can result in injury or equipment damage.**

## Connecting to the USB Interface

### ⚠ DANGER

#### POTENTIAL FOR EXPLOSION

- Verify that the power, input and output (I/O) wiring are in accordance with Class I, Division 2 wiring methods.
- Substitution of any component may impair suitability for Class I, Division 2.
- Do not disconnect equipment while the circuit is live or unless the area is known to be free of ignitable concentrations.
- Remove power before attaching or detaching any connectors to or from this product.
- Ensure that power, communication, and accessory connections do not place excessive stress on the ports. Consider the vibration in the environment when making this determination.
- Securely attach power, communication, and external accessory cables to the panel or cabinet.
- Use only commercially available USB cables.
- Use only non-incendive USB configurations.
- Suitable for use in Class I, Division 2, Groups A, B, C, D Hazardous Locations.
- Confirm that the USB cable has been attached with the USB cable clamp before using the USB interface.
- Use the USB (mini-B) interface for temporary connection only during maintenance and setup of the device.
- Do not use the USB (mini-B) interface in hazardous locations.

**Failure to follow these instructions will result in death or serious injury.**

#### USB Interface

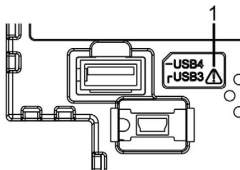

1 Safety alert symbol (see the safety messages above)

## Attaching USB Clamp Type A (1 port)

When using a USB device, attach a USB cable clamp to the USB interface to prevent the USB cable from being disconnected.

**NOTE :** Watch your fingers. The edge of the clip is sharp.

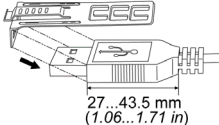
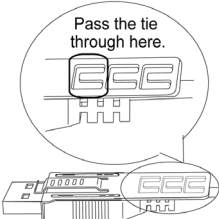
Step	Action
1	<p>Mount the clip to the USB mark  connector shell so that it overlaps. The clip matches the 27 to 43.5 mm (1.06 to 1.71 in) length of the USB connector.</p>  <p><b>NOTE :</b> When installing clamps to reduce cable stress onto both USB1 and USB2, at USB1 overlay the clip on the side with the USB mark, and on USB2 the side without the USB mark. Make sure the ties do not interfere with the other.</p>
2	<p>Align the clip and the USB cable connector shell. Adjust the position of the holes where the clip is attached. To ensure stability, select the clip-hole position that is closest to the base of the connector shell.</p> 

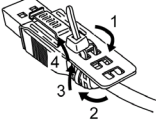
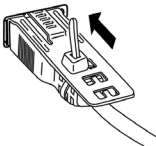
3	<p>As shown, pass the tie through the clip hole. Next, turn the tie and pass it through the head so that the USB cable can pass through the center of the tie loop.</p>  <p><b>NOTE :</b></p> <ul style="list-style-type: none"> <li>• Check the direction of the head beforehand. Make sure the USB cable is through the center of the tie loop and that the tie can pass through the head.</li> <li>• You can substitute the tie provided with PFXZCBCLUSA1 (by Pro-face) or other commercially available ties with a width of 4.8 mm (0.19 in) and thickness of 1.3 mm (0.05 in).</li> </ul>
4	<p>While pressing the grip on the clip, insert the cable from step 3 all the way into the USB host interface. Make sure that the clip tab is secured to the USB cable attached to this product.</p> 

## Removing USB Clamp Type A (1 port)

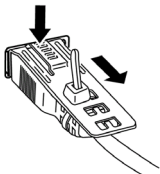
Step	Action
1	<p>Remove the USB cable while pushing the grip section of the clip.</p> 

## AUX Connector

# ⚠ DANGER

### ELECTRIC SHOCK

- Remove the AUX connector from this product prior to wiring.
- Strip wires only to the required length.
- Do not solder the wire itself.

**Failure to follow these instructions will result in death or serious injury.**

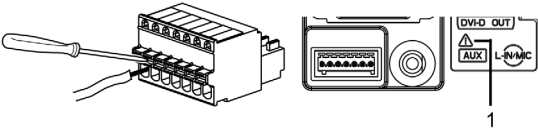
Step	Action
1	Insert the screwdriver into the opening button. This will open the wire's round-shaped hole.
2	Hold the screwdriver and insert the wire into the wire's round-shaped hole.
3	Take out the screwdriver from the opening button. The round-shaped hole will then close, and the wire will be held securely in place. To remove the wire, re-insert the screwdriver into the opening button and when the wire's spring clamp releases, pull the wire out.
	 <p>1 Safety alert symbol (see the following NOTE) (only for Open Box)</p>
4	Insert the wired AUX connector into the Auxiliary Output/Speaker Output Interface (AUX) of this product.

#### Recommendations:

- AUX Connector: PFXZCDCNAUX1 by Pro-face
- Screwdriver: SZS 0.4 X 2.0 (Product No. 1205202) manufactured by Phoenix Contact

If you use another manufacturer, be sure the part has the following dimensions:

- point depth: 0.4 mm (0.02 in)
- point height: 2.0 mm (0.08 in)

Point shape should have isolation properties meeting DIN 5264 and EN60900.

#### NOTE :

- Wire should be AWG 28 to AWG 20 thick and twisted.
- Applicable wire sizes are Style 1015 and Style 1007.
- Be sure to strip 8.0 mm (0.31 in) of cover from the wire.
- Use copper wire rated for 75 °C (167 °F).

## Cleaning This Product

### NOTICE

#### EQUIPMENT DAMAGE

- Power off this product before cleaning it.
- Do not use hard or pointed objects to operate the touch panel as you may damage the panel surface.
- Do not use paint thinner, organic solvents, or a strong acid compound to clean the unit.

**Failure to follow these instructions can result in equipment damage.**

When this product gets dirty, soak a soft cloth in water with a neutral detergent, wring the cloth tightly and wipe this product.

## Replacing the Battery

Open the Expansion Unit Interface Cover on the front of this product (see page 10 and 11) to replace the battery. Use only the replacement battery for this product (model number PFXZCBBT1).

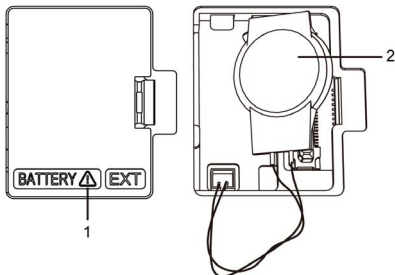

1 Safety alert symbol (see the safety messages as follows)

2 Battery

**⚠ ⚠ DANGER****HAZARD OF ELECTRIC SHOCK, EXPLOSION OR ARC FLASH**

- Remove all power from the device before removing any covers or elements of the system, and prior to installing or removing any accessories, hardware, or cables.
- Unplug the power cable from both this product and the power supply.
- Always use a properly rated voltage sensing device to confirm power is off.
- Replace and secure all covers or elements of the system before applying power to this product.
- Use only the specified voltage when operating this product. This product is designed to use 12 to 24 Vdc. Always check whether your device is DC powered before applying power.

**Failure to follow these instructions will result in death or serious injury.**

**⚠ DANGER****EXPLOSION, FIRE, OR CHEMICAL HAZARD**

- Use this product's replacement battery only.
- Do not cause a short circuit.
- Recycle or properly dispose of used batteries.

**Failure to follow these instructions will result in death or serious injury.**

**NOTICE****LOSS OF DATA**

- Before replacing the Battery for Memory Backup, supply power to the Box Module for 5 minutes or more.
- Replace the Battery for Memory Backup regularly every five years after you purchase this product.
- Allow only qualified personnel to change the Battery for Memory Backup.

**Failure to follow these instructions can result in equipment damage.**

## Standards

For information on certifications and standards, such as certified models and certificates, see the product markings or visit our website:

<http://www.pro-face.com/trans/en/manual/1002.html>

### DANGER

#### POTENTIAL FOR EXPLOSION

- Suitable for use in Class I, Division 2, Groups A, B, C, and D Hazardous Locations.
- Substitution of any component may impair suitability for Class I, Division 2.
- Do not disconnect equipment while the circuit is live or unless the area is known to be free of ignitable gases concentrations.
- Always confirm that this product is suitable for use in hazardous locations by checking that the ANSI/ISA 12.12.01 or CSA C22.2 N°213 certification appears on the product labeling.
- Do not attempt to install, operate, modify, maintain, service, or otherwise alter this product except as permitted in this manual. Unpermitted actions may impair the suitability of this product for Class I, Division 2 operation.
- To power on or power off this product installed in a Class I, Division 2 hazardous location, you must either:
  - Use a switch located outside the hazardous environment, or
  - Use a switch certified for Class I, Division 1 operation inside the hazardous area.
- Do not disconnect equipment unless power has been switched off or the area is known to be non-hazardous. This applies to all connections including power, ground, serial, parallel, and network connections.
- Never use unshielded/ungrounded cables in hazardous locations.
- When enclosed, keep enclosure doors and openings closed at all times to avoid the accumulation of foreign matter inside the workstation.

**Failure to follow these instructions will result in death or serious injury.**



The following message is for UL Hazardous Locations.

## DANGER

### RISQUE D'EXPLOSION

- Le remplacement de n'importe quel composant peut nuire à la conformité à la Classe I, Division 2.
- Avant de déconnecter l'équipement, couper le courant ou s'assurer que l'emplacement est désigné non dangereux.

**Le non-respect de ces instructions provoquera la mort ou des blessures graves.**

### Inquiry

Do you have any questions about difficulties with your unit?  
Please access our site any time that you need help with a solution.  
**<http://www.pro-face.com/trans/en/manual/1001.html>**

### Notes

Please be aware that Schneider Electric shall not be held liable by the user for any damages, losses, or third party claims arising from the uses of this product.