

MODBUS TCP Master Driver

1	System Configuration.....	3
2	External Devices Selection	6
3	Communication Settings	7
4	Setup Items	18
5	Supported Devices.....	24
6	Device Code and Address Code.....	28
7	Error Messages.....	29

Introduction

This manual describes how to connect the Display and the External Device (target PLC).

In this manual, the connection procedure is described in the sections identified below:

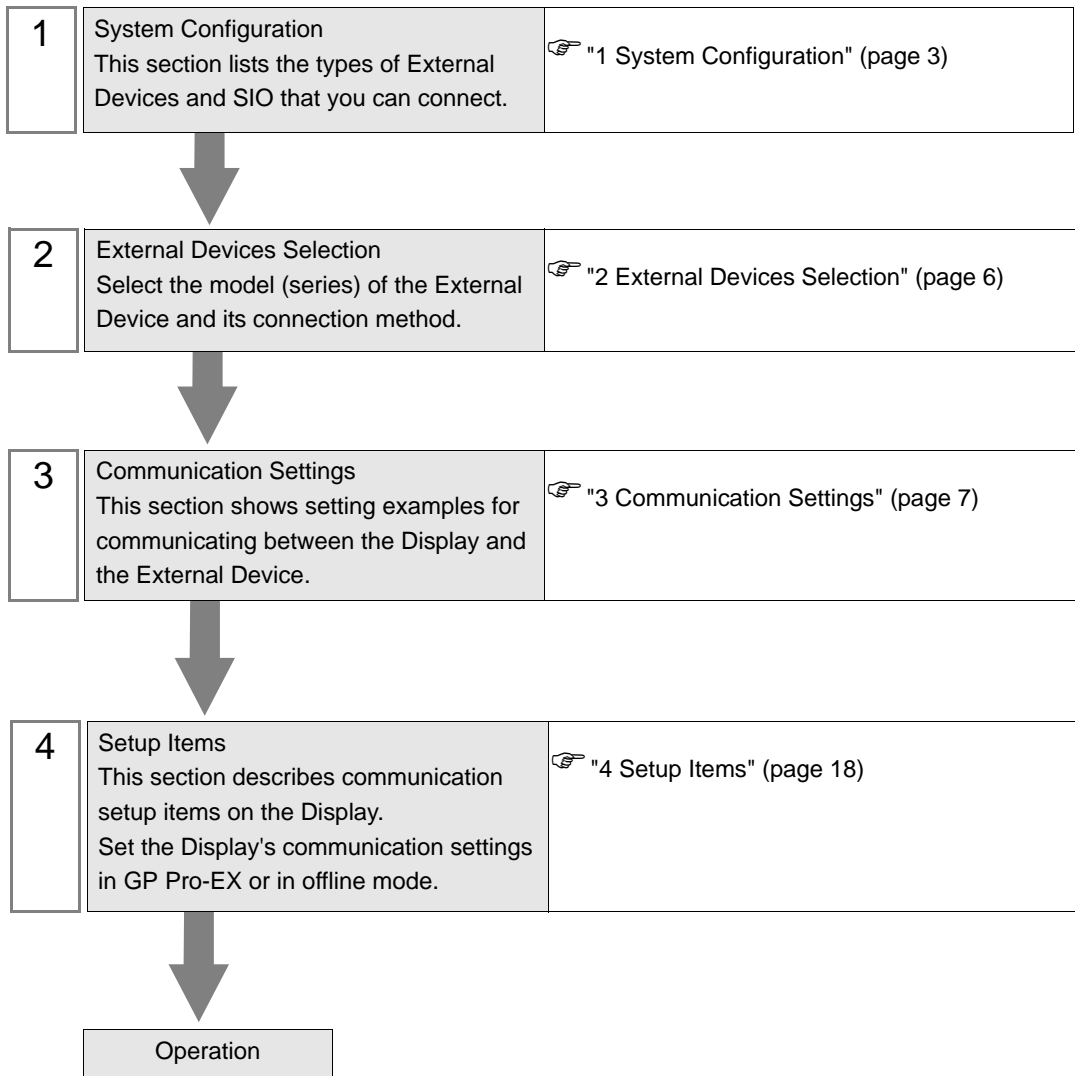

1 System Configuration

1.1 Schneider Electric SA External Devices

The following table lists system configurations for connecting Schneider Electric SA External Devices and the Display.

Driver	CPU	Link I/F	SIO Type	Setting Example
Premium	TSX P57 103M TSX P57 153M TSX P57 203M TSX P57 253M TSX P57 303M TSX P57 353M TSX P57 453M	TSX ETY 4102 TSX ETY 4103 TSX ETY 5102 TSX ETY 5103 TSX WMY 100 M	Ethernet (Modbus TCP)	Setting Example 1 (page 7)
	TSX P57 2623M TSX P57 2823M TSX P57 3623M TSX P57 4823M	-----		Setting Example 2 (page 9)
Quantum	140 CPU 113 02 140 CPU 113 03 140 CPU 434 12A 140 CPU 534 14A	140 NOE 771 00 140 NOE 771 10 140 NWM 100 00		Setting Example 3 (page 11)
	140 CPU 651 50 140 CPU 651 60	-----		Setting Example 4 (page 13)

■ Connection Configuration

- 1:1 Connection



- 1:n Connection

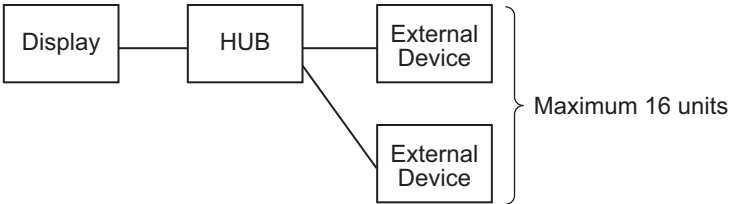

- n:1 Connection(PremiumSeries)

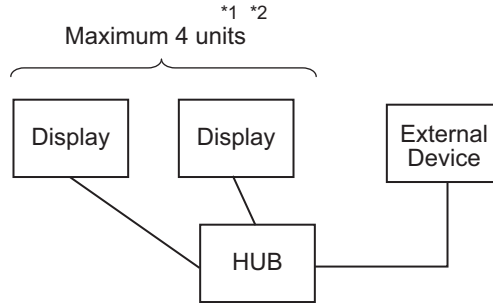

- *1 You can connect max 1 unit of TSXP571**/TSXP572**, max 3 units of TSXP573**, max 4 units of TSXP574**.
- *2 Number of connecting units is the unit number when connecting the Display only. Number of connecting Display will be limited by the number of other External Devices which is connected by Ethernet.

- n:1 Connection(Quantum Series)

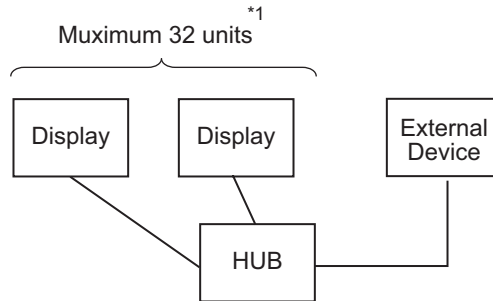

- *1 Number of connecting units is the unit number when connecting the Display only. Number of connecting Display will be limited by the number of other External Devices which is connected by Ethernet.

1.2 YOKOGAWA Electric Corporation External Devices

The following table lists system configurations for connecting YOKOGAWA Electric Corp. External Devices and the Display.

Driver	CPU	Link I/F	SIO Type	Setting Example
FCN	NFCP100-S00	Network interface on CPU	Ethernet (Modbus TCP)	Setting Example 5 (page 15)
FCJ	NFJT100-S100	Control network interface on the controller		Setting Example 5 (page 15)

■ Connection Configuration

- 1:1 Connection

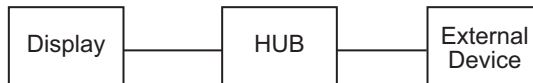

- 1:n Connection

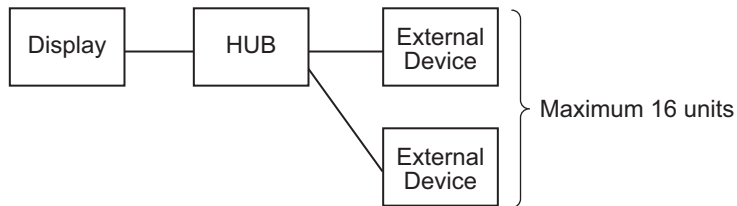

- n:1 Connection

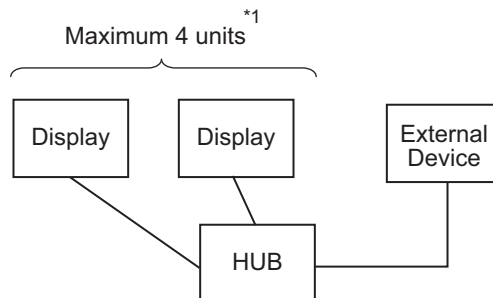

*1 Number of connecting units is the unit number when connecting the Display only. Number of connecting Display will be limited by the number of other External Devices which is connected by Ethernet.

2 External Devices Selection

Select the External Device to be connected to the Display.

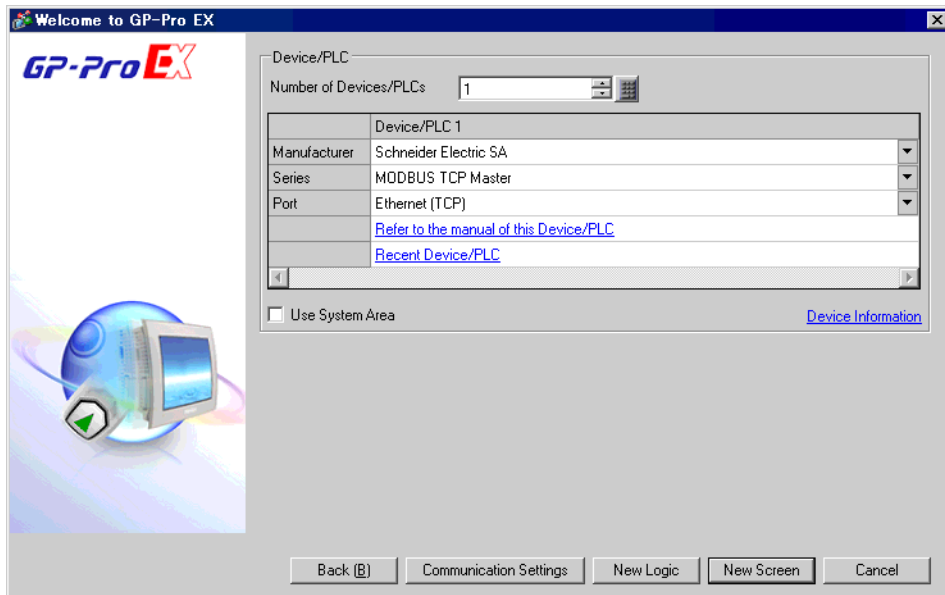

Setup Items	Setup Description
Number of Devices/PLCs	Enter an integer from 1 to 4 to define the number of Devices/PLCs to connect to the display.
Manufacturer	Select the manufacturer of the External Device to connect. Select "Schneider Electric SA".
Series	Select the External Device model (series) and the connection method. Select "MODBUS TCP Master". In System configuration, make sure the External Device you are connecting is supported by "MODBUS TCP Master". ☞ "1 System Configuration" (page 3)
Port	Select the Display port to connect to the External Device.
Use System Area	Check this option to synchronize the system data area of the Display and the device (memory) of the External Device. When synchronized, you can use the External Device's ladder program to switch the display or display the window on the Display. Cf. GP-Pro EX Reference Manual "LS Area (Direct Access Method Area)" This feature can also be set in GP-Pro EX or in the Display's offline mode. Cf. GP-Pro EX Reference Manual "System Settings [Display Unit] - [System Area] Settings Guide" Cf. Maintenance/Troubleshooting Guide "Main Unit - System Area Settings"

3 Communication Settings

This section provides examples of communication settings recommended by Pro-face for the Display and the External Device.

When you use the External Device, use GP-Pro EX and the ladder software to set as below.

3.1 Setting Example 1

■ Settings of GP-Pro EX

◆ Communication Settings

To display the setup screen, from the [Project] menu, point to [System Settings] and select [Device/PLC].

Device/PLC 1

Summary [Change Device/PLC](#)

Manufacturer Series Port

Text Data Mode [Change](#)

Communication Settings

Timeout (sec)

Retry

Wait To Send (ms)

Device-Specific Settings

Allowable Number of Devices/PLCs 16 [Add Device](#)

No.	Device Name	Settings
1	PLC1	IP Address=192.168.000.001,Port No.=502,Unit ID=255

◆ Device Setting

To display the [Individual Device Settings] dialog box, from [Device-Specific Settings] in the [Device/PLC] window, select the external device and click [Settings]  .

To connect multiple External Devices, from [Device-Specific Settings] in the [Device/PLC] window, click [Add Device] to add another External Device.

[Equipment Configuration]Tab

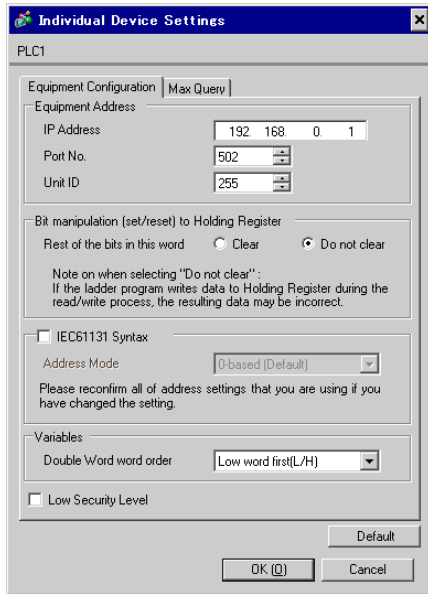

[Max Query] tab

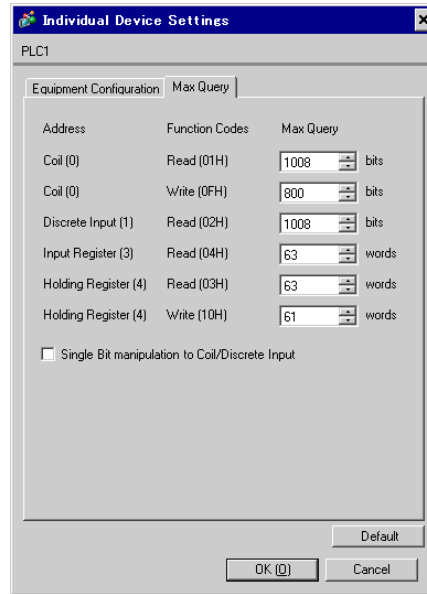

◆ Notes

- Check with the network administrator about the IP address. Do not duplicate IP addresses.
- Set IP address on the External Device for IP address in Device-specific settings.
- You need to set the IP address of the Display in its offline mode.

■ External Device Settings

Use the ladder software "PL7 PRO" for communication settings.

Execute "Hardware Configuration" from "Configuration" in "Application Browser" of "PL7 PRO" to display the "Configuration" dialog box. Double-click the empty slot to display the "Add Module" dialog box. Select "Communication" in the "Family" field. Then select "Link Unit" display in the "Module" field to display the screen for setting.

Setup Items	Setup Description
IP address configuration	Configured (Fixed)
IP address	Optional
Ethernet configuration	Ethernet II (Fixed)

◆ Notes

- Check with the network administrator about the IP address. Do not duplicate IP addresses.
- Please refer to the manual of the ladder software for details on other settings.

3.2 Setting Example 2

■ Settings of GP-Pro EX

◆ Communication Settings

To display the setup screen, from the [Project] menu, point to [System Settings] and select [Device/PLC].

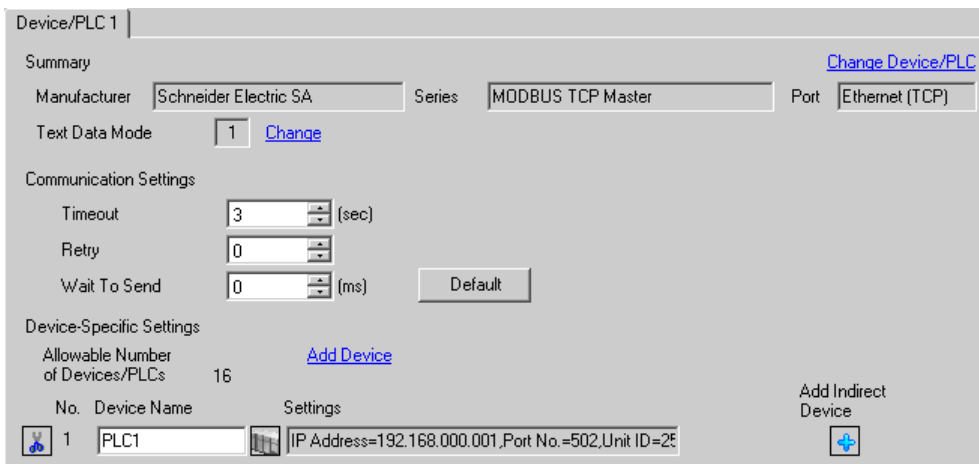

◆ Device Setting

To display the [Individual Device Settings] dialog box, from [Device-Specific Settings] in the [Device/PLC] window, select the external device and click [Settings] .

To connect multiple External Devices, from [Device-Specific Settings] in the [Device/PLC] window, click [Add Device] to add another External Device.

[Equipment Configuration]Tab

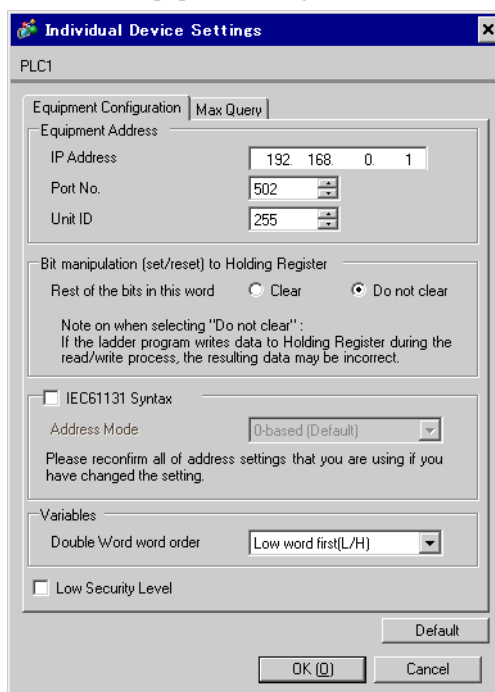

[Max Query] tab

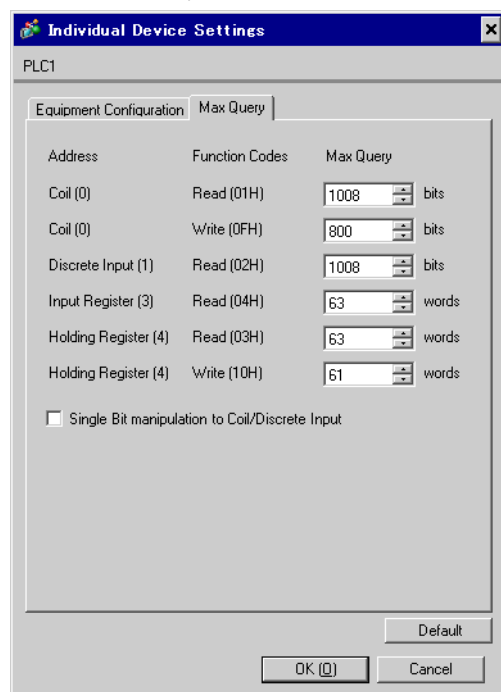

◆ Notes

- Check with the network administrator about the IP address. Do not duplicate IP addresses.
- Set the IP address of the External Device under [Individual Device Settings].
- You need to set the IP address of the Display in its offline mode.

■ External Device Settings

Use the ladder software "PL7 PRO" for communication settings.

For setting, go to "Configuration" in "Application Browser" of "PL7 PRO", "Hardware Configuration", and "ETY PORT" in this order.

Setup Items	Setup Description
IP address configuration	Configured (Fixed)
IP address	Optional
Ethernet configuration	Ethernet II (Fixed)

◆ Notes

- Check with the network administrator about the IP address. Do not duplicate IP addresses.
- Please refer to the manual of the ladder software for details on other settings.

3.3 Setting Example 3

■ Settings of GP-Pro EX

◆ Communication Settings

To display the setup screen, from the [Project] menu, point to [System Settings] and select [Device/PLC]..

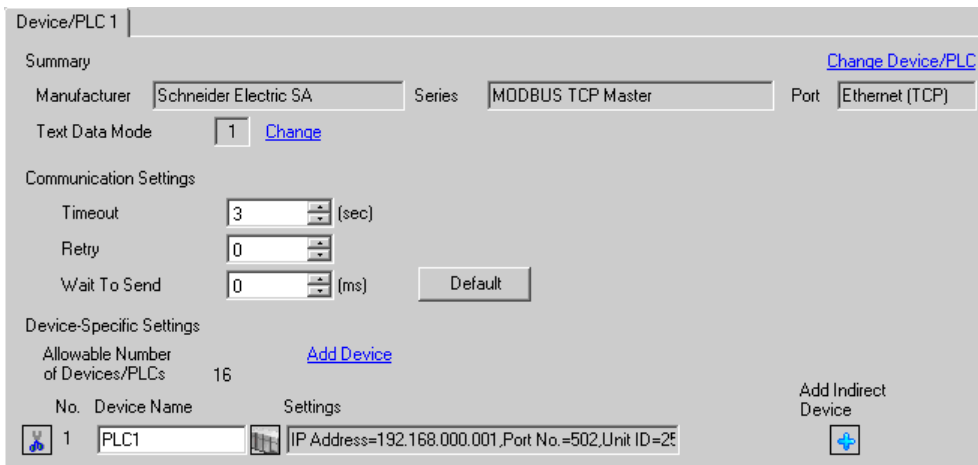

◆ Device Setting

To display the [Individual Device Settings] dialog box, from [Device-Specific Settings] in the [Device/PLC] window, select the external device and click [Settings] .

To connect multiple External Devices, from [Device-Specific Settings] in the [Device/PLC] window, click [Add Device] to add another External Device.

[Equipment Configuration] tab

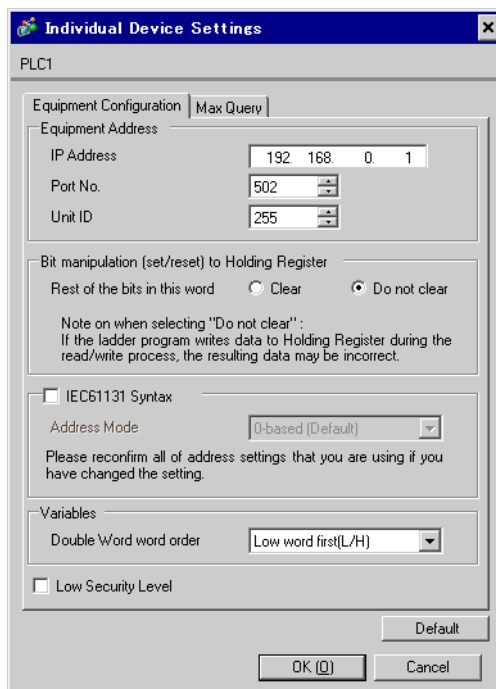

[Max Query] tab

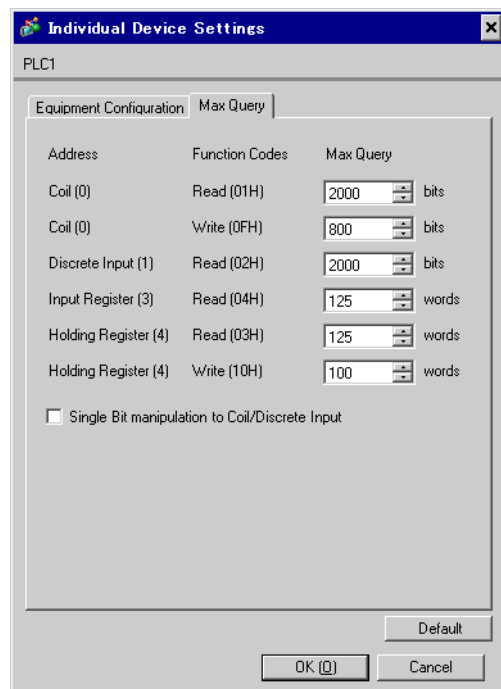

◆ Notes

- Check with the network administrator about the IP address. Do not duplicate IP addresses.
- Set the IP address of the External Device under [Individual Device Settings].
- You need to set the IP address of the Display in its offline mode.

■ External Device Settings

Use the ladder software "Concept" for communication settings.

After selecting PLC for the Quantum Series in "PLC Selection" of "Concept", select "Select Extensions" from "Config Extension". Set the number of Link Unit connected to "TCP/IP Ethernet" in the "Select Extensions" dialog box displayed next. Then, select "Ethernet /I/O Scanner" in "Config Extensions" and perform setting in the "Ethernet /I/O Scanner" dialog box.

Setup Items	Setup Description
Ethernet configuration	Specify IP Address (Fixed)
Internet Address	Optional
Frame Type	Ethernet II (Fixed)

◆ Notes

- Check with the network administrator about the IP address. Do not duplicate IP addresses.
- Please refer to the manual of the ladder software for details on other settings.

3.4 Setting Example 4

■ Settings of GP-Pro EX

◆ Communication Settings

To display the setup screen, from the [Project] menu, point to [System Settings] and select [Device/PLC].

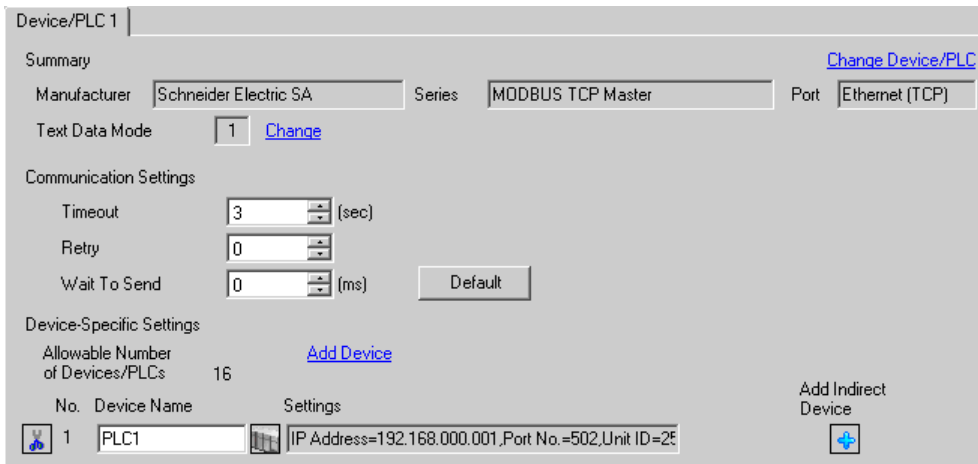

◆ Device Setting

To display the [Individual Device Settings] dialog box, from [Device-Specific Settings] in the [Device/PLC] window, select the external device and click [Settings] .

To connect multiple External Devices, from [Device-Specific Settings] in the [Device/PLC] window, click [Add Device] to add another External Device.

[Equipment Configuration] tab

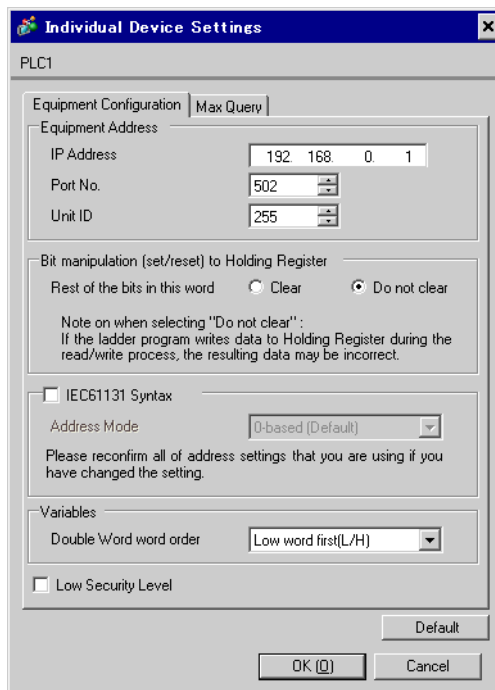

[Max Query] tab

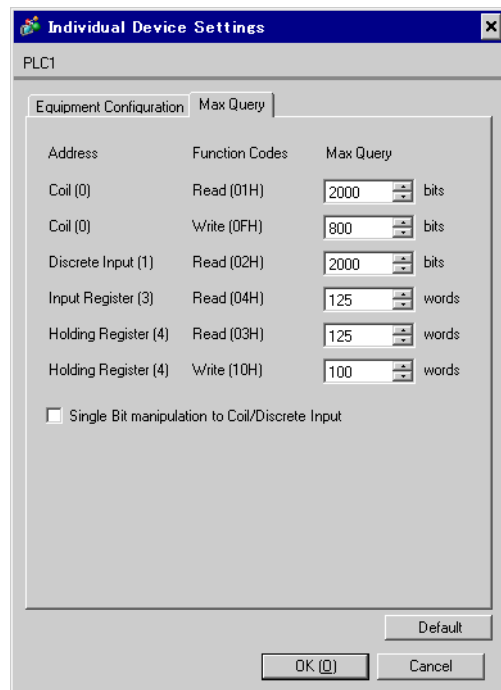

◆ Notes

- Check with the network administrator about the IP address. Do not duplicate IP addresses.
- Set the IP address of the External Device under [Individual Device Settings].
- You need to set the IP address of the Display in its offline mode.

■ External Device Settings

Use the ladder software "Unity Pro XL" for communication settings.

Startup "Unity Pro XL". Select "New Project" and specify CPU (Quantum Series, 140 CPU 651 *0). Go to "Communication" in "Project Browser", and right-click on "Network" to select "New Network...". Then the Add Network window is displayed.

Set "List of available Networks" in the "Add Network" window to "Ethernet". Put the optional name in "Change Name" and press OK.

Check that the name you put in "Change Name" is displayed under "Network", "Communication" of "Project Browser". Double-click the displayed name to display the "(Your optional name) window" for setting.

Setup Items	Setup Description
IP address configuration	Configured (Fixed)
IP address	Optional
Ethernet configuration	Ethernet II (Fixed)

◆ Notes

- Check with the network administrator about the IP address. Do not duplicate IP addresses.
- Please refer to the manual of the ladder software for details on other settings.

3.5 Setting Example 5

■ Settings of GP-Pro EX

◆ Communication Settings

To display the setup screen, from the [Project] menu, point to [System Settings] and select [Device/PLC]..

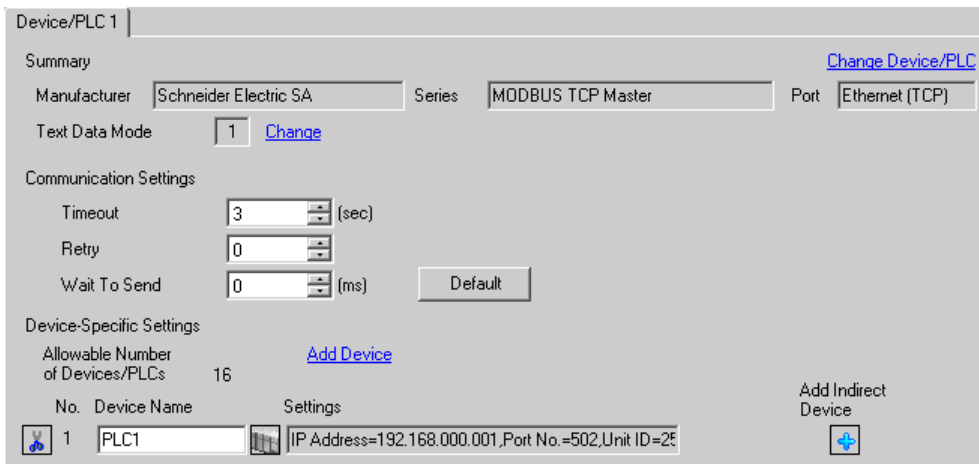

◆ Device Setting

To display the [Individual Device Settings] dialog box, from [Device-Specific Settings] in the [Device/PLC] window, select the external device and click [Settings] .

To connect multiple External Devices, from [Device-Specific Settings] in the [Device/PLC] window, click [Add Device] to add another External Device.

[Equipment Configuration] tab

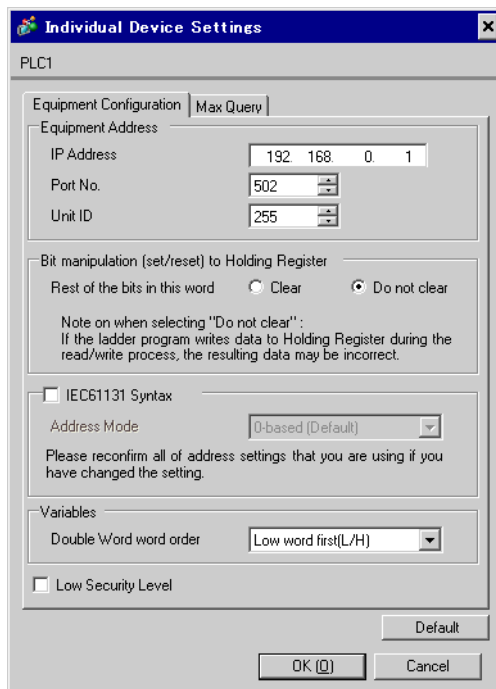

[Max Query] tab

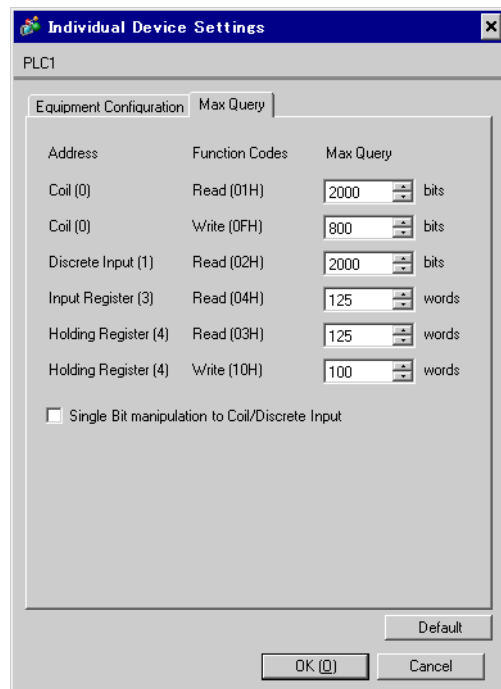

◆ Notes

- Check with the network administrator about the IP address. Do not duplicate IP addresses.
- Set the IP address of the External Device under [Individual Device Settings].
- You need to set the IP address of the Display in its offline mode.

■ External Device Settings

Use the ladder software (Logic Designer) for communication settings. Refer to your External Device manual for details.

- 1 Start up the ladder software.
- 2 To start the MODBUS communication (RTU mode) slave function, create the control logic. For the example of control logic, refer to "Control Logic Example".
 ☞ ◆ Control Logic Example (page 16)
- 3 Select [Rebuild Project] from the [Build] menu.
- 4 Double-click [Target Setting] in the project tree Window to display the [Target] dialog box.
- 5 Enter "192.168.0.1" in [Host Name/IP Address].
- 6 Click [OK].
- 7 Download the communication settings to the External Device.
- 8 Reboot the External Device.

◆ Control Logic Example

To connect the Display to the External Device, the control logic is required.

The control logic example is shown below.

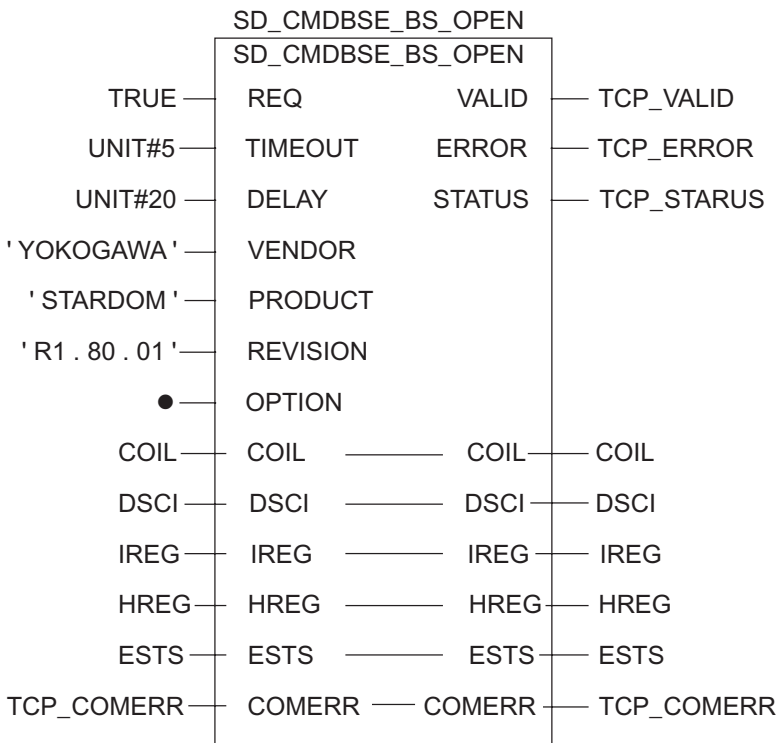

◆ Notes

- Check with the network administrator about the IP address. Do not duplicate IP addresses.
- Please refer to the manual of the ladder software for details on other settings.

4 Setup Items

Set up the Display's communication settings in GP Pro-EX or in the Display's offline mode.

The setting of each parameter must match that of the External Device.

 "3 Communication Settings" (page 7)

NOTE

- You need to set the IP address of the Display in its offline mode.

Cf. Maintenance/Troubleshooting Guide "Ethernet Settings"

4.1 Setup Items in GP-Pro EX

■ Communication Settings

To display the setup screen, from the [Project] menu, point to [System Settings] and select [Device/PLC].

Setup Items	Setup Description
Timeout	Use an integer from 1 to 127 to enter the time (s) for which the Display waits for the response from the External Device.
Retry	In case of no response from the External Device, use an integer from 0 to 255 to enter how many times the Display retransmits the command.
Wait To Send	Use an integer from 0 to 255 to enter standby time (ms) for the Display from receiving packets to transmitting the next commands.

NOTE

- Refer to the GP-Pro EX Reference Manual for Indirect Device.

Cf. GP-Pro EX Reference Manual "Changing the Device/PLC at Runtime (Indirect Device)"

■ Device Setting

To display the [Individual Device Settings] dialog box, from [Device-Specific Settings] in the [Device/PLC] window, select the external device and click [Settings]  .

To connect multiple External Devices, from [Device-Specific Settings] in the [Device/PLC] window, click [Add Device] to add another External Device.

[Equipment Configuration]Tab

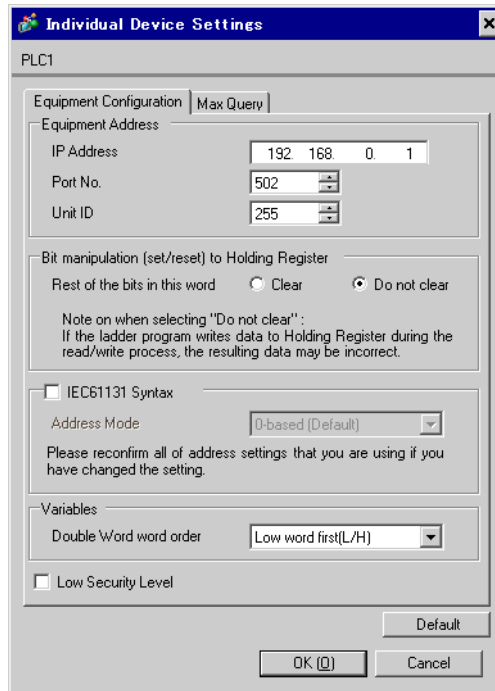

Setup Items	Setup Description
IP Address	Set IP address of the External Device. NOTE <ul style="list-style-type: none"> Check with the network administrator about the IP address. Do not duplicate IP addresses.
Port No.	Use an integer from "1 to 65535" to enter the port No. of the External Device.
Unit ID	Use an integer from 1 to 247 to enter the unit ID of the External Device.
Bit manipulation (set/reset) to Holding Register Other bits in this word	Select how other bits in the same word are handled when you manipulate bits in the holding register, from "Clear" or "Do not clear".
IEC61131 Syntax	Check this item when you use the IEC61131 grammar for variables. If you check this item, select the address mode from [0-based] or [1-based].
Double Word word order	Select the order of checking double word data from "Low word first" or "High word first".
Low Security Level	Check this option to decrease the format check level.

[Max Query] tab

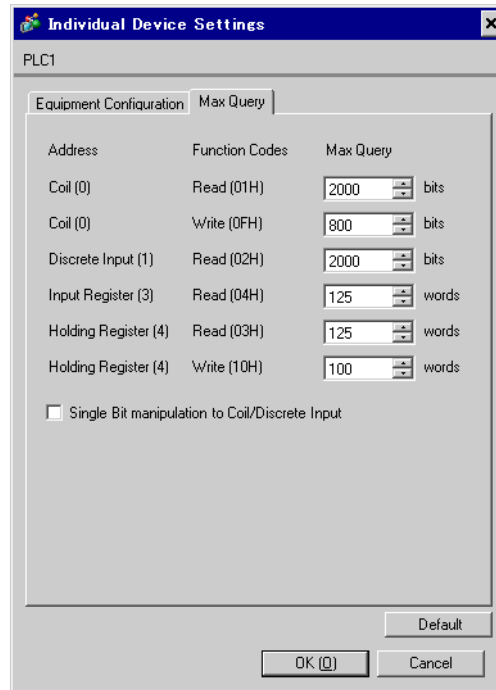

Setup Items	Setup Description
Coil Read	Set the number of max data for device [coil] that can be read for one communication, using 16 to 2000 bits. NOTE • If you check [Single Bit Manipulation in Coil/Discrete Input], set the max query using 1 to 2000.
Coil Write	Set the number of max data for device [coil] that can be written for one communication, using 1 to 800 bits.
Discrete Input Read	Set the number of max data for device [discrete input] that can be read for one communication, using 16 to 2000 bits. NOTE • If you check [Single Bit Manipulation in Coil/Discrete Input], set the max query using 1 to 2000.
Input Register Read	Set the number of max data for device [input register] that can be read for one communication, using 1 to 125 words.
Holding Register Read	Set the number of max data for device [holding register] that can be read for one communication, using 1 to 125 words.
Holding Register Write	Set the number of max data for device [holding register] that can be written for one communication, using 1 to 100 words.
Single Bit manipulation to Coil/Discrete Input	Check this option to read or write the coil or discrete input in bit units.

4.2 Setup Items in Offline Mode

NOTE

- Refer to the Maintenance/Troubleshooting manual for information on how to enter offline mode or about the operation.
- Cf. Maintenance/Troubleshooting Guide "Offline Mode"
- The number of the setup items to be displayed for 1 page in the offline mode depends on the Display in use. Please refer to the Reference manual for details.

■ Communication Settings

To display the setting screen, touch [Device/PLC Settings] from [Peripheral Equipment Settings] in offline mode. Touch the External Device you want to set from the list that appears.

Comm.	Device			
MODBUS TCP Master		[TCP]	Page 1/1	
Timeout(s)		3	▼	▲
Retry		0	▼	▲
Wait To Send(ms)		0	▼	▲
Exit		Back		2007/07/23 14:44:17

Setup Items	Setup Description
Timeout	Use an integer from 1 to 127 to enter the time (s) for which the Display waits for the response from the External Device.
Retry	In case of no response from the External Device, use an integer from 0 to 255 to enter how many times the Display retransmits the command.
Wait To Send	Use an integer from 0 to 255 to enter standby time (ms) for the Display from receiving packets to transmitting the next commands.

■ Device Setting

To display the setting screen, touch [Device/PLC Settings] from [Peripheral Equipment Settings]. Touch the External Device you want to set from the displayed list, and touch [Device].

(1/2)

Comm.	Device			
MODBUS TCP Master		[TCP]	Page 1/2	
Device/PLC Name <input type="text" value="PLC1"/>				
IP Address		<input type="text" value="192"/> <input type="text" value="168"/> <input type="text" value="0"/> <input type="text" value="1"/>		
Port No.		<input type="text" value="502"/>	▼ ▲	
Unit ID		<input type="text" value="255"/>	▼ ▲	
Bit manipulation to HR		Rest of bits in word are not cleared		
IEC61131 Syntax		OFF		
Double Word word order		Low word first		
Low Security Level		OFF		
				➔
Exit		Back		2007/07/23 14:44:22

Setup Items	Setup Description
Device/PLC Name	Select the External Device to set. Device/PLC name is the title of the External Device set with GP-Pro EX.(Initial value [PLC1])
IP Address	Set IP address of the External Device. NOTE <ul style="list-style-type: none"> Check with the network administrator about the IP address. Do not duplicate IP addresses.
Port No.	Use an integer from "1 to 65535" to enter the port No. of the External Device.
Unit ID	Use an integer from 1 to 247 to enter the unit ID of the External Device.
Bit manipulation to HR	Indicates how other bits in the same word are handled when you manipulate bits in the holding register, by "Rest of bits in word are cleared" or "Rest of bits in word are not cleared".(Not available to set in offline mode.)
IEC61131 Syntax	Indicates the usage status of the currently set IEC61131 syntax by ON/OFF. (Not available to set in offline mode.)
Double Word word order	Indicates the currently set order of storing double word data displaying "Low word first" or "High word first". (Not available to set in offline mode.)
Low Security Level	Indicates whether the format check level is decreased by ON/OFF. If decreased, ON is displayed. (Not available to set in offline mode.)

(2/2)

Comm.	Device			
MODBUS TCP Master		[TCP]	Page 2/2	
Device/PLC Name <input type="text" value="PLC1"/>				
Max Query				
Read Coil	2000 bits			
Write Coil	800 bits			
Read Discrete Input	2000 bits			
Read Input Register	<input type="text" value="125"/>	▼	▲	
Read Holding Register	<input type="text" value="125"/>	▼	▲	
Write Holding Register	<input type="text" value="100"/>	▼	▲	
Single Bit manipulation OFF				
				
Exit		Back		2007/07/23 14:44:26

Setup Items	Setup Description
Device/PLC Name	Select the External Device to set. Device/PLC name is the title of the External Device set with GP-Pro EX.(Initial value [PLC1])
Read Coil	Displays the number of max data for device [coil] that can be read for one communication.(Not available to set in offline mode.)
Write Coil	Displays the number of max data for device [coil] that can be written for one communication.(Not available to set in offline mode.)
Read Discrete Input	Displays the number of max data for device [discrete input] that can be read for one communication.(Not available to set in offline mode.)
Read Input Register	Set the number of max data for device [input register] that can be read for one communication, using 1 to 125 words.
Read Holding Register	Set the number of max data for device [holding register] that can be read for one communication, using 1 to 125 words.
Write Holding Register	Set the number of max data for device [holding register] that can be written for one communication, using 1 to 100 words.
Single Bit manipulation	Indicates whether to read or write the coil or discrete input in bit units by displaying ON/OFF. If ON is displayed, you can read or write in bit units. (Not available to set in offline mode.)

5 Supported Devices

The following table shows the range of supported device addresses. Please note that the actual supported range of the devices varies depending on the External Device to be used. Please check the actual range in the manual of your External Device.

■ Premium/Quantum Series

 : This address can be specified as system data area.

Device	Bit Address	Word address	32 bits	Remarks
Coil	000001 - 065536	000001 - 065521		+1B+ 1
Discrete Input	100001 - 165536	100001 - 165521	L / H	+1B+ 1 *2
Input Register	-----	300001 - 365536	or H / L	B i t 15 *2
Holding Register	400001,0 - 465536,15 ^{*3}	400001 - 465536	*1	B i t 15

*1 You can set the data storing order in word unit of 32-bit data in the Device Setting dialog box.

*2 Write disabled.

*3 An access method at the time of Bit Set varies depending on the [Rest of the bits in this word] setting of [Device Setting].

- Clear..... B i t 15

- Do not clear400001,00 - 465536,15

■ FCN/FCJ Series

 : This address can be specified as system data area.

Device	Bit Address	Word address	32 bits	Remarks
Coil	000001 - 009984	000001 - 009969		+16+ 1 *2
Discrete Input	100001 - 109984	100001 - 109969	L/H	+16+ 1 *2 *3
Input Register	300001.00 - 309999.15	300001 - 309999	or	Bit 15 *3
Holding Register	400001.00 - 409999.15 *4	400001 - 409999	H/L *1	Bit 15

- *1 You can set the data storing order in word unit of 32-bit data in the Device Setting dialog box.
- *2 The device access range of the External Device is specified as 1 to 9999, that of the Display, however, as up to 9984, since the Display device is accessible in 16-bit units.
- *3 Write disabled.
- *4 An access method at the time of Bit Set varies depending on the [Rest of the bits in this word] setting of [Device Setting].
 - Clear..... Bit 15
 - Do not clear400001,00 - 409999,15

■ Supported Function Codes

The supported function code list is shown below.

Function Code (Hex)	Description
FC01(0x01)	Read the ON/OFF status of the slave coil (0X).
FC02(0x02)	Read the ON/OFF status of the slave discrete input (1X).
FC03(0x03)	Read the description of the slave holding register (4X).
FC04(0x04)	Read the description of the slave input register (3X).
FC05(0x05)	Change (Write) the slave coil (0X) status to either ON or OFF.
FC06(0x06)	Change (write) the description of the slave holding register (4X).
FC15(0x0F)	Change (Write) the slave consecutive multiple coils (0X) status to either ON or OFF.
FC16(0x10)	Change (write) the descriptions of the slave consecutive multiple holding registers (4X).

NOTE • FC15/FC16 are used for writing. FC05/FC06 are used for the External Devices that do not support the function codes mentioned on the left.

■ IEC61131 Syntax Address Description

The following table shows the equivalence between IEC61131 syntax and MODBUS syntax address descriptions.

Device	MODBUS Syntax			IEC61131 Syntax				
	Format	Range	First element	Format	0 start		1 start	
					Range	First element	Range	First element
Coil	000001+i	i = 0 to 65535	000001	%Mi	i = 0 to 65535	%M00000	i = 1 to 65536	%M00001
Discrete Input	100001+i	i = 0 to 65535	100001	-	-	-	-	-
Input Register (Word)	300001+i	i = 0 to 65535	300001	-	-	-	-	-
Input Register (Word bit)	300001+i,j	i = 0 to 65535 j = 0 to 15	300001,0 0	-	-	-	-	-
Holding Register (Word)	400001+i	i = 0 to 65535	400001	%MWi	i = 0 to 65535	%MW00000	i = 1 to 65536	%MW00001
Holding Register (Word bit)	400001+i,j	i = 0 to 65535 j = 0 to 15	400001,0 0	%Mwi:X j	i = 0 to 65535 j=0 to 15	%MW00000: X00	i = 1 to 65535 j=0 to 15	%MW00001 :X00

NOTE • The addresses 100000 and 300000 cannot be accessed using IEC61131 syntax.
• If you apply IEC61131 syntax to a project that has a discrete input or input register already set, the addresses become "-Undefined-".

NOTE

- For system data area, refer to the GP-Pro EX Reference Manual.

Cf. GP-Pro EX Reference Manual "LS Area (Direct Access Method Area)"

- Refer to the precautions on manual notation for icons in the table.

 "Manual Symbols and Terminology"

6 Device Code and Address Code

Use device code and address code when you set "Device Type & Address" for the address type of the data display or other devices.

■ Premium/Quantum Series

Device	Device Name	Device Code (HEX)	Address Code
Coil	0	0080	Value of (word address - 1) divided by 16
Discrete Input	1	0081	Value of (word address - 1) divided by 16
Input Register	3	0001	Value of (word address - 1)
Holding Register	4	0000	Value of (word address - 1)

■ FCN/FCJ Series

Device	Device Name	Device Code (HEX)	Address Code
Coil	0	0080	Value of (word address - 1) divided by 16
Discrete Input	1	0081	Value of (word address - 1) divided by 16
Input Register	3	0001	Value of (word address - 1)
Holding Register	4	0000	Value of (word address - 1)

7 Error Messages

Error messages are displayed on the screen of the Display as follows: "No. : Device Name: Error Message(Error Occurrence Area)". Each description is shown below.

Item	Description
No.	Error No.
Device Name	Name of the External Device where an error has occurred. Device/PLC name is the title of the External Device set with GP-Pro EX.(Initial value [PLC1])
Error Message	Displays messages related to an error that has occurred.
Error Occurrence Area	<p>Displays the IP address or device address of the External Device where an error has occurred, or error codes received from the External Device.</p> <p>NOTE</p> <ul style="list-style-type: none"> • IP addresses are displayed as "IP address (Decimal): MAC address (Hex)". • Device addresses are displayed as "Address: Device address". • Received error codes are displayed as "Decimal [Hex]".

Display Examples of Error Messages

"RHAA035: PLC1: Error has been responded for device write command (Error Code: 2[02H])"

NOTE

- Refer to your External Device manual for details on received error codes.
- Refer to "Display-related errors" in "Maintenance/Troubleshooting Guide" for details on the error messages common to the driver.

