

# Q/QnA Series Ethernet Driver

1	System Configuration.....	3
2	Selection of External Device .....	8
3	Example of Communication Setting.....	9
4	Setup Items.....	29
5	Supported Device.....	37
6	Device Code and Address Code.....	45
7	Error Messages.....	50

## Introduction

This manual describes how to connect the display and the External Device (target PLC).

In this manual, the connection procedure will be described by following the below sections:

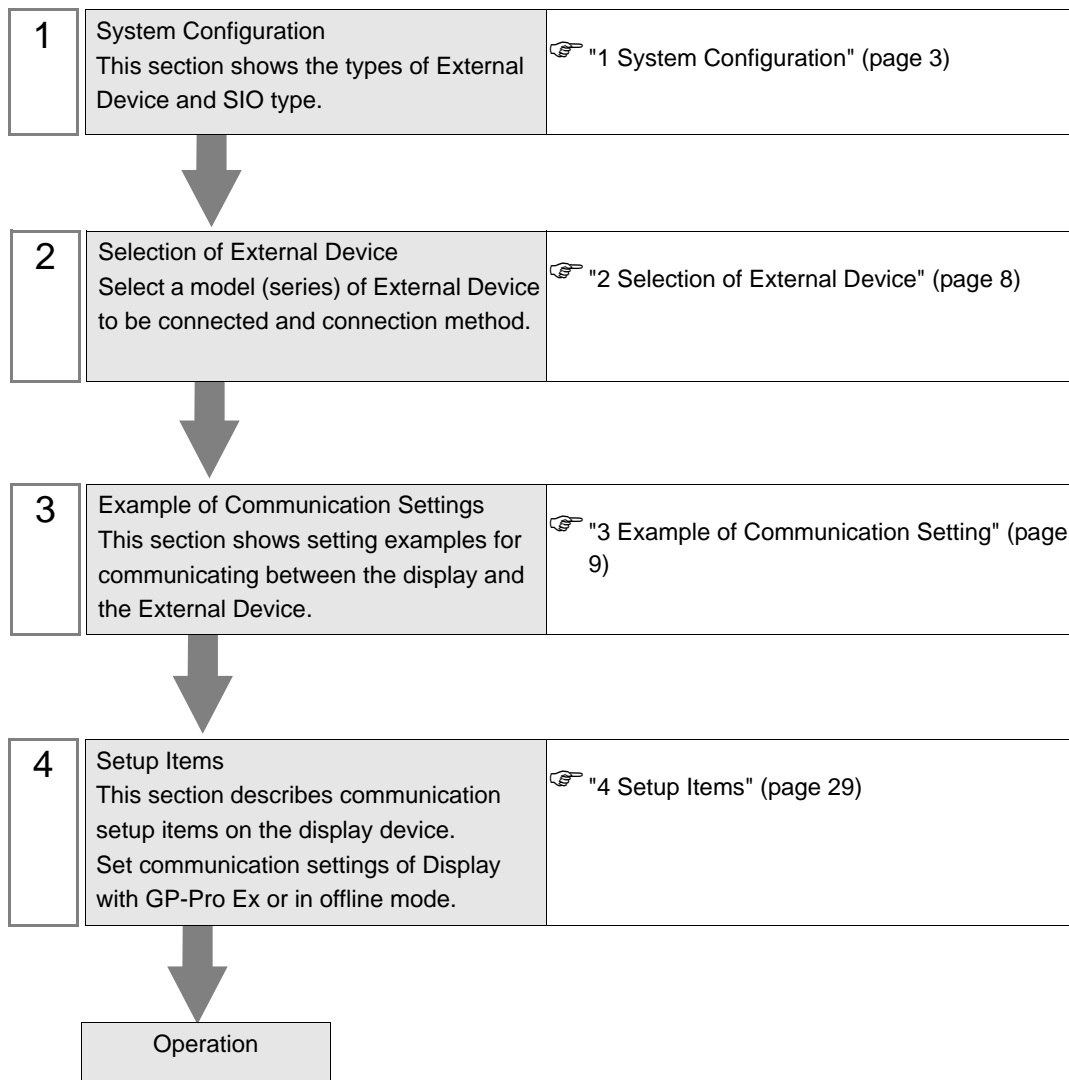

# 1 System Configuration

The system configuration in the case when the External Device of Mitsubishi Electric Corp. and the display are connected is shown.

Series	CPU	Link I/F	SIO Type	Setting Example
MELSEC Q Series	Q00CPU Q00JCPU Q01CPU Q02CPU Q02HCPU Q06HCPU Q12HCPU Q25HCPU Q03UDECPU Q04UDEHCPU Q06UDEHCPU Q13UDEHCPU Q26UDEHCPU	QJ71E71	Ethernet (UDP)	Setting Example 1 (page 9)
			Ethernet (TCP)	Setting Example 2 (page 13)
		QJ71E71-B2	Ethernet (UDP)	Setting Example 1 (page 9)
			Ethernet (TCP)	Setting Example 2 (page 13)
		QJ71E71-B5	Ethernet (UDP)	Setting Example 1 (page 9)
			Ethernet (TCP)	Setting Example 2 (page 13)
		QJ71E71-100	Ethernet (UDP)	Setting Example 1 (page 9)
			Ethernet (TCP)	Setting Example 2 (page 13)
	Q02UCPU Q03UDCPU Q04UDHCPU Q06UDHCPU Q13UDHCPU Q26UDHCPU	QJ71E71-B2	Ethernet (UDP)	Setting Example 1 (page 9)
			Ethernet (TCP)	Setting Example 2 (page 13)
		QJ71E71-B5	Ethernet (UDP)	Setting Example 1 (page 9)
			Ethernet (TCP)	Setting Example 2 (page 13)
		QJ71E71-100	Ethernet (UDP)	Setting Example 1 (page 9)
			Ethernet (TCP)	Setting Example 2 (page 13)

Continued to next page.

Series	CPU	Link I/F	SIO Type	Setting Example
MELSEC QnA Series	Q2ACPU Q2ACPU-S1 Q3ACPU Q4ACPU Q4ARCPU	AJ71QE71	Ethernet (UDP)	Setting Example 3 (page 17)
			Ethernet (TCP)	Setting Example 4 (page 20)
		AJ71QE71-B5	Ethernet (UDP)	Setting Example 3 (page 17)
			Ethernet (TCP)	Setting Example 4 (page 20)
	Q2ASCPU Q2ASHCPU Q2ASCPU-S1 Q2ASHCPU-S1	A1SJ71QE71-B2	Ethernet (UDP)	Setting Example 3 (page 17)
			Ethernet (TCP)	Setting Example 4 (page 20)
		A1SJ71QE71-B5	Ethernet (UDP)	Setting Example 3 (page 17)
			Ethernet (TCP)	Setting Example 4 (page 20)
MELSEC L Series	L02CPU L26CPU-BT	Ethernet port on CPU unit	Ethernet (UDP)	Setting Example 5 (page 23)
			Ethernet (TCP)	Setting Example 6 (page 26)

**IMPORTANT** • When you open the project file (which has been created with the Ver.1.12.04 or earlier Q/QnA series Ethernet driver) with GP-Pro EX where Ver.1.12.05 or later driver is installed, the [Multiple CPU system] checkbox in the [Basic] tab is checked. Specify [Multiple CPU system] according to the environment you use.

☞ " ■ Device Setting" (page 30)

- You can confirm the driver version using GP-Pro EX as follows:  
From [System Setting window] in the workspace, select [Peripheral List] to display the version.

**NOTE** • The time of GP4000 series can be automatically updated in [Clock Update Settings] of GP-Pro EX, if you set the External Device bit address SM213 to ON.  
For details on [Clock Update Settings], refer to GP-Pro EX Reference Manual.

## ■ Connection Configuration

- 1:1 Connection

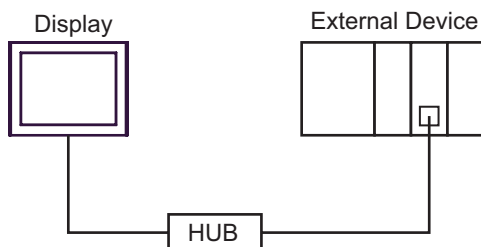

- 1:n Connection (when access station is source station)

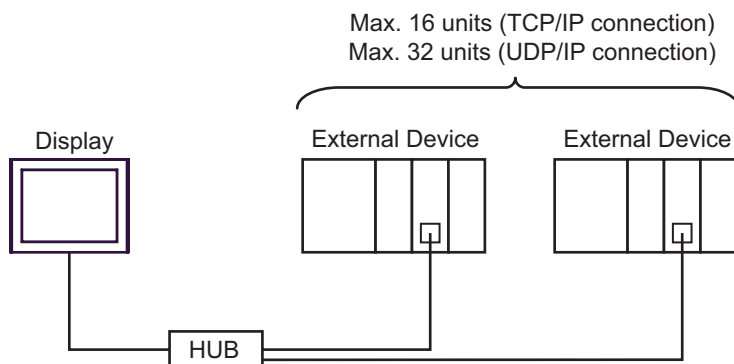

- 1:n Connection (access beyond network)

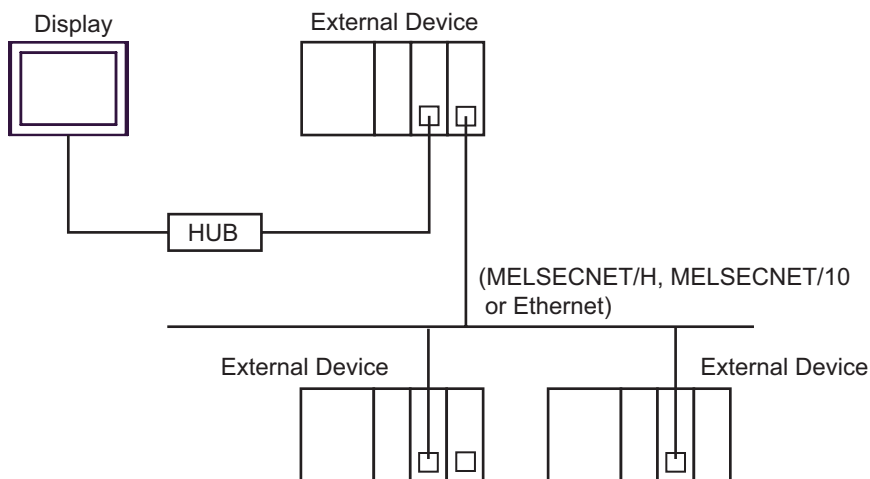

### NOTE

- In case of communication via network, please set larger value than the response monitoring time of the relay station for timeout settings.

Setting examples for access beyond the network are shown below. Check the details of the setup items in "Setup Item."

☞ "4 Setup Items" (page 29)

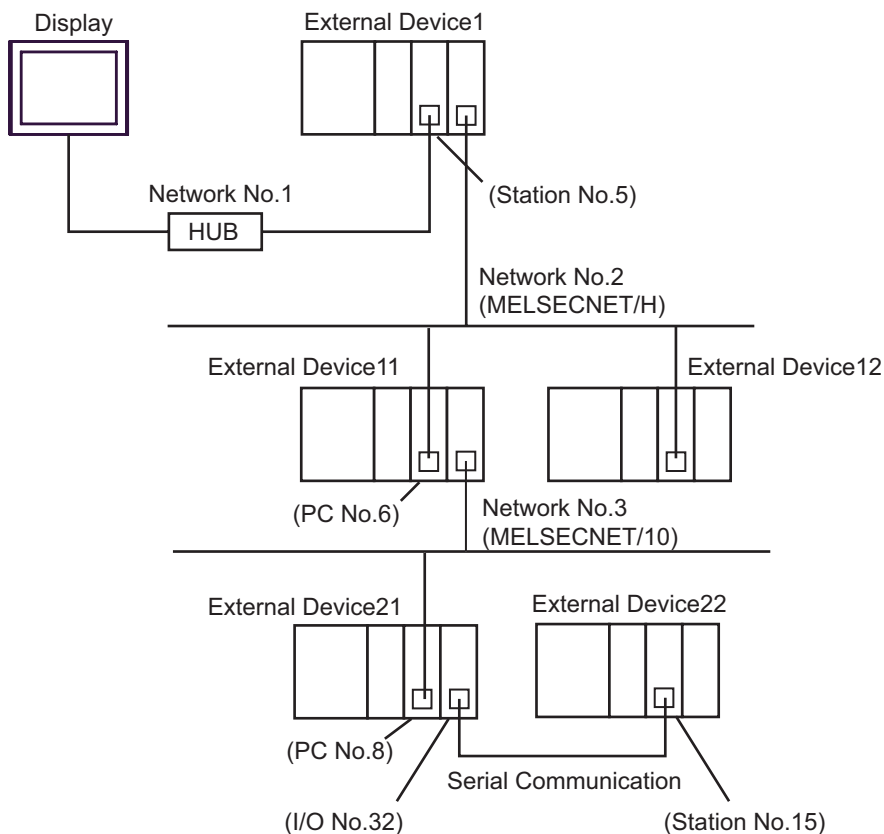

External Device to be Accessed	Port No.	Station No.	Network No.	PC No.	Request destination module I/O No.	Request destination module Station No.
External Device 1	1025	5	0	255	1023	0
External Device 11	1026	5	2	6	1023	0
External Device 22	1027	5	3	8	32	15

- n : 1 Connection

MELSEC-Q Series : Max. 16 units \*1  
 MELSEC-QnA Series : Max. 8 units \*2  
 MELSEC-L Series : Max. 16 units

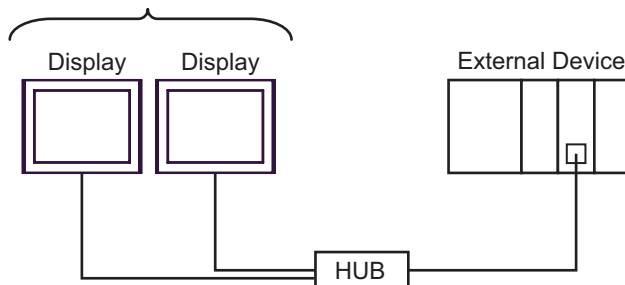

- \*1 When transmitting data via the External Device's OPEN Setting feature instead of the Auto OPEN UDP Port feature, up to 16 Display units can be connected. Also, when using the External Device's Auto Open UDP Port feature, there is no limitation for the number of Display units that can be connected.
- \*2 When transmitting data via the External Device's parameter setting instead of the Auto OPEN UDP Port feature, up to 8 Display units can be connected. Also, when using the External Device's Auto Open UDP Port feature, there is no limitation for the number of Display units that can be connected.

- Multi CPU System

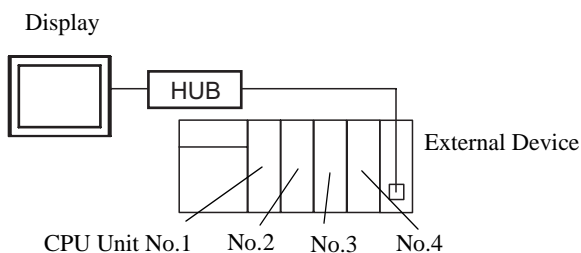
**NOTE**

- For CPU's Unit No., No.1 is allocated to the CPU slot and No.2, 3, and 4 are allocated to the other slots from No.1 to right.
- With Multi CPU System, it's possible to access a CPU unit that is not directly connected.

## 2 Selection of External Device

Select the External Device to be connected to the display.

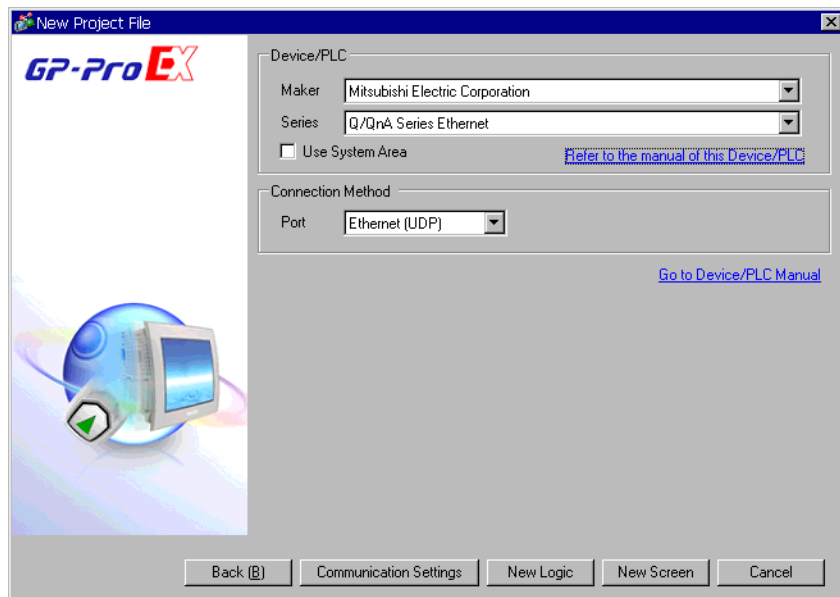

Setup Items	Setup Description
Maker	Select the maker of the External Device to be connected. Select "Mitsubishi Electric Corporation".
Driver	Select a model (series) of the External Device to be connected and connection method. Select "Q/QnA Series Ethernet". Check the External Device which can be connected in "Q/QnA Series Ethernet" in system configuration.  "1 System Configuration" (page 3)
Use System Area	Check this option when you synchronize the system data area of Display and the device (memory) of External Device. When synchronized, you can use the ladder program of External Device to switch the display or display the window on the display. Cf. GP-Pro EX Reference Manual "LS Area (Direct Access Method Area)" This can also be set in GP-Pro EX or in the Display's offline mode. Cf. GP-Pro EX Reference Manual "Display Unit (System Area) Settings Guide" Cf. Maintenance/Troubleshooting Guide "Main Unit - System Area Settings"
Port	Select the port of the display to be connected to the External Device from "Ethernet (UDP)" and "Ethernet (TCP)".  <b>NOTE</b> When using PLC ladder monitor, select "Ethernet (UDP)."



## 3 Example of Communication Setting

Examples of communication settings of the display and the External Device, recommended by Pro-face, are shown.

When you use the MELSEC Q/QnA Ethernet Series, use GP-Pro EX and the ladder software to set as below.

### 3.1 Setting Example 1

#### ■ Setting of GP-Pro EX

##### ◆ Communication Settings

To display the setting screen, select [Device/PLC Settings] from [System setting window] in workspace.

Device/PLC 1

Summary [Change Device/PLC](#)

Maker  Series  Port

Text Data Mode  [Change](#)

Communication Settings

Port No.

Timeout  (sec)

Retry

Wait To Send  (ms)

Device-Specific Settings

Allowable Number of Devices/PLCs 32

Number	Device Name	Settings
<input type="button" value="Settings"/> 1	<input type="text" value="PLC1"/>	<input type="text" value="IP Address=192.168.000.001,Port No.=1025,Communication data code=Binary c"/>

## ◆ Device Setting

To display the setting screen, click  ([Setting]) of External Device you want to set from [Device-Specific Settings] of [Device/PLC Settings].

When [Allowable No. of Device/PLCs] is multiple, click  from [Device-Specific Settings] of [Device/PLC Settings] to add another External Device.

[Basic] tab

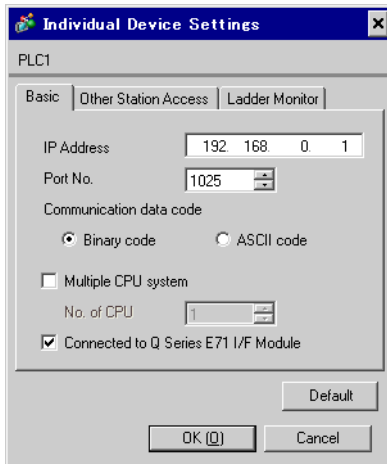

[Other Station Access] tab

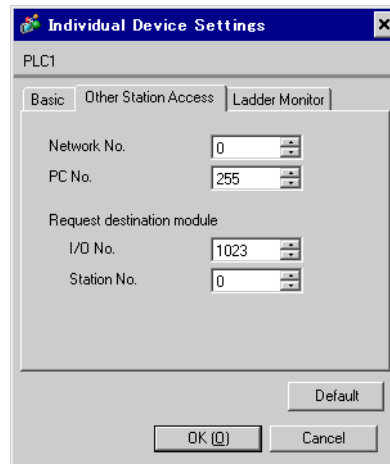

[Ladder Monitor] tab

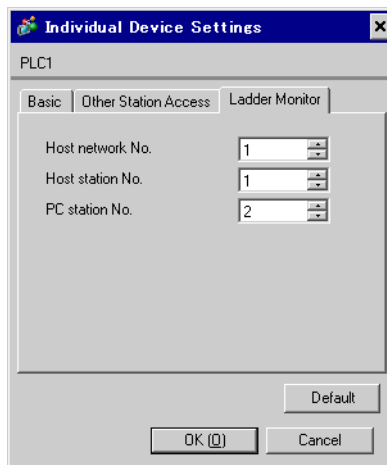

## ◆ Notes

- Check with a network administrator about IP address. Do not set the duplicate IP address.
- Set IP address on the External Device for IP address in Device-specific settings.
- You need to set IP address on the display in the offline mode of the display.
- Limitations when you use UDP/IP to access the multiple PLCs via network are shown below.
  - When you set the retry frequency to zero, the error message of "Response timed out for initial communication command" is displayed at startup.
  - At startup, you cannot read the device data until timeout time elapses once.

## ■ Setting of External Device

Perform the settings of External Device in "Network Parameter" of the Parameter Settings of the ladder software.

### ◆ Network Parameter MNET/10H Ethernet Settings

Setup Items	Settings
Network Type	Ethernet
Head I/O No.	Option
Network No.	Option
Group No.	Option
Station No.	Option
Mode	On-line

### ◆ Ethernet Operation Settings

Setup Items	Settings
Communication Data Code Settings	Binary code communication
Initial Timing Settings	Always wait for OPEN
IP Address Setting	192.168.0.1
Send Frame Settings	Ethernet (V2.0)
TCP Living Confirmation Settings	Option
Enable Write during RUN	Enable

### ◆ Open Settings

Setup Items	Settings
Protocol	UDP
Open Method	Unused
Source Port No.	401H <sup>*1*2</sup>
Destination IP Address	192.168.0.2 <sup>*1*3</sup>
Destination Port Number	401H <sup>*1*2*3</sup>
Fixed Buffer	Option
Update Procedure of Fixed Buffer	Procedure exist
Pairing Opening	Option
Living Confirmation	Option

\*1 Check with a network administrator about setting value.

\*2 Enter in hex number.

\*3 Adjust to the setting on Display.

**◆ Other Settings**

The following settings are items only if necessary.

- **Initial Settings**  
Settings related to timer for TCP connection. Basically, communication is available with default settings.  
Change the settings when you want to customize (such as shortening timeout).
- **Routing Information**  
Set only when you use subnet mask or router.
- **Auto Open UDP Port**  
When you use the UDP port, you can communicate using the auto open UDP port (port No. 5000) on the PLC.

**◆ Notes**

Check with a network administrator about IP address. Do not set the duplicate IP address.

## 3.2 Setting Example 2

### ■ Setting of GP-Pro EX

#### ◆ Communication Settings

To display the setting screen, select [Device/PLC Settings] from [System setting window] in workspace.

Device/PLC 1

Summary [Change Device/PLC](#)

Maker  Series  Port

Text Data Mode  [Change](#)

Communication Settings

Port No.   Auto



Timeout  (sec)

Retry

Wait To Send  (ms)

Device-Specific Settings

Allowable Number of Devices/PLCs 16 

Number	Device Name	Settings
 1	<input type="text" value="PLC1"/>	 IP Address=192.168.000.001,Port No.=1025,Communication data code=Binary c

### ◆ Device Setting

To display the setting screen, click  ([Setting]) of External Device you want to set from [Device-Specific Settings] of [Device/PLC Settings].

When [Allowable No. of Device/PLCs] is multiple, click  from [Device-Specific Settings] of [Device/PLC Settings] to add another External Device.

[Basic] tab

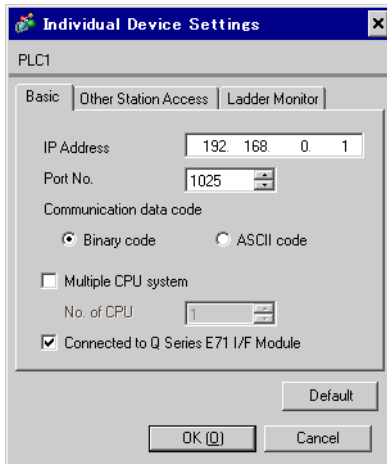

[Other Station Access] tab

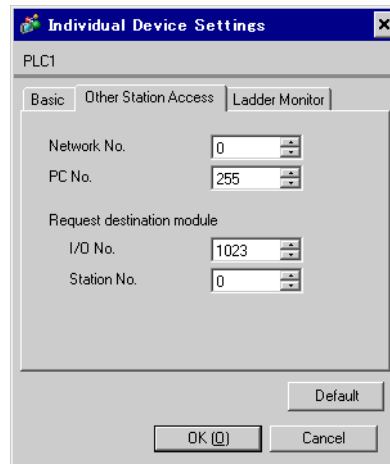

[Ladder Monitor] tab

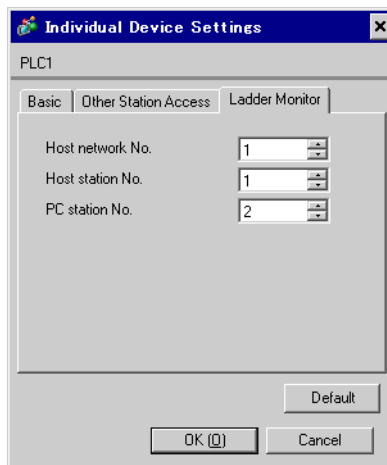

### ◆ Notes

- Check with a network administrator about IP address. Do not set the duplicate IP address.
- Set IP address on the External Device for IP address in Device-specific settings.
- You need to set IP address on the display in the offline mode of the display.

## ■ Settings of External Device

Perform the settings of External Device in "Network Parameter" of the Parameter Settings of the ladder software.

### ◆ Network Parameter MNET/10H Ethernet Settings

Setup Items	Settings
Network Type	Ethernet
Head I/O No.	Option
Network No.	Option
Group No.	Option
Station No.	Option
Mode	On-line

### ◆ Ethernet Operation Settings

Setup Items	Settings
Communication Data Code Settings	Binary code communication
Initial Timing Settings	Always wait for OPEN
IP Address Setting	192.168.0.1
Send Frame Settings	Ethernet (V2.0)
TCP Living Confirmation Settings	Option
Enable Write during RUN	Enable

### ◆ Open Settings

Setup Items	Settings
Protocol	TCP
Open Method	Unpassive
Source Port No.	401H*1*2
Destination IP Address	Setting unnecessary
Destination Port Number	Setting unnecessary
Fixed Buffer	Option
Update Procedure of Fixed Buffer	Procedure exist
Pairing Opening	Option
Living Confirmation	Option

\*1 Check with a network administrator about setting value.

\*2 Enter in hex number.

**◆ Other Settings**

The following settings are items only if necessary.

- **Initial Settings**  
Settings related to timer for TCP connection. Basically, communication is available with default settings.  
Change the settings when you want to customize (such as shortening timeout).
- **Routing Information**  
Set only when you use subnet mask or router.
- **Auto Open UDP Port**  
When you use the UDP port, you can communicate using the auto open UDP port (port No. 5000) on the PLC.

**◆ Notes**

Check with a network administrator about IP address. Do not set the duplicate IP address.



### 3.3 Setting Example 3

#### ■ Setting of GP-Pro EX

##### ◆ Communication Settings

To display the setting screen, select [Device/PLC Settings] from [System setting window] in workspace.

Device/PLC 1

Summary [Change Device/PLC](#)

Maker  Series  Port

Text Data Mode  [Change](#)

Communication Settings

Port No.

Timeout  (sec)

Retry

Wait To Send  (ms)

Device-Specific Settings

Allowable Number of Devices/PLCs 32

Number	Device Name	Settings
<input type="button" value="1"/>	<input type="text" value="PLC1"/>	<input type="text" value="IP Address=192.168.000.001,Port No.=1025,Communication data code=Binary c"/>

## ◆ Device Setting

To display the setting screen, click  ([Setting]) of External Device you want to set from [Device-Specific Settings] of [Device/PLC Settings].

When [Allowable No. of Device/PLCs] is multiple, click  from [Device-Specific Settings] of [Device/PLC Settings] to add another External Device.

[Basic] tab

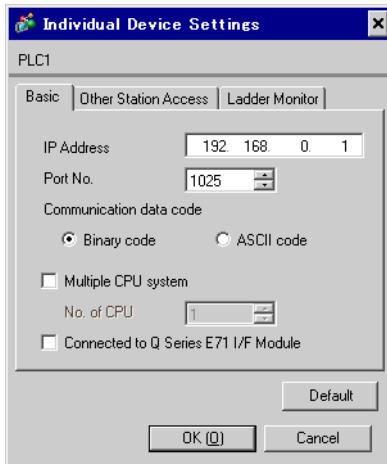

[Other Station Access] tab

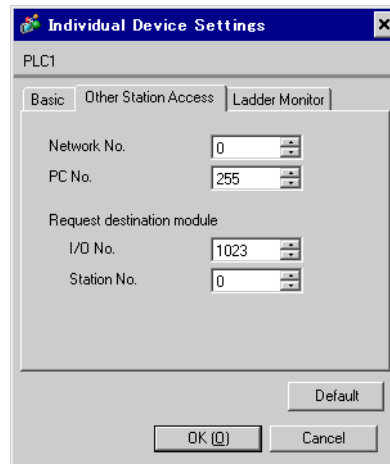

[Ladder Monitor] tab

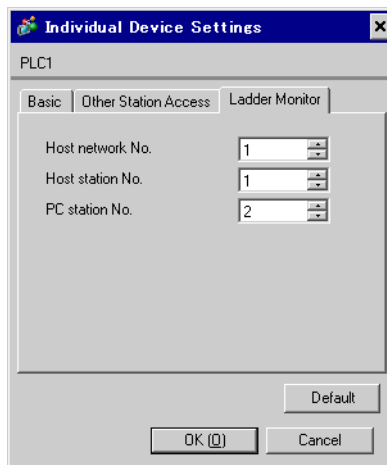

## ◆ Notes

- Check with a network administrator about IP address. Do not set the duplicate IP address.
- Set IP address on the External Device for IP address in Device-specific settings.
- You need to set IP address on the display in the offline mode of the display.
- Limitations when you use UDP/IP to access the multiple PLCs via network are shown below.
  - When you set the retry frequency to zero, the error message of "Response timed out for initial communication command" is displayed at startup.
  - At startup, you cannot read the device data until timeout time elapses once.



## 3.4 Setting Example 4

### ■ Setting of GP-Pro EX

#### ◆ Communication Settings

To display the setting screen, select [Device/PLC Settings] from [System setting window] in workspace.

Device/PLC 1

Summary [Change Device/PLC](#)

Maker  Series  Port

Text Data Mode  [Change](#)

Communication Settings

Port No.   Auto

Timeout  (sec)

Retry

Wait To Send  (ms)

Device-Specific Settings

Allowable Number of Devices/PLCs 16

Number	Device Name	Settings
<input type="button" value="1"/>	<input type="text" value="PLC1"/>	<input type="text" value="IP Address=192.168.000.001,Port No.=1025,Communication data code=Binary c"/>

### ◆ Device Setting

To display the setting screen, click  ([Setting]) of External Device you want to set from [Device-Specific Settings] of [Device/PLC Settings].

When you connect multiple External Device, click  from [Device-Specific Settings] of [Device/PLC Settings] to add another External Device.

[Basic] tab

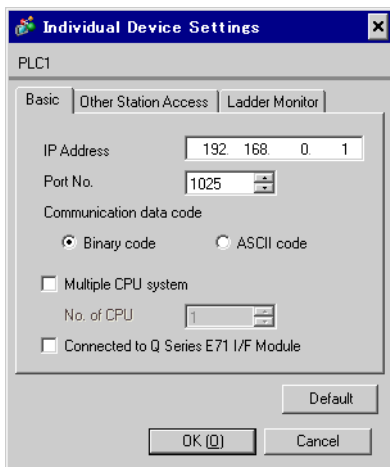

[Other Station Access] tab

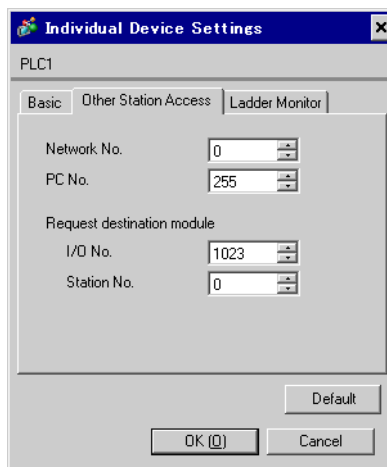

[Ladder Monitor] tab

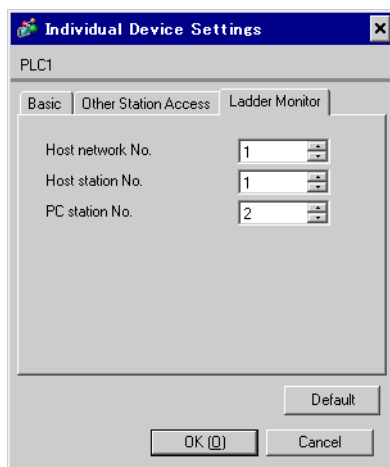

### ◆ Notes

- Check with a network administrator about IP address. Do not set the duplicate IP address.
- Set IP address on the External Device for IP address in Device-specific settings.
- You need to set IP address on the display in the offline mode of the display.



## 3.5 Setting Example 5

### ■ Setting of GP-Pro EX

#### ◆ Communication Settings

To display the setting screen, select [Device/PLC Settings] from [System setting window] in workspace.

Device/PLC 1

Summary [Change Device/PLC](#)

Maker  Series  Port

Text Data Mode  [Change](#)

Communication Settings

Port No.

Timeout  (sec)

Retry

Wait To Send  (ms)

Device-Specific Settings

Allowable Number of Devices/PLCs 32

Number	Device Name	Settings
<input type="button" value="1"/>	<input type="text" value="PLC1"/>	<input type="text" value="IP Address=192.168.000.001,Port No.=1025,Communication data code=Binary c"/>

## ◆ Device Setting

To display the setting screen, click  ([Setting]) of External Device you want to set from [Device-Specific Settings] of [Device/PLC Settings].

When [Allowable No. of Device/PLCs] is multiple, click  from [Device-Specific Settings] of [Device/PLC Settings] to add another External Device.

[Basic] tab

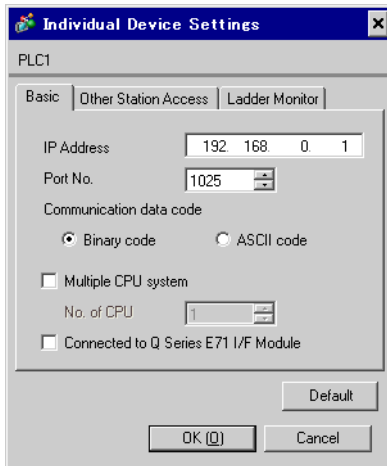

[Other Station Access] tab

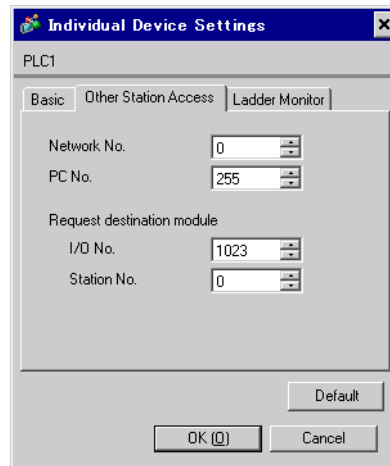

[Ladder Monitor] tab

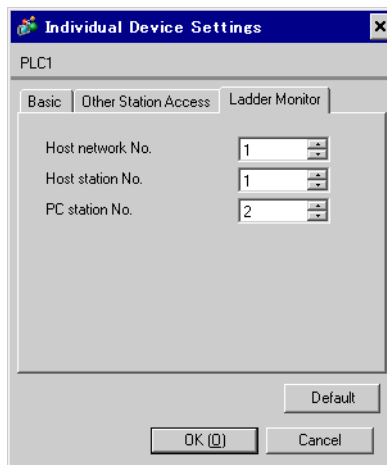

## ◆ Notes

- The check on [Connected to Q Series E71 I/F Module] is removed.
- Check with a network administrator about IP address. Do not set the duplicate IP address.
- Set IP address on the External Device for IP address in Device-specific settings.
- You need to set IP address on the display in the offline mode of the display.



## ■ Setting of External Device

To configure communication settings, use the ladder software (GX-Developer Ver.8.88S). After completing the settings, reboot the External Device to enable them. Please refer to the manual of the External Device for details.

- 1 Start up the ladder software.
- 2 Double-click [PC Parameter] under [Parameter].
- 3 Configure the following settings in the [Built-in Ethernet port] tab of the window that appears.

Setup Items	Settings
IP Address	192.168.0.1
Subnet Mask pattern	Option
Default Router IP Address	Option
Communication Data Code Settings	Binary code communication
Enable Write during RUN	Enable <sup>*1</sup>

\*1 It enables writing to the External Device even when the CPU is in RUN status.

- 4 Click [Open settings].
- 5 Configure the following settings in the window that appears.

Setup Items	Settings
Protocol	UDP
Open Method	MC Protocol
Source Port No.	401H <sup>*1</sup>

\*1 Use an integer from "0401H to 1387H" and "1392H to FFFE" to enter the source port No. Check with a network administrator about setting value.

- 6 Click [End].

## 3.6 Setting Example 6

### ■ Setting of GP-Pro EX

#### ◆ Communication Settings

To display the setting screen, select [Device/PLC Settings] from [System setting window] in workspace.

Device/PLC 1

Summary [Change Device/PLC](#)

Maker  Series  Port

Text Data Mode  [Change](#)

Communication Settings

Port No.   Auto

Timeout  (sec)

Retry

Wait To Send  (ms)

Device-Specific Settings

Allowable Number of Devices/PLCs 16

Number	Device Name	Settings
<input type="button" value="👤"/> 1	<input type="text" value="PLC1"/>	<input type="button" value="⚙️"/> IP Address=192.168.000.001,Port No.=1025,Communication data code=Binary c

### ◆ Device Setting

To display the setting screen, click  ([Setting]) of External Device you want to set from [Device-Specific Settings] of [Device/PLC Settings].

When you connect multiple External Device, click  from [Device-Specific Settings] of [Device/PLC Settings] to add another External Device.

[Basic] tab

[Other Station Access] tab

[Ladder Monitor] tab

### ◆ Notes

- The check on [Connected to Q Series E71 I/F Module] is removed.
- Check with a network administrator about IP address. Do not set the duplicate IP address.
- Set IP address on the External Device for IP address in Device-specific settings.
- You need to set IP address on the display in the offline mode of the display.

## ■ Settings of External Device

To configure communication settings, use the ladder software (GX-Developer Ver.8.88S). After completing the settings, reboot the External Device to enable them. Please refer to the manual of the External Device for details.

- 1 Start up the ladder software.
- 2 Double-click [PC Parameter] under [Parameter].
- 3 Configure the following settings in the [Built-in Ethernet port] tab of the window that appears.

Setup Items	Settings
IP Address	192.168.0.1
Subnet Mask pattern	Option
Default Router IP Address	Option
Communication Data Code Settings	Binary code communication
Enable Write during RUN	Enable <sup>*1</sup>

\*1 It enables writing to the External Device even when the CPU is in RUN status.

- 4 Click [Open settings].
- 5 Configure the following settings in the window that appears.

Setup Items	Settings
Protocol	TCP
Open Method	MC Protocol
Source Port No.	401H <sup>*1</sup>

\*1 Use an integer from "0401H to 1387H" and "1392H to FFFEH" to enter the source port No. Check with a network administrator about setting value.

- 6 Click [End].

## 4 Setup Items

Set communication settings of the display with GP-Pro Ex or in offline mode of the display.

The setting of each parameter must be identical to that of External Device.

 "3 Example of Communication Setting" (page 9)

**NOTE** • Set the Display's IP address in offline mode.

Cf. Maintenance/Troubleshooting Guide "Ethernet Settings"

### 4.1 Setup Items in GP-Pro EX

#### ■ Communication Settings

To display the setting screen, select [Device/PLC Settings] from [System setting window] in workspace.

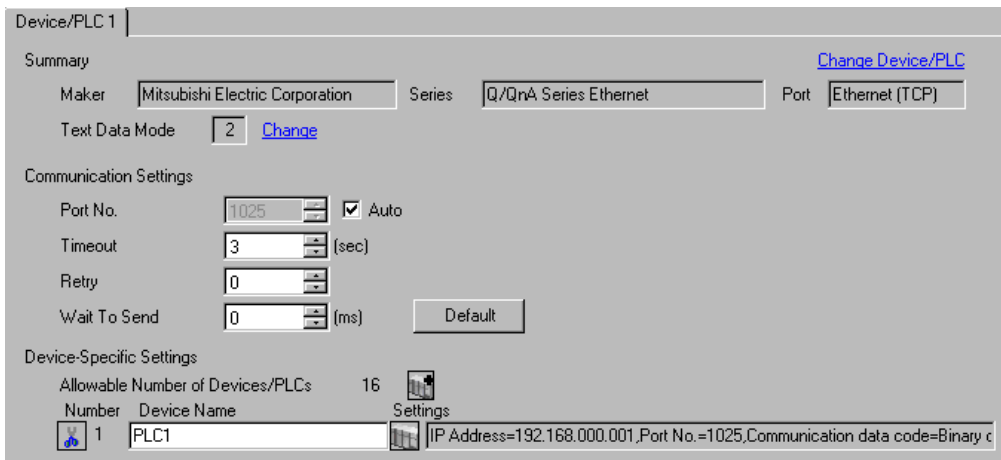

Device/PLC 1

Summary

Maker: Mitsubishi Electric Corporation Series: Q/QnA Series Ethernet Port: Ethernet (TCP) [Change Device/PLC](#)

Text Data Mode: 2 [Change](#)

Communication Settings

Port No.: 1025  Auto

Timeout: 3 (sec)

Retry: 0

Wait To Send: 0 (ms) [Default](#)

Device-Specific Settings

Allowable Number of Devices/PLCs: 16

Number	Device Name	Settings
1	PLC1	IP Address=192.168.000.001,Port No.=1025,Communication data code=Binary c

Setup Items	Setup Description
Port No.	<p>Use an integer from 1025 to 65535 to enter the port No. of the display. When you check the option of [Auto Assign], the port No. will be automatically set.</p> <p><b>NOTE</b></p> <ul style="list-style-type: none"> <li>[Auto Assign] option is available to set only when you select "Ethernet (TCP)" in [Connecting Method].</li> </ul>
Timeout	<p>Use an integer from 1 to 127 to enter the time (s) for which Display waits for the response from External Device.</p> <p><b>NOTE</b></p> <ul style="list-style-type: none"> <li>In case of communicating via network, please set larger value than the response monitoring time of the relay station for timeout settings.</li> </ul>
Retry	<p>In case of no response from the External Device, use an integer from 0 to 255 to enter how many times the display retransmits the command.</p>
Wait To Send	<p>Use an integer from 0 to 255 to enter standby time (ms) for the display from receiving packets to transmitting next commands.</p>

## ■ Device Setting

To display the setting screen, click  ([Setting]) of External Device you want to set from [Device-Specific Settings] of [Device/PLC Settings].

When [Allowable No. of Device/PLCs] is multiple, click  from [Device-Specific Settings] of [Device/PLC Settings] to add another External Device.

### ◆ [Basic] tab

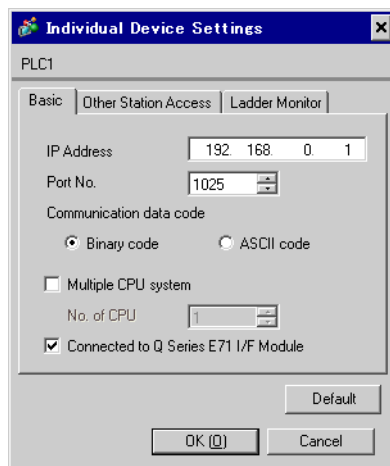

Setup Items	Setup Description
IP Address	Set IP address of the External Device. <b>NOTE</b> <ul style="list-style-type: none"> <li>Check with a network administrator about IP address. Do not set the duplicate IP address.</li> </ul>
Port No.	Use an integer from 1025 to 65535 to enter the port No. (Decimal) of the External Device. <b>IMPORTANT</b> <ul style="list-style-type: none"> <li>Do not use the following port No. because Ethernet unit reserves them in the system.                UDP connection: 5001-5002                TCP connection: 5000-5002</li> </ul>
Communication data Code	Select the data format to communicate with the External Device from "Binary code communication" or "ASCII code communication".
Multiple CPU system	Check this option when you use Multiple CPU system.
No. of CPU	Use an integer from 1 to 4 to enter the number of CPU units that is used with Multiple CPU system. <b>NOTE</b> <ul style="list-style-type: none"> <li>[No. of CPU] is available to set only when you check [Multiple CPU system].</li> </ul>
Connected to Q Series E71 I/F Module	Check this checkbox only when the Q Series E71 I/F unit is used. If this is checked when the Q Series E71 I/F unit is not used, the error may be displayed on the External Device.

## ◆ [Other Station Access] tab

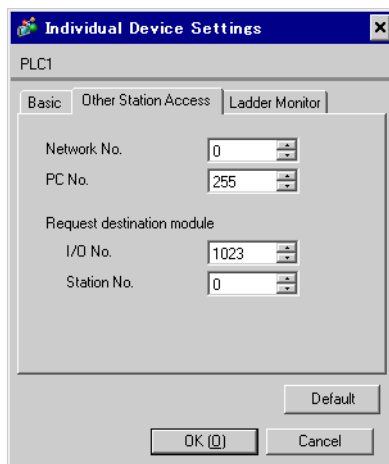

Setup Items	Setup Description
Network No.	Set PC No. when you communicate via network. Use an integer from 0 to 239 to enter network No. of the External Device to communicate. If you do not communicate via network, enter 0.
PC No.	Set PC No. when you communicate via network. Use an integer from 0 to 64 or 125 to 126 to enter PC No. of the External Device to communicate. If you do not communicate via network, enter 255.
I/O No.	Set PC No. when you communicate via network. Use an integer from 0 to 511 to enter I/O No. of the External Device to communicate. If you do not communicate via network, enter 1023.
Station No.	Enter a station number of the External Device, using 0 to 31.

## ◆ [Ladder Monitor] tab

The content of [Ladder Monitor] tab is used on the PLC ladder monitor. If the PLC ladder monitor is not used, the set value becomes invalid. Refer to the Mitsubishi Electric Q Series PLC Ladder Monitor Operation Manual for details of the ladder monitor.

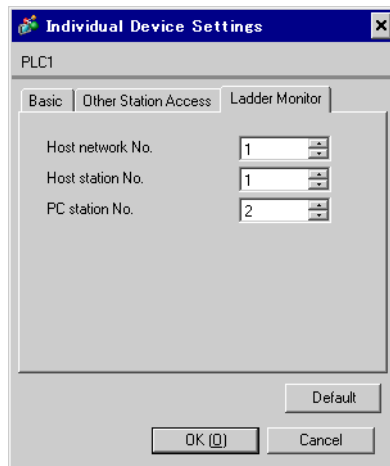

Setup Items	Setup Description
Host network No.	Input the network number that the Display is connected to from 1 through 239.
Host station No.	Input the PC station number of the Display from 1 through 64.
PC station No.	Input the PC station number of the External Device that is directly connected from 1 through 64.

**NOTE**

- Do not set the same PC station number within the same network.
- If an error is displayed on the PLC ladder monitor, set the same number as the one for [Host network No.] (in the [Ladder Monitor] tab) to [Network No.] (in the [Other Station Access] tab). In addition, set the same number as the one for [PC station No.] (in the [Ladder Monitor] tab) to [PC No.] (in the [Other Station Access] tab).
- The PLC ladder monitor cannot be used for the External Device that is connected via the serial communication module.



- Setting examples of [Ext. Setting] tab are shown below.

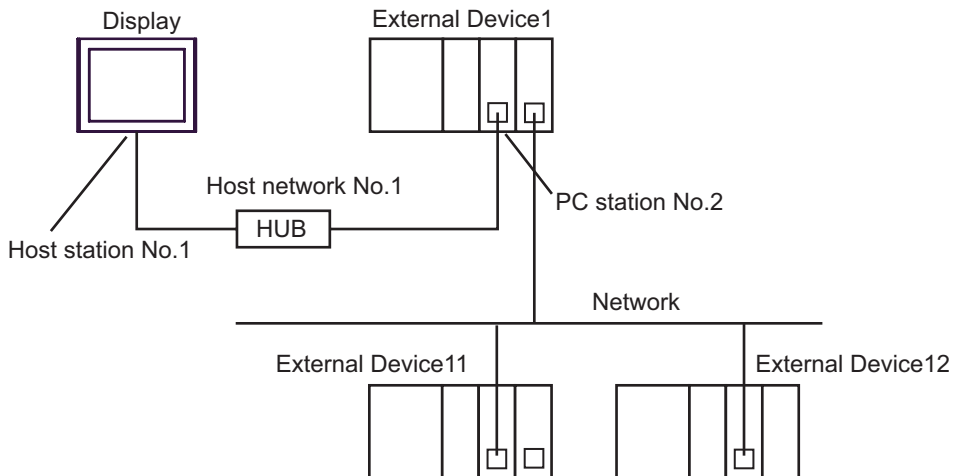

Setup Items	Settings
Host network No.	1
Host station No.	1
PC station No.	2

## 4.2 Setup Items in Offline Mode

**NOTE**

- Refer to the Maintenance/Troubleshooting guide for information on how to enter offline mode or about the operation.

Cf. Maintenance/Troubleshooting Guide "Offline Mode"

### ■ Communication Settings

To display the setting screen, touch [Device/PLC Settings] from [Peripheral Settings] in offline mode. Touch the External Device you want to set from the displayed list.

Comm.	Device			
Q/QnA Series Ethernet [TCP] Page 1/1				
Port No.	<input type="radio"/> Fixed <input checked="" type="radio"/> Auto <input type="text" value="1025"/>			
Timeout(s)	<input type="text" value="3"/>			
Retry	<input type="text" value="0"/>			
Wait To Send(ms)	<input type="text" value="0"/>			
Exit		Back		2009/10/15 15:35:09

Setup Items	Setup Description
Port No.	Set the Port No. of the display. In UDP connection, entered port No. will be assigned regardless of whether you select [Fixed] or [Auto]. In TCP connection, select either of [Fixed] or [Auto]. When you select [Fixed], use an integer from 1025 to 65535 to enter the port No. of the display. When you select [Auto], the port No. will be automatically assigned regardless of the entered value.
Timeout	Use an integer from 1 to 127 to enter the time (s) for which Display waits for the response from External Device. <b>NOTE</b> <ul style="list-style-type: none"> <li>In case of communicating via network, please set larger value than the response monitoring time of the relay station for timeout settings.</li> </ul>
Retry	In case of no response from the External Device, use an integer from 0 to 255 to enter how many times the display retransmits the command.
Wait To Send	Use an integer from 0 to 255 to enter standby time (ms) for the display from receiving packets to transmitting next commands.

## ■ Device Setting

To display the setting screen, touch [Device/PLC Settings] from [Peripheral Settings]. Touch the External Device you want to set from the displayed list, and touch [Device].

(Page 1/2)

Comm.	Device			
Q/QnA Series Ethernet		[TCP]	Page 1/2	
Device/PLC Name	[PLC1]			
IP Address	192	168	0	1
Port No.	1025			
Data Code	<input checked="" type="radio"/> Binary <input type="radio"/> ASCII			
Multiple CPU	NotUse			
Q Series E71 I/F	[ON]			
				➔
Exit		Back		2009/10/15 15:35:13

Setup Items	Setup Description
Device/PLC Name	Select the External Device for device setting. Device name is a title of External Device set with GP-Pro EX.(Initial value [PLC1])
IP Address	Set IP address of the External Device. <b>NOTE</b> <ul style="list-style-type: none"> <li>Check with a network administrator about IP address. Do not set the duplicate IP address.</li> </ul>
Port No.	Use an integer from 1025 to 65535 to enter the port No. (Decimal) of the External Device. <b>IMPORTANT</b> <ul style="list-style-type: none"> <li>Do not use the following port No. because Ethernet unit reserves them in the system. UDP connection: 5001-5002 TCP connection: 5000-5002</li> </ul>
Data Code	Select the data format to communicate with the External Device from "Binary code communication" or "ASCII code communication".
Multiple CPU	The setting of Multiple CPU system is displayed in "NotUse" or "1 to 4".
Q Series E71 I/F	Select "ON" and "OFF" respectively when the Q Series E71 I/F unit is used and when the Q Series E71 I/F unit is not used. If "ON" is selected when the Q Series E71 I/F unit is not used, the error may be displayed on the External Device.

(Page 2/2)

The content of [Ext. Setting] tab is used on the PLC ladder monitor. If the PLC ladder monitor is not used, the set value becomes invalid. Refer to the Mitsubishi Electric Q Series PLC Ladder Monitor Operation Manual for details of the ladder monitor.

Comm.	Device			
Q/QnA Series Ethernet		[TCP]	Page 2/2	
Device/PLC Name <input type="text" value="PLC1"/>				
Network No.		<input type="text" value="0"/>		
PC No.		<input type="text" value="255"/>		
Request destination module				
I/O No.		<input type="text" value="1023"/>		
Station No.		<input type="text" value="0"/>		
Ladder Monitor Setting				
Host network No.		<input type="text" value="1"/>		
Host station No.		<input type="text" value="1"/>		
PC station No.		<input type="text" value="2"/>		
Exit		Back		2009/10/15 15:35:18

Setup Items	Setup Description
Device/PLC Name	Select the External Device for device setting. Device name is a title of External Device set with GP-Pro EX.(Initial value [PLC1])
Network No.	Set PC No. when you communicate via network. Use an integer from 0 to 239 to enter network No. of the External Device to communicate. If you do not communicate via network, enter 0.
PC No.	Set PC No. when you communicate via network. Use an integer from 0 to 64 or 125 to 126 to enter PC No. of the External Device to communicate. If you do not communicate via network, enter 255.
I/O No.	Set PC No. when you communicate via network. Use an integer from 0 to 511 to enter I/O No. of the External Device to communicate. If you do not communicate via network, enter 1023.
Station No.	Enter a station number of the External Device, using 0 to 31.
Host network No.	Input the network number that the Display is connected to from 1 through 239.
Host station No.	Input the PC station number of the Display from 1 through 64.
PC station No.	Input the PC station number of the External Device that is directly connected from 1 through 64.

**NOTE**

- Do not set the same PC station number within the same network.
- Refer to the [Ladder Monitor] tab of "Setup Items in GP-Pro EX" for the examples of [Ladder Monitor] tab.

" ◆ [Ladder Monitor] tab" (page 32)

## 5 Supported Device

Range of supported device address is shown in the table below. Please note that the actually supported range of the devices varies depending on the External Device to be used. Please check the actual range in the manual of your External Device.

Input address of external device in the dialog below.

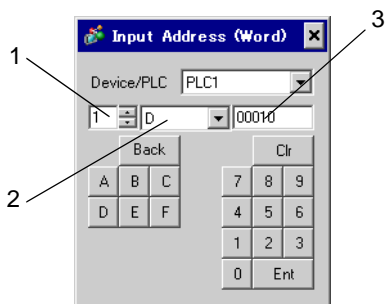

- |                |  |
|----------------|--|
| 1. Unit Number | Select the number of a CPU unit to communicate with from 1 to 4.<br>Select "0" to access a CPU unit that is directly connected like the Single CPU System. |
| 2. Device      | Specify a device.  |
| 3. Address     | Specify an address.  |

■ MELSEC Q (High performance model, Basic model) / MELSEC QnA Series

     This address can be specified as system data area.

Device	Bit Address	Word Address	32 bits	Notes
Input Relay	X0000-X1FFF	X0000-X1FF0	L/H	<span style="border: 1px solid black; padding: 2px;">***0</span>
Output Relay	Y0000-Y1FFF	Y0000-Y1FF0		<span style="border: 1px solid black; padding: 2px;">***0</span>
Internal Relay	M00000-M32767	M00000-M32752		<span style="border: 1px solid black; padding: 2px;">÷16</span>
Special Relay	SM0000-SM2047	SM0000-SM2032		<span style="border: 1px solid black; padding: 2px;">÷16</span>
Latch Relay	L00000-L32767	L00000-L32752		<span style="border: 1px solid black; padding: 2px;">÷16</span>
Annunciator	F00000-F32767	F00000-F32752		<span style="border: 1px solid black; padding: 2px;">÷16</span>
Edge Relay	V00000-V32767	V00000-V32752		<span style="border: 1px solid black; padding: 2px;">÷16</span>
Step Relay	S0000-S8191	S0000-S8176		<span style="border: 1px solid black; padding: 2px;">÷16</span>
Link Relay	B0000-B7FFF	B0000-B7FF0		<span style="border: 1px solid black; padding: 2px;">***0</span>
Special Link Relay	SB000-SB7FF	SB000-SB7F0		<span style="border: 1px solid black; padding: 2px;">***0</span>
Timer (Contact)	TS00000-TS23087	-----		
Timer (Coil)	TC00000-TC23087	-----		
Retentive Timer (Contact)	SS00000-SS23087	-----		
Retentive Timer (Coil)	SC00000-SC23087	-----		
Counter (Contact)	CS00000-CS23087	-----		
Counter (Coil)	CC00000-CC23087	-----		
Timer (Current Value)	-----	TN00000-TN23087		
Retentive Timer (Current Value)	-----	SN00000-SN23087		
Counter (Current Value)	-----	CN00000-CN23087		
Data Register	-----	D00000-D25983		<span style="border: 1px solid black; padding: 2px;">Bit F</span>
Special Register	-----	SD0000-SD2047		<span style="border: 1px solid black; padding: 2px;">Bit F</span>
Link Register	-----	W0000-W657F		<span style="border: 1px solid black; padding: 2px;">Bit F</span>
Special Link Register	-----	SW000-SW7FF		<span style="border: 1px solid black; padding: 2px;">Bit F</span>
File Register (Normal)	-----	R00000-R32767		<span style="border: 1px solid black; padding: 2px;">Bit F</span> *1
File Register (Block switching is not necessary)	-----	ZR0000000-ZR1042431		<span style="border: 1px solid black; padding: 2px;">Bit F</span> *1

Continued to next page.

Device	Bit Address	Word Address	32 bits	Notes
File Register (0R - 31R) <sup>*2</sup>	-----	0R0000-0R32767	<b>L/H</b>	<b>Bit F</b> <sup>*1</sup>
	-----	1R0000-1R32767		
	-----	2R0000-2R32767		
	:	:		
	-----	30R0000-30R32767		
	-----	31R0000-31R26623		

\*1 It is different by the memory card which uses the range of file register.

\*2 Set the block No. on the head of device name. This is the device name for conversion with GP-Pro/PBIII for Windows. When you newly specify the device, we recommend that you should use the file register (Block switching is not necessary).

**NOTE**

- The notation of addresses differs depending on a selected Unit No.  
<Ex.>When 0 is selected for Unit No.,

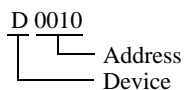

<Ex.>When 1 is selected for Unit No.,

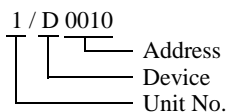











- Please refer to the GP-Pro EX Reference Manual for system data area.  
Cf. GP-Pro EX Reference Manual "LS Area (Direct Access Method Area)"
- Please refer to the precautions on manual notation for icons in the table.

☞ "Manual Symbols and Terminology"

## ■ MELSEC Q (Universal model) Series

 This address can be specified as system data area.

Device	First 5 digits of the serial No. in the CPU unit: Less than 10042		First 5 digits of the serial No. in the CPU unit: 10042 or later		32bits	Notes
	Bit Address	Word Address	Bit Address	Word Address		
Input Relay	X0000-X1FFF	X0000-X1FF0	X0000-X1FFF	X0000-X1FF0	<b>L/H</b>	
Output Relay	Y0000-Y1FFF	Y0000-Y1FF0	Y0000-Y1FFF	Y0000-Y1FF0		
Internal Relay	M00000-M32767	M00000-M32752	M00000-M61439	M00000-M61424		
Special Relay	SM0000-SM2047	SM0000-SM2032	SM0000-SM2047	SM0000-SM2032		
Latch Relay	L00000-L32767	L00000-L32752	L00000-L32767	L00000-L32752		
Annunciator	F00000-F32767	F00000-F32752	F00000-F32767	F00000-F32752		
Edge Relay	V00000-V32767	V00000-V32752	V00000-V32767	V00000-V32752		
Step Relay	S0000-S8191	S0000-S8176	S0000-S8191	S0000-S8176		
Link Relay	B0000-B7FFF	B0000-B7FF0	B0000-BEFFF	B0000-BEFFF0		
Special Link Relay	SB0000 - SB7FFF	SB0000 - SB7FF0	SB0000 - SB7FFF	SB0000 - SB7FF0		
Timer (Contact)	TS00000-TS25023	-	TS00000-TS25471	-		
Timer (Coil)	TC00000-TC25023	-	TC00000-TC25471	-		
Retentive Timer (Contact)	SS00000-SS25023	-	SS00000-SS25471	-		
Retentive Timer (Coil)	SC00000-SC25023	-	SC00000-SC25471	-		
Counter (Contact)	CS00000-CS25023	-	CS00000-CS25471	-		
Counter (Coil)	CC00000-CC25023	-	CC00000-CC25471	-		
Timer (Current Value)	-	TN00000-TN25023	-	TN00000-TN25471		

continued to next page



Device	First 5 digits of the serial No. in the CPU unit: Less than 10042		First 5 digits of the serial No. in the CPU unit: 10042 or later		32bits	Notes
	Bit Address	Word Address	Bit Address	Word Address		
Retentive Timer (Current Value)	-	SN00000-SN25023	-	SN00000-SN25471	[L/H]	
Counter (Current Value)	-	CN00000-CN25023	-	CN00000-CN25471		
Data Register	-	D00000-D28159	-	D00000-D28671		[Bit F]
Special Register	-	SD00000-SD2047	-	SD00000-SD2047		[Bit F]
Link Register	-	W00000-W6DFF	-	W00000-W6FFF		[Bit F]
Special Link Register	-	SW00000-SW6DFF	-	SW00000-SW6FFF		[Bit F]
File Register (Normal)	-	R00000-R32767	-	R00000-R32767		[Bit F] *1
File Register (Block switching is not necessary)	-	ZR0000000-ZR4184063	-	ZR0000000-ZR4184063		[Bit F] *1
File Register (0R - 31R) *2	-	0R00000-0R32767	-	0R00000-0R32767		[Bit F] *1
	-	1R00000-1R32767	-	1R00000-1R32767		
	-	2R00000-2R32767	-	2R00000-2R32767		
	:	:	:	:		
	-	30R00000-30R32767	-	30R00000-30R32767		
	-	31R00000-31R26623	-	31R00000-31R26623		

\*1 It is different by the memory card which uses the range of file register.

\*2 Set the block No. on the head of device name. This is the device name for conversion with GP-Pro/PB III for Windows. When you newly specify the device, we recommend that you should use the file register (Block switching is not necessary).

**NOTE**

- The notation of addresses differs depending on a selected Unit No.

<Ex.>When 0 is selected for Unit No.,

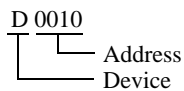

<Ex.>When 1 is selected for Unit No.,

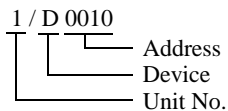

- Please refer to the GP-Pro EX Reference Manual for system data area.  
Cf. GP-Pro EX Reference Manual "LS Area (Direct Access Method Area)"
- Please refer to the precautions on manual notation for icons in the table.

☞ "Manual Symbols and Terminology"

## ■ MELSEC L Series

     This address can be specified as system data area.

Device	Bit Address	Word Address	32 bits	Notes
Input Relay	X0000-X1FFF	X0000-X1FF0	L / H	<span style="border: 1px solid black; padding: 2px;">***0</span>
Output Relay	Y0000-Y1FFF	Y0000-Y1FF0		<span style="border: 1px solid black; padding: 2px;">***0</span>
Internal Relay	M00000-M61439	M00000-M61424		<span style="border: 1px solid black; padding: 2px;">÷16</span>
Special Relay	SM0000-SM2047	SM0000-SM2032		<span style="border: 1px solid black; padding: 2px;">÷16</span>
Latch Relay	L00000-L32767	L00000-L32752		<span style="border: 1px solid black; padding: 2px;">÷16</span>
Annunciator	F0000-F32767	F00000-F32752		<span style="border: 1px solid black; padding: 2px;">÷16</span>
Edge Relay	V00000-V32767	V00000-V32752		<span style="border: 1px solid black; padding: 2px;">÷16</span>
Step Relay	S0000-S8191	S0000-S8176		<span style="border: 1px solid black; padding: 2px;">÷16</span>
Link Relay	B0000-BEFFF	B0000-BEFFF0		<span style="border: 1px solid black; padding: 2px;">***0</span>
Special Link Relay	SB0000-SB7FFF	SB0000-SB7FFF0		<span style="border: 1px solid black; padding: 2px;">***0</span>
Timer (Contact)	TS00000-TS25471	-----		
Timer (Coil)	TC00000-TC25471	-----		
Retentive Timer (Contact)	SS00000-SS25471	-----		
Retentive Timer (Coil)	SC00000-SC25471	-----		
Counter (Contact)	CS00000-CS25471	-----		
Counter (Coil)	CC00000-CC25471	-----		
Timer (Current Value)	-----	TN00000-TN25471		
Retentive Timer (Current Value)	-----	SN00000-SN25471		
Counter (Current Value)	-----	CN00000-CN25471		
Data Register	-----	D00000-D65535		<span style="border: 1px solid black; padding: 2px;">Bit F</span>
Special Register	-----	SD0000-SD2047		<span style="border: 1px solid black; padding: 2px;">Bit F</span>
Link Register	-----	W0000-WFFFF		<span style="border: 1px solid black; padding: 2px;">Bit F</span>
Special Link Register	-----	SW0000-SW6FFF		<span style="border: 1px solid black; padding: 2px;">Bit F</span>
File Register (Normal)	-----	R00000-R32767		<span style="border: 1px solid black; padding: 2px;">Bit F</span> *1
File Register (Block switching is not necessary)	-----	ZR0000000-ZR393215		<span style="border: 1px solid black; padding: 2px;">Bit F</span> *1

Continued to next page.

Device	Bit Address	Word Address	32 bits	Notes
File Register (0R - 11R) <sup>*2</sup>	-----	0R00000-0R32767	<b>L/H</b>	<b>Bit F</b> <sup>*1</sup>
	-----	1R00000-1R32767		
	-----	2R00000-2R32767		
	:	:		
	-----	10R00000-10R32767		
	-----	11R00000-11R32767		

\*1 It is different by the memory card which uses the range of file register.

\*2 Set the block No. on the head of device name. This is the device name for conversion with GP-Pro/PBIII for Windows. When you newly specify the device, we recommend that you should use the file register (Block switching is not necessary).

---

**NOTE**

- Please refer to the GP-Pro EX Reference Manual for system data area.  
Cf. GP-Pro EX Reference Manual "LS Area (Direct Access Method Area)"
  - Please refer to the precautions on manual notation for icons in the table.  
☞ "Manual Symbols and Terminology"
-

## 6 Device Code and Address Code

Use device code and address code when you select "Device & Address" for the address type in data displays.

Device	Device Name	Device Code (HEX)	Address Code
Input Relay	X	0080	Value of word address divided by 0x10
	1/X	0180	
	2/X	0280	
	3/X	0380	
	4/X	0480	
Output Relay	Y	0081	Value of word address divided by 0x10
	1/Y	0181	
	2/Y	0281	
	3/Y	0381	
	4/Y	0481	
Internal Relay	M	0082	Value of word address divided by 16
	1/M	0182	
	2/M	0282	
	3/M	0382	
	4/M	0482	
Special Relay	SM	0083	Value of word address divided by 16
	1/SM	0183	
	2/SM	0283	
	3/SM	0383	
	4/SM	0483	
Latch Relay	L	0084	Value of word address divided by 16
	1/L	0184	
	2/L	0284	
	3/L	0384	
	4/L	0484	

continued to next page

Device	Device Name	Device Code (HEX)	Address Code
Annunciator	F	0085	Value of word address divided by 16
	1/F	0185	
	2/F	0285	
	3/F	0385	
	4/F	0485	
Edge Relay	V	0086	Value of word address divided by 16
	1/V	0186	
	2/V	0286	
	3/V	0386	
	4/V	0486	
Step Relay	S	0087	Value of word address divided by 16
	1/S	0187	
	2/S	0287	
	3/S	0387	
	4/S	0487	
Link Relay	B	0088	Value of word address divided by 0x10
	1/B	0188	
	2/B	0288	
	3/B	0388	
	4/B	0488	
Special Link Relay	SB	0089	Value of word address divided by 0x10
	1/SB	0189	
	2/SB	0289	
	3/SB	0389	
	4/SB	0489	
Timer (Current Value)	TN	0060	Word Address
	1/TN	0160	
	2/TN	0260	
	3/TN	0360	
	4/TN	0460	

continued to next page

Device	Device Name	Device Code (HEX)	Address Code
Retentive Timer (Current Value)	SN	0062	Word Address
	1/SN	0162	
	2/SN	0262	
	3/SN	0362	
	4/SN	0462	
Counter (Current Value)	CN	0061	Word Address
	1/CN	0161	
	2/CN	0261	
	3/CN	0361	
	4/CN	0461	
Data Register	D	0000	Word Address
	1/D	0100	
	2/D	0200	
	3/D	0300	
	4/D	0400	
Special Register	SD	0001	Word Address
	1/SD	0101	
	2/SD	0201	
	3/SD	0301	
	4/SD	0401	
Link Register	W	0002	Word Address
	1/W	0102	
	2/W	0202	
	3/W	0302	
	4/W	0402	
Special Link Register	SW	0003	Word Address
	1/SW	0103	
	2/SW	0203	
	3/SW	0303	
	4/SW	0403	

continued to next page

Device	Device Name	Device Code (HEX)	Address Code
File Register (Normal)	R	000F	Word Address
	1/R	010F	
	2/R	020F	
	3/R	030F	
	4/R	040F	
File Register (Block switching is not necessary)	ZR	000E	Word Address
	1/ZR	010E	
	2/ZR	020E	
	3/ZR	030E	
	4/ZR	040E	

continued to next page



Device	Device Name	Device Code (HEX)	Address Code
File Register (0R-31R)	0R	0010	Word Address
	1/0R	0110	
	2/0R	0210	
	3/0R	0310	
	4/0R	0410	
	1R	0011	Word Address
	1/1R	0111	
	2/1R	0211	
	3/1R	0311	
	4/1R	0411	
	2R	0012	Word Address
	1/2R	0112	
	2/2R	0212	
	3/2R	0312	
	4/2R	0412	
	:	:	:
	30R	002E	Word Address
	1/30R	012E	
	2/30R	022E	
	3/30R	032E	
	4/30R	042E	
	31R	002F	Word Address
	1/31R	012F	
	2/31R	022F	
3/31R	032F		
4/31R	042F		

## 7 Error Messages

Error messages are displayed on the screen of Display as follows: "No. : Device Name: Error Message (Error Occurrence Area)". Each description is shown below.

Item	Description
No.	Error No.
Device Name	Name of External Device where error occurs. Device name of External Device is a title of External Device set with GP-Pro EX.(Initial value [PLC1])
Error Message	Displays messages related to the error which occurs.
Error Occurrence Area	<p>Displays IP address or device address of External Device where error occurs, or error codes received from External Device.</p> <p><b>NOTE</b></p> <ul style="list-style-type: none"> <li>• IP address is displayed such as "IP address (Decimal): MAC address (Hex)".</li> <li>• Device address is displayed such as "Address: Device address".</li> <li>• Received error codes are displayed such as "Decimal [Hex]".</li> </ul>

Display Examples of Error Messages

"RHAA035: PLC1: Error has been responded for device write command (Error Code: 2 [02H])"

**NOTE**

- Refer to your External Device manual for details on received error codes.
- Refer to "Display-related errors" in "Maintenance/Troubleshooting Guide" for details on the error messages common to the driver.

### ■ Error Messages Specific to the External Device

Error No.	Message	Description
RHxx128	(Node Name): AGP cannot read or write when "I/O No." and "Station No." are set.	When both "I/O No." and "Station No." in "Request destination module" are set and then access is made to other station, the Display reads or writes data to the Control CPU only in Multiple CPU system.
RHxx129	(Node Name): The specified CPU number does not exist. (Address:(Device Address))	The specified CPU No.1 for read or write does not exist.
RHxx130	(Node Name): The specified CPU number does not exist. (Address:(Device Address))	The specified CPU No.2 for read or write does not exist.
RHxx131	(Node Name): The specified CPU number does not exist. (Address:(Device Address))	The specified CPU No.3 for read or write does not exist.
RHxx132	(Node Name): The specified CPU number does not exist. (Address:(Device Address))	The specified CPU No.4 for read or write does not exist.