



Computer Link Ethernet Driver

1	System Configuration.....	3
2	Selection of External Device	6
3	Example of Communication Setting.....	7
4	Setup Items.....	16
5	Supported Device.....	20
6	Device Code and Address Code.....	26
7	Error Messages.....	30

Introduction

This manual describes how to connect the Display and the External Device (target PLC).

In this manual, the connection procedure will be described by following the sections below:

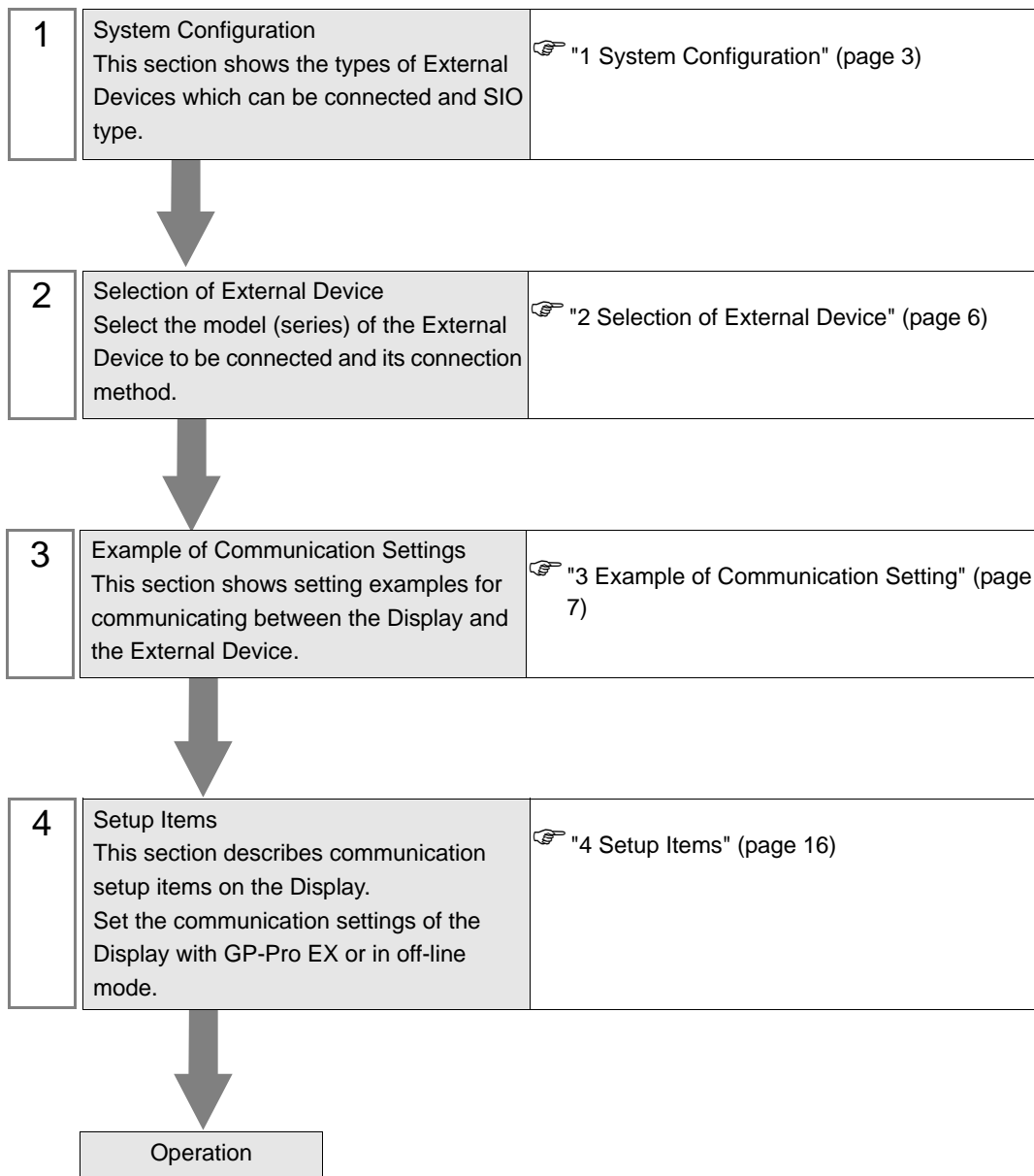

1 System Configuration

The following shows the system configuration where the External Device of TOSHIBA Corporation and the Display are connected.

Series Name	Model/CPU		Link I/F	SIO Type	Setting Example
T Series	T2N		PU-235N PU-245N	Ethernet (UDP)	Setting Example 1 (page 7)
	T3H		EN311		Setting Example 2 (page 9)
	S2T		EN611 EN631 EN651A		Setting Example 4 (page 14)
V Series	Model2000	S2PU22A S2PU32A S2PU72A S2PU72D S2PU82	EN611 EN621 EB621 EN631 EN641 EB641 EN651A EN661 FN661	Ethernet (UDP)	Setting Example 3 (page 11)
	Model3000	S3PU21 S3PU45A S3PU55A S3PU55B S3PU65A	EN711 EN721 EN731 EN741 EN751 EN761 FN711		

NOTE

- The length of the communication cable depends on the I/F link to be used. Please refer to the manual of the External Device for details.

■ Connection Configuration

[1:1 Connection]

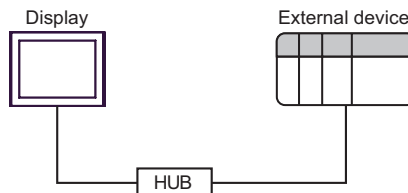

[1:n Connection]

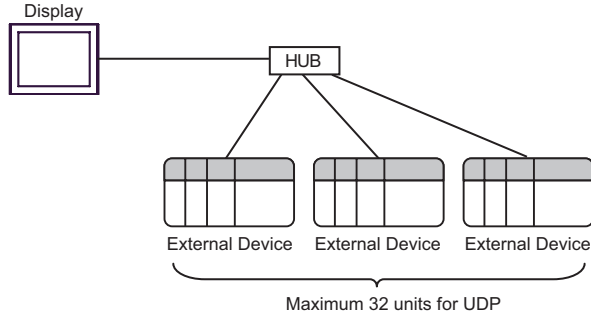

[[n:1 Connection]

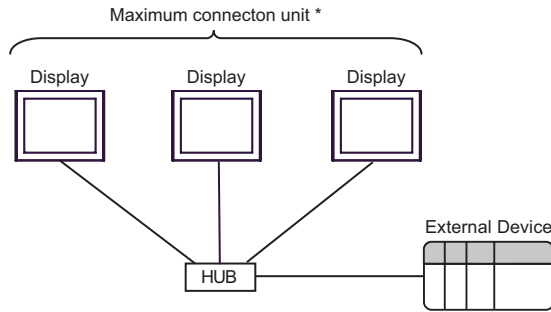

* For T Series, one External Device can connect to up to two Displays.
 For V Series, there is no limit to the number of Displays that can be connected to one External Device.
 Note that more Displays will result in increasing the communication load.

[[n:m Connection]

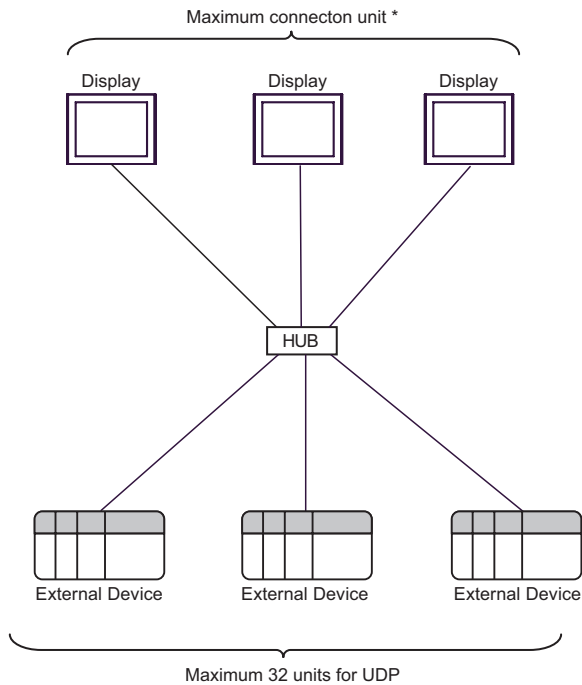

* For T Series, one External Device can connect to up to two Displays.
 For V Series, there is no limit to the number of Displays that can be connected to one External Device.
 Note that more Displays will result in increasing the communication load.

[When using the gateway function]

Example)

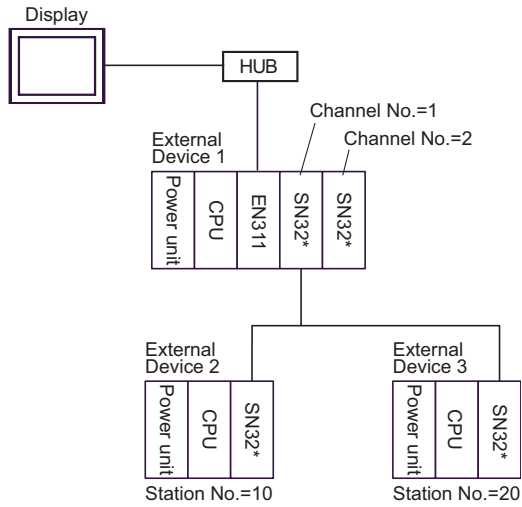

NOTE

- The CPU available with External Device 1 is T3H (Firmware version 1.2 or later) only. For External Device 2 and 3, T3H or S2T only.
- Channel Nos. are assigned in order from near the CPU.
- Station Nos. can be set using the switch on the TOSLINE module (setting range: 1 to 64).

<Setting Example>

To access the above External Device 2 with station No. 10, check [Use gateway function] in the [Device-Specific Settings] window and then configure the following settings.

Item	Setting
Channel No.	1
Station No.	10

These settings provide access to External Device 2 via External Device 1.

2 Selection of External Device

Select the External Device to be connected to the Display.

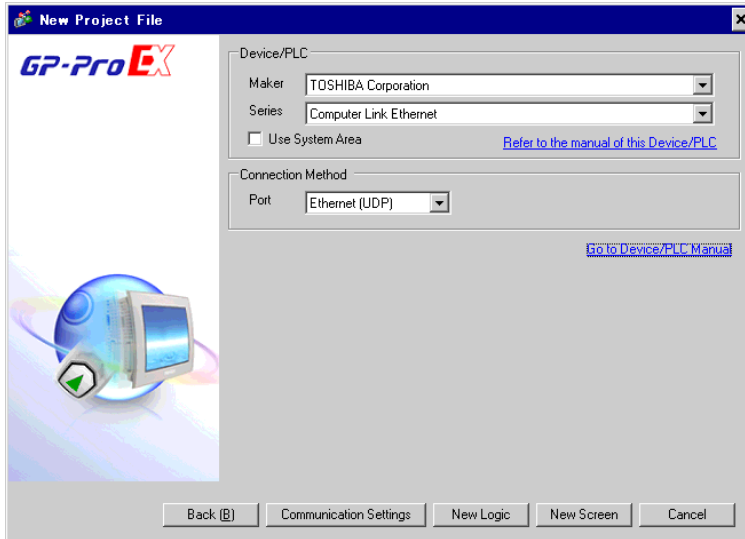

Setup Items	Setup Description
Maker	Select the maker of the External Device to be connected. Select "TOSHIBA Corporation".
Series	Select the model (series) of the External Device to be connected and its connection method. Select "Computer Link Ethernet". Check the External Device which can be connected in "Computer Link Ethernet" in system configuration. ☞ "1 System Configuration" (page 3)
Use System Area	Check this option when you synchronize the system data area of the Display and the device (memory) of the External Device. When they are synchronized, you can use the ladder program of the External Device to switch the display or to display the window on the Display. Cf. GP-Pro EX Reference Manual "Appendix 1.4 LS Area (Direct Access Method)" This can also be set with GP-Pro EX or in off-line mode of the Display. Cf. GP-Pro EX Reference Manual "5.17.6 Setting Guide of [System Setting Window], Setting Guide of [Main Unit Settings], System Area Setting" Cf. Maintenance/Troubleshooting Manual "2.15.1 Common to the Display", Setting Guide of [Main Unit Settings], System Area Setting
Port	Select the port of the Display to be connected to the External Device.

3 Example of Communication Setting

The following shows examples of communication settings of the Display and the External Device, which are recommended by Digital Electronics Corp.

3.1 Setting Example 1

■ Settings of GP-Pro EX

◆ Communication Settings

To display the setting screen, select [Device/PLC Settings] from [System setting window] in workspace.

◆ Device Setting

To display the setting screen, click  ([Setting]) of the External Device you want to set from [Device-Specific Settings] of [Device/PLC Settings].

■ Settings of External Device

To configure communication settings for the Ethernet unit, use the DIP switches on the Ethernet module, and the ladder software (T-PDS32 for Windows). Please refer to the manual of the External Device for more details on the settings.

◆ Using the DIP Switches for Settings

Set the DIP switches on the Ethernet module as shown below.

DIP Switch	Settings	Setup Description
SW01	OFF	Programmer (T-PDS)
SW02	ON	RAM
SW03	OFF	RUN
SW04	OFF	Computer link (communication port)
SW05	OFF	
SW06	OFF	Odd parity (programmable port)

◆ Using the Ladder Software for Settings

1. Start up the ladder software.
2. From the [Option] menu, select [Connection Type].
3. In the [Connection Type] dialog box, select [Direct] and then click [Setting].
4. Select the connection port on the PC, and then click [OK].
5. From the [PLC] menu, select [Online/Offline] to switch to online mode.
6. From the [PLC] menu, select [I/O assign information] - [General I/O assign information].
7. In the [I/O assign information] dialog box, click [Auto assign] to register the I/O module installed in the slot.
8. Set the IP address and port No. of the External Device using the ladder program.

The following is an example where the IP address is set to "192.168.0.1", and the port No. to "1024".

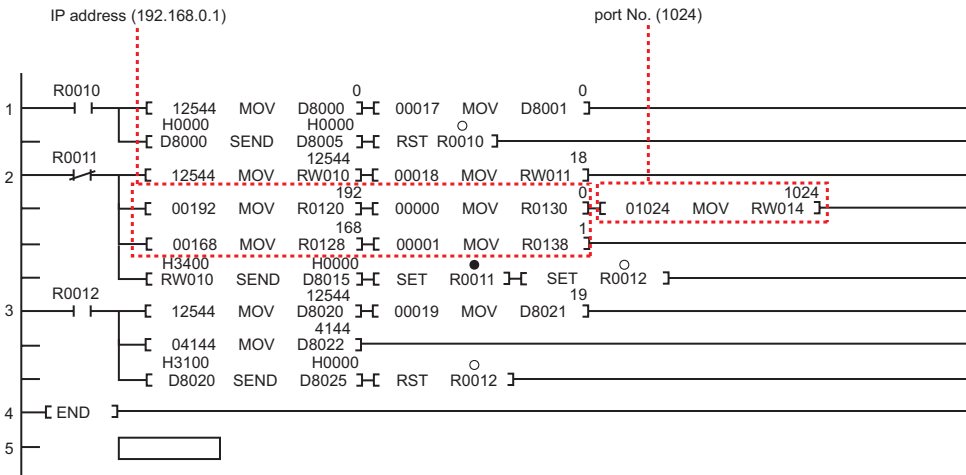

9. Run the created ladder program to reflect the communication settings.

◆ Notes

- Check with the network administrator about the IP address.
- Be sure not to duplicate IP addresses on the same network.

3.2 Setting Example 2

■ Settings of GP-Pro EX

◆ Communication Settings

To display the setting screen, select [Device/PLC Settings] from [System setting window] in workspace.

Device/PLC 1

Summary [Change Device/PLC](#)

Maker TOSHIBA Corporation Series Computer Link Ethernet Port Ethernet (UDP)

Text Data Mode 2 [Change](#)

Communication Settings

Port No. 1024

Timeout 3 (sec)

Retry 2

Wait To Send 0 (ms) [Default](#)

Device-Specific Settings

Allowable Number of Devices/PLCs 32 [Settings](#)

Number	Device Name
1	PLC1

Series=T Series, IP Address=192.168.0.001, Port No.=1024, Use gateway func

◆ Device Setting

To display the setting screen, click  ([Setting]) of the External Device you want to set from [Device-Specific Settings] of [Device/PLC Settings].

Individual Device Settings

PLC1

Series T Series V Series

Please reconfirm all of address settings that you are using if you have changed the series.

IP Address 192.168.0.1

Port No. 1024

TL-S Setting

Use gateway function

Channel No. 1

Station No. 1

[Default](#)

[OK \(O\)](#) [Cancel](#)

■ Settings of External Device

To configure communication settings for the Ethernet unit, use the ladder software (T-PDS32 for Windows).

Please refer to the manual of the External Device for more details on the settings.

◆ Using the Ladder Software for Settings

1. Start up the ladder software.
2. From the [Option] menu, select [Connection Type].
3. In the [Connection Type] dialog box, select [Direct] and then click [Setting].
4. Select the connection port on the PC, and then click [OK].
5. From the [PLC] menu, select [Online/Offline] to switch to online mode.
6. From the [PLC] menu, select [I/O assign information] - [General I/O assign information].
7. In the [I/O assign information] dialog box, click [Auto assign] to register the I/O module installed in the slot.
8. Set the IP address and port No. of the External Device using the ladder program.

The following is an example where the IP address is set to "192.168.0.1", and the port No. to "1024".

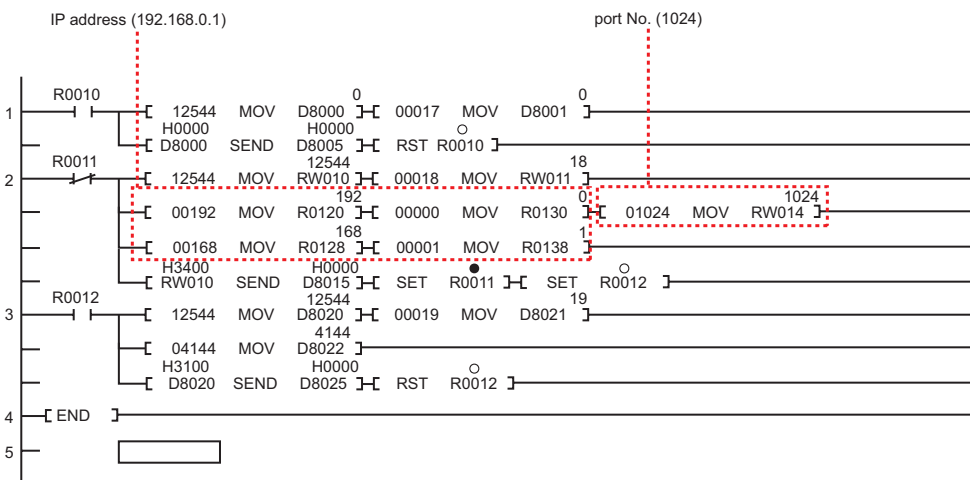

9. Run the created ladder program to reflect the communication settings.

◆ Notes

- Check with the network administrator about the IP address.
- Be sure not to duplicate IP addresses on the same network.

3.3 Setting Example 3

■ Settings of GP-Pro EX

◆ Communication Settings

To display the setting screen, select [Device/PLC Settings] from [System setting window] in workspace.

Device/PLC 1

Summary [Change Device/PLC](#)

Maker: TOSHIBA Corporation Series: Computer Link Ethernet Port: Ethernet (UDP)

Text Data Mode: 2 [Change](#)

Communication Settings

Port No.: 1024

Timeout: 3 (sec)

Retry: 2

Wait To Send: 0 (ms) [Default](#)

Device-Specific Settings

Allowable Number of Devices/PLCs: 32 [Settings](#)

Number	Device Name
1	PLC1

Series=V Series, IP Address=192.168.0.001, Port No.=1024, Use gateway func

◆ Device Setting

To display the setting screen, click [Settings](#) ([Setting]) of the External Device you want to set from [Device-Specific Settings] of [Device/PLC Settings].

Individual Device Settings

PLC1

Series: T Series V Series

Please reconfirm all of address settings that you are using if you have changed the series.

IP Address: 192.168.0.1

Port No.: 1024

TL-S Setting

Use gateway function

Channel No.: 1

Station No.: 1

[Default](#)

[OK \(O\)](#) [Cancel](#)

■ Settings of External Device

To configure communication settings for the Ethernet unit, use the DIP switches on the Ethernet module, and the ladder software (V-Series Engineering Tool 3).

Please refer to the manual of the External Device for more details on the settings.

◆ Using the DIP Switches for Settings

Set the DIP switches on the Ethernet module as shown below.

DIP Switch	Settings	Setup Description
SW08	ON	IP address type: Selectable from the Tool.
SW07	ON	
SW06	ON	IP address free setting: Free
SW05	OFF	Unused
SW04	OFF	Unused
SW03	OFF	Unused
SW02	OFF	Operation mode: Normal
SW01	OFF	

◆ Using the Ladder Software for Settings

1. Start the product manager of V-Series Engineering Tool 3 (for administration) and specify the user product path.
2. Click [Login security setting] to display the [Login security] dialog box.
Enter the user name and password, and then click [OK].
3. From the [Member] menu, select [Add].
Enter a user name and password other than the administrator's, and then click [OK].
4. Start V-Series Engineering Tool 3.
5. Right-click the [System] folder and then select [New] from the menu that appears.
6. Enter a system name and then click [OK].
7. Double-click the created icon with the system name.
8. Right-click the [Station] folder and then select [New] from the menu that appears.
9. Enter a station name and select the station model name in use. Then click [OK].
10. Right-click the [Unit] folder and then select [New] from the menu that appears.
11. Select the No. and model name of the unit in use. Then click [OK].
12. Right-click the [Module] folder and then select [New] from the menu that appears.
13. Configure the CPU module as follows.
In the [Add module] dialog box, select the slot No. and model name of the CPU module in use. Then click [OK].
14. Configure the Ethernet module as follows.
In the [Add module] dialog box, select the slot No. and model name of the Ethernet module in use. Then click [OK].
15. Right-click the CPU module and then select [Module parameter] from the menu that appears.

16. Select the module name and enter the following settings for the External Device. Then click [Write].

Setup Items	Setting
Computer Link 1 Ether. SlotNo	Slot No. where the Ethernet module is installed
Computer Link 1 UDP ProtNo	1024

17. Switch to the Ethernet module name and enter the following settings for the External Device. Then click [Download].

Setup Items	Setting
IP address type	Optional
IP address primary	192.168.0.1
Subnet mask primary	255.255.255.0

18. Click [Close].

19. From the [Tool] menu, select [Transmission parameter setting].

20. In the [Transmission parameter setting] dialog box, set the parameters and then click [OK].

21. Right-click the station model module and select [Download] from the menu that appears to write the communication settings into the External Device.

◆ Notes

- Check with the network administrator about the IP address.
- Be sure not to duplicate IP addresses on the same network.
- For Ethernet communication with the Display unit, use the Ethernet module's EN-A connector. It is not possible to communicate with the Display unit using the EN-B connector.

3.4 Setting Example 4

■ Settings of GP-Pro EX

◆ Communication Settings

To display the setting screen, select [Device/PLC Settings] from [System setting window] in workspace.

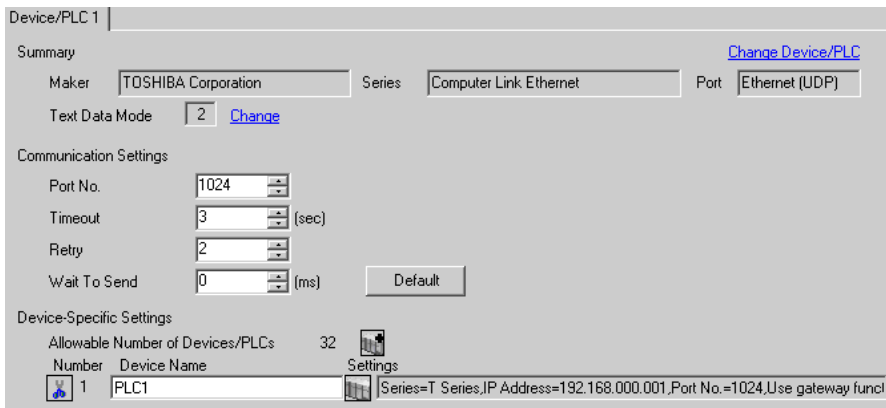

◆ Device Setting

To display the setting screen, click  ([Setting]) of the External Device you want to set from [Device-Specific Settings] of [Device/PLC Settings].



■ Settings of External Device

To configure communication settings for the Ethernet unit, use the DIP switches on the Ethernet module, the ladder software (T-PDS32 for Windows), and the Ethernet parameter configuration tool.

Please refer to the manual of the External Device for more details on the settings.

◆ Using the DIP Switches for Settings

Set the DIP switches on the Ethernet module as shown below.

DIP Switch	Settings	Setup Description
SW08	ON	IP address type: Selectable from the Tool.
SW07	ON	
SW06	ON	IP address free setting: Free
SW05	OFF	Unused
SW04	OFF	Unused
SW03	OFF	Unused
SW02	OFF	Operation mode: Normal
SW01	OFF	

◆ Using the Configuration Tool for Settings

1. Start up the ladder software.
2. From the [Option] menu, select [Connection Type].
3. In the [Connection Type] dialog box, select [Direct] and then click [Setting].
4. Select the connection port on the PC, and then click [OK].
5. From the [PLC] menu, select [Online/Offline] to switch to online mode.
6. From the [PLC] menu, select [I/O assign information] - [General I/O assign information].
7. In the [I/O assign information] dialog box, click [Auto assign] to register the I/O module installed in the slot.
8. Click [OK] to start the writing process.
9. Click the [Data monitor] tool button.
10. Click [Range], and set "SW063" in [Initial address], and "1" in [Block size]. Then click [OK].
11. Double-click "SW063" that appears.
12. Set the port No. "1024" in [Value], and then click [Setting].
13. Click [Close].
14. Start the Ethernet parameter configuration tool.
15. Click [Read].
16. Enter the following settings for the External Device in the [Ethernet parameter settings] dialog box. Then click [Finish].

Setup Items	Setting
IP address	192.168.0.1
Subnet mask	255.255.255.0
Gateway IP address	0.0.0.0

17. Click [Yes] to complete the parameter settings.
18. Reboot the External Device.

4 Setup Items

Set the communication settings of the Display with GP-Pro Ex or in off-line mode of the Display.

The setting of each parameter must be identical to that of the External Device.

☞ "3 Example of Communication Setting" (page 7)

NOTE • Set the Display's IP address in off-line mode.

Cf. Maintenance/Troubleshooting Manual "2.5 Ethernet Settings"

4.1 Setup Items in GP-Pro EX

■ Communication Settings

To display the setting screen, select [Device/PLC Settings] from [System setting window] in workspace.

Setup Items	Setup Description
Port No.	Use an integer from "1024 to 65535" to enter the port No. of the Display.
Timeout	Use an integer from "1 to 127" to enter the time (s) for which the Display waits for the response from the External Device.
Retry	In case of no response from the External Device, use an integer from "0 to 255" to enter how many times the Display retransmits the command.
Wait To Send	Use an integer from "0 to 255" to enter the standby time (ms) from when the Display receives packets until it transmits the next command.

■ Device Setting

To display the setting screen, click  ([Setting]) of the External Device you want to set from [Device-Specific Settings] of [Device/PLC Settings].

To connect multiple External Devices, click  from [Device-Specific Settings] of [Device/PLC Settings] to add External Devices.



Setup Items	Setup Description
Series	Select the model of the External Device.
IP Address	Set the IP address of the External Device. NOTE Check with the network administrator about the IP address. Be sure not to duplicate IP addresses.
Port No.	Use an integer from "1024 to 65535" to enter the port No. of the External Device.
Use gateway function	Check this to use the TOSLINE network for network access.
Channel No.	Use an integer from "1 to 64" to enter the channel No. of the network module in the External Device that serves as a gateway. Available only when [Use gateway function] is checked.
Station No.	Use an integer from "1 to 64" to enter the station No. of the target External Device. Available only when [Use gateway function] is checked.

4.2 Settings in Off-Line Mode

- NOTE** • Refer to the Maintenance/Troubleshooting manual for information on how to enter off-line mode or about the operation.

Cf. Maintenance/Troubleshooting Manual "2.2 Off-line Mode"

■ Communication Settings

To display the setting screen, touch [Device/PLC Settings] from [Peripheral Equipment Settings] in off-line mode. Touch the External Device you want to set from the list that appears.

Comm.	Device			
Computer Link Ethernet		[UDP]	Page 1/1	
Port No.	1024 ▼ ▲			
Timeout(s)	3 ▼ ▲			
Retry	2 ▼ ▲			
Wait To Send(ms)	0 ▼ ▲			
Exit		Back		2007/06/14 16:02:56

Setup Items	Setup Description
Port No.	Use an integer from "1024 to 65535" to enter the port No. of the Display.
Timeout	Use an integer from "1 to 127" to enter the time (s) for which the Display waits for the response from the External Device.
Retry	In case of no response from the External Device, use an integer from "0 to 255" to enter how many times the Display retransmits the command.
Wait To Send	Use an integer from "0 to 255" to enter the standby time (ms) from when the Display receives packets until it transmits the next command.

■ Device Setting

To display the setting screen, touch [Device/PLC Settings] from [Peripheral Equipment Settings]. Touch the External Device you want to set from the list that appears, and touch [Device Settings].

Comm.	Device			
Computer Link Ethernet		[UDP]	Page 1/1	
Device/PLC Name	[PLC1]			
Series	T Series			
IP Address	192 168 0 1			
Port No.	1024			
Gateway function	<input checked="" type="radio"/> OFF <input type="radio"/> ON			
Channel No.	1			
Station No.	1			
Exit		Back		2007/06/14 16:03:07

Setup Items	Setup Description
Device/PLC Name	Select the External Device to set. Device name is the title of the External Device set with GP-Pro EX. (Initial value [PLC1])
Series	Displays the model of the External Device.
IP Address	Set the IP address of the External Device. NOTE Check with the network administrator about the IP address. Be sure not to duplicate IP addresses.
Port No.	Use an integer from "1024 to 65535" to enter the port No. of the External Device.
Gateway function	Select "ON" to use the TOSLINE network for network access.
Channel No.	Use an integer from "1 to 64" to enter the channel No. of the network module in the External Device that serves as a gateway. Available only when [Use gateway function] is set to ON.
Station No.	Use an integer from "1 to 64" to enter the station No. of the target External Device. Available only when [Use gateway function] is set to ON.





5 Supported Device

The following table shows the range of supported device addresses.

5.1 T Series

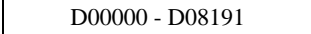
■ T2N

 : This address can be specified as system data area.

Device	Bit Address	Word Address	32 bit	Remarks
Input	X00000 - X0127F	XW0000 - XW0127		
Output	Y00000 - Y0127F	YW0000 - YW0127		
Auxiliary Relay	R00000 - R0255F	RW0000 - RW0255		
Special Relay	S00000 - S0255F	SW0000 - SW0255		
Link Relay	L00000 - L0255F	LW0000 - LW0255		
Timer Register	-	T0000 - T0511		
Timer Device	T.0000 - T.0511	-		*1
Counter Register	-	C0000 - C0511		
Counter Device	C.0000 - C.0511	-		*1
Link Register Relay	Z00000 - Z0999F	-		
Data Register	-	 D00000 - D08191		
Link Register	-	W00000 - W02047		
File Register	-	F00000 - F01023		

*1 Write disable

NOTE

- Please refer to the GP-Pro EX Reference Manual for system data area.

Cf. GP-Pro EX Reference Manual "Appendix 1.4 LS Area (Direct Access Method)"

- Please refer to the precautions on manual notation for icons in the table.

 "Manual Symbols and Terminology"

■ T3H/S2T

 : This address can be specified as system data area.

Device	Bit Address	Word Address	32 bit	Remarks
Input	X00000 - X0511F	XW0000 - XW0511	L/H	
Output	Y00000 - Y0511F	YW0000 - YW0511		
Auxiliary Relay	R00000 - R0999F	RW0000 - RW0999		
Special Relay	S00000 - S0255F	SW0000 - SW0255		
Link Relay	L00000 - L0255F	LW0000 - LW0255		
Timer Register	-	T0000 - T0999		
Timer Device	T.0000 - T.0999	-		*1
Counter Register	-	C0000 - C0511		
Counter Device	C.0000 - C.0511	-		*1
Link Register Relay	Z00000 - Z0999F	-		
Data Register	-	D00000 - D08191		Bit F
Link Register	-	W00000 - W02047		Bit F
File Register	-	F00000 - F32767		Bit F

*1 Write disable

NOTE

- Please refer to the GP-Pro EX Reference Manual for system data area.

Cf. GP-Pro EX Reference Manual "Appendix 1.4 LS Area (Direct Access Method)"



- Please refer to the precautions on manual notation for icons in the table.

 "Manual Symbols and Terminology"

5.2 V Series

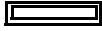
■ model2000 (S2PU22/S2PU32/S2PU72/S2PU82)

 : This address can be specified as system data area.

Device	Bit Address	Word Address	32 bit	Remarks
I Variable	IX00000 - IX3071F	IW0000 - IW3071	L/H	
O Variable	QX00000 - QX3071F	QW0000 - QW3071		
System	S00000 - S0511F	SW0000 - SW0511		
Data	-	DW00000 - DW04095		
Data	R00000 - R4095F	RW00000 - RW4095		*1
User Register ^{*2}	-	F00000 - F32767		

*1 The R and RW devices and the D device are in the same area. To write bits from the Display, specify the R device.

*2 Available only to S2PU82.

NOTE

- There are the local variable, controller global variable and station global variable besides the above devices, though you cannot access them from the Display.
- Please refer to the GP-Pro EX Reference Manual for system data area.

Cf. GP-Pro EX Reference Manual "Appendix 1.4 LS Area (Direct Access Method)"

- Please refer to the precautions on manual notation for icons in the table.

 "Manual Symbols and Terminology"

■ model3000 (S3PU21)

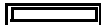
 : This address can be specified as system data area.

Device	Bit Address	Word Address	32 bit	Remarks
I Variable	IX00000 - IX3071F	IW0000 - IW3071	[L/H]	
O Variable	QX00000 - QX3071F	QW0000 - QW3071		
System	S00000 - S0511F	SW0000 - SW0511		
Data	-	DW00000 - DW04095		[Bit F]
Data	R00000 - R4095F	RW00000 - RW4095		*1
User Register	-	F00000 - F32767		[Bit F]

*1 The R and RW devices and the D device are in the same area. To write bits from the Display, specify the R device.

NOTE

- There are the local variable, controller global variable and station global variable besides the above devices, though you cannot access them from the Display.
- Please refer to the GP-Pro EX Reference Manual for system data area.



Cf. GP-Pro EX Reference Manual "Appendix 1.4 LS Area (Direct Access Method)"

- Please refer to the precautions on manual notation for icons in the table.

 "Manual Symbols and Terminology"

■ model3000 (S3PU45)

 : This address can be specified as system data area.

Device	Bit Address	Word Address	32 bit	Remarks
I Variable	IX00000 - IX5119F	IW0000 - IW5119	L/H	
O Variable	QX00000 - QX5119F	QW0000 - QW5119		
System	S00000 - S0511F	SW0000 - SW0511		
Data	-	DW00000 - DW04095		
Data	R00000 - R4095F	RW00000 - RW4095		*1
User Register	-	F00000 - F32767		

*1 The R and RW devices and the D device are in the same area. To write bits from the Display, specify the R device.

NOTE

- There are the local variable, controller global variable and station global variable besides the above devices, though you cannot access them from the Display.
- Please refer to the GP-Pro EX Reference Manual for system data area.

Cf. GP-Pro EX Reference Manual "Appendix 1.4 LS Area (Direct Access Method)"

- Please refer to the precautions on manual notation for icons in the table.

 "Manual Symbols and Terminology"

■ model3000 (S3PU55/S3PU65)

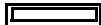
 : This address can be specified as system data area.

Device	Bit Address	Word Address	32 bit	Remarks
I Variable	IX00000 - IX8191F	IW00000 - IW8191	[L/H]	
O Variable	QX00000 - QX8191F	QW00000 - QW8191		
System	S000000 - S0511F	SW00000 - SW0511		
Data	-	DW00000 - DW04095		[Bit F]
Data	R000000 - R4095F	RW000000 - RW4095		*1
User Register	-	F000000 - F32767		[Bit F]

*1 The R and RW devices and the D device are in the same area. To write bits from the Display, specify the R device.

NOTE

- There are the local variable, controller global variable and station global variable besides the above devices, though you cannot access them from the Display.
- Please refer to the GP-Pro EX Reference Manual for system data area.

Cf. GP-Pro EX Reference Manual "Appendix 1.4 LS Area (Direct Access Method)"

- Please refer to the precautions on manual notation for icons in the table.

 "Manual Symbols and Terminology"

6 Device Code and Address Code

Use device code and address code when you select "Device Type & Address" for the address type of the data display or other devices.

6.1 T Series

■ T2N

Device	Device Name	Device Code (HEX)	Address Code
Input Register	XW	0080	Word Address
Input Device	X		Word Address
Output Register	YW	0081	Word Address
Output Device	Y		Word Address
Auxiliary Register	RW	0084	Word Address
Auxiliary Relay	R		Word Address
Special Register	SW	0085	Word Address
Special Relay	S		Word Address
Link Relay Register	LW	0086	Word Address
Link Relay Device	L		Word Address
Timer Register	T	0060	Word Address
Counter Register	C	0061	Word Address
Data Register	D	0000	Word Address
Link Register	W	0001	Word Address
File Register	F	0002	Word Address

■ T3H/S2T

Device	Device Name	Device Code (HEX)	Address Code
Input Register	XW	0080	Word Address
Input Device	X		Word Address
Output Register	YW	0081	Word Address
Output Device	Y		Word Address
Auxiliary Register	RW	0084	Word Address
Auxiliary Relay	R		Word Address
Special Register	SW	0085	Word Address
Special Relay	S		Word Address
Link Relay Register	LW	0086	Word Address
Link Relay Device	L		Word Address
Timer Register	T	0060	Word Address
Counter Register	C	0061	Word Address
Data Register	D	0000	Word Address
Link Register	W	0001	Word Address
File Register	F	0002	Word Address

6.2 V Series

■ model2000 (S2PU82)

Device	Device Name	Device Code (HEX)	Address Code
I Variable Register	IW	0080	Word Address
I Variable Device	IX		Word Address
Q Variable Register	QW	0081	Word Address
Q Variable Device	QX		Word Address
System Register	SW	0085	Word Address
System Device	S		Word Address
Data Register	DW	0000	Word Address
User Register	F	0002	Word Address
Data Register	RW	0084	Word Address
Data Device	R		Word Address

■ model2000 (S2PU22/S2PU32/S2PU72)

Device	Device Name	Device Code (HEX)	Address Code
I Variable Register	IW	0080	Word Address
I Variable Device	IX		Word Address
Q Variable Register	QW	0081	Word Address
Q Variable Device	QX		Word Address
System Register	SW	0085	Word Address
System Device	S		Word Address
Data	DW	0000	Word Address
Data Register	RW	0084	Word Address
Data Device	R		Word Address

■ model3000 (S3PU45)

Device	Device Name	Device Code (HEX)	Address Code
I Variable Register	IW	0080	Word Address
I Variable Device	IX		Word Address
Q Variable Register	QW	0081	Word Address
Q Variable Device	QX		Word Address
System Register	SW	0085	Word Address
System Device	S		Word Address
Data	DW	0000	Word Address
User Register	F	0002	Word Address
Data Register	RW	0084	Word Address
Data Device	R		Word Address

■ model3000 (S3PU55/S3PU65)

Device	Device Name	Device Code (HEX)	Address Code
I Variable Register	IW	0080	Word Address
I Variable Device	IX		Word Address
Q Variable Register	QW	0081	Word Address
Q Variable Device	QX		Word Address
System Register	SW	0085	Word Address
System Device	S		Word Address
Data	DW	0000	Word Address
User Register	F	0002	Word Address
Data Register	RW	0084	Word Address
Data Device	R		Word Address

7 Error Messages

Error messages are displayed on the Display screen as follows: "No.: Device Name: Error Message (Error Occurrence Area)". Each description is shown below.

Item	Description
No.	Error No.
Device Name	Name of the External Device where an error has occurred. Device name is the title of the External Device set with GP-Pro EX. ((Initial value [PLC1])
Error Message	Displays messages related to an error that has occurred.
Error Occurrence Area	<p>Displays the IP address or device address of the External Device where an error has occurred, or error codes received from the External Device.</p> <p>NOTE</p> <ul style="list-style-type: none"> • IP address is displayed as "IP address (Decimal): MAC address (Hex)". • Device address is displayed as "Address: Device address". • Received error codes are displayed as "Decimal [Hex]".

Display Examples of Error Messages

"RHAA035: PLC1: Error has been responded for device write command (Error Code: 2[02H])"

NOTE

- Refer to your External Device manual for details on received error codes.
- Refer to "When an error is displayed (Error Code List)" in "Maintenance/Troubleshooting Manual" for details on the error messages common to the driver.

■ Error Codes Specific to the External Device

Error codes specific to the External Device are shown below.

Error Code	Description
115 (73H)	Register No./Size error. This error occurs if you access an address outside the area.