



SIMATIC S5 CPU Direct Driver

1	System Configuration.....	3
2	Selection of External Device	6
3	Example of Communication Setting.....	7
4	Setup Items	8
5	Cable Diagram	13
6	Supported Device.....	14
7	Device Code and Address Code.....	15
8	Error Messages	16

PREFACE

This manual describes how to connect the Display and the External Device (target PLC).

In this manual, the connection procedure will be described by following the below sections:

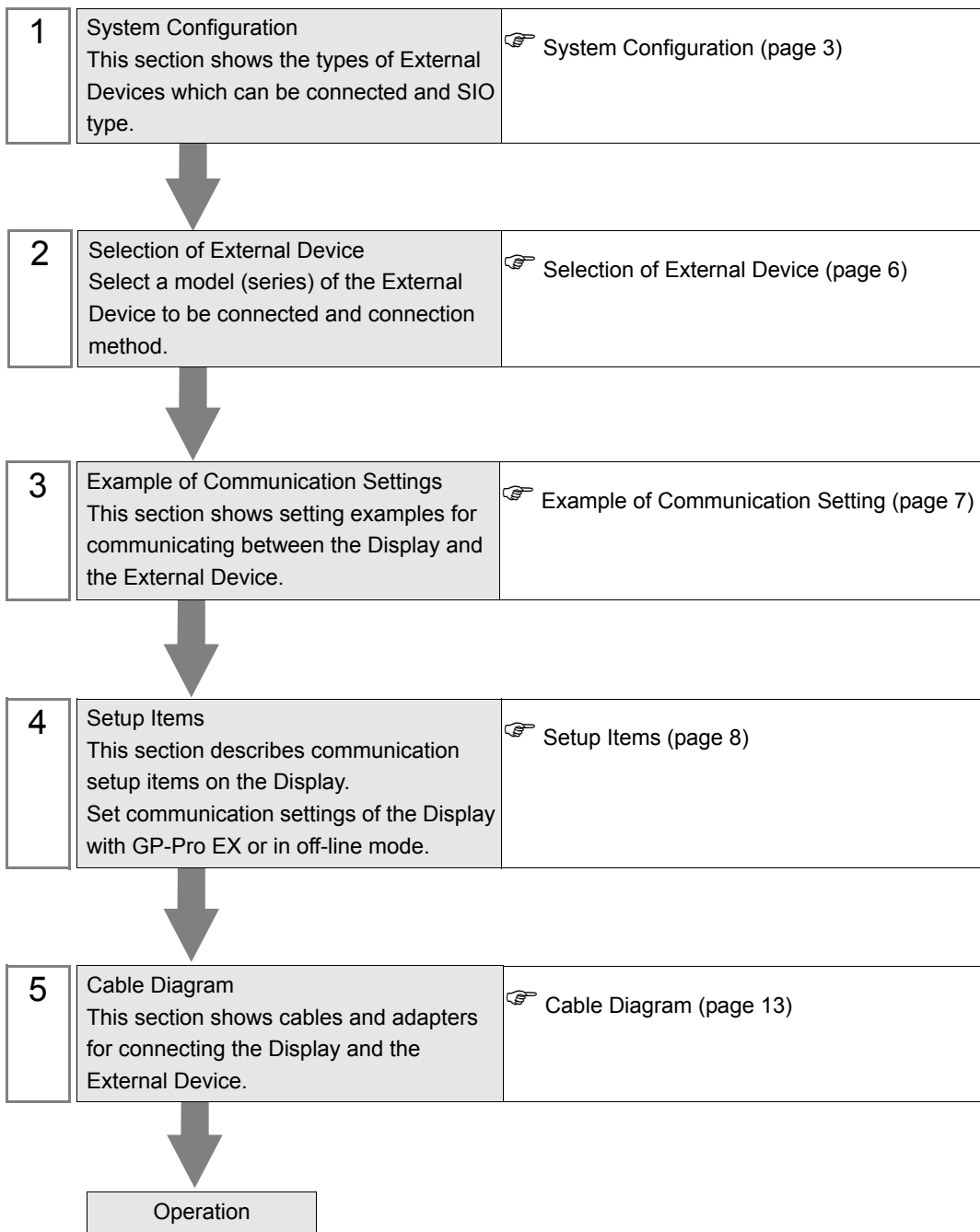

1 System Configuration

The system configuration in the case when the External Device of Siemens AG and the Display are connected is shown.

Series Name	CPU	Link I/F	SIO Type	Setting Example	Cable Diagram
Series 90U-115U	CPU 90U CPU 95U CPU 100 CPU 102 CPU 103 CPU 941 CPU 942 CPU 943 CPU 944	PG port on CPU	RS232C	Setting Example 1 (page 7)	Cable Diagram 1 (page 13)
Series 135U/155U	CPU 922 CPU 928 CPU 928B	PG port on CPU	RS232C		

■ Connection Configuration

[1:1 Connection]

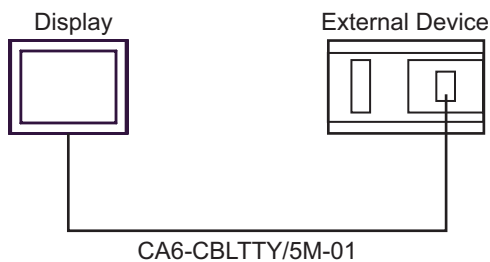

■ IPC COM Port

When connecting IPC with an External Device, the COM port used depends on the series and SIO type. Please refer to the IPC manual for details.

Usable port

Series	Usable Port		
	RS-232C	RS-422/485(4 wire)	RS-422/485(2 wire)
PS-2000B	COM1 ^{*1} , COM2, COM3 ^{*1} , COM4	-	-
PS-3450A, PS-3451A, PS3000-BA, PS3001-BD	COM1, COM2 ^{*1*2}	COM2 ^{*1*2}	COM2 ^{*1*2}
PS-3650A, PS-3651A	COM1 ^{*1}	-	-
PS-3700A (Pentium®4-M) PS-3710A	COM1 ^{*1} , COM2 ^{*1} , COM3 ^{*2} , COM4	COM3 ^{*2}	COM3 ^{*2}
PS-3711A	COM1 ^{*1} , COM2 ^{*2}	COM2 ^{*2}	COM2 ^{*2}
PL-3000B, PL-3600T, PL-3600K, PL-3700T, PL-3700K, PL-3900T	COM1 ^{*1*2} , COM2 ^{*1} , COM3, COM4	COM1 ^{*1*2}	COM1 ^{*1*2}

*1 The RI/5V can be switched. Use the IPC's switch to change if necessary.

*2 Set up the SIO type with the DIP switch. Please set up as follows according to SIO type to be used.

DIP switch setting: RS-232C

DIP switch	Setting	Description
1	OFF ^{*1}	Reserved (always OFF)
2	OFF	SIO type: RS-232C
3	OFF	
4	OFF	Output mode of SD (TXD) data: Always output
5	OFF	Terminal resistance (220Ω) insertion to SD (TXD): None
6	OFF	Terminal resistance (220Ω) insertion to RD (RXD): None
7	OFF	Short-circuit of SDA (TXA) and RDA (RXA): Not available
8	OFF	Short-circuit of SDB (TXB) and RDB (RXB): Not available
9	OFF	RS (RTS) Auto control mode: Disabled
10	OFF	

*1 When using PS-3450A, PS-3451A, PS3000-BA and PS3001-BD, turn ON the set value.

DIP switch setting: RS-422/485 (4 wire)

DIP switch	Setting	Description
1	OFF	Reserved (always OFF)
2	ON	SIO type: RS-422/485
3	ON	
4	OFF	Output mode of SD (TXD) data: Always output
5	OFF	Terminal resistance (220Ω) insertion to SD (TXD): None
6	OFF	Terminal resistance (220Ω) insertion to RD (RXD): None
7	OFF	Short-circuit of SDA (TXA) and RDA (RXA): Not available
8	OFF	Short-circuit of SDB (TXB) and RDB (RXB): Not available
9	OFF	RS (RTS) Auto control mode: Disabled
10	OFF	

DIP switch setting: RS-422/485 (2 wire)

DIP switch	Setting	Description
1	OFF	Reserved (always OFF)
2	ON	SIO type: RS-422/485
3	ON	
4	OFF	Output mode of SD (TXD) data: Always output
5	OFF	Terminal resistance (220Ω) insertion to SD (TXD): None
6	OFF	Terminal resistance (220Ω) insertion to RD (RXD): None
7	ON	Short-circuit of SDA (TXA) and RDA (RXA): Available
8	ON	Short-circuit of SDB (TXB) and RDB (RXB): Available
9	ON	RS (RTS) Auto control mode: Enabled
10	ON	

2 Selection of External Device

Select the External Device to be connected to the Display.

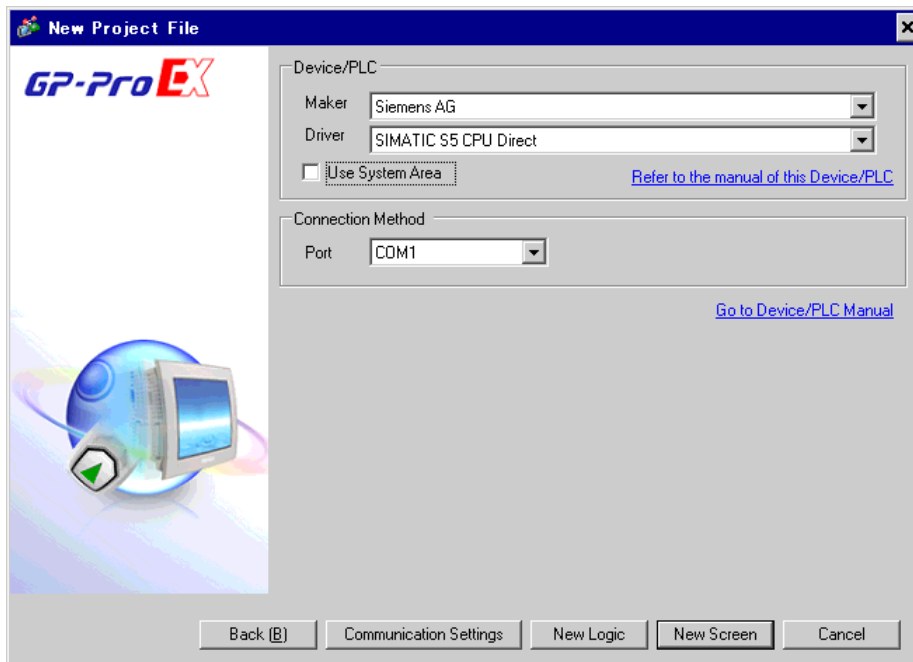

Setup Items	Setup Description
Maker	Select the maker of the External Device to be connected. Select "Siemens AG".
Driver	Select a model (series) of the External Device to be connected and connection method. Select "SIMATIC S5 CPU Direct". Check the External Device which can be connected in "SIMATIC S5 CPU Direct" in system configuration. ☞ System Configuration (page 3)
Use System Area	Check this option when you synchronize the system data area of the Display and the device (memory) of the External Device. When synchronized, you can use the ladder program of the External Device to switch the display or display the window on the Display. Cf. GP-Pro EX Reference Manual "Appendix 1.4 LS Area (Direct Access Method)" This can be also set with GP-Pro EX or in off-line mode of the Display. Cf. GP-Pro EX Reference Manual " 5.17.6 Setting Guide of [System Setting Window]■[Main Unit Settings] Settings Guide◆System Area Setting" Cf. Maintenance/Troubleshooting "2.15.1 Settings common to all Display models◆System Area Settings"
Port	Select the Display port to be connected to the External Device.

3 Example of Communication Setting

Examples of communication settings of the Display and the External Device, recommended by Digital Electronics Corp., are shown.

3.1 Setting Example 1

■ Settings of GP-Pro EX

◆◆ Communication Settings

To display the setting screen, select [Device/PLC Settings] from [System setting window] in workspace.

◆◆ Device Setting

To display the setting screen, click  ([Setting]) of the External Device you want to set from [Device-Specific Settings] of [Device/PLC Settings].

■ Settings of External Device

The communication setting of the External Device is fixed.

You need not set it.

4 Setup Items

Set communication settings of the Display with GP-Pro Ex or in off-line mode of the Display.

The setting of each parameter must be identical to that of External Device.

 Example of Communication Setting (page 7)

4.1 Setup Items in GP-Pro EX

■ Communication Settings

To display the setting screen, select [Device/PLC Settings] from [System setting window] in workspace.

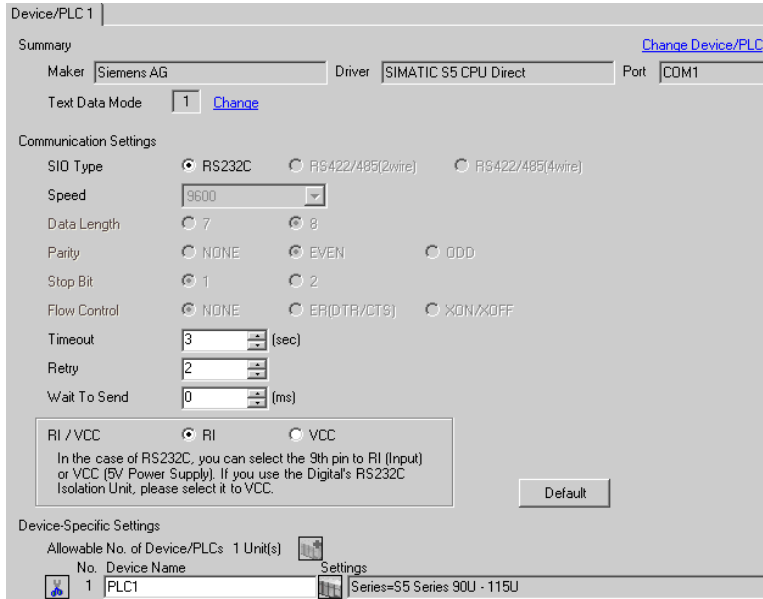

Device/PLC 1

Summary [Change Device/PLC](#)

Maker Driver Port

Text Data Mode [Change](#)

Communication Settings

SIO Type RS232C RS422/485[2wire] RS422/485[4wire]

Speed

Data Length 7 8

Parity NONE EVEN ODD

Stop Bit 1 2

Flow Control NONE ER(DTR/DT9) XON/XOFF

Timeout (sec)

Retry

Wait To Send (ms)

RI / VCC RI VCC

In the case of RS232C, you can select the 9th pin to RI (Input) or VCC (5V Power Supply). If you use the Digital's RS232C Isolation Unit, please select it to VCC.

Device-Specific Settings

Allowable No. of Device/PLCs 1 Unit(s)

No. Device Name Series=55 Series 90U - 115U

Setup Items	Setup Description
SIO Type	Displays the SIO type to communicate with the External Device.
Speed	Displays the communication speed between the External Device and the Display.
Data Length	Displays data length.
Parity	Displays how to check parity.
Stop Bit	Displays stop bit length.
Flow Control	Displays the communication control method to prevent overflow of transmission and reception data.
Timeout	Use an integer from "1 to 127" to enter the time (s) for which the Display waits for the response from the External Device.
Retry	In case of no response from the External Device, use an integer from "0 to 255" to enter how many times the Display retransmits the command.
Wait To Send	Use an integer from "0 to 255" to enter standby time (ms) for the Display from receiving packets to transmitting next commands.
RI/VCC	You can switch RI/VCC of the 9th pin if you select RS232C for SIO type. It is necessary to change RI/5V by changeover switch of IPC when connect with IPC. Please refer to the manual of the IPC for more detail.

■ Device Setting

To display the setting screen, click  ([Setting]) of the External Device you want to set from [Device-Specific Settings] of [Device/PLC Settings].



Setup Items	Setup Description
Series	Select a model of the External Device.

4.2 Settings in Off-Line Mode

- NOTE** • Refer to the Maintenance/Troubleshooting manual for information on how to enter off-line mode or about the operation.

Cf. Maintenance/Troubleshooting Manual "2.2 Off-line Mode"

- The number of the setup items to be displayed for 1 page in the off-line mode depends on the Display in use. Please refer to the Reference manual for details.

■ Communication Settings

To display the setting screen, touch [Device/PLC Settings] from [Peripheral Equipment Settings] in the off-line mode. Touch the External Device you want to set from the displayed list.

Comm.	Device	Option		
SIMATIC S5 CPU Direct [COM1] Page 1/1				
SIO Type		RS232C		
Speed		9600		
Data Length		8		
Parity		EVEN		
Stop Bit		1		
Flow Control		NONE		
Timeout(s)		3 ▼ ▲		
Retry		2 ▼ ▲		
Wait To Send(ms)		0 ▼ ▲		
Exit		Back		2006/10/12 09:50:10

Setup Items	Setup Description
SIO Type	<p>Select the SIO type to communicate with the External Device.</p> <p>IMPORTANT</p> <p>To make the communication settings correctly, confirm the serial interface specifications of Display unit for [SIO Type]. We cannot guarantee the operation if a communication type that the serial interface does not support is specified. For details concerning the serial interface specifications, refer to the manual for Display unit.</p>
Speed	Displays the communication speed between the External Device and the Display.
Data Length	Displays data length.
Parity	Displays how to check parity.
Stop Bit	Displays stop bit length.
Flow Control	Displays the communication control method to prevent overflow of transmission and reception data.
Timeout	Use an integer from "1 to 127" to enter the time (s) for which the Display waits for the response from the External Device.

Setup Items	Setup Description
Retry	In case of no response from the External Device, use an integer from "0 to 255" to enter how many times the Display retransmits the command.
Wait To Send	Use an integer from "0 to 255" to enter standby time (ms) for the Display from receiving packets to transmitting next commands.

■ Device Setting

To display the setting screen, touch [Device/PLC Settings] from [Peripheral Equipment Settings]. Touch the External Device you want to set from the displayed list, and touch [Device].

Comm.	Device	Option		
SIMATIC S5 CPU Direct		[COM1]	Page 1/1	
Device/PLC Name		[PLC1]		
Series		S5 90U-115U		
Exit		Back		2006/10/12 09:50:15

Setup Items	Setup Description
Device/PLC Name	Select the External Device to set. Device name is a title of the External Device set with GP-Pro EX. (Initial value [PLC1])
Series	Display a model of the External Device.

■ Option

To display the setting screen, touch [Device/PLC Settings] from [Peripheral Equipment Settings].

Touch the External Device you want to set from the displayed list, and touch [Option].

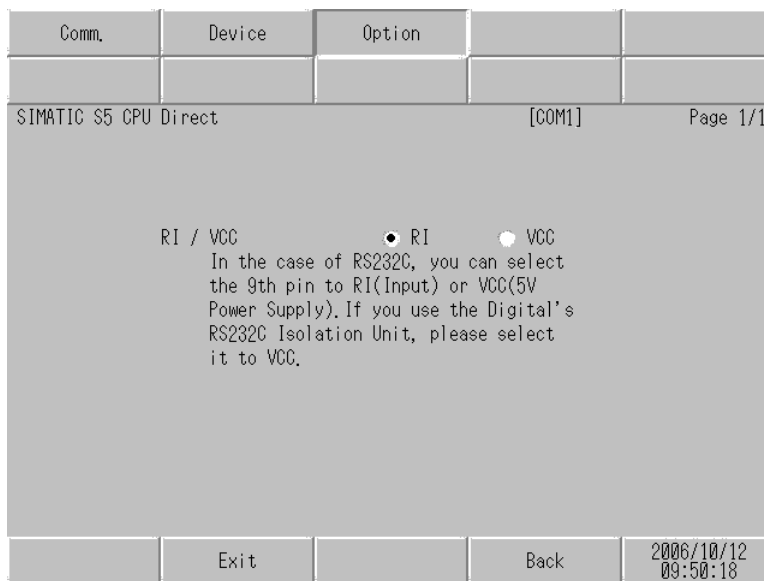

Setup Items	Setup Description
RI/VCC	You can switch RI/VCC of the 9th pin if you select RS232C for SIO type. It is necessary to change RI/5V by changeover switch of IPC when connect with IPC. Please refer to the manual of the IPC for more detail.

NOTE

- GP-4100 series do not have the [Option] setting in the off-line mode.

5 Cable Diagram

The cable diagram shown below may be different from the cable diagram recommended by Siemens AG. Please be assured there is no operational problem in applying the cable diagram shown in this manual.

- The FG pin of the main body of the External Device must be D-class grounded. Please refer to the manual of the External Device for more details.
- SG and FG are connected inside the Display. When connecting SG to the External Device, design the system not to form short-circuit loop.
- Connect the isolation unit, when communication is not stabilized under the influence of a noise etc..

Cable Diagram 1

Display (Connection Port)	Cable		Remarks
GP3000 (COM1) ST (COM1) IPC*1 PC/AT	1A	SIEMENS TTY converter cable by Pro-face CA6-CBLTTY/5M-01 (5m)	
GP-4105 (COM1)	1B	User-created cable + SIEMENS TTY converter cable by Pro-face CA6-CBLTTY/5M-01 (5m)	

*1 Only the COM port which can communicate by RS-232C can be used.

☞ ■ IPC COM Port (page 4)

1A)

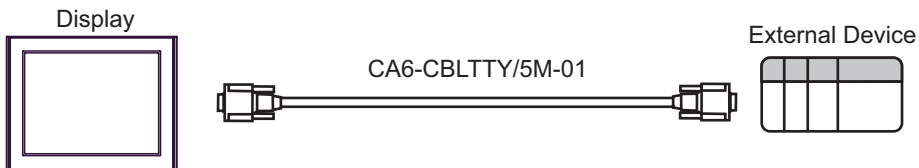

1B)

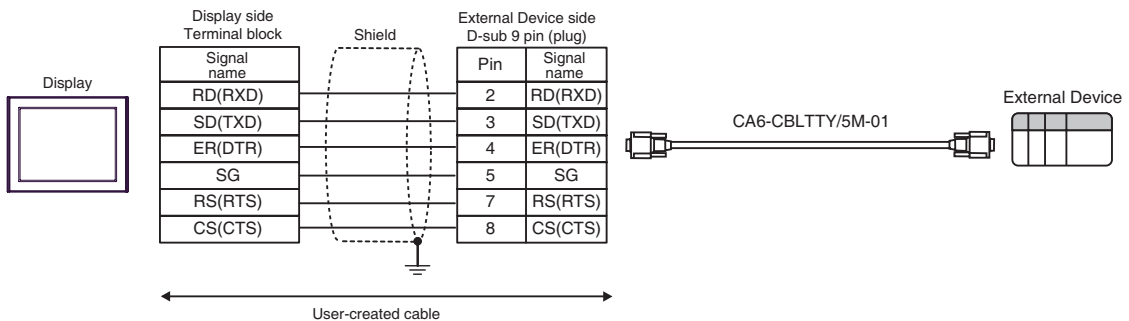







6 Supported Device

Range of supported device address is shown in the table below.

6.1 Series 90U-115U

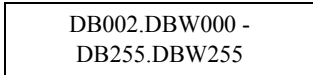
 : This address can be specified as system data area.

Device	Bit Address	Word Address	32 bit	Remarks
Input Relay	I000.0 - I127.7	IW000 - IW126		
Output Relay	Q000.0 - Q127.7	QW000 - QW126		
Internal Relay	F000.0 - F255.7	FW000 - FW254		
Timer	-	T000 - T255		
Counter	-	C000 - C255		
Data Block	DB002.DBX000.00 - DB255.DBX255.15	 DB002.DBW000 - DB255.DBW255		

NOTE

- Please refer to the GP-Pro EX Reference Manual for system data area.







Cf. GP-Pro EX Reference Manual "Appendix 1.4 LS Area (Direct Access Method)"

- Please refer to the precautions on manual notation for icons in the table.

 "Manual Symbols and Terminology"

6.2 Series 135U/155U

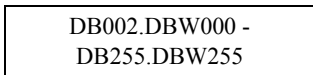
 : This address can be specified as system data area.

Device	Bit Address	Word Address	32 bit	Remarks
Input Relay	I000.0 - I127.7	IW000 - IW126		
Output Relay	Q000.0 - Q127.7	QW000 - QW126		
Internal Relay	F000.0 - F255.7	FW000 - FW254		
Timer	-	T000 - T255		
Counter	-	C000 - C255		
Data Block	DB002.DBX000.00 - DB255.DBX255.15	 DB002.DBW000 - DB255.DBW255		
Extended Data Block	X001.XBX000.00 - X255.XBX255.15	X001.XBW000 - X255.XBW255		

NOTE

- Please refer to the GP-Pro EX Reference Manual for system data area.

Cf. GP-Pro EX Reference Manual "Appendix 1.4 LS Area (Direct Access Method)"

- Please refer to the precautions on manual notation for icons in the table.

 "Manual Symbols and Terminology"

7 Device Code and Address Code

Use device code and address code when you select "Device Type & Address" for the address type in data displays.

7.1 Series 90U-115U

Device	Device Name	Device Code (HEX)	Address Code
Data Block	DB	0000	Value of (Data Block No. x 0x10000) + word address
Input	I	0080	Value of word address divided by 2
Output	Q	0081	Value of word address divided by 2
Internal Relay	F	0082	Value of word address divided by 2
Timer	T	0060	Word Address
Counter	C	0061	Word Address

7.2 Series 135U/155U

Device	Device Name	Device Code (HEX)	Address Code
Data Block	DB	0000	Value of (Data Block No. x 0x10000) + word address
Extended Data Block	X	0001	Value of (Extended Data Block No. x 0x10000) + word address
Input	I	0080	Value of word address divided by 2
Output	Q	0081	Value of word address divided by 2
Internal Relay	F	0082	Value of word address divided by 2
Timer	T	0060	Word Address
Counter	C	0061	Word Address

8 Error Messages

Error messages are displayed on the Display screen as follows: "No. : Device Name: Error Message(Error Occurrence Area)". Each description is shown below.

Item	Description
No.	Error No.
Device Name	Name of the External Device where error occurs. Device name is a title of the External Device set with GP-Pro EX. ((Initial value [PLC1])
Error Message	Displays messages related to the error which occurs.
Error Occurrence Area	<p>Displays IP address or device address of the External Device where error occurs, or error codes received from the External Device.</p> <p>NOTE</p> <ul style="list-style-type: none"> • IP address is displayed such as "IP address (Decimal): MAC address (Hex)". • Device address is displayed such as "Address: Device address". • Received error codes are displayed such as "Decimal[Hex]".

Display Examples of Error Messages

"RHAA035: PLC1: Error has been responded for device write command (Error Code: 2[02H])"

-
- NOTE**
- Refer to your External Device manual for details on received error codes.
 - Refer to "When an error is displayed (Error Code List)" in "Maintenance/Troubleshooting Manual" for details on the error messages common to the driver.
-