

28



Using Logic Functions

This chapter explains what you can do using the GP-Pro EX Logic Feature. First, read "28.1 Settings Menu" (page 28-2), and then go to the corresponding page for further instructions.

28.1	Settings Menu	28-2
28.2	Switching Screens Using a Logic Program	28-4
28.3	Generating a Pulse at One Second Intervals	28-5
28.4	Entering the Timer Value on the Screen	28-6
28.5	Moving Data Between Connection Devices	28-7

28.1 Settings Menu

By using logic functions and performing easy to use Windows operations, you can create a logic program that conforms to international standard IEC61131-3.

The logic program you write downloads and runs on the GP. Also, variables created in your logic program can be shared with other screen functions (such as switches and lamps).

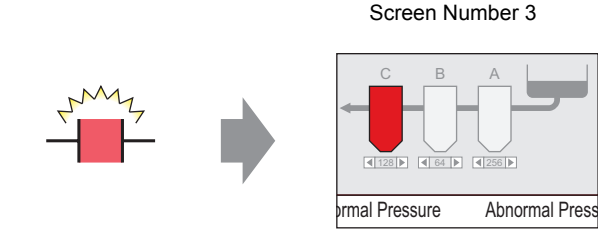
Switching Screens Using a Logic Program	
 <p>When the alarm A bit turns ON...</p> <p>Displays screen number 3.</p>	<p>☞ "28.2 Switching Screens Using a Logic Program" (page 28-4)</p>

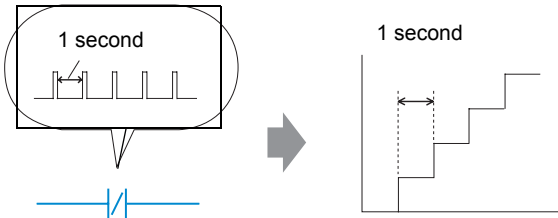
Generating a Pulse at One Second Intervals	
<p>Using the counter, you can create a circuit that counts up every 1 second.</p> 	<p>☞ "28.3 Generating a Pulse at One Second Intervals" (page 28-5)</p>

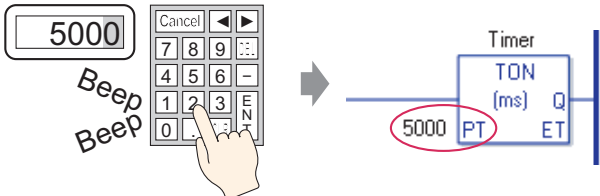
Entering the Timer Value on the Screen	
<p>A numeric keypad appears and the numeric values can be changed.</p> 	<p>☞ "28.4 Entering the Timer Value on the Screen" (page 28-6)</p>

Moving Data Between Connection Devices

You can specify the device address for a connection device using the logic program.

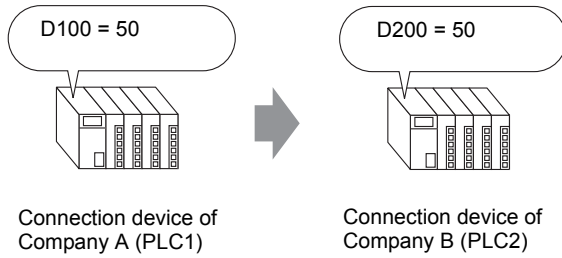

☞ "28.5 Moving Data Between Connection Devices" (page 28-7)

28.2 Switching Screens Using a Logic Program

28.2.1 Introduction

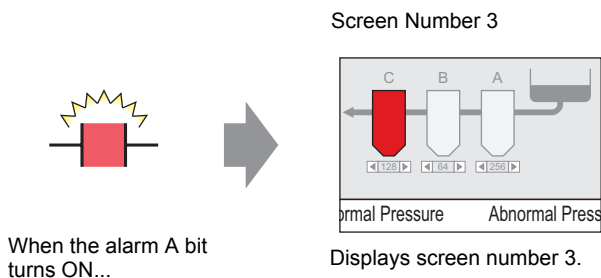

■ Complete Logic Program

In the following example of a Logic program, a trigger sets up a MOV P command to store the screen value in a system variable (#H_ChangeScreenNo).



NOTE

- For more information on commands, refer to the following.
 "31.14 Operation (Move)" (page 31-201)

■ Function Summary

You can change the screen on the GP by storing the number of the screen you want to display in the system variable #H_ChangeScreenNo.

1. When the "alarm A" bit turns ON, "3" is stored in #H_ChangeScreenNo.
2. The display changes to screen number 3.

28.3 Generating a Pulse at One Second Intervals

28.3.1 Introduction

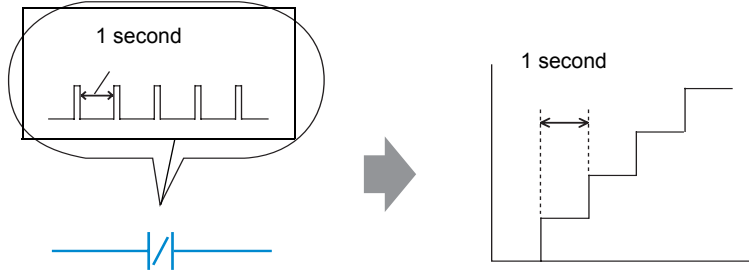

■ Complete Logic Program

In the following example logic program, there is a normally closed contact set to "timer variable.Q" and a timer instruction set to 1 second (1000 ms).



NOTE

- For more information on commands, refer to the following.
☞ "31.8 Timer Instruction" (page 31-85)

■ Function Summary

The basic operation of the timer instruction (TON) is to repeatedly turn on "timer variable.Q" after the defined time has elapsed.

1. After 1 second (1000ms), the TON command "Clock1SecondPulse.Q" turns on.
2. Upon the next scan, the TON command will be reset after the normally closed contact turns on.
3. When TON command is reset, the normally closed contact will be turned off and the TON command will return to a conducting state.

As a result, the normally closed contact "Clock1SecondPulse.Q" repeatedly turns OFF for one second and turns ON upon the next scan.

☞ Chapter 31 Instructions (page 31-1)

28.4 Entering the Timer Value on the Screen

28.4.1 Introduction

A numeric keypad appears and the numeric values can be changed.

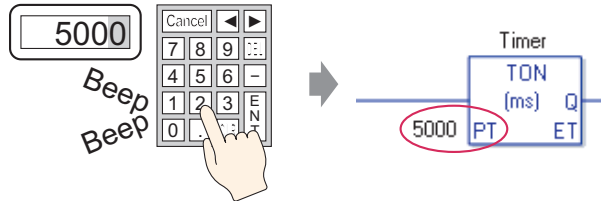

■ Complete Logic Program

The following example of a logic program uses a timer instruction set to five seconds, or 5000 milliseconds.

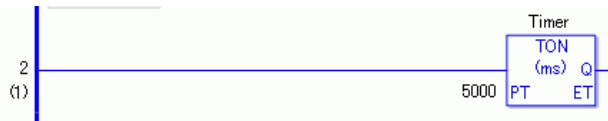

NOTE

- For more information on commands, refer to the following.
 "31.8 Timer Instruction" (page 31-85)

■ Screen Settings Example

In the Data Display [Monitor Address], enter "Timer.PT". Select the [Data Entry] check box. "Timer.PT" stores the timer preset time of five seconds. You can change the value using the Data Display.

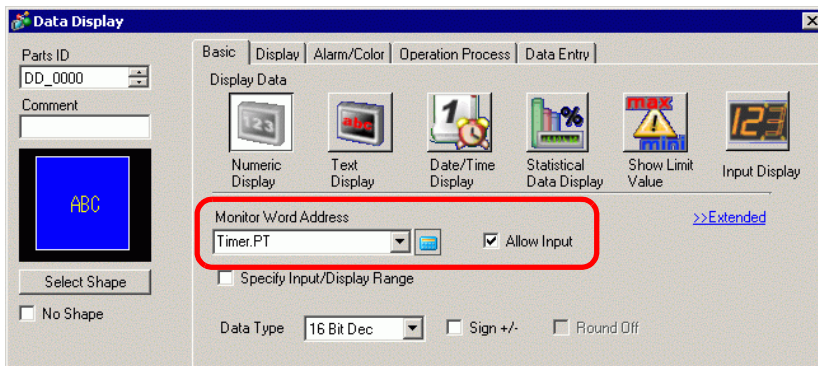

■ Function Summary

When you use the Data Display to enter a value, it changes the timer preset time "Timer.PT".

28.5 Moving Data Between Connection Devices

28.5.1 Introduction

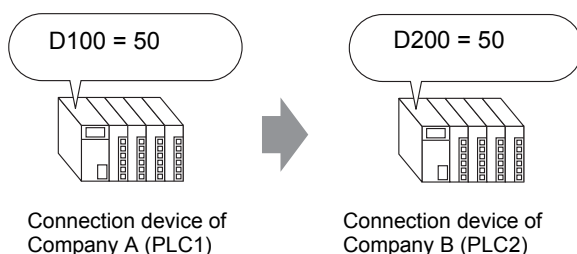

■ Complete Logic Program

In the following example of a logic program, the MOV instruction copies data between connection devices.

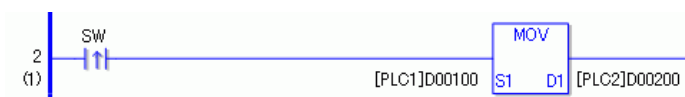

NOTE

- For more information on commands, refer to the following.
 "31.14 Operation (Move)" (page 31-201)

■ Function Summary

When turning on the bit that initiates the write operation, data in [PLC1]D0100 is stored in [PLC2]D0200.

