

# MP Series SIO (Extension) Driver

1	System Configuration.....	3
2	Selection of External Device .....	6
3	Example of Communication Setting.....	7
4	Setup Items.....	9
5	Cable Diagram .....	14
6	Supported Device.....	15
7	Device Code and Address Code.....	16
8	Error Messages.....	17

## Introduction

This manual describes how to connect the Display and the External Device (target PLC).

In this manual, the connection procedure will be described by following the below sections:

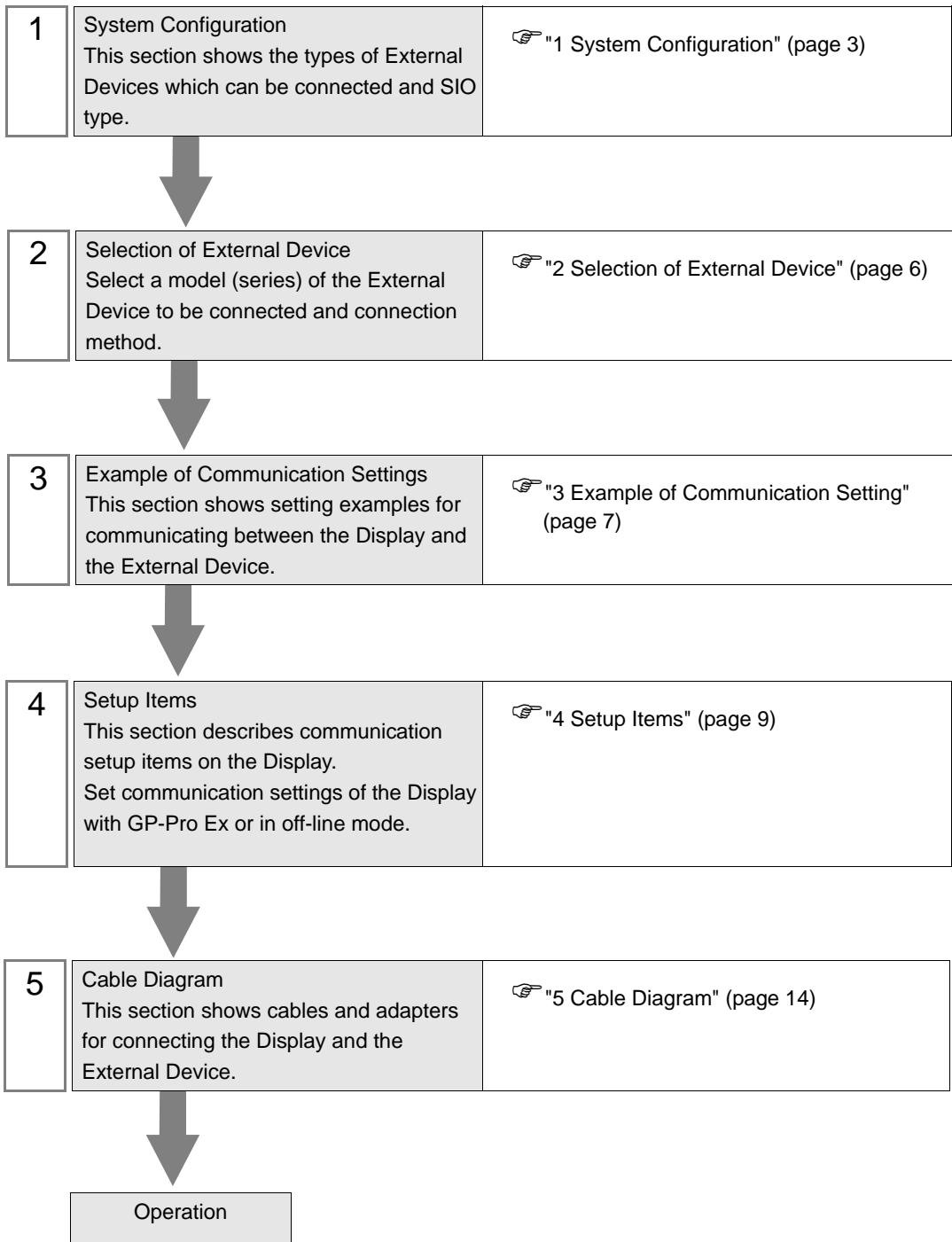

# 1 System Configuration

The system configuration in the case when the External Device of YASKAWA Electric Corporation and the Display are connected is shown.

Series	CPU	Link I/F	SIO Type	Setting Example	Cable Diagram
MP2000	MP2300 MP2200 MP2310 MP2300S	Serial port on 218IF-01	RS232C	"3.1 Setting Example 1" (page 7)	" Cable Diagram 1" (page 14)
		Serial port on 218IF-02	RS232C	"3.1 Setting Example 1" (page 7)	" Cable Diagram 1" (page 14)
		Serial port on 260IF-01	RS232C	"3.1 Setting Example 1" (page 7)	" Cable Diagram 1" (page 14)
		Serial port on 261IF-01	RS232C	"3.1 Setting Example 1" (page 7)	" Cable Diagram 1" (page 14)
		PORT on 217IF-01	RS232C	"3.1 Setting Example 1" (page 7)	" Cable Diagram 1" (page 14)

## ■ Connection Configuration

- 1:1 Connection



## ■ IPC COM Port

When connecting IPC with an External Device, the COM port used depends on the series and SIO type. Please refer to the IPC manual for details.

### Usable port

Series	Usable Port		
	RS-232C	RS-422/485(4 wire)	RS-422/485(2 wire)
PS-2000B	COM1 <sup>*1</sup> , COM2, COM3 <sup>*1</sup> , COM4	-	-
PS-3450A, PS-3451A, PS3000-BA, PS3001-BD	COM1, COM2 <sup>*1*2</sup>	COM2 <sup>*1*2</sup>	COM2 <sup>*1*2</sup>
PS-3650A, PS-3651A	COM1 <sup>*1</sup>	-	-
PS-3700A (Pentium®4-M) PS-3710A	COM1 <sup>*1</sup> , COM2 <sup>*1</sup> , COM3 <sup>*2</sup> , COM4	COM3 <sup>*2</sup>	COM3 <sup>*2</sup>
PS-3711A	COM1 <sup>*1</sup> , COM2 <sup>*2</sup>	COM2 <sup>*2</sup>	COM2 <sup>*2</sup>
PL-3000B, PL-3600T, PL-3600K, PL-3700T, PL-3700K, PL-3900T	COM1 <sup>*1*2</sup> , COM2 <sup>*1</sup> , COM3, COM4	COM1 <sup>*1*2</sup>	COM1 <sup>*1*2</sup>

\*1 The RI/5V can be switched. Use the IPC's switch to change if necessary.

\*2 Set up the SIO type with the DIP switch. Please set up as follows according to SIO type to be used.

### DIP switch setting: RS-232C

DIP switch	Setting	Description
1	OFF <sup>*1</sup>	Reserved (always OFF)
2	OFF	SIO type: RS-232C
3	OFF	
4	OFF	Output mode of SD (TXD) data: Always output
5	OFF	Terminal resistance (220Ω) insertion to SD (TXD): None
6	OFF	Terminal resistance (220Ω) insertion to RD (RXD): None
7	OFF	Short-circuit of SDA (TXA) and RDA (RXA): Not available
8	OFF	Short-circuit of SDB (TXB) and RDB (RXB): Not available
9	OFF	RS (RTS) Auto control mode: Disabled
10	OFF	

\*1 When using PS-3450A, PS-3451A, PS3000-BA and PS3001-BD, turn ON the set value.

## DIP switch setting: RS-422/485 (4 wire)

DIP switch	Setting	Description
1	OFF	Reserved (always OFF)
2	ON	SIO type: RS-422/485
3	ON	
4	OFF	Output mode of SD (TXD) data: Always output
5	OFF	Terminal resistance (220Ω) insertion to SD (TXD): None
6	OFF	Terminal resistance (220Ω) insertion to RD (RXD): None
7	OFF	Short-circuit of SDA (TXA) and RDA (RXA): Not available
8	OFF	Short-circuit of SDB (TXB) and RDB (RXB): Not available
9	OFF	RS (RTS) Auto control mode: Disabled
10	OFF	

## DIP switch setting: RS-422/485 (2 wire)

DIP switch	Setting	Description
1	OFF	Reserved (always OFF)
2	ON	SIO type: RS-422/485
3	ON	
4	OFF	Output mode of SD (TXD) data: Always output
5	OFF	Terminal resistance (220Ω) insertion to SD (TXD): None
6	OFF	Terminal resistance (220Ω) insertion to RD (RXD): None
7	ON	Short-circuit of SDA (TXA) and RDA (RXA): Available
8	ON	Short-circuit of SDB (TXB) and RDB (RXB): Available
9	ON	RS (RTS) Auto control mode: Enabled
10	ON	

## 2 Selection of External Device

Select the External Device to be connected to the Display.

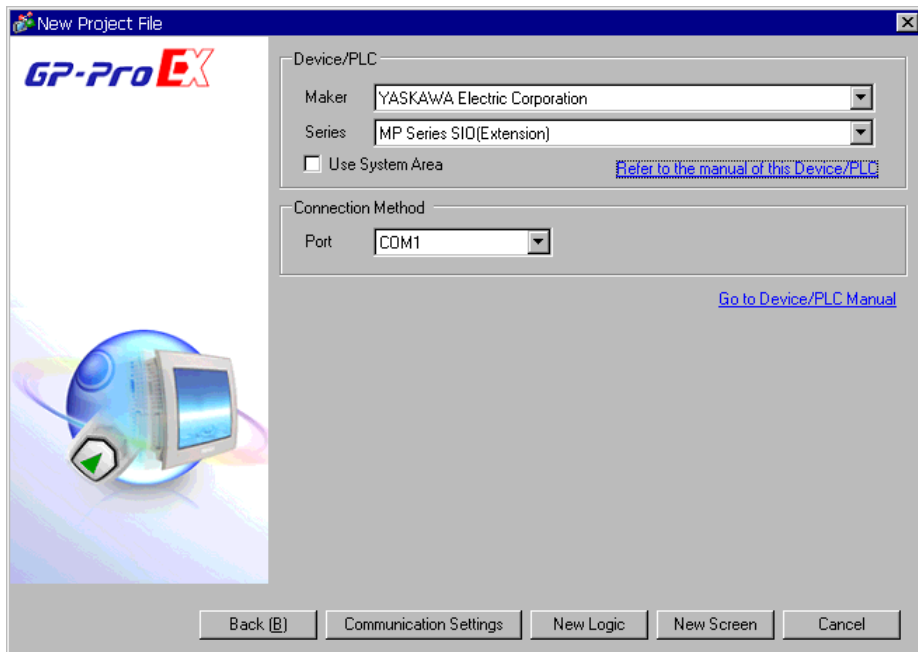

Setup Items	Setup Description
Maker	Select the maker of the External Device to be connected. Select "YASKAWA Electric Corporation".
Driver	Select a model (series) of the External Device to be connected and connection method. Select "MP Series SIO (Extension)". Check the External Device which can be connected in "MP Series SIO (Extension)" in system configuration. ☞ "1 System Configuration" (page 3)
Use System Area	Check this option when you synchronize the system data area of Display and the device (memory) of External Device. When synchronized, you can use the ladder program of External Device to switch the display or display the window on the display. Cf. GP-Pro EX Reference Manual "Appendix 1.4 LS Area (Direct Access Method)" This can be also set with GP-Pro EX or in off-line mode of Display. Cf. GP-Pro EX Reference Manual " 5.17.6 Setting Guide of [System Setting Window]■[Main Unit Settings] Settings Guide◆System Area Setting" Cf. Maintenance/Troubleshooting "2.15.1 Settings common to all Display models ◆System Area Settings"
Port	Select the Display port to be connected to the External Device.

### 3 Example of Communication Setting

Examples of communication settings of the Display and the External Device, recommended by Pro-face, are shown.

#### 3.1 Setting Example 1

##### ■ Settings of GP-Pro EX

##### ◆ Communication Settings

To display the setting screen, select [Device/PLC Settings] from [System setting window] in workspace.

The screenshot shows the 'Device/PLC 1' settings window. The 'Summary' section includes:
 

- Maker: YASKAWA Electric Corporation
- Driver: MP Series SIO(Extension)
- Port: COM1
- Text Data Mode: 1 (Change)

 The 'Communication Settings' section includes:
 

- SIO Type:  RS232C,  RS422/485(2wire),  RS422/485(4wire)
- Speed: 19200
- Data Length:  7,  8
- Parity:  NONE,  EVEN,  ODD
- Stop Bit:  1,  2
- Flow Control:  NONE,  ER(DTR/CTS),  XON/XOFF
- Timeout: 3 (sec)
- Retry: 2
- Wait To Send: 0 (ms)
- RI / VCC:  RI,  VCC

 A note states: 'In the case of RS232C, you can select the 9th pin to RI (Input) or VCC (5V Power Supply). If you use the Digital's RS232C Isolation Unit, please select it to VCC.' A 'Default' button is present.
   
 The 'Device-Specific Settings' section shows:
 

- Allowable No. of Device/PLCs: 1 Unit(s)
- Table:
 

No.	Device Name	Settings
1	PLC1	Station No.=1

##### ◆ Device Setting

To display the setting screen, click ([Setting]) of External Device you want to set from [Device-Specific Settings] of [Device/PLC Settings].

When you connect multiple External Device, click from [Device-Specific Settings] of [Device/PLC Settings] to add another External Device.

The 'Individual Device Settings' dialog box for PLC1 shows:
 

- Station No.: 1
- Buttons: Default, OK (O), Cancel

## ■ Settings of External Device

Communication setting of communication module by ladder software (MPE720).

Please refer to the manual of external device for more detail.

### ◆ Ladder Software Setting

- 1 Start ladder software, make an order folder and a PLC folder in a root folder.
- 2 Click the right button of the PLC which select logon in the displayed menu.

- |             |  |
|-------------|--|
| <b>NOTE</b> | <ul style="list-style-type: none"> <li>• Logon after confirming that a check does not begin [online] of a displayed menu.</li> <li>• Refer to User's Manual of the PLC about a method of logon.</li> </ul> |
|-------------|--|

- 3 Double-click the [Definition folder]-[Module constitution] of the PLC folder, and display [Engineering Manager].
- 4 Select the rack classification and communication module, the pull-down menu in [Controller] of [Engineering Manager].  
Set the number corresponding to the slot number that a communication module uses.  
Select the communication module, setting contents are displayed to [Module details] of [Engineering Manager].
- 5 Double-click the number part at No. in [Module details].  
Double-click the slot number connecting the ethernet unit.

Setup Items	Setup Description
Transmission Protocol	MEMOBUS
Master/Slave	Slave
Device Address	Device address of the External Device
Serial I/F	RS-232C
Transmission Mode	RTU
Data Length	8Bit
Parity Bit	even
Stop Bit	1Stop
Baud Rate	19.2K
Sending	Disable
Automatically Reception	Disable

- 6 Double-click the "No.1", and set serial communication.  
Use serial communication setting to forward communication setting and the ladder program to the PLC.
- 7 Save setting content and finish [Engineering Manager].
- 8 DIP switch "INIT" of a communication module is ON and spend a power supply.
- 9 Forward communication setting to a communication module.
- 10 Logon the PLC at online and write in the data which transferred at flash memory.
- 11 Power supply of PLC is OFF and DIP switch of the INIT is OFF, after spend the power supply of PLC.



## 4 Setup Items

Set communication settings of the Display with GP-Pro EX or in off-line mode of the Display.

The setting of each parameter must be identical to that of External Device.

☞ "3 Example of Communication Setting" (page 7)

### 4.1 Setup Items in GP-Pro EX

#### ■ Communication Settings

To display the setting screen, select [Device/PLC Settings] from [System setting window] in workspace.

The screenshot shows the 'Device/PLC 1' settings window. At the top, there's a 'Summary' section with fields for 'Maker' (YASKAWA Electric Corporation), 'Driver' (MP Series SIO(Extension)), and 'Port' (COM1). Below this is 'Text Data Mode' set to '1'. The 'Communication Settings' section includes radio buttons for 'SIO Type' (RS232C, RS422/485(2wire), RS422/485(4wire)), a 'Speed' dropdown (19200), 'Data Length' (7, 8), 'Parity' (NONE, EVEN, ODD), 'Stop Bit' (1, 2), and 'Flow Control' (NONE, ER(DTR/CTS), XON/XOFF). There are also spinners for 'Timeout' (3 sec), 'Retry' (2), and 'Wait To Send' (0 ms). A 'RI / VCC' section has radio buttons for 'RI' and 'VCC', with a note: 'In the case of RS232C, you can select the 9th pin to RI (Input) or VCC (5V Power Supply). If you use the Digital's RS232C Isolation Unit, please select it to VCC.' A 'Default' button is present. The 'Device-Specific Settings' section at the bottom shows 'Allowable No. of Device/PLCs' as '1 Unit(s)' and a table with columns 'No.', 'Device Name', and 'Settings', containing one entry: '1', 'PLC1', and 'Station No.=1'.

Setup Items	Setup Description
SIO Type	Display the SIO type to communicate with the External Device.
Speed	Select speed between External Device and Display.
Data Length	Select data length.
Parity	Select how to check parity.
Stop Bit	Select stop bit length.
Flow Control	Select the communication control method to prevent overflow of transmission and reception data.
Timeout	Use an integer from 1 to 127 to enter the time (s) for which Display waits for the response from External Device.
Retry	In case of no response from the External Device, use an integer from 0 to 255 to enter how many times the Display retransmits the command.
Wait To Send	Use an integer from 0 to 255 to enter standby time (ms) for the Display from receiving packets to transmitting next commands.
RI/VCC	You can switch RI/VCC of the 9th pin when you select RS232C for SIO type. It is necessary to change RI/5V by changeover switch of IPC when connect with IPC. Please refer to the manual of the IPC for more detail.

## ◆ Device Setting

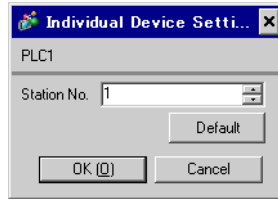

Setup Items	Setup Description
Station No.	Enter a station number of the External Device, using 1 to 63.

## 4.2 Setup Items in Off-Line Mode

- NOTE** • Refer to the Maintenance/Troubleshooting manual for information on how to enter off-line mode or about the operation.

Cf. Maintenance/Troubleshooting Manual "2.2 Off-line Mode"

### ◆ Communication Settings

To display the setting screen, touch [Device/PLC Settings] from [Peripheral Settings] in off-line mode. Touch the External Device you want to set from the displayed list.

Comm.	Device	Option		
MP Series SIO(Extension)			[COM1]	Page 1/1
SIO Type		RS232C		
Speed		19200		
Data Length		<input type="radio"/> 7 <input checked="" type="radio"/> 8		
Parity		<input type="radio"/> NONE <input checked="" type="radio"/> EVEN <input type="radio"/> ODD		
Stop Bit		<input checked="" type="radio"/> 1 <input type="radio"/> 2		
Flow Control		ER(DTR/CTS)		
Timeout(s)		3	▼ ▲	
Retry		2	▼ ▲	
Wait To Send(ms)		0	▼ ▲	
	Exit		Back	2038/08/01 14:40:07

Setup Items	Setup Description
SIO Type	Select the SIO type to communicate with the External Device. <b>IMPORTANT</b> To make the communication settings correctly, confirm the serial interface specifications of Display unit for [SIO Type]. We cannot guarantee the operation if a communication type that the serial interface does not support is specified. For details concerning the serial interface specifications, refer to the manual for Display unit.
Speed	Select speed between External Device and Display.
Data Length	Select data length.
Parity	Select how to check parity.
Stop Bit	Select stop bit length.
Flow Control	Select the communication control method to prevent overflow of transmission and reception data.
Timeout (s)	Use an integer from 1 to 127 to enter the time (s) for which Display waits for the response from External Device.
Retry	In case of no response from the External Device, use an integer from 0 to 255 to enter how many times the Display retransmits the command.

continued to next page

Setup Items	Setup Description
Wait To Send (ms)	Use an integer from 0 to 255 to enter standby time (ms) for the Display from receiving packets to transmitting next commands.

#### ◆ Device Setting

To display the setting screen, touch [Device/PLC Settings] from [Peripheral Settings]. Touch the External Device you want to set from the displayed list, and touch [Device].

Comm.	Device	Option		
MP Series SIO(Extension)		[COM1]	Page 1/1	
Device/PLC Name		[PLC1] ▼		
Station No.		[ 1 ] ▼ ▲		
Exit		Back		2038/08/01 14:40:09

Setup Items	Setup Description
Device/PLC Name	Select the External Device for device setting. Device name is a title of External Device set with GP-Pro EX.(Initial value [PLC1])
Station No.	Enter a station number of the External Device, using 1 to 63.

## ◆ Option

To display the setting screen, touch [Device/PLC Settings] from [Peripheral Settings]. Touch the External Device you want to set from the displayed list, and touch [Option].

Comm.	Device	Option		
MP Series SIO(Extension)		[COM1]	Page 1/1	
RI / VCC <input checked="" type="radio"/> RI <input type="radio"/> VCC In the case of RS232C, you can select the 9th pin to RI(Input) or VCC(5V Power Supply). If you use the Digital's RS232C Isolation Unit, please select it to VCC.				
	Exit		Back	2038/08/01 14:40:11

Setup Items	Setup Description
RI/VCC	You can switch RI/VCC of the 9th pin when you select RS232C for SIO type. It is necessary to change RI/5V by changeover switch of IPC when connect with IPC. Please refer to the manual of the IPC for more detail.

## 5 Cable Diagram

The cable diagram shown below may be different from the cable diagram recommended by Fuji Electric Corporation. Please be assured there is no operational problem in applying the cable diagram shown in this manual.

- The FG pin of the External Device body must be D-class grounded. Please refer to the manual of the External Device for more details.
- SG and FG are connected inside the Display. When connecting SG to the External Device, design the system not to form short-circuit loop.
- Connect the isolation unit, when communication is not stabilized under the influence of a noise etc..

Cable Diagram 1

Display (Connection Port)	Cable	Remarks
GP (COM1) ST (COM1) IPC*1 PC/AT	Your own cable	The cable length must be 15m or less.

\*1 Only the COM port which can communicate by RS-232C can be used.

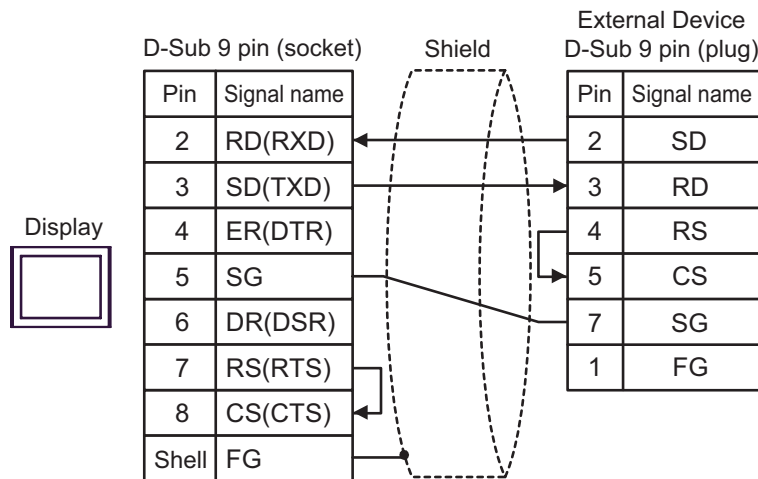

 ■ IPC COM Port (page 4)



## 6 Supported Device

Range of supported device address is shown in the table below. Please note that the actually supported range of the devices varies depending on the External Device to be used. Please check the actual range in the manual of your connecting equipment.

 This address can be specified as system data area.

Device	Bit Address	Word Address	32 bits	Notes
System registers	SB000000 - SB08191F	SW00000 - SW08191		
Input registers	IB000000 - IBFFFFFF	IW00000 - IWFFFFF		*1
Output registers	OB000000 - OBFFFFFF	OW00000 - OWFFFFF		*1
Data registers	MB000000 - MB65534F	 MW00000 - MW65534		

\*1 As for Input and Output registers, device 0x9000-0xFFFF cannot be written.

### NOTE

- Please refer to the GP-Pro EX Reference Manual for system data area.  
Cf. GP-Pro EX Reference Manual "Appendix 1.4 LS Area (Direct Access Method)"
- Please refer to the precautions on manual notation for icons in the table.  
 "Manual Symbols and Terminology"

## 7 Device Code and Address Code

Use device code and address code when you select "Device Type & Address" for the address type in data displays.

Device	Device Name	Device Code (HEX)	Address Code
System registers	SW/SB	0080	Word address
Input registers	IW/IB	0001	Word address
Output registers	OW/OB	0081	Word address
Data registers	MW/MB	0000	Word address



## 8 Error Messages

Error messages are displayed on the screen of Display as follows: "No. : Device Name: Error Message (Error Occurrence Area)". Each description is shown below.

Item	Description
No.	Error No.
Device Name	Name of External Device where error occurs. Device name is a title of External Device set with GP-Pro EX. (Initial value [PLC1])
Error Message	Displays messages related to the error which occurs.
Error Occurrence Area	Displays IP address or device address of External Device where error occurs, or error codes received from External Device. <b>NOTE</b> <ul style="list-style-type: none"> <li>• IP address is displayed such as "IP address (Decimal): MAC address (Hex)".</li> <li>• Device address is displayed such as "Address: Device address".</li> <li>• Received error codes are displayed such as "Decimal [Hex]".</li> </ul>

Display Examples of Error Messages

"RHAA035: PLC1: Error has been responded for device write command (Error Code: 2 [02H])"

- 
- |             |  |
|-------------|--|
| <b>NOTE</b> | <ul style="list-style-type: none"> <li>• Refer to your External Device manual for details on received error codes.</li> <li>• Refer to "When an error is displayed (Error Code List)" in "Maintenance/Troubleshooting Manual" for details on the error messages common to the driver.</li> </ul> |
|-------------|--|
- 

### ■ Error Code Peculiar to PLC

The error code peculiar to PLC is as follows.

Error code	Description
0x90	Transfer error.
0x92	Illegal parameter.
0x96	Register No. over.
0x9C	File is modified.
0x9D	Data access error.

**■ Error Messages Specific to the External Device**

Message ID	Error Message	Description
RHxx128	"(Node Name):PLC is busy now(Error Code: [Hex])"	PLC is "Busy"
RHxx129	"(Node Name):Option module is not mounted(Error Code: [Hex])"	Option module not mount.
RHxx130	"(Node Name):Module is not ready(Error Code: [Hex])"	Module is not ready
RHxx131	"(Node Name):CPU is stopped(Error Code: [Hex])"	CPU is stopped
RHxx132	"(Node Name): Write protected(Error Code: [Hex])"	Write protected