

29 | Logic Programming

This chapter provides an overview of the addresses that you can use in GP-Pro EX and GP, and how to create Logic Programs using the GP-Pro EX Logic functions.

First, read "29.1 Logic Programming Steps" (page 29-2), and then go to the corresponding page for further instructions.

29.1	Logic Programming Steps	29-2
29.2	Preparing to Create Logic Programs.....	29-3
29.3	Addresses used in the logic program.....	29-8
29.4	Rung and Branch Insertion	29-27
29.5	Ladder Instruction Insertion.....	29-41
29.6	Allocating Addresses to Instructions	29-57
29.7	Input Comments	29-63
29.8	Logic Operations with Power ON	29-72
29.9	Transferring Logic Programs.....	29-75
29.10	Logic Program Error Correction	29-77
29.11	Monitoring Logic Programs on the Computer (Online Monitor).....	29-79
29.12	Monitoring Logic Programs on the GP (Logic Monitor)	29-90
29.13	Convenient features to create/edit logic.....	29-99
29.14	Settings Guide.....	29-159
29.15	Restrictions	29-170

29.1 Logic Programming Steps

Use the following steps to create logic programs.

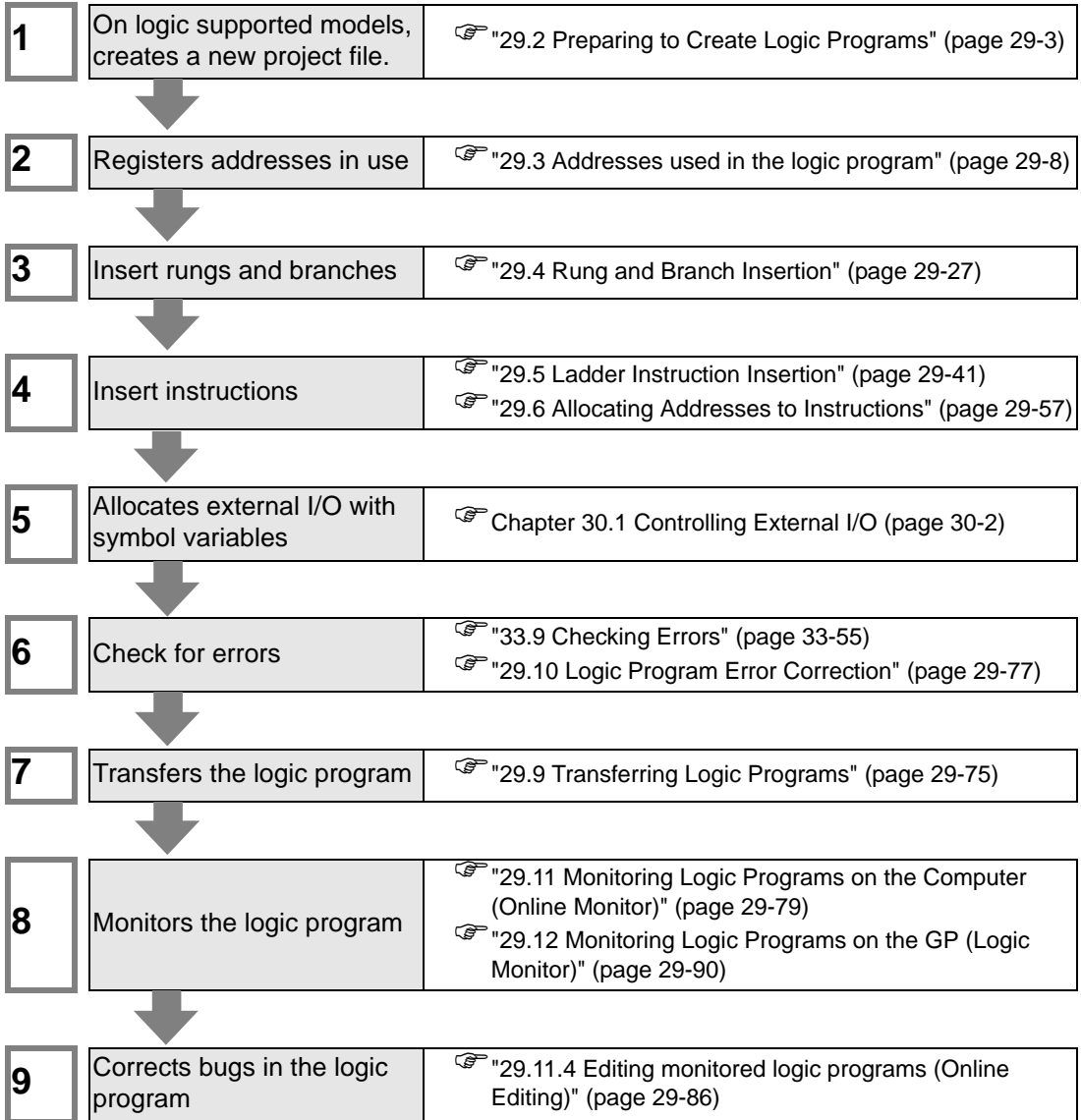

NOTE

- For the complete development flow, please see the following.
☞ "4.2 Creating HMI Displays and Logic Programs" (page 4-3)

29.2 Preparing to Create Logic Programs

NOTE

- The procedures to start/end GP-Pro EX and save project files are the same as the procedures to create a new screen.

 Chapter 5 Start to Finish (page 5-1)

29.2.1 Using Logic

■ If your model supports logic functions

To enable logic programming settings, select a model that supports logic functions in [Display Unit] when you create a new project file.

NOTE

 "1.3 Supported Features" (page 1-5)

■ If your model does not support logic functions

When you create a project file and in [Display Unit] select a model that does not support logic functions, the logic programming settings are disabled.

IMPORTANT

- You can create logic programs, but you cannot transfer the programs to the GP unit if it does not support logic functions.
-

NOTE

- Even if you change the logic functions from [Enable] to [Disable], the logic program will not be deleted. You can also edit the logic program.
-

29.2.2 Logic Program Display

You can select the type of logic program creation/edit from Ladder and IL (Instruction List).
By default, the logic program is shown using ladders.

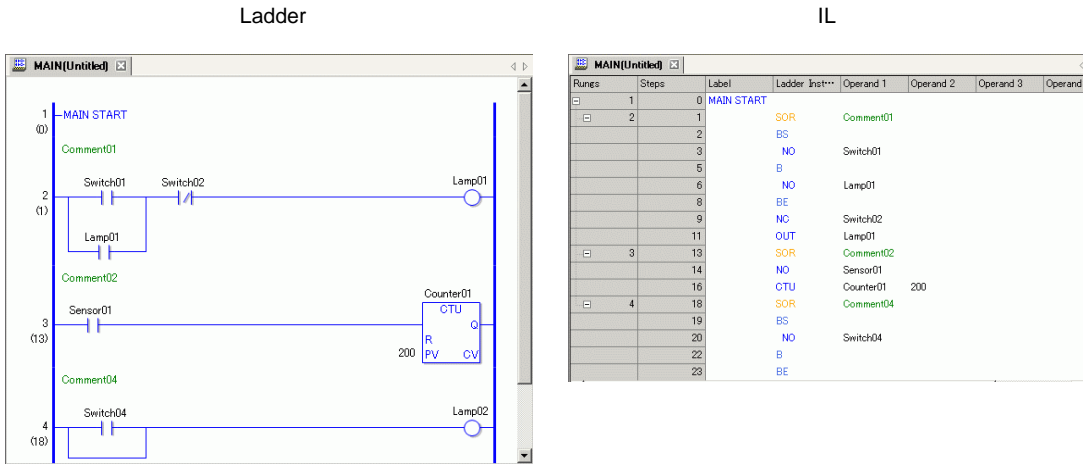

■ Setup Procedure

- 1 Click the [Screen List] tab to open the [Screen List] Window.

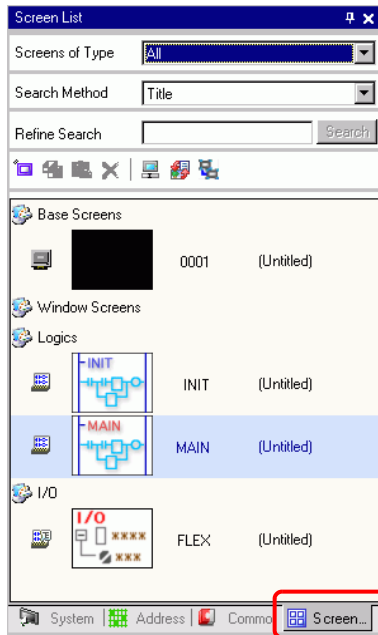

NOTE

- If the [Screen List] tab is not displayed on the work space, on the [View (V)] menu point to [Work Space (W)] and then click [Screen List (G)].

2 Double-click the [MAIN] logic screen to display it in the work space.

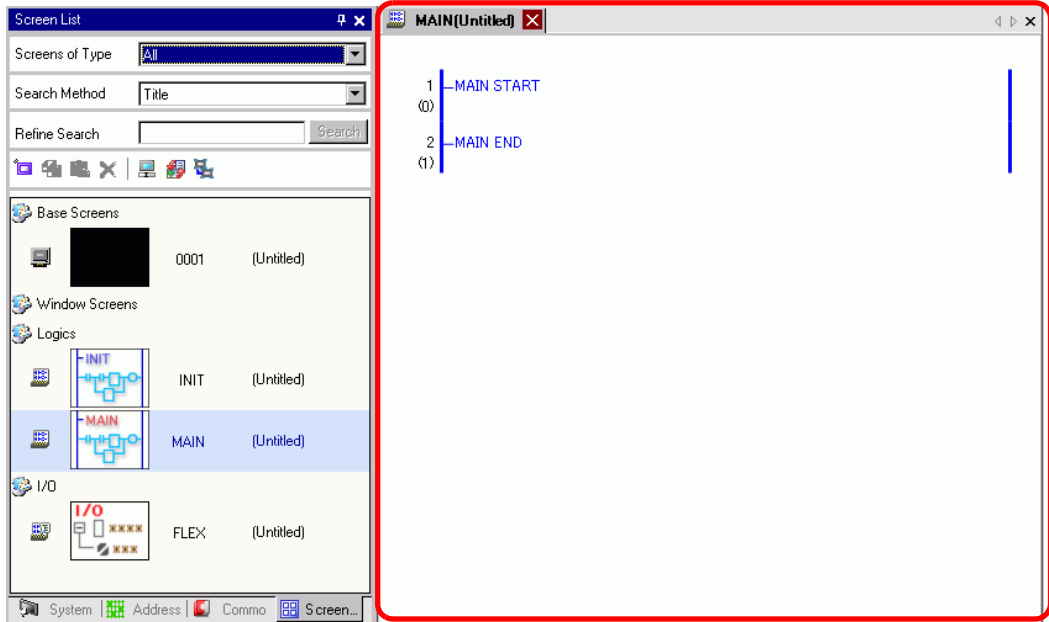

NOTE

- Double-click any logic screen in the screen list to switch logic screens.

3 In order to switch between Ladder and IL, click [Instruction List (I)] in [Change View (V)] from the [Screen (S)] menu.

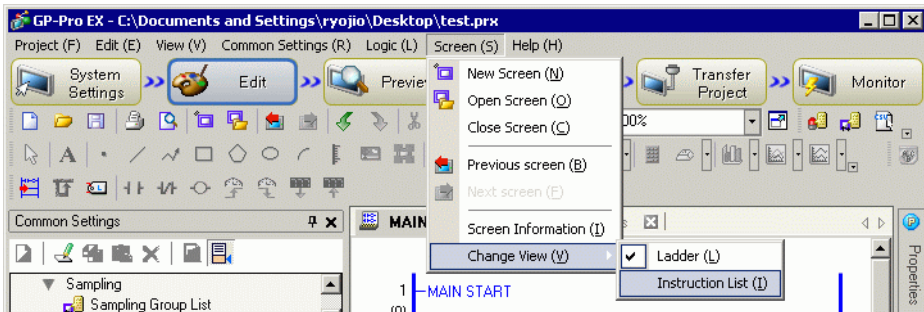

NOTE

- For details on editing the logic program using IL, refer to the following.
How to insert an instruction or a branch
☞ "29.4.3 Inserting an instruction/branch using IL" (page 29-37)

■ Logic Type

Logic programs consist of the following three types of logic.

Logic Type	Logic Name	Description
Initialize Logic	INIT	The logic is run only once when the GP starts up. You can create only one INIT program in a project file. Start Label: "INIT START" End Label: "INIT END"
Main Logic	MAIN	The logic program is run after the initialize logic has been run. Start Label: "MAIN START" End Label: "MAIN END"
Subroutines	SUB-01-SUB-32	Logic is created to run the subroutine processing. You can create up to 32 subroutines in a project file. Start Label: "SUB-** START" (**01 to 32) End Label: "SUB-** RETURN" (**01 to 32)

- The Initialize Logic and Main Logic are created beforehand.
- You can add a subroutine with the [New Screen (N)] command.
- The total number of rungs in all programs, excluding the Start Label/End Label must be less than 5000.

29.2.3 Logic Screen Part Name

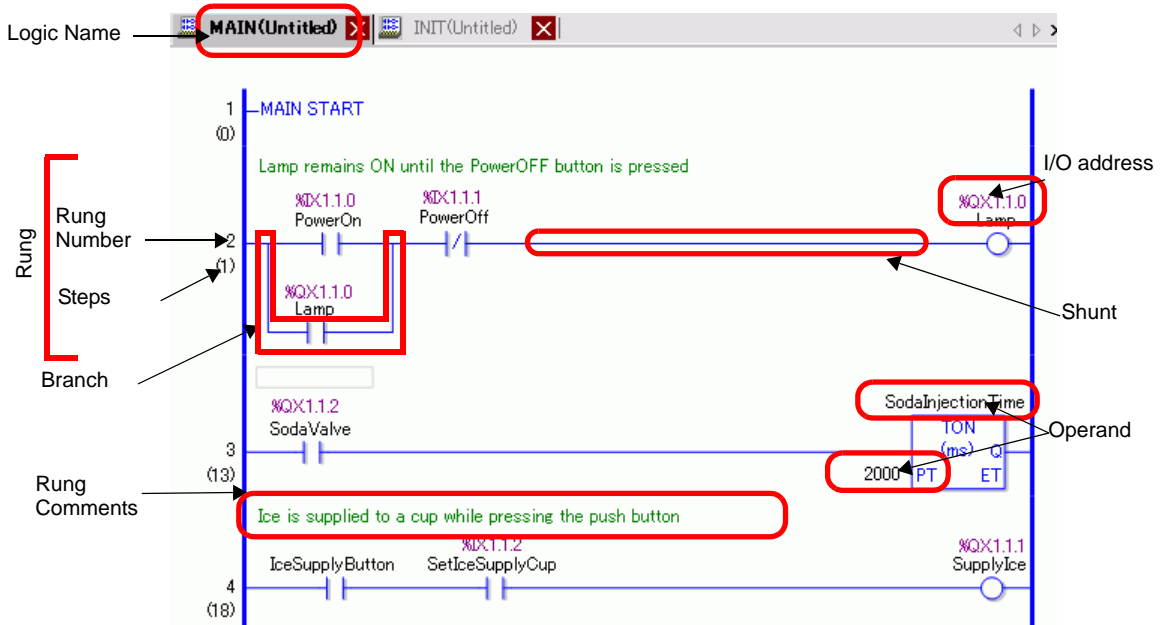

Items	Description
Logic Name	The name of the logic screen will be displayed. Click the tab to switch screens.
Rung	Consists of zero or more instructions or one label. The maximum number of instructions per rung is 150. The maximum number of branches is 50.
Rung Number	Sequential numbers with the Start Label as 1 are displayed for each rung.
Steps	Steps are the size of a logic program calculated as 6 bytes per 1 step.
Shunt	This indicates the horizontal shaft connecting the left power bar to the right power bar. (Connection)
Branch	Executes the logic program by connecting to rungs in parallel. "29.4.2 Inserting and Deleting Branches" (page 29-34)
Operand	Indicates the constants allocated to the instructions. "29.6.1 Operand Settings" (page 29-57)
I/O address	The address value allocated to the I/O unit. The I/O address format differs depending on the allocated drivers. Chapter 30 Controlling External I/O (page 30-1)
Rung Comments	Displayed when a rung has a comment. "29.7.2 Adding Rung Comments" (page 29-65)
Symbol Variable Comments	Displayed as a tool tip when the pointer points to a variable with a comment. "29.7.3 Symbol Variable Comments" (page 29-67)

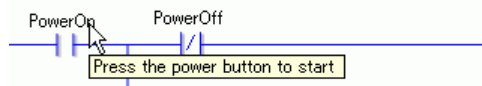

29.3 Addresses used in the logic program

29.3.1 Usable Addresses

On the GP-Pro EX, you can use (Device Address) of the connection device/PLC and the addresses of the GP data storage area.

These addresses can be used in two ways, as follows.

For a device address (Device Address), use the original addresses of device/PLC or GP, for example, [PLC1]X00100 or [#INTERNAL]LS0100.

For a symbol variable, you can assign a name to the device/PLC or GP address, such as "sales_quantity" or "stock_quantity".

■ Symbol Variable

There are two kinds of Symbol Variables.

- Symbol

Names applied to device addresses are called symbols.

You can manage all addresses using names, and even use these names when defining the address in parts and other objects.

Allocatable device address: Bit address and Word address

- Variable

Items that are assigned to GP-Pro EX internal devices are called "variables."

There are two ways to register variables as follows.

Variable Format: Allows you to name each variable.

NOTE

- When creating a new project file, select [Variable Format].
- If you selected a model that does not support logic functions, you cannot select [Address Format].
- You can select [Address Format] only when creating a new program. You cannot change the format after you create a program.

 "29.3.2 Using Addresses with Flexible Names (Variable Format)" (page 29-10)

Address format: Uses the device address as the name. Use this format when there are too many addresses to name.

NOTE

- You can change the method from [Address Format] to [Variable Format] even during logic programming. However you cannot change back from [Variable Format] to [Address Format].
- Even if the number of addresses in the logic program exceeds the number of variables, you can change the format from [Address Format] to [Variable Format]. This causes only the addresses in the logic program to change to variables.
Addresses available to the logic program but unused do not change into variables.

 "29.3.3 Using prepared addresses (Address Format)" (page 29-17)

■ PLC Address (Device Address)

◆ External Address

- Connection Device Address

This looks up the connection device data.

You can use this area only when communication with the device/PLC is set through a direct access system.

For example, [PLC1]X00100

NOTE

☞ "29.3.4 Using External Addresses" (page 29-22)

You cannot use disabled addresses to read devices/PLC. For unreadable addresses, refer to the "GP-Pro EX Device Connection Manual".

◆ Internal Address

These are temporary storage locations for saving data such as the values operated on or controlled in the GP.

NOTE

☞ "29.3.5 Using Internal Addresses" (page 29-24)

- LS Area

This contains free user areas and an area for operating the GP.

You can use this area only when communication with the device/PLC is set through a direct access system.

For example, [#INTERNAL]LS0100

- User Area

You may use all areas as you like, up to 30,000 Words.

For example, [#INTERNAL]USR00100

- Memory Link System Area

This area acts as a medium for the host write/read request.

You can use this area only when communication with the connection device is set through a memory link.

For example, [#MEMLINK]0100

■ System Variable

These variables have predefined functions. They display and control the state of the GP when a logic program is run. The system variables cannot be deleted.

NOTE

☞ "29.3.6 System Variable" (page 29-26)

☞ "A.6 System Variables" (page A-89)

29.3.2 Using Addresses with Flexible Names (Variable Format)

The following explains the symbol variables that you can use when [Register Variable] is set to [Variable Format].

Use symbol variables that are not fixed to the hardware to create a reusable logic program. In GP-Pro EX, you can name variables and use them in logic programming. For most PLCs, data storage areas are handled as device addresses in registers named by the PLC manufacturer.

For example:

	External Input/ Output	Internal Relay	Timer	Data Register
Company M	X001	M100	T200	D00001
Company O	01	1001	TIM000	DM0000
Digital Electronics Corporation of Japan	Switch1	Timer Start	Timer	Run Time

For models by other manufacturers



The above program description is a drawing.

For GP-Pro EX

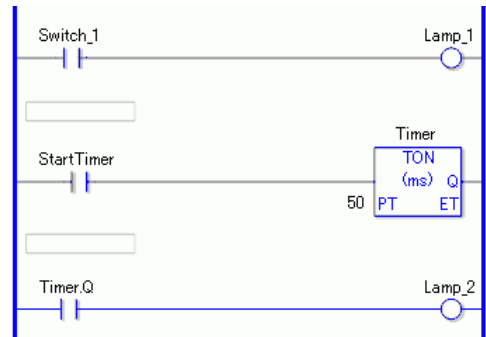

■ Registering Symbol Variables

- 1 From the [Common Settings (R)] menu, select [Symbol Variable (V)], or click . The [Edit Symbol Variables] window appears.

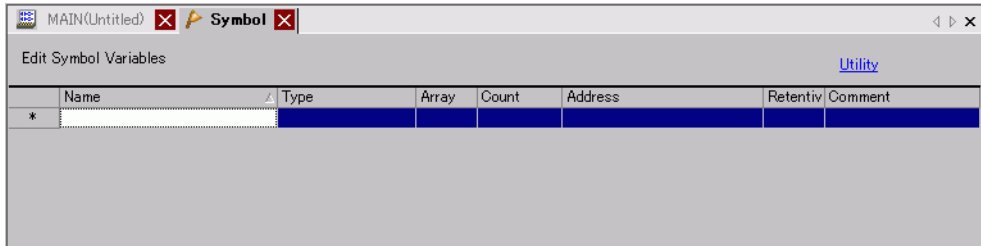

- 2 Double-click a cell in the [Name] column to enter a name. (For example, Switch1)

IMPORTANT

- Symbol variable names have some restrictions.
 - The maximum number of characters is 32.
 - You cannot use the following symbols.
+ - * / = % & | \ : . , # ? @ [] < > "
 - You cannot use TAB or DEL.
 - You cannot use a name starting with a single-byte number.
 - You cannot use a single-byte space.
 - You cannot leave the name blank.
 - Double-byte characters and single-byte characters are different.
 - Upper case characters and lower case characters are different.

- 3 Click a cell in the [Type] column to select a type. (Example, Bit Address)

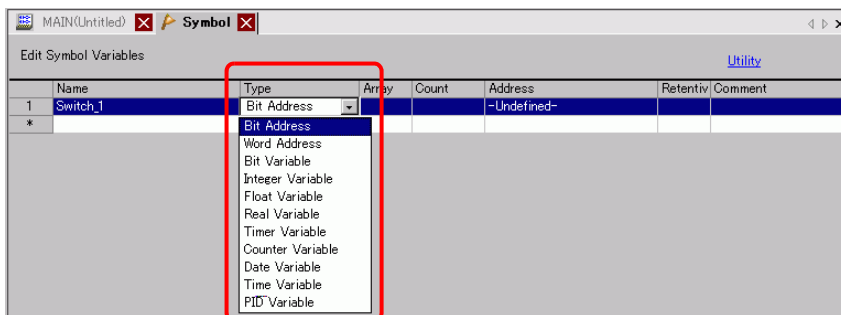

- If you selected [Bit Address] or [Word Address], you can specify the address. Proceed to step 4.
- If you selected [Bit Variable], [Integer Variable], [Float Variable], or [Real Variable], you can specify the array. To specify the array, go to step 5. If not setting the array, proceed to step 6.
- If you selected [Timer Variable], [Counter Variable], [Time Variable], or [Date Variable], proceed to step 6.
- If you selected [PID Variable], the [Retentive] check box must always be selected. Proceed to step 7.

NOTE

- For details on the types of variables, refer to the following.
 ■ Variable Type" (page 29-13)

4 Specify the address on the [Address] column. Proceed to step 8.

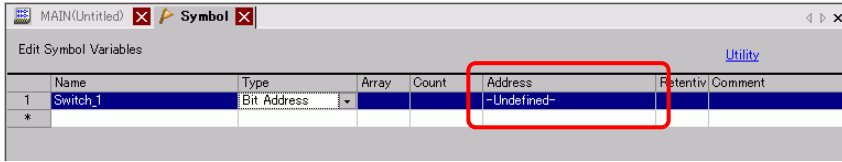

Click [-Undefined-] to display a keyboard for inputting the address.

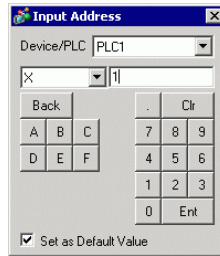

Select the connection device and device, input the address, then click "Ent".

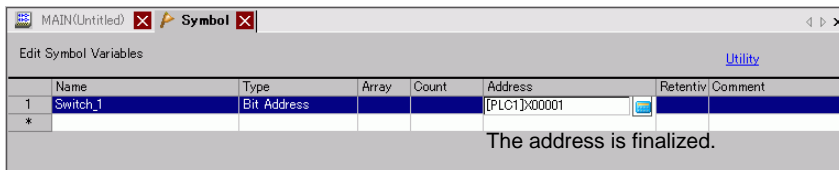

5 To specify the array, click a cell in the [Array] column, then select the check box to display the cell in the [Count] column. In the [Count] column, enter the array size (for example, 5). Proceed to step 6.

NOTE

- For details on the arrays, refer to the following.
 " ■ Arrays and Array Sizes" (page 29-15)

6 For the keep setting, click a cell in the [Retentive] column and select the check box. For the clear setting, do not select the check box in the [Retentive] cell.

NOTE

- For details on the retentive/volatile settings, refer to the following.
 " ■ Retentive" (page 29-16)



7 To input a comment, click the cell in the [Comment] column and enter the comment.

NOTE

- For details on comments, refer to the following.
 "29.7.3 Symbol Variable Comments" (page 29-67)

8 The registration is complete.

NOTE

- You can make changes to registered variables only when they are used in the logic program. You can delete variables that are not used on any screen. To delete, select the symbol variable and click  or press the [Delete] key.
- To register the registered symbol variable to a part placed on a new screen, refer to the following.
 "5.9 Registering Addresses with Comprehensible Names" (page 5-59)

■ Variable Type

There are nine variable types: Bit, Integer, Float, Real, Timer, Counter, Time, Date, and PID.

◆ Bit Variable

Variable with a 1-bit length that indicates ON/OFF with a value of either 0 (OFF) or 1 (ON).

◆ Integer Variable

Signed variable with a 32-bit length that has integer values of -2147483648 (16#80000000) - 2147483647 (16#7FFFFFFF).

◆ Float Variable

32-bit variables have a floating point value of 1.175494351e-38 to 3.402823466e+38 and 0. You can use up to 7 decimal places.

◆ Real Variable

64-bit variables have a floating point value of 2.2250738585072014e-308 to 1.7976931348623158e+308 and 0. You can use up to 15 decimal places.

◆ Timer Variable

Use timer variables to enable timer instructions.

Timer variables consist of the following five variables.

For details on instructions, refer to Chapter 31 Instructions (page 31-1) .

Variable	Description	Variables Settings
PT	Setting Value	32-Bit Integer
ET	Current Value	32-Bit Integer
Q	Output	Bit
TI	Time Count	Bit
R	Timer Reset	Bit

NOTE

- Even when clear is selected for timer variables, the PT (preset time) is retained.
 " ■ Retentive" (page 29-16)

◆ Counter Variable

Use counter variables to enable counter instructions.

Counter variables consist of the following seven variables.

For details on instructions, refer to Chapter 31 Instructions (page 31-1) .

Variable	Description	Variables Settings
PV	Setting Value	32-Bit Integer
CV	Current Value	32-Bit Integer
Q	Output	Bit
QD	Down Counter Output	Bit
QU	Up Counter Output	Bit
UP	Up Counter	Bit
R	Counter Reset	Bit

NOTE

- When scanning to reset the counter, the counter will not be updated. You must scan once to reset the counter.
 - Even when clear is selected for counter variables, PV (preset value) is retained.
-  " ■ Retentive" (page 29-16)

◆ **Date/Time Variable**

Use date/time variables to enable date/time instructions.

Date/time variables consist of the following three variables.

For details on instructions, refer to Chapter 31 Instructions (page 31-1) .

Variable	Description	Variables Settings
YR	Year (0-99)	32-Bit Integer
MO	Month (1-12)	32-Bit Integer
DAY	Day (1-31)	32-Bit Integer

◆ **Time Variable**

Use time variables to enable time instructions.

The time variable consists of the following three variables.

For details on instructions, refer to Chapter 31 Instructions (page 31-1) .

Variable	Description	Variables Settings
HR	Hour (0-23)	32-Bit Integer
MIN	Minute (0-59)	32-Bit Integer
SEC	Second (0-59)	32-Bit Integer

◆ PID Variable

Use PID variables to enable PID instructions.

PID variables consist of the following eleven variables.

For details on instructions, refer to Chapter 31 Instructions (page 31-1) .

Variable	Description	Variables Settings
KP	Constant Proportion (x1000)	32-Bit Integer
TR	Integral time (x1000)	32-Bit Integer
TD	Differential time (x1000)	32-Bit Integer
PA	Processing Deadband Range	32-Bit Integer
BA	Bias	32-Bit Integer
ST	Sampling Cycle	32-Bit Integer
Q	PID Processing Complete Flag	Bit
UO	Exceeding the Minimum Scaled Value	Bit
TO	Exceeding the Maximum Scaled Value	Bit
PF	Processing Deadband Range Flag	Bit
IF	Integral Range Processing Flag	Bit

■ Arrays and Array Sizes

You can specify arrays for bit, integer, float, and real variables. The maximum number of array elements you can set up is 4,096.

However, the float and real variable limit is 128 items.

Arrays provide you with a method to manipulate multiple elements in a single variable. It enables you to group variables with the same type and save it all at one time.

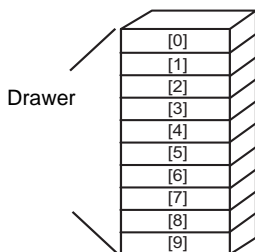

Imagine the drawers of a desk or chest, for example.

A chest with an array size of 10 has 10 drawers from [0] to [9]. Each drawer is called Chest [0], Chest [1], ..., Chest [9].

Each of these drawers becomes a data register on the PLC. If 10 Chest memories are used, the array method calls the array size 10 with the symbol variable name Chest.

■ Retentive

If variables are set to retentive, they are stored in backup SRAM and retain their values when the unit is shut down.

These values are kept until the backup battery runs out, which causes these variables to revert to their default value as defined in GP-Pro EX. When shutting down or resetting the GP, the latest values are copied to SRAM. Downloading a logic program will initialize variables with their default values set up in GP-Pro EX, unless you select the Retentive Transfer check box.

IMPORTANT

- Data saved in SRAM is lost when the power is turned off or the battery runs out. In such case, the values specified in GP-Pro EX are used as the default values.

NOTE

- Retentive Settings allow you to specify the variable points to retentive/volatile.

 "29.14 Settings Guide" (page 29-159)

29.3.3 Using prepared addresses (Address Format)

NOTE

- For details on setting to Address Format, refer to the following.
 "29.14.1 [Logic Programs] Setting Guide" (page 29-159)

The following explains the symbol variables that you can use when [Register Variable] is set to [Address Format].

Type	Address (by the Address method)	Display	Size	Remarks
Bit Variable	X_0000 to X_0255	Decimal (Base 10)	256	Input
	Y_0000 to Y_0255	Decimal (Base 10)	256	Output
	M_0000 to M_7999	Decimal (Base 10)	8000	Internal
Integer Variable	I_0000 to I_0063	Decimal (Base 10)	64	Input
	Q_0000 to Q_0063	Decimal (Base 10)	64	Output
	D_0000 to D_7999	Decimal (Base 10)	8000	Internal
Float Variable	F_0000 to F_0127	Decimal (Base 10)	128	Internal
Real Variable	R_0000 to R_0127	Decimal (Base 10)	128	Internal
Timer Variable	T_0000 to T_0511	Decimal (Base 10)	512	Internal
Counter Variable	C_0000 to C_0511	Decimal (Base 10)	512	Internal
Date Variable	N_0000 to N_0063	Decimal (Base 10)	64	Internal
Time Variable	J_0000 to J_0063	Decimal (Base 10)	64	Internal
PID Variable	U_0000 to U_0007	Decimal (Base 10)	8	Internal

■ Registering Symbol Variables

You can name Bit Addresses and Word Addresses as you like.

- 1 From the [Common Settings (R)] menu, select [Symbol Variable (V)], or click . The [Edit Symbol Variables] window appears.

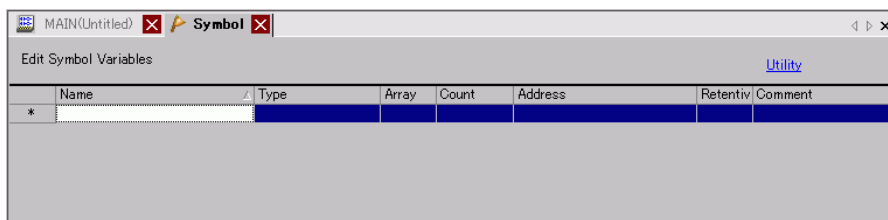

2 Double-click a cell in the [Name] column to enter a name. (For example, Switch1)

IMPORTANT

- Symbol variable names have some restrictions.
 - The maximum number of characters is 32.
 - You cannot use the following symbols.
+ - * / = % & | \ : . , # ? @ [] < > "
 - You cannot use TAB or DEL.
 - You cannot use a name starting with a single-byte number.
 - You cannot use a single-byte space.
 - You cannot leave the name blank.
 - Double-byte characters and single-byte characters are different.
 - Upper case characters and lower case characters are different.

3 Click the cell in the [Type] column and select either [Bit Address] or [Word Address] type.

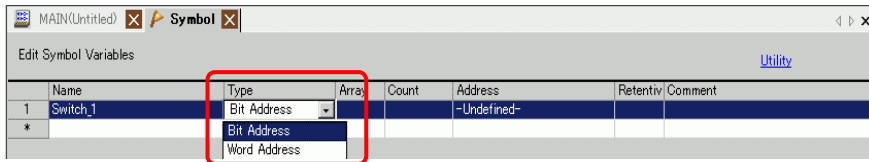

NOTE

- For details on the types of variables, refer to the following.
☞ " ■ Variable Type" (page 29-13)

4 Specify the address on the [Address] column, then go to step 7.

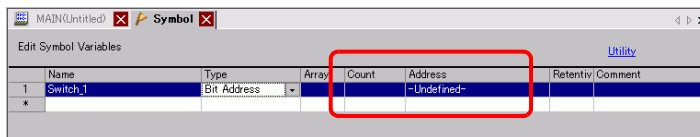

Click [-Undefined-] to display a keyboard for inputting the address.

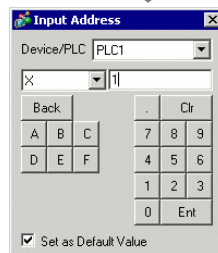

Select the connection device and device, input the address, then click "Ent".

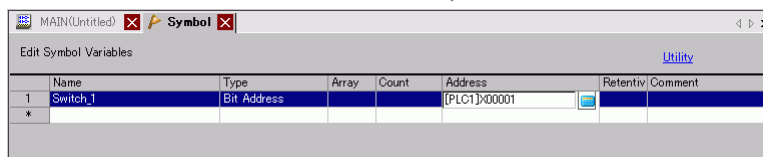

The address is finalized.



5 To input a comment, click the cell in the [Comment] column and enter the comment.

NOTE

- For details on comments, refer to the following.
☞ "29.7.3 Symbol Variable Comments" (page 29-67)

6 The registration is complete.

NOTE

- You can only change and delete registered symbol variables that are not in use.
To delete, select the symbol variable and click  or press DELETE.
 - To register the registered symbol variable to a part placed on a new screen, refer to the following.
 "5.9 Registering Addresses with Comprehensible Names" (page 5-59)
-

■ Logic Address Display

When [Register Variable] is set to [Address Format], you can use the logic addresses of bit variables and integer variables allocated within the GP-Pro EX.

The address is displayed as X_0100 on a logic program. For example, [#LOGIC]X_0100

NOTE

- Users cannot edit the addresses, such as register the names of their choice, or change or delete addresses.

As shown below, display the logic address in the [Address] window, and specify the address for the logic program instruction and the part placed on the screen.

1 Select the [Address] tab to open the [Address] window.

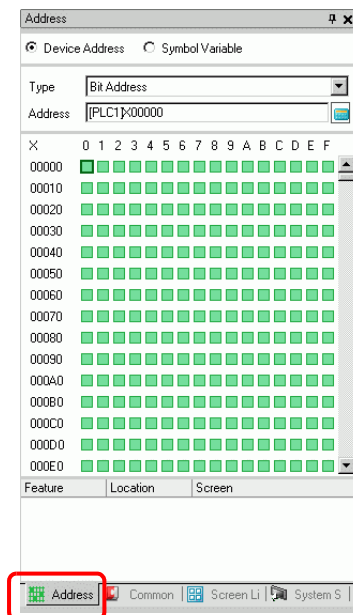

NOTE

- If the [Address] tab is not displayed in the Work Space, on the [View (V)] menu, point to [Work Space (W)], and then click [Address (A)].

2 Select [Device Address], and in [Type], select [Bit Address (Bit Variable)] or [Word Address (Integer Variable)].

3  Click the icon to display the [Input Address] dialog box.

4 In [Device/PLC], select [#LOGIC] and the device to specify the address.

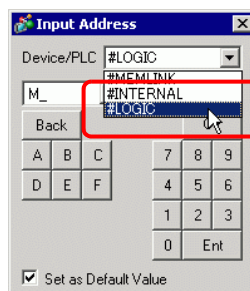

5 The logic address will be displayed. Specify the address by dragging the address to the logic program instruction or the part placed on the screen.

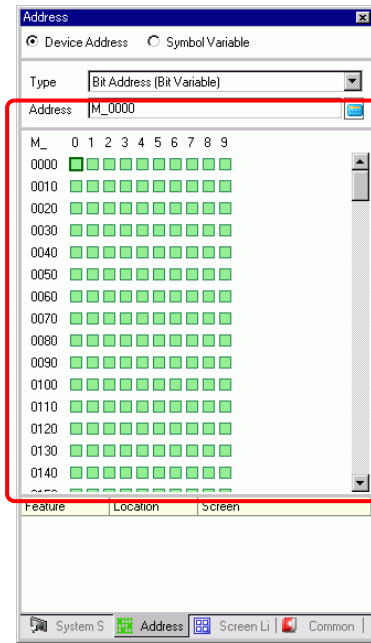

NOTE

☞ " ■ Operand Settings Using Drag and Drop" (page 29-60)

29.3.4 Using External Addresses

You can specify the device address if direct access is used to communicate with the connection device (PLC).

NOTE  "A.1.2 Communicating with a Device/PLC Using the Direct Access Method" (page A-4)



■ External Device Address

This can be used when the symbol variable is a bit-address or word-address type.

◆ [Symbol Variable] Window

Click the cell in the [Address] column and click .

NOTE

- For the variable format, refer to the following.
 " ■ Registering Symbol Variables" (page 29-11)
- For the address format, refer to the following.
 " ■ Registering Symbol Variables" (page 29-17)

◆ [Address] Window

1 Select [Device Address], and in [Type], select [Bit Address (Bit Variable)] or [Word Address (Integer Variable)].

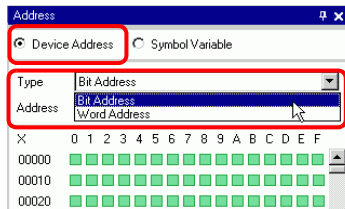

2  Click the icon to display the [Input Address] dialog box.

3 In [Device/PLC] (for example, PLC1) and input the address of the model (for example, X00000).

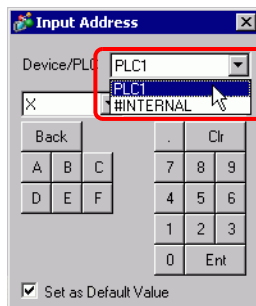

◆ **Logic**

1 Double-click the operand and click  to display the address input box.



2 In [Device/PLC] (for example, PLC1) and input the address of the model (for example, X00000).

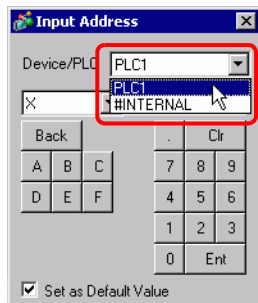

29.3.5 Using Internal Addresses

If direct access is used to communicate with the connection device (PLC), you can specify the addresses for the LS area and user area.

NOTE

☞ "A.1.2 Communicating with a Device/PLC Using the Direct Access Method" (page A-4)

When memory link is used to communicate with the connection device (PLC), you can specify the addresses for the user area and memory link system area.

NOTE

☞ "A.1.3 Using the Memory Link Method with Unsupported Devices/PLCs" (page A-6)

■ Internal Address

This can be used when the symbol variable is a bit-address or word-address type.

◆ [Symbol Variable] Window

Click the cell in the [Address] column and click .

NOTE

- For the variable format, refer to the following.
☞ "■ Registering Symbol Variables" (page 29-11)
- For the address format, refer to the following.
☞ "■ Registering Symbol Variables" (page 29-17)

◆ [Address] Window

1 Select [Device Address], and in [Type], select [Bit Address (Bit Variable)] or [Word Address (Integer Variable)].

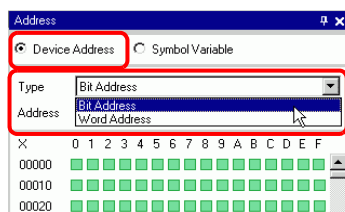

2  Click the icon to display the [Input Address] dialog box.

3 In [Device/PLC], select the connection device name and input the address of the model.

LS Area or User Area
 Connection Device Name (INTERNAL)
 Address (for example, LS0000)

System Area for Memory Link
 Connection Device Name (MEMLINK)
 Address (for example, 0000)

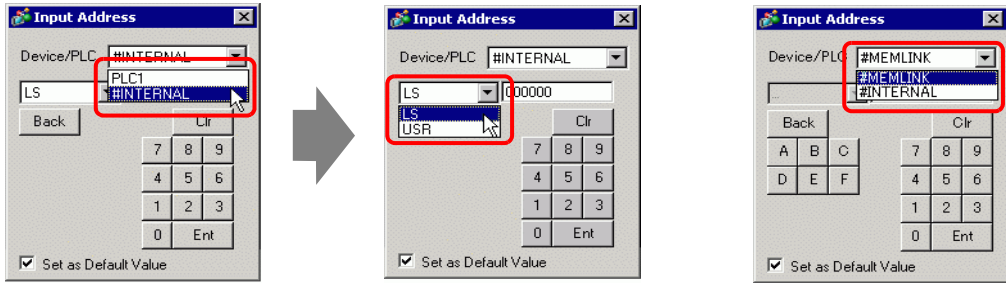

◆ Logic

1 Double-click the operand and click  to display the address input box.



2 In [Device/PLC], select the connection device name and input the address of the model.

LS Area or User Area
 Connection Device Name (INTERNAL)
 Address (for example, LS0000)

System Area for Memory Link
 Connection Device Name (MEMLINK)
 Address (for example, 0000)

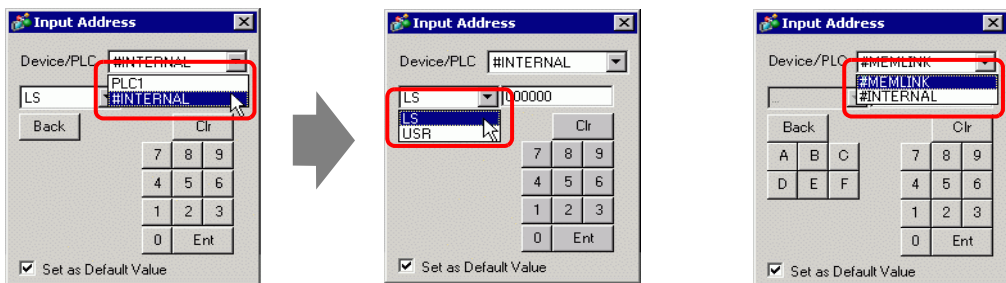

29.3.6 System Variable

There are two kinds of system variables. One is used for logic and the other for screens.

Users cannot edit the variables, for example, register the names of their choice, or change or delete addresses.

Furthermore, there are two types of system variables. One is an integer-type and the other is a bit-type.

NOTE

☞ "A.6 System Variables" (page A-89)

■ System Variable Settings

◆ [Address] Window

Select [Symbol Variable] to display a list of symbol variables. Under [Type], select [System Variable (Bit)] or [System Variable (Integer)] to display the variables by type.

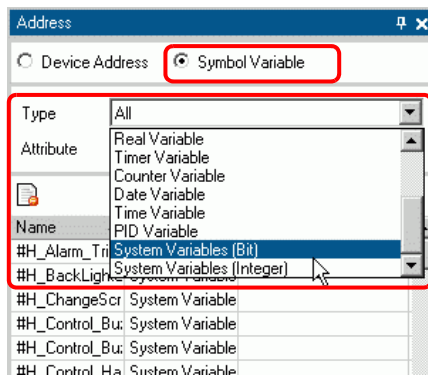

◆ Logic

Double-click the operand and click  to select the system variable.

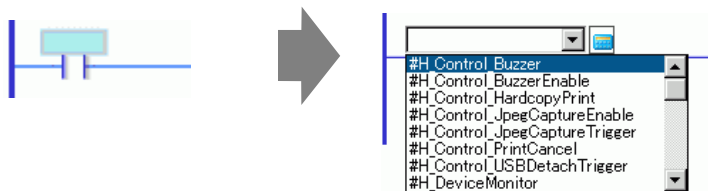

29.4 Rung and Branch Insertion

The following explains how to edit rungs in the logic.

29.4.1 Editing Rungs

■ Inserting Rungs

1 Select the rung number one up from where you want to insert a rung.

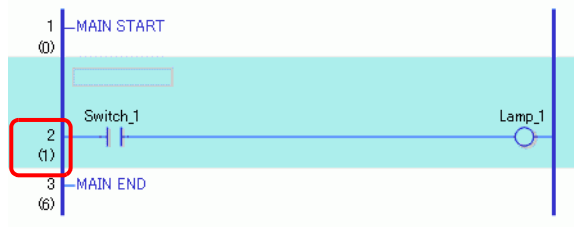

2 Click . Inserts a rung below the selected rung number

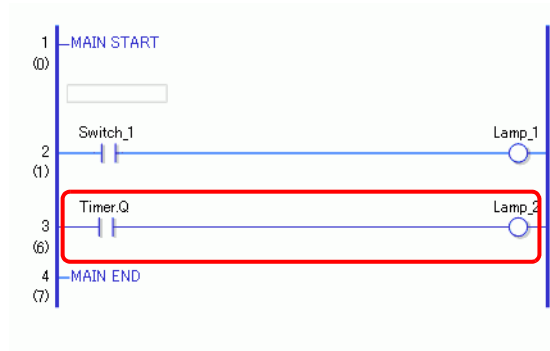

NOTE

- You can also insert a rung in any of the following ways.
- On the [Logic (L)] menu, select [Insert Row (R)].
- Right-click and then click [Insert Rung (R)].
- Press CTRL+R.

■ Delete Rung

1 Select the rung that you want to delete.

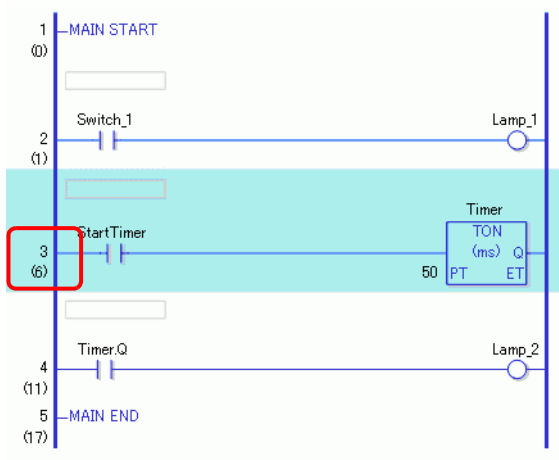

NOTE

- You can select a range to delete more than one rung all at once.
 ☞ " ■ Selecting Multiple Rungs" (page 29-33)

2 Click .

The selected rung is deleted.

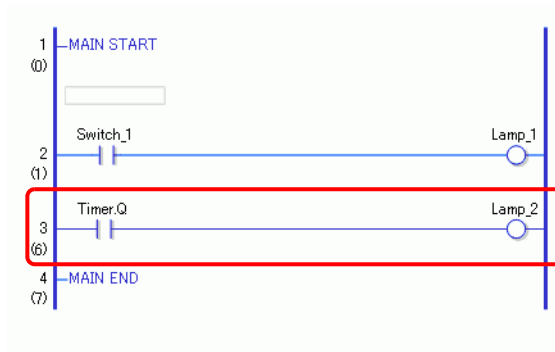

NOTE

- You can also delete a rung in either of the following ways.
- Right-click and then click [Delete (D)].
- Press DELETE.

■ Copying Rungs

When you want to input the same instruction sequence in more than one rung, you can save time by copying the rung already created and pasting it in the rungs.

1 Select the rung number that you want to copy.

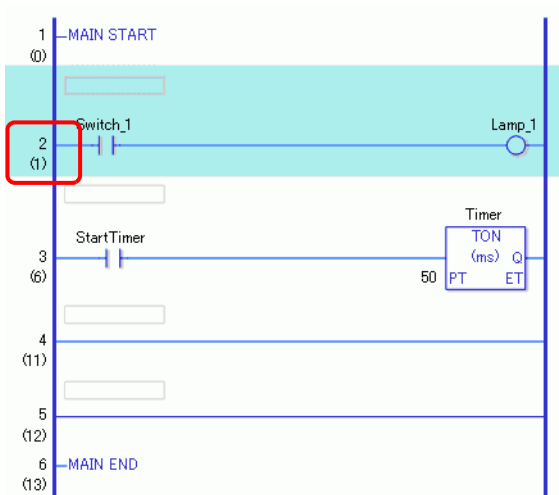

NOTE

- You can select a range to copy more than one rung at all once.
 " ■ Selecting Multiple Rungs" (page 29-33)

2 Click .

The selected rung is copied to the clipboard.

NOTE

- You can also copy a rung in either of the following ways.
- Right-click and then click [Copy (C)].
- Press CTRL+C.

3 Paste the copied rung in the desired location.

NOTE

-  " ■ Pasting Rungs" (page 29-31)

■ Cutting Rungs

When you want to move a created rung, you can save time by cutting the rung and pasting it in the desired location.

1 Select the rung number that you want to cut.

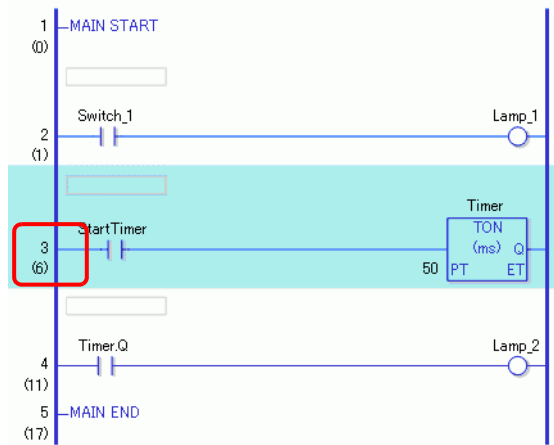

NOTE

- You can select a range to cut more than one rung.
 " ■ Selecting Multiple Rungs" (page 29-33)

2 Click .

The cut rungs are copied to the clipboard and the selected rungs are deleted.

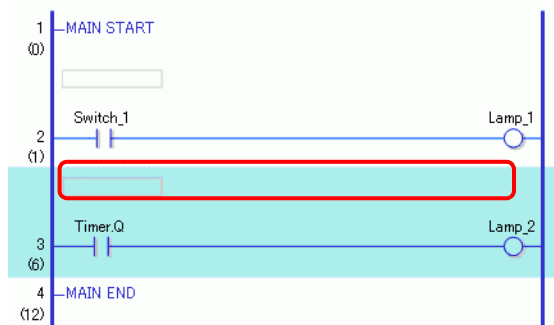

NOTE

- You can also cut a rung in either of the following ways.
- Right-click and then click [Cut (X)].
- Press CTRL+X.

3 Paste the copied rung in the desired location.

NOTE

-  " ■ Pasting Rungs" (page 29-31)

■ Pasting Rungs

You can paste to the desired position rungs that were cut or copied.

Here, paste the copied rung between the 3rd and 4th rungs, for example.

The rung copied to the clipboard



1 Select a part (power bar or instruction) immediately above where you want to insert the rung.

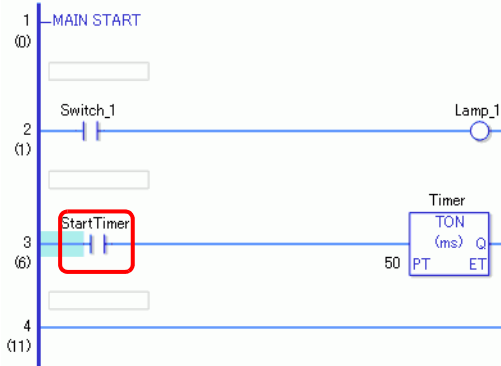

NOTE

- By clicking a rung number and selecting the entire rung, the original rung will be replaced with the copied rung.

2 Click .

The rung is pasted below the selected rung.

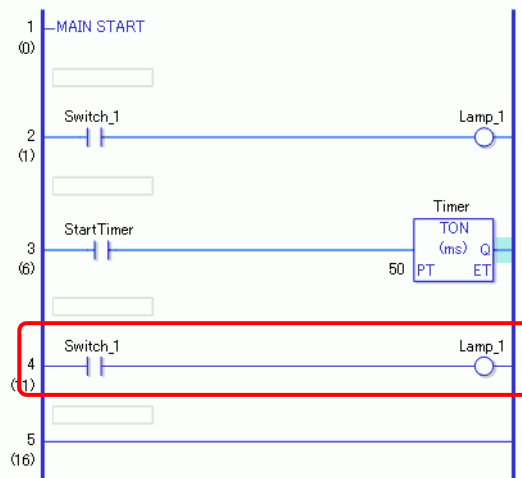

NOTE

- You can also paste a rung in either of the following ways.
- Right-click and then click [Paste (P)].
- Press CTRL+V.
- When a rung is pasted, operands and rung comments in the rung instruction are also pasted. Edit the rung as required.
- ☞ "29.6 Allocating Addresses to Instructions" (page 29-57)
- ☞ "29.7 Input Comments" (page 29-63)

■ Moving Rungs

You can move the rung by dragging and dropping it to another position, without cutting and pasting the rung.

1 Select the rung number of the rung to be moved.

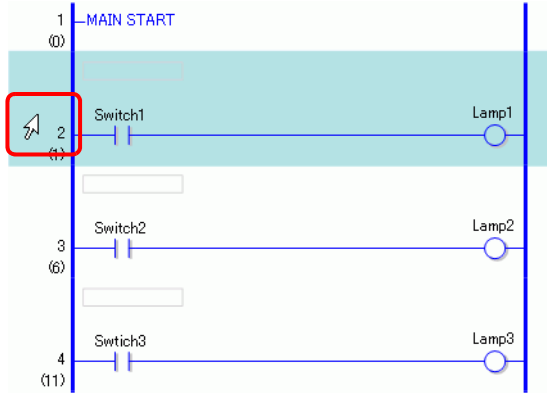

NOTE

- You cannot select multiple rungs to move them all at once.

2 Move the cursor to the desired rung position.

The insertion focus of the rung appears where you move the cursor.

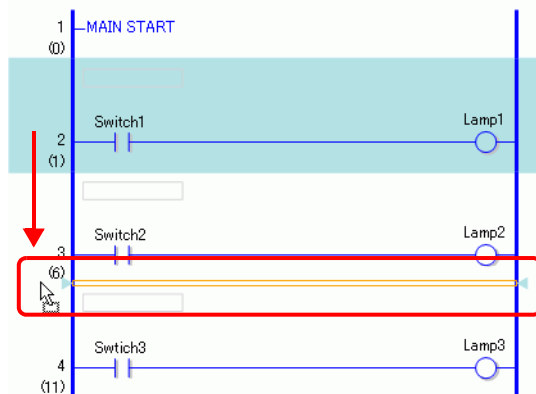

3 Release the left button to move the rung.

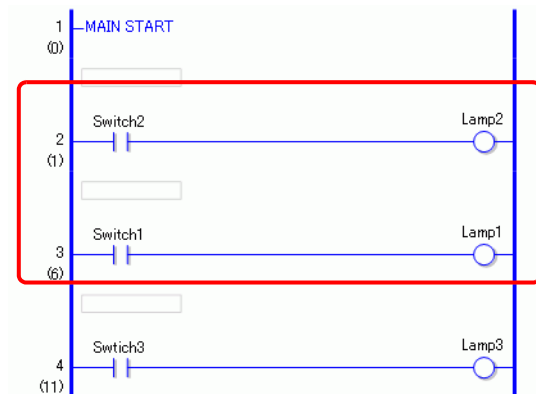

■ Selecting Multiple Rungs

You can copy and delete more than one rung by selecting a range.

1 Click the first rung number of the range that you want to select.

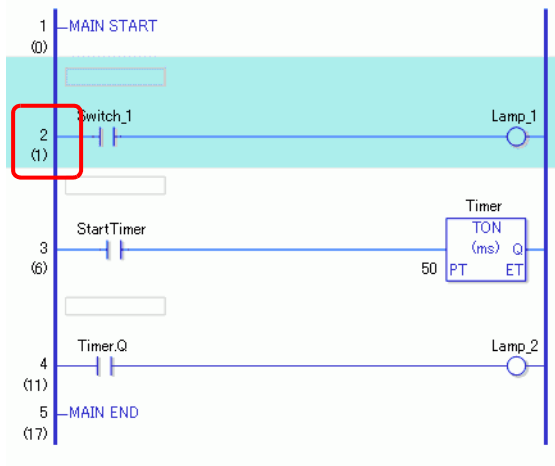

2 While holding down SHIFT, select the last rung number of the range. All the rungs between the two are selected.

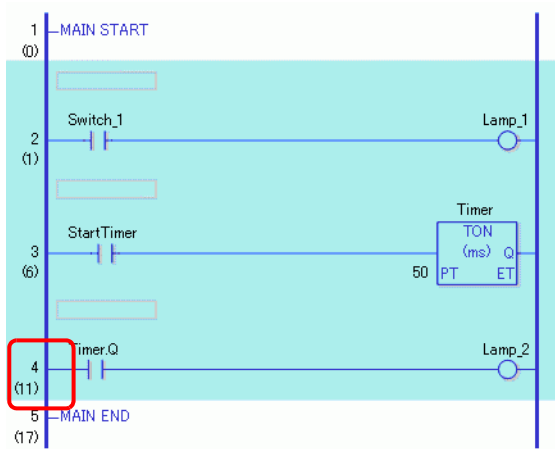

NOTE

- You can also select a rung range in the following way.
- While pressing the [Shift] key, press the [arrow up] key or [arrow down] key and select the last rung number in the range to select.
- Press CTRL+A to select all rungs. Note that the first rung's start label and the last rung's end label will not be selected.

29.4.2 Inserting and Deleting Branches

■ Inserting Branches

The following explains how to insert a branch.

Here, a branch will be inserted between a NO instruction (Normally Open) and an NC instruction (Normally Closed) to create a self-latching logic program, for example.

1 Select where you want to start the branch.

In this case, select the left of the NO instruction (parameter "a").



2 Click . A dashed line is drawn between the start and end points of the branch.



NOTE

- You can also insert a branch in either of the following ways.
 - Right-click and then click [Insert Branch (B)].
 - Press CTRL+B.
-

3 Press the LEFT ARROW or RIGHT ARROW key to determine the final position, and then press ENTER. The branch will be inserted.



NOTE

- You can define the end position using your mouse. Click where the pointer changes back to as an end point to insert the branch.
- You can click the start point of the branch in step 1, and drag to the right of the NO instruction (Normally Open). Release the left mouse button when the pointer changes from to and the branch will be inserted. The branch end is not valid in areas where the pointer is shown as . If this symbol shows, the branch will not be inserted after you release the left mouse button.

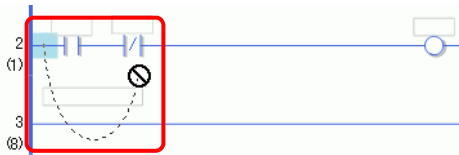

- While multiple instructions or shunts are selected, a branch for detouring from the instruction will be inserted when [Insert Branch (B)] is performed.



4 Insert an instruction in the branch.

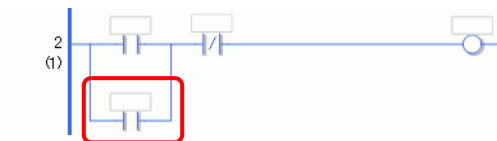

NOTE

" ■ Inserting Instructions" (page 29-41)

■ Deleting Branches

To delete branches, you must delete the instructions before deleting the branches.

1 Delete the instruction.

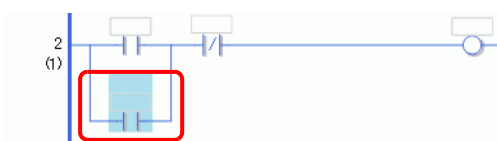

NOTE

" ■ Deleting Instructions" (page 29-43)

2 Select the branch that you want to delete.



3 Click . The branch is deleted.



NOTE

- You can also delete a branch in either of the following ways.
 - Right-click and then click [Delete (D)].
 - Press DELETE.
-

29.4.3 Inserting an instruction/branch using IL

This section explains how to describe a logic program using IL.

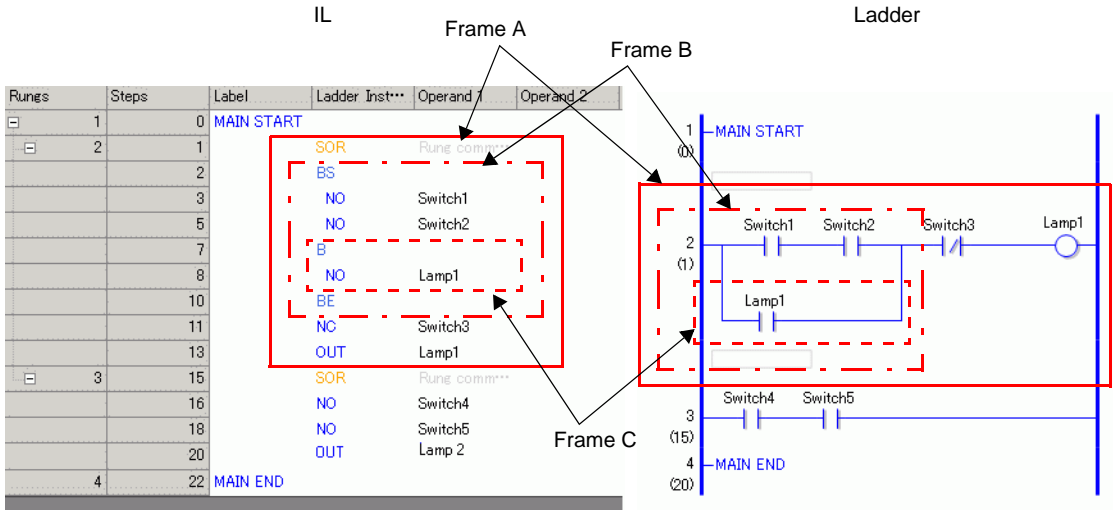

Instruction Name	Description	illustration
SOR	Indicates a starting point of a circuit. From an SOR to the next SOR is one circuit.	Frame A
BS	Indicates a starting point of a branch. The section from BS to B is the upper portion of the branch in the ladder configuration.	Frame B
B	Indicates a branch (lower portion). The section from B to BE is the lower portion of the branch in the ladder configuration.	Frame C
BE	Indicates an ending point of a branch.	

■ Inserting Rungs/Instructions

- 1 Select the first rung (MAIN START).

Rungs	Steps	Label	Ladder Inst...	Operand 1	Operand 2
	1	0	MAIN START		
	2	1	MAIN END		

2 Click . An SOR (Circuit Starting Point) is inserted into the rung next to the MAIN START, and then a box for adding an instruction is displayed.

Rungs	Steps	Label	Ladder Inst**	Operand 1	Operand 2
1	0	MAIN START			
2	1		SOR		Comment
3	2	MAIN END			

NOTE • An SOR (Circuit Starting Point) can also be inserted using the  icon or right-click menu as shown below.

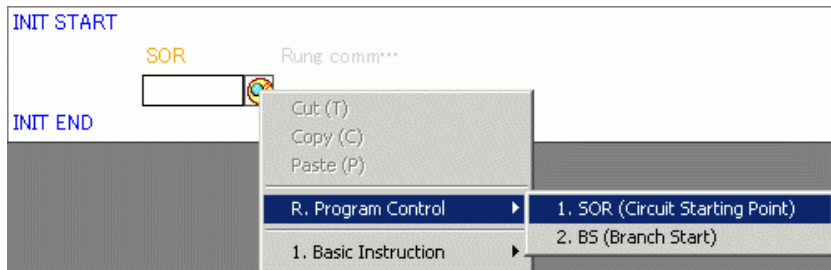

3  Alternatively, you can insert the instruction through text input.

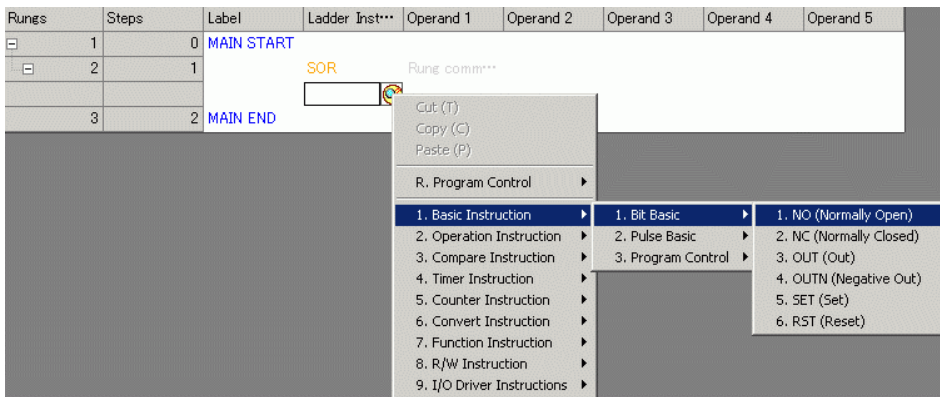

4 Allocate a symbol variable to [Operand 1] for the instruction.

Rung	Step	Label	Instruction	:Operand1
1	0	MAIN START		
2	1		SOR	Comment
	2		NO	switch
3	4	MAIN END		

■ Inserting Branches

1 Select the instruction (NO instruction) to insert the branch.

Rungs	Steps	Label	Ladder Inst...	Operand 1
1	0	MAIN START		
2	1		SOR	Comment
	2		NO	Switch 1
3	4	MAIN END		

2 Click . BS, B and BE are inserted.

The sections from BS to B and from B to BE are the upper portion and lower portion of the branch, respectively, in the ladder configuration.

Rungs	Steps	Label	Ladder Inst...	Operand 1
1	0	MAIN START		
2	1		SOR	Comment
	2		BS	
3	3		NO	Switch
	5		B	
3	6		BE	
	7	MAIN END		

NOTE

- A BS (Branch Starting Point) can also be inserted using the  icon or right-click menu as shown below.

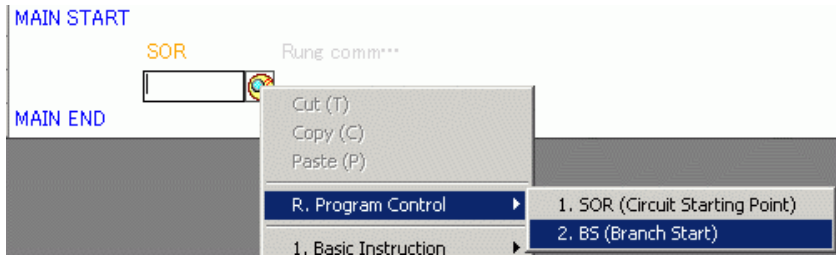

29.5 Ladder Instruction Insertion

29.5.1 Editing Instructions

■ Inserting Instructions

- 1 Select where you want to insert the instruction, and on the [Logic (L)] menu, click [Insert Instruction (I)].



NOTE

- You can also insert an instruction in the following way.
 - Double-click where you want to insert the instruction.
 - Right-click where you want to insert the instruction, and then click [Insert Instruction (I)].
 - Press INSERT.
 - In the Instruction toolbar, click the instruction icon to insert the instruction immediately. Ladder instruction icons that are not displayed in the ladder instructions can be displayed by customizing.
- ☞ "29.13.8 Toolbar Customization" (page 29-145)

- 2  Click to select the instruction.

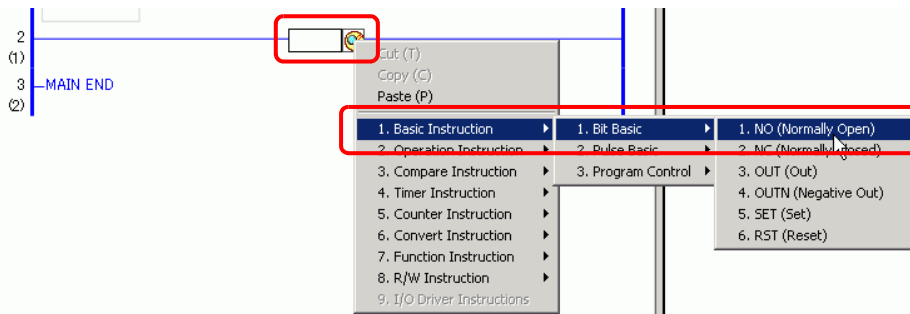

NOTE

- You can also type the instruction directly into the text box. Every time you enter a character, possible instructions for the input text are displayed.

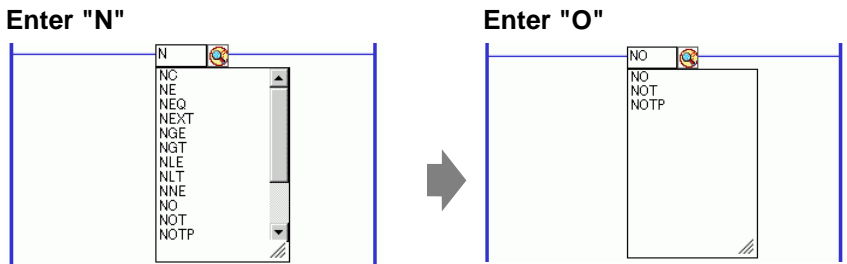

- On the [View (V)] menu, select [Option Settings (O)]. The [Option Settings] window opens. In the [Option Settings] window, select [Logic Edit Style] > [Delete (E)]. Select the [Set up operands when adding instructions] check box. The operand input box will appear when the instruction is inserted.

☞ "29.6.1 Operand Settings" (page 29-57)

3 The instruction is inserted.

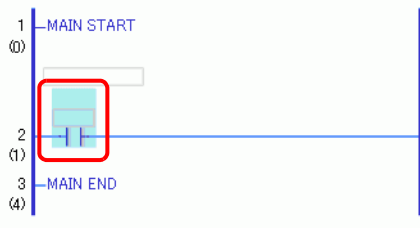

■ Deleting Instructions

1 Select the instruction that you want to delete.

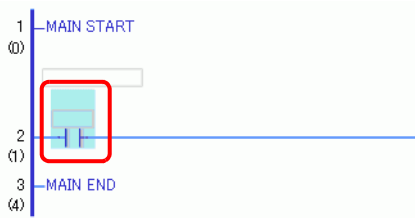

2 Click . The instruction is deleted.

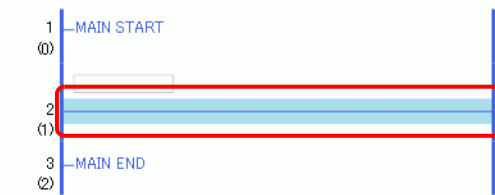

NOTE

- You can also delete an instruction in either of the following ways.
- Right-click and then click [Delete (D)].
- Press DELETE.

■ Copying Instructions

You can save time by copying the instruction and pasting it in the desired location.

1 Select the instruction that you want to copy.

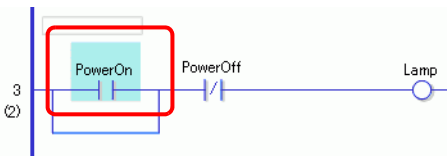

2 Click .

The selected instruction is copied to the clipboard.

NOTE

- You can also copy an instruction in either of the following ways.
- Right-click and then click [Copy (C)].
- Press CTRL+C.

3 Paste the copied instruction in the desired location.

NOTE

 " ■ Pasting Instructions" (page 29-45)

■ Cutting Instructions

When you want to move previously created instructions, you can save time by cutting the instruction and pasting it in the desired location.

1 Select the instruction that you want to cut.

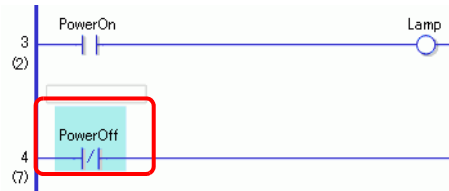

2 Click . The cut instruction is deleted from its original location and copied to the clipboard.

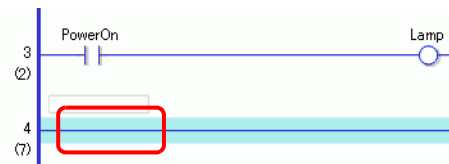

NOTE

- You can also cut an instruction in either of the following ways.
 - Right-click and then click [Cut (X)].
 - Press CTRL+X.
-

3 Paste the copied instruction in the desired location.

NOTE

 " ■ Pasting Instructions" (page 29-45)

■ Pasting Instructions

You can paste instructions that were copied/cut to the desired location.

Here, paste the copied NO instruction (Normally Open) in the branch in the 3rd rung, for example.

An instruction copied to the clipboard



1 Select where you want to insert the instruction.

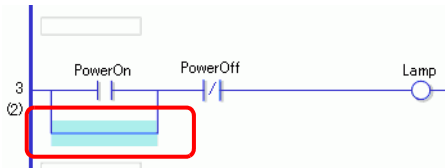

NOTE

- If you select an instruction itself, the original instruction will be replaced with the copied instruction.

2 Click . The instruction on the clipboard is pasted.

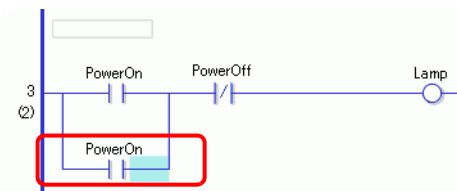

NOTE

- You can also paste an instruction in either of the following ways.
- Right-click and then click [Paste (P)].
- Press CTRL+V.
- When an instruction is pasted, the operands of the instruction are also pasted. Edit the instruction as required.

 "29.6 Allocating Addresses to Instructions" (page 29-57)

■ Edit Instructions

You can change a ladder instruction you created to another instruction in the same ladder instruction group.

NOTE

- For groups of ladder instructions that can be changed, refer to the following.
 "◆ Ladder instruction groups that can change" (page 29-47)

Here, as an example, the NC ladder instruction (Normally closed) on the second rung is changed to NO ladder instruction (Normally open).

1 You can change ladder instructions using the following two methods.

Ladder Instructions

Select the ladder instruction to change by clicking the ladder instruction icon from the ladder instruction toolbar.

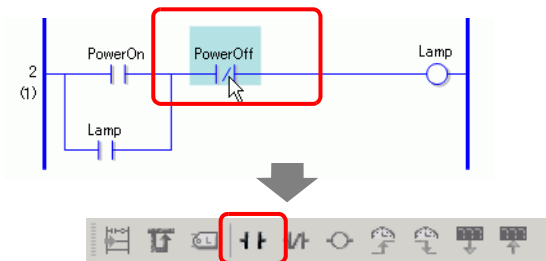

NOTE

- You can only click ladder instruction icons that can change.
- Ladder instruction icons that are not displayed in the ladder instructions can be displayed by customizing.
 "29.13.8 Toolbar Customization" (page 29-145)

Right-click

Right-click the ladder instruction, select [Edit Instruction (H)], and then select the desired ladder instruction.

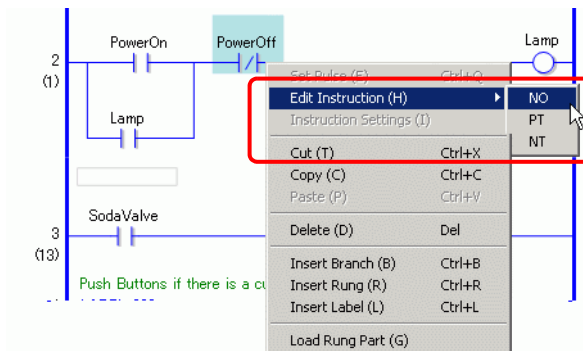

2 The ladder instruction will be changed.

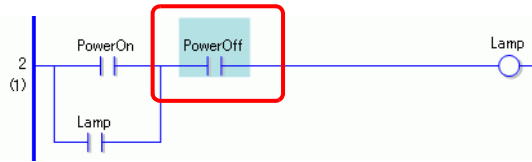

◆ Ladder instruction groups that can change

Group	Instruction
1	NO,NC,PT,NT
2	OUT,OUTN,SET,RST
3	ADD,SUB,MUL,DIV,MOD
4	ADDP,SUBP,MULP,DIVP,MODP
5	INC,DEC
6	INCP,DECP
7	JADD,JSUB
8	JADDP,JSUBP
9	AND,OR,XOR
10	NOT (Overwrite disabled)
11	ANDP,ORP,XORP
12	NOTP (Overwrite disabled)
13	BLMV,FLMV
14	BLMVP,FLMVP
15	SHL,SHR,SAL,SAR,ROL,ROR,RCL,RCR
16	SHLP,SHRP,SALP,SARP,ROLP,RORP,RCLP,RCRP
17	EQ,GT,GE,LT,LE,NE
18	JEQ,JGT,JGE,JLT,JLE,JNE
19	NEQ,NGT,NGE,NLT,NLE,NNE
20	TON,TOF,TP
21	TONA,TOFA
22	CTU,CTD
23	CTUD (Overwrite disabled)
24	CTUP,CTDP
25	CTUDP (Overwrite disabled)
26	BCD,BIN

Continued

Group	Instruction
27	BCDP,BINP
28	ENCO,DECO
29	ENCOP,DECOP
30	RAD,DEG
31	RADP,DEGP
32	I2F,I2R,F2I,F2R,R2I,R2F
33	I2FP,I2RP,F2IP,F2RP,R2IP,R2FP
34	H2S,S2H
35	H2SP,S2HP
36	SUM,AVE
37	SUMP,AVEP
38	SIN,COS,TAN,ASIN,ACOS,ATAN,COT
39	SINP,COSP,TANP,ASINP,ACOSP,ATANP,COTP
40	EXPLN,LG10
41	EXPP,LNP,LG10P

29.5.2 Subroutines and Labels

When a JSR instruction (Jump to Subroutine) or JMP instruction (Jump) is inserted, the GP jumps to the subroutine or label to execute the instruction.

Subroutines and labels have the following differences.

JSR Instruction: Executes a subroutine program with the given name and moves to the position next to the JSR instruction in the main logic program.

JMP instruction: Jumps to the label specified in the JMP instruction and continues to execute the logic program. Continues program execution without returning to the original JMP instruction.

NOTE

- For details on JSR instructions and JMP instructions, refer to the explanation for the relevant instruction.

 Chapter 31 Instructions (page 31-1)

■ Inserting Subroutines

Create a new subroutine screen to which the instruction will jump, and create a subroutine program on the screen.

You can insert JSR instructions anywhere in the logic program.

When the GP executes a JSR instruction, the instruction jumps to the given subroutine with the same name as itself, and the subroutine is executed.

For example, a subroutine could reset counters every time the GP is turned on.

◆ Creating a Subroutine

- 1 On the normal toolbar or the [Screen List] window, click . The [New Screen (N)] dialog box appears.

NOTE

- You can display the [New Screen (N)] dialog box in either of the following ways.
 - Right-click the logic screen in the [Screen List] window and select [New Screen (N)].
 - On the [Screen (S)] menu, click [New Screen (N)].
 - If the [Screen List] tab is not displayed on the work space, on the [View (V)] menu point to [Work Space (W)] and then click [Screen List (G)].
-

- 2 In [Screens of Type], select [Logic] and in [Logic Name], select the subroutine name (for example, SUB-01).

Input the title when necessary. You can input up to 30 characters.

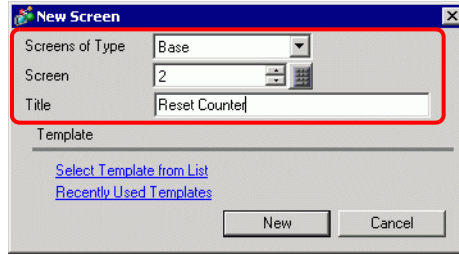

3 Click [New]. The subroutine screen will be displayed.

4 Create the subroutine.

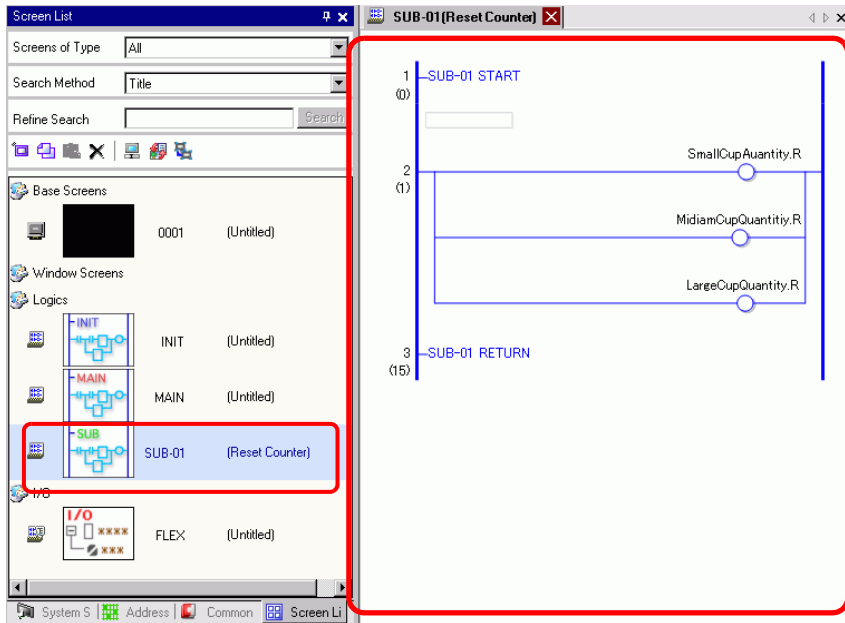

NOTE • To add more than one subroutine to a logic program, repeat steps 1 to 5 to create the desired number of subroutine programs.

◆ **Inserting a JSR Instruction**

To execute the subroutine you created in a specific location in the main logic program [MAIN], you must insert a JSR instruction.

Here, for example, a subroutine [SUB-01] is executed when the OUT instruction (Out) "lamp" in the 2nd rung turns on. The JSR instruction is inserted in the 3rd rung.

1 Select the 2nd rung to enter the rung.

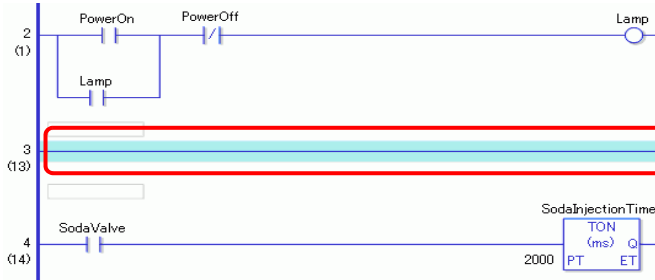

NOTE

- For how to enter a rung, refer to the following.
 ☞ " ■ Inserting Rungs" (page 29-27)

2 Insert a PT instruction in the 3rd rung (Positive Transition) and assign the symbol variable "lamp" to the PT instruction.

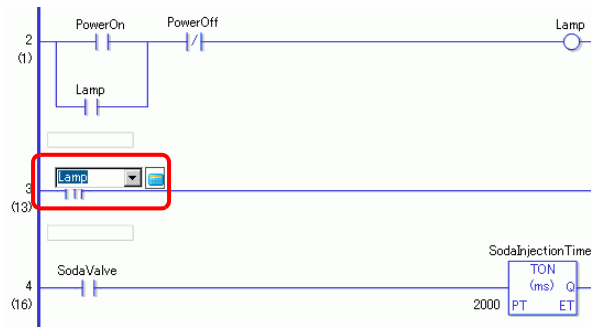

NOTE

- For how to enter an instruction, refer to the following.
 ☞ " ■ Inserting Instructions" (page 29-41)
- For the operand settings, refer to the following.
 ☞ "29.6.1 Operand Settings" (page 29-57)
- For details on an instruction, refer to the explanation of the relevant instruction.
 ☞ Chapter 31 Instructions (page 31-1)

3 Insert the JSR instruction to the right of the PT instruction.

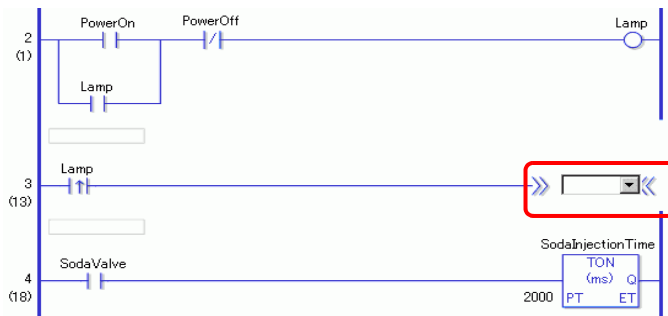

4 For the JSR instruction operand, specify the [SUB-01] subroutine.

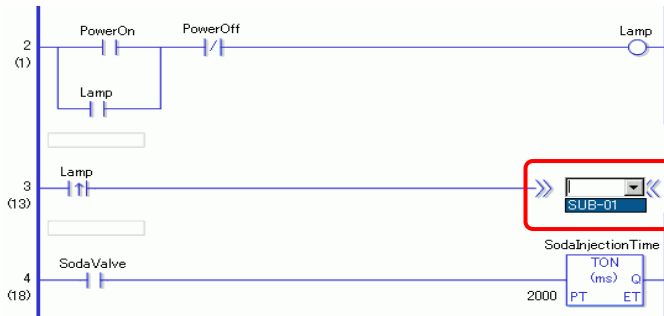

When the "Lamp" ON is detected, the operation jumps to the subroutine program [SUB-01]. After the subroutine program [SUB-01] is executed, the main logic program [MAIN] resumes in the 4th rung.

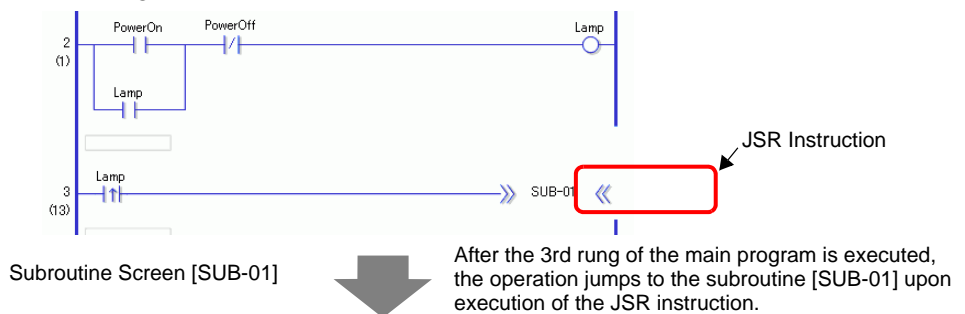

Subroutine Screen [SUB-01]

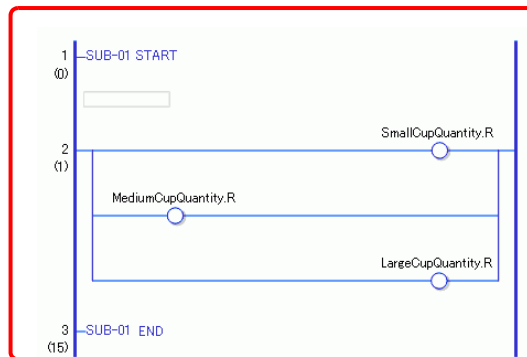

After the [SUB-01] subroutine is executed, the operation returns to run the main program in the 4th rung.

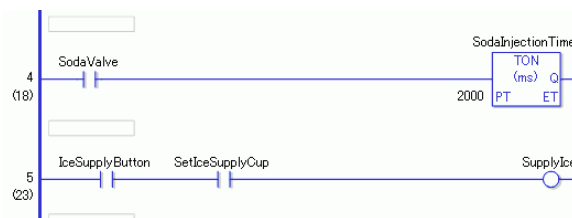

■ Insert Label

You can insert JMP instructions (Jump) and jump labels anywhere in the logic program.

When the GP executes the JMP instruction, the operation jumps to the label with the same name as the instruction, and the logic program continues to run.

Here, for example, a [LABEL-001] label is inserted in the jump instruction, and the operation jumps to the 3rd rung upon execution of the JMP instruction when the "Switch 1" in the 2nd rung turns on.

◆ Inserting a Label

1 Select the 2nd rung.

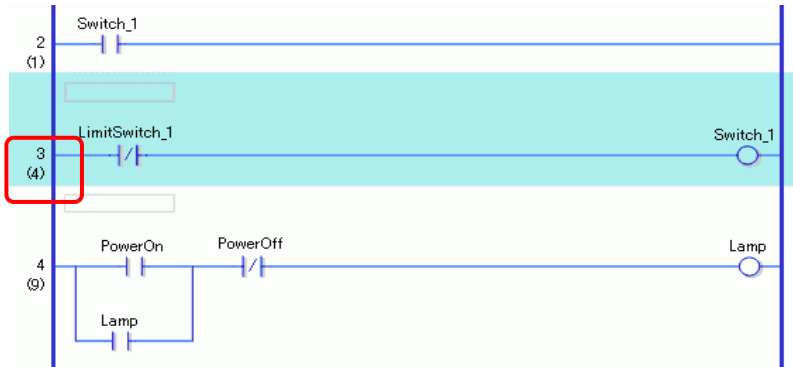

2 Click . The label is inserted in the 3rd rung.

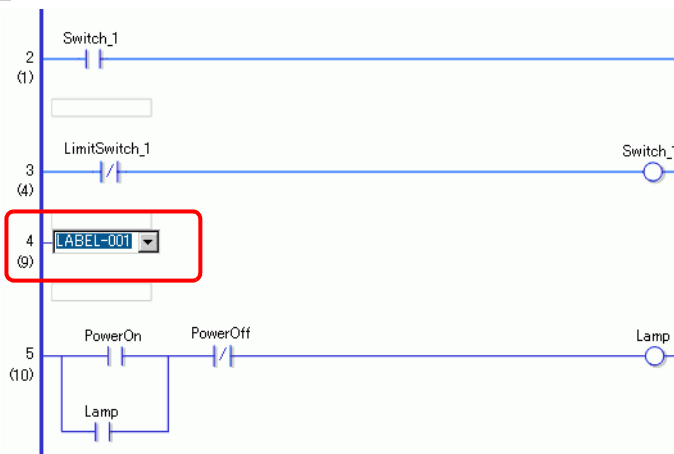

NOTE

- You can also insert a label in any of the following ways.
- On the [Logic (I)] menu, click [Insert Label (L)].
- Right-click and then click [Insert Label (L)].
- Press CTRL+L.

3 Select the label name (for example, LABEL-001).

◆ **Inserting a JMP Instruction**

1 Insert a JMP instruction to the right of "Switch 1" of a NO instruction (Normally Open) in the 2nd rung.

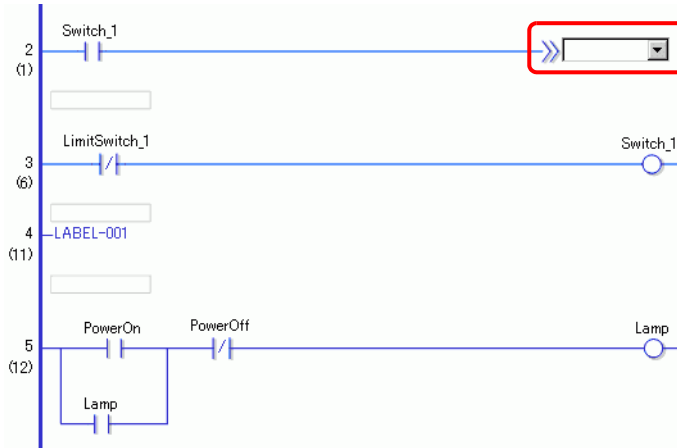

NOTE

- For how to enter an instruction, refer to the following.
 ☞ " ■ Inserting Instructions" (page 29-41)

2 Specify an operand label [LABEL-001] for the JMP instruction operand.

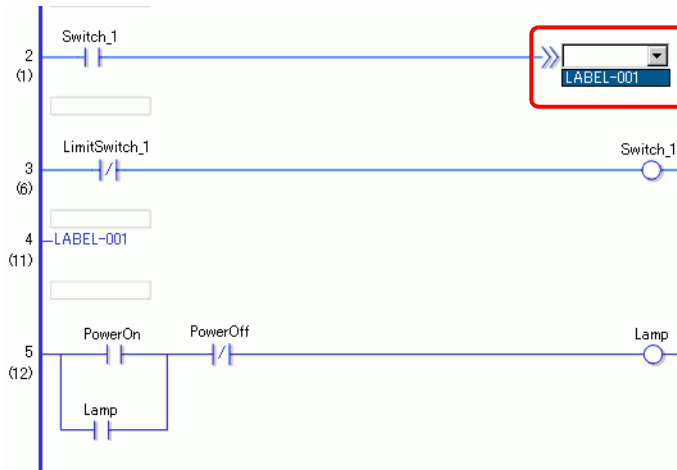

When the "LABEL-001" JMP instruction is detected, the operation jumps to the [LABEL-001] label. After the [LABEL-001] label is executed, the logic program runs from the next rung.



When "Switch 1" is on, the JMP instruction "LABEL-001" is detected and the operation jumps to the [LABEL-001] label in the 4th rung.

The 3rd rung will not be executed.



Executes from the 4th rung.

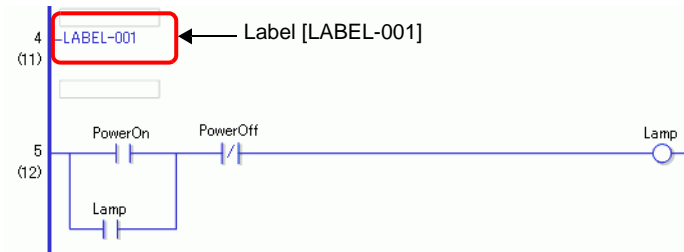

NOTE

- Specify the same name for the variables and labels allocated to the JMP instruction. The instruction will jump to the label with the same name.
- Right-clicking the JMP instruction and selecting [To Corresponding Area (O)] causes the cursor to move to the corresponding label.

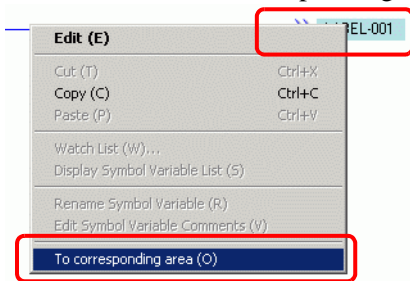

- Right-clicking the label and selecting [To Corresponding Area (O)] - [~th rung JMP](~ means rung number) causes the cursor to move to the corresponding JMP instruction.

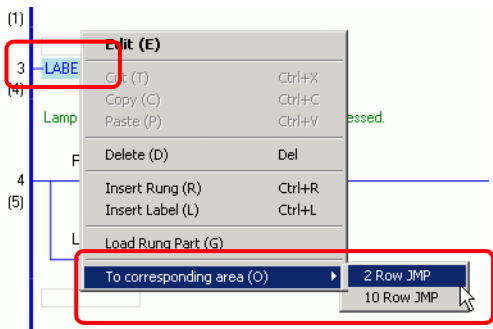

29.6 Allocating Addresses to Instructions

NOTE

- For details on the instructions, refer to the relevant instructions.
 ☞ Chapter 31 Instructions (page 31-1)

29.6.1 Operand Settings

The following explains how to allocate values and symbol variables (addresses) to instructions.

NOTE

- In the [Option Settings] window, select [Logic Edit Style] > [Delete (E)]. Select the [Set up operands when adding instructions] check box. The operand input box will appear when the instruction is inserted.
 ☞ "5.17.7 [Preferences] Settings Guide ■ Logic Common" (page 5-193)
- You can change the operand details using the property window.
 ☞ "29.13.5 Using Reference Features to Search Logic Programs" (page 29-130)

■ Setting Operands, Basic

When an instruction is inserted in a rung, the operand input box will appear. In the box, enter the value and symbol variable (address) to be linked to the instruction.

Here, for example, the symbol variable "lamp" is allocated to an OUT instruction (Out).

- 1 Double-click the OUT instruction (Out) operand. A text box is displayed for entering the operand.

NOTE

- You can display the operand input box in either of the following ways.
- Right-click the operand and then click [Edit (E)].
- Select the operand and press ENTER.

- 2 Type "lamp" in the text box and press ENTER.

A message appears: "Register 'lamp' as bit variable."

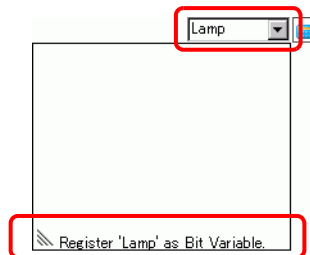

3 Press ENTER. The [Confirm Symbol Registration] dialog box appears. Click [Yes (Y)].

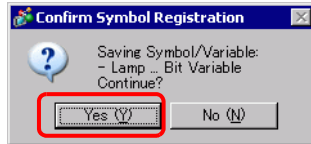



4 The symbol variable type necessary for the instruction will be allocated. In this case, a "bit variable" type is allocated.

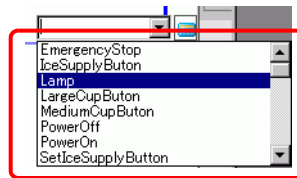

NOTE

- If symbol variables that can be allocated were previously registered, or if the system variables can be allocated, click  to display those variables. You can select and specify the displayed symbol variables and system variables.



- To directly enter the address, click .

GP-Pro EX automatically assigns the type necessary for the new symbol variable created for the instruction.

■ Setting Operands, Advanced

Advanced instructions have more than one operand.

Here, the operand settings procedures for a TON instruction (On Delay Timer) are explained as an example. A symbol variable "soda injection time" is allocated to an operand and a setting time [setting time (PT)] for the timer output to turn on is allocated to another operand.

1 Double-click the TON instruction (On Delay Timer) operand. A text box is displayed for entering the operand.



NOTE

- You can display the operand input box in either of the following ways.
- Right-click the operand and then click [Edit (E)].
- Select the operand and press ENTER.

2 Input "soda injection time" in the text box and press [Enter] to check.

A message appears: "Register 'soda injection time' as timer variable."

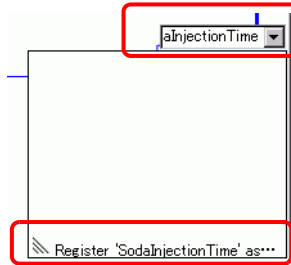

3 Press the [Enter] key. The [Confirm Symbol Registration] dialog box appears. Click [Yes (Y)].

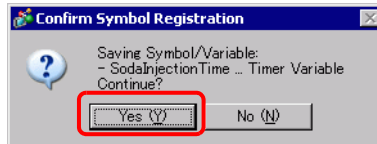

4 The symbol variable type necessary for the instruction will be allocated. In this case, a "timer variable" type is allocated.

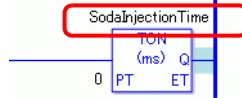

NOTE

- If symbol variables that can be allocated were previously registered, or if the system variables can be allocated, click  to display those variables. You can select and specify the displayed symbol variables and system variables.

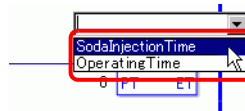

5 The default value "0" is input in the setting value [Setting Time (PT)]. Double-click the instruction to change the [Setting Time (PT)].

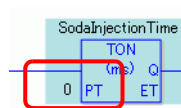

NOTE

- Right-click and then click [Instruction Settings]. The setting dialog box appears.
- If no symbol variable is input in Procedure 1, the setting dialog box will not appear.
- For some instructions, the setting dialog box might not appear.
- The setting dialog box differs depending on the instruction.

- The setting dialog box for the TON instruction (On Delay Timer) will be displayed. Change the settings as necessary and click [OK (O)].

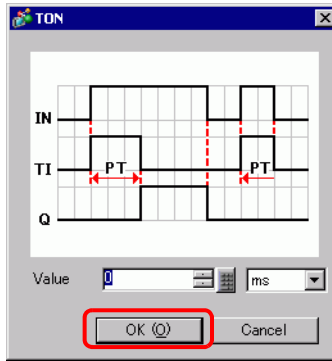

■ Operand Settings Using Drag and Drop

When the symbol variable has already been registered for the instruction, you can drag the variable from the [Address] window to specify the operand. Here, an NO instruction (Normally Open) is specified for the symbol variable "power on button" of the "bit variable" type.

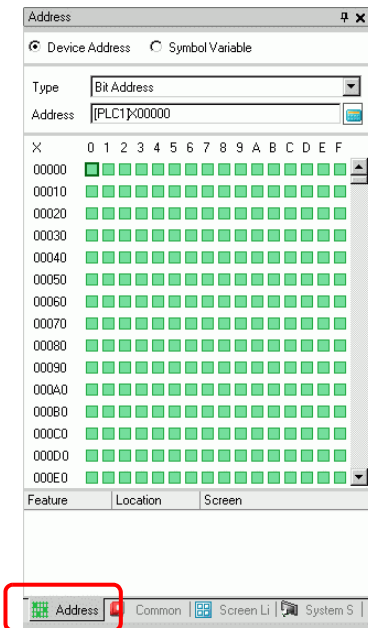

- Select the [Address] tab to open the [Address] window.

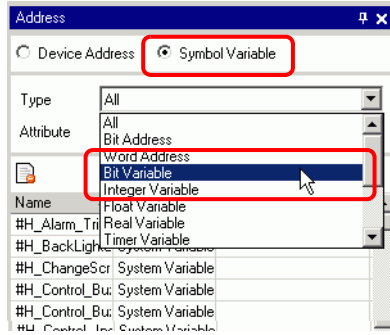

-
- NOTE**
- If the [Address] tab is not displayed in the Work Space, on the [View (V)] menu, point to [Work Space (W)], and then click [Address (A)].
-

2 Select [Symbol Variable], and for the [Type] select [Bit Variable].



3 Only symbol variables whose [Type] are [Bit Variable] are displayed. On the list, click [Power on Button]. Release the left button when the pointer changes from  to .

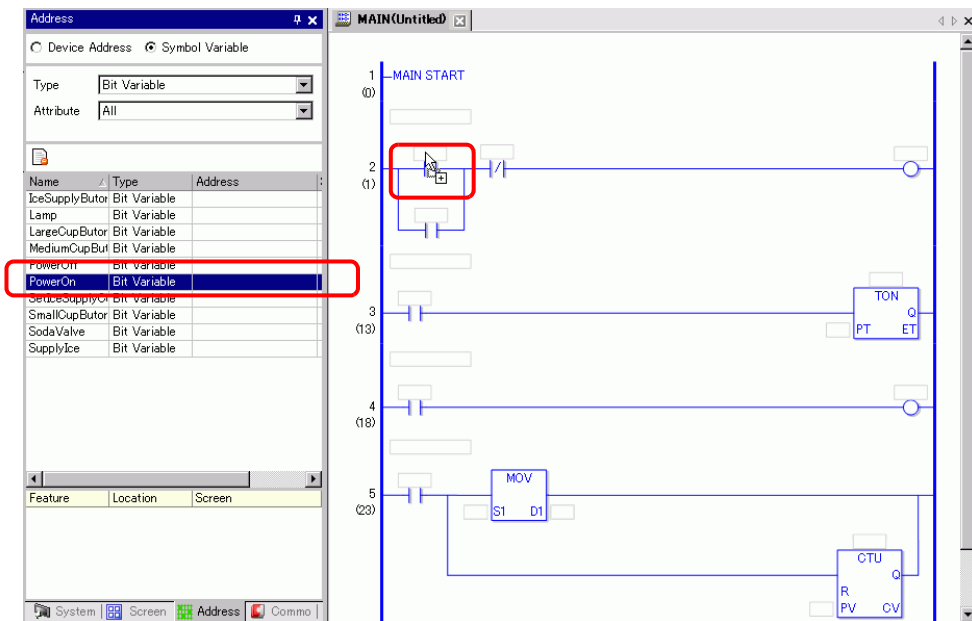

4 The symbol variable has been allocated to the instruction operand.



NOTE

- Whether the variable type is [Bit Variable], [Integer Variable], [Float Variable], or [Real Variable] set up as arrays, or structure variables [Timer Variable], [Counter Variable], [Time Variable], [Date Variable], or [PID Variable] which consist of several variables, all the possible variables are displayed. Select the variable from the displayed list of variables.

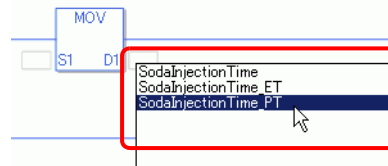

■ Pulse Settings

You can change instructions into pulse settings as follows.

- 1 Right-click the instruction that you want to change and then click [Pulse Settings].



- 2 The instruction is changed into a pulse setting.

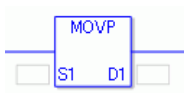

NOTE

- To cancel the pulse setting, right-click and then click [Remove Pulse].
-

29.7 Input Comments

GP-Pro EX allows you to add logic program titles and comments to rungs and symbols variables.

Comments improve readability and are useful when debugging and making changes.

29.7.1 Adding Titles

- 1 Click the [Screen List] tab to open the [Screen List] window.

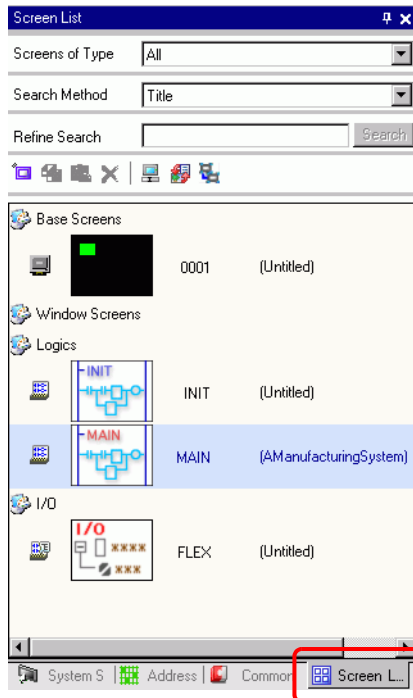
**NOTE**

- If the [Screen List] tab is not displayed on the work space, on the [View (V)] menu point to [Work Space (W)] and then click [Screen List (G)].

2 Select the logic screen to which you want to add the title and click . The [Change Screen Attributes] dialog box appears.

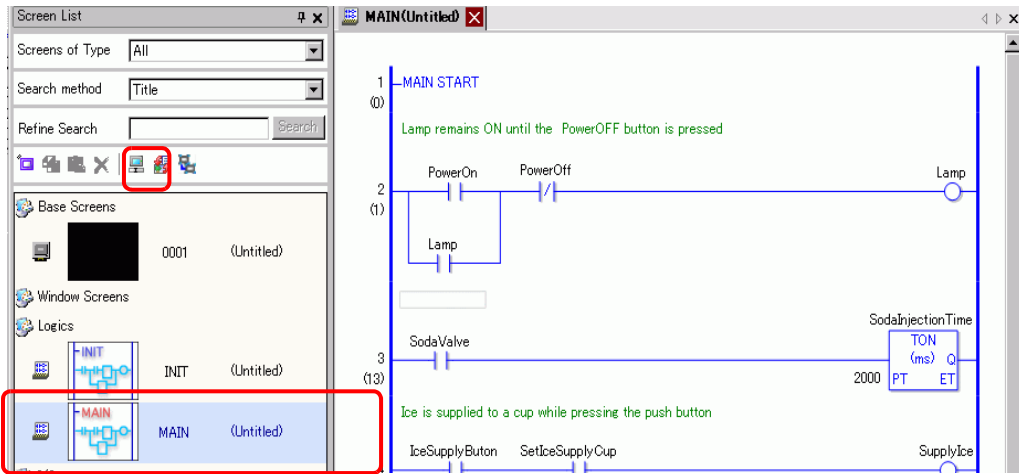

NOTE • Right-click the logic screen in the [Screen List] window or screen tab, then click [Change Attributes] to display the [Change Screen Attribute] dialog box.

3 Enter the title and click [Change].
Enter up to 30 characters.

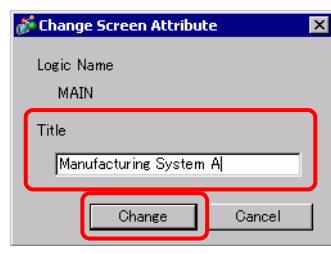

4 The title is displayed to the right of the logic screen and in the screen tab.

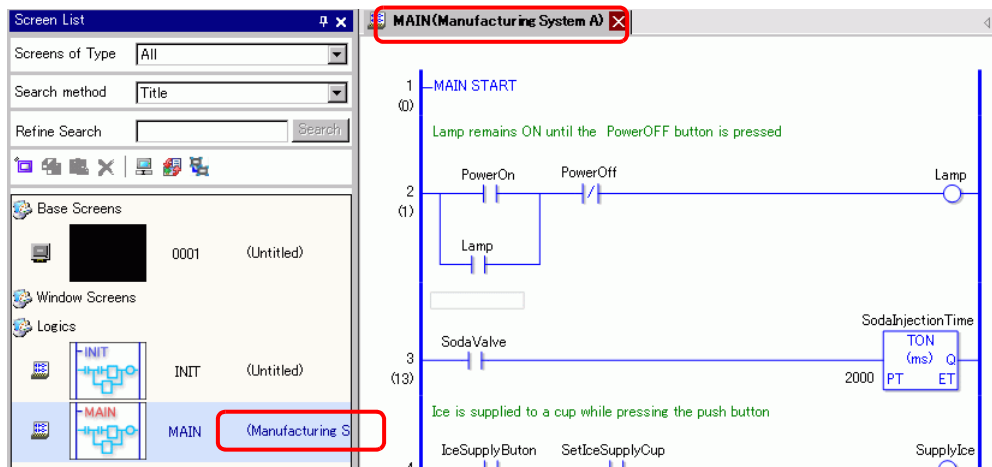

NOTE • You can also add and change the titles in [Properties].
☞ "29.13.5 Using Reference Features to Search Logic Programs" (page 29-130)

29.7.2 Adding Rung Comments

You can add comments to each rung in a logic program.

1 Double-click the part for rung comments. The comment input box will be displayed.

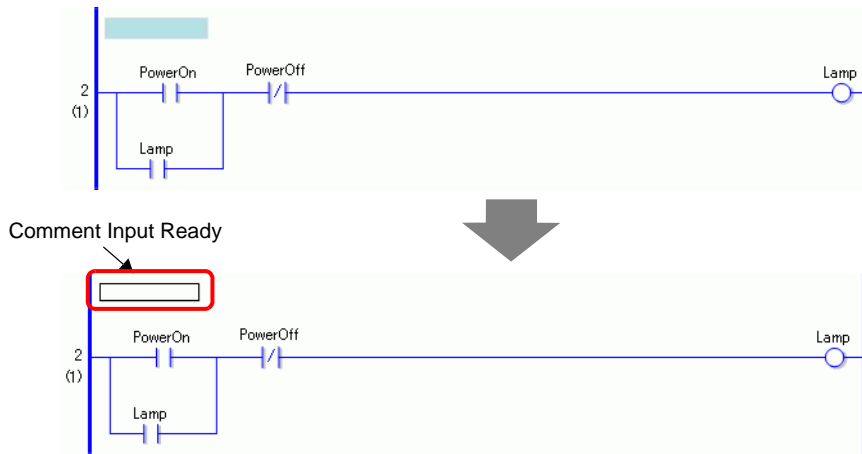

NOTE

- To input comments, right-click the rung comment portion and then click [Delete (E)].

2 Enter the rung comment in the text box.
Enter up to 128 characters.

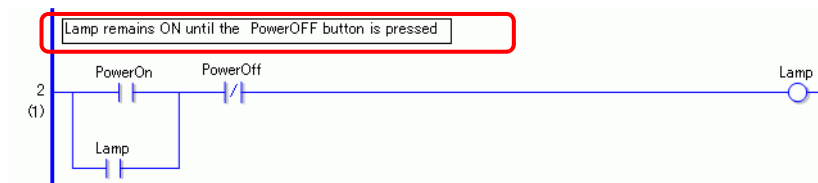

NOTE

- Press SHIFT+ENTER to insert a line feed.

3 Press ENTER to input the text. The rung comment has been input.

NOTE

- You can also add and change rung comments in [Properties].
 ☞ "29.13.5 Using Reference Features to Search Logic Programs" (page 29-130)
- You can display a list of rung comments and edit the comments in the [Comment List] window.
 ☞ "29.7.4 [Comment List] Window" (page 29-69)

IMPORTANT

- Define the number of comments you can have in the project in the [Project Information] dialog box, [Logic Memory] area. Do not store comments that exceed the [Logic Memory].
 - ☞ "29.13.2 Checking the Size for Creating Programs" (page 29-112)
 - You cannot edit the rung comments during online monitoring.
 - You can add rung comments to rungs and normal labels. You cannot add them to start and end labels.
-

29.7.3 Symbol Variable Comments

Enter variable comments in the [Edit Symbol Variable] window's [Comment] field. Up to 32 characters long.

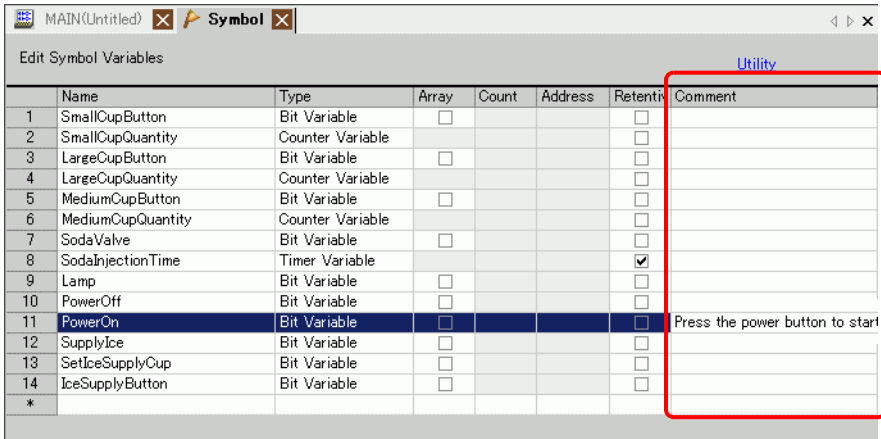

NOTE

- For how to input the symbol variable comments, refer to the following.
 - ☞ "■ Registering Symbol Variables" (page 29-17)
- You can also add and change the symbol variable comments in [Properties].
 - ☞ "29.13.5 Using Reference Features to Search Logic Programs" (page 29-130)
- You can display a list of symbol variable comments and edit the comments in the [Comment List] window.
 - ☞ "29.7.4 [Comment List] Window" (page 29-69)
- A comment about the system variable can be added or changed using the [Edit Symbol Variable Comment] dialog box, which is displayed by right-clicking the symbol variable section allocated to the instruction and selecting [Edit Symbol Variable Comments (V)].

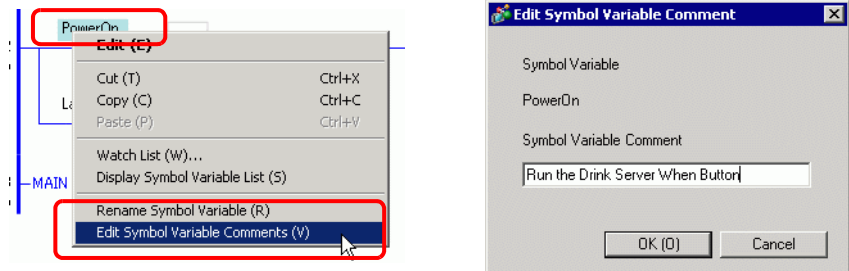

- A comment about the symbol variable is displayed in a tool tip when the cursor is placed over the symbol variable part of the instruction.

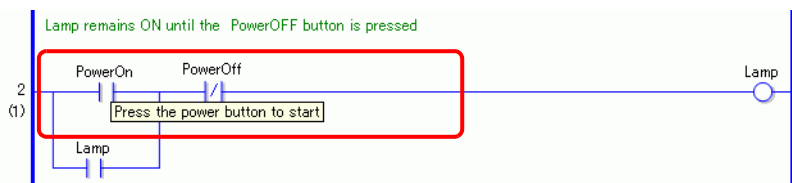

NOTE

- Press the [F9] key to display all comments in the logic.

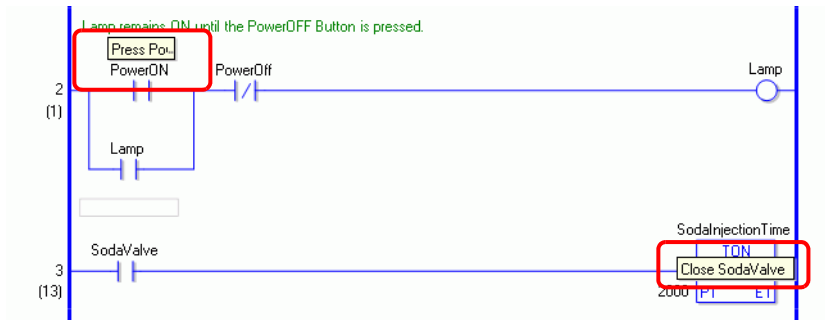

If the entire comment does not fit in the comment area, the rest of the comment is indicated by a "...".
 Click the comment to view it in its entirety.



IMPORTANT

- Define the number of symbol variable comments you can have in the project in the [Project Information] dialog box, [Logic Memory] area. Do not store comments that exceed the [Logic Memory].
 ☞ "29.13.2 Checking the Size for Creating Programs" (page 29-112)
- You cannot edit the symbol variable comment during online monitoring.

29.7.4 [Comment List] Window

Use the [Comment List] to view variable, symbol, system variable, and rung comments in the logic program.

NOTE

- Please refer to the Settings Guide for details.
- ☞ "29.14 Settings Guide" (page 29-159)

■ Using the [Comment List] Window

- 1 On the [View (V)] menu, point to [Work Space (W)] and then click [Comment List (C)]. The [Comment List] window opens.
- 2 In [Target Item], select the type of comment type you want to display in the list.

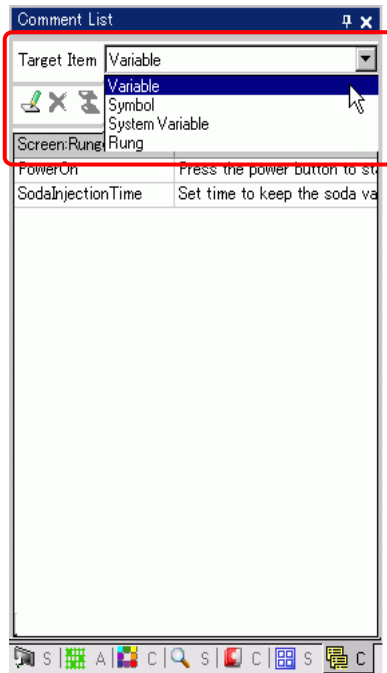

- 3 To edit a comment, select the comment and click .

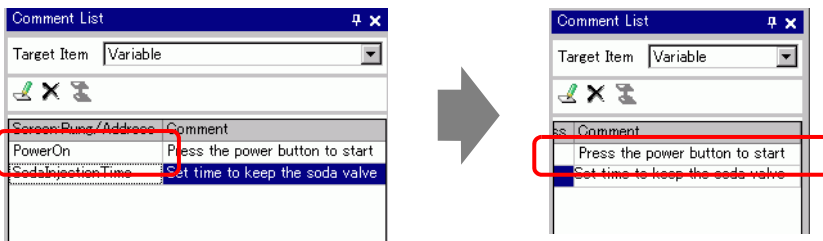
NOTE

- You can edit the comment in the following ways.
- Double-click the comment.
- Right-click the comment and click [Delete (E)].

4 To delete the comment, select the comment and click .

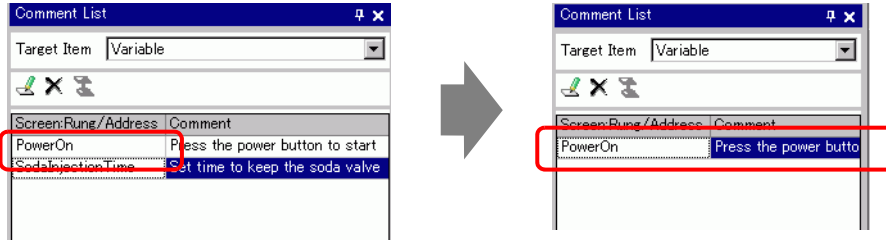

- NOTE**
- You can delete the comment in the following ways.
 - Double-click the comment.
 - Right-click the comment and click [Delete].
 - Select the comment and press DELETE.

5 When [Target Item] is [Rung], double-click a cell in the [Screen: Rung/Address] column to select the rung in the logic with the comment you want to delete.

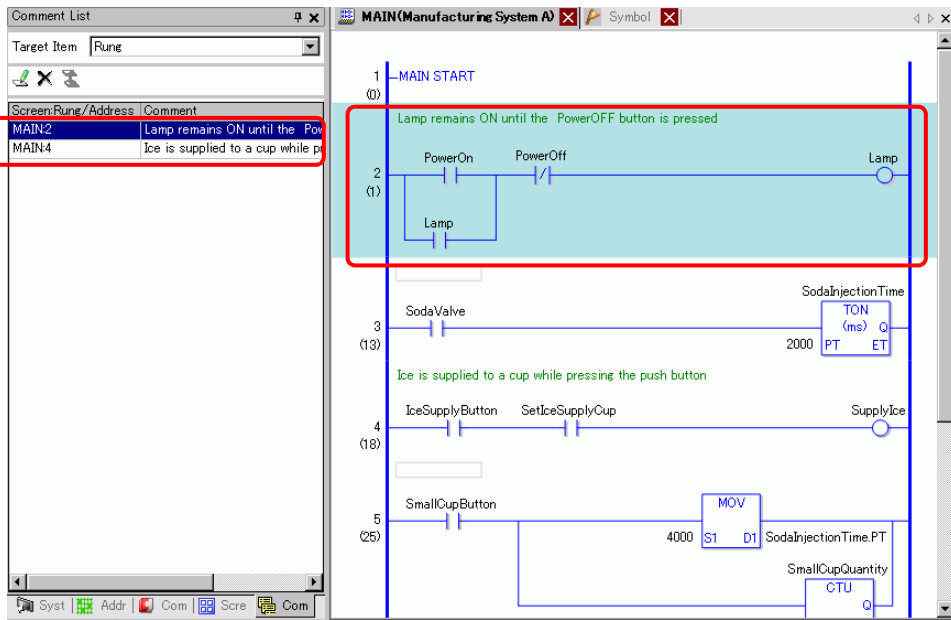

6 When [Target Item] is [Variable] or [System Variable], double-click the cell in the [Screen: Rung/Address] column. This displays the [Address] window and selects the relevant symbol variable or system variable.

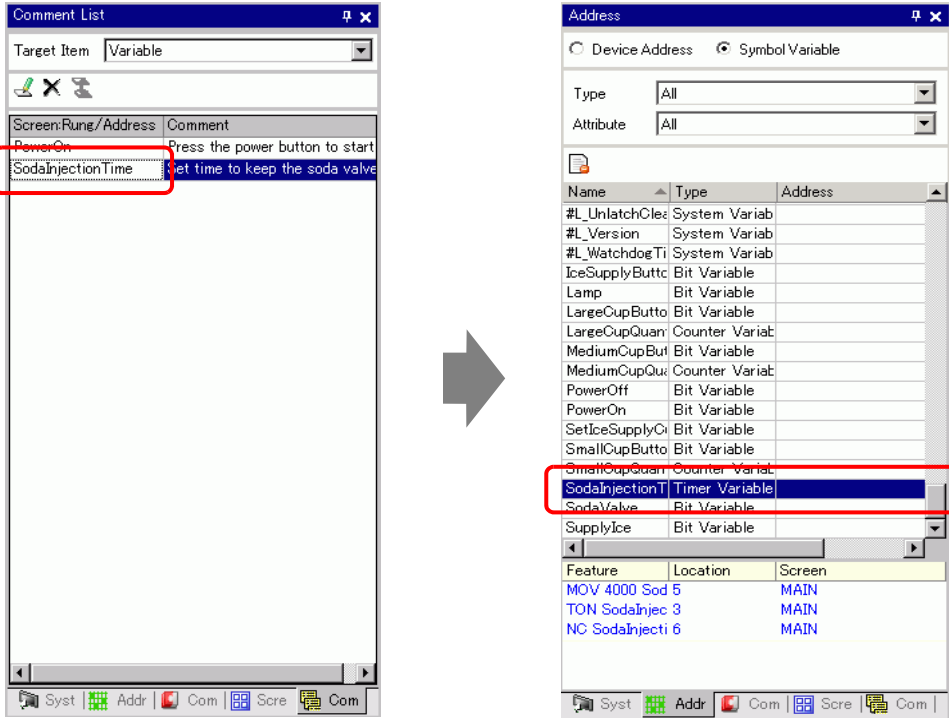

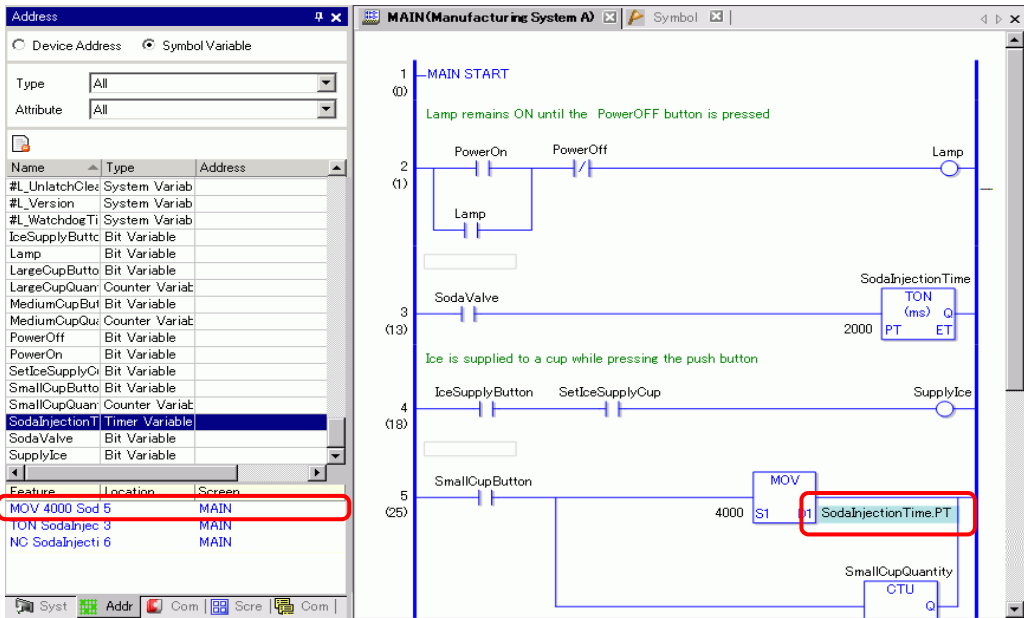

7 Select the lower part of the [Address] window to select the target variable on the logic screen.



29.8 Logic Operations with Power ON

Determine whether to run or stop the logic programs when the GP is on.

NOTE

- Please refer to the Settings Guide for details.
 " ◆ Logic" (page 5-173)
- You can configure the logic screen settings in offline mode.
- For restrictions of logic action when the power is ON, refer to the following.
 " ◆ Logic" (page 5-173)

1 Select the [System Settings] tab to display the [System Settings] workspace.

NOTE

- If the [System Settings] tab is not displayed in the workspace, on the [View (V)] menu, point to [Workspace (W)], and then click [System Settings (S)].

2 From [Display], select [Display Unit].

- 3 Select the [Logic] tab, and then select either [RUN] or [STOP] under [Logic Program Operation] of the [Run at Start Up] section under [Logic].

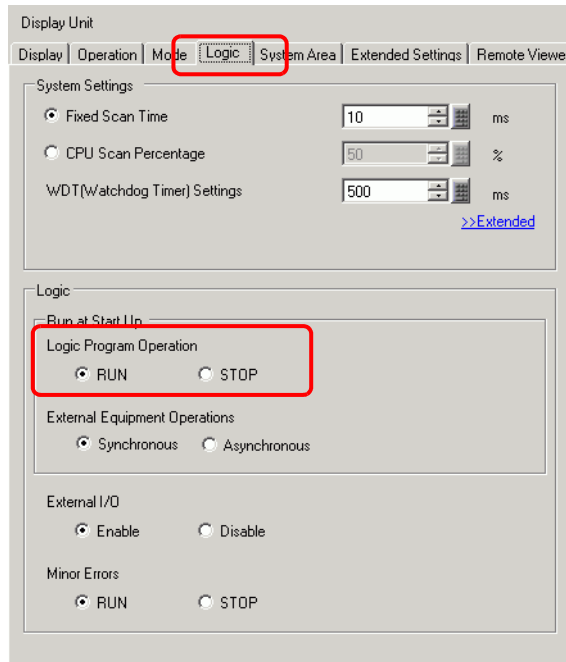

NOTE

- Select [Synchronous] in [External Equipment Operations] to synchronize communication with external devices when the power is ON.

■ Communication synchronization with external devices when powering up

External equipment operations when the power is ON are handled as follows.

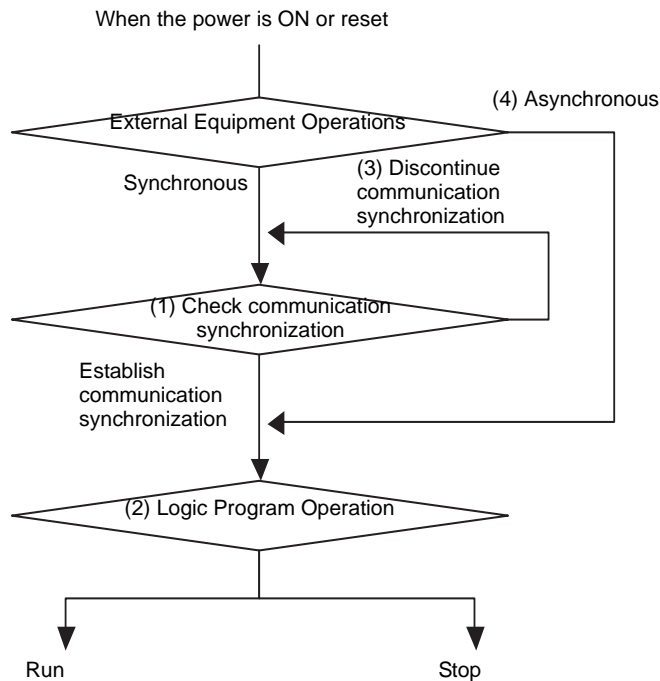

- (1) When [External Equipment Operations] is set to [Synchronous], check whether communication synchronization is established.
- (2) When synchronization is selected, for [Logic Program Operation] select either the [RUN] or [STOP] option.
- (3) When synchronization is not selected, the logic program checks for synchronous communication to start. Logic will not start until synchronization is set.
- (4) When the [External Equipment Operations] is [Asynchronous], the logic program does not check whether communication synchronization has been set.

- * Communication synchronization is checked only when the power is ON and the controller is reset.
- * While the power is ON, when [External Equipment Operations] is set to [Synchronous], it checks whether communication synchronization is established even when [Logic Program Operation] is set to [STOP].
- * Synchronize only external addresses (external devices) used in the logic programs.

29.9 Transferring Logic Programs

Logic programs are transferred in project file format. You cannot transfer logic programs alone.

NOTE

- For details on how to transfer, refer to the following.
 - ☞ Chapter 33 Transferring Projects and Data (page 33-1)
- When a project is transferred or saved, error checking is performed automatically.
Program files cannot be transferred to GP if an error is detected. To check for errors before transferring, refer to the following.
 - ☞ "33.9 Checking Errors" (page 33-55)

■ Retentive Transfer

When using the transfer tool to download a project with the same name as on the GP, and project transfer is set to [Auto] and the Retain retentive variables check box is selected, you can transfer the project while retaining GP variable values backed up to SRAM. Variable values cannot be retained at download if the system settings are different, the project on the GP is damaged, the Retain retentive variables check box is not selected, or transfer is set to Forced. Here, if the keep transfer check box is not selected or the compulsory transfer check box is selected, you cannot transfer the file by keeping the current value.

If the [Retain retentive variables] check box is cleared, the variable value is cleared to 0 even if in the [Symbol Variable] common settings [Retentive] is selected. [Retain retentive variables] check box should be selected to retain values of variables that use the [Retentive] setting.

1 Connect the GP to your PC.

2 On the state toolbar, click the transfer project icon  to start the transfer tool and click [Transfer Settings].

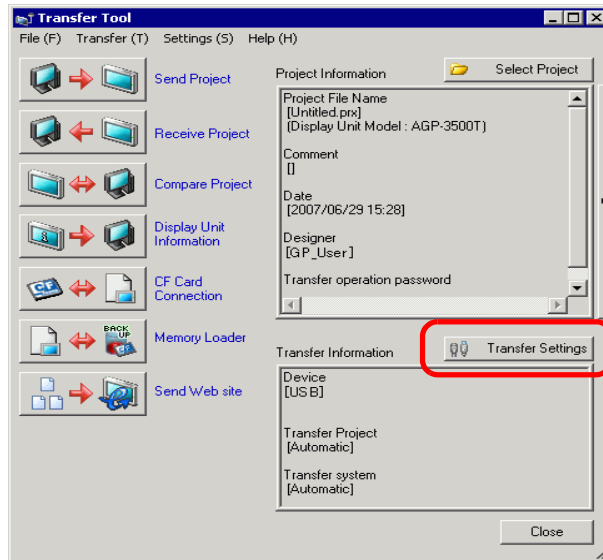

3 The [Transfer Settings] dialog box appears. Select the [Retain retentive variables] check box in [Transfer Project] and click [OK (O)].

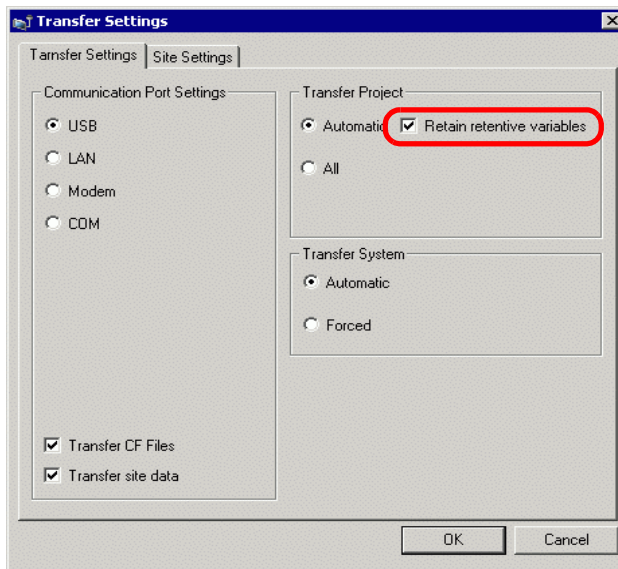

4 In the Transfer Tool, click [Send Project] to start transferring to the GP.

29.10 Logic Program Error Correction

Program files cannot be transferred to GP if an error is detected. Detected errors are listed on the [Error Check] window.

■ Display the [Error Check] window

The [Error Check] window is hidden when logic is being edited.

It will be displayed automatically when the mouse cursor is placed on the [Error Check] tab on the bottom-right of the screen. When the mouse cursor is moved back to the editing screen, it will be hidden automatically.

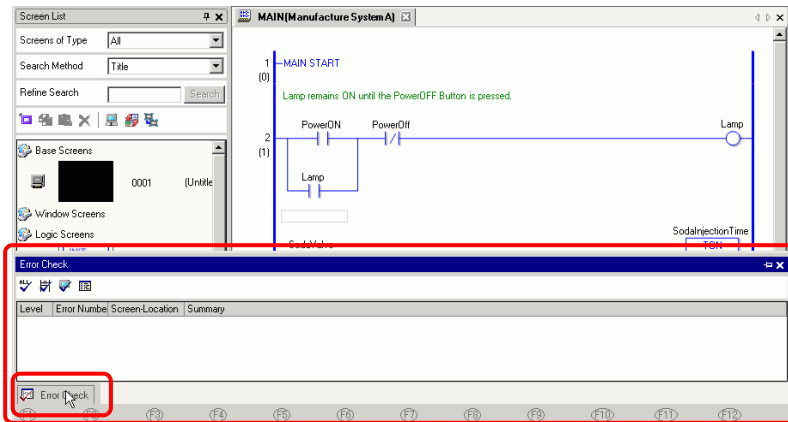
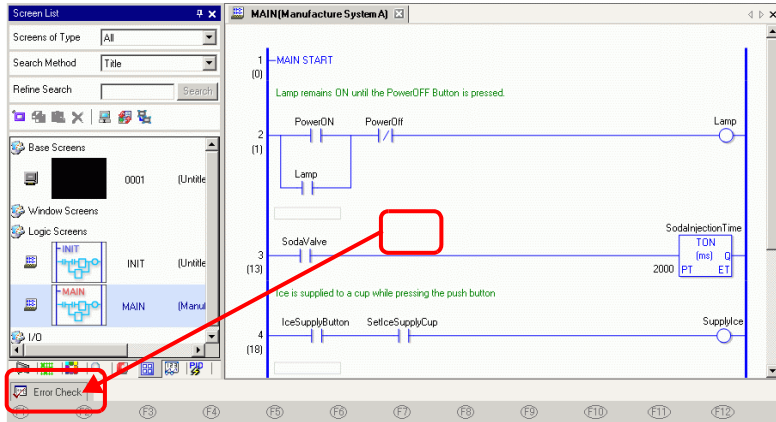



NOTE

- If the [Error Check] window is not displayed, from the [Display (V)] menu point to [Work Space (W)] and click [Error Check Window (E)].
- If showing and hiding of the [Error Check] window does not occur automatically, click  on the top-right of the [Error Check] window.

■ Running Error Check

The following methods allow you to run an error check.

- Click  in the toolbar.
- Click  on the [Error Check] window.
- Select [Error Check (E)] from the [Utility (T)] of the [Project (F)] menu.

■ Error Correction

Refer to the displayed [Level], [Error Number], [Screen Location], and [Summary] to create appropriate logic programs.

By displaying the logic screen and selecting the error rung, the error in the logic program will be selected. This will help you correct the error.

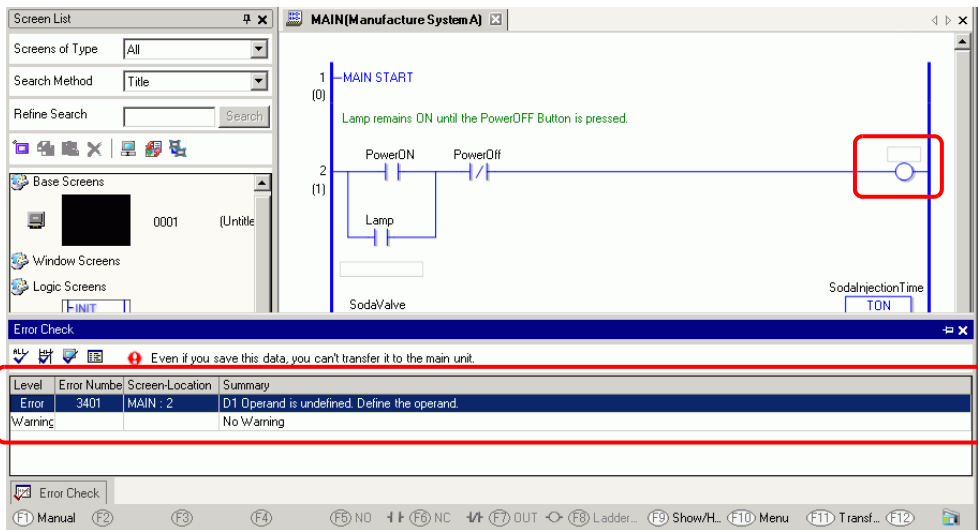

NOTE

- In [Preferences], you can select the settings to display duplicate coil warnings during error checking.
 "5.17.7 [Preferences] Settings Guide ■ Error Check" (page 5-192)
- Up to 100 errors and warning messages can be displayed. If more than 100 errors and/or warnings are generated, only excess messages will be displayed.

29.11 Monitoring Logic Programs on the Computer (Online Monitor)

You can monitor logic programs running in the GP on the computer.

In the [Watch List] window, you can check the symbol variable ON/OFF state or device values. In the [PID Monitor] window, you can also make adjustments to the PID instruction values while monitoring. These features make it useful for debugging.

The Online Monitor can be run simultaneously with a computer connected via USB and a computer connected via Ethernet (LAN).

NOTE

- AGP-3301S, AGP-3301L, and AGP-3302B do not support the online monitor.
 - In [Preferences], you can configure the communication settings and monitor the settings with online monitoring.
- ☞ "5.17.7 [Preferences] Settings Guide ■ Monitor Step Common Settings" (page 5-197)

29.11.1 Online Monitoring Procedures

1 To your PC, connect the GP that you want to monitor.

2 In GP-Pro EX, from the state toolbar, click the monitor icon . Monitor step begins.

NOTE

- If you click the monitor icon while editing a project, the [Project File Save] dialog box appears. Click [Yes (Y)] to save the edited logic program. Upon saving, the logic program performs an error check. If any errors are detected, monitor mode will not start. Instead, an error message will display. Click [OK (O)], fix the error, and then start from step 2 again. If there are no errors, monitor mode starts up. Click [No (O)] to discard any changes made to the logic program and start up monitor mode. Click [Cancel] to return to the editor without saving any changes.

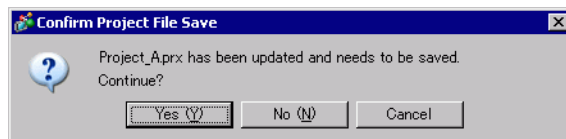

- If a monitor password has been set up, enter the password.
- ☞ "29.13.4 To enhance security" (page 29-128)

3 The lines in the logic program turn green to show the operational status of the logic program. Check its operation.

To stop the logic program, select [Command (C)] from the [Controller (C)] menu and then click [Stop (S)] or [Pause (P)]. (Stopping the logic program changes the front LED of the GP unit from constant green to flashing green.)

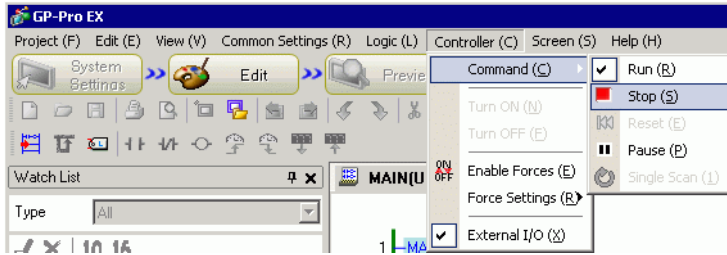

29.11.2 Monitor/Change the Current Value of Symbol Variables

You can monitor the symbol variable ON/OFF and the device values within the logic program registered in the [Watch List] window.

NOTE

- Please refer to the Settings Guide for details.
 ☞ "29.14.2 [Work Space] Settings Guide ■ Watch List" (page 29-166)

- 1 On the [View (V)] menu, point to [Work Space (W)] and then click [Watch List (W)]. The [Watch List] window appears.
- 2 Right-click the symbol variable that you want to monitor within the logic program and then click [Watch List (W)]. The symbol variable is added to the [Watch List] window.

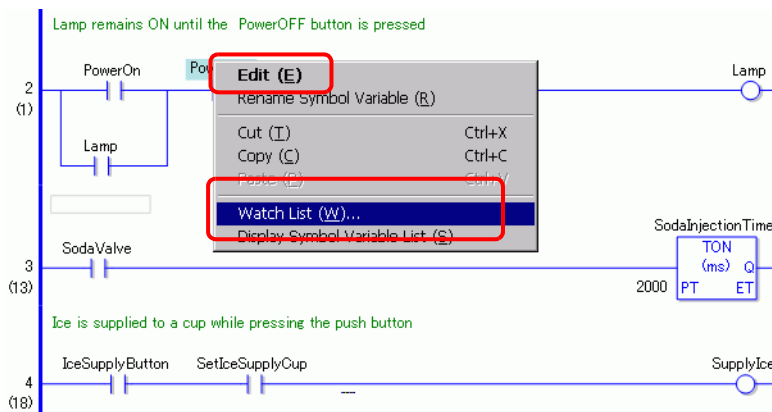

NOTE

- To add a variable to the Watch List, drag the symbol variable to monitor and drop it into the Watch List. You can register multiple symbol variables collectively by selecting, dragging, and dropping them.
- You can also add the variable by selecting [Symbol Variable] in the [Address] window, right-clicking the symbol variable that you want to monitor, and clicking [Add to Watch List].

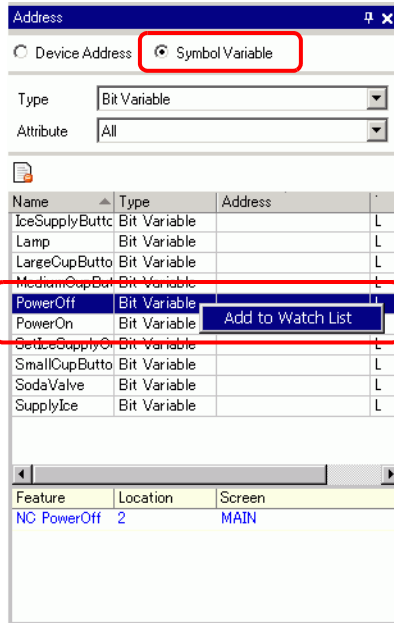

3 In the [Watch List]'s Type list, select the data type of symbol variables to monitor.

4 Transfer the project to the GP.

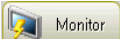
5 In GP-Pro EX, from the state toolbar, click the monitor icon . Monitor step begins.

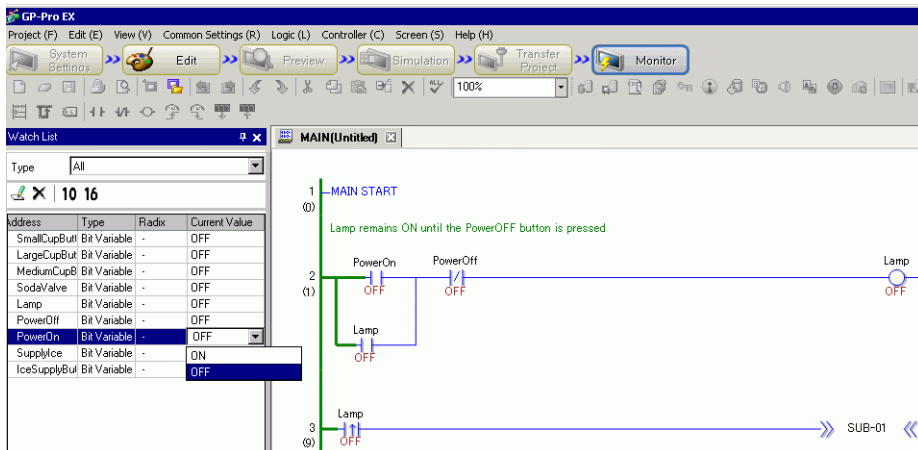

6 Monitor the current value of registered symbol variables in the [Watch List].

You can check how operations are affected when you change the current value of each address. To check operations when the [Type] is [Bit Variable], you can right-click to select [Force ON (C)] or [Force OFF (O)].

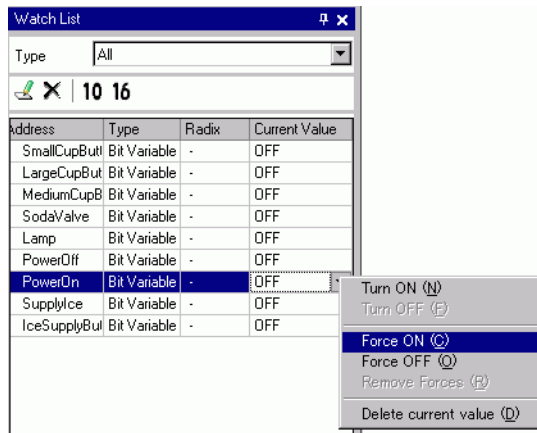

- NOTE**
- When the [Type] is [Bit Variable], an operational check can be performed by selecting [Force ON (C)] or [Force OFF (O)] from the [Controller] menu after selecting the operand in Monitor Step, or from the menu displayed by right-clicking the operand.
 - When the [Type] is [Integer Variable], [Float Variable] or [Real Variable], operational check can be performed by changing the current value by selecting [Current Value Editing] from the [Controller] menu after selecting the operand in Monitor Step, or from the menu displayed by right-clicking the operand.

7 End online monitoring. Click the [Edit] icon  on the State Toolbar. The [End Monitor] dialog box appears. Click [Yes (Y)] to return to the editor.

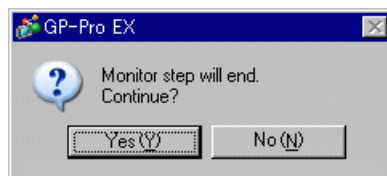

- NOTE**
- When you specify [Force ON (C)] or [Force OFF (O)], the symbol variable keeps its ON or OFF state until you remove forces.
 - You can add addresses to the [Watch List] window while in the Monitor Step. However, when you exit Monitor Step and return to the editor, the registered content will be discarded. If you do not want to discard the registered contents, select [Read Project] to read the project file from GP and return to the editor.

29.11.3 Adjusting the Setting Values for the PID Instruction

You can adjust the setting values for the PID instructions while monitoring the values in the [PID Monitor] window.

NOTE

- Please refer to the Settings Guide for details.
 ➔ "29.14.2 [Work Space] Settings Guide ■ PID Monitor" (page 29-162)

1 Run the online monitor.

NOTE

- ➔ "29.11.1 Online Monitoring Procedures" (page 29-79)

2 On the [View (V)] menu, point to [Work Space (W)] and then click [PID Monitor Window (M)]. The [PID monitor] window opens.

3 In [Target PID Variable], select the PID variable that you want to monitor. The PID instruction setting is displayed in a graph.

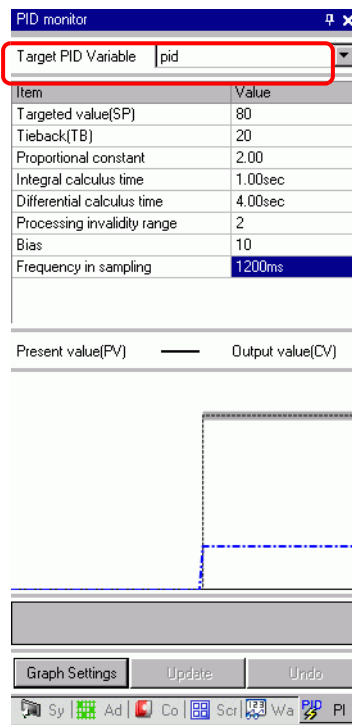

4 You can change the setting values while looking at the graph.

When the setting value is changed, the data is written to the following devices.

Items on the Screen	Save in	Remarks
Target PID Variable	None	Displays PID variables selected.
Targeted Value (SP)	Operand S1	Can be changed only when the instruction operand is a variable.
Tieback (TB)	Operand S3	Can be changed only when the instruction operand is a variable.
Proportional Constant	Variable Format ****.KP Address Format U_****.KP	Set value (x1000).
Integral Calculus Time	Variable Format ****.IT Address Format U_****.IT	Set value (x1000).
Differential Calculus Time	Variable Format ****.DT Address Format U_****.DT	Set value (x1000).
Processing Deadband Range	Variable Format ****.PA Address Format U_****.PA	
Bias	Variable Format ****.BA Address Format U_****.BA	
Frequency in Sampling	Variable Format ****.ST Address Format U_****.ST	

NOTE

- Click [Update] to update the graph.
- Click [Graph] to change the graph display's Upper Limit, Lower Limit, and display Width settings.

29.11.4 Editing monitored logic programs (Online Editing)

You can edit logic programs during online monitoring (Online Editing). You can edit the following.

- Insert/Delete Rungs
- Insert/Delete Branching
- Insert/Delete Instructions
- Edit Operands
- Insert/Delete Labels

NOTE

- Online Editing edits logic programs in the GP on a computer, so edited content is not reflected in the project files (*.prx) in the computer. After online editing, the following dialog box appears when the online monitor is closed. If you want to reflect the edited contents to the project file in the PC, click [Yes (Y)]. Otherwise, click [No (N)].

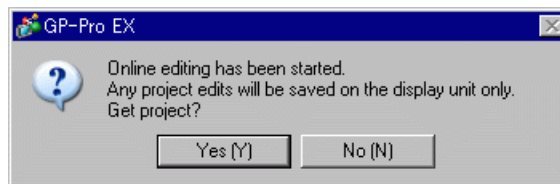

- With Online Editing, you cannot create a new variable. Allocate existing variables when adding instructions.
- After editing, an error check is performed in the logic program. If any errors are found, the transfer will not occur.

■ Editing Procedures

In Online Editing, you can edit only a single rung at a time. Click [Edit Rung (E)] in the [Logic (L)] menu to edit the selected rung. Click [OK (O)] to transfer the edited logic program to the GP.

Click [Cancel] to cancel editing and go back to the online monitor.

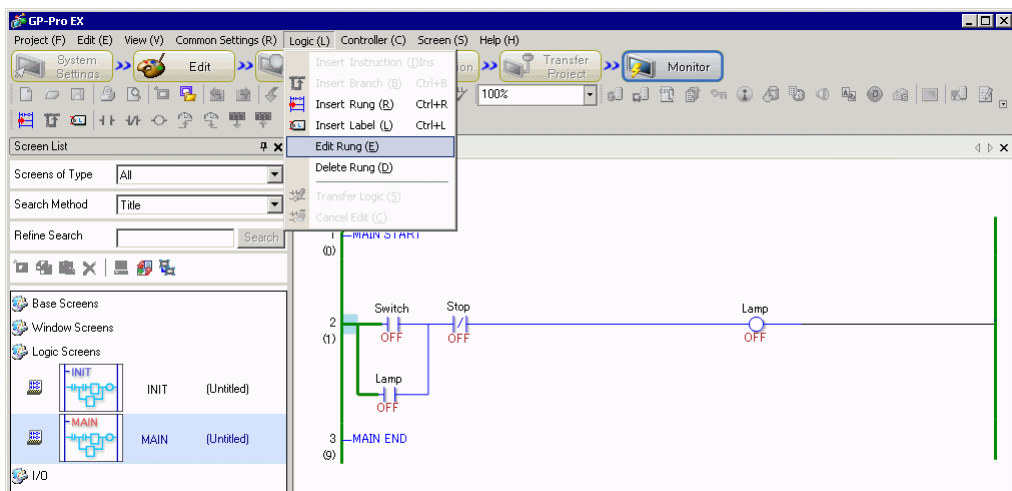

NOTE

- Each time an online editing is performed, 1 is added to the system variable (#L_EditCount) showing the number of edits. For details on system variables, see "A.6 System Variables" (page A-89).
- If a password has been set for online editing, the [Release Protection] dialog box is displayed before starting editing.
- To set the password, refer to "29.13.4 To enhance security" (page 29-128).

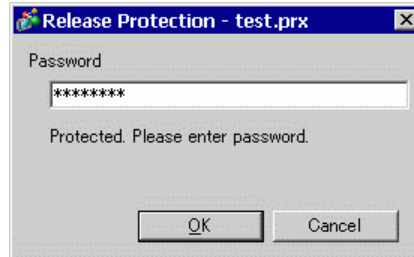

◆ Inserting/Deleting Rungs

A rung is inserted one down from the rung you selected. To insert, select a rung when the online monitor is on, and click [Insert Rung (R)] under the [Logic (L)] menu.

To delete a rung, select the rung to be deleted and click [Delete Rung (D)] on the [Logic (L)] menu.

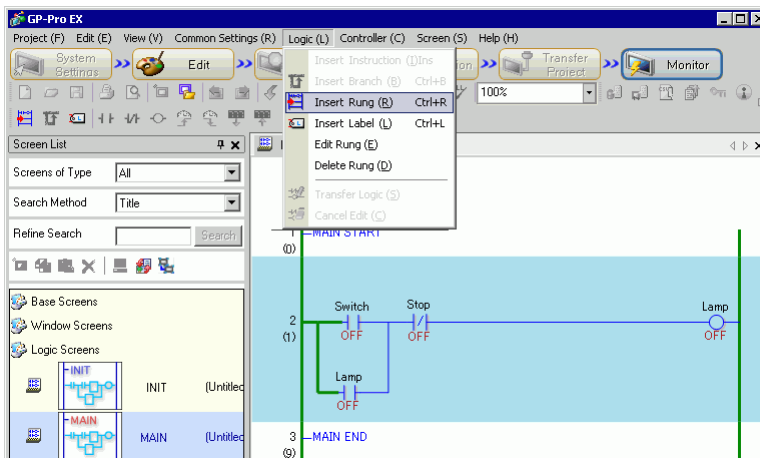
**NOTE**

- Upon deleting a rung, the [Transfer Logic] dialog box is displayed and the modified logic program will be transferred to the GP. You do not need to go to the [Logic (L)] menu and click [OK (O)].
- Alternatively, you can insert/delete rungs from the [Delete Rung (D)] on the [Logic (L)] menu or right-click the menu.

◆ Inserting/Deleting Branches

Select the point where you want to insert a branch and click [Insert Branch (B)] on the [Logic (L)] menu.

To delete, click [Delete Rung (D)] on the [Logic (L)] menu.

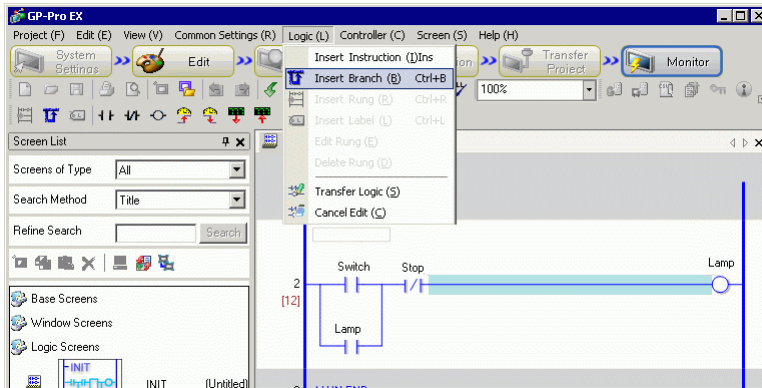

NOTE • Alternatively, you can insert/delete branches from the [Delete Rung (D)] on the [Logic (L)] menu or right-click the menu.

◆ Inserting/Deleting Instructions

Select the point where you want to insert an instruction and click [Insert Instruction (I)] on the [Logic (L)] menu.

To delete, click [Delete Rung (D)] on the [Logic (L)] menu.

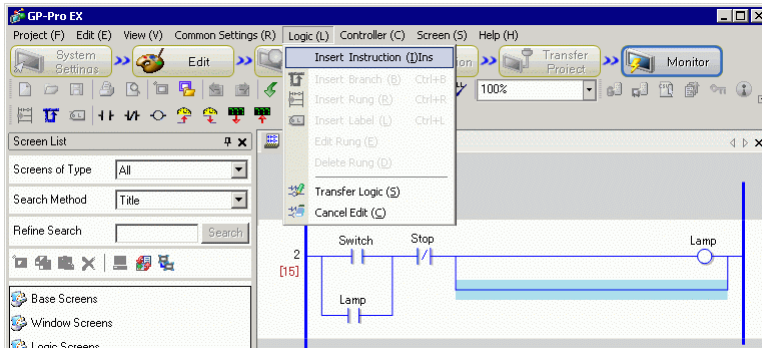

IMPORTANT • With Online Editing, you cannot create a new variable. Allocate existing variables when adding instructions.

NOTE • Alternatively, you can insert/delete instructions from the [Delete Rung (D)] on the [Logic (L)] menu or right-click the menu.

◆ Editing Operands

Select the operand to be edited, then select [Cut/Copy/Paste/Delete] on the [Delete Rung (D)] on the [Logic (L)] menu.

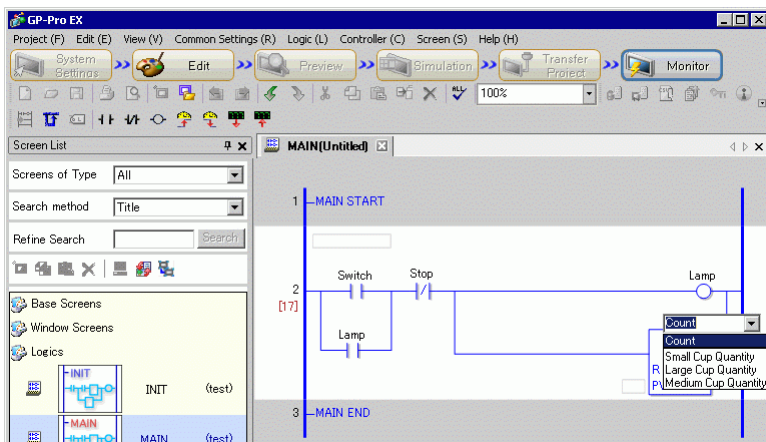

◆ Inserting/Deleting Labels

A label is inserted one down from the rung you select. To insert, select a rung when online monitor is on, and click [Insert Label (L)] on the [Logic (L)] menu. To delete, select the label to be deleted, then click [Delete Rung (D)] on the [Logic (L)] menu.

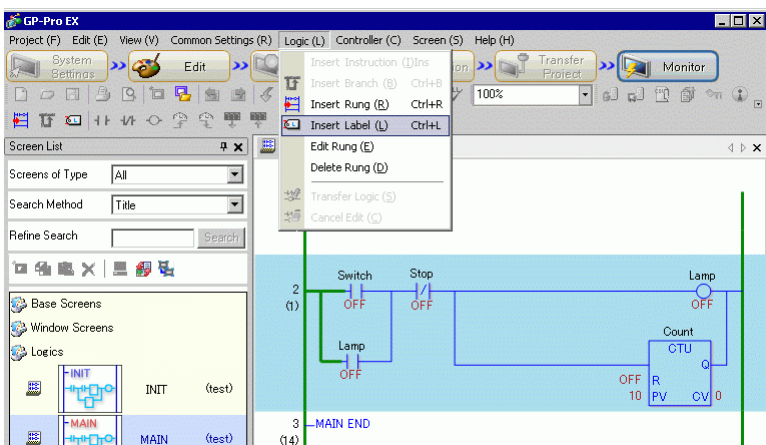

NOTE

- Upon deleting a label, the [Transfer Logic] dialog box is displayed and the modified logic program will be transferred to the GP. On the [Logic (L)] menu you do not need to confirm the editing.

29.12 Monitoring Logic Programs on the GP (Logic Monitor)

Logic monitoring is the function that displays the logic program on the GP screen. It allows you to check the operations of the logic program on the GP unit without using a personal computer.

The program is executed without stopping even during logic monitoring.

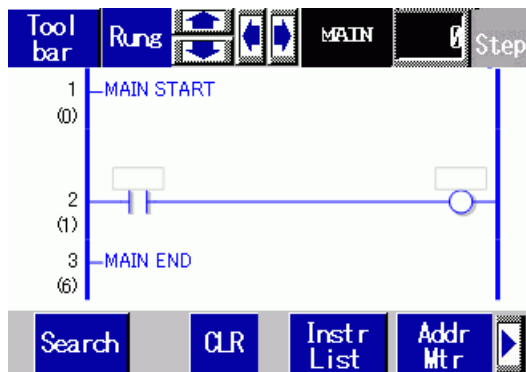

29.12.1 Starting and Ending the Logic Monitor

■ Trigger Method

There are 3 ways to start the logic monitor.

- **Start up with Parts**
Logic monitoring begins when you turn on the first bit of the #L system variable (#L_LogicMonitor) using a switch part.
Turn off the first bit to display the screen before logic monitoring begins. Specify #L_LogicMonitor.X[1] for the address. The #L_LogicMonitor.X[0] is for monitoring addresses. The address monitoring screen appears when the system variable specification bit is turned on, such as during logic monitoring.
- **Start up with the Logic Program**
Using an instruction, turn on bits 0 (Address Monitor) and 1 (Logic Monitor) of #LSystem Variable (#L_LogicMonitor).
- **Start up with the System Menu**
On the system menu, touch [Logic Monitor] and [Address Monitor].

NOTE

- You cannot start up multiple monitors at the same time. When bits 0 and 1 are turned on at the same time, the address monitor for bit 0 is triggered. And bit 1, which turned ON at the same time, turns OFF.
- Once the monitors have started up, it is easy to switch monitors. Bit 0 or bit 1 of the system variable (#L_LogicMonitor) will not turn on/off when switching monitors.
- You can start up the logic monitor when the logic functions are not being used. The address monitor is started up when you start up the logic monitor.
- You cannot start the logic monitor on AGP-3302B or AGP-3301. The address monitor is started up when you start up the logic monitor.

■ End Method

There are four ways to end the logic monitor as follows.

- **End with Parts**
Using D-Script, turn off bits 0 and 1 of the #L system variable (#L_LogicMonitor).
(Use parts for converting data Instruction addresses such as D-Scripts.)
Since the logic monitor does not allow editing by the user, you cannot use the switch part.
- **Logic**
Use the instruction to turn off bits 0 and 1 of the system variable #L (#L_LogicMonitor).
- **Screen Change**
When the screens change, the started-up monitor ends.
- **Monitor Screen**
Touch [End] in each of the logic monitoring and address monitoring screens.

NOTE

- If not changing the screens, click [Back to Previous] to end.
 - Please note that if there is no screen to go back to, such as when you start up the logic monitor when the initial screen was not on, you will not be able to end the logic monitor.
 - When the logic monitor and address monitor end, #L_LogicMonitor is Zero-cleared.
-

29.12.2 Logic Monitor Functions

The following explains the logic monitor features.

■ Logic monitor



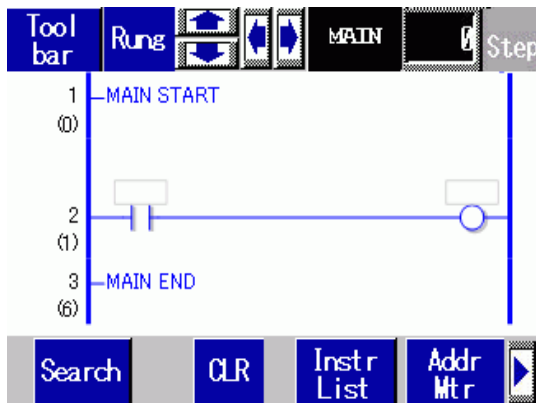

Monitors the entire logic. The logic monitor allows you to check the operational status and instruction layouts.

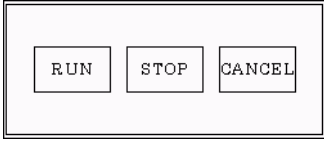

The logic monitor has the following features.

Feature	Details	
Scroll		Scroll the logic using [Rung] or [Column]. Rung: Scroll the logic using rungs. Column: Scroll the instructions one by one without the logic. For landscape, you can use only the [Column] scroll.
Zoom		Touch the displayed instruction to zoom the monitor display. ☞ " ■ Zoom Monitor" (page 29-94)
Logic Name Display		Display the logic names being monitored. The names to be displayed are [INIT], [MAIN], [ERRH], and [SUB-01]-[SUB-32].
Step		Display the top step number being monitored. When any change is made, the operation jumps to the rung with the specified step number.
Toolbar		Switch the toolbar show/hide at the bottom of the screen. Page 1
		Page 2
		Click or to switch Page 1 with Page 2.
Exit		End the monitor.

Continued







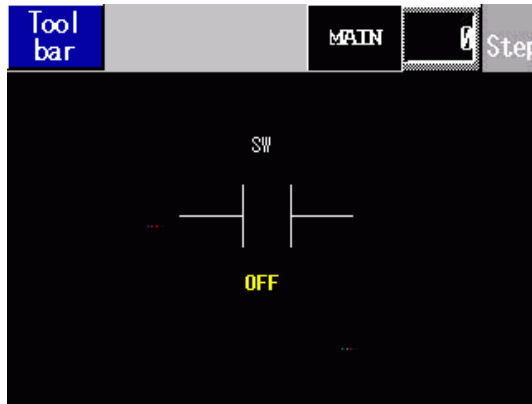



Feature		Details
Toolbar	RUN/STOP 	Switch the logic between RUN and STOP. Click to display the screen below. Use the buttons to run and stop the logic. 
	Address Monitor 	Switch to the address monitor. ☞ " ■ Address Monitor" (page 29-95)
	Ladder Instructions 	Switch to the instruction list. ☞ " ■ Ladder Instructions" (page 29-97)
	Search 	Search the variables and instructions specified in the instruction list. ☞ " ■ Search" (page 29-98)

■ Zoom Monitor

Zoom and monitor an instruction. The zoomed in monitor allows you to check the operational status and the instruction operand.

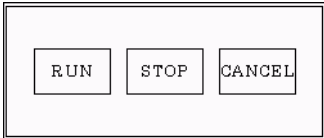

The Zoom Monitor has the following features.

Feature		Details
Toolbar		Switch the toolbar show/hide at the bottom of the screen. Page 1   Page 2  Click  or  to switch Page 1 with Page 2.
Exit		End the monitor.
RUN/STOP		Switch the logic between RUN and STOP. Click to display the screen below. Touch [RUN] to run or [STOP] to stop the logic. 
Logic		Switch to the logic monitor. ☞ " ■ Logic monitor" (page 29-92)
DEC/HEX		Switch the display of the current operand value between decimal/hexadecimal.

■ Address Monitor

Monitor the address used in the logic. You can check the variable name and the current value. In the address format, the logic address is monitored.

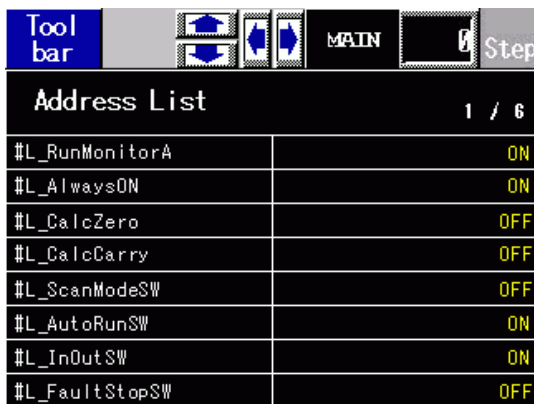

The address monitor has the following features.







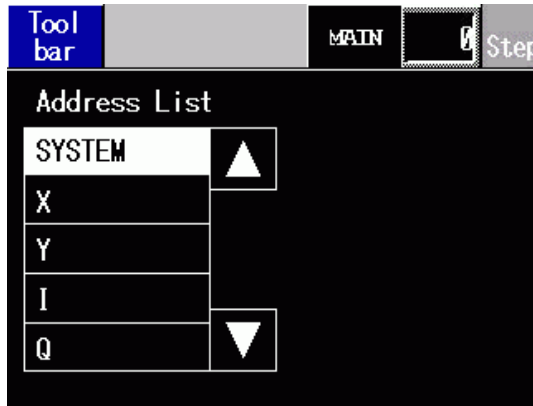

Feature		Details
Scroll		Scroll the list. Up/Down: Scroll per page. Right/Left: Jump to the top/last page.
Toolbar		Switch the toolbar show/hide at the bottom of the screen. Page 1 Page 2 Click or to switch Page 1 with Page 2.
Exit		End the monitor.
RUN/STOP		Switch the logic between RUN and STOP. Click to display the screen below. Touch [RUN] to run or [STOP] to stop the logic.
DEC/HEX		Switch the display of the current operand value between decimal/hexadecimal.
Address Search		Switch to the address search. " ■ Address Search" (page 29-96)

■ **Address Search**

Select the Address Type to display in the address monitor. You can check the values stored in each address. You can use it only in address format.



The address search has the following features.







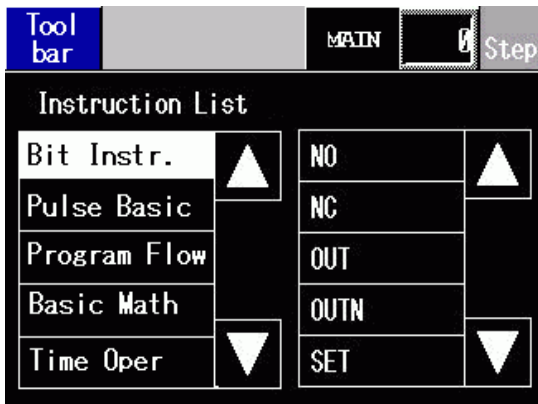

Feature	Details
Toolbar 	Switch the toolbar show/hide at the bottom of the screen. Page 1   Page 2  Click  or  to switch Page 1 with Page 2.
Exit 	End the monitor.
Logic 	Switch to the logic monitor. ☞ " ■ Logic monitor" (page 29-92)

■ **Ladder Instructions**

Provides a list of instructions. Select the category to display all the lists and then select the relevant list.



The instruction list has the following features.

Feature	Details
Toolbar 	Switch the toolbar show/hide at the bottom of the screen. Page 1   Page 2  Click  or  to switch Page 1 with Page 2.
Exit 	End the monitor.
Logic 	Switch to the logic monitor.  " ■ Logic monitor" (page 29-92)

■ **Search**

In the address monitor and instruction list, select a variable to use as the search key. The search is conducted in the logic monitor.

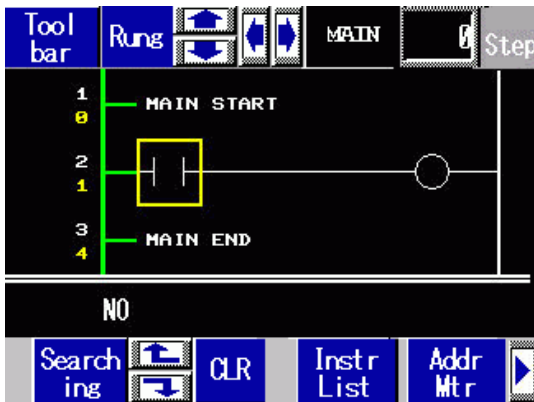

The search has the following features.

Feature	Description
Variable Search	Use only variables as the search key. Select only the key variable in the address monitor.
Instruction Search	Use only instructions as the search key. Select only the key instruction in the instruction list.
Variable & Instruction Search	Use a variable and instruction as the search keys. Select the key variable in the address monitor and the key instruction in the instruction list.
Next Search	Based on the first search result, search a variable and instruction with the next closest match.
Clear Search	Clear the variable and instruction selected as the search keys.

NOTE

- You can perform a search only while search is selected. The search is terminated if you scroll the screen.
- You can use the up/down search in the next search.

■ **Password**

For logic with a password, you can monitor the logic after inputting the password.

29.13 Convenient features to create/edit logic

29.13.1 Replacing Parts in Instructions and Instructions in Parts

Drag the parts and instructions between the drawing screen and logic screen to allocate symbol variables, insert new instructions, and place new parts. This allows you to create screens and logic programs more efficiently.

Here, for example, a logic screen (for example, MAIN) and a drawing screen (for example, Base 1) are open in the editing area tile vertically.

NOTE



- To display two screens vertically, on the [View (V)] menu, point to [Editing Area (B)], and then click [Tile Vertically], or click .
- You can start up multiple instances of GP-Pro EX and drag the parts and instructions between projects from one logic screen to another, or from one drawing screen to another. Dragging and dropping from a logic screen to a drawing screen or from a drawing screen to a logic screen is not allowed.

IMPORTANT

- If you drag and drop from another project, the allocated symbol variables may overlap. When you drag and drop different types of symbol variables, if the address you have set is for drawing parts, they will be undefined. Please note that in logic program, the type will be changed to match the target project. We suggest you make sure the symbol variable names do not overlap when you drag and drop.
 - ☞ "29.10 Logic Program Error Correction" (page 29-77)
 - ☞ "29.9 Transferring Logic Programs" (page 29-75)
- You cannot drag and drop between projects created in different versions.

■ Assigning Symbol Variables to Instructions from Parts

You can allocate the symbol variables allocated to parts on the drawing screen to the instruction operands in the Logic.

- 1 Click the part on the drawing screen. Drag it to the instruction operand to which you want the part allocated. Release the mouse where the pointer changes from  to .

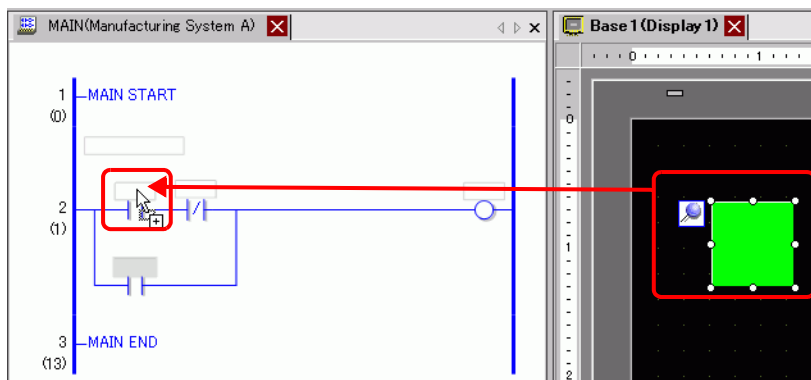

2 Select the symbol variable.

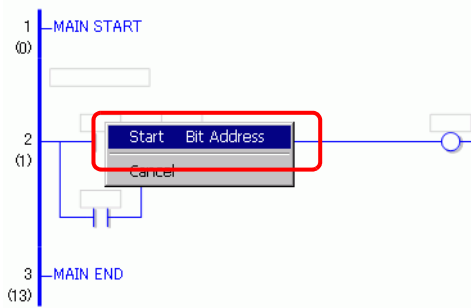

NOTE

- Symbol variables that can be allocated differ depending on parts.
- ☞ "◆ Drag and Drop Parts" (page 29-111)
- When more than one symbol variable is allocated to a part, the possible symbol variables are displayed.
- Click [Cancel] to cancel the symbol variable allocation.
- Where the pointer is displayed with , you cannot assign symbol variables.

3 The symbol variable allocated to the part is allocated to the instruction operand.

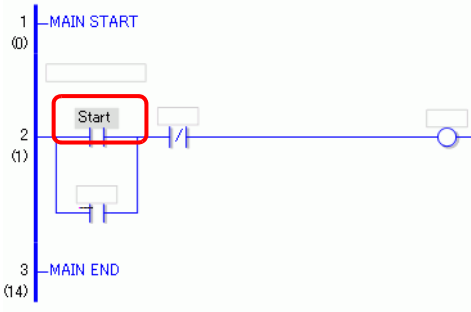



NOTE

- You can allocate symbol variables in the [Address] window.
- ☞ "■ Operand Settings Using Drag and Drop" (page 29-60)

■ Assigning Symbol Variables to Parts from Instructions

You can allocate symbol variables allocated to the instruction operand in the Logic to parts on the drawing screen.

- 1 Click the instruction operand in the Logic. Drag it to the part on the drawing screen to which you want the part allocated. When the feature list is displayed, point to the feature to which you want allocated. Where  changes to , release the left mouse button.

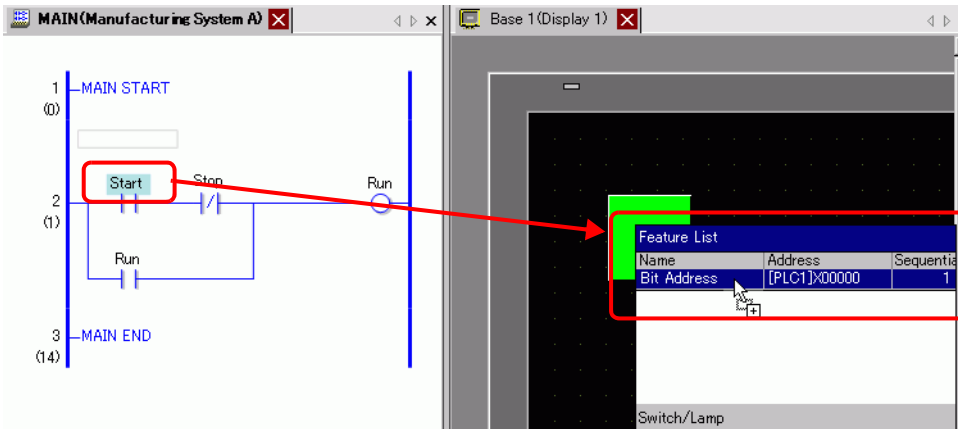

NOTE

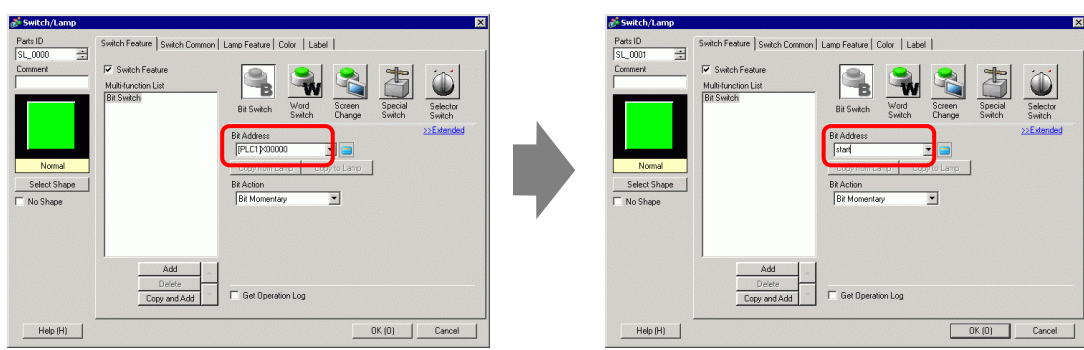

- Symbol variables you can be allocated differ depending on instructions.
- "◆ Instructions that use Drag and Drop" (page 29-105)
- When more than one feature is allocated to a part, the possible features are displayed.
- If you release the left button on the mouse before the rung is reverse-displayed, the symbol variable allocation is canceled.
- Where the pointer is displayed with , you cannot assign symbol variables.

- 2 The symbol variable allocated to the instruction operand is allocated to the part.



■ Inserting New Instructions from Parts

You can insert instructions by dragging the parts to the rungs or shunts of the logic program.

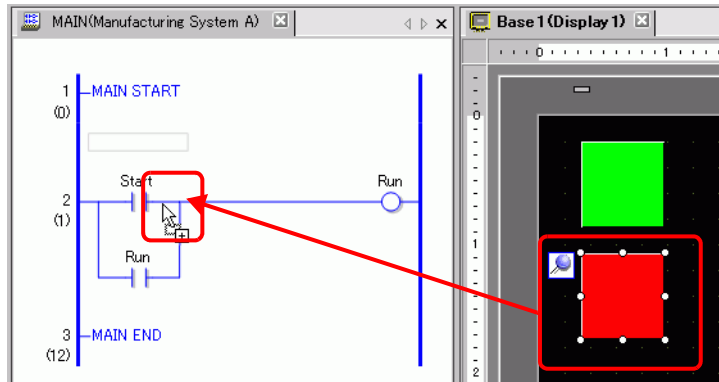

- 1 Click the part on the drawing screen. Drag it to where you want to insert the instruction in the Logic. Release the mouse where the pointer changes from  to .

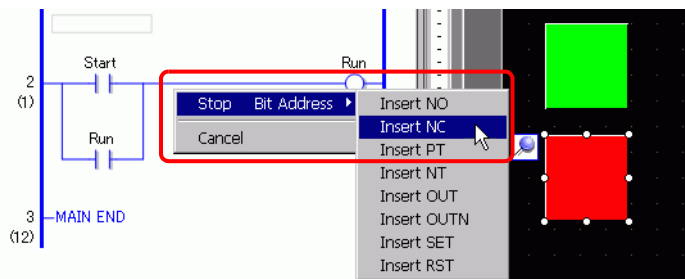

- 2 Select the symbol variable and then select the instruction that you want to insert.



NOTE

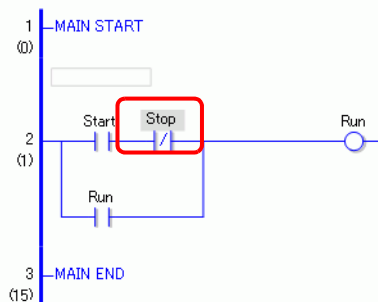

- Instructions that can be inserted differ depending on the parts.
-  "◆ Drag and Drop Parts" (page 29-111)
- When more than one symbol variable is allocated to a part, the possible symbol variables are displayed.
- Click [Cancel] to cancel the symbol variable allocation.
- Where the pointer is displayed with , you cannot insert instructions.

- 3 The instruction to which the symbol variable of the part is allocated is inserted.



■ Placing New Parts from Instructions

You can allocate symbol variables allocated to the instruction operand in the Logic to parts on the drawing screen.

- 1 Click the instruction in the Logic. Drag the instruction to where you want to place it on the drawing screen. Where  changes to , release the left mouse button.

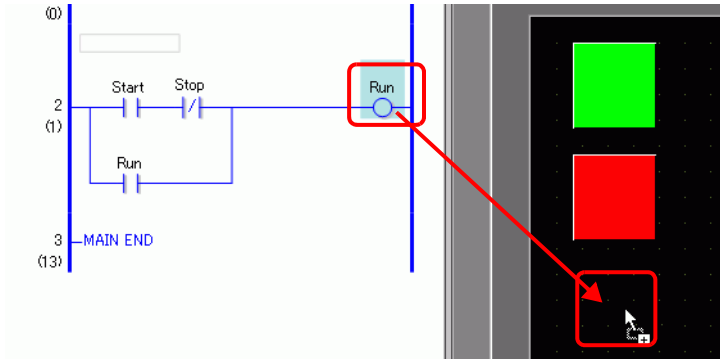

- 2 Select the operand and then select the part that you want to place.

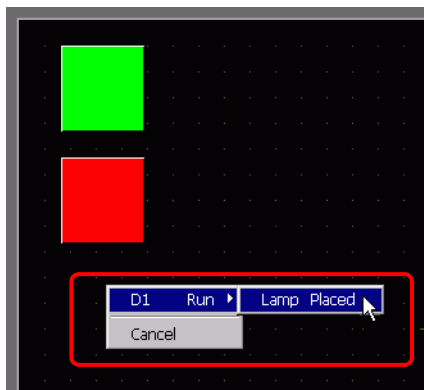

NOTE

- Parts that can be placed differ depending on the instruction.
- "◆ Instructions that use Drag and Drop" (page 29-105)
- When more than one part can be placed, the possible parts will be displayed.
- If you drag an instruction that cannot be placed, the action will be canceled.
- Click [Cancel] to cancel the part placement.
- Where the pointer is displayed with , you cannot place parts.
- When structure variables are allocated to ladder instructions, all integer variables and bit variables are displayed.

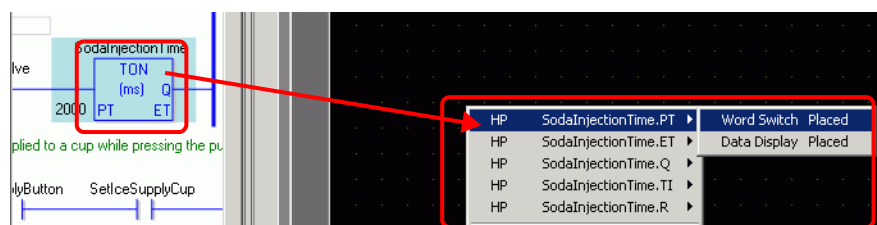

- 3 The part is placed with the symbol variable of the instruction. Change the size and Color as necessary.

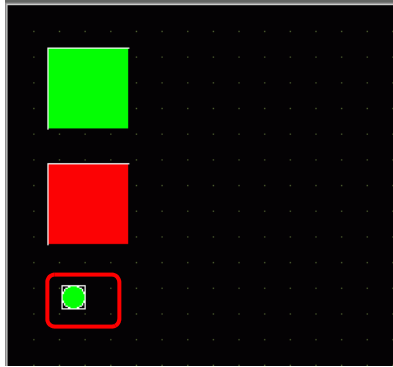

NOTE

- If [Copy Symbol Variable to Label] in the [Option Settings] dialog box is checked, the symbol variable name is registered for the label of the part and displayed.
Change the setting of labels as needed.



 " ■ Logic Common" (page 5-193)

■ Drag and Drop Ladder Instructions and Parts

◆ Instructions that use Drag and Drop

You can drag the following parts from the instructions or operands in the Logic and drop on the drawing screen to allocate or reallocate the symbol variables.

IMPORTANT

- Do not place real-type variables or instructions that have real variables as parts in operands. It will not display properly.

Drag & Drop Instructions and Operands				Parts that can be allocated or parts to which a new symbol variable can be placed	
Instructions	Number of Operands		Symbol Variable Type		
Basic Instructions	NO, NC, PT, NT	1	S1	Bit Address	• Bit Switch
				Bit Variable	
	OUT, OUTN, SET, RST, PTO, NTO	1	D1	Bit Address	• Lamp
				Bit Variable	
	JMP, JSR	1			
	RET, EXIT				
	FOR	1	S1	Word Address	• Data Display
				Integer Variable	
	NEXT				
PBC	2	S1			
		D1	Bit Variable	• Lamp	
PBR	1	S1			
Operation Instructions	ADD, SUB, MUL, DIV	3	S1	Word Address	• Word Switch • Data Display (You cannot select the Word switch for float variables and real variables)
				Integer Variable	
				Float Variable	
				Real Variable	
			S2	Word Address	
				Integer Variable	
				Float Variable	
				Real Variable	
			D1	Word Address	
				Integer Variable	
				Float Variable	
				Real Variable	

Continued

Drag & Drop Instructions and Operands				Parts that can be allocated or parts to which a new symbol variable can be placed	
Instructions	Number of Operands		Symbol Variable Type		
Operation Instructions	MOD	3	S1	Word Address	<ul style="list-style-type: none"> • Word Switch • Data Display
				Integer Variable	
			S2	Word Address	
				Integer Variable	
			D1	Word Address	
				Integer Variable	
	JADD, JSUB	3	S1	Time Variable (.HR	[Variable: Integer Variable]
			S2	Time Variable (.HR	<ul style="list-style-type: none"> • Word Switch • Data Display
			D1	Time Variable (.HR	
	AND, OR, XOR	3	S1	Word Address	<ul style="list-style-type: none"> • Word Switch • Data Display
				Integer Variable	
			S2	Word Address	
				Integer Variable	
			D1	Word Address	
				Integer Variable	
	NOT	2	S1	Word Address	
				Integer Variable	
			D1	Word Address	
Integer Variable					
MOV	2	S1	Word Address	<ul style="list-style-type: none"> • Word Switch • Data Display 	
			Integer Variable		
		D1	Word Address		
			Integer Variable		
BLMV	3	S1	Bit Address (Array)	<ul style="list-style-type: none"> • Word Switch • Data Display (You cannot select S1 or D1.)	
			Integer Variable (Array)		
			Float Variable (Array)		
			Real Variable (Array)		
		S2	Integer Variable		
			D1		Bit Address (Array)
		Integer Variable (Array)			
		Float Variable (Array)			
		Real Variable (Array)			

Continued

Drag & Drop Instructions and Operands					Parts that can be allocated or parts to which a new symbol variable can be placed
Instructions	Number of Operands	Symbol Variable Type			
Operation Instructions	FLMV	3	S1	Word Address	<ul style="list-style-type: none"> • Word Switch • Data Display (You cannot select D1.)
				Integer Variable	
				Float Variable	
				Real Variable	
		S2	Integer Variable		
			D1	Integer Variable (Array)	
	Float Variable (Array)				
	Real Variable (Array)				
	XCH	2	D1	Word Address	<ul style="list-style-type: none"> • Word Switch • Data Display
				Integer Variable	
D2			Word Address		
			Integer Variable		
ROL, ROR, RCL, RCR, SHL, SHR, SAL, SAR	3	S1	Word Address	<ul style="list-style-type: none"> • Word Switch • Data Display 	
			Integer Variable		
		S2	Word Address		
			Integer Variable		
		D1	Word Address		
			Integer Variable		
Compare Instructions	EQ, GT, GE, LT, LE, NE	2	S1	Word Address	<ul style="list-style-type: none"> • Word Switch • Data Display (You cannot select the Word switch for float variables and real variables.)
				Integer Variable	
				Float Variable	
				Real Variable	
		S2	Word Address		
			Integer Variable		
	JEQ, JGT, JGE, JLT, JLE, JNE	2	S1	Time Variable (.HR .MIN .SEC)	[Variable: Integer Variable]
			S2	Time Variable (.HR .MIN .SEC)	<ul style="list-style-type: none"> • Word Switch • Data Display
	NEQ, NGT, NGE, NLT, NLE, NNE	2	S1	Date Variable (.YR .MO .DAY)	[Variable: Integer Variable]
			S2	Date Variable (.YR .MO .DAY)	<ul style="list-style-type: none"> • Word Switch • Data Display

Continued

Drag & Drop Instructions and Operands				Parts that can be allocated or parts to which a new symbol variable can be placed	
Instructions	Number of Operands		Symbol Variable Type		
Timer Instructions	TON, TOF, TP, TONA, TOFA	1	Variable	Timer Variable (.ET .PT)	[Variable: Integer Variable] • Word Switch • Data Display
				Timer Variable (.Q .TI .R)	[Variable: Bit Variable] • Bit Switch • Lamp
Counter Instructions	CTU, CTD, CTUD	1	Variable	Counter Variable (.PV .CV)	[Variable: Integer Variable] • Word Switch • Data Display
				Counter Variable (.Q .QD .QU .UP .R)	[Variable: Bit Variable] • Bit Switch • Lamp
Convert Instructions	BCD, BINENCO, DECO	2	S1	Word Address	• Word Switch • Data Display
				Integer Variable	
			D1	Word Address	
				Integer Variable	
	RAD, DEG, SCL	2	S1	Word Address	• Word Switch • Data Display (You cannot select the Word switch for float variables and real variables.)
				Integer Variable	
				Float Variable	
			D1	Real Variable	
Word Address					
Integer Variable					
I2F, I2R, F2I, F2R, R2I, R2F, H2S, S2H	2	S1	Type		
			D1	Type	

Continued

Drag & Drop Instructions and Operands				Parts that can be allocated or parts to which a new symbol variable can be placed	
Instructions	Number of Operands		Symbol Variable Type		
Function Instruction	SUM, AVE	3	S1	Integer Variable (Array)	<ul style="list-style-type: none"> • Word Switch • Data Display (You cannot select S1.)
				Float Variable (Array)	
				Real Variable (Array)	
			S2	Integer Variable	
				D1	
			Float Variable		
	Real Variable				
	SQRT	2	S1	Float Variable	<ul style="list-style-type: none"> • Data Display
				Real Variable	
			D1	Float Variable	
				Real Variable	
	BCNT	2	S1	Integer Variable (Array)	
Float Variable (Array)					
Real Variable (Array)					
D1			Integer Variable (Array)		
			Float Variable (Array)		
			Real Variable (Array)		
PID	5	Variable	PID Variable (.KP .TR .TD .PA .BA .ST)	[Variable: Integer Variable] <ul style="list-style-type: none"> • Word Switch • Data Display 	
			PID Variable (.Q .UO .TO .PF .IF)	[Variable: Bit Variable] <ul style="list-style-type: none"> • Bit Switch • Lamp 	
		S1	Word Address	<ul style="list-style-type: none"> • Word Switch • Data Display 	
			Integer Variable		
		S2	Word Address		
			Integer Variable		
		S3	Word Address		
			Integer Variable		
		D1	Word Address		
			Integer Variable		

Continued

Drag & Drop Instructions and Operands					Parts that can be allocated or parts to which a new symbol variable can be placed
Instructions		Number of Operands		Symbol Variable Type	
Function Instruction	SIN, COS, TAN, ASIN, ACOS, ATAN, COT, EXP, LN, LG10	2	S1	Float Variable	• Data Display
				Real Variable	
			D1	Float Variable	
				Real Variable	
R/W Instruction	JRD, JSET	1	D1	Time Variable (.HR .MIN .SEC)	[Variable: Integer Variable] • Word Switch • Data Display
	NRD, NSET	1	D1	Date Variable (.YR .MO .DAY)	[Variable: Integer Variable] • Word Switch • Data Display

◆ **Drag and Drop Parts**

The following are operands for which you can allocate symbol variables or instructions that you can insert, by dragging and dropping parts from the drawing screen to the logic screen.

Drag & Drop Parts			Operands that can be assigned symbol variables and instructions you can insert	
Parts		Symbol Variable Type	Instructions	Operand
Switch/Lamp	Bit Switch	Bit Address	NO, NC, PT, NT, OUT, OUTN, SET, RST, PTO, NTO	
		Bit Variable		
	Word Switch	Word Address	MOV, ADD, SUB, MUL, DIV, EQ, GT, GE, LT, LE, NE	They are allocated to S1 of the instruction.
		Integer Variable		
	Screen Change			
	Special Switch			
	Selector Switch			
Lamp	Bit Address	NO, NC, PT, NT, OUT, OUTN, SET, RST, PTO, NTO		
	Bit Variable			
Data Display	Data Display (Input Permit)	Word Address	MOV, ADD, SUB, MUL, DIV, EQ, GT, GE, LT, LE, NE	They are allocated to S1 of the instruction.
		Integer Variable		
		Float Variable		
	Text Display	Word Address	-	
		Integer Variable	-	
	Date/Time Display			
	Statistical Data Display			
Show Limit Value				

29.13.2 Checking the Size for Creating Programs

By checking the current logic capacity, symbol variable capacity, address points, comments memory of logic programs, you can prevent errors such as exceeded capacity. You can change the proportion of the logic capacity and comment memory depending on the use.

NOTE

- The logic capacity is calculated as the sum of the logic and the comments in the logic. Variable capacity is the sum of the variable and the symbol variable comments.

■ Checking Memory Usage

- 1 Select the [Project Information (I)] from [Properties (I)] of [Project (F)] menu.
The [Project Information] dialog box will be displayed.
- 2 Click [Logic Memory] and then click the [Logic] tab to check [Logic Capacity (Steps)], [Variable Capacity], [Number of Addresses Used in Logic] and [Comment Memory].

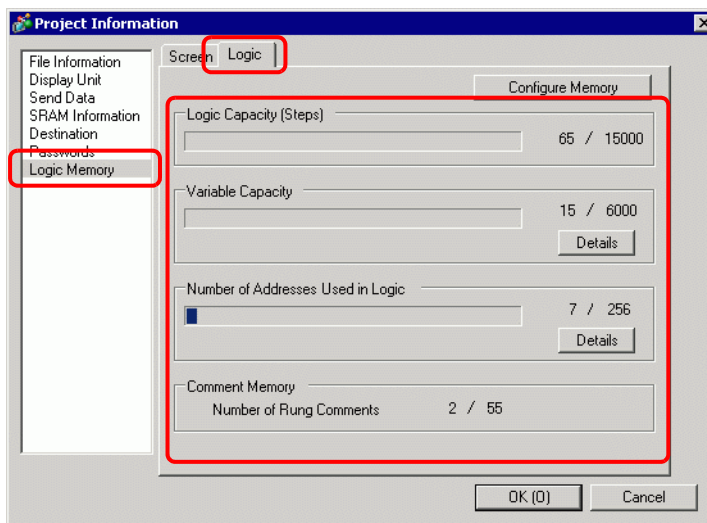

- From [Variable Capacity], click [Details] to check the current number, assignable number, and the current sum for each symbol variable.

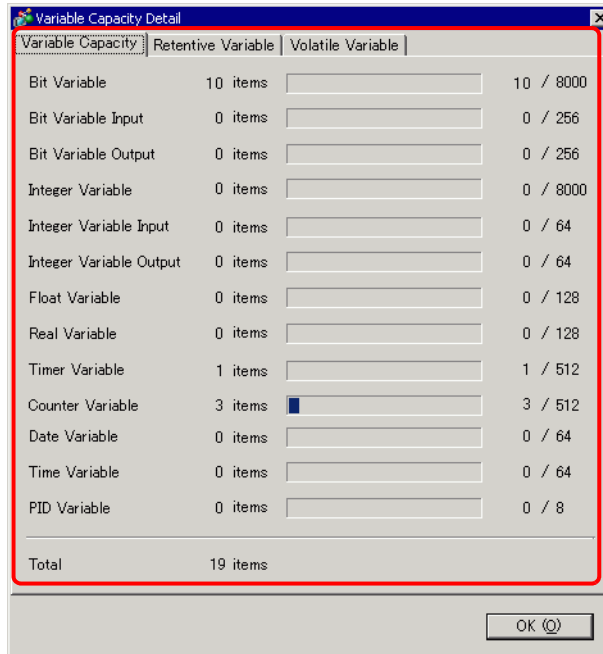

NOTE

- You can choose to display [Retentive Variable]/[Volatile Variable] by clicking the tab.

- Click the [Addresses used in Logic] details to check the current number, the configurable number of [Bit], [Integer] and [System Variable] and the total number.

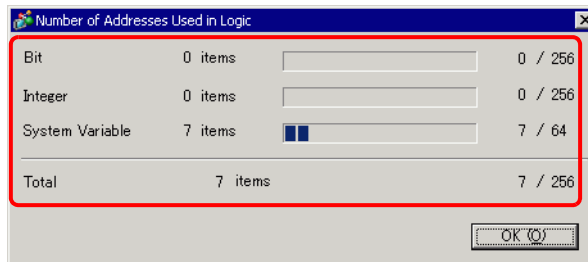

NOTE

- The [Number of Addresses Used in Logic] is the number of external addresses of [PLC1]****and internal addresses of [USER]. Please note that the number of addresses that can be used in a logic program is limited.

■ Configure Memory

You can specify the upper capacity limit for the symbol variable comments and rung comments.

IMPORTANT

- The size of logic program that you can create is determined based on the comment memory that you specified. When creating a logic program with many steps involved, reduce the comment blocks. When creating a logic program with many comments, increase the comment blocks. You cannot create comments exceeding the comment memory settings or steps exceeding the number determined by the comment memory.

- 1 In the [Project Information] dialog box, click [Configure Memory]. The [Configure Memory] dialog box appears.
- 2 Sets the upper limit for the symbol variable comment memory, ranging from 0 to 15. If you select [Expand Logic Program Area], the upper limit of the number of steps is changed from 15000 to 60000. (The upper limit of the screen data will be decreased by 1MB.)

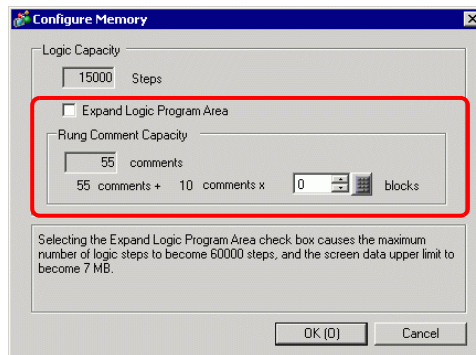

■ Symbol Variable Number Restriction

When using device addresses in logic programs, the following number restrictions will apply.

Name	Memory Size	Maximum Number for Registration	Registration Number Restrictions on the GP-Pro EX
Bit Address (Bit Variable)	64 bytes	512	256
Word Address (Integer Variable)	1024 bytes	256	256
System Variable	256 bytes	64	64
Total Number Available	1000	256	

NOTE

- Check the number restriction for the device addresses on the GP-Pro EX.

■ Logic Program and GP Memory Limits

Items	Number Restriction on the GP-Pro EX	GP Memory Restriction
Number of Programs	INIT 1 MAIN 1 SUB 32 Total 34 60K Steps	96 KB
Number of Program Rungs	5000 Rungs	
Number of Instructions per Rung	150	
Number of Label Characters	Fixed Name	None
Number of Labels per Project	99	
Number of Devices	28000 Devices	64 KB
Number of NT/PT Instructions	Unlimited (depends on the number of programs)	None
Number of Constants	Unlimited (depends on the number of programs)	None
Number of Compulsory Changes	Unlimited (depends on the number of programs)	None
Array Size	4096	None

Continued

Items	Number Restriction on the GP-Pro EX	GP Memory Restriction
Number of Variables	9000 Symbol Variables 6000 Variables	1 MB
Variable Name	32 characters	
Number of Symbol Variable Comments	210 (Default value)	16 KB 14 KB
Number of Characters for Symbol Variable Comments	32 characters	
Number of Rung Comments	55 comments (initial value)	16 KB 14 KB
Characters in Rung Comments	128 characters	
Number of Program Comments	34	8 KB
Characters in Program Comments	32 characters	
Number of Nests	50	Stack: 16 (32)

29.13.3 Adjusting Logic Scan Time

The following provides an overview of logic functions and the scan time when the logic program is run. The steps to set the scan time are also provided.

■ Logic Features

◆ Summary

The logic features operate as follows. The details are explained on the next page.

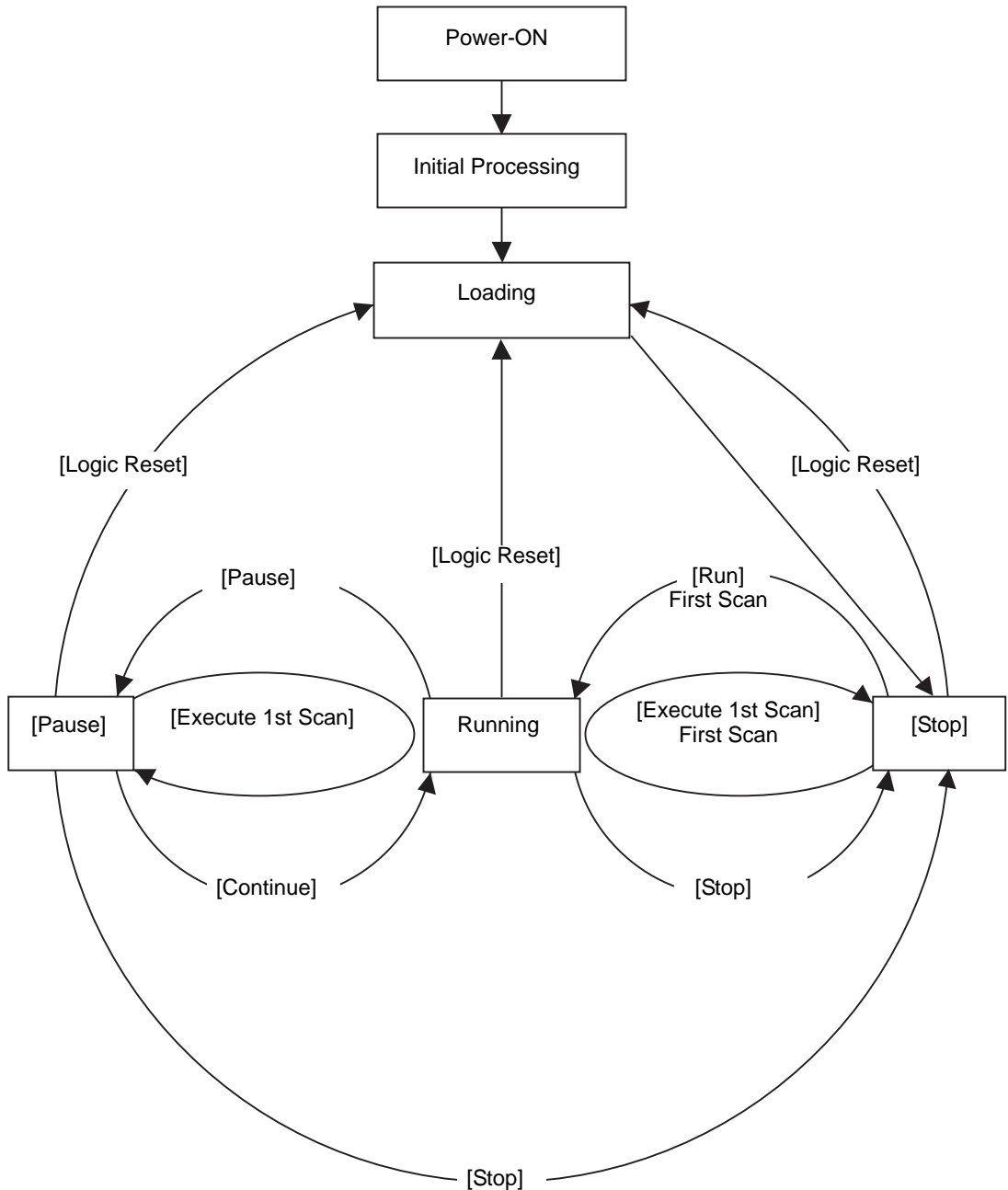

- **Initial Processing**

This is the initial state of the logic program execution engine. After the logic program execution engine has been initialized, the logic state changes to "loading."
- **Loading**

The logic program is read from the memory. It checks whether the logic program has been loaded normally and remedies the error if not loaded normally. Once the program has been loaded normally, it will stop.

If [Run] is selected for the Power-ON action, the run command will be executed. When changing to the "running" state, the I/O is initialized.
- **Stop**

The logic is in the paused state. Upon receiving a command ([Logic Reset], [Run], [Execute 1st Scan], [Continue], or [Pause]), the state will change accordingly.

The [Logic Reset] command starts "loading". Symbol variables are initialized. When it is a retentive variable and the power is off or the GP logic is reset, the most recent data is maintained. However, if the logic is reset with the online monitor (mode that runs a program in the logic on the GP-Pro EX) or #L_Command, the variable is initialized with the initial value for logic features in GP-Pro EX.

The [Run] command or [Execute 1st Scan] command zero-clears the clear-type variable. The [Run] command starts "running". The [Execute 1st Scan] command runs the logic program once.
- **First Scan**

Reads I/O, runs the initialized logic program, and then writes the I/O.
- **Running**

The logic program execution engine is running. The engine reads the I/O, runs the logic program, writes the I/O, and updates the system variables (#L_AvgLogicTime, #L_AvgScanTime, and so on).

The [Logic Reset] command starts "loading".

The [Stop] command stops the logic.

The [Pause] command pauses the logic.
- **Pause**

The logic program execution engine is paused. To prevent the I/O watchdog time-out, I/O write/read is executed. However, since the logic program has not run, the output state remains unchanged. Upon receiving a command, the state will change accordingly.

The [Logic Reset] command starts "loading".

The [Execute 1st Scan] command runs the logic program once.

The [Stop] command stops the logic. The [Continue] command starts "running".

◆ **Run Mode**

The scan runs as follows.

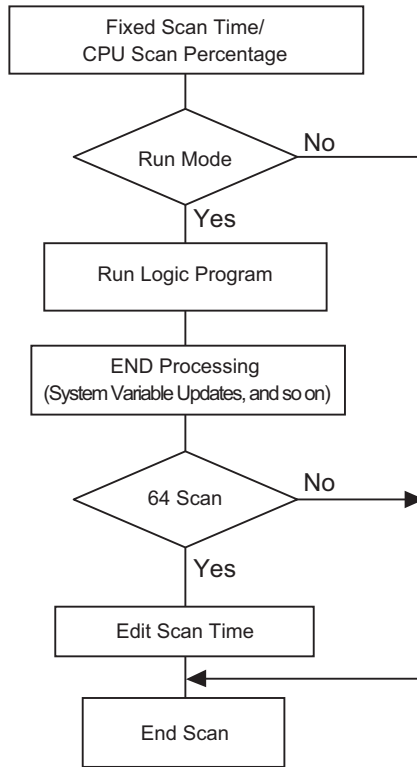

- **Scan Time Adjustment**
The scan time is adjusted every 64 scans. The scan times for the fixed scan time mode and CPU scan percentage mode are as follows.
- **Fixed Scan Time Mode**
Scan Time = $(\#L_AvgLogicTime * 100) / 50$ (Models that can use logic GP-33** Series: Models except 30:
- **CPU Scan Percentage Mode**
Scan Time = $(\#L_AvgLogicTime * 100) / \#L_PercentScan$

NOTE

- For the details of #L_AvgLogicTime, #L_PercentScan, refer to the following.
☞ "A.6 System Variables" (page A-89)

- **Scan Time Error**
The following error is found in the logic scan time.

Model	Error
GP3000 Series	10%

* Communicating via Ethernet or MPI may affect the scan time. For more information, see "29.15 Restrictions" (page 29-170).

■ Logic Scan Time

The logic time includes the logic features and display and the display features (screen display, touch panel processing, communication). The logic feature runs the logic programs. Both features are as follows. The GP scan time has a fixed scan time mode and a CPU scan percentage mode.

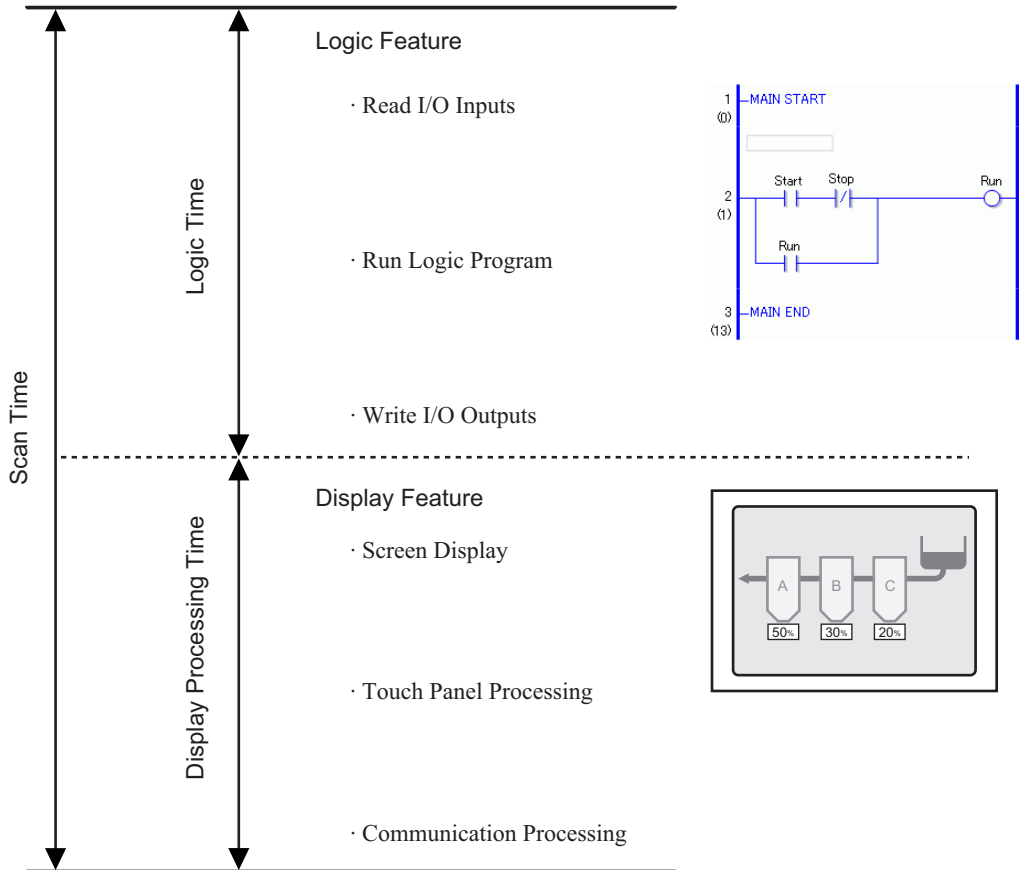

NOTE

- Updating the device/PLC addresses depends on Address Refresh, and is not affected by the fixed scan time or CPU scan percentage. For details on address refresh, refer to " ■ Address Refresh" (page 29-125).

☞ " ◆ Fixed Scan" (page 29-121)

☞ " ◆ CPU Percentage Scan" (page 29-123)

◆ **Fixed Scan**

This mode maintains the specified scan time.

It allows you to process a logic program in a certain cycle. It is suitable for programs that prioritize control (logic programs) and for which the screen is mainly used for monitoring (data display) with few operations required.

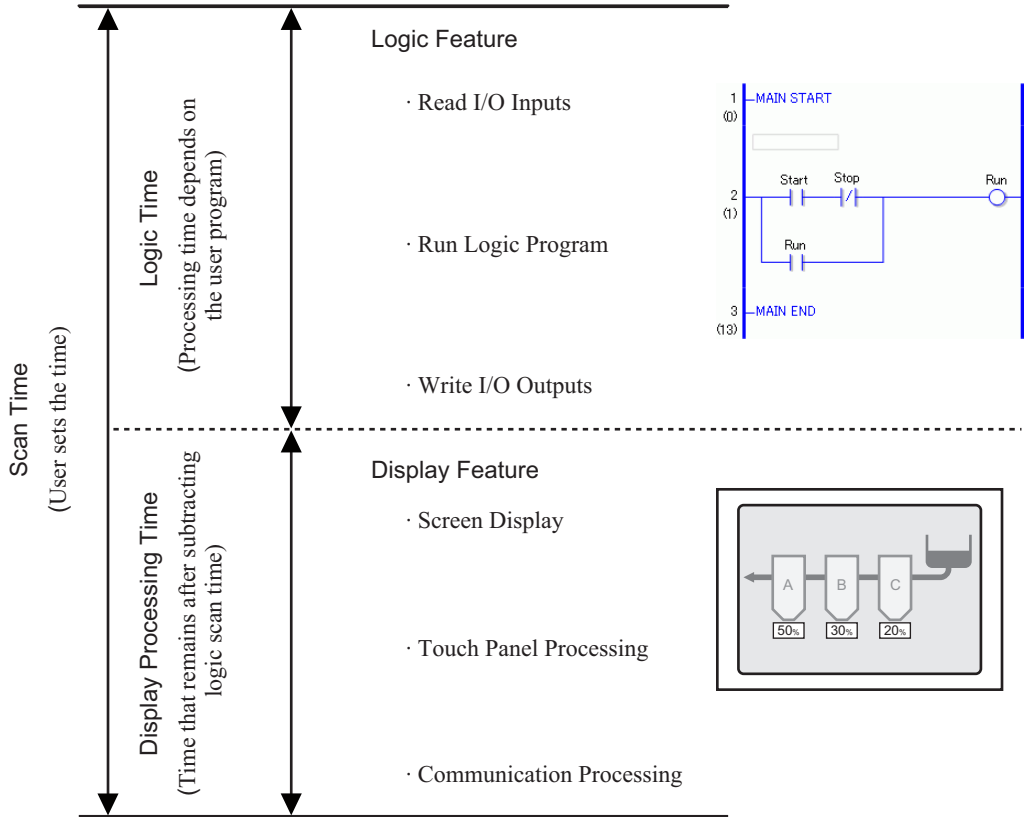

Display Processing Time = Setting Value for Fixed Scan Time (ms) - Logic Time

For example, if 50 ms is specified for the fixed scan time, and the logic executing time is 20 ms: Display Processing Time = 50 ms – 20 ms = 30 ms

As the logic time becomes longer, the processing time becomes shorter. For this reason, the display update speed on the GP becomes slower; however, the logic program runs continuously.

IMPORTANT

- The minimum scan time setting is 10 ms.
- For the scan setting, input 10 ms or larger by 1 ms increments.
- When the logic time and the constant scan time values are set up with constant values, the scan time is automatically adjusted to twice the logic time.

Model	Scan Time Automatically Adjusted	Scan Time Automatically Adjusted Example
GP-3200 Series GP-3300 Series LT3000 Series	Logic time exceeds 50% of the defined constant scan	<ul style="list-style-type: none"> • Constant scan (defined value): 50 ms • Logic time: 30 ms Scan time is adjusted to 60 ms.
GP-3400 Series GP-3500 Series GP-3600 Series GP-3700 Series	Logic time exceeds 30% of the defined constant scan	<ul style="list-style-type: none"> • Constant scan (defined value): 50 ms • Logic time: 20 ms Scan time is adjusted to 40 ms.

NOTE

- Adjust the setting time based on the #L_AvgScanTime value after testing the operation on the GP.
 "A.6 System Variables" (page A-89)

◆ CPU Percentage Scan

This mode specifies the logic time occupancy (%) during scan time and changes the scan time for operation.

The mode prevents pressure on the display processing time caused by increased logic time, and it is suitable for systems that prioritize speed in screen operations and screen switching.

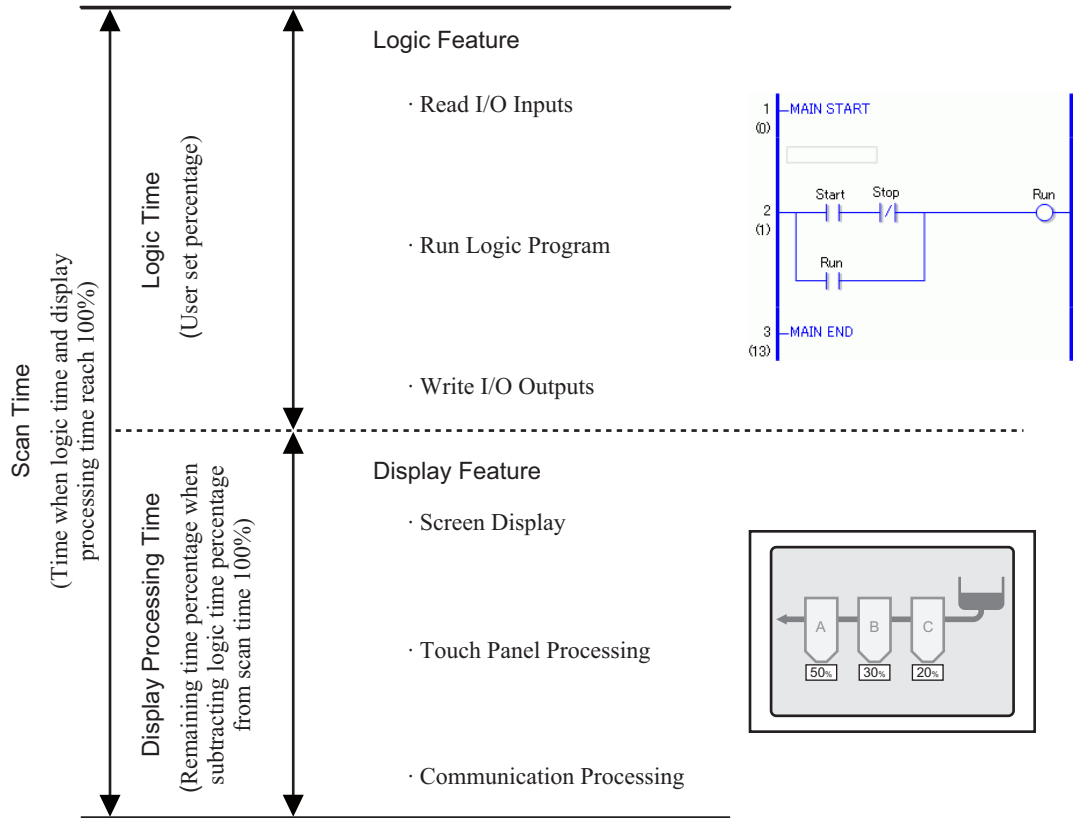

Scan Time = Logic Time Setting Value for the CPU Scan Percentage (%)

For example, if 40% is specified for the CPU scan percentage and the logic executing time is 20 ms:

$$\text{Scan Time} = (20 / 40) * 100 = 50 \text{ ms}$$

$$\text{Display Processing Time} = 50 \text{ ms} - 20 \text{ ms} = 30 \text{ ms}$$

As the logic time becomes longer, the display processing time and the scan time become longer. For this reason, as the logic time becomes longer, the time allocated for the display processing becomes longer. This results in improved display update speed on the GP while slowing down the processing cycle of the logic programs.

IMPORTANT

- Specify the scan time value for the CPU scan percentage by 1 ms increments.
- The processing time per instruction in the logic program remains unchanged.
- You cannot specify a CPU scan percentage larger than 50%.
- If 50% is specified for the CPU scan percentage, the display processing time and logic program processing time will be the same length. The display processing will not be prioritized.

◆ Setup Procedure

NOTE

- Please refer to the Settings Guide for details.
☞ "5.17.6 [System Settings] Setting Guide ◆ Logic" (page 5-173)

1 In the [System Settings], click [Display Unit].



NOTE

- If the [System Settings] tab is not displayed in the workspace, on the [View (V)] menu, point to [Workspace (W)], and then click [System Settings (S)].

2 Click the [Logic] tab. In [System Settings], select [Fixed Scan Time] or [CPU Scan Percentage] and enter a value for the setting.

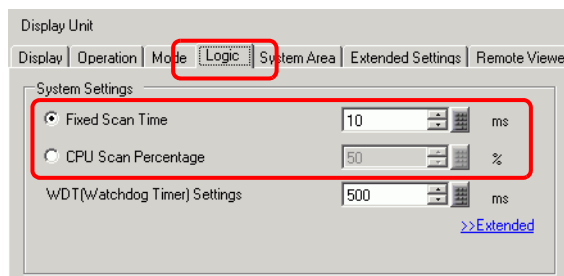

■ Address Refresh

◆ Summary

When device addresses are used in logic programs, pseudo addresses (logic addresses) of the logic features are allocated. The device addresses are updated periodically and logic programs are run through these allocated pseudo addresses.

Address Refresh is the method of updating the data between device addresses and pseudo addresses.

You can specify the update interval depending on the user system.

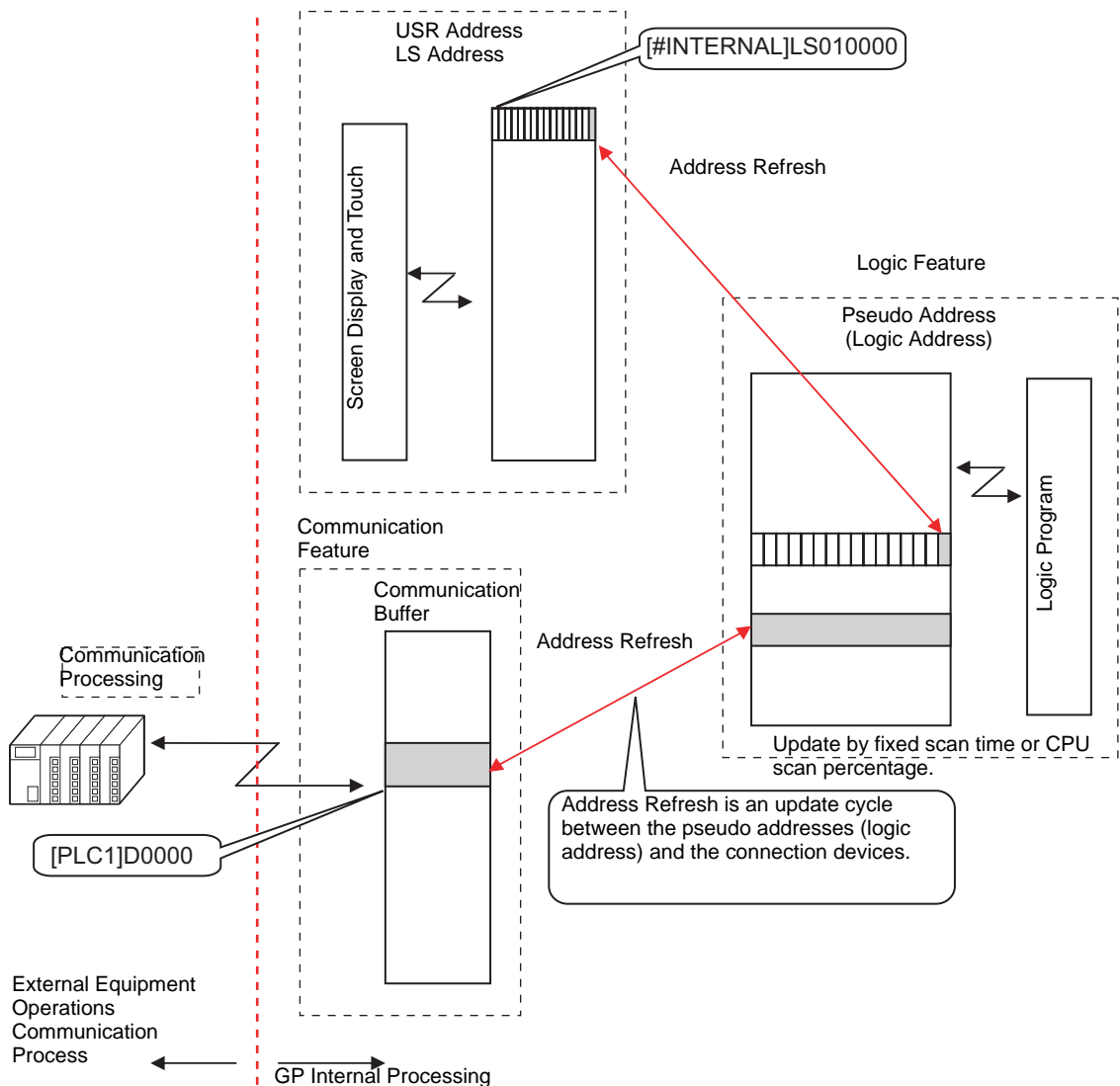

◆ **Setup Procedure**

You can choose the address refresh update from fast, medium or slow.

IMPORTANT

- Update interval is not a fixed value as it is affected by the user system. The actual update interval is stored in (#L_AddressRefreshTime). Adjust the system variable to select fast, medium or slow for the update interval.
- The update speed of the screen may be affected because the address refresh update interval is shorter.

NOTE

- Please refer to the Settings Guide for details.
 ☞ "5.17.6 [System Settings] Setting Guide ◆ Logic" (page 5-173)

1 In the [System Settings], click [Display].



NOTE

- If the [System Settings] tab is not displayed in the workspace, on the [View (V)] menu, point to [Workspace (W)], and then click [System Settings (S)].

2 Click the [Logic] tab and in [System Settings], click [>>Extended].

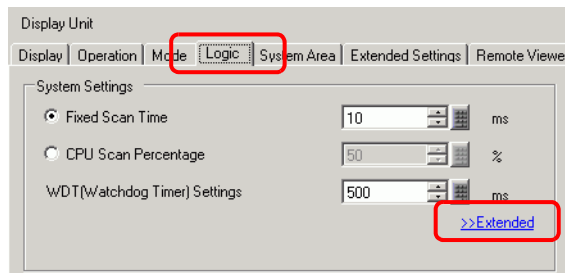

3 In [Address Refresh], select the speed.

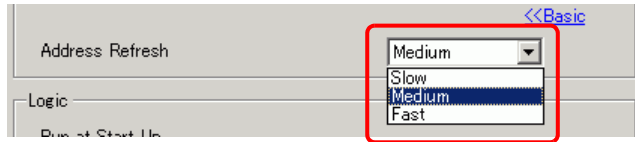

29.13.4 To enhance security

You can enhance security so that only users with password privileges can use this when monitoring logic programs.

■ Setup Procedure

- 1 From the [Common Settings (R)] menu, point to [Security (Q)] and select [Security Password (P)] or click  on the toolbar.

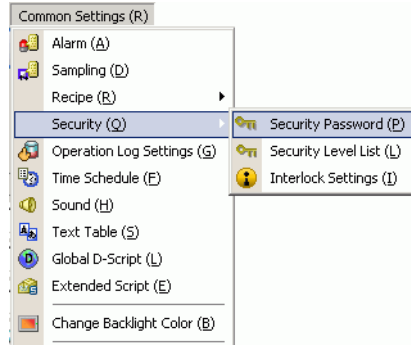

- 2 The password setting screen will open. Select the [Enable Security Function] check box, and type the password at the level of use.

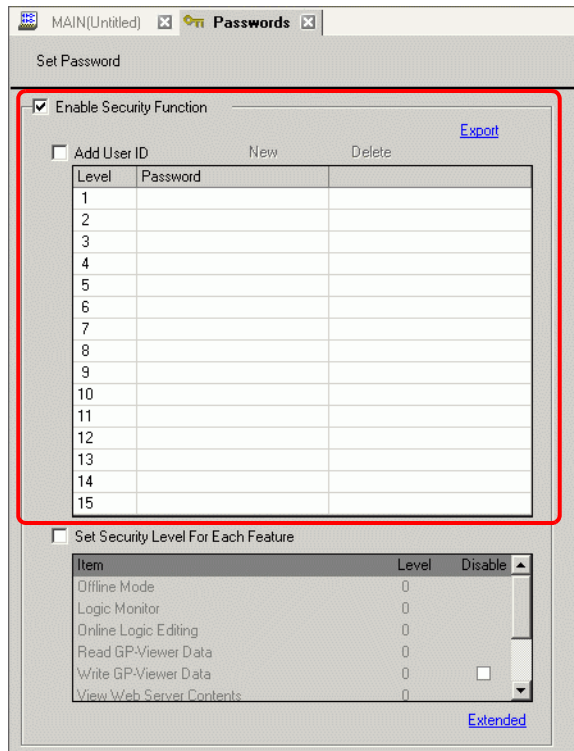

NOTE

- Set a password up to eight single-byte characters long.
- Select the [Add User ID] check box to add the User ID to the Password. As with the password, User IDs can be up to eight single-byte characters long.

3 Select [Set up Functions at Each Security Level] and set the level of [Online Logic Editing].

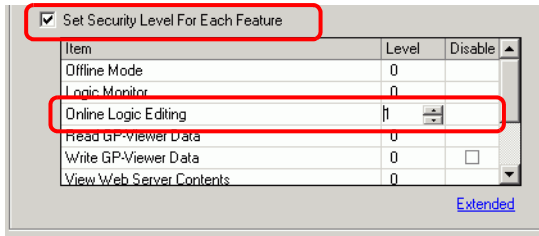

NOTE

- The security level of Online Logic Monitor always needs to be equal to or greater than that of the Logic Monitor. To set security for both of these, be sure to set the level of Online Logic Monitor first.

4 Set the level of the [Logic Monitor].

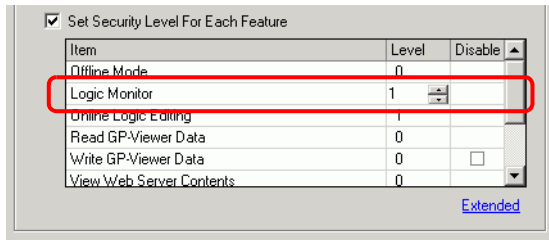

NOTE

- You can configure advanced security feature settings. Please refer to the Settings Guide for details.
☞ "22.10.1 Common (Security Settings) Settings Guide" (page 22-40)

29.13.5 Using Reference Features to Search Logic Programs

In [Properties], you can search for rungs and instructions in logic programs and display the details in [Properties] by selecting rungs and instructions in logic programs. You can edit symbol variables in [Properties].

NOTE

- Please refer to the Settings Guide for details.
 ☞ "5.17.5 [Work Space] Settings Guide ■ Screen List" (page 5-133)

■ [Properties] Display

- 1 In [Logic], open the logic screen you want to display.
- 2 Select [View (V)], [Work Space (W)], and click [Properties (P)].
 The total numbers of rungs and steps are displayed.

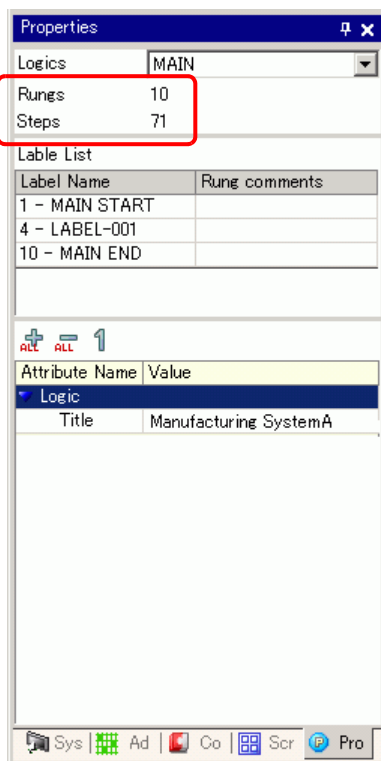

NOTE

- In [Logic], you can select the logic program.

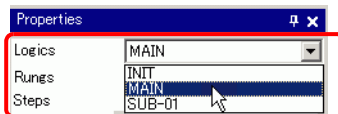

■ Properties Search

- In [Label List], all the logic program labels are displayed. Select a label to move the cursor to the selected logic program label.

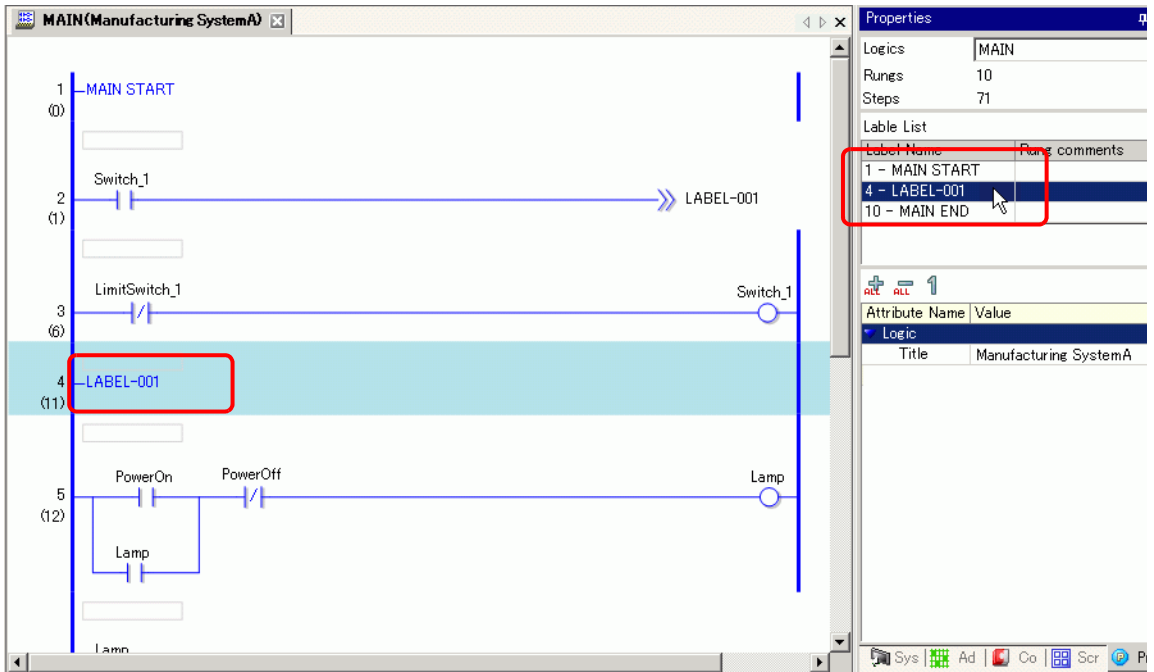

- Click [Rung Number] and enter a number to move the cursor to that rung.

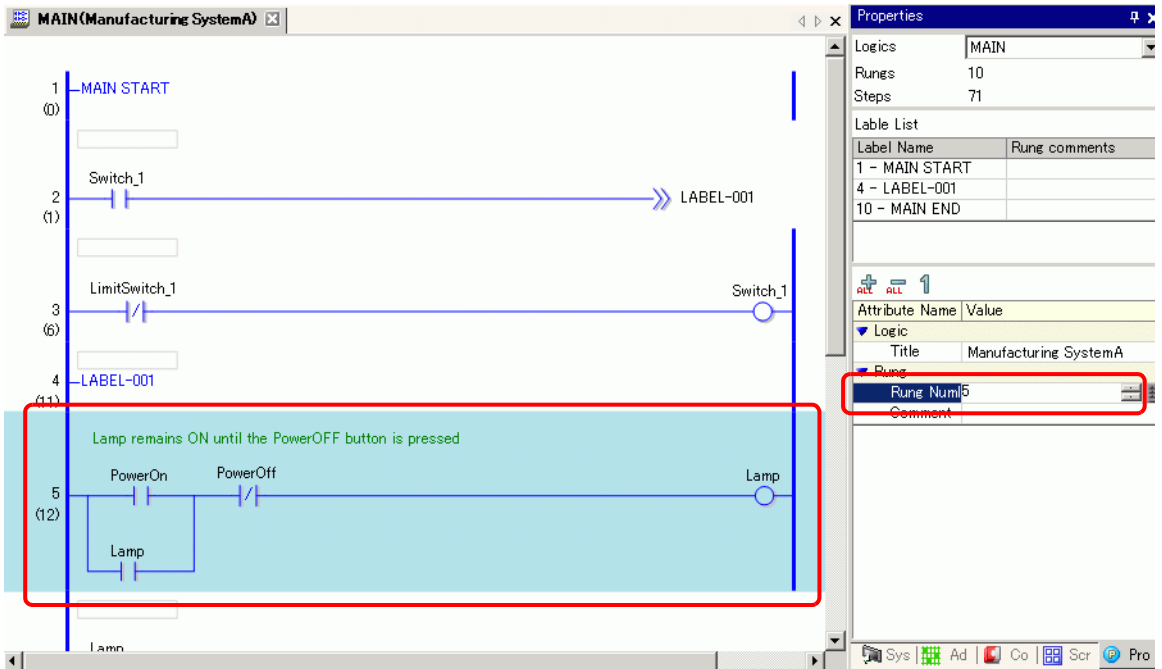

■ Display and Edit the Logic Program Information in Program Windows

- Select a rung in the logic program to display [Rung Number] and [Comment] for the selected rung.

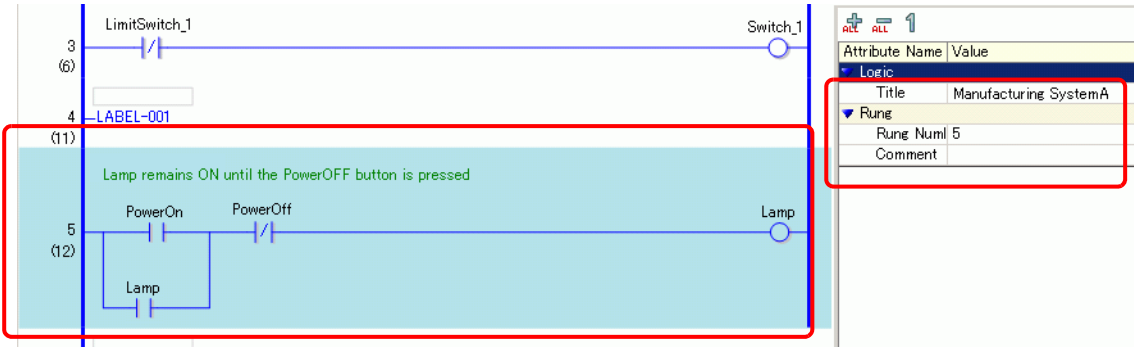

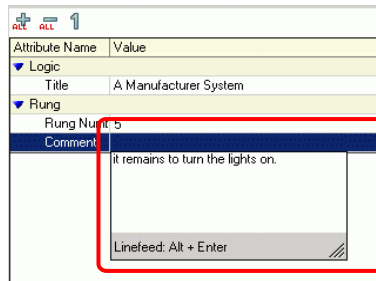

- You can directly edit the comment by clicking [Comment].

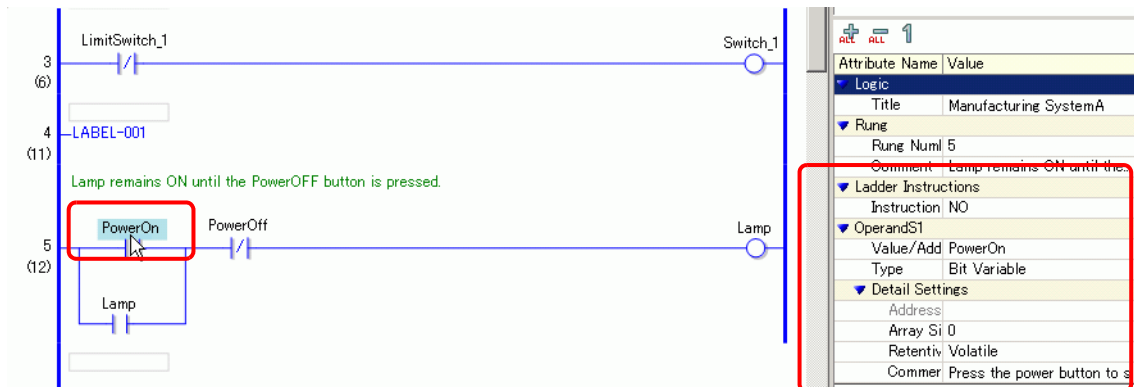

- Select an instruction or operand in the logic program to display [Instruction Name], [Value and Address], [Type], and the detailed settings. Click any of these to edit the settings.



NOTE

- If the detailed settings are not displayed, click  (or  located to the left of [Detail Settings]) to display [Address], [Array Size], [Retentive], and [Comment]. The settings that you can edit differ depending on [Type].

Method to Search Rung and Variable Comments

NOTE

- For how to display the Comment List, refer to the following.
 ☞ "29.7.4 [Comment List] Window" (page 29-69)

- When [Target Item] is [Rung], double-click a cell in the [Screen: Rung/Address] column to select the rung in the logic with the comment you want to delete.

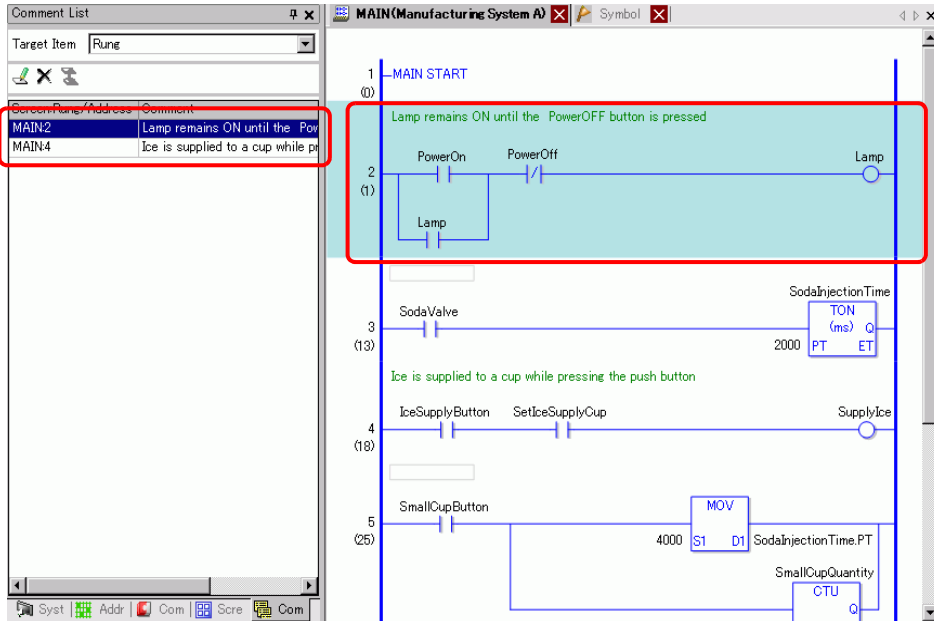

- When [Target Item] is [Variable] or [System Variable], double-click the cell in the [Screen: Rung/Address] column. This displays the [Address] window and selects the relevant symbol variable or system variable.

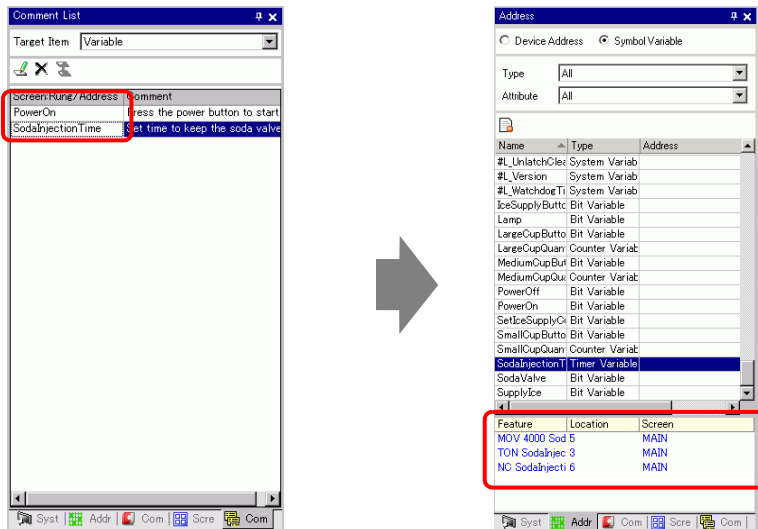

Select the lower part of the [Address] window to select the target variable on the logic screen.

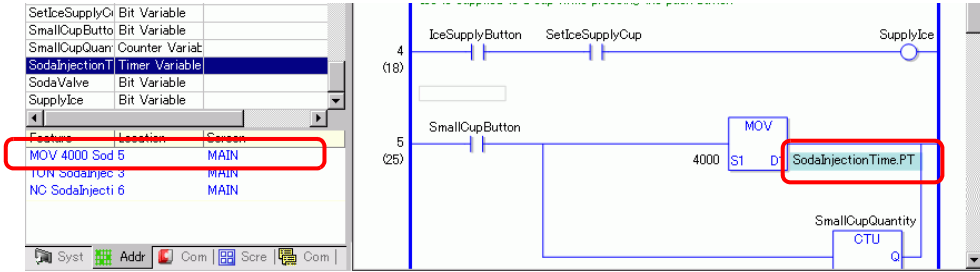

29.13.6 Using Previously Created Logic Programs

You can register a previously created part of a logic program or a subroutine program as a logic part. You can call the logic program part from another project file as well as from the logic program that you are currently editing.

Registering frequently used logic programs saves you from creating the same program over and over and reduces your workload.

Furthermore, you can export and import registered logic parts to use the same logic parts in GP-Pro EX on other computers.

NOTE

- Logic parts are saved in the specified folder. Consequently, only computers on which logic parts have been registered can load the logic parts.

■ Registering Logic Parts

◆ Registering Rung Parts

Registering a part of a rung as a logic part.

- 1 Select the range of rungs that you want to register as the part.

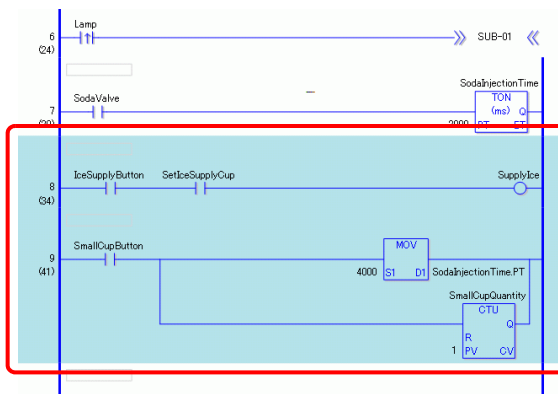

- 2 From the [Logic (L)] menu, point to [Parts (M)], and click [Save Selected Rungs (R)]. The [Rung Part Registration] dialog box appears.

- 3 Enter the [Parts Name] and [Comment] and click [Register].

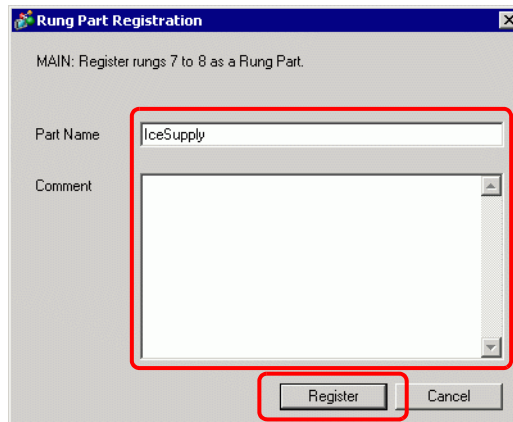

◆ Registering Subroutine Parts

Registering a subroutine program as a logic part.

- 1 Display a subroutine program you want to register as a logic part.
- 2 From the [Logic (L)] menu, point to [Parts (M)], and click [Register Subroutine (S)]. The [Subroutine Part Registration] dialog box appears.
- 3 Enter the [Parts Name] and [Comment] and click [Register].

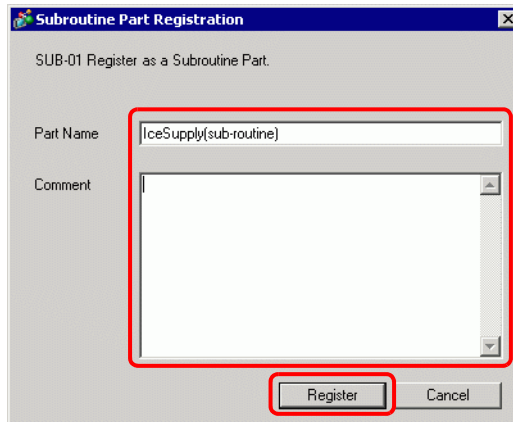

■ Calling Logic Parts

You can call a registered logic part and insert the part in the logic program that you are editing.

◆ Inserting Rung Parts in Logic Programs

- 1 Select the rung one up from where you want to insert the part or a part (power bar, instruction, etc.) of the rung.

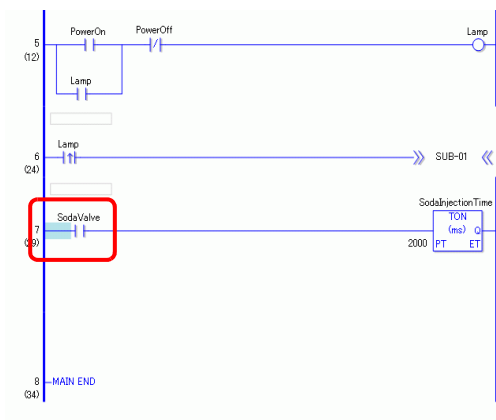

- 2 From the [Logic (L)] menu, point to [Parts (M)], and click [Load (P)]. The [Load Part] dialog box will display.

3 Select [Rung Parts] and choose the rungs parts to be inserted from [Parts Name] and click [Load].

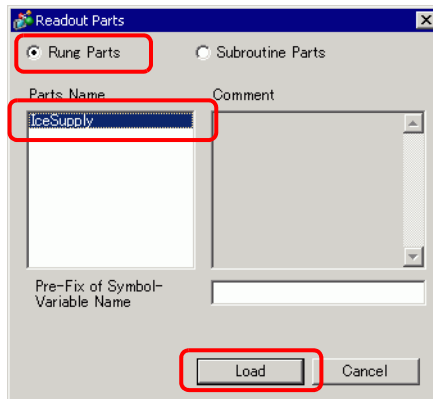

NOTE

- You can avoid overlapping the symbol variable names by inputting text in [Pre-Fix of Symbol-Variable Name].
 If a logic program is loaded when the symbol variables are overlapped, the variable type may be changed.
 In that case, the input text is added in front of the symbol variable name of the rung parts, then inserted into the logic program you are editing.
 For example, when entering "ALine" in [Pre-Fix of Symbol-Variable Name]:

	Rung Parts	After Insertion of the Logic Program
Symbol Variable Name	Switch1	ALineSwitch1

4 The rung part is inserted.

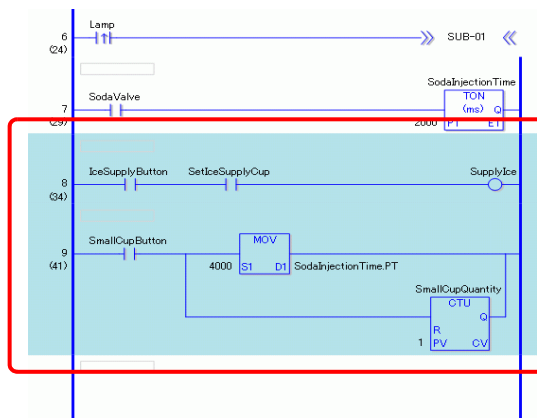

◆ Add Subroutine Parts

- 1 From the [Logic (L)] menu, point to [Parts (M)], and click [Load (P)]. The [Load Part] dialog box will display.
- 2 Select [Subroutine Parts] and the [Parts Name]. Select [Subroutine Parts], then select [Parts Names], [Subroutine Name], then click [Load].

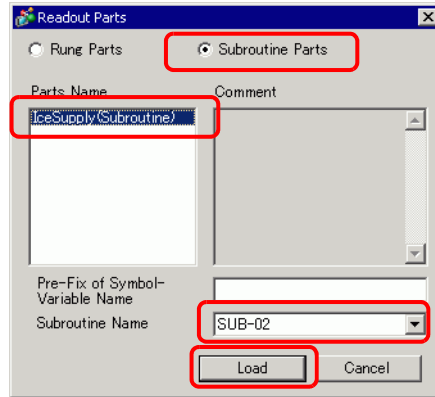

- 3 The subroutine screen with the selected subroutine name will be added.

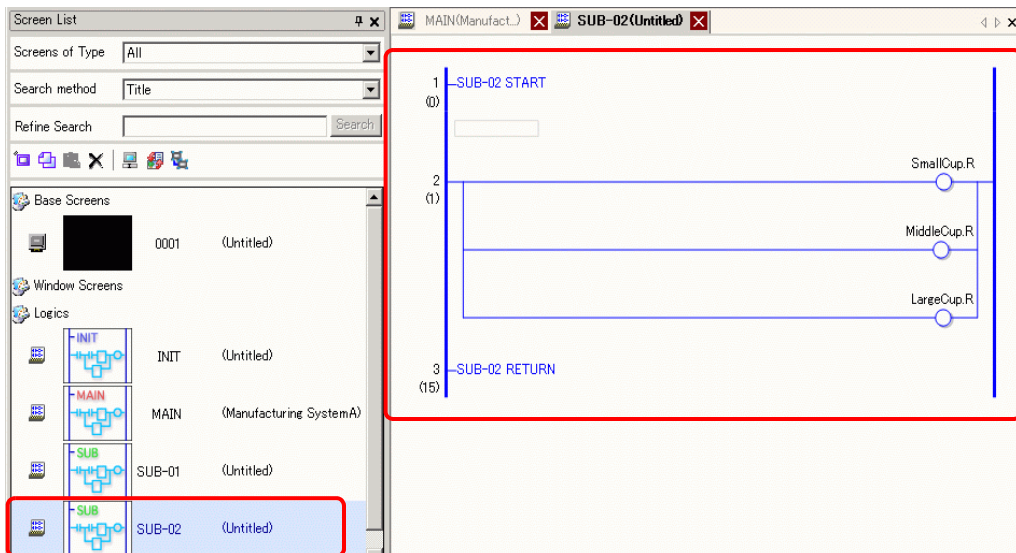

■ Editing Logic Parts

You can edit and delete part names and comments for registered logic parts.

- 1 From the [Logic (L)] menu, point to [Parts (M)], and click [Parts Management (M)]. The [Parts Management] dialog box appears.
- 2 Select [Edit Part Name/Comment] to edit rung parts, and select [Subroutine Parts] to edit subroutine parts.
- 3 From [Parts List], click [Rung Parts] if you want to edit rung parts, or click [Subroutine Parts] if you want to edit subroutine parts, and select [Parts Name].

NOTE

- You can also display [Parts Name] by clicking **+**.
-

- 4 To edit [Parts Name] or [Comment], click [Edit] to modify the text in [Parts Name] or [Comment].

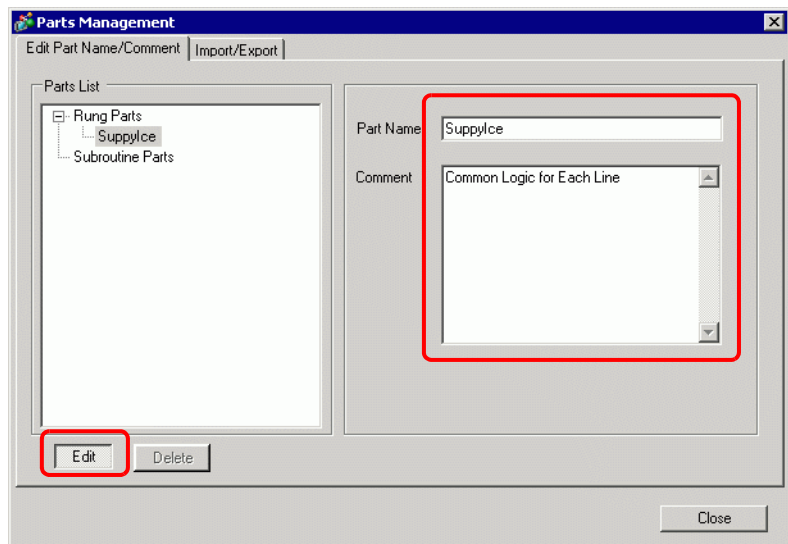

To delete parts, click [Delete (D)]. When the following dialog box appears, click [Yes (Y)].

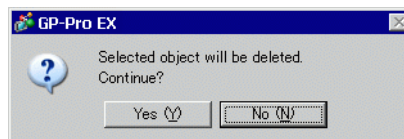

- 5 Click [Close] to close the [Parts Management] dialog box.

■ Logic Parts Import/Export

You can import and export registered logic parts together into a single file (.lpf). This enables you to use the same logic parts in GP-Pro EX on other computers.

NOTE

- Unreadable addresses cannot be used as device addresses. For unreadable addresses, refer to the "GP-Pro EX Device Connection Manual".

◆ Export Procedures

- 1 From the [Logic (L)] menu, point to [Parts (M)], and click [Parts Management (M)]. The [Parts Management] dialog box appears.
- 2 Click the [Import/Export] tab.
- 3 From [Parts List], click [Rung Parts] if you want to export rung parts, or click [Subroutine Parts] if you want to export subroutine parts, and select [Parts Name].

NOTE

- You can also display [Parts Name] by clicking .

- 4 Click [Add>>]. Parts are added to [Parts to Export].

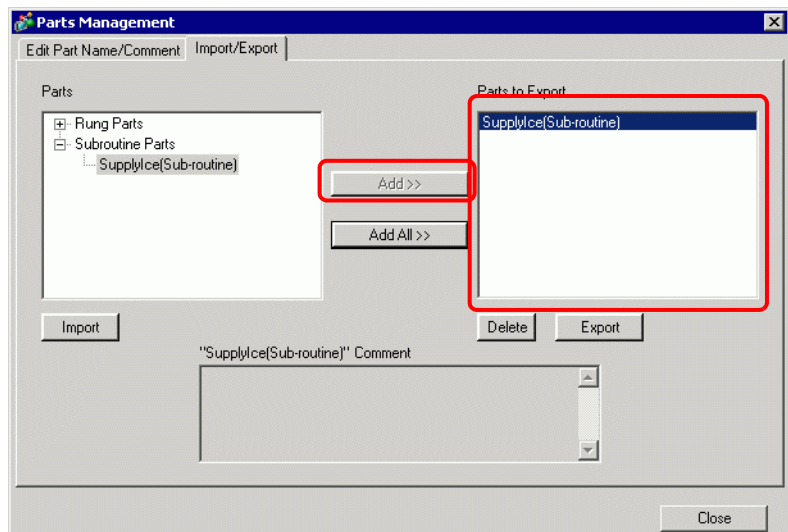

NOTE

- To export multiple parts, repeat the steps 3 and 4.
- To export all parts, click [Add All>>].
- Parts can also be added to [Parts to Export] by double-clicking the [Parts Name] in the [Parts List].

- 5 Click [Export]. Parts in the [Export Summary] will be exported.

6 Specify the save location for the logic parts batch file (.lpf), enter a name, and click [Save].

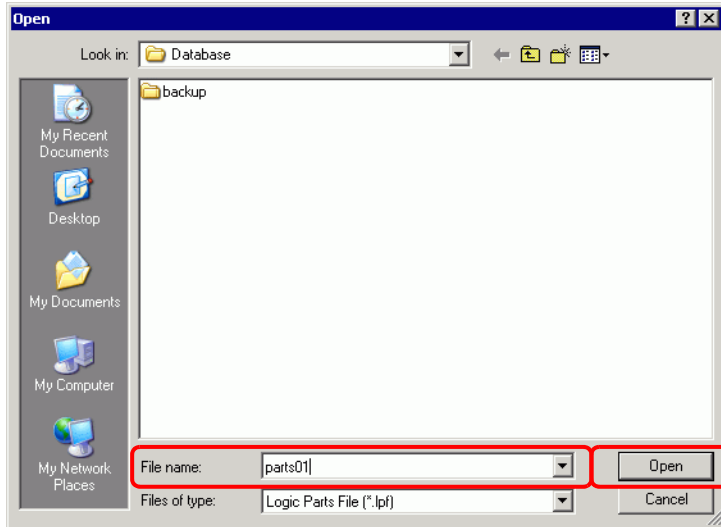

7 Click [Close] to close the [Parts Management] dialog box.

◆ Import Procedures

Copy the exported logic parts batch file (.lpf) on the computer used beforehand.

- 1 From the [Logic (L)] menu, point to [Parts (M)], and click [Parts Management (M)]. The [Parts Management] dialog box appears.
- 2 Click the [Import/Export] tab.
- 3 Click [Import].

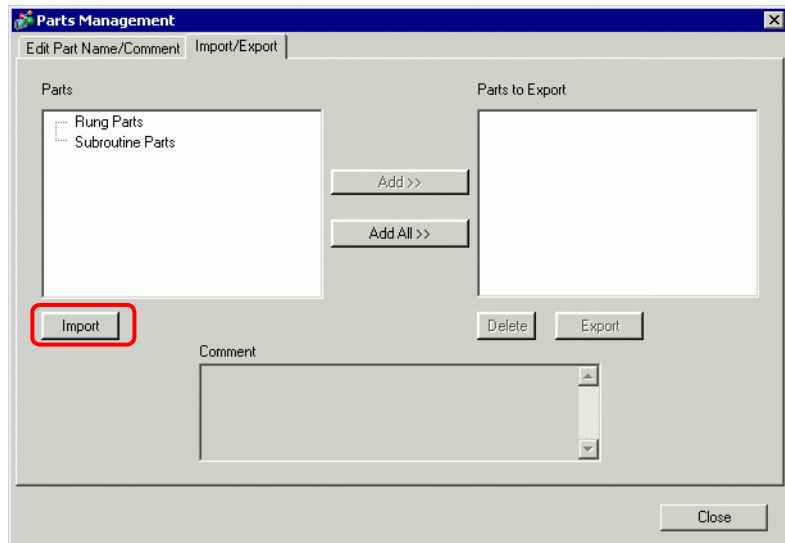

4 Specify a logic parts batch file (.lpf) to be imported, and click [Open].

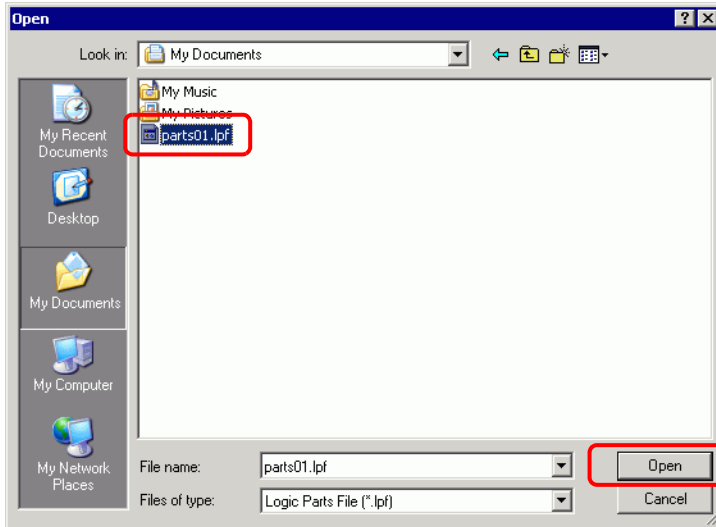

5 Logic parts will be imported.

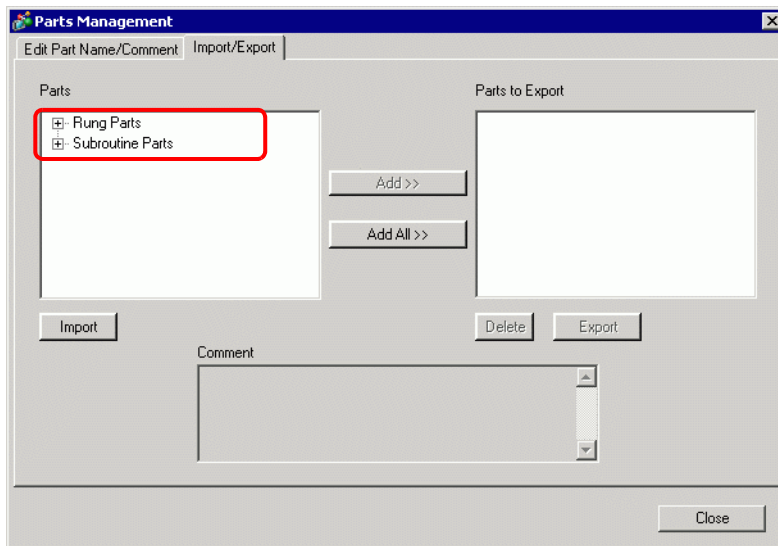

NOTE

- If there are parts with the same names to be imported, a message will appear. Check the parts name, and click [OK (O)].

6 Click [Close] to close the [Parts Management] dialog box.

29.13.7 Deleting all unused symbol variables

From registered symbol variables, all unused symbol variables can be deleted at once.

1 Select the [Address] tab to open the [Address] window.

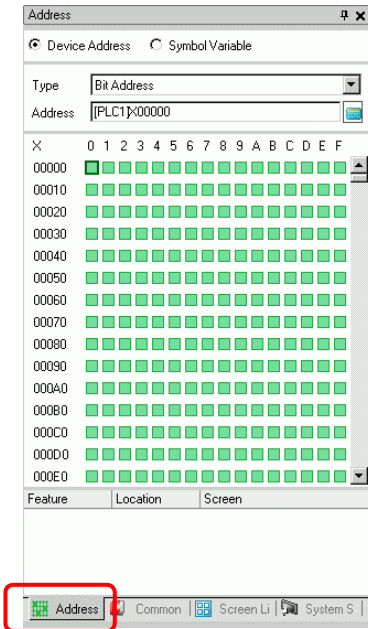

NOTE • If the [Address] tab is not displayed in the Work Space, on the [View (V)] menu, point to [Work Space (W)], and then click [Address (A)].

2 Select [Symbol variable] and click . The [Unused Symbol Variables] dialog box will appear.

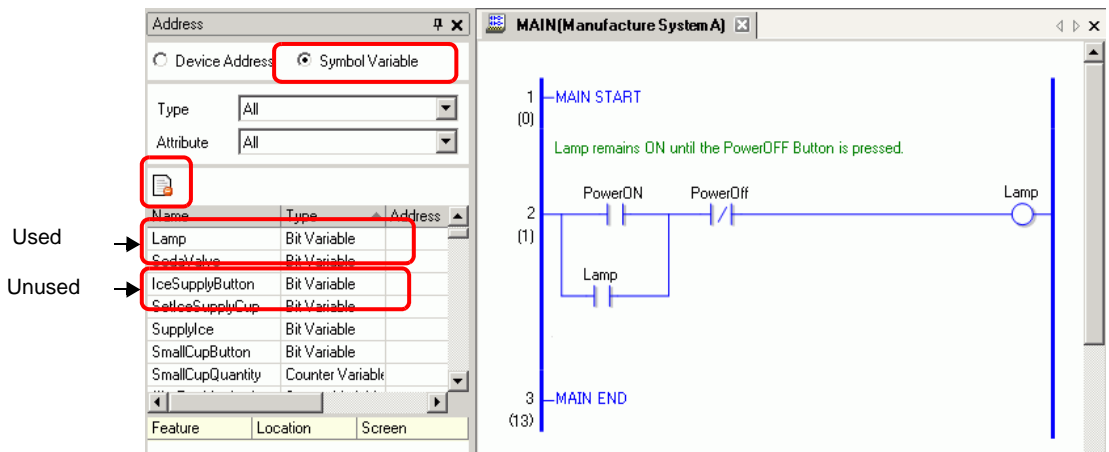

3 Click [Delete All].

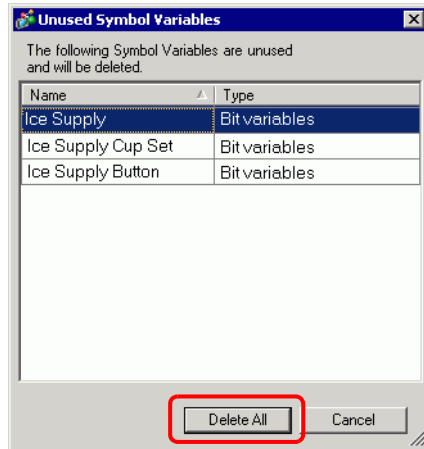

NOTE • Deletes all unused variables. You cannot specify which variables to delete or not delete.

4 All unused symbol variables were deleted.

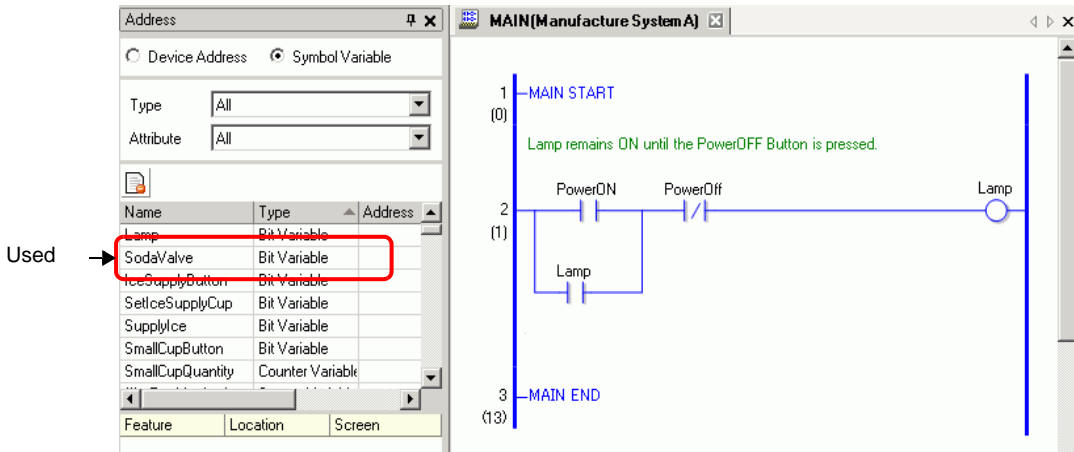

29.13.8 Toolbar Customization

When programming, you may want to put frequently used instruction icons on the toolbar.

■ Setup Procedure

- 1 On the [View (V)] menu, click [Option Settings O)]. The [Option Settings] dialog box appears.
- 2 Select [Toolbar], then click [Toolbar Settings]. The [Toolbar Settings] dialog box appears.

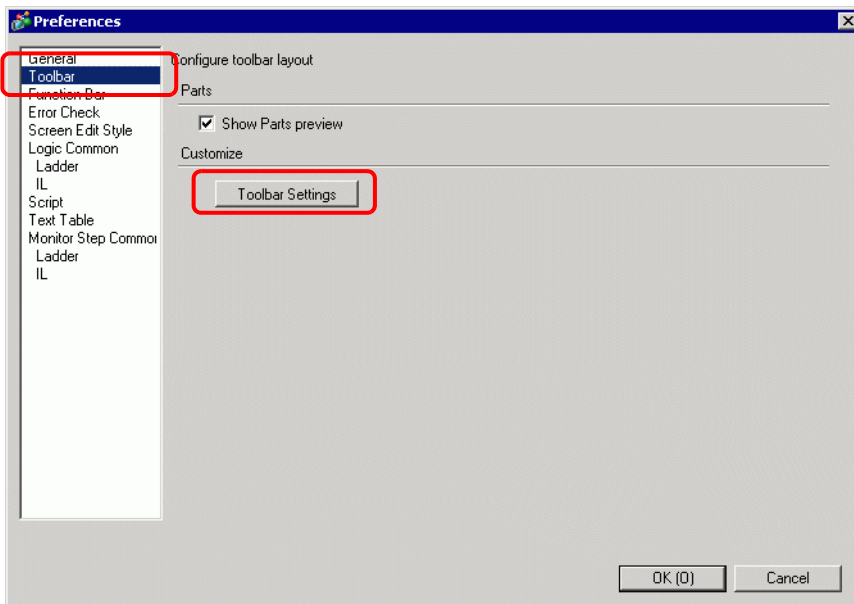

- 3 Select [Object Toolbar], and then [Ladder Instruction]. Select the category of the command you want to place on the toolbar. Icons in the selected category appear in [Items].

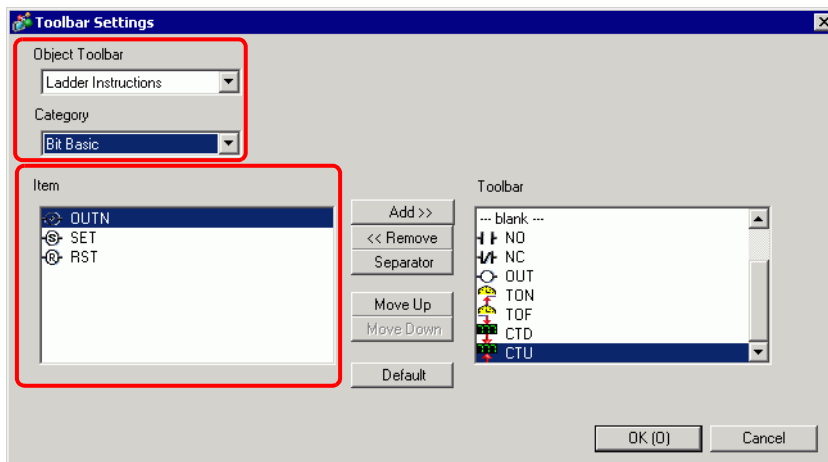

4 In [Item], select the icon and click [Add] to move the selected icon to [Toolbar].

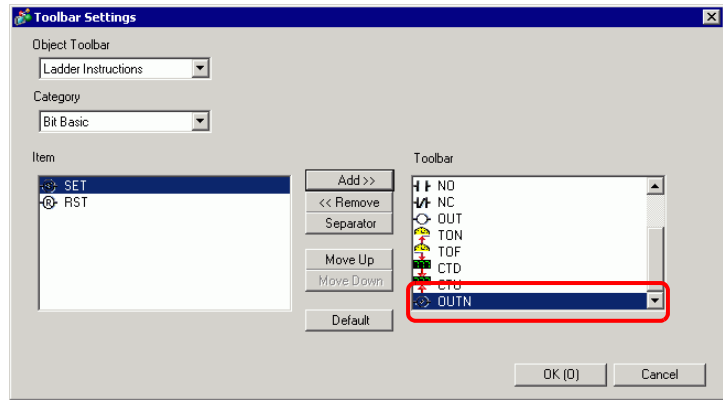
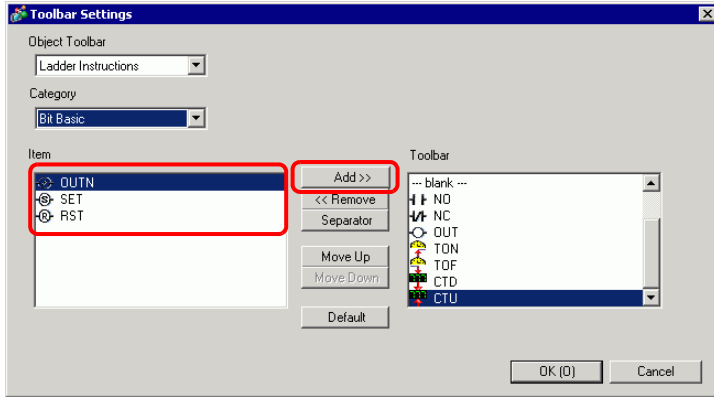







5 Click [OK (O)] to close the [Toolbar Settings] dialog box, then click [OK (O)] to close the [Preferences] dialog box.

■ Ladder Instructions Icon List

























Icons for each instruction are shown below.

NOTE

- For details on the instructions, refer to the relevant instructions.
 Chapter 31 Instructions (page 31-1)

Category		Feature	Instruction	Icon
Basic Instructions	Bit Basics	Normally Open	NO	
		Normally Closed	NC	
		Out	OUT	
		Negative Out	OUTN	
		Set	SET	
		Reset	RST	
	Pulse Basic	Positive Transition	PT	
		Negative Transition	NT	
	Program Control	Jump	JMP	
		Jump to Subroutine	JSR	
		Return	RET	
		Repeated Process (Start)	FOR	
		Repeated Process (End)	NEXT	
		Inverse	INV	
		Exit	EXIT	
		Power Bar Control	PBC	
Power Bar Reset		PBR		
Logic Wait Instruction	LWA			































Continued

Category		Feature	Instruction	Icon
Operation Instructions	Operation Instruction	Add	ADD	
		Subtract	SUB	
		Multiplication	MUL	
		Division	DIV	
		Modulation	MOD	
		Increment	INC	
		Decrement	DEC	
	Time Operation	Time Addition	JADD	
		Time Subtraction	JSUB	
	Logical Operation	Logical AND	AND	
		Logical OR	OR	
		Logical XOR	XOR	
		Logical NOT	NOT	
	Transfer	Move (Copy)	MOV	
		Block Move (Block Copy)	BLMV	
		Fill Move (Fill Copy)	FLMV	
		Exchange	XCH	
	Shift	Shift Left	SHL	
		Shift Right	SHR	
		Arithmetic Shift Left	SAL	
		Arithmetic Shift Right	SAR	
	Rotation	Rotate Left	ROL	
		Rotate Right	ROR	
		Rotate Left with Carry Over	RCL	
Rotate Right with Carry Over		RCR		





Continued

Category		Feature	Instruction	Icon
Compare Instructions	Arithmetic Compare	Compare (=)	EQ	
		Compare (>)	GT	
		Compare (>=)	GE	
		Compare (<)	LT	
		Compare (<=)	LE	
		Compare (<>)	NE	
	Time Compare	Time Compare (=)	JEQ	
		Time Compare (>)	JGT	
		Time Compare (>=)	JGE	
		Time Compare (<)	JLT	
		Time Compare (<=)	JLE	
		Time Compare (<>)	JNE	
	Date Compare	Date Compare (=)	NEQ	
		Date Compare (>)	NGT	
		Date Compare (>=)	NGE	
		Date Compare (<)	NLT	
		Date Compare (<=)	NLE	
		Date Compare (<>)	NNE	
Timer Instructions	—	On Delay Timer	TON	
		Off Delay Timer	TOF	
		Pulse Timer	TP	
		Duration On Delay Timer	TONA	
		Duration Off Delay Timer	TOFA	
Counter Instructions	—	Up Counter	CTU	
		Down Counter	CTD	
		Up/Down Counter	CTUD	

Continued

Category		Feature	Instruction	Icon
Convert Instructions	Data Convert	BCD Convert	BCD	
		BIN Convert	BIN	
		Encode	ENCO	
		Decode	DECO	
		Convert to Radian	RAD	
		Convert Degree	DEG	
		Scale	SCL	
	Type Convert	Convert Integer to Float	I2F	
		Convert Integer to Real	I2R	
		Convert Float to Integer	F2I	
		Convert Float to Real	F2R	
		Convert Real to Integer	R2I	
		Convert Real to Float	R2F	
		Convert to Seconds	H2S	
Convert Seconds to Time	S2H			
Function Instructions	Calculation Functions	Sum	SUM	
		Average	AVE	
		Square Root	SQRT	
		Bit Count	BCNT	
		PID	PID	
	Trigonometric Functions	Sine	SIN	
		Cosine	COS	
		Tangent	TAN	
		Arc Sine	ASIN	
		Arc Cosine	ACOS	
		Arc Tangent	ATAN	
		Cotangent	COT	
	Miscellaneous Functions	Exponential	EXP	
Logarithm		LN		
Log Base 10		LG10		

Continued

Category		Feature	Instruction	Icon
R/W Instruction	Time Read/Write	Read Time	JRD	
		Set Time	JSET	
	Date Read/Write	Read Date	NRD	
		Set Date	NSET	

29.13.9 Collectively Editing Symbol Variables

You can import and export a list of symbol variable settings as a CSV-format file.

The CSV format for exporting data in the symbol variable settings allows you to create or edit data using generic spreadsheet software.

◆ CSV File Format

In the [Edit Symbol Variables] window, click [Utility] and then click [Export] to output information on the symbol variable settings as a CSV-format file as follows.

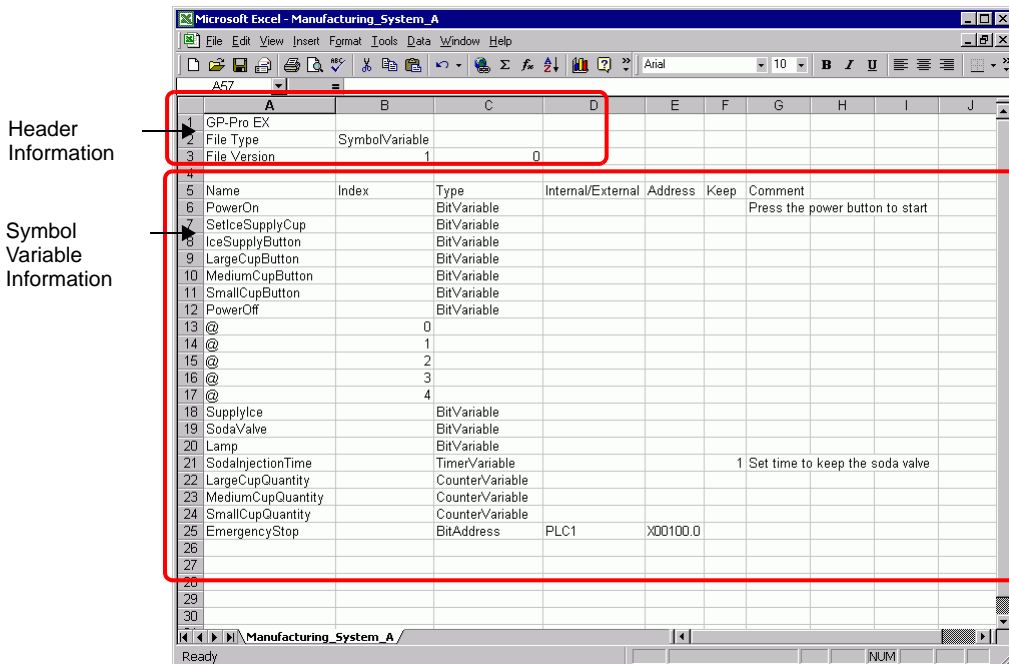

- **Header Information**

The GP-Pro EX header information is attached to the exported CSV file. If any changes are made to the information, an error will occur during import. Please do not edit the information.

- GP-Pro EX : (Please do not edit.)
- File Type : Symbol Variable (Please do not edit.)
- File Version : The file version is saved. (Please do not edit.)

NOTE • When creating new symbol variables in a CSV file, use the above formats, including the header information.

- **Symbol Variable Information (Required)**

This is information on the symbol variables.

- Name : This saves the symbol variable names. To specify the array, use the "@" character for the array size starting from the next row.

NOTE • For naming restrictions, refer to the following.
 ☞ " ■ Registering Symbol Variables" (page 29-11)

Index : When specifying the array, use sequential values starting from zero as the index.

NOTE

- When the symbol variable is a Bit-Address or Word-Address type, it is not used.
- For details on arrays and array sizes, refer to the following.
 " ■ Arrays and Array Sizes" (page 29-15)

Type : Input the symbol variable type using the following text.

Type	Text
Bit Address	BitAddress
Word Address	WordAddress
Bit Variable	BitVariable
Integer Variable	IntegerVariable
Float Variable	FloatVariable
Real Variable	RealVariable
Timer Variable	TimerVariable
Counter Variable	CounterVariable
Time Variable	DateVariable
Date Variable	TimeVariable
PID Variable	PidVariable

NOTE

- When [Register Variable] is specified as [Address Format], use Bit Addresses or Word Addresses only.
- For details on types, refer to the following.
 " ■ Variable Type" (page 29-13)

Internal/External: Input the address category using the following text.

Category	Text	Text	Remarks
Internal Address	LS Area	#INTERNAL	You can use it only with direct access.
	User Area	#INTERNAL	
	Memory Link System Area	#MEMLINK	You can use it only with memory link.
External Address		PLC1-4	You can use it only with direct access.

NOTE

- When [Register Variable] is specified as [Address Format], use Bit Addresses or Word Addresses only.
 - For details on addresses, refer to the following.
☞ "29.3.1 Usable Addresses" (page 29-8)
-

Address : Input the address value.

NOTE

- When [Register Variable] is specified as [Address Format], use Bit Addresses or Word Addresses only.
 - For details on addresses, refer to the following.
☞ "29.3.1 Usable Addresses" (page 29-8)
-

Retentive : Input the retentive/volatile settings.

Settings	Value
Retentive	1
Volatile	0

NOTE

- For the clear setting, you can omit the "0" value.
 - When [Register Variable] is specified as [Address Format], it is not used.
 - For details on the retentive/volatile settings, refer to the following.
☞ " ■ Retentive" (page 29-16)
-

Comment : Input the comment.

NOTE

- For details on comments, refer to the following.
☞ "29.7 Input Comments" (page 29-63)
-

◆ **Export Procedures**

1 In the [Edit Symbol Variables] window, click [Utility] and then click [Export].

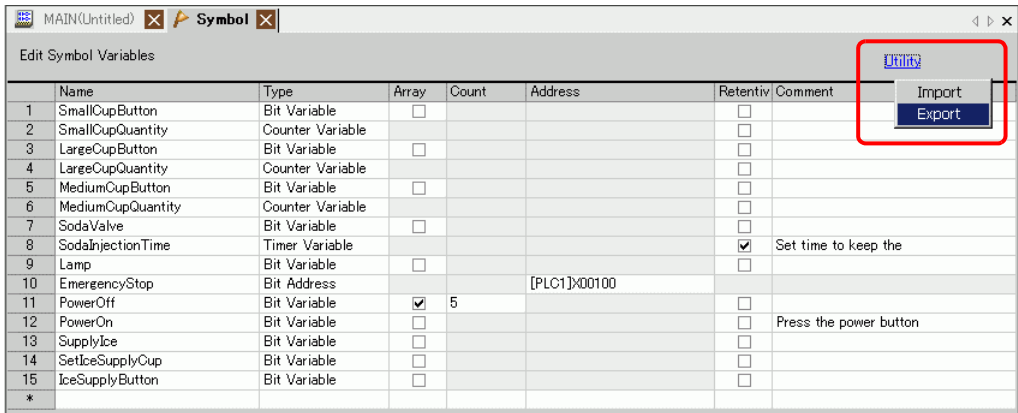

NOTE • You cannot import/export system variables.

2 Specify the location to save the CSV file, enter the file name, and then click [Save].

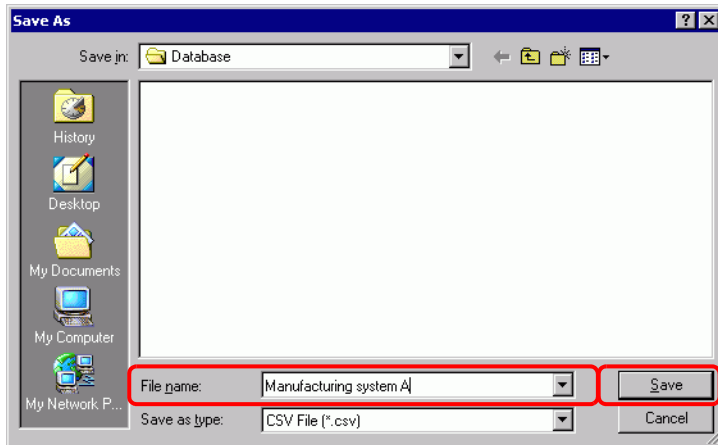

◆ **Import Procedures**

- 1 In the [Edit Symbol Variables] window, click [Utility] and then click [Import].
 - For CSV files exported from GP-Pro EX, select [GP-Pro EX Format].
 - For CSV files exported from the other application software, select [Other Formats].

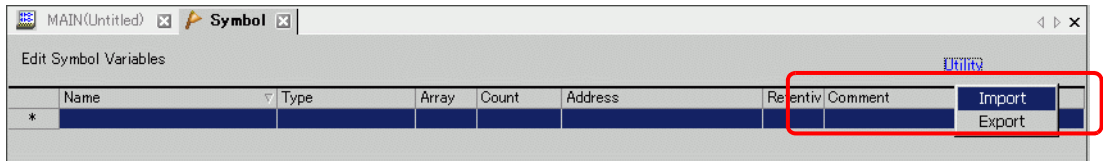

- 2 Specify the CSV file to import and then click [Open].

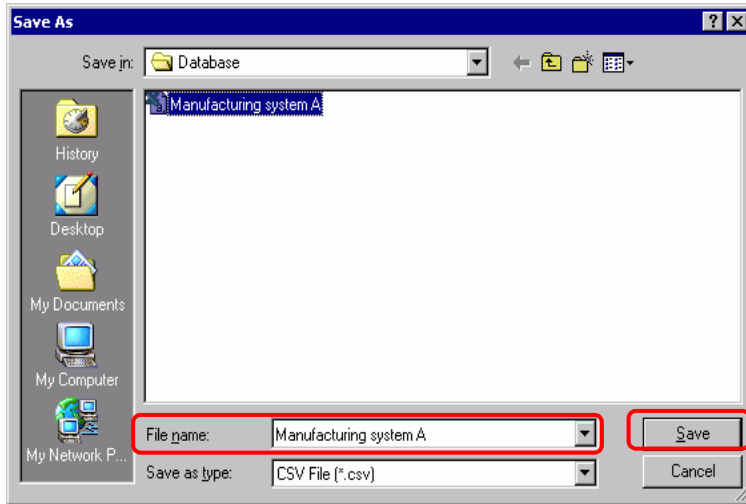

- If you selected the CSV file exported from GP-Pro EX, proceed to step 4.
 - If you selected the CSV file exported from the other application software, proceed to step 3.
- 3 The [Import Data Link] dialog box appears. Edit the data as necessary and click [OK (O)].

NOTE • For details on the [Import Data Link] dialog box, refer to the following.
 ☞ "29.14.3 [Import Data Link] Dialog Box Settings Guide" (page 29-168)

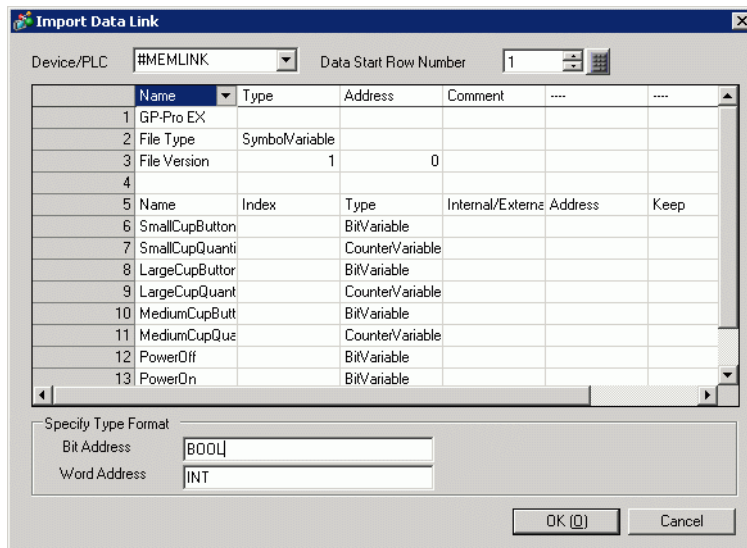

4 Import will be completed after error checking. If an error message is displayed, check the contents of the message and then click [OK (O)].

IMPORTANT

- If the CSV file is not in the appropriate format as shown below, an error message will be displayed and import cannot be completed.
 - CSV files exported from GP-Pro EX
 - The name [Name] has not been entered, or an inappropriate character has been used.
 - The symbol variable name already exists in the file.
 - The type [Type] has not been input, or undefined text has been used.
 - The array size has not been input, or sequential numbers have not been used.
 - The array settings have been input in a type [Type] that cannot be arrayed.
 - The keep setting "1" has been input for the Bit Address or Word Address.
 - The keep setting "1" has not been specified for the PID variable.

CSV files exported from the other application software

- If [Name], [Address] and [Type] are not specified
- If the number of columns exceeds the upper limit (255)
- If the number of rows exceeds the upper limit (65535)

NOTE

- If there is an error only in some rows in the imported data, the following [Import Error] dialog box appears, and only the rows free of errors are imported. Check the details of the error, and click [Close (C)].

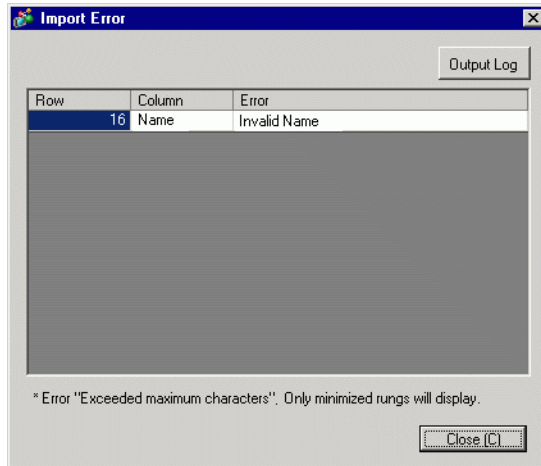

- If you click [Output Log], the contents of the [Import Error] dialog box can be output as a file in CSV format.
-

29.14 Settings Guide

29.14.1 [Logic Programs] Setting Guide

NOTE

- You can define the logic scan time settings in the System Settings [Display Unit]'s [Logic] tab.
 "5.17.6 [System Settings] Setting Guide ◆ Logic" (page 5-173)

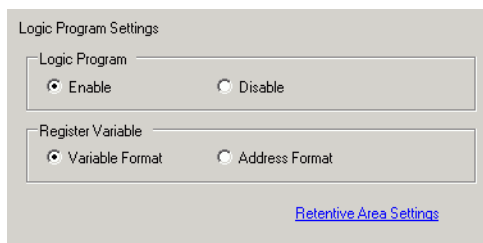

Setting	Description
Logic Program	Select whether to [Enable] or [Disable] the logic features.
Register Variable	Select [Variable Format] or [Address Format] to register an address.
Retentive Settings	<p>Click [Retentive Settings] to display the [Retentive Settings] dialog box. The retentive/volatile points can be specified for symbol variables in [Variable Format]. The retentive/volatile ranges can be specified for symbol variables in [Address Format].</p> <p>Variable Format Only the variable points for retentive/volatile may be specified. You can configure the retentive/volatile settings individually in the [Symbol Variable] window, the [Address] window or [Properties Window] after creating a new variable. Please note that the clear setting is selected when creating a new variable.</p> <p>Address Format For each address, specify the retentive/volatile range. With this setting, all the addresses within the keep area will be kept, and the addresses within the clear area will not be kept. Please note that all the variables allocated to I/O (X, Y, I, Q) will be set to volatile. You cannot change the settings to retain variables between sessions. Furthermore, you can only choose the retentive setting for PID Variables (U).</p>

Continued





Setting	Description			
Retentive Settings	Initialization Settings of Number of Retentive/Volatile			
	Symbol Variable	Reset		For Address Format
		Retentive	Volatile	
	Bit Variable	4000 points	4000 points	M_
	Integer Variable	4000 points	4000 points	D_
	Float Variable	64 points	64 points	F_
	Real Variable	64 points	64 points	R_
	Timer Variable	256 points	256 points	T_
	Counter Variable	256 points	256 points	C_
	Time Variable	32 points	32 points	J_
Date Variable	32 points	32 points	N_	
PID Variable	8 points	0 points	U_	

29.14.2 [Work Space] Settings Guide

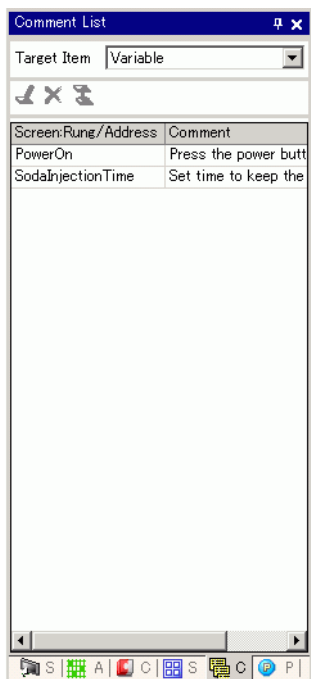
The following explains the windows displayed in the work space for using logic features.

■ Comment List



Setting	Description	
Target Item	Select [Variable], [System Variable], or [Rung] to display the comments.	
Operation Icons	Edit 	You can edit comments in [Variable] and [Rung].
	Delete 	You can delete comments in [Variable] and [Rung].
	Add 	When you click the icon, the [Address Input] dialog box appears only in [Address Format], selected in [Register Variable]. You can specify addresses and add logic addresses.  " ■ Logic Address Display" (page 29-20)
Screen: Rung/Address	The symbol variable name is displayed in [Variable]. The system variable name is displayed in [System Variable]. Double-click to switch to the [Address] window and the relevant variable will be selected. The logic name and rung number are displayed in [Rungs]. Double-click to select the target rung in the logic program.	
Comment	The comment for the selected rung will be displayed. Double click to edit [Variable] and [Rung].	

■ PID Monitor

In Monitor Step, for PID instructions used on the Logic screen, you can check the operation of PID values. You can also change each parameter.

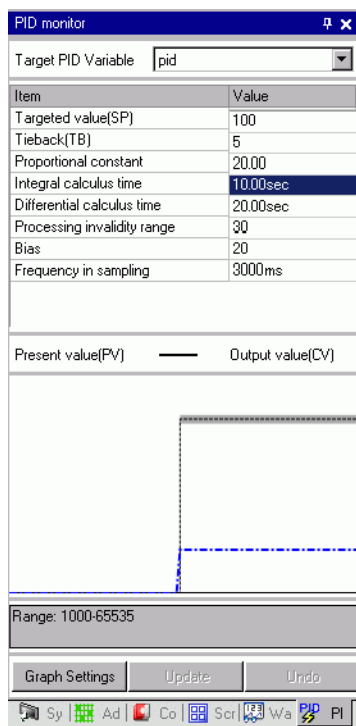

Setting	Description
Target PID Variable	Select the PID variable that you want to monitor.
List of PID Adjustments	You can input values and adjust the PID while referring to the graph.
Graph Display	The PID instruction values are displayed in a graph that can be monitored.
Graph	You can specify the details of the graph. Click and the settings dialog box appears. <div data-bbox="669 1302 1007 1518" data-label="Image"> </div>
	Displayed Items
Graph Display Range	Specify [Upper Limit], [Lower Limit] and [Width] for the graph display range.
Update	The graph must be updated with the values specified for the PID adjustment.
Undo	Return to the state before PID adjustment values were input.

◆ PID Adjustments

Items	Value
Set Point (SP)	Specify the target value. Enter values for the minimum and maximum output. The range for input depends on the PID instruction output settings. For details, refer to the PID instructions. ☞ Chapter 31 Instructions (page 31-1)
Tieback (TB)	Specify a value for output during power off. The range for input depends on the PID instruction output settings. For details, refer to the PID instructions. ☞ Chapter 31 Instructions (page 31-1)
Proportional Constant	Specify the proportion for comparison control. A larger value means that the set point will be reached sooner. A smaller value means the set point will be approached more gradually, resulting in reduced overshooting. The setting range is from 0.01 to 100.00. For details about proportional constants, see the next page. ☞ " ◆ Proportional Operation (P)" (page 29-164)
Integral Calculus Time	Specify the intervals between integral calculations. The setup range is from 0.00 to 3000.00 seconds. For details about integral calculus time, see the following. ☞ " ◆ Integral Operation (I)" (page 29-164)
Differential Calculus Time	Specify the intervals between differential calculations. The setup range is from 0.00 to 3000.00 seconds. For details about differential calculus time, see the following. ☞ " ◆ Derivative Operation (D)" (page 29-165)
Processing Deadband Range	Specifies the range in which the PID operation does not run. The deviation in the settings range is "0", and the processing deadband range is based on $(\text{maximum output value} - \text{minimum output value}) / 2$.
Bias	The value specified here is added to the output value for operation. The settings range from the minimum output value to the maximum output value.
Sampling Frequency	Specify the sampling frequency for the PID operation. The frequency depends on the scan time and the PID instruction is operated in the scan after the specified frequency. The settings range from operation frequency to 65535 (ms).

◆ **Proportional Operation (P)**

Calculate the operation volume (output value) proportionate to the deviation (deviation between the set point and current value). The formula for the relation between deviation (E) and operation volume (CV) is as follows.

$$CV = KPE \quad (\text{KP is the proportional gain.})$$

When the deviation is fixed, the proportional action is as follows.

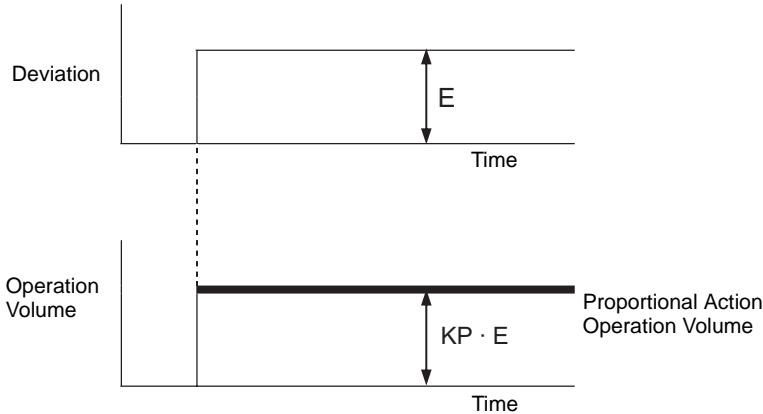

The operation volume changes within the range of 0 to 4095 (initial value). As KP increases, the operation volume proportionate to the deviation increases and the correcting action is strengthened. This proportional action causes offset (residual deviation).

◆ **Integral Operation (I)**

Continuously change the operation volume (output value) to eliminate any deviation (deviation between the set point and current value). Doing so can eliminate the offset from the proportional action.

Once deviation is caused in the integral action, the operation volume of the action changes to the operation volume of the proportional action. The time required for the change is called the "integral calculus time." The time is indicated as TI. A smaller TI results in a stronger integral action.

If the deviation is fixed, the integral action is as follows.

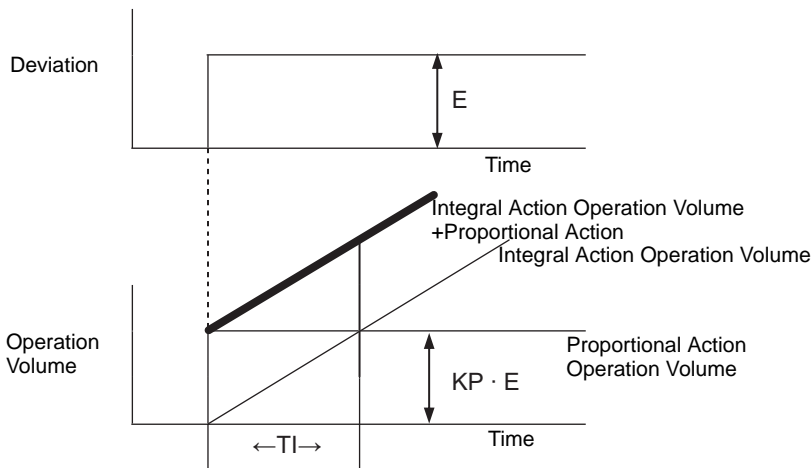

Use integral action as "PI action" combined with the proportional action or as "PID action" combined with the proportional and derivative action." You cannot use integral action alone.

◆ Derivative Operation (D)

Add the operation volume (output value) proportionate to any deviation (deviation between the set point and current value) to eliminate deviation. Doing so prevents the control target from drastically changing due to an external disturbance.

Once deviation has occurred in the derivative action, the operation volume of the action changes to the operation volume of the integral operation. The time required for the change is called the "differential calculus time" and is indicated as TD.

A larger TD results in stronger derivative action.

If the deviation is fixed, the derivative action is as follows.

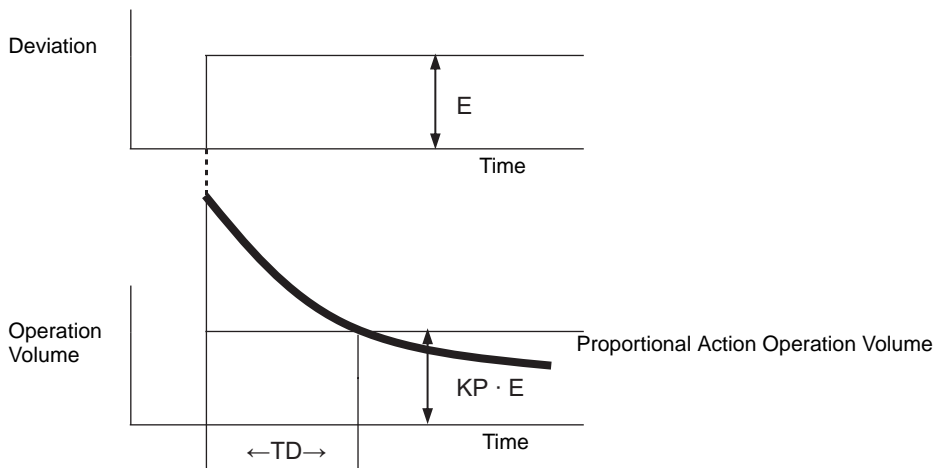

Use derivative action as "PD action" combined with the proportional action or as "PID action" combined with the proportional action and integral action." You cannot use derivative action alone.

■ Watch List

In Monitor Step, the Watch List displays the current value of symbol variables. The Watch List is useful for debugging purposes because you can edit values of symbol variables in the list.

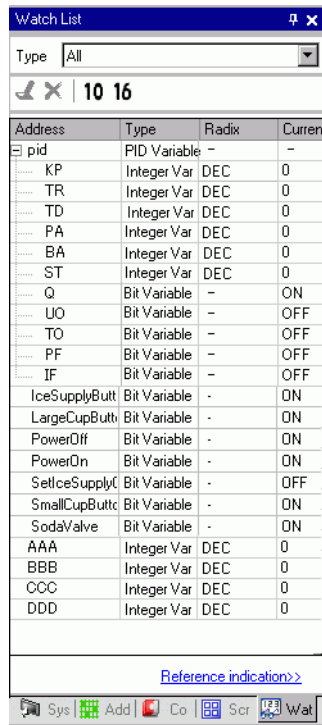

Setting		Description
Type		Select the type of symbol variable or system variable registered in the [Watch List] window. For how to register, refer to the following. "29.11.2 Monitor/Change the Current Value of Symbol Variables" (page 29-81)
Operation Icons	Edit	In Monitor Step, you can edit the display format and value of registered symbol variables.
	Delete	In Monitor Step, you can remove symbol variables from the watch list.
	Decimal 10	In Monitor Step, changes the display to decimal format.
	Hexadecimal 16	In Monitor Step, changes the display to hexadecimal format.
Address		The variable name added to the watch list will be displayed.
Type		The variable type added to the watch list window will be displayed.
Display Format		The variable format added to the watch list will be displayed.

Continued

Setting	Description
Current Value	<p>In Monitor Step, the current value added to the watch list will be displayed.</p> <p>If the type is [Bit Variable], right-click and then click [ON], [OFF], [Force ON (C)], or [Force OFF (O)].</p> <p>If the type is [Integer Variable], [Float Variable], or [Real Variable], right-click to input the value.</p>
Example Display	<p>In Monitor Step, you can configure the settings only for the [Integer Variable] type. Select [Specify Bit], [Specify Byte], or [Specify Word].</p> <p>Decimal or hexadecimal format can be specified in [Specify Byte] and [Specify Word].</p>

29.14.3 [Import Data Link] Dialog Box Settings Guide

NOTE

- Displayed when importing a CSV file exported from the other application software.

☞ "◆ Import Procedures" (page 29-156)

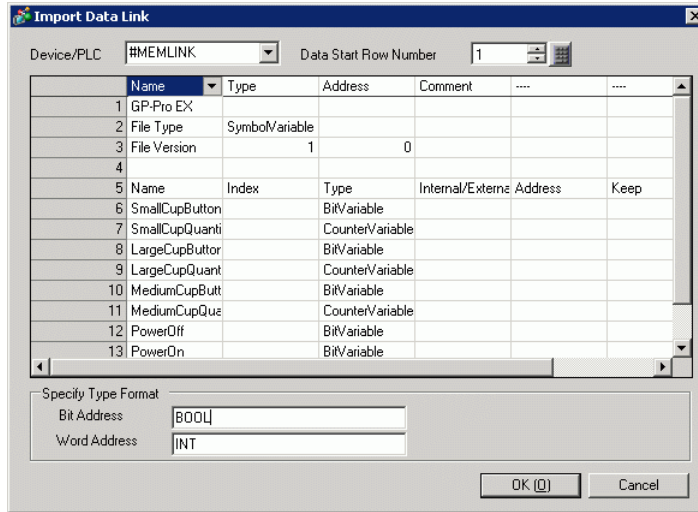

Setting	Description
Device/PLC	Specify a device/PLC of the address set for the imported symbol variable.
Data Start Row Number	Specify the row number of the data to be imported. The row before the specified row number will not be imported.
Import Data List	<p>Lists the details of imported files. Select an item name from [Name], [Type], [Address] and [Comment] as import settings for each column.</p> <p>IMPORTANT</p> <ul style="list-style-type: none"> • [Name], [Type] and [Address] must be specified. Otherwise, import cannot be completed. • Item names cannot be duplicated. Please note that if you select the item name that has already been specified for another item, the name of that item will be changed.
Bit Address	<p>You can import a specific address as a bit address from [Import Data List]. If you enter the text in [Type] in the Import Data List, all the relevant addresses are imported as bit addresses. If the field is left blank, the address will not be imported as a bit address. For example, if "BitVariable" is specified in the above screen, "Lamp", "Power Off Button", etc., are imported as a bit address.</p> <p>NOTE</p> <ul style="list-style-type: none"> • You can enter text up to 64 characters. The alphanumeric characters are case-sensitive.

Continued

Setting	Description
Word Address	<p>You can import a specific address as a word address from [Import Data List].</p> <p>If you enter the text in [Type] in the Import Data List, all the relevant addresses are imported as word addresses.</p> <p>If the field is left blank, the address will not be imported as a word address.</p> <p>NOTE</p> <ul style="list-style-type: none">• You can enter text up to 64 characters. The alphanumeric characters are case-sensitive.

29.15 Restrictions

29.15.1 Scan Time Delay

■ GP-3300 Series

- When a logic program is "enabled," a maximum 6% delay may occur temporarily.
- When communicating a large volume of data (for example, sequential address = 960 Words) on a PLC over Ethernet (for example, Mitsubishi Electric's Q Series), a maximum 30% delay may occur.
- When sending and receiving data using AGP Ethernet, take the scan time delay into consideration.
- When data is communicated with a PLC (for example, Mitsubishi Q Series) that has several Ethernet connections, a max 100% delay may occur.
- When a large volume of data (for example, 10K Bytes) is communicated using Pro-Server EX (our product), a maximum 100% scan time delay may occur. When accessing memory for a large volume of data (for example, 10K Bytes) with the Pro-Server EX, take the scan time delay into consideration.
- When data is communicated with the MPI protocol, a maximum 30% delay may occur.

■ GP-3400/3500/3600/3750 Series

- When communicating a large volume of data (sequential address = 960 Words) on a PLC that uses Ethernet (Mitsubishi Electric's Q Series), a maximum 15% delay may occur. When sending and receiving data with AGP Ethernet, take the scan time delay into consideration.
- When a large volume of data (for example, 10K Bytes) is communicated using Pro-Server EX (our product), a maximum 20% scan time delay may occur. When accessing memory for a large volume of data (for example, 10K Bytes) with the Pro-Server EX, take the scan time delay into consideration.
- When data is communicated with MPI protocol, a max of 15% delay may occur.
- When movies are recorded or played on an FTP server that has multimedia functions, a max of 15% delay may occur.
- No scan time can be guaranteed when a program is being uploaded.
- No scan time can be guaranteed when a CF card being read.
- When an error arises in the logic or the I/O driver, the scan time is delayed by approximately 10ms.
- When many devices are connected to a LAN, the scan time may be delayed. It is recommended to physically separate LAN into a control system LAN and an information system LAN, etc.
To be more specific, have two LAN cards ready on a PC and configure the control system LAN that AGP belongs to on one card and configure the information system LAN on the other. In other words, separate the LAN into two groups on the PC.
- When movies are recorded/played using the multimedia function while the logic is in use, movie recording/playback may stop.
- Please note that data updates between a device/PLC and the logic program are not synchronized when the device/PLC address (excluding internal addresses) is used in the logic program.

The data value is sometimes undefined when the logic program starts, and is not updated until communication with the device/PLC is set. Check that the device/PLC address data has been read before using it in the logic program.

For example, A special relay (always on) is used for a device/PLC.

Connection Device: Special relay (always on)

Logic program: Use the special relay in the logic program and check that the special relay is on before using the device/PLC address. If there are several devices/PLCs, a different relay is required for each device.

- For logic programs, you cannot use disabled addresses to read devices/PLC. For unreadable addresses, refer to the "GP-Pro EX Device Connection Manual".
- If the same addresses (except variables) used in instructions are referenced as both word and bit addresses, data may differ at different points in a single scan.

For example, the NO instruction [PLC1]D0000.00 is not updated even though the MOV instruction sets data in [PLC1]D0000. Even when using a variable (Data), and you write "1" to the variable, the update to the third rung [PLC1]D0000.00 occurs after a few scans.

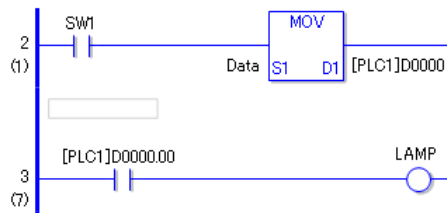

To avoid this problem, do the following.

- After substituting the address with a variable, define the bit (rung 2)
- In the logic program, to write the data change to the device/PLC, you must use the MOV instruction (rung 5)

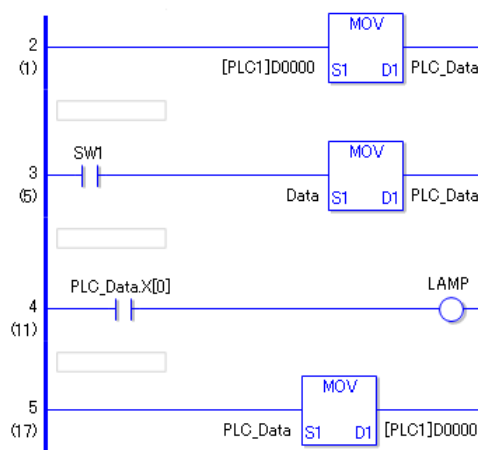

- If the logic program includes operations for writing to the device/PLC address, the following phenomenon may occur, depending on the communication speed and the number of device/PLC addresses to write to:
 - When the GP starts up, parts set up with the device/PLC address do not display.
 - Change screen operations take extra time.
 - Writing to the device/PLC fails.

- This phenomenon occurs due to excess write operations from the logic program to the device/PLC.
To avoid this problem, do the following: Increase the transmission speed with the device/PLC.

- Adjust the number of addresses to write to the device/PLC.
- Adjust the number of addresses used to write to the device/PLC. You can use operand (D) to specify device/PLC addresses.

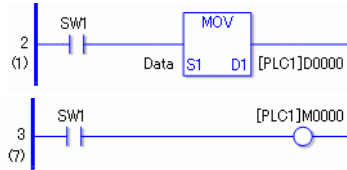

- The number of addresses that you can reference is as follows.
For example, when updating data in the logic every 10ms, in the following system use a maximum value of 20.

Device/PLC: MELSEC FX

Communication speed: 115200bps

Address updates: Medium speed

- By using the system variable #L_RefreshEnable in the logic program, you can control write operations to the device/PLC so that they occur only after communication with the device/PLC has been checked.

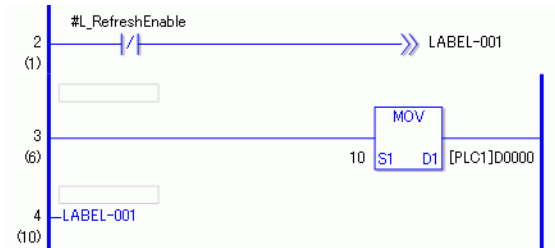

29.15.2 Restrictions for Online Monitoring

- In Online Editing, you can edit only a single rung at a time. You cannot edit multiple rungs at a time.
- Rungs containing I/O Driver instructions are unavailable for online editing.
- Scan time delay

Upon clicking [OK (O)], the modified logic program will be loaded to the GP. At that time, a scan time delay may occur only once.

For example, the following delay may occur when adding 339 steps (8 timer instructions, 8 counter instructions) to the running 10000 steps logic program:

GP-3300 Series: Approx. 8.1ms

GP-3400/3500/3600/3700 Series: Approx. 2.9ms

To avoid #L_WatchdogTime error caused by delay, the settings of Watchdog Time are ignored for the one scan mentioned above.

When you end online editing, the Watchdog Time settings will be enabled.

- Monitoring from Multiple Editors

Using the online monitor, you can connect two computers at the same time, one using a USB connection and the other using an Ethernet connection.

When one of the computers makes an online editing connection, it forces termination of the other computer's online monitor connection. The following dialog box appears to indicate that online editing is used and the online monitor will stop.

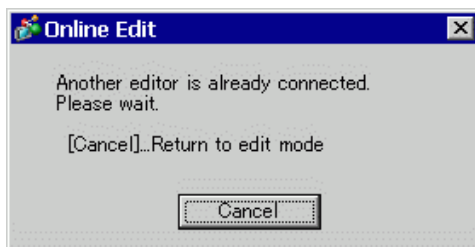

- If consecutive changes are made to the current value, the online monitor may be forced to end. In such cases, do the following.
 - If the online monitor ends when the device/PLC address value is updated, increase the communication speed with the device/PLC
 - Increase the retry count in the monitor settingsFor monitor settings, see the following.
☞ "5.17.7 [Preferences] Settings Guide ■ Monitor Step Common Settings" (page 5-197)

29.15.3 Restrictions for Online Editing

- When the project data is received after online editing while another GP-Pro EX is used for online editing, invalid data may be received; therefore, data reception will not be completed.

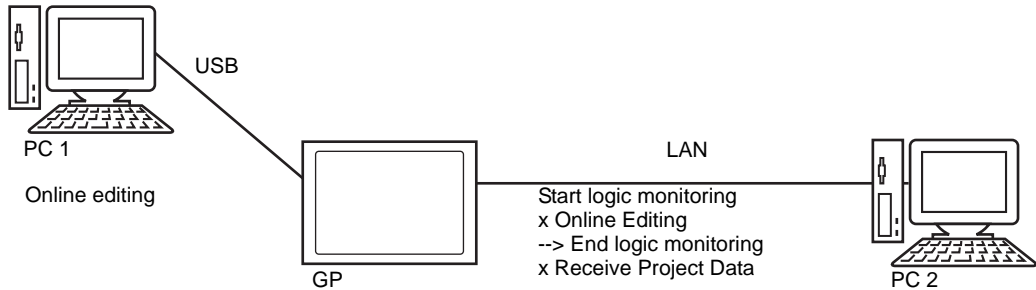

- Restrictions on the connection of multiple PC with a GP are as follows.
 - Limiting the monitoring while transferring the project by another PC
If another PC is transferring the project, GP-Pro EX notifies the user that the monitoring cannot be performed and does not carry out the process.
 - Limiting the online editing while transferring/receiving the project by another PC
If another PC is transferring/receiving the project, GP-Pro EX notifies the user that the online editing cannot be performed and does not carry out the process.
 - Limiting the transfer of the project during monitoring/online editing by another PC
If another PC is monitoring/online editing, GP-Pro EX notifies the user that the transfer of the project cannot be performed and does not carry out the process.
 - Limiting the reception of the project during online editing by another PC
If another PC is online editing, GP-Pro EX notifies the user that the reception of the project cannot be performed and does not carry out the process.

- Restriction when the second PC (PC2) is operated while the first PC (PC1) is operated

PC1 \ PC2		USB				
		Transfer Project Data	Receive Project Data	Logic Monitoring	Online Editing	Reception of Project Data after Online Editing
USB	Transfer Project Data	X	X	X	X	X
	Receive Project Data	X	X	X	X	X
	Logic Monitoring	X	X	X	X	X
	Online Editing	X	X	X	X	X
	Reception of Project Data after Online Editing	X	X	X	X	X
LAN	Transfer Project Data	X	X	X	X	X
	Receive Project Data	X	X	O		
	Logic Monitoring	X	O	O	O	O
	Online Editing	X	X	O	X	X
	Reception of Project Data after Online Editing	X	X	O	X	X

PC1 \ PC2		LAN				
		Transfer Project Data	Receive Project Data	Logic Monitoring	Online Editing	Reception of Project Data after Online Editing
USB	Transfer Project Data	X	X	X	X	X
	Receive Project Data	X	X	O	X	X
	Logic Monitoring	X	O	O	O	O
	Online Editing	X	X	O	X	X
	Reception of Project Data after Online Editing	X	X	O	X	X
LAN	Transfer Project Data	X	X	X	X	X
	Receive Project Data	X	X	X	X	X
	Logic Monitoring	X	X	X	X	X
	Online Editing	X	X	X	X	X
	Reception of Project Data after Online Editing	X	X	X	X	X

O: Operable, X: Not operable

29.15.4 Restrictions for Logic Monitoring

- The enlarged monitor and address monitor can display a limited number of characters.

Resolution	Pixel Size	Bit Instruction	Application Instruction
QVGA	320 x 240	38 characters	13 characters
VGA	640 x 480	78 characters	33 characters
SVGA	800 x 600	98 characters	43 characters
XGA	1024 x 768	126 characters	57 characters

- This is for the landscape screen only. The portrait screen can also be displayed in landscape.
- For the numeric display of actual number variables, the value displayed on the screen may not match the internal value.

29.15.5 Restriction for Logic Action When the Power is ON

- External addresses used in the logic program (connection device) are target addresses updated at the defined frequency. Other addresses that are not used in the logic program are not part of the target address list. External addresses for which communication scanning has stopped are not targets either.
- They are processed only when the power is ON or controller is reset.
- The effect is different from typical processes, depending on the speed of address refreshing.
- For communication checking after running a logic program, monitor the L system variable "#L_RefreshEnable" in the logic program.
- If a communication error occurs when the power is ON, not even the logic program will run.
- A connection device that stopped communication scanning retains its status before stopping the scanning.
- If [External Equipment Operations] is [Synchronous], the logic will not operate until communication synchronization with the external device is checked.
- If [External Equipment Operations] is [Synchronous], communication synchronization is checked even when [Logic Program Operation] is [STOP].