



# 33 | Transferring Projects and Data



This chapter explains how to transfer GP-Pro EX project files to the GP and how to transfer the project files stored on the GP to your PC.

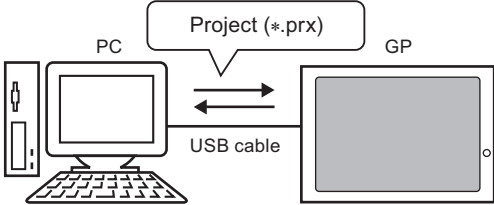

Please start by reading "33.1 Settings Menu" (page 33-2) and then turn to the corresponding page.

33.1	Settings Menu .....	33-2
33.2	Transferring Project Files via USB Transfer Cable .....	33-5
33.3	Transferring Project Files via Ethernet (LAN) .....	33-12
33.4	Comparing Project Changes Prior to Transfer .....	33-25
33.5	Transferring Only Data to a CF Card .....	33-29
33.6	Transferring with Passwords .....	33-32
33.7	Transferring Project Files Using a CF Card or USB Storage .....	33-37
33.8	Updating Remote Screen Data via Modem .....	33-50
33.9	Checking Errors .....	33-55
33.10	Setting Up Transfer Tool .....	33-58
33.11	Restrictions .....	33-74

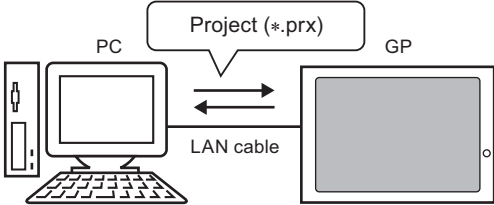
### 33.1 Settings Menu

Transferring Project Files via USB Transfer Cable	
<p>Use a USB transfer cable to transfer project files (*.prx).</p> 	<ul style="list-style-type: none"> <li> Setup Procedure (page 33-6)</li> <li> Introduction (page 33-5)</li> </ul>

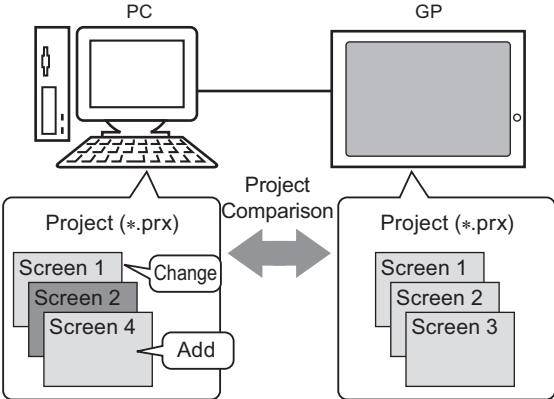
Transferring Project Files via Ethernet (LAN)	
<p>Use a LAN cable to transfer project files (*.prx).</p> 	<ul style="list-style-type: none"> <li> Setup Procedure (page 33-13)</li> <li> Introduction (page 33-12)</li> </ul>

Comparing Project Changes Prior to Transfer	
<p>Compare the project files (*.prx) on the PC and GP to check which screens have been updated.</p> 	<ul style="list-style-type: none"> <li> Setup Procedure (page 33-26)</li> <li> Introduction (page 33-25)</li> </ul>

**Transferring Only Data to a CF Card**

Without transferring the project file, copy recipe data to the CF Card in the GP, and alarm data from the CF Card to a PC.

CF-Card Export Folder

CF-Card

Copy data

\FILE  
ZR00000.csv  
ZR00001.csv  
\DATA  
...

\FILE  
ZR00000.csv  
\ALARM  
\SAMP  
...

- ☞ Setup Procedure (page 33-30)
- ☞ Introduction (page 33-29)

**Transferring with Passwords**

When transferring data, a password can be required to prevent unauthorized access and transfer.

Transfer Tool

Click

Password Input Window

Password

Try to transfer and...

A window opens and waits for the password

- ☞ Setup Procedure (page 33-33)
- ☞ Introduction (page 33-32)

**Transferring Project Files Using a CF Card or USB Storage**

Transfers project files between GP and your PC using a CF Card or USB storage.

Memory Loader Tool  
+  
Backup Data (\*.cml)

CF-Card

or

USB Memory

Create Backup Data

Download

- ☞ Setup Procedure (page 33-38)
- ☞ Introduction (page 33-37)

Updating Remote Screen Data via Modem

Connect the modem to GP and transfer the screen data from your PC to GP.

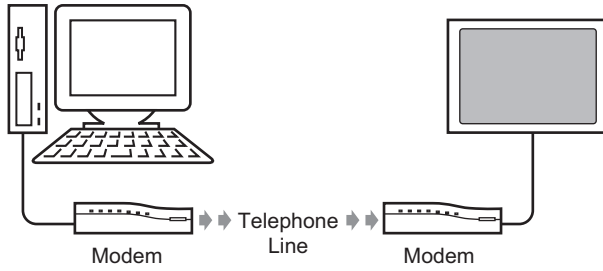

- ☞ Transfer Process (page 33-51)
- ☞ Introduction (page 33-50)

Checking Errors

Check errors before you send the project data.

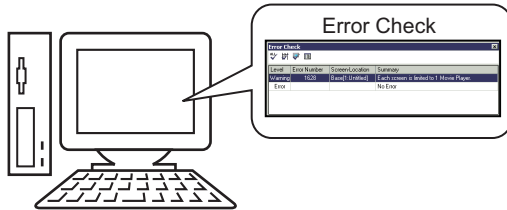

- ☞ Setup Procedure (page 33-56)
- ☞ Introduction (page 33-55)

## 33.2 Transferring Project Files via USB Transfer Cable

Use an optional USB transfer cable (type: CA3-USBCB-01) to connect a PC to the GP and transfer project files (\*.prx).

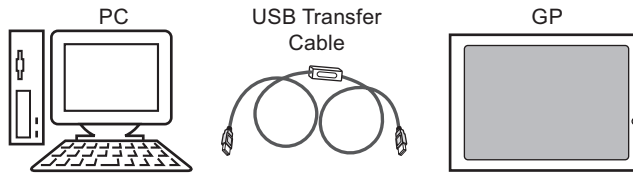

**IMPORTANT**

- For specifications and instructions on how to install your USB transfer cable, please refer to your USB transfer cable's instruction manual.

### 33.2.1 Introduction

- Transfer from PC -> GP (Send)

You can send the selected project files (\*.prx) to the GP for display.

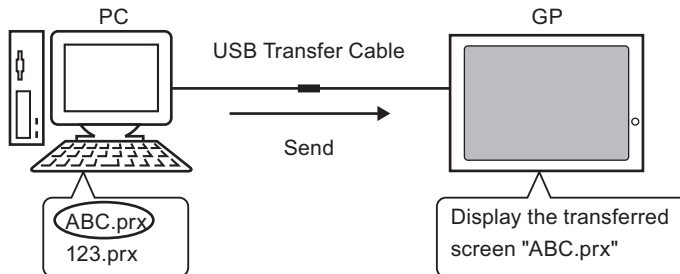

- Transfer from GP -> PC (Receive)

Project data stored in the GP can be transferred to the PC as a new project file (\*.prx)

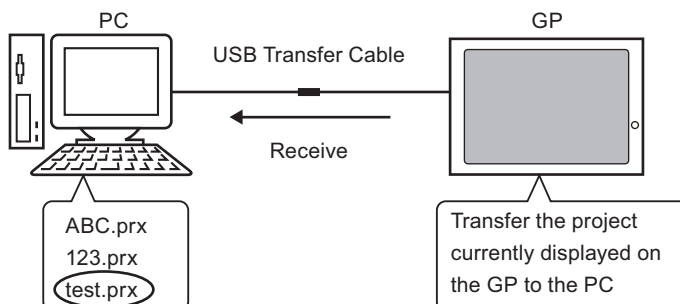

### 33.2.2 Transfer Process

#### ■ Transfer from PC to GP (Send)

The following explains the procedure for transferring project files to the GP for the first time.

**NOTE**

- For more information about the Send function, please refer to "33.10.3 How Sending Data Works" (page 33-70).
- Please refer to the Settings Guide for details.  
 ☞ "33.10 Setting Up Transfer Tool" (page 33-58)

1 Connect the PC and GP using the optional USB transfer cable set. If the USB cable driver is not installed, a dialog box appears. Install the driver as directed.

**NOTE**

- Depending on your Windows XP Security Level settings, the following [Install Hardware] dialog box may appear during USB driver installation. Click [Continue (C)] to start installation of the CA3-USBCB-01 driver. Once installation has been completed, click [Finish].

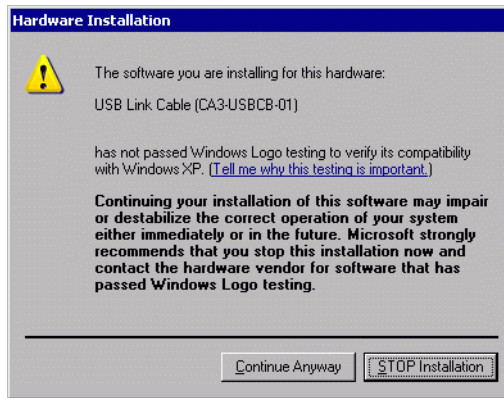

2 Turn ON the GP. The [Initial Start Mode] screen appears on the GP.  
 (GP Screen)

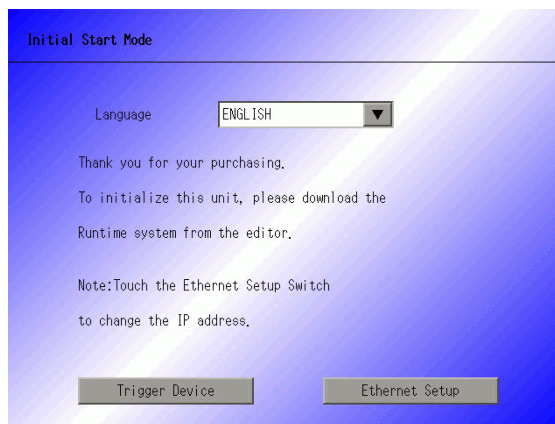

This screen appears when you first power up the GP. After transferring a project once, this screen will not appear.

3 On the GP-Pro EX state tool bar, click the Transfer Project icon . The [Transfer Tool] dialog appears.

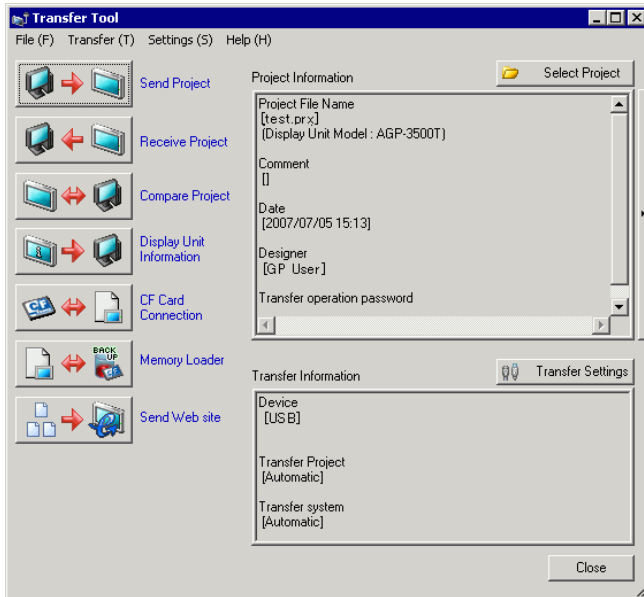

4 Confirm the project details in [Project Information].

To transfer a different project, click the [Select Project] button and choose the appropriate project.

5 In [Transfer Information], acknowledge that [Device] is [USB]. If [USB] is not selected, click [Transfer Settings]. The [Transfer Settings] dialog box appears. In [Communication Port Settings], select [USB] and click [OK].

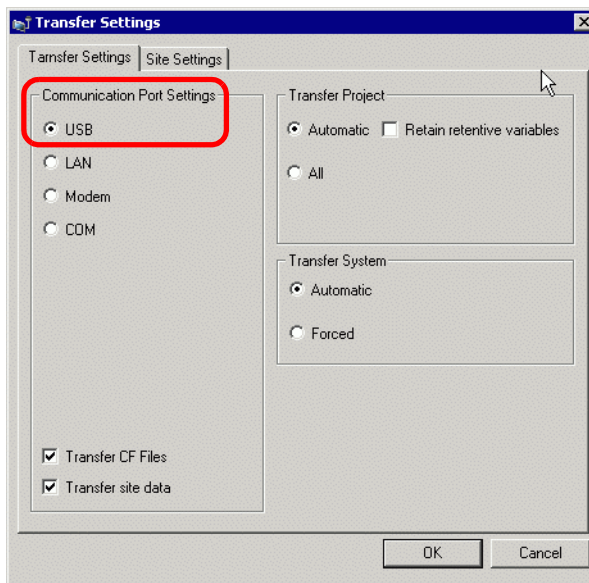

6 Click [Send Project].

The transfer begins. When the following dialog box appears, click [Yes]. This dialog box is not displayed when the same project file is sent again.

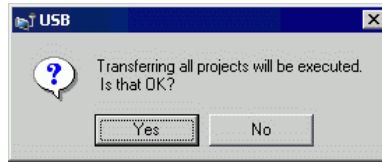

The following dialog box appears during transfer to check the communication status. During the transfer, the GP changes to Transferring mode and communication with the device/PLC is suspended.

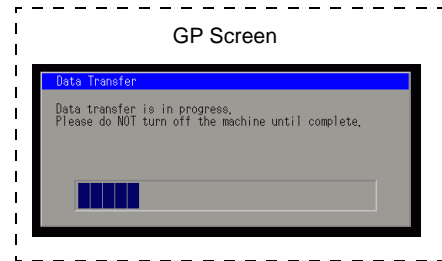
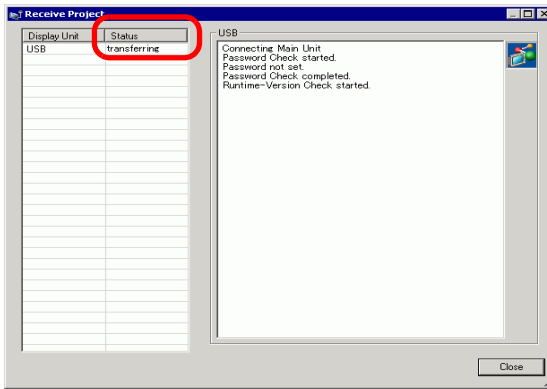

7 When the transfer finishes, the status changes from [Transferring] to [Transfer Complete]. Click [Close]. (The GP is reset and the transferred screens are displayed.)

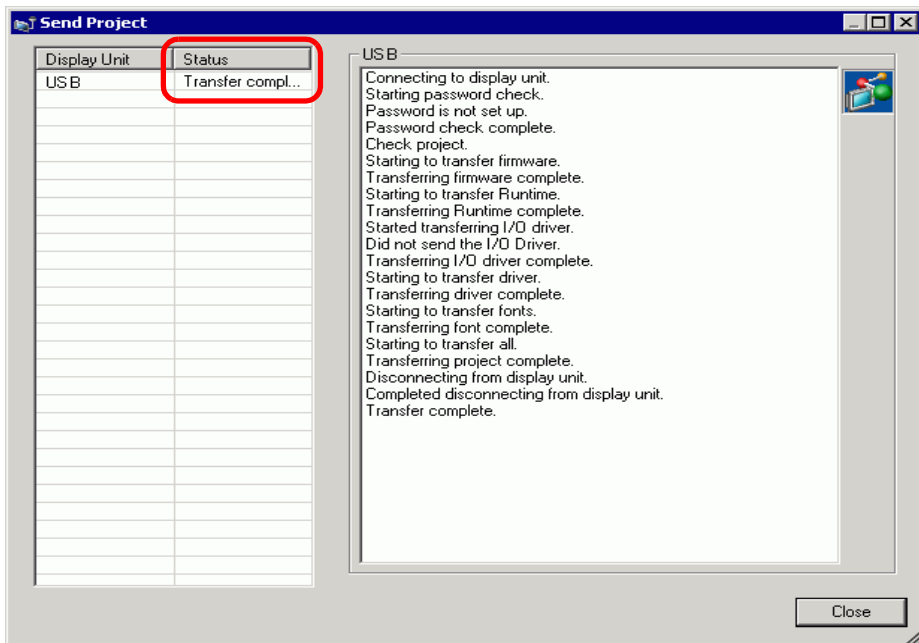

8 Click [Close] to return to the Transfer Tool. Click [Close] again to close the Transfer Tool.



## ■ Transfer from GP to PC (Receive)

Receives project data currently stored on the GP to a PC.

**NOTE**

- For more information about the Receive function, please refer to "33.10.4 How Receive Works" (page 33-71).
- Please refer to the Settings Guide for details.  
 ☞ "33.10 Setting Up Transfer Tool" (page 33-58)

1 Connect the PC and GP using the optional USB transfer cable set.

2 On the GP-Pro EX state tool bar, click the Transfer Project icon . The [Transfer Tool] dialog appears.

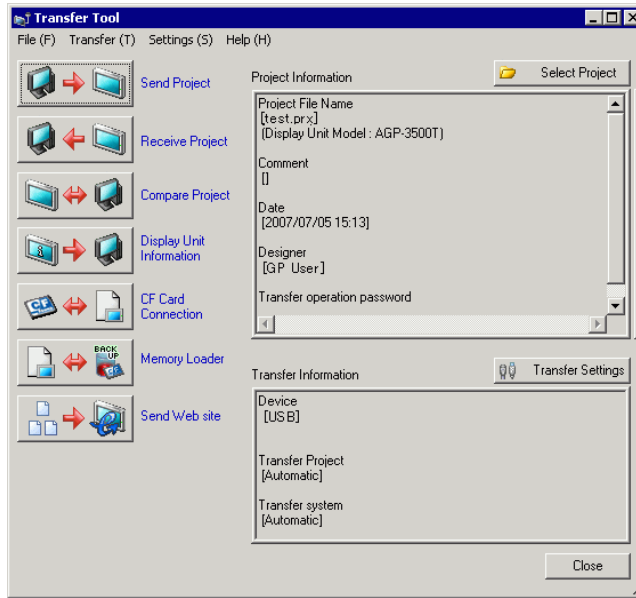

3 In [Transfer Information], acknowledge that [Device] is [USB]. If [USB] is not selected, click [Transfer Settings] to display the [Transfer Settings] dialog box below. In [Communication Port Settings], select [USB] and click [OK].

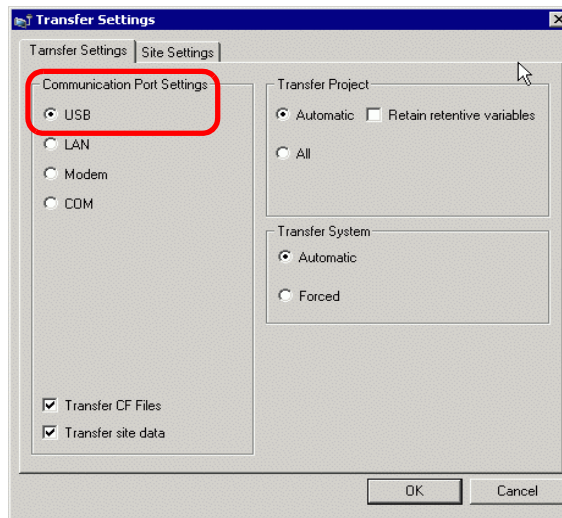





### 33.3 Transferring Project Files via Ethernet (LAN)

Use an Ethernet connection to transfer project files (\*.prx) over the LAN.

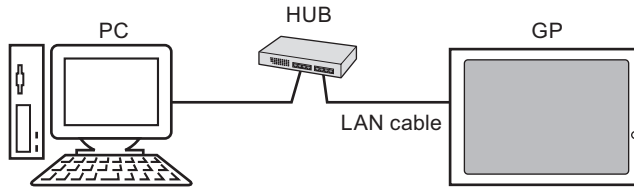

**IMPORTANT**

- To communicate using Ethernet, Ethernet settings, such as the IP address and port number, must be set up on the GP.

**NOTE**

- Make sure to use a HUB for Ethernet Communication. 1:1 connections using a cross cable may not be possible depending on the type of PC and network card you are using.

#### 33.3.1 Introduction

- Transfer from PC → GP (Send)  
 You can send the selected project files (\*.prx) to the GP to display the project.  
 The same project can be sent to multiple GPs on the network.

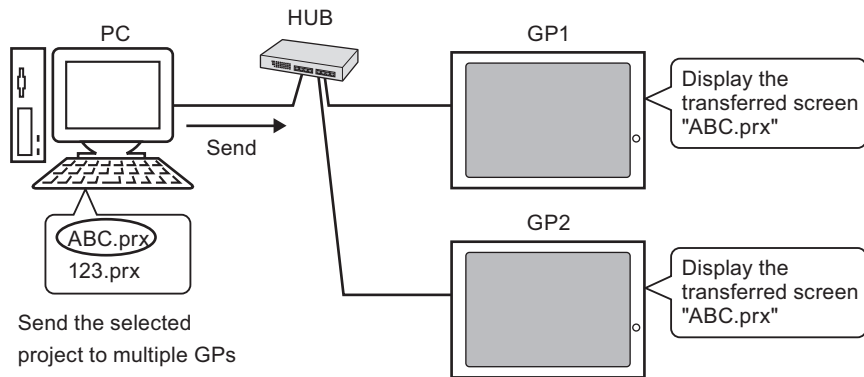

- Transfer from GP → PC (Receive)  
 Project data stored in the GP can be saved to the PC as a new project file (\*.prx)  
 Even if multiple GPs exist on the network, data can only be received from one GP.

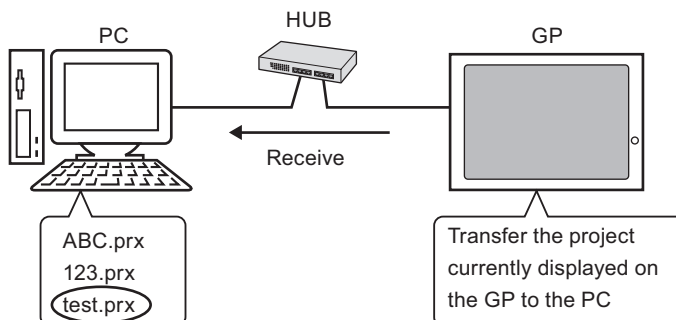

### 33.3.2 Transfer Process

#### ■ Transfer from PC to GP (Send)

This procedure is used when sending the first project to the GP.

**NOTE**

- For more information about the Send function, please refer to "33.10.3 How Sending Data Works" (page 33-70).
- The IP address preset at the time of purchase can be used to transfer data.  
 ☞ " ■ Transferring Projects Using the Factory Set IP Address" (page 33-21)
- Please refer to the Settings Guide for details.  
 ☞ "33.10 Setting Up Transfer Tool" (page 33-58)

- 1 Connect the LAN cable to the GP to establish the network with the PC installed with GP-Pro EX. (Designate the same network IP address on your PC.)
- 2 Turn ON the GP. The [Initial Start Mode] screen appears. To change the display language, touch the [Language] drop-down list.

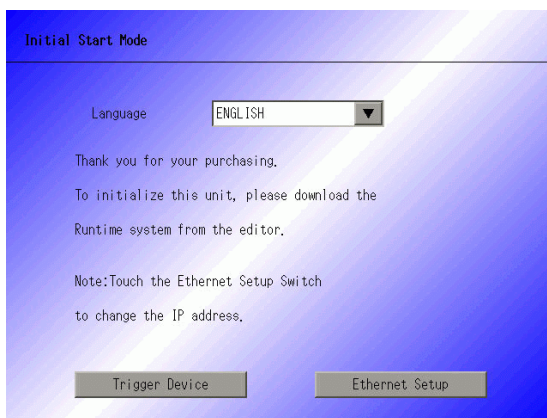

This screen appears when you first power up the GP. After transferring a project once, this screen will not appear.

- 3 Set the IP address on the GP. Touch [Ethernet Setup]. The following screen appears and the contents set at the time of transfer are displayed.

**NOTE**

- The IP address is set by default to 10.\*\*\*.\*\*\*.\*\*\*. The \*\*\*part depends on the individual model.

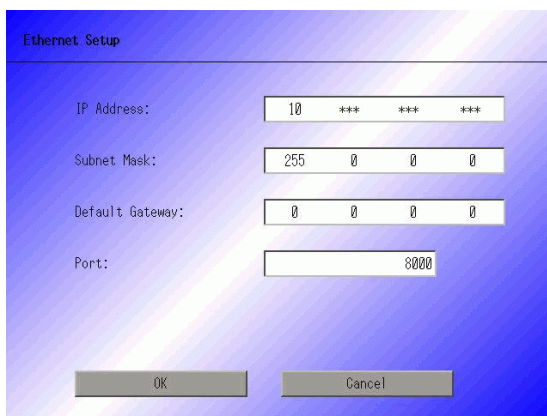

- 4 Modify the IP address, subnet mask, and touch [OK].  
(For example, First GP unit: [IP Address] 192.168.0.1; [Subnet Mask] 255.255.255.0)  
Set the IP address of the same network also to other GPs.
- 5 The confirm restart message appears. Touch [Yes] and the system restarts.  
After restarting, the [Initial Start Mode] screen is displayed.

**NOTE**

- Once a project has been transferred, the next time you transfer a project, the [Initial Start Mode] screen does not appear. To change the Ethernet settings, do so on the GP offline screen.

- 6 On the GP-Pro EX state tool bar, click the Transfer Project icon . The [Transfer Tool] dialog appears.

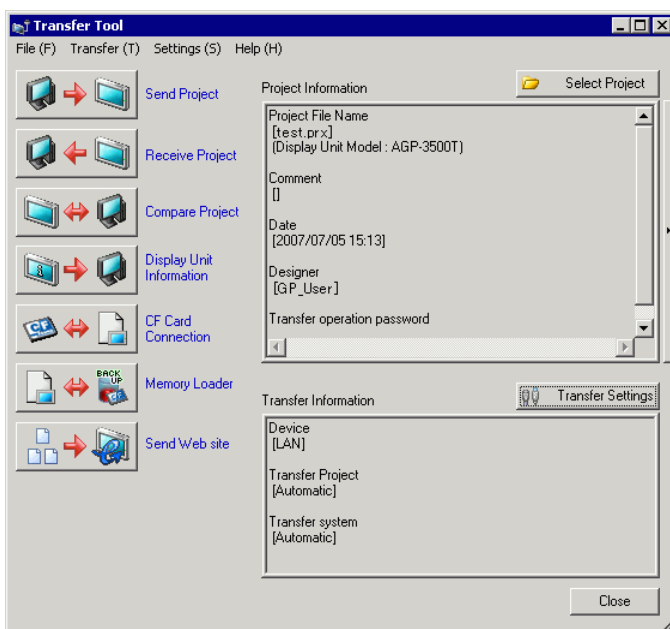

- 7 Confirm the project details in [Project Information].  
To transfer a different project, click the [Select Project] button and choose the appropriate project.

- Click [Transfer Settings] to display the [Transfer Settings] dialog box. Ensure that [Communication Port Settings] is set to [LAN]. Select the [LAN Auto Setting] check box and click [OK].

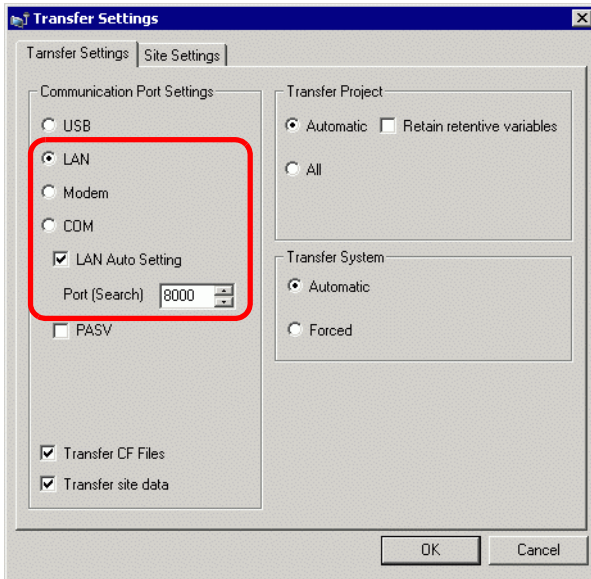

You can also open the dialog box on the [Project (F)] menu by pointing to [Transfer Project (G)] and selecting [Transfer Settings (C)].

- Click [Send Project]. The [Select Main Unit] dialog box displays the IP addresses of the GPs available on the network.

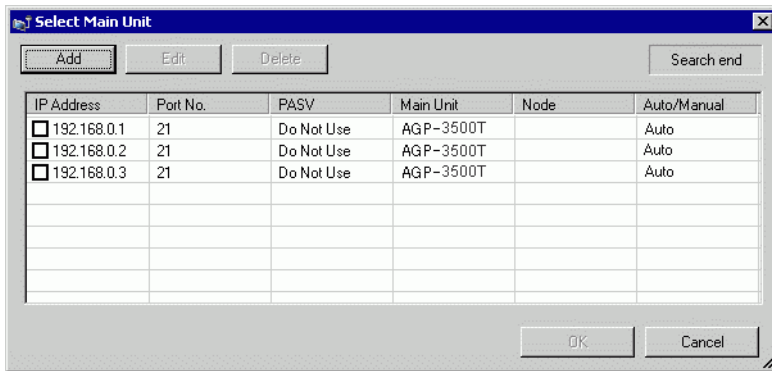

**NOTE**

- Detects the display units connected to the same subnet mask as the PC.
- If the IP address is not automatically detected, click [Add] and manually enter the IP address. You can change the port number when WinGP is in use.

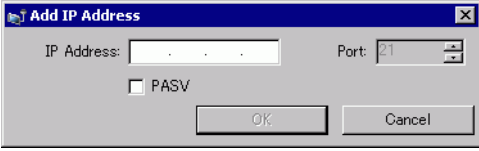

- If you cannot transfer because of firewall or router restrictions, selecting the [PASV] check box sometimes allows you continue with the transfer.

- 10 Select each IP address of the GP to which you want to transfer [OK]. The transfer begins. When multiple IP addresses are checked, the project is sent to multiple GPs at once.

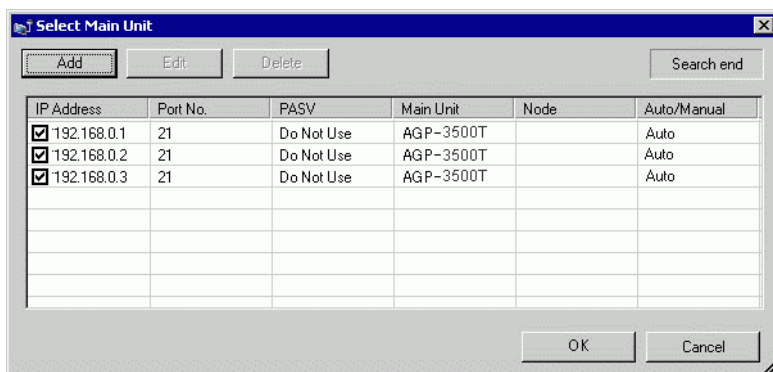

- 11 When the following dialog box appears, click [Yes]. This dialog box is not displayed when the same project file is sent again.

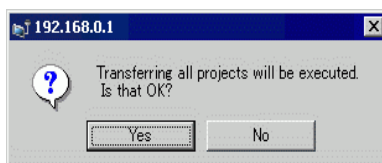

The following dialog box appears during transfer to check the communication status. The following is an example of sending multiple projects.

During the transfer, the GP changes to Transferring mode and communication with the device/PLC is suspended.

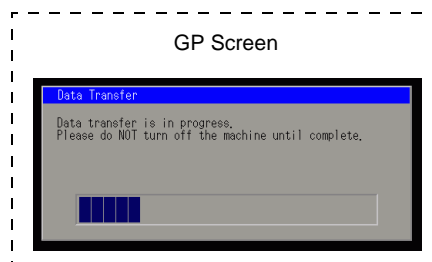
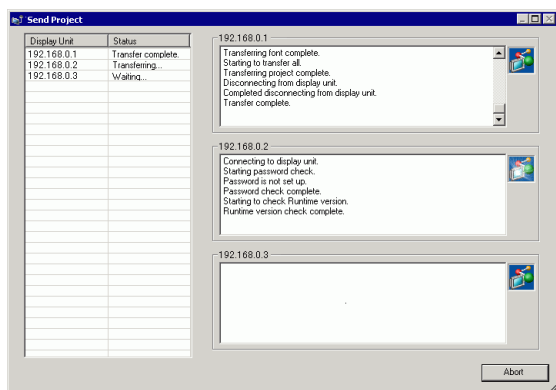

**NOTE**

- If you select multiple IP addresses, the project is transferred to one GP, then the next, in sequence.
- If a project file is password protected, the transfer cannot start until the password is confirmed.



- 12 When the transfer finishes, the status changes from [Transferring] to [Transfer Complete]. Click [Close].  
The GP is reset and the transferred project screen is displayed.

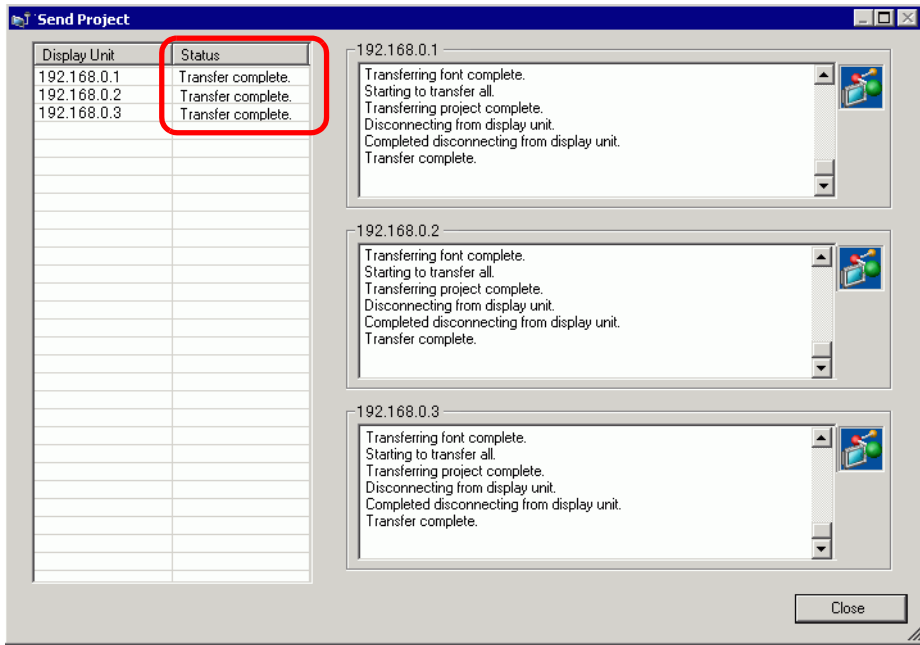

- 13 Click [Close] to return to the Transfer Tool. Click [Close] again to close the Transfer Tool.

## ■ Transfer from GP to PC (Receive)

Receives project data currently stored on the GP to a PC. You must set an IP address on the GP prior to receiving data using Ethernet.

**NOTE**

- For more information about the Receive function, please refer to "33.10.4 How Receive Works" (page 33-71).
- Please refer to the Settings Guide for details.
  - ☞ "33.10 Setting Up Transfer Tool" (page 33-58)
- Set an IP address in the "Ethernet Settings" on the offline screen.

- 1 Connect the LAN cable to the GP to establish the network with the PC installed with GP-Pro EX. (Designate the same network IP address on your PC.)
- 2 On the GP-Pro EX state tool bar, click the Transfer Project  icon to launch the transfer tool. Make sure that [LAN] is selected for [Device] in [Transfer Settings].

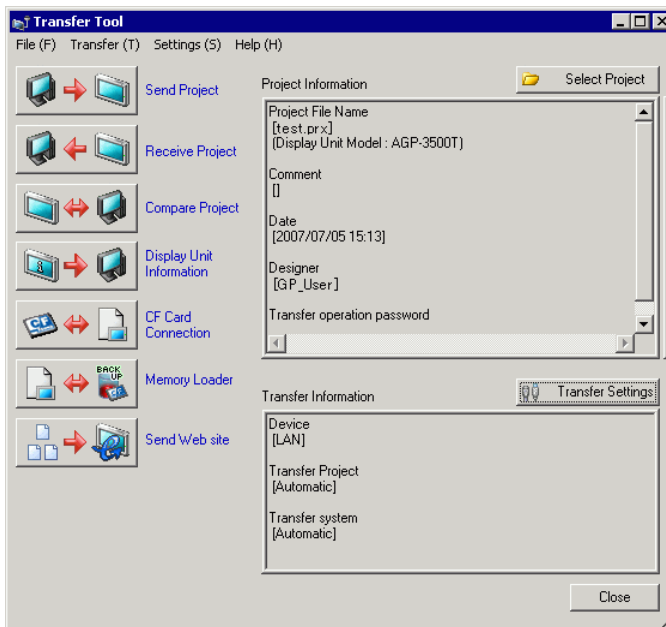

- 3 Click [Receive Project]. The following dialog box appears. Specify the [Save in] location and [File name] for the data to be received, and click [Save].

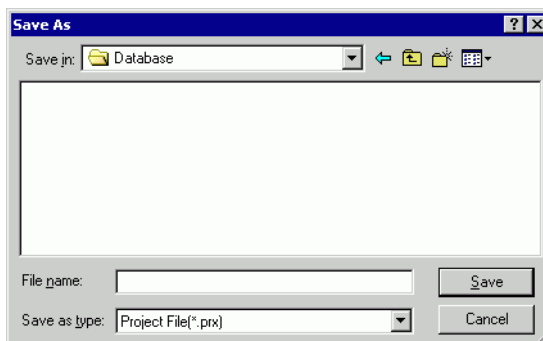





### ■ Transferring Projects Using the Factory Set IP Address

The default IP address of the GP is set at the factory. When transferring with this IP address, change the IP address used by the PC to which you are transferring data.

**IMPORTANT**

- Do not use the factory-set IP address when a private address "10.\*\*\*.\*\*\*.\*\*\*" is used on the same network. A network communication error may occur.

**NOTE**

- Please refer to the Settings Guide for details.  
☞ "33.10 Setting Up Transfer Tool" (page 33-58)

#### 1 Modify the PC's IP address subnet mask.

Set the IP address within the range of "10.255.255.1" to "10.255.255.254" and the subnet mask to "255.0.0.0".

**NOTE**

- You may have to restart the PC before the settings take effect.

#### 2 Connect the LAN cable to the GP to establish the network with the PC installed with GP-Pro EX.

#### 3 Turn ON the GP. The [Initial Start Mode] screen appears. To change the display language, touch the [Language] drop-down list. Ethernet settings do not need to be set.

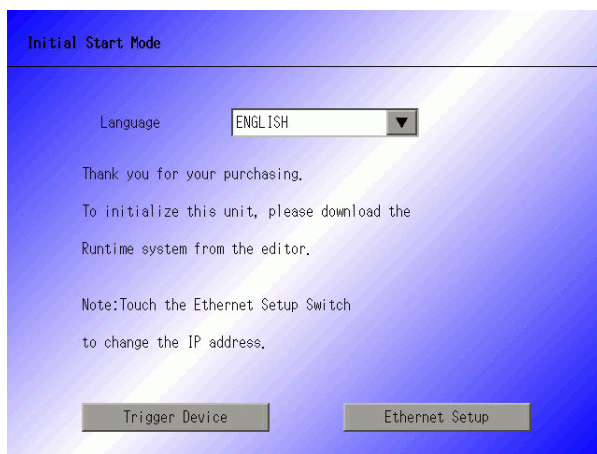

4 On the GP-Pro EX state tool bar, click the Transfer Project icon . The [Transfer Tool] dialog appears.

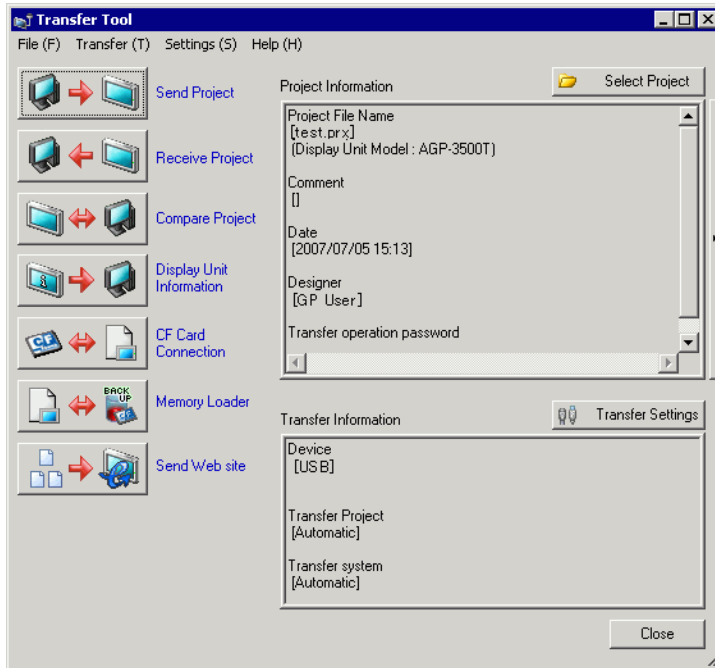

5 Click [Transfer Settings]. The following dialog box appears. Ensure that [Communication Port Settings] is set to [LAN]. Select the [LAN Auto Setting] check box and click [OK].

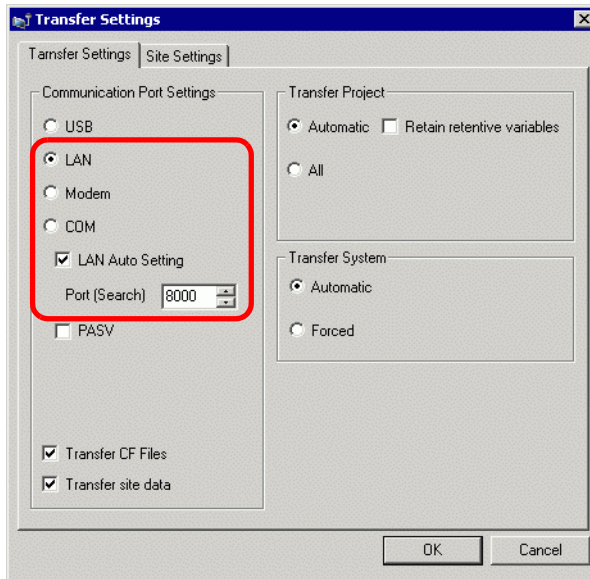

You can also open the dialog box on the [Project (F)] menu by pointing to [Transfer Project (G)] and selecting [Transfer Settings (C)].

6 Click [Send Project]. The [Select Main Unit] dialog box displays the IP addresses of the GPs available on the network. The transfer begins. When multiple IP addresses are checked, the project is sent to multiple GPs at once.

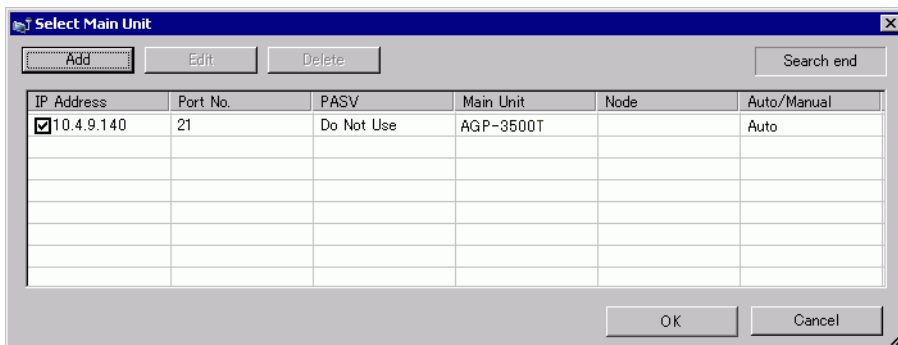

**NOTE**

- If the GP's IP address and subnet mask have changed, data can not be retrieved. Ensure that you update these items in the PC settings.

The following dialog box appears during transfer to check the communication status. During the transfer, the GP changes to Transferring mode and communication with the device/PLC is suspended.

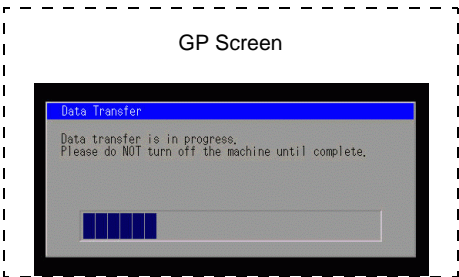
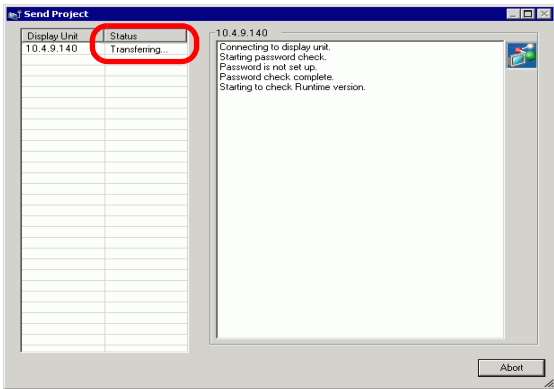





## 33.4 Comparing Project Changes Prior to Transfer

### 33.4.1 Introduction

Compares projects currently open in GP-Pro EX (or selected projects) with those stored on the GP. This is useful for confirming which screens you updated before transferring the file.

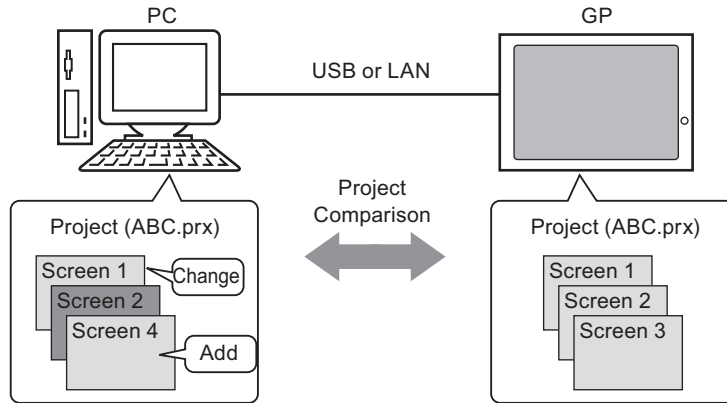

The comparison displays the following information:

- Screen numbers are the same, and screen contents are different. The screen is updated on the GP.
- Screen(s) exist only on the PC      The screen is added to the GP
- Screen(s) exist only on the GP      The screen is deleted from the GP

**NOTE**

- You can only run a comparison for one GP at a time, even when connected on a LAN.

### 33.4.2 Comparison Procedure

Compares the project currently open in GP-Pro EX to that stored on the GP connected through LAN.

**NOTE**

- Please refer to the Settings Guide for details.  
 ☞ "33.10 Setting Up Transfer Tool" (page 33-58)

1 On the GP-Pro EX state tool bar, click the Transfer Project icon . The [Transfer Tool] dialog appears.

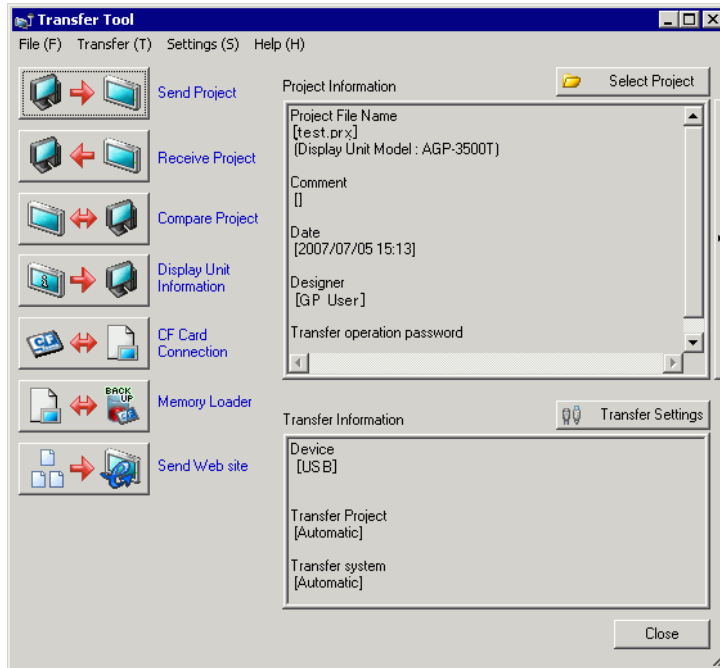

- 2 Click [Transfer Settings] to display the [Transfer Settings] dialog box. Ensure that [Communication Port Settings] is set to [LAN]. Select the [LAN Auto Setting] check box and click [OK].

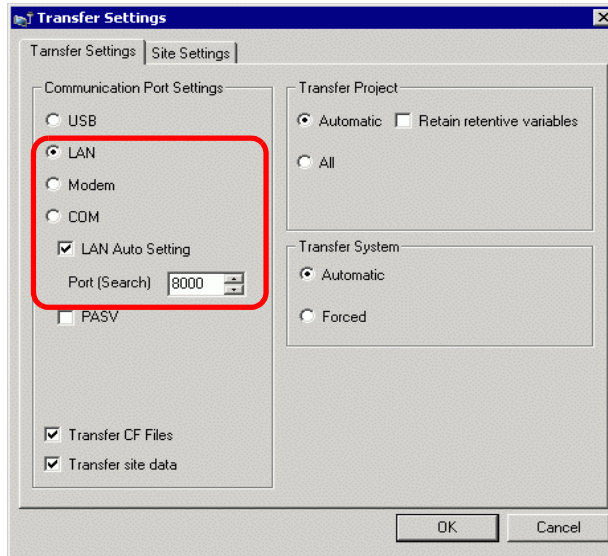

- 3 Select each IP address of the GP to compare project data and click [OK].

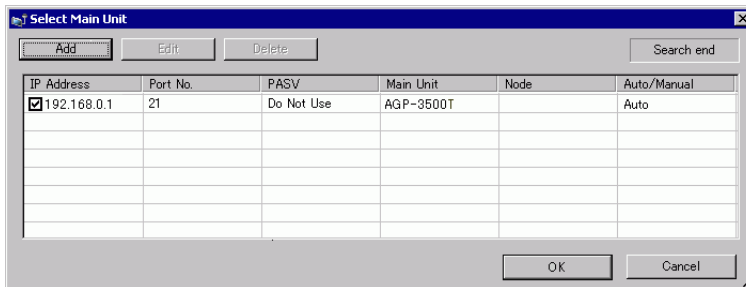

- 4 The following [Comparison] dialog box appears and displays the results of the comparison between the PC and GP.

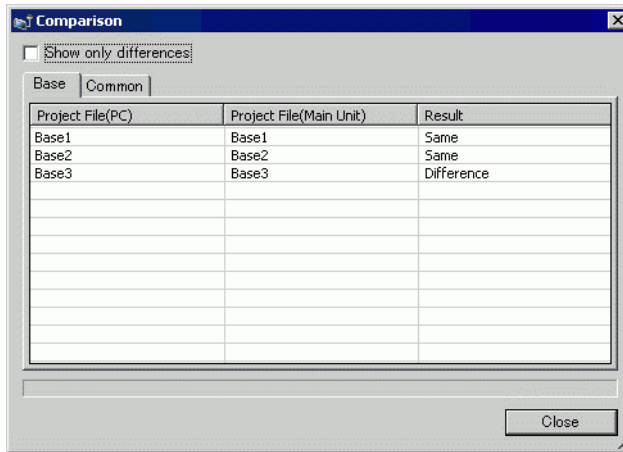

**NOTE**

- Select the [Show Only Differences] check box. The comparison results show screens that are different.
- The following messages appear when there are no differences in projects and when the projects are different.

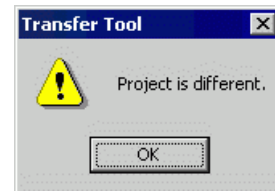

- 5 After confirming the results, click [Close].

## 33.5 Transferring Only Data to a CF Card

### 33.5.1 Introduction

Use the [CF Card Connection] feature on a PC to check data currently stored in the CF Card on the GP, copy data between the CF Card folder and the CF Card, to delete the data in a CF Card, or to change a file name.

- Data copy

You can copy Recipe and image data from the CF Card folder to the CF Card without transferring the project.

You can also copy alarm and sample data stored in the CF Card to the PC.

For example, Copy created Recipe data (ZR00000.csv) to the CF Card

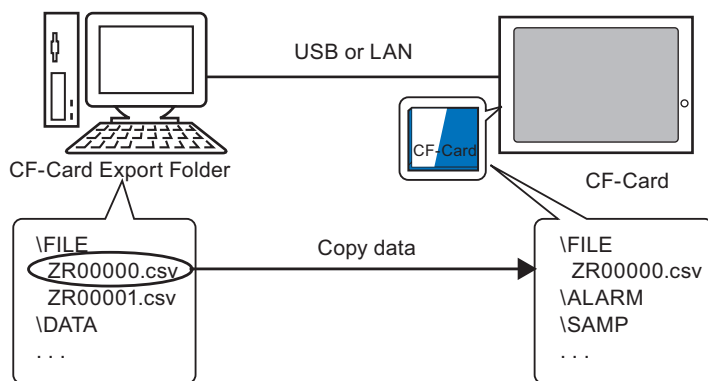

- Delete CF Card data

You can delete data in the CF Card in the GP.

For example, Delete CF Card Alarm data (Z100000.csv)

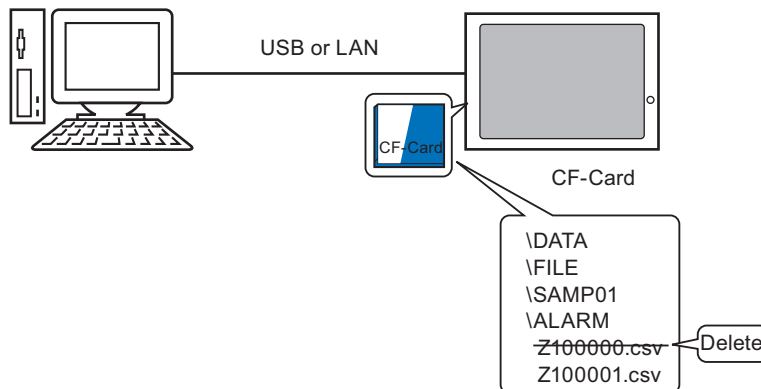

### 33.5.2 Transfer Process

Copy the recipe data (ZR00000.csv) in the CF Card Folder to the CF Card in GP.

**NOTE**

- Please refer to the Settings Guide for details.  
 ↳ "33.10 Setting Up Transfer Tool" (page 33-58)

1 On the GP-Pro EX state tool bar, click the Transfer Project icon . The [Transfer Tool] dialog appears.

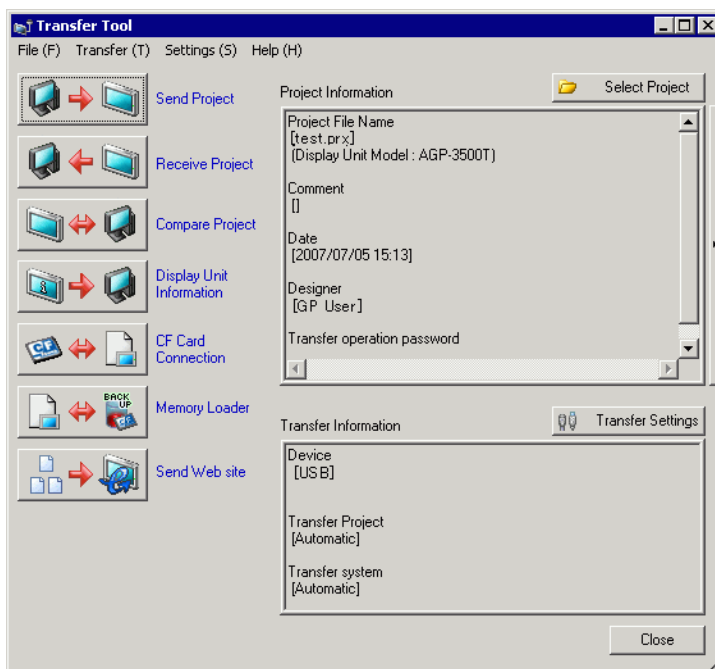

2 Click [CF Card Connection]. The following dialog box appears. Select [Connect Offline] and click [OK].

During the transfer, the GP changes to Transferring mode and communication with the device/PLC is suspended.

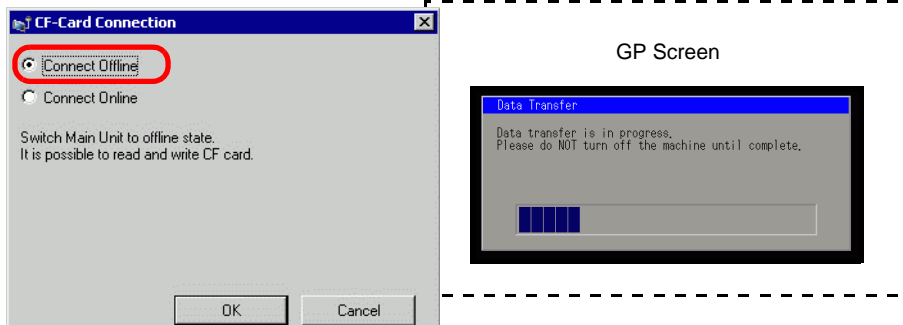

**NOTE**

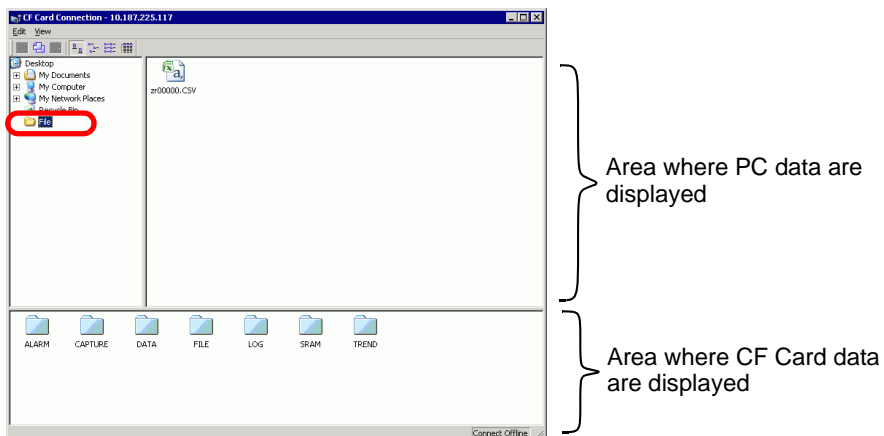

- When [Connect Online] is selected, you can only read data on the CF Card. You cannot copy, delete, or move CF Card data.

- 3 When the CF Card connection tool starts, select the **FILE** folder from the folder list on the left. The data in the folder is displayed on the right side.



- 4 Select the Recipe data (ZR00000.csv) from the data displayed on the right-hand side, then drag it to the lower CF Card area.

**NOTE**

- You can also select the recipe data (ZR00000.csv), click  to copy, then click  in the CF Card area to paste.

- 5 Close the tool with .  
Click [Close] again to close the Transfer Tool.

## 33.6 Transferring with Passwords

### 33.6.1 Introduction

You can protect the sending and receiving of projects by setting a password. Requiring a password prevents the transfer if passwords do not match. This feature is a security measure to allow only specific persons to transfer data.

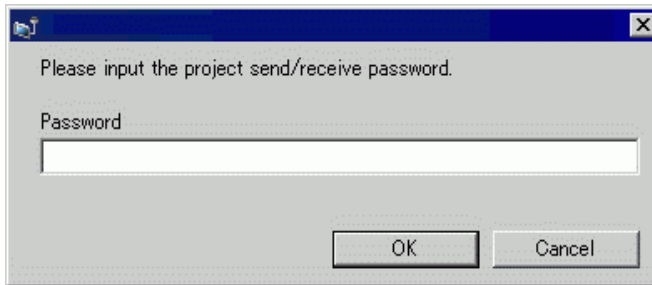
**IMPORTANT**

- Do not forget the password as you will not be able to transfer data without it.
- If an incorrect wrong password is entered three times, the transfer is canceled.

**NOTE**

- If a Password Input window remains on the screen for 5 minutes without any input, an alarm message appears. After another 5 minutes, a time-out occurs and the transfer is forcibly canceled.
- Passwords also apply when comparing projects and transferring data to and from the CF card.



### 33.6.2 Setup Procedure

Set a password.

**IMPORTANT**

- Do not forget the password as you will not be able to transfer data without it.

1 On the [Project (F)] menu of GP-Pro EX, point to [Information (I)] and select [Project Information (I)].

The [Project Information] dialog box appears.

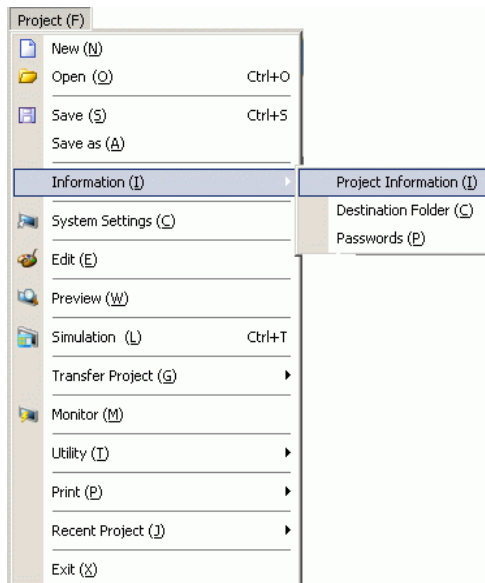

2 Select [Passwords] from the item list on the left-hand side.

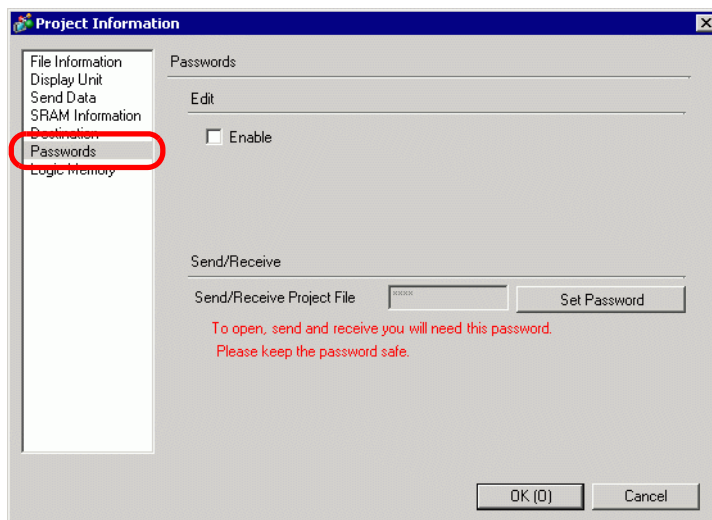

3 Under [Send/Receive], click [Set Password]. The following dialog box appears.

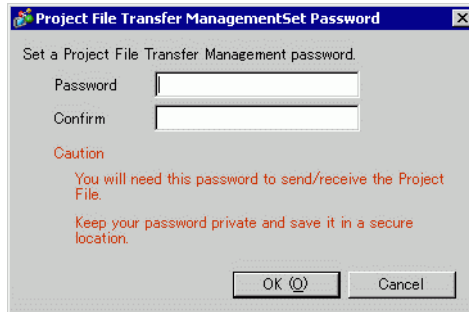

4 Enter a password up to 24 single-byte characters.

Confirm the password.

5 Click [OK].

### 33.6.3 Passwords Remove/Change

Removes a previously set password.

- 1 On the [Project (F)] menu of GP-Pro EX, point to [Information (I)] and select [Project Information (I)].

The [Project Information] dialog box appears.

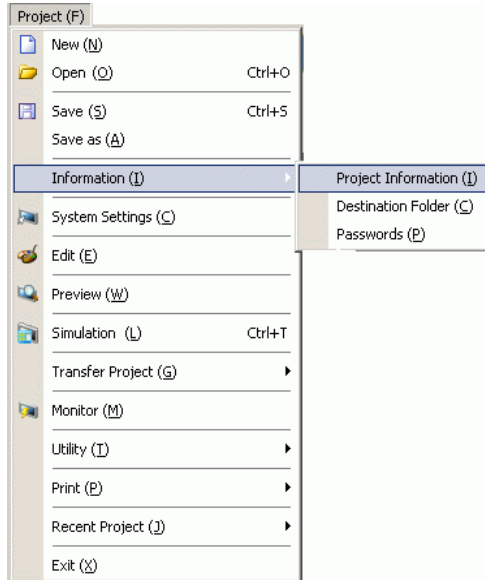

- 2 Select [Passwords] from the item list on the left-hand side.

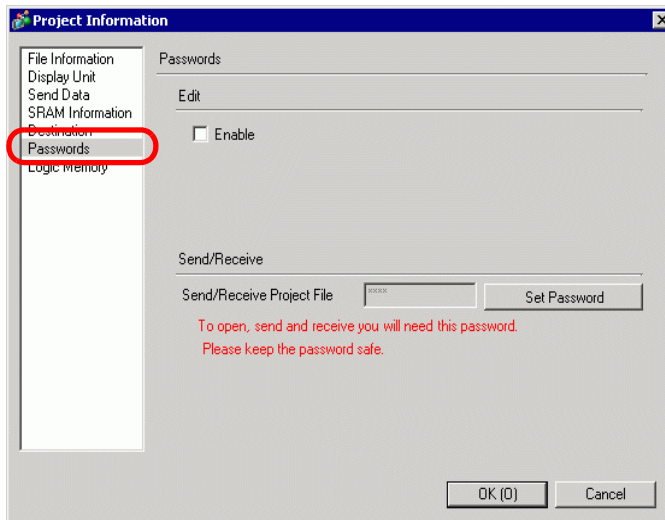

3 Under [Send/Receive], click [Set Password]. The following dialog box appears.



4 Enter the currently set password.

5 Leave the [Password] and [Confirm] fields blank and click [OK]. The password is reset.

---

**NOTE**

- To change the password, enter the new password in the second [Password] field, then enter the same password in the [Confirm] field and click [OK].
-

## 33.7 Transferring Project Files Using a CF Card or USB Storage

### 33.7.1 Introduction

Without connecting USB or Ethernet cables, you can transfer project files between the GP and your PC using an external memory such as a CF Card or USB storage device. You can also use the external memory to copy project files from one GP to another.

- Transfer from PC to GP

On the GP, downloads and displays the project backup data stored on a CF Card or USB storage device.

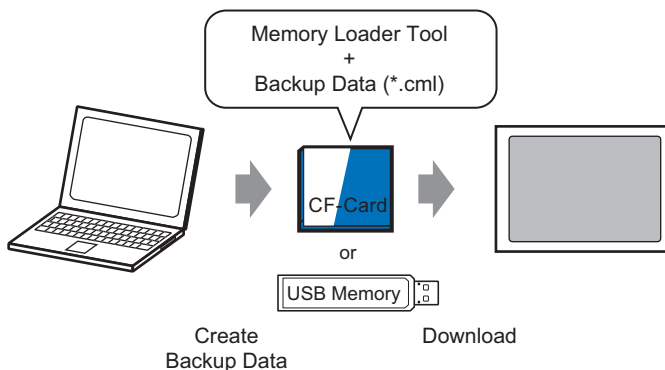

- Transfer from GP to PC

Uploads the backup data from the GP to a CF Card or USB storage device and loads the data to the PC as a project file. You can also download and display the backup data on a different GP.

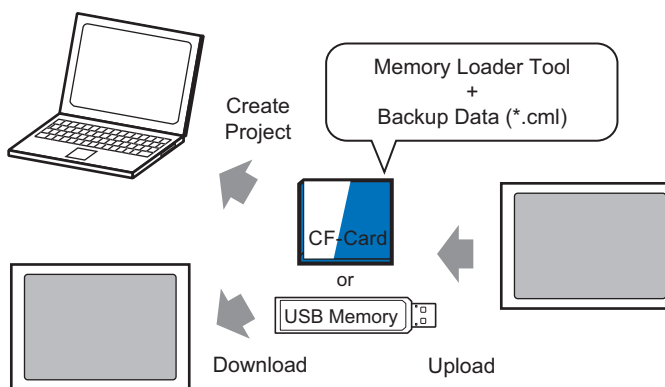

**IMPORTANT**

- To backup (upload) the project on the GP or start (download) the project from the backup data on a CF Card, the special Memory Loader Tool must also be copied to the CF Card. To backup the project on a USB storage device, a different Memory Loader Tool specific for USB storage devices must be copied to the USB storage device.
- Once the data is saved in the CF Card folder, you cannot use the data in USB storage. Similarly, once the data is saved in the USB destination folder, you cannot use the data on a CF Card.

### 33.7.2 Transfer Process

- NOTE**
- Please refer to the Settings Guide for details.  
 ☞ " ■ [Memory Loader] Settings Guide" (page 33-67)

#### ■ Transferring Project Files from PC to GP

Create project backup data on a CF Card and start the project from the CF Card (or USB memory) on the GP. When you create backup data on your PC, the "memory loader tool" is automatically saved on the CF Card (or on the USB storage). This tool is necessary for starting up projects on the GP.

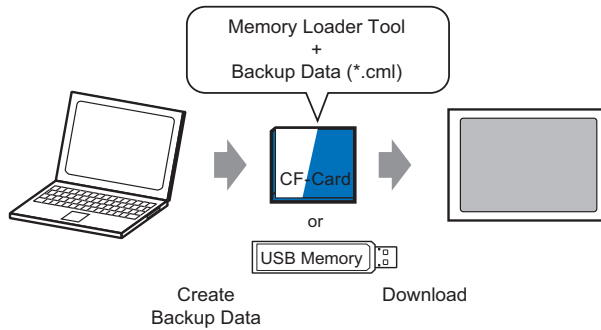

- IMPORTANT**
- You need to format (initialize) the CF Card and USB storage device in FAT.
  - You can initialize the CF Card in GP. For initializing, see "2.7. Initialization of the memory/CF Card" in "Maintenance/Troubleshooting."7

The following shows the process for using a CF Card. To use USB Storage, replace "CF Card" with "USB storage" in the process.

- 1 On the GP-Pro EX state tool bar, click the Transfer Project icon  to launch [Transfer Tool].

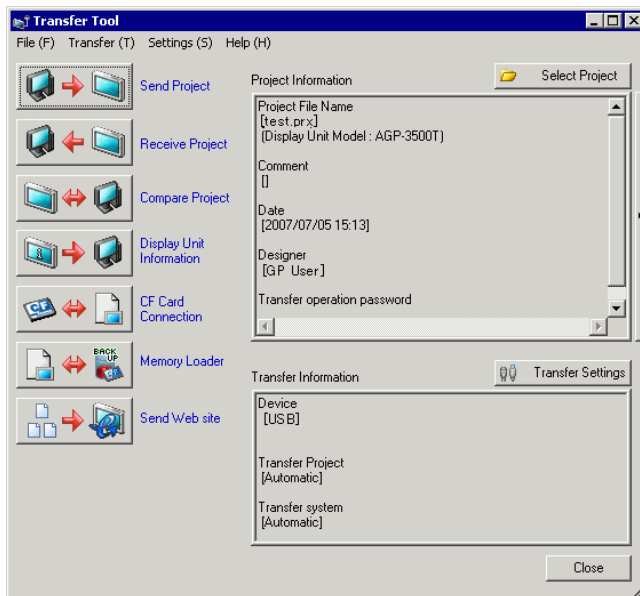

2 In [Select project], select the project you wish to transfer.

3 Click [Memory Loader] to open the following dialog box. Click [Create Backup File].

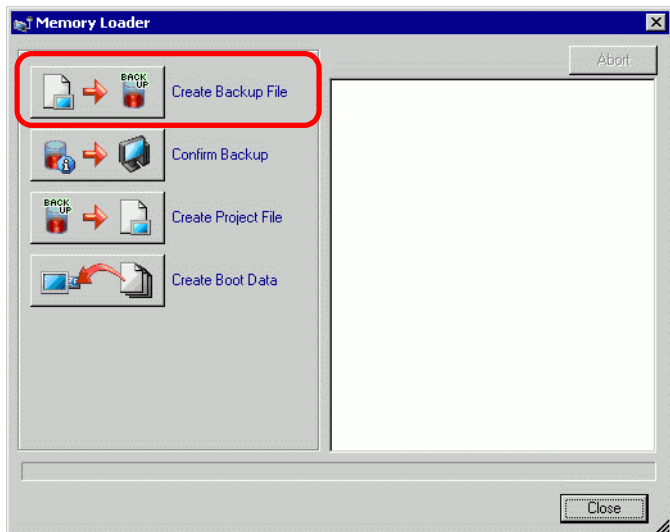

4 Select [CF Card] and click [Browse].

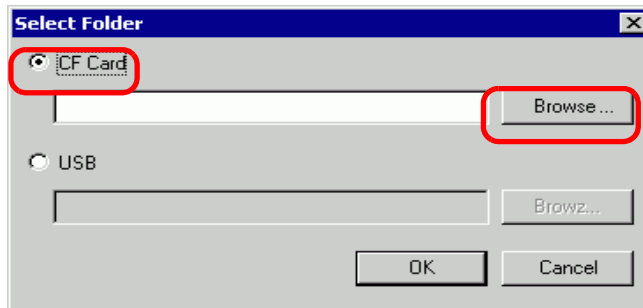

**NOTE**

- When you have selected [CF Card], the folder selected in the [Select Folder] dialog box appears.  
☞ "5.7.2 Setup Procedure ■ Setting the Destination Folder" (page 5-53)

- 5 In the [Browse For Folder] dialog box, specify the CF Card folder for the destination and click [OK].

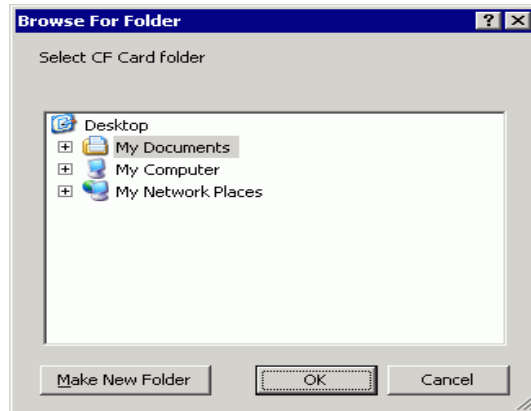

- 6 In the [Select Folder] dialog box, click [OK] to start creating data.  
While creating data, the following dialog box appears to show the creation status.

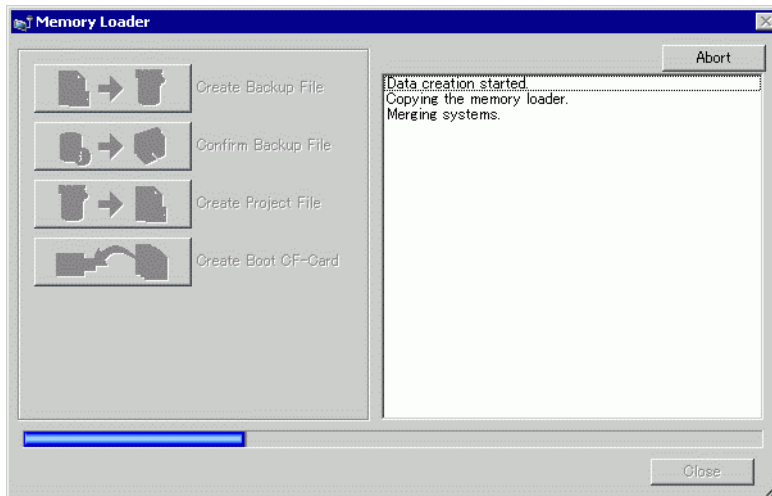



7 When the message "Data Creation Ended" appears, click [Close].

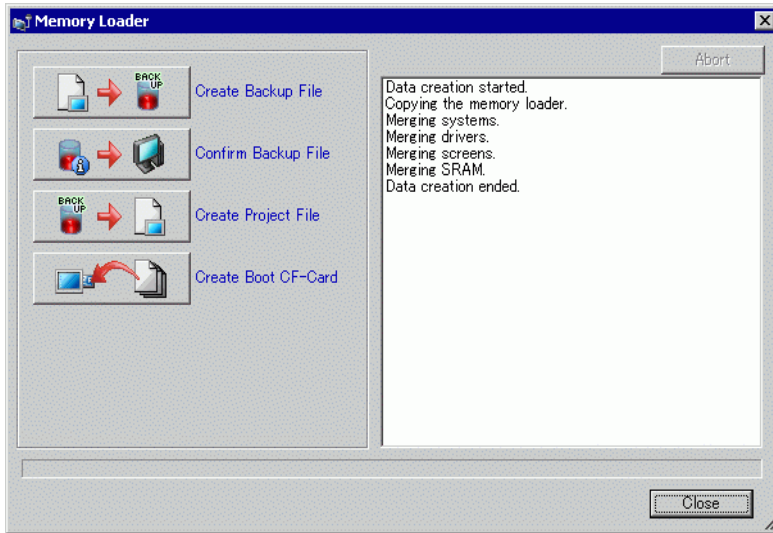

8 Copy or move all data created in the CF Card folder to the CF Card. The data, project backup data, and the CF Card Memory Loader Tool are all transferred to the CF Card.

9 Insert the created CF Card in the GP.

Touch the top right corner -> bottom left corner (or top left corner -> bottom right) on the GP screen in this order within 0.5 seconds and switch to offline mode.

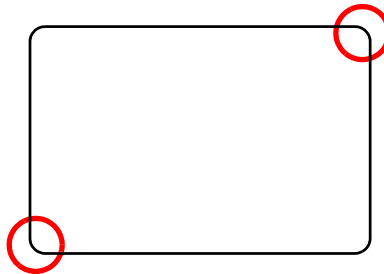

**NOTE**

- To start the CF Card, you can either use the system menu or the DIP switches on the back of the GP. Turn the GP power OFF, turn ON DIP switch 1, and then turn the GP power back ON to launch the Memory Loader tool. You cannot use the DIP switches to start the CF Card when using USB Storage.
- To transfer project data to the GP for the first time (for a newly purchased GP), the [Initial Transfer Mode] screen appears when you turn the power ON.

10 Touch [CF/USB]. Touch [CF startup] to reset GP.

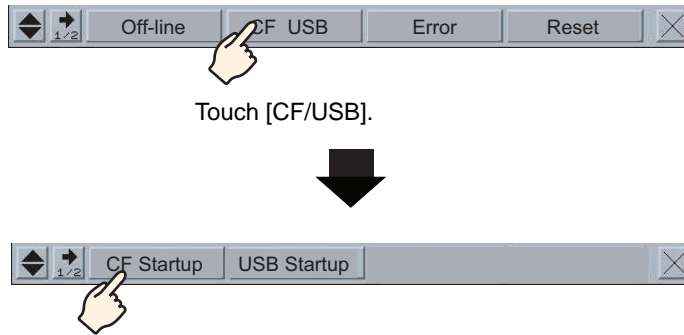

11 The Memory Loader Tool launches. The following screen opens. Touch [Download].

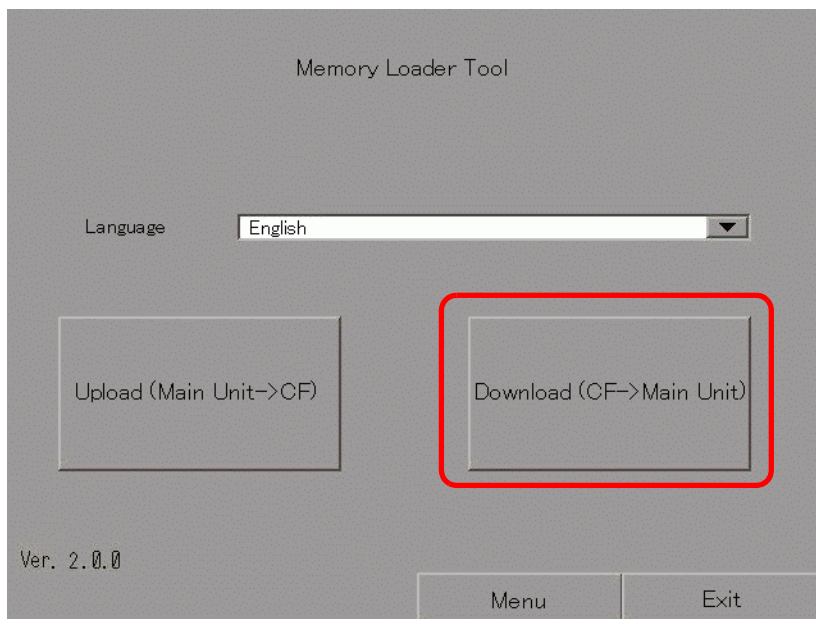

- 12 In [Select File], select a file you want to transfer and touch [Start]. If there is a password for transferring, input the password first, then touch [Start].

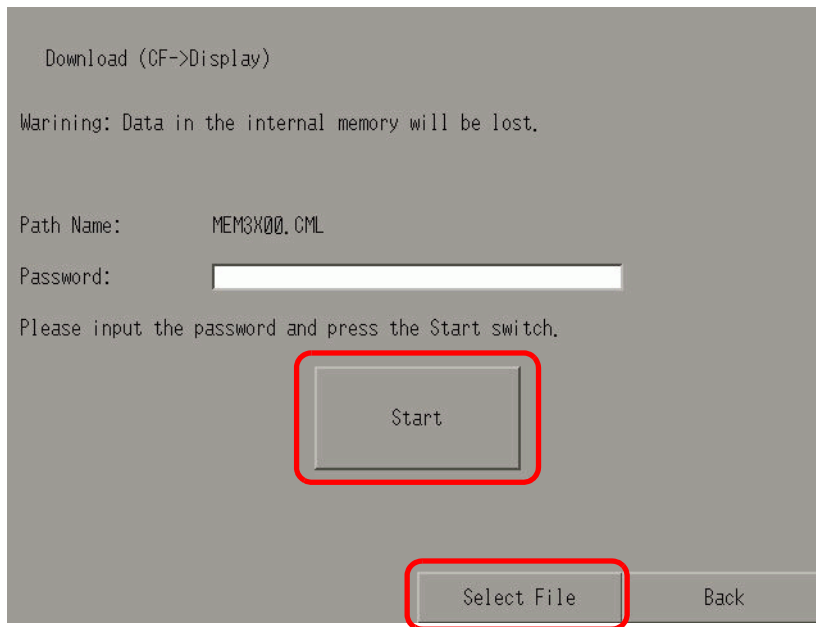

---

**IMPORTANT**

- Once you start downloading, all project data on the GP is deleted, including the data in the backup SRAM.
- If you performed CF Start with the DIP switch, turn the Number 1 DIP switch back OFF.

- 
- 13 Once downloading is complete, touch [Back] and then [Exit] to exit the Memory Loader Tool.

## ■ Transferring Project Files from GP to PC (or to Another GP)

Backup (upload) the project on the GP to a CF card or USB storage. The backup data (\*.cml) can be converted into a project file (\*.prx) and edited on a PC. You can also download and display the backup data on a different GP.

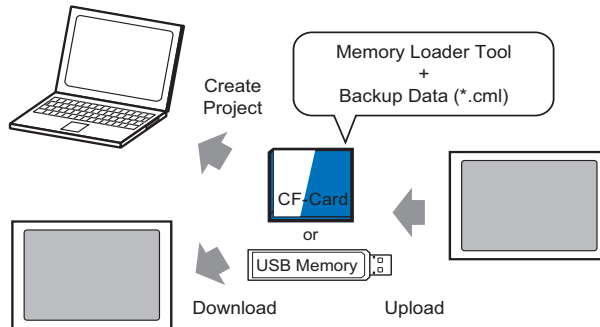

**IMPORTANT**

- You need to format (initialize) the CF Card and USB storage device in FAT.
- You can initialize the CF Card in GP. For initializing, see "2.7. Initialization of the memory/CF Card" in "Maintenance/Troubleshooting."7

## ◆ Create a startup CF Card/USB

The Memory Loader Tool must be installed on the CF Card or the USB storage device when you want to either: upload a backup project from the GP to a CF Card or a USB storage device; or download a backup project from the CF Card or USB storage device.

- 1 To launch the [Transfer tool], click the Transfer Project icon on the GP-Pro EX status tool bar. 
- 2 Click [Memory Loader]. The following dialog box appears.
- 3 Click [Create Boot Data]. The memory loader tool will be created in the CF Card/USB destination folder you specified.

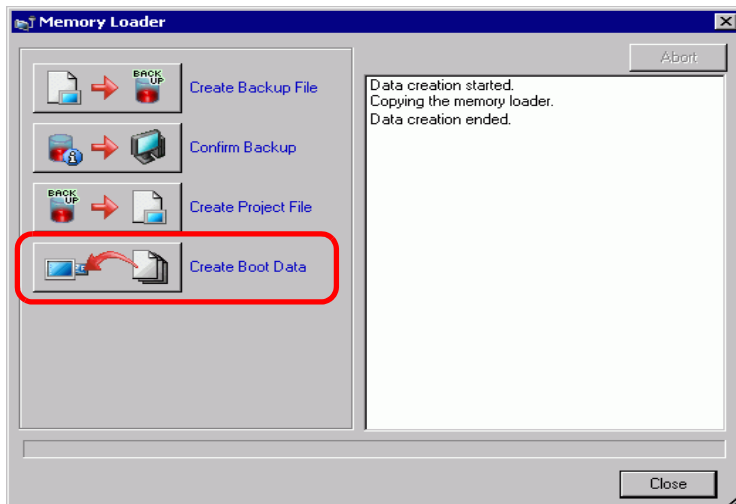

4 Move or copy all the created data to the CF Card/USB storage. The CF Card/USB storage device is now ready.

### ◆ Transfer (GP → CF Card → PC)

The following shows the process for using a CF Card. To use USB Storage, replace "CF Card" with "USB storage" in the process.

1 Insert the CF card with boot data.

To display the system menu, within 0.5 seconds of each touch, touch the top-right then the bottom-left corner, or touch the top-left then bottom-right corner.

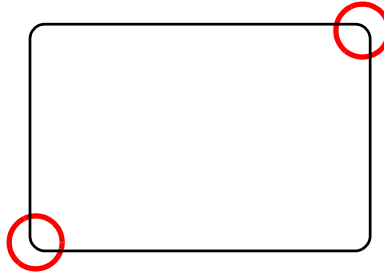

2 Touch [CF/USB]. Touch [CF startup] to reset GP.



Touch [CF/USB].



3 The Memory Loader Tool launches. The following screen opens. Touch [Upload].

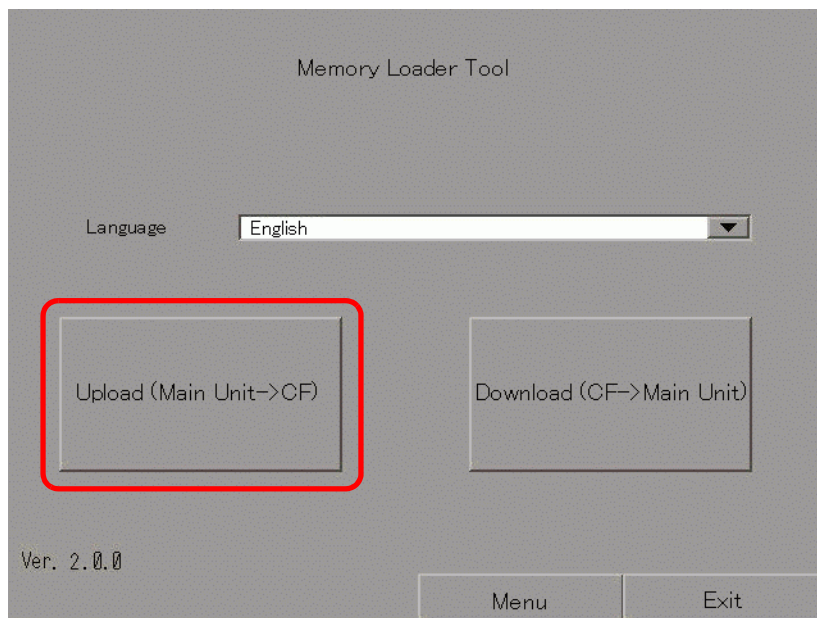

4 Touch [Start] to begin saving the GP project as backup data (\*.cml). If there is a password for transferring, input the password first, then touch [Start].

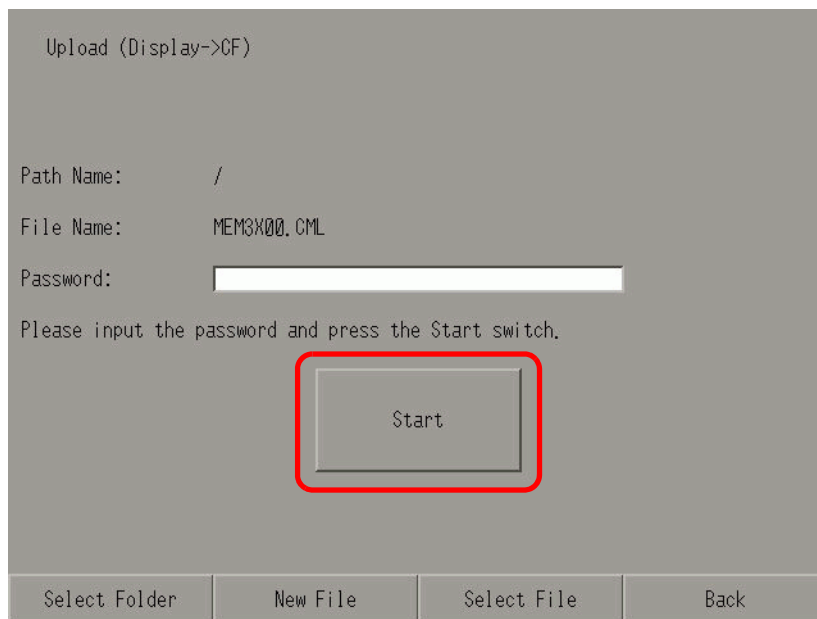

**NOTE**

- Backup data is saved as displayed in the [File Name] field. If you are using AGP-3500T, by default this is "MEM3X00.CML." If you want to use another file name, touch [New File]. To overwrite an existing file name in the CF Card, touch [Select File].

5 Once upload is complete, touch [Back] then [Exit] to close the Memory Loader Tool.

6 Remove the CF Card from the GP and insert it into the PC.

7 On the GP-Pro EX state tool bar, click the Transfer Project icon  to launch [Transfer Tool].

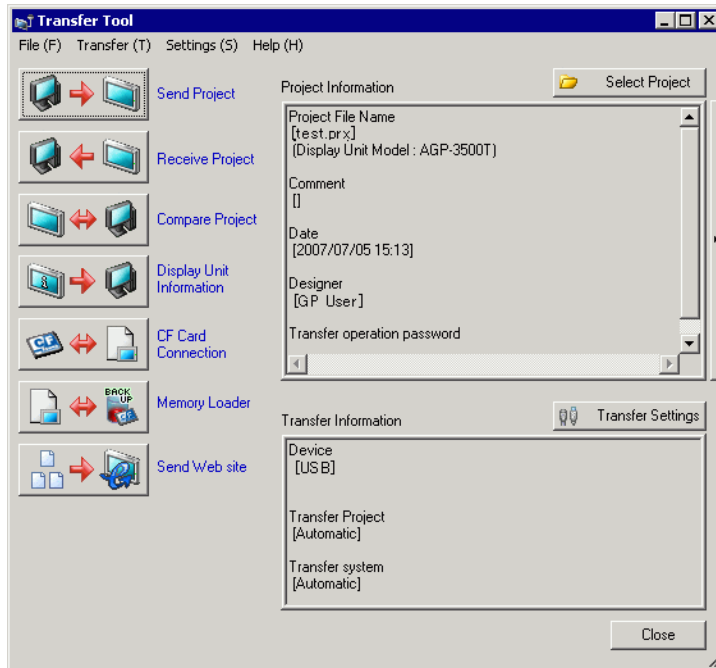

8 Click [Memory Loader]. The following dialog box appears. Click [Create Project].

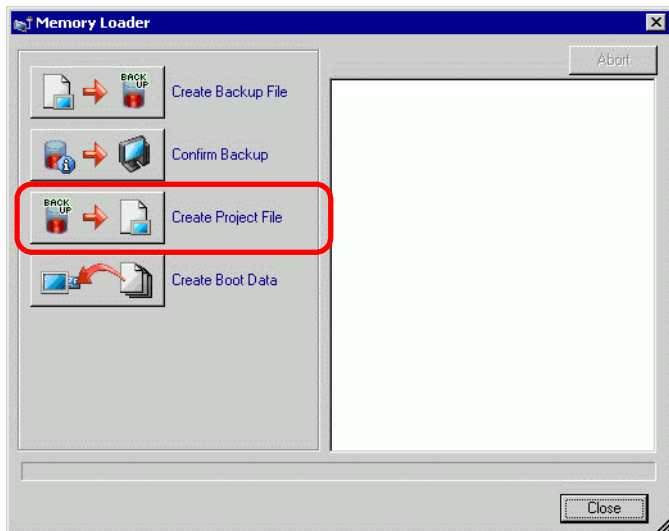

9 In the following dialog box, select the CF Card in the [Look In] field. Select the backup file (\*.cml) to convert to a project file (\*.prx) and click [Open].

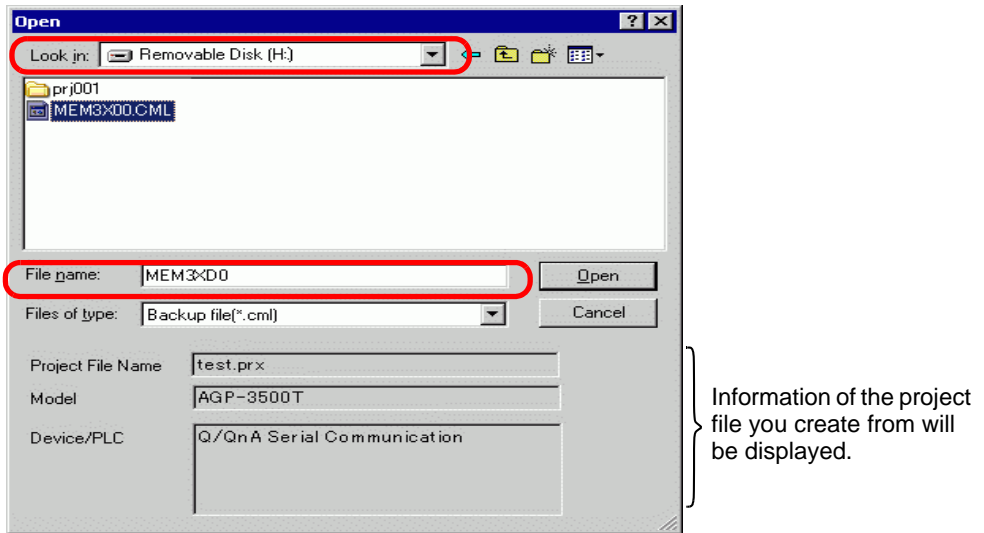

10 Enter the name and the location of the project file you are going to create and click [Save].

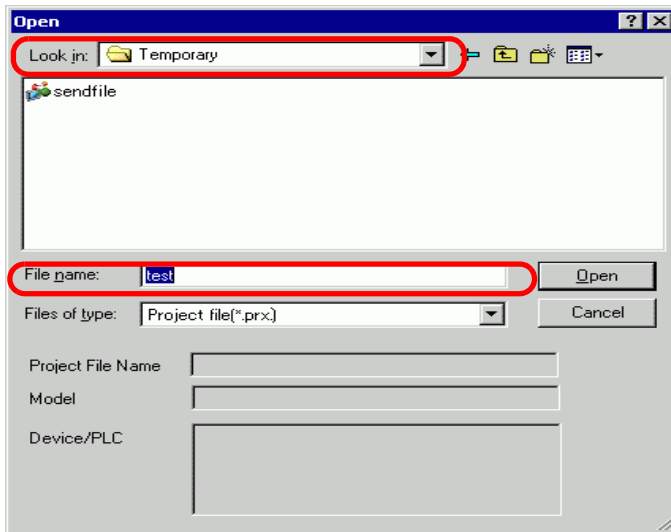



11 Confirm the information in the [Project Create] dialog box, and then click [Create].

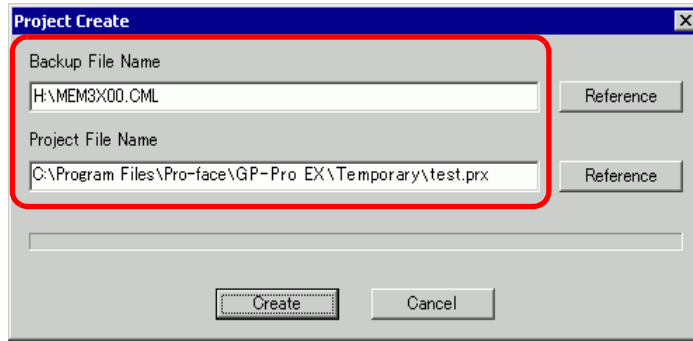

**NOTE**

- Click [Browse] to edit the settings of the backup file or the project file.

12 The following dialog box appears.

When the message "Creating project files complete" appears, click [Close].

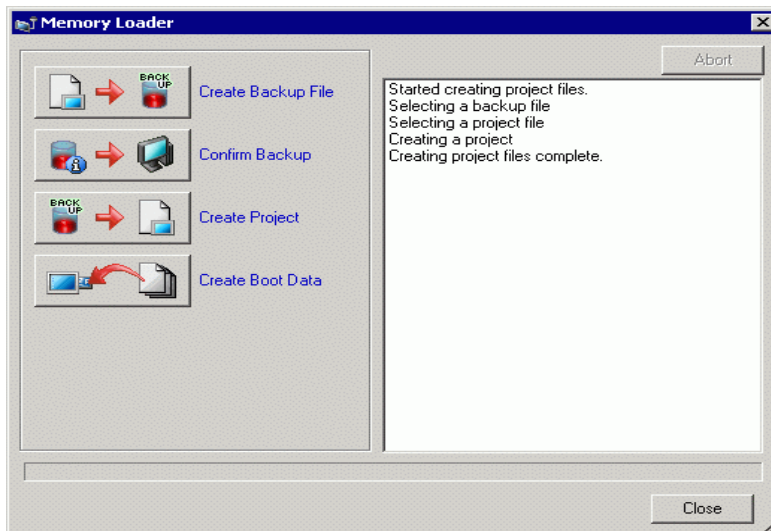

## 33.8 Updating Remote Screen Data via Modem

### 33.8.1 Introduction

Using a modem to transfer screen data from the PC to a remote GP. You can also use a modem to transfer from the GP to a PC.

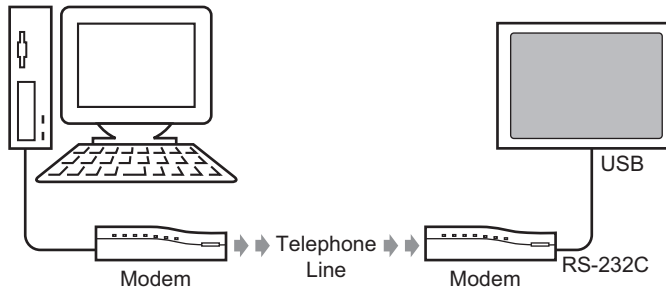

---

**NOTE**

- In this transfer, you can only transfer screen information of the project file. You cannot transfer all projects or the system.
  - To connect the GP to a modem, use "CA6-USB232-01", a USB-Serial (RS-232C) conversion cable manufactured by Pro-face (sold separately). The following conversion cable can also be used:  
Manufacturer: IO Data Device, Inc. Model: USB-RSAQ3
-

### 33.8.2 Transfer Process

Connect a modem to your PC and GP to transfer the screen data from your PC to GP.

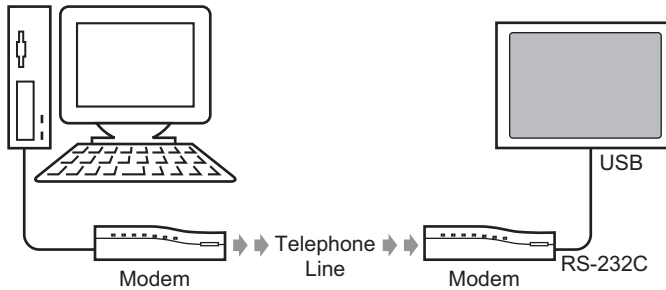

**NOTE**

- Ensure the PC has the proper communication settings for the modem. In the Windows® [Control Panel], set up the [Phone and Modem Options].
- To connect the GP to a modem, use "CA6-USB232-01", a USB-Serial (RS-232C) conversion cable manufactured by Pro-face (sold separately). The following conversion cable can also be used:  
 Manufacturer: IO Data Device, Inc. Model: USB-RSAQ3

1 On the GP-Pro EX state tool bar, click the System Settings icon . When the [System Settings] window appears, click [Modem].

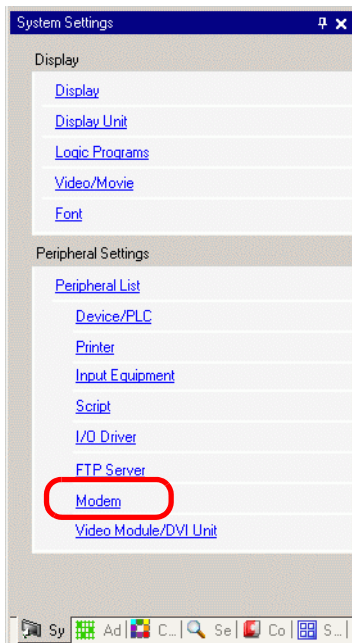

**NOTE**

- If the [System Settings] tab is not displayed in the workspace, on the [View (V)] menu, point to [Workspace (W)], and then click [System Settings (S)].

- 2 Select the modem communication speed. The modem settings for GP-Pro EX are now complete.

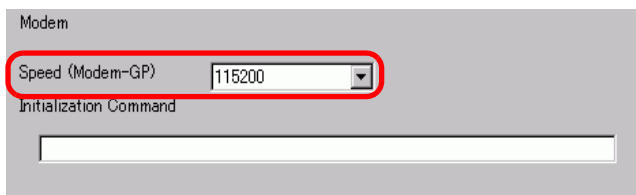
**NOTE**

- For the proper modem settings, please read the manual of the modem.

- 3 From the [Project (F)] menu, select [Transfer Project (G)] or click  from the tool bar.
- 4 Click [Transfer Settings] and the following dialog box will appear. In the [Communication Port Settings] select [Modem].

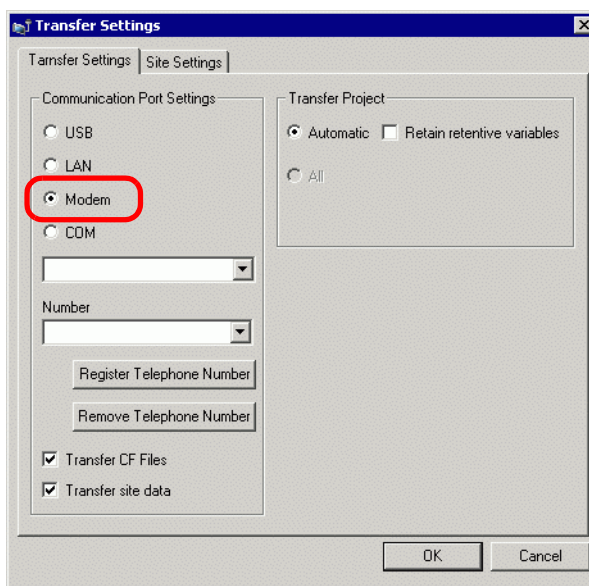

- 5 Select the modem. You can confirm which modems are set up on the PC from the Device Manager dialog box in the Windows Control Panel. Enter the telephone number of the modem connected with the GP in the [Number] field.
- 6 If you don't need to transfer data in the CF Card Folder to the CF Card in GP, clear the [Transfer CF Files] check box and click [OK].

7 Click [Send Project].

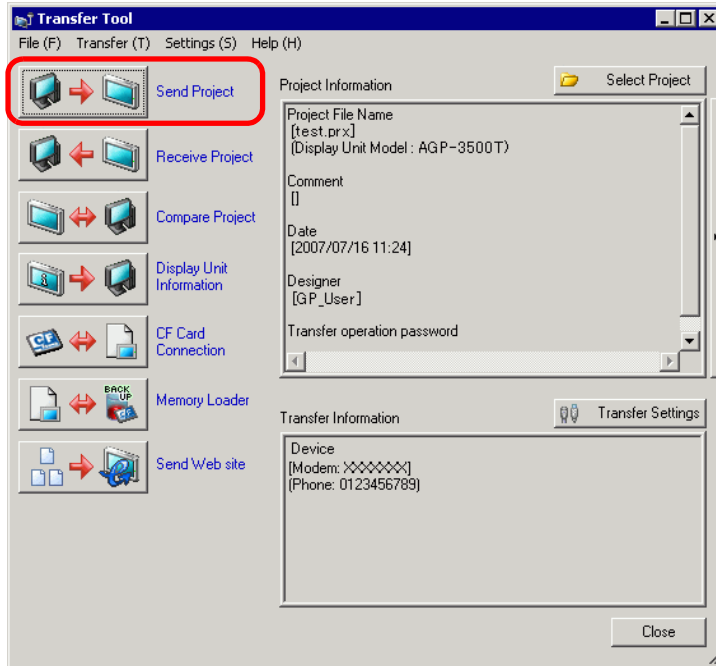

The following dialog box appears during transfer to check the communication status. During the transfer, the GP changes to Transferring mode and communication with the device/PLC is suspended.

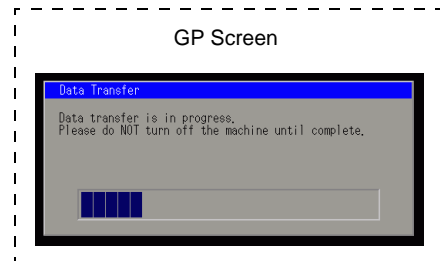
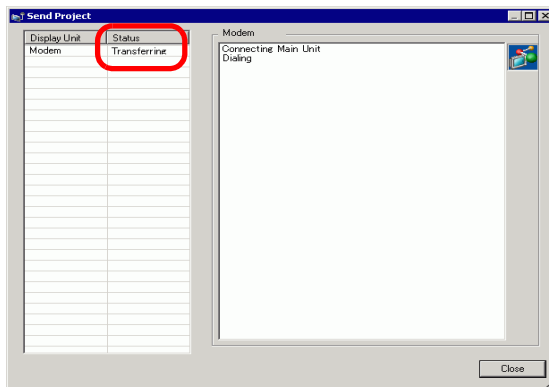

- 8 When the transfer finishes, the status changes from [Transferring] to [Transfer Complete]. Click [Close]. The GP is reset and the transferred screens are displayed.

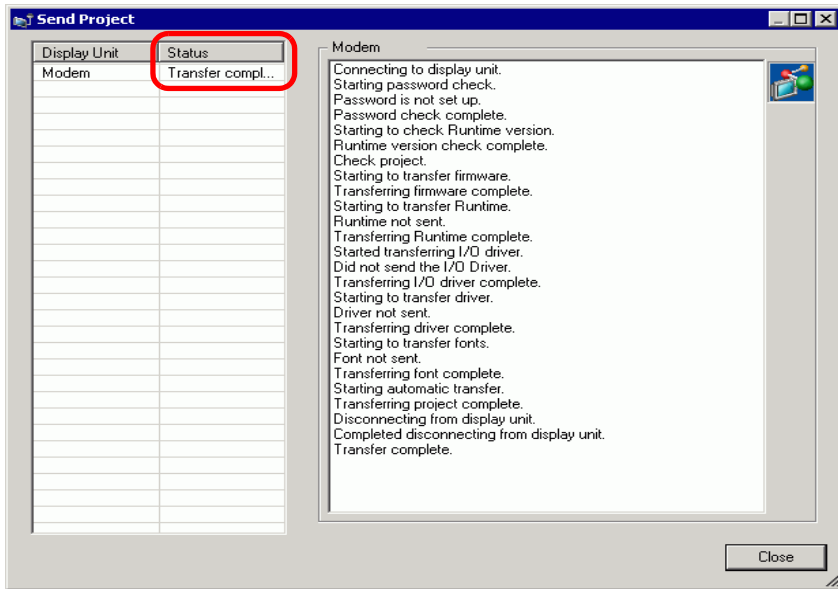

- 9 Click [Close] to return to the Transfer Tool. Click [Close] again to close the Transfer Tool.

## 33.9 Checking Errors

### 33.9.1 Introduction

Before sending the project file, ensure no errors exist in the screen settings and the logic program. This helps you avoid having to correct errors after the transfer.

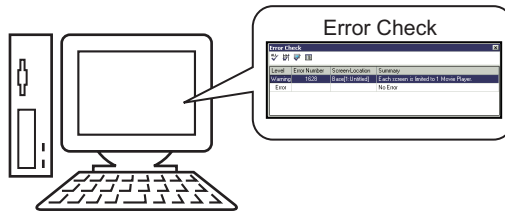

---

**NOTE**

- An automatic error check is performed when you transfer or save a project file.
-

### 33.9.2 Setup Procedure

**NOTE**

- Please refer to the Settings Guide for details.
  - ☞ "5.17.7 [Preferences] Settings Guide" (page 5-187)
  - ☞ "5.17.4 [Utility] Settings Guide" (page 5-116)

1 From the [View (V)] menu, select [Preferences (O)]. The following dialog box appears. On the left, select [Error Check] then select the [Display Warnings] check box. Click [OK].

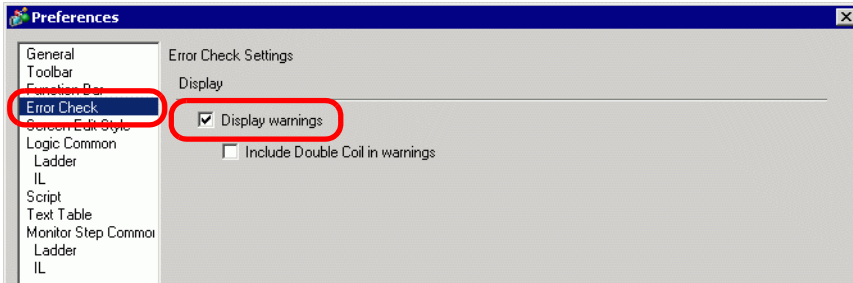

2 To start the error check, from the [Project (F)] menu point to [Utility (T)] and select [Error Check (E)], or click .

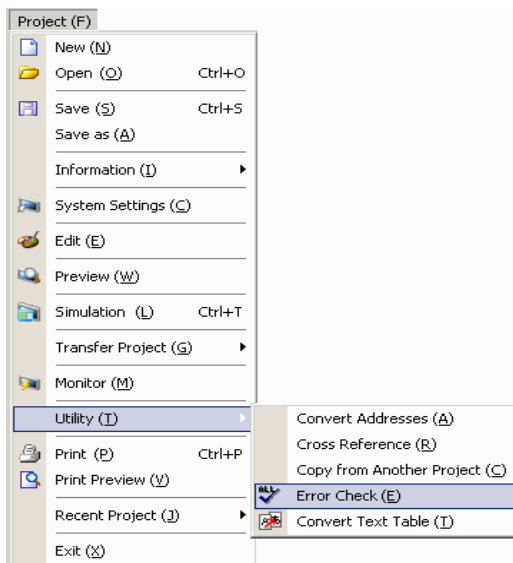

During the error check, the following dialog box displays, which closes when the check is complete.

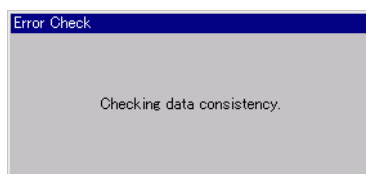



3 If there is an error or a warning, the following screen appears. [Check details in the [Summary] column.

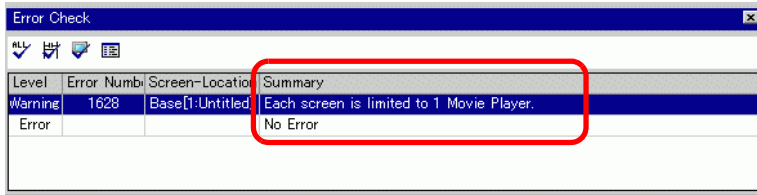

**NOTE**

- The Error Check window may be hidden. To display the window, while GP-Pro EX is in its initial state move your mouse to the bottom-left part of the application and click the [Error Check] tab.

4 Double-click on the selected line in the list to view the screen with the error.

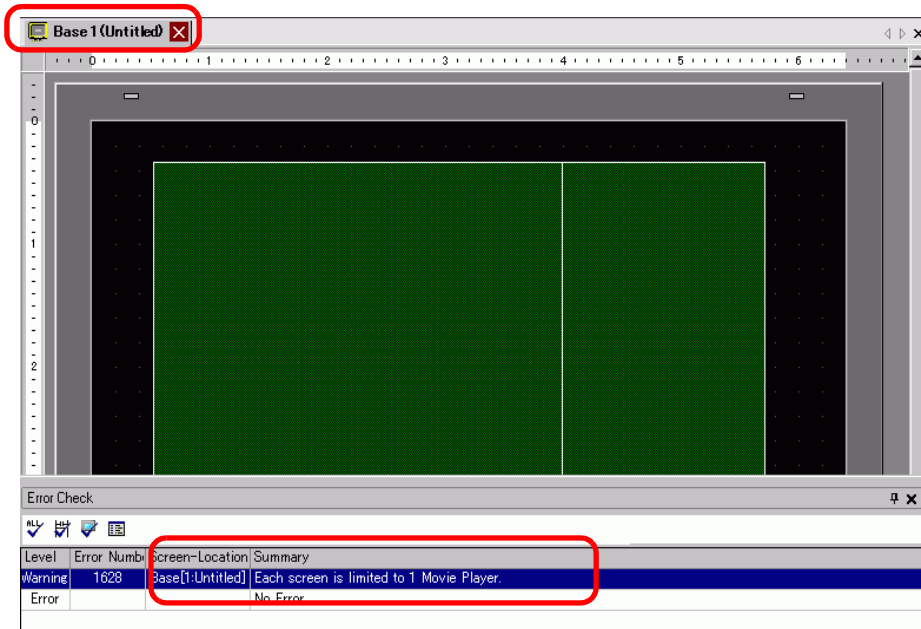

**NOTE**

- For errors in the logic program, see the following section.  
 ➔ "29.10 Logic Program Error Correction" (page 29-77)

5 Make corrections in the relevant areas and click to recheck errors. Once all the errors are fixed, the window appears as follows.

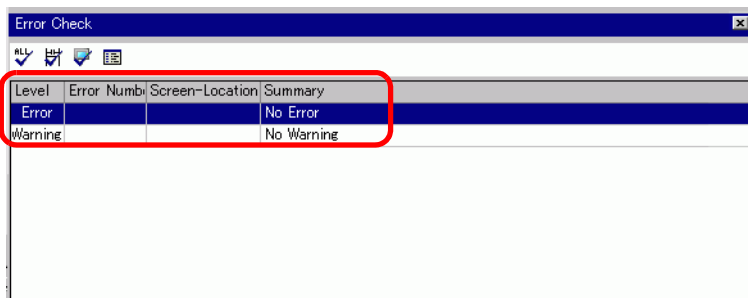

### 33.10 Setting Up Transfer Tool

The "Transfer Tool" transfers project data between a PC and the GP.

On the GP-Pro EX state tool bar, click the [Transfer Project] icon  or on [Project (F)] menu, point to [Transfer Project (G)] and select [Other Transfer (E)] to launch the transfer tool.

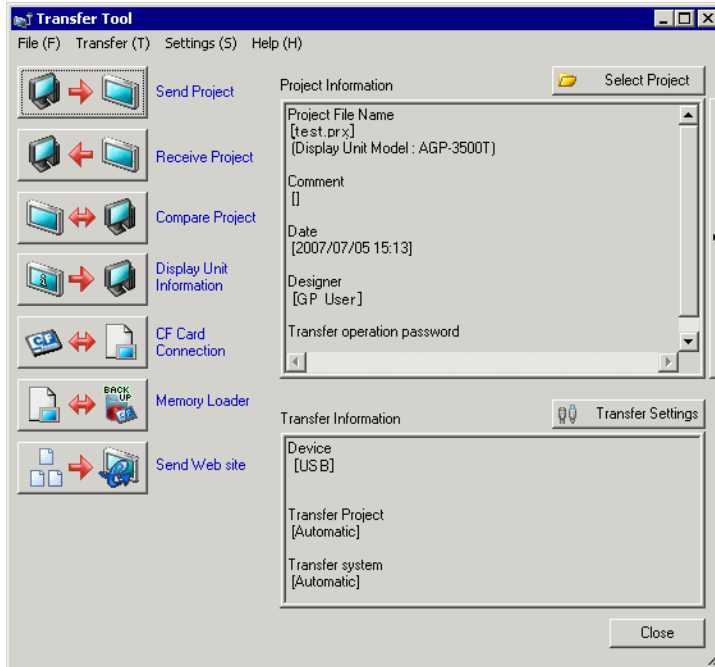

- NOTE**
- You can install the transfer tool without installing GP-Pro EX on your PC. This is useful when only transferring files on a PC other than the development PC (the PC used for screen creation).  
 ☞ "33.10.5 Installing the Transfer Tool" (page 33-72)

Setting	Description
Send Project	<p>Sends the project currently open in GP-Pro or the project selected in [Select project]) to the GP.                      If you have selected the CF Card folder for the project, the data in the CF Card folder is sent to the CF Card inserted in the GP. If you do not wish to send the data to the CF Card, clear the [Transfer data to CF Card] check box in [Transfer Settings].                      ☞ "33.10.3 How Sending Data Works" (page 33-70)</p> <p><b>IMPORTANT</b></p> <ul style="list-style-type: none"> <li>When a send occurs, data stored in GP's backup SRAM is deleted.</li> </ul>
Receive Project	<p>Project data stored in a connected GP is received and saved to the PC in the designated location as a new project file (*.prx).                      For projects using the CF Card, all data on the CF Card in the GP are received and saved in the destination location.                      ☞ "33.10.4 How Receive Works" (page 33-71)</p>

Continued

Setting	Description
Compare Project	<p>Compares the project currently open in GP-Pro EX or the project selected in [Select project] to the project stored on the connected GP and displays the results.</p> <p>For project set with the CF Card folder, the CF Card folder data and the data on the CF Card inserted in the GP are compared.</p>
Display Unit Information	<p>Reads and displays the system version, stored project information and screen information for the connected GP.</p> <p>System Version : Type and version of the display unit and version of the driver</p> <p>Project Information: Project file name, comment, date, creator</p> <p>Screen List : Screen number and type, comment, size, date</p>
CF Card Connection	<p>Tasks you can perform are different depending on the connection.</p> <div data-bbox="637 625 1002 886" style="border: 1px solid black; padding: 5px; margin: 10px 0;"> </div> <ul style="list-style-type: none"> <li>• <b>Connect Offline</b> While the CF Card is connected, the GP changes to Transferring mode and communication with the device/PLC is suspended. You can copy files between the CF Card Folder and the CF Card, delete and change names of the files.</li> <li>• <b>Connect Online</b> While the CF Card is connected, the GP continues to communicate with other devices/PLCs. You can check the CF Card information such as the file name, file size, and date.</li> </ul> <p><b>NOTE</b></p> <ul style="list-style-type: none"> <li>• GP is automatically disconnected from the CF Card 10 minutes after the last action.</li> </ul>
Memory Loader	<p>Open the [Memory loader] dialog box. This allows you to create and acknowledge the backup data and create project files from backup data.</p> <p>☞ " ■ [Memory Loader] Settings Guide" (page 33-67)</p>

Continued

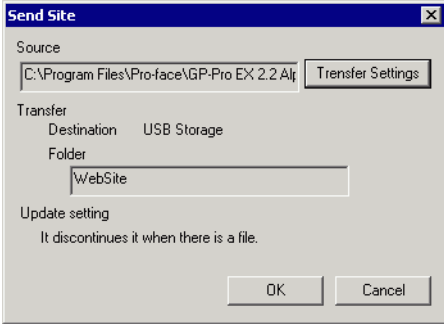
Setting	Description
Send Web Site	<p>Opens the [Send Web Site] dialog box. [Transfer Setting] and [Site Data Write Settings] fields display the [Second Web Site] contents. [The field displays the contents selected in the [Transfer Settings] dialog box.</p>  <ul style="list-style-type: none"> <li>• Source Click [Transfer Settings] to display the [Transfer Settings] dialog box's [Send Web Site] tab. ☞ " ■ Site Transfer Settings" (page 33-64)</li> </ul>
Select Project	Select the project file (*.prx) you want to transfer to the GP.
Project Information	<p>Information on the project currently open in GP-Pro EX (or the project selected in [Select project]) is displayed. Use [Select Project] to view project information of other projects.</p>
Transfer Settings	<p>Open the [Transfer Settings] dialog box. This allows you to modify the ports or transfer method. ☞ "33.10.1 [Transfer Settings] Settings Guide" (page 33-61)</p>
Transfer Information	<p>Displays setting information about the GP's currently selected communication port and transfer method. Change the [Transfer Settings] to update this information.</p>

### 33.10.1 [Transfer Settings] Settings Guide

On the [Project (F)] menu in GP-Pro EX, point to [Transfer Project (G)] and select [Transfer Settings (C)] or click [Transfer Settings] with the transfer tool to display the following dialog box.

#### ■ Transfer Settings

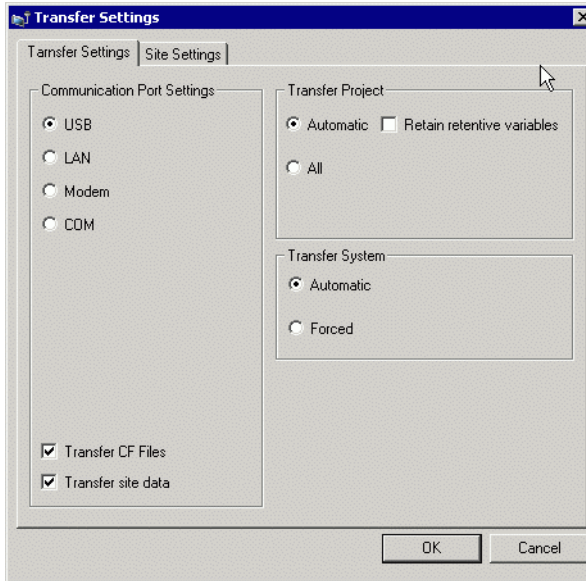

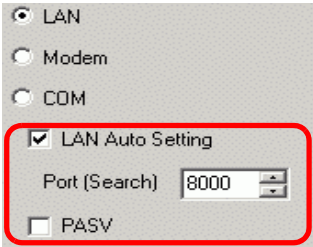
Setting		Description
Communication Port Settings	USB	Select when using a USB transfer cable to transfer screens.
	LAN	Select when using Ethernet (LAN) to transfer screens. 
	LAN Auto Setting	Select to automatically search all GPs on the network.
	Port (Search)	When [LAN Auto Setting] is designated, set the port number used during search.
	PASV	Select if [LAN] is selected but data cannot be transferred due to network security.

Continued

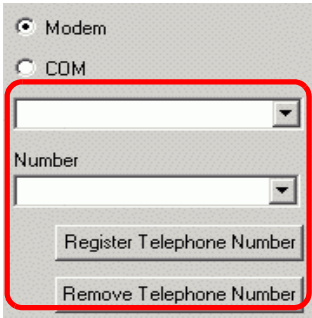
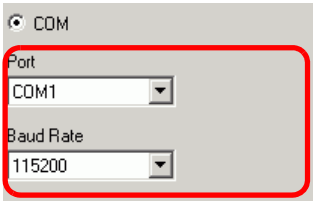
Setting		Description
Communication Port Settings	Modem	<p>Select this option to use a modem to transfer projects.</p> 
	Phone Number	Enter the phone number for the modem.
	Register Telephone Number	Registers telephone numbers. You can register up to 100 phone numbers.
	Delete Telephone Number	Delete registered phone numbers.
	COM	<p>Specify when transferring projects using a COM port.</p> 
	Port	Select the COM port to use from COM1 to COM9.
	Baud rate	Select the communication speed from 9600/19200/38400/57600/115200. Select the same speed as you selected in [Modem] in the system settings.
Transferring CF Files	Specify whether to send the data in the CF Card folder to the CF Card in the GP. If you do not wish to replace the data on the CF Card, clear the check box.	
Transfer Site Data	<p>[Specify whether to send the standard HTML template in the folder set for [Data Transmission] in [Site Transfer Settings].</p> <p>👉 "37.15.1 Standard Template HTML Setting Guide" (page 37-73)</p>	
Transfer Project	Automatic	The project to be transferred is compared with the project on the GP. If they are the same project, only updated or added screen data are sent. When sending a new or different project, the whole project is sent after you click [OK] in the confirmation message.
	All	Sends the whole project to be transferred. Overwrites the existing project on the GP.
	Retain retentive variables	<p>Transfer the project and retain current values of retentive values.</p> <p><b>IMPORTANT</b></p> <ul style="list-style-type: none"> <li>If the check box is not selected, data in the variables will be initialized.</li> </ul>

Continued

Setting		Description
Transfer System	Automatic	<p>When you send the project, GP-Pro EX automatically compares between the project system version and the GP system version, and, if necessary, downloads the system program <sup>*1</sup>, the protocol program <sup>*2</sup>, and the font <sup>*3</sup> to the GP.</p> <p>These items are downloaded in the following cases:</p> <ul style="list-style-type: none"> <li>• When you perform a transfer when GP has no data (factory default)</li> <li>• If the system program (Runtime) version stored on the GP is older than the GP-Pro EX version.</li> <li>• When old versions of protocol programs (drivers) are stored in the GP, or when project device/PLC settings have been added or changed.</li> <li>• When a font not in the GP was used in GP-Pro EX.</li> </ul>
	Forced	<p>After you format the GP and send a project, GP-Pro EX will forcibly download the system programs <sup>*1</sup>, protocol programs <sup>*2</sup>, and fonts <sup>*3</sup> to the GP.</p> <p>These are downloaded even if the GP-Pro EX system is a previous version of the current system on the display unit.</p>

\*1 Data used to operate the project on the GP

\*2 Data needed to communicate with the device/PLC to be used.

\*3 Font data used by the project.

## ■ Site Transfer Settings

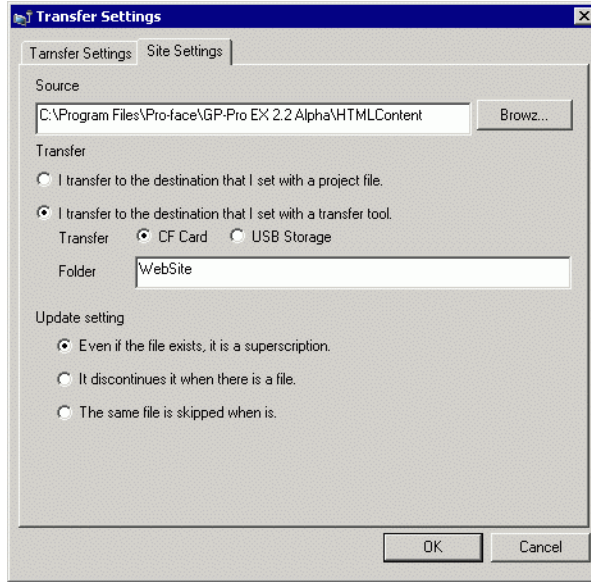

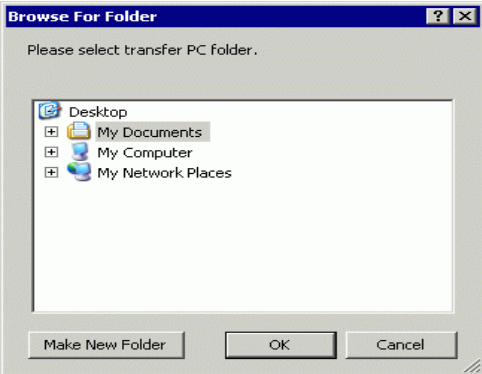
Setting	Description
<p>Transfer Transmission</p>	<p>Specify the folder where the Web site data is stored. To select the source folder, click [Browse] and use the [Browse For Folders] dialog box to select the folder.</p> 
<p>Transfer Settings</p>	<ul style="list-style-type: none"> <li>• Enable Project Setup Transfers data to the destination specified in the [Display Unit] page's [Remote Viewer] tab, [Web Server] settings. The data is transferred if the [Enable Web Server] check box is selected. ☞ "37.15.2 System Settings [Display Unit] - [Remote Viewer] Settings Guide n Web Server" (page 37-81)</li> <li>• Enable Transfer Tool Setup [Transfers data to the destination specified through [Destination] and [Folder].</li> </ul>

Continued



Setting	Description
Site Data Write Settings	<ul style="list-style-type: none"><li>• <b>Overwrite files</b> If the same file name exists, the existing file will be overwritten.</li><li>• <b>Stop When File Exists</b> If a file with the same file name, the transmission of the file is terminated when such a file is detected.</li><li>• <b>Skip When Same File Exists</b> If the same file name exists, the transmission of such a file is terminated and the next file is sent.</li></ul>

### ■ COM Transfer Connections

Connect the computer and GP using 2 cables.

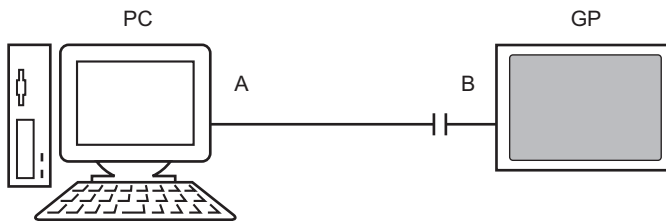

A: Originally created cable

Create the cable based on the diagram below.

DSUB9 (EIA-574)

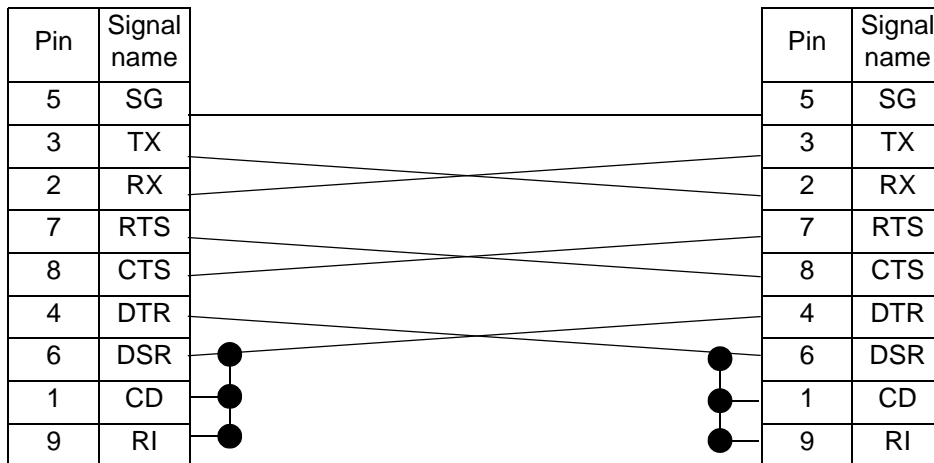

B: RS232C-USB Conversion cable

(Cable commercially available, Type: EC-USBRSAQ3)

## ■ [Memory Loader] Settings Guide

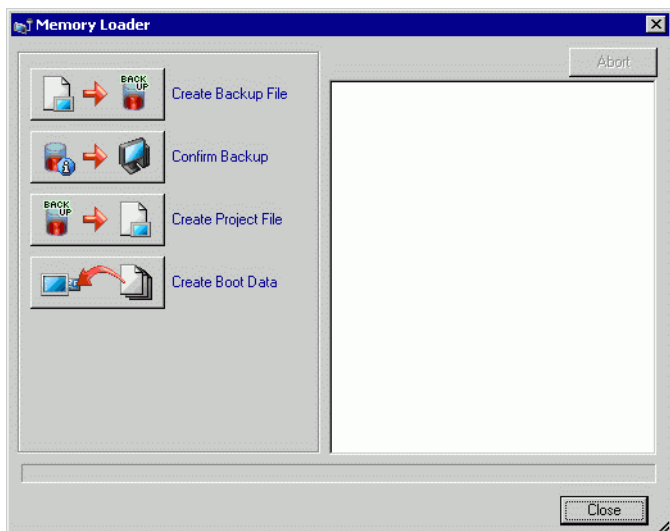

**NOTE**

- To use [Memory Loader], first set up [Destination Folder].  
 ☞ " ◆ Destination" (page 5-108)

Setting	Description
<p>Create Backup File</p>	<p>In the destination folder you selected in [Select Folder], create backup data (*.cml) for the project currently open in GP-Pro EX (or the project selected in [Select project]) and the memory loader to start the data on the GP. Save the data in the CF Card folder onto the CF Card and the data in the USB folder onto the USB storage device.</p> <div data-bbox="546 1155 1016 1412" style="border: 1px solid black; padding: 5px; margin: 10px auto; width: fit-content;"> </div> <p><b>NOTE</b></p> <ul style="list-style-type: none"> <li>• This selection is not available if you selected IPC series as the unit type.</li> </ul>

Continued

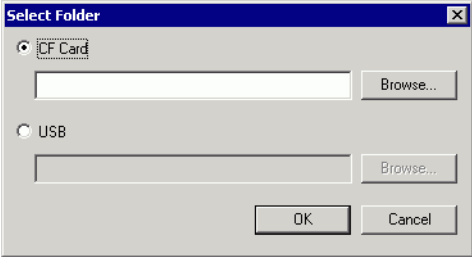
Setting	Description
Confirm Backup Data	<p>Lists the stored backup data: [System Information], [Project Information], [Backup Size], and the names and dates of each backup file.</p> <ul style="list-style-type: none"> <li>• About Backup File Name The backup file default name depends on the display model. AGP-3600T, 3510T, 3500T, 3500S, 3500L, 3400T, 3400S —&gt; MEM3X00.CML AGP-3750T, 3650T, 3560T, 3550T, 3450T —&gt; MEM3X50.CML AGP-3300T, 3300S, 3300L, 3301S, 3301L —&gt; MEM330X.CML AGP-3302B —&gt; MEM3302.CML AGP-3200T —&gt; MEM3X0XZ.CML AGP-3200A —&gt; MEM320XZ.CML LT-3201A —&gt; MEM32XXL.CML LT-3300S, LT-3300L, LT3301L —&gt; MEM330XL.CML AST-3211A (MPI), AST-3201A (SIO), AST-3301B —&gt; MEM320XZ.CML AST-3301S —&gt; MEM3X0XZ.CML AST-3401T, AST-3501C, AST-3501T —&gt; MEM3X01Z.CML AGP3300HS, AGP3300HL —&gt; MEM3300H.CML AGP3310HT —&gt; MEM3X00H.CML</li> </ul>
Create Project File	<p>You can create a project file (*.prx) from backup data (*.cml).</p>
Create Boot Data	<p>In the destination folder you selected in [Select Folder], create the memory loader tool necessary for upload from the GP to the CF Card/USB storage device and for download from the CF Card/USB storage to the GP. Save the data in the CF Card folder onto the CF Card and the data saved in the USB folder onto the USB storage device.</p> <p><b>NOTE</b></p> <ul style="list-style-type: none"> <li>• This selection is not available if you selected IPC series as the unit type.</li> </ul> 

### 33.10.2 [Modem] Settings Guide

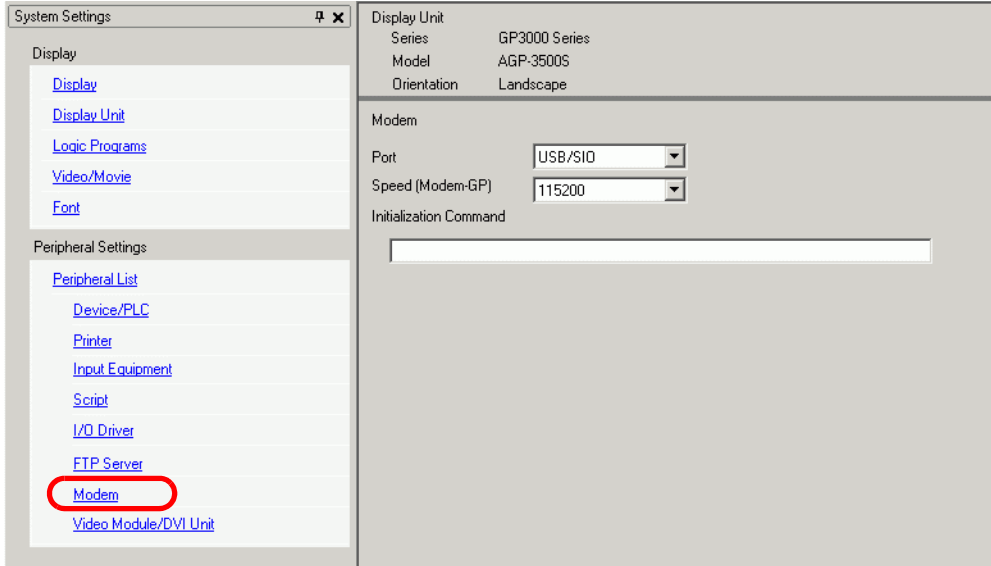

Setting	Description
Port	Select from [Disable] or [USB/SIO].
Speed (Modem-GP)	Set the communication speed between modem and GP.
Initialization Command	Enter the Initialization Command of the modem. <div style="border: 1px solid black; padding: 2px; display: inline-block;"><b>NOTE</b></div> <ul style="list-style-type: none"> <li>If you set blank for the Initialization Command, the command "ATE1Q0V1&amp;C1&amp;D2" will be automatically sent.</li> </ul>

**NOTE**

- For setting details, please refer to the instruction manual that come with your modem.

### 33.10.3 How Sending Data Works

Writes the project currently open (or the selected project) in GP-Pro EX to the GP.

If a project is configured with a CF Card output folder (\DATA and \FILE), data is saved to the CF Card in the GP.

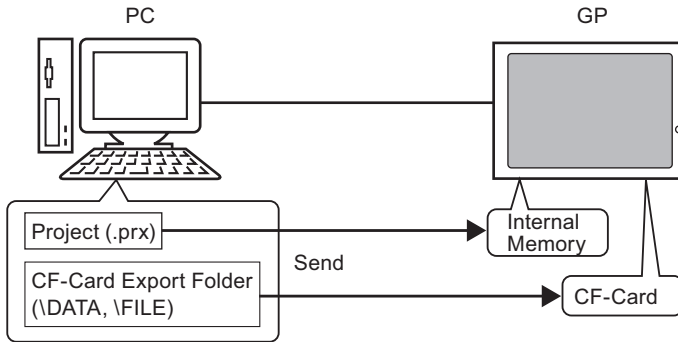

- NOTE**
- Only one project file (\*.prx) can be saved on the GP.
  - When sending a project, the necessary system programs, protocol programs, and fonts are downloaded to the GP. The transfer will take a few moments.
  - If the file is already in the CF Card folder, the file is overwritten when transferred. If you do not wish to overwrite the file, clear the [Transfer CF Card data] check box in [Transfer Settings] for the transfer tool.

If the same project exists in the GP, only modified or added screens are transferred.  
 When there is no project or a different project on the GP, the whole project is transferred.

#### ■ When a different project is stored in the GP

For example, Transfer "Lesson.prx" to the GP where "Test.prx" is stored.

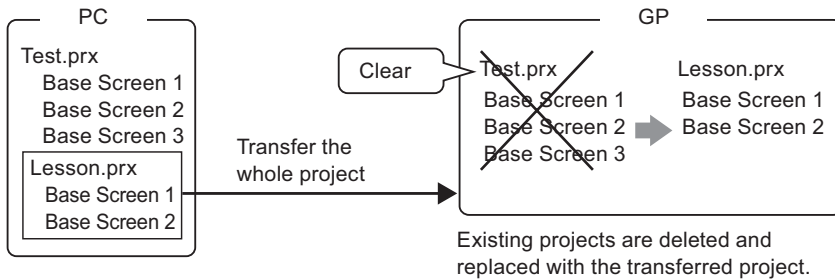

### 33.10.4 How Receive Works

Project data currently stored in the GP are saved to the destination location on the PC as a new project file (\*.prx).  
If the project uses the CF Card folder, data contained in the CF Card (\DATA and \FILE) is saved to the defined location.

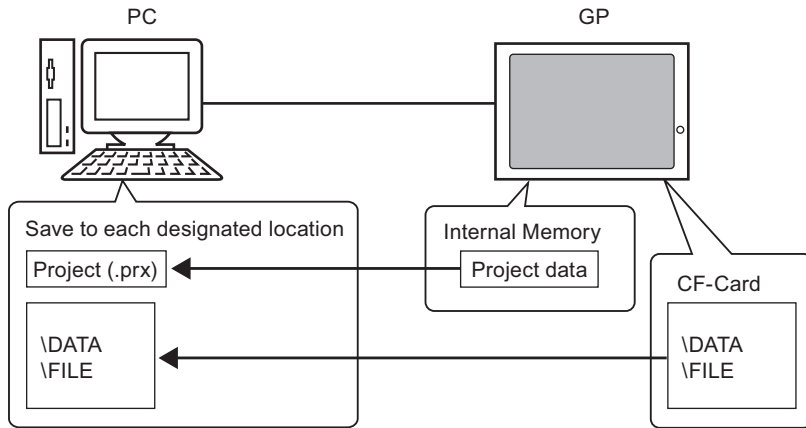

### 33.10.5 Installing the Transfer Tool

If you want to transfer projects from a PC that does not have GP-Pro EX installed, you can install the Transfer Tool onto this PC.

Operating Systems that support Transfer Tool

- Windows® 2000 Professional (SP3 or higher)
- Windows® XP
- Windows® 98 (Second Edition or higher)
- Windows® Me
- Windows Vista® (Ultimate, Home Premium, Home Basic, Business)

---

**IMPORTANT**

- You cannot install GP-Pro EX onto a PC installed with the transfer tool. Uninstall the transfer tool to install GP-Pro EX.
- 

#### ■ Installing Transfer Tool

- 1 Insert the GP-Pro EX installation CD-ROM (Disk1) into the CD drive of the computer that is being used for the Transfer Tool.  
The following window appears.



- 2 [Click [Transfer Tool]].

---

**NOTE**

- You cannot run the Transfer Tool installation on a computer with GP-Pro EX already installed.
- 

- 3 Set the destination folder for the installation. The default location is \Program Files\Pro-face\GP-Pro EX \*.\* (\*.\* indicates the version).
- 4 Installation starts. When completed restart the PC.



## ■ Transfer Tool: From Triggering to Sending

- 1 On the PC start menu, select [Program (P)] then point to [Pro-face], [GP-Pro EX \*.\*], and then click [Transfer Tool]. (\*.\*\* indicates the version number)

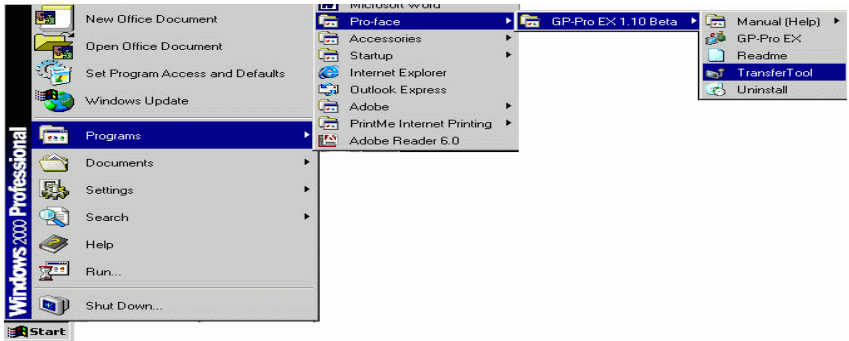

- 2 Transfer Tool launches.

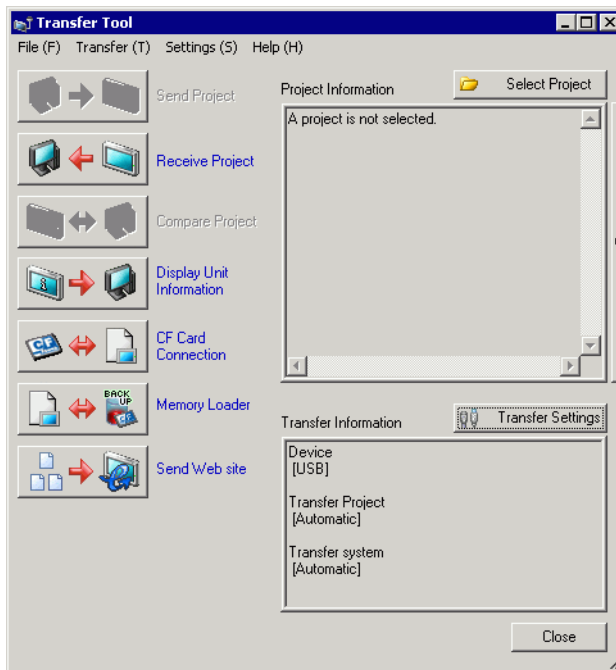

- 3 To retrieve a project from the GP, click [Receive Project].  
To send a project or compare projects, select a project with [Select Project].

## 33.11 Restrictions

### 33.11.1 Transfer Restrictions

- When sending a project, data stored in GP's backup SRAM is deleted.
- When sending a project, the necessary system programs, protocols, and fonts are downloaded to the GP. The transfer will take a few moments.

Downloads occur in the following cases:

- When you perform transfer when GP has no data (factory default)
- If the system program (Runtime) version stored on the GP is older than the GP-Pro EX version.
- When old versions of protocol programs (drivers) are stored in the GP, or when project device/PLC settings have been added or changed.
- When a font not in the GP was used in GP-Pro EX.

When a download occurs, the GP is reset.

- After restarting, the transferred screens appear.
- When the GP unit is offline, the project cannot be transferred. During the transfer, the GP changes to Transferring mode and communication with devices/PLCs is suspended.
- When a problem is found with the system program on the GP, an error message appears on the GP. Transfer the project file again.
- You cannot transfer the project file to a different model. To perform transfers even between same model GPs, except for GP3200 Series, one of the following conditions must apply.
  - Models that do not support the control feature.
  - Models equipped with DIO board
  - Models with FLEX NETWORK connections
- Project files created on AGP3300 Series Rev.4 or later models cannot be transferred to AGP3300 Series Rev.3 or earlier models.  
Transfer will fail, or the transfer screen will appear again upon restarting the GP even after file transfer is complete.

### 33.11.2 Restrictions for Transfer Using Ethernet

- You can transfer data between the GP and a PC on a different network by using a router. However, there are cases where the PC cannot automatically search the GP on a different network.
- For a PC that is using two or more Ethernet cards, the desired GP may not be detected even if the PC automatically detects IP addresses. This occurs when the PC searches the GPs connected to the Ethernet card that was previously found. Click [Add] on the [Select Display Unit] dialog box and manually set the IP address of the GP.
- When using the Transfer Tool on a PC running Windows XP SP2 with Windows Firewall enabled, you are prompted to allow the transfer. If you transfer data to more than one GP at the same time, either select [PASV] in the [Transfer Settings]>[Communication Port Settings] or disable Windows Firewall.

---

### 33.11.3 Restrictions on Transfer Using a COM Port

---

- Create the special cable before using the port.  
☞ "33.10.1 [Transfer Settings] Settings Guide ■ COM Transfer Connections" (page 33-66)
- You can only transfer project files to a GP on which the system program (Runtime) created in GP-Pro EX 1.10 is downloaded.
- COM port transfer is not available when using WinGP.

---

### 33.11.4 Restrictions on CF Card Connection

---

- When the GP is offline, the CF Card connection feature cannot be used.
- There is a limit to the frequency that data can be rewritten to the CF Card. 500 KB of data can be rewritten around 100,000 times. Backup to another media.  
☞ "A.5 Transferring Data Between a CF Card and a USB Memory Device" (page A-82)
- If there is no action taken for five minutes after you start [CF Card connection], a warning message appears. If you do not take any action for another five minutes, the GP is disconnected.

---

### 33.11.5 Restrictions on Modem Transfer

---

- If GP does not already have a project in it, you cannot transfer via a modem.
- You cannot transfer a new project via a modem. You can only use a modem to update the screen data of the project already on the GP.
- You cannot transfer the project file under the following conditions:
  - When system settings have changed
  - For project files created on a different version of GP-Pro EX (Note that you can transfer files as long as the run-time system, protocol driver, and I/O driver versions are the same.
- The modem connecting to the GP must meet the following requirements.
  - Support AT commands
  - Allow automatic answering
  - Support hardware flow control
  - Modem that can return text with the result commandA modem can be used only after connecting to a specific operation center.
- Since the GP receiving modem is analog, you cannot use ISDN TA modem.
- The modem connected to your PC must support AT commands. Use a Windows-compatible modem that can establish telephone communication with the modem connected with GP. A modem can be used only after connecting to a specific operation center.
- For supported modem models, refer to Pro-face's support site "Otasuke Pro!" (<http://www.pro-face.com/otasuke/>). Supported models may change due to GP upgrades.
- Modem transfer is not available when using WinGP.

---

### 33.11.6 Restrictions on Memory Loader

---

- The CF Card memory size must be at least 64 MB.
- There is a limit to the frequency that data can be rewritten to the CF Card. 500 KB of data can be rewritten around 100,000 times. Backup to another media.
- CF Cards and USB storage devices require different "memory loader tools" for startup. Create the respective tools.
- Even if multiple USB storage devices are connected to the GP, you can only use the USB storage that is first recognized.
- When using the memory loader to download the GP-Pro EX project to a GP set up with a Pro-Server EX project file (\*.npx), be aware that the \*.npx file will be deleted. Using the CF card or USB storage device, follow these steps to move .prx and .npx project files to another GP.
  1. Transfer the GP-Pro EX project file (.prx) from the PC to the GP.
  2. Transfer the Pro-Server EX project file (.npx) from the PC to the GP.
  3. Start the memory loader tool on the GP to begin upload operations. The GP-Pro EX (.prx) and Pro-Server EX (.npx) project files on the GP are saved to the CF card or USB storage device.
    - ☞ " ■ Transferring Project Files from GP to PC (or to Another GP)" (page 33-44)
  4. From the GP, remove the CF card or USB storage device and load it into a different GP to download the project files.
- Memory Loader Tool's Backup data (\*.cml) created for AGP3300 Series Rev.4 or later models cannot be downloaded to AGP3300 Series Rev.3 or earlier models. Download will fail with an error, or the transfer screen will appear upon restart after downloading.

#### ■ CF Card Cautions for Use

- When ejecting a CF Card, make sure that the CF Card access LED lamp turns OFF. Otherwise, the data on the CF Card may be damaged.
- When accessing a CF Card, be sure not to power OFF or reset the GP, or eject the CF Card. Create an application screen on which the CF Card cannot be accessed, and on that application screen, you may power OFF or reset the GP, open and close the CF Card cover, and eject the CF Card.
- When inserting a CF Card, check the front and back sides and the connector position of the card. If the CF Card is inserted the wrong way, the data, the CF Card, or the GP may be damaged.
- Use a CF Card manufactured by Digital Electronics Corporation. If a CF Card manufactured by another company is used, the contents of the CF Card may be damaged.
- Please make sure to back up all CF Card data.
- Please refrain from doing the following, as it can result in damage to data and equipment:
  - Bending the CF Card
  - Dropping the CF Card
  - Spilling water on the card
  - Touching the CF Card's connectors directly
  - Disassembling or modifying the CF Card

## ■ USB Storage Cautions for Use

- While accessing the USB device, do not reset the display unit or remove the USB storage device. Data on the storage device may be corrupted.  
To remove the USB storage device safely, design the system to remove the device only after turning ON system variable #H\_Control\_USBDetachTrigger and after confirming #H\_Status\_USBUsing is OFF.  
 "A.6.2 HMI system variables (#H system variables) n Bit type" (page A-107)
- Please make sure to back up all data on USB storage devices.

