

24



Data Sampling

This chapter explains the workflow of GP-Pro EX "Data Sampling" including how to change the settings.

Start with "24.1 An Introduction to the Sampling Feature" (page 24-2), and then turn to the corresponding page from "24.2 Settings Menu" (page 24-3)

24.1	An Introduction to the Sampling Feature.....	24-2
24.2	Settings Menu	24-3
24.3	Sampling Data at Constant Intervals.....	24-5
24.4	Sampling Data at Specific Periods	24-10
24.5	Displaying Sampled Data	24-14
24.6	Saving Sampling Data to CF Card/USB Storage	24-20
24.7	Display/Save Sampled Data in CSV with a Custom Format	24-30
24.8	Settings Guide.....	24-37
24.9	Sampling Structure.....	24-115
24.10	Restrictions	24-152

24.1 An Introduction to the Sampling Feature

24.1.1 What is the Sampling Feature?

This feature samples data from the desired address value of the device/PLC at the designated time and then stores it in the GP. This is useful for viewing data history.

At the designated time, data from the device/PLC is read in to the GP.

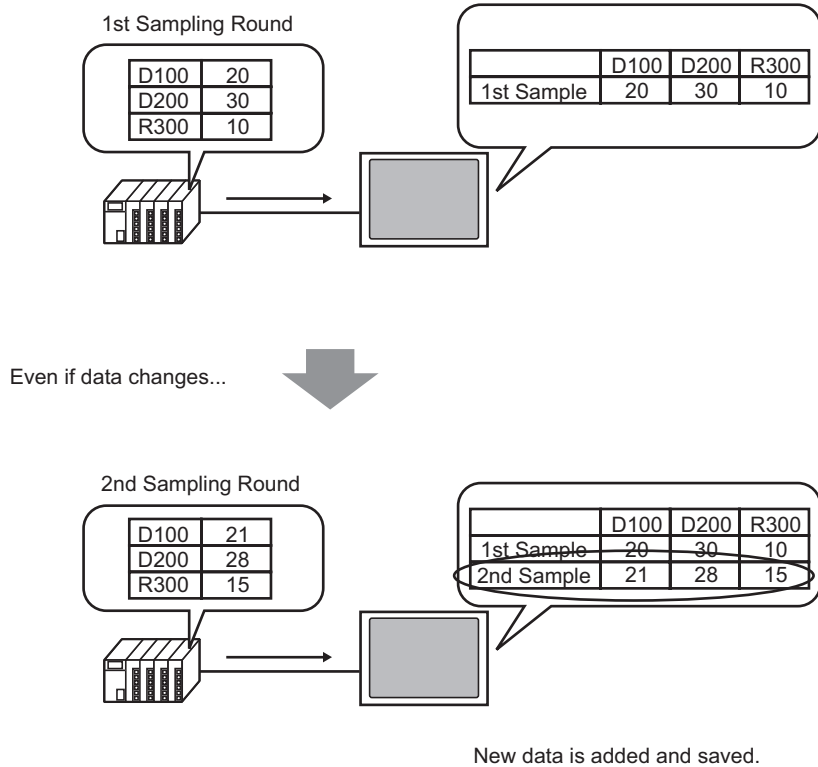

Data collected by the Sampling feature is called "Sampling Data".

Sampled data can be displayed as a line graph on the GP screen and printed from a printer connected to the GP screen. The data can also be saved to a CF Card or USB storage device. You can edit it using general spreadsheet software (such as Microsoft Excel) on the screen because it is saved in CSV format.

24.2 Settings Menu

Sampling Data at Constant Intervals

Data is collected from once every hour for 10 times, starting at 08:00

8:00 1st Sampling Round

D100	D101	D102
20	30	10

9:00 2nd Sampling Round

D100	D101	D102
20	30	10
21	28	15

⋮

17:00 10th Sampling Round

D100	D101	D102
20	30	10
21	28	15
⋮	⋮	⋮
32	41	24

- ☞ Setup Procedure (page 24-6)
- ☞ Introduction (page 24-5)

Sampling Data at Specific Periods

Data is collected every time the designated bit turns ON.

Sampling Trigger Bit Address
M100:ON

Data Sampling

D100	D101	D102
20	30	10

- ☞ Setup Procedure (page 24-11)
- ☞ Introduction (page 24-10)

Displaying Sampled Data

Every time data is collected, it is displayed on a Sampling Data Display on the screen.

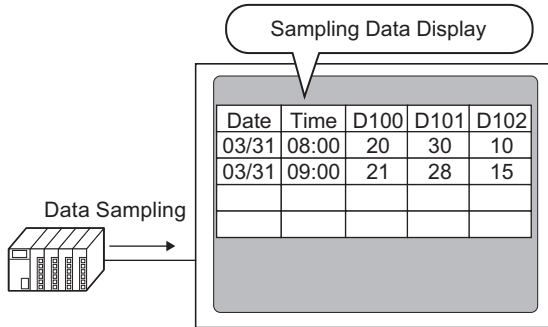

- ☞ Setup Procedure (page 24-15)
- ☞ Introduction (page 24-14)

Saving Sampling Data to CF Card/USB Storage

Write a command to the designated Control Address and the GP sampling data is written in CSV format to the CF Card.

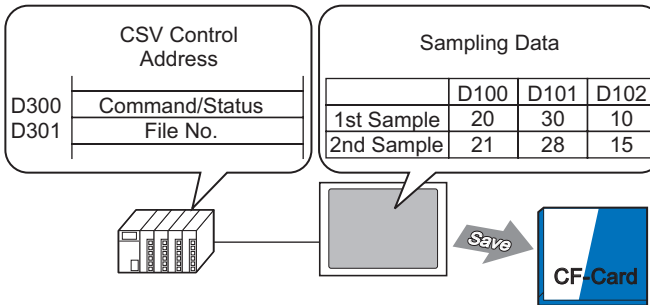

- ☞ Setup Procedure (page 24-21)
- ☞ Introduction (page 24-20)

Display/Save Sampled Data in CSV with a Custom Format

Create a customized format: display only selected data, change the Item Names, display a calculation row with averages or maximum values.

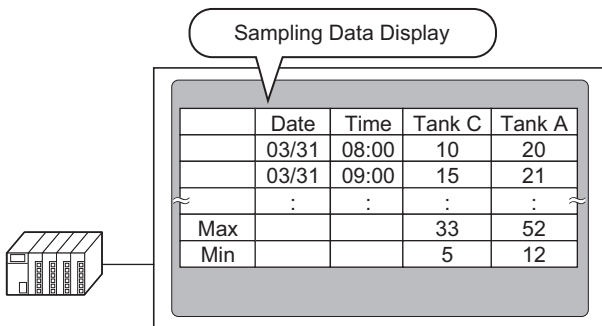

- ☞ Setup Procedure (page 24-31)
- ☞ Introduction (page 24-30)

24.3 Sampling Data at Constant Intervals

24.3.1 Introduction

Read the designated address value from the device/PLC at a fixed interval and save that data in the GP.

- Designating the Start Time and sampling data at fixed intervals after that time.
For example, Start Time: 08:00, Sampling Cycle: 1 hour, Occurrences: 10

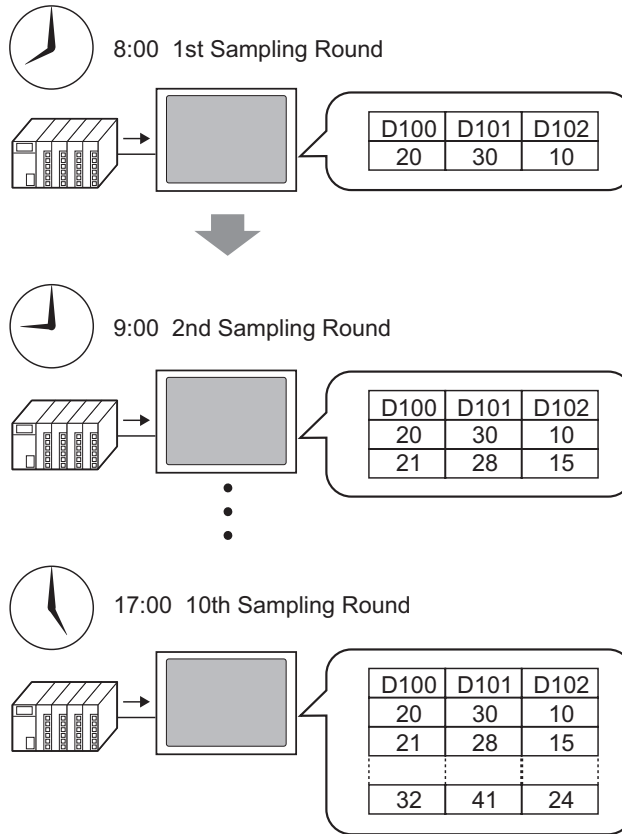

When you reach the limit defined in the [Occurrences] field, you can either continue sampling by overwriting the oldest sample, or stop sampling.

24.3.2 Setup Procedure

NOTE

- Please refer to the Settings Guide for details.
 ☞ "24.8.1 Common (Sampling) Settings Guide" (page 24-37)

Configure settings to sample the data from D100, D101, and D102 once every hour starting at 8:00 for ten cycles.

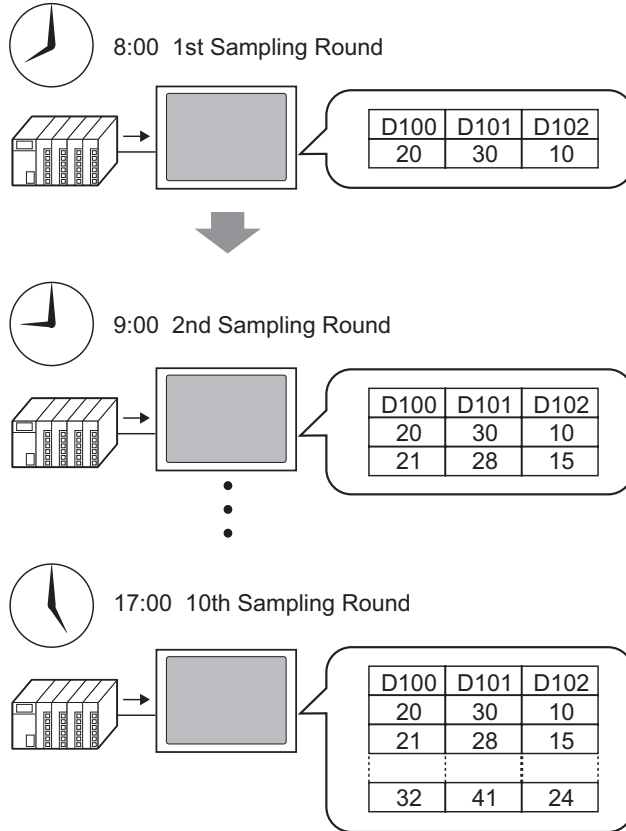

1 In the [Common Settings (R)] menu, select the [Sampling (D)] command or click , and the following screen appears.

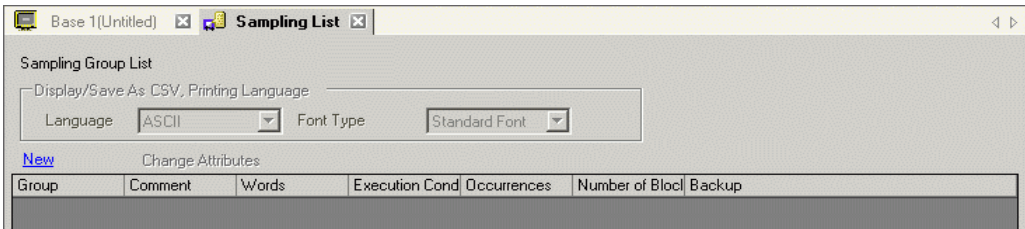

2 Click [Create] and the following dialog box appears. Set the sampling group number, click [OK], and the sampling group settings screen appears.

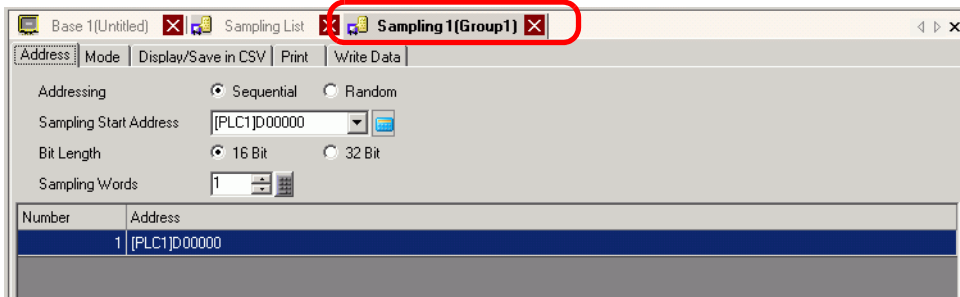
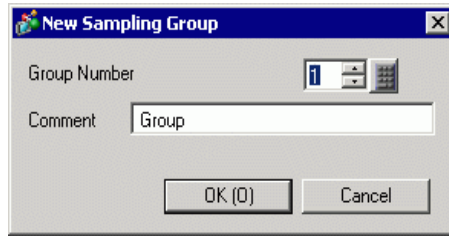

3 In [Sampling Start Address], set the start address (D100) for data you want to sample.

Click  to display an address input keypad.

Select the device "D" and enter "100" in the address, then press the "Ent" key.

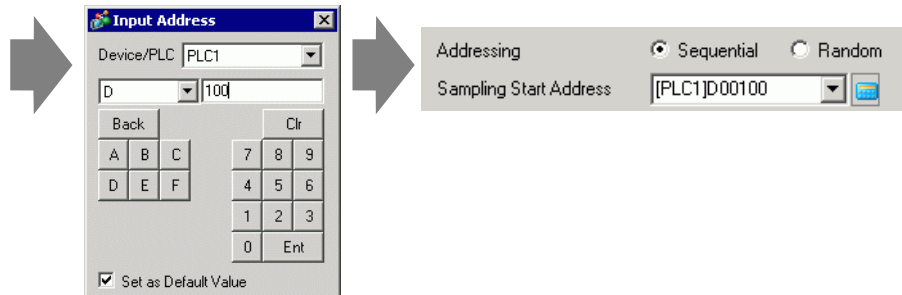

4 Designate the bit length to store for sampled data, and in [Sampling Words], set the number of addresses (for example, 3). The first three words are displayed, starting from the designated address.

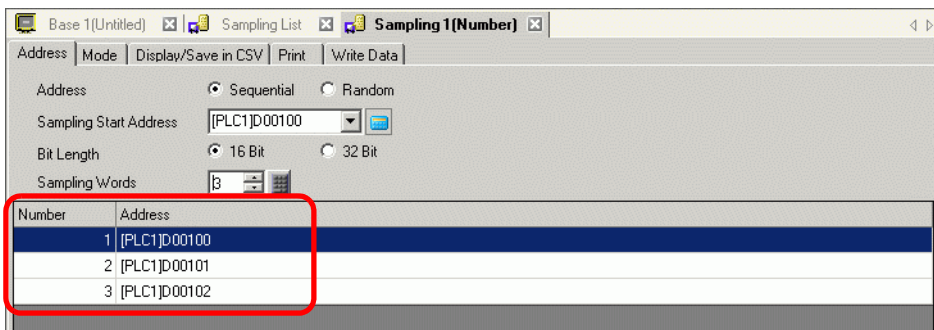

5 On the [Mode] tab, for the [Execution Condition] select [Time Specification].

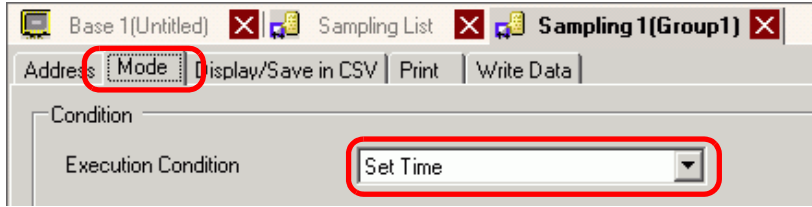

6 In [Sampling Permit Bit Address], set the Bit Address (For example, M100) to control the data sampling operation.



NOTE

- Please ensure that this bit is turned ON before the Start Time. Sampling will not begin if this bit is OFF at the Start Time. Time is monitored with the Clock Data in the GP.

7 Designate the Start Time (08:00) for the data sampling, and set the cycle and Occurrences (each hour for 10 cycles).

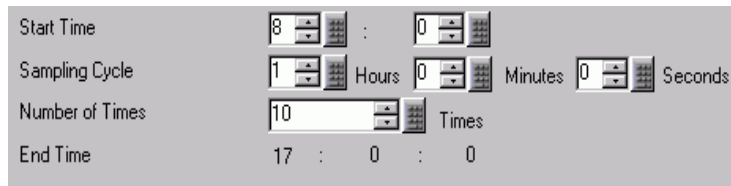

8 Set up the address (for example, M50) to delete the sampling data. When this bit is turned ON, all data from sampling group 1 stored in the GP is deleted.

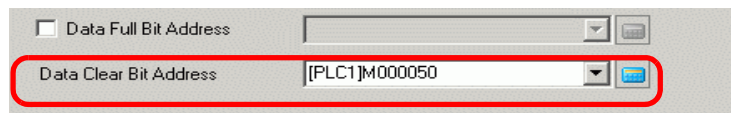

9 Click [Extended] and the following dialog box will open. As needed, set the number of days of sampling data that will be maintained in the GP.

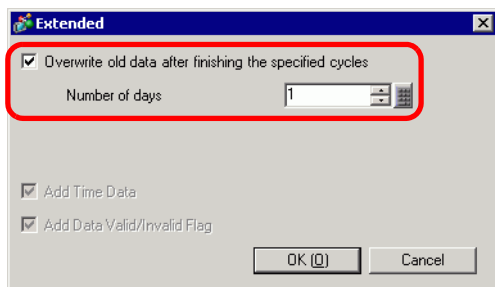

For the picture to the left, one day data will be maintained in the GP. On the following day at the Start Time (8:00), the previous day sampling data will be overwritten in order and new data stored. If you do not want data to be overwritten, clear the [Overwrite old data after finishing the specified cycles] check box. On the next day, sampling does not run at the start time.

If you clear the [Overwrite old data after finishing the specified cycles] check box, you can adjust the [Blocks] setting. A "block" is the sampling data collected from the designated Occurrences. When displaying or printing data, you can use block units.

For example, sample for five days from Monday to Friday and display/print data by each day.

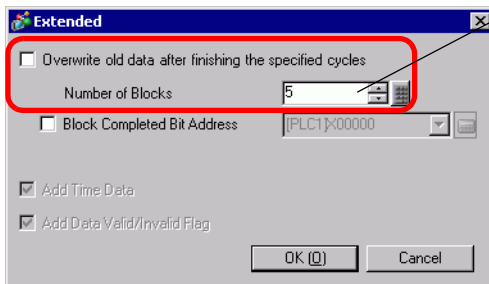

The sampled data for the designated Occurrences is one block. Specify how many blocks.

For the picture to the left, five days sampling data will be maintained in the GP. On the 6th day and later, sampling will not occur. To resume sampling, clear the sampling data stored in the GP.

NOTE

- For information about the timing of the Sampling action, please refer to the following.
 - ☞ "24.9.2 The Sampling Action ◆ Time Specification" (page 24-122)
- When the [Backup to Internal Memory] check box is not selected, the sampling data stored in the GP is erased when the GP is turned OFF or reset.

24.4 Sampling Data at Specific Periods

24.4.1 Introduction

Each time the designated bit address turns ON, the specified address value is read from the device/PLC and that data is saved in the GP.

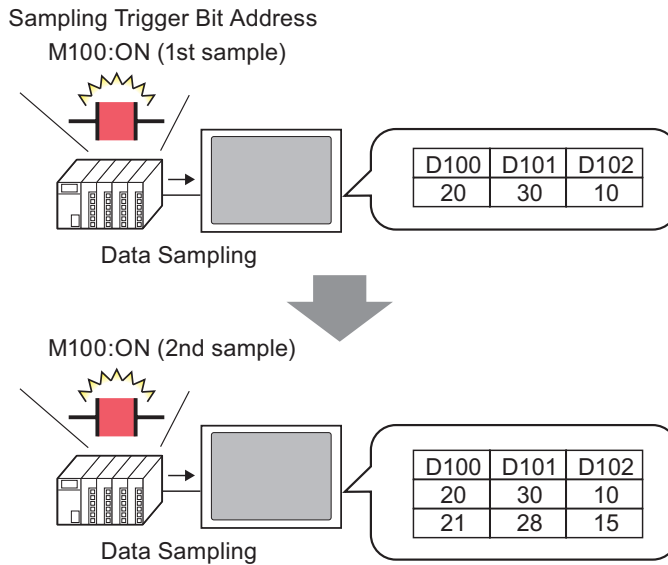

Sample data from the designated Occurrences, and set whether to overwrite the oldest data and store the new data the next time the designated bit turns ON, or to stop sampling.

24.4.2 Setup Procedure

NOTE

- Please refer to the Settings Guide for details.
 ☞ "24.8.1 Common (Sampling) Settings Guide" (page 24-37)

Configure settings to sample data from D100, D101, and D102 every time the bit (M100) turns ON.

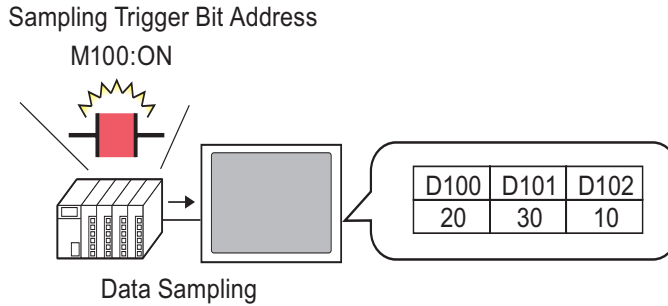

1 In the [Common Settings (R)] menu, select the [Sampling (D)] command or click , and the following screen appears.

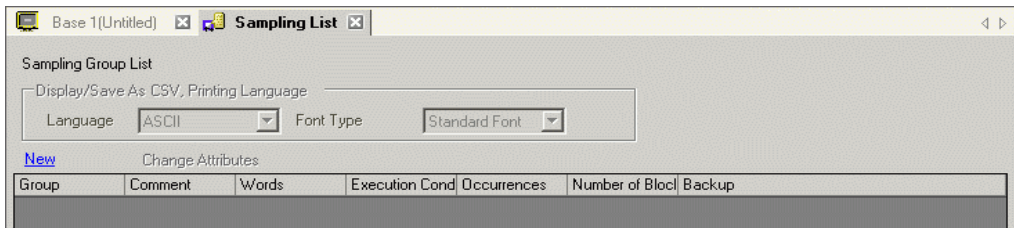

2 Click [Create] and the following dialog box appears. Set the sampling group number, click [OK], and the sampling settings screen appears.

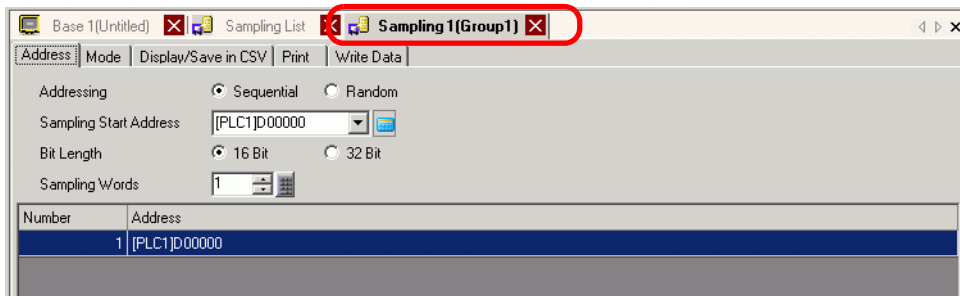
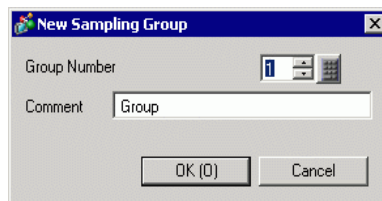

3 In [Sampling Start Address], set the start address (D100) for data you want to sample.

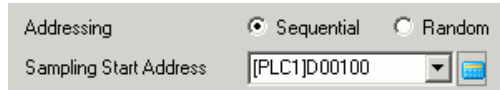

4 Designate the bit length to store for sampled data, and in [Sampling Words], set the number of addresses (for example, 3). The first three words are displayed, starting from the designated address.

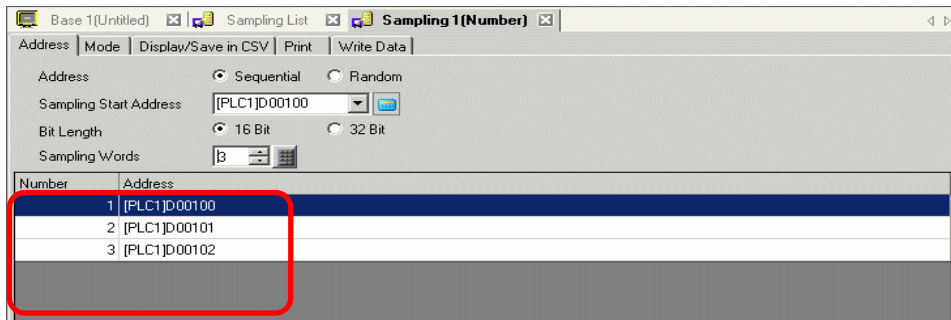

5 On the [Mode] tab, for the [Execution Condition] select [Bit ON].

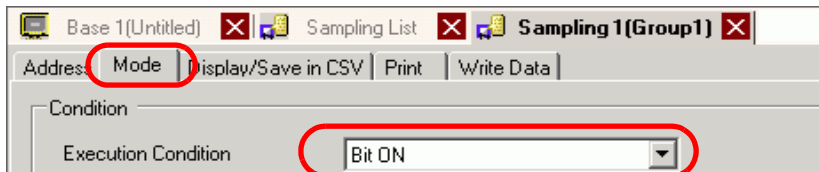

6 In [Sampling Trigger Bit Address], set the bit address (for example, M100) to control the data sampling operation. Data sampling runs every time this bit turns ON.



7 Designate the number of times to sample the data (for example, 4 times).



8 Set up the address (for example, M50) to delete the sampling data. When this bit is turned ON, all data from sampling group 1 stored in the GP is deleted.

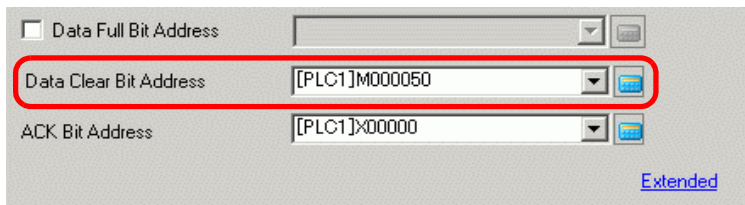

Click [Extended] and in the following dialog box, designate the [ACK Bit Address] (for example, M20) which will confirm when the data reading is finished. When the data reading is finished, this bit turns ON. Accept this Bit ON and turn OFF the [Sampling Trigger Bit Address] (M100).

(When M100 turns OFF, M20 turns OFF.)

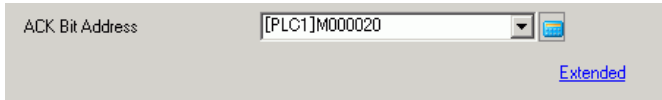

When data for the designated number of times (for example, 4) specified in step 7 is saved on the GP and the trigger bit (M100) turns ON for the 5th time, data will be overwritten and stored in order starting from the 1st time's data.

If you do not want data to be overwritten, clear the [Overwrite old data after finishing the specified cycles] check box in the [Advanced Object Configuration] dialog box. When the designated bit turns ON for the 5th time, sampling will not occur.

9 Click [Extended] to open the [Extended] dialog box.

If you clear the [Overwrite old data after finishing the specified cycles] check box, you can adjust the [Number of Blocks] setting. A "block" is the sampling data collected from the designated Occurrences. When displaying or printing data, you can use block units.

For example, sampling for five days from Monday to Friday and displaying/printing data by each day.

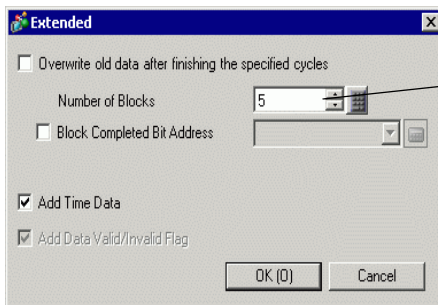

The sampled data for the designated Occurrences is one block. Specify how many blocks.

NOTE

- For information about the timing of the Sampling action, please refer to the following.
☞ "24.9.2 The Sampling Action ◆ Bit ON" (page 24-125)
- When the [Backup to Internal Memory] check box is not selected, the sampling data stored in the GP is erased when the GP is turned OFF or reset.

24.5 Displaying Sampled Data

24.5.1 Introduction

Display data collected with the Sampling feature (Sampling Data) on the GP screen in table format.

Data is displayed on the screen every time sampling occurs. This feature is useful for checking changes in address values.

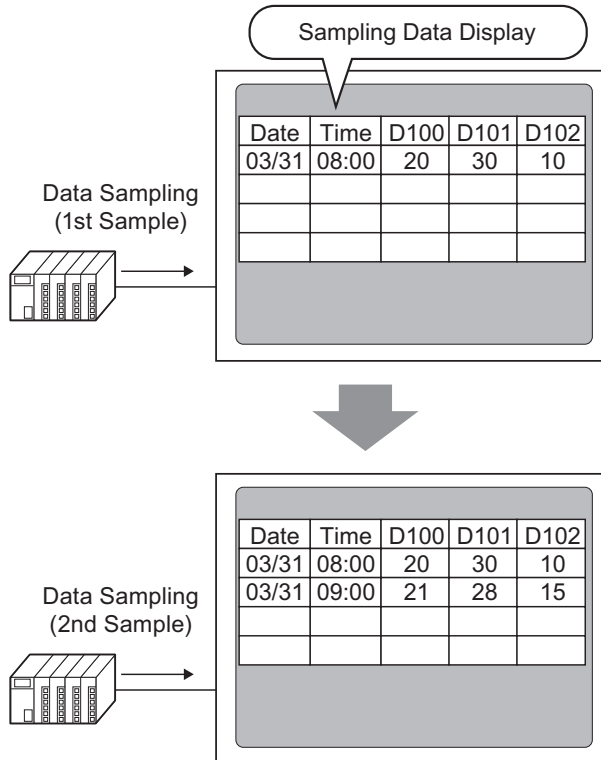

NOTE

- Data displayed on the GP screen can be edited by touch.
- Sampled Data can also be displayed in a Line Chart.

☞ "18.4 Using Trend Graphs" (page 18-13)

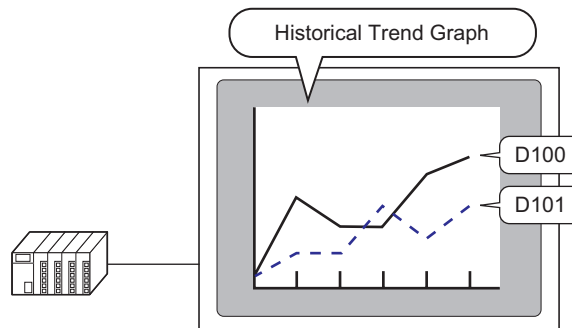

- For more detailed information about sampling data, refer to the following.
- ☞ "24.9.3 Sampling Data Display" (page 24-132)

24.5.2 Setup Procedure

NOTE

- Please refer to the Settings Guide for details.
 - ☞ "24.8.1 Common (Sampling) Settings Guide ■ Display/Save in CSV" (page 24-64)
 - ☞ "24.8.2 Sampling Data Display Guide" (page 24-108)
- For details of the part placement method and the address, shape, color, and label setting method, refer to the "Part Editing Procedure".
 - ☞ "8.6.1 Editing Parts" (page 8-44)

Configure settings to display Sampling Group "1" on the GP screen.

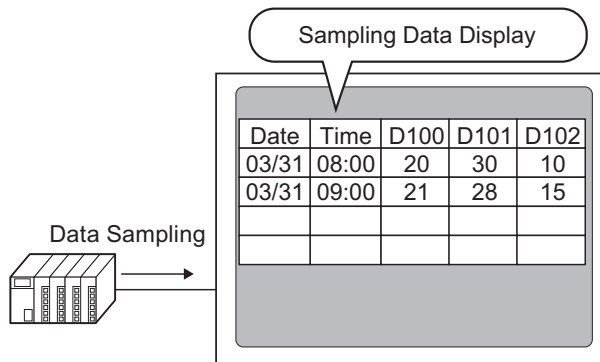

1 In the [Common Settings (R)] menu, select [Sampling (D)] or click , and a list of registered sampling groups appear. Double-click row 1 and the sampling group 1 setup screen appears.

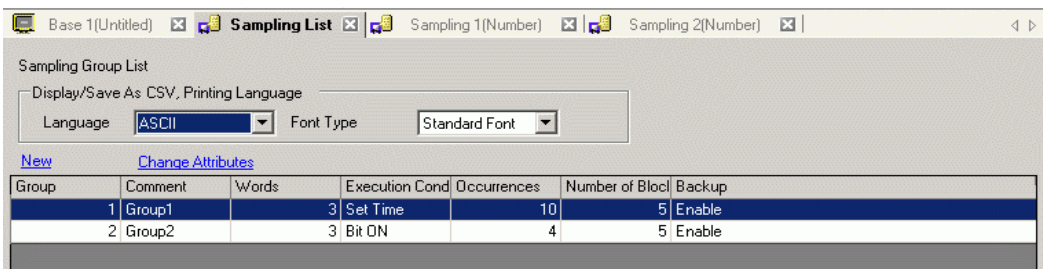

For information about Address/Action, see "24.3.2 Setup Procedure" (page 24-6)

2 Open the [Display/Save in CSV] tab. Select the [Display/Save in CSV] check box.

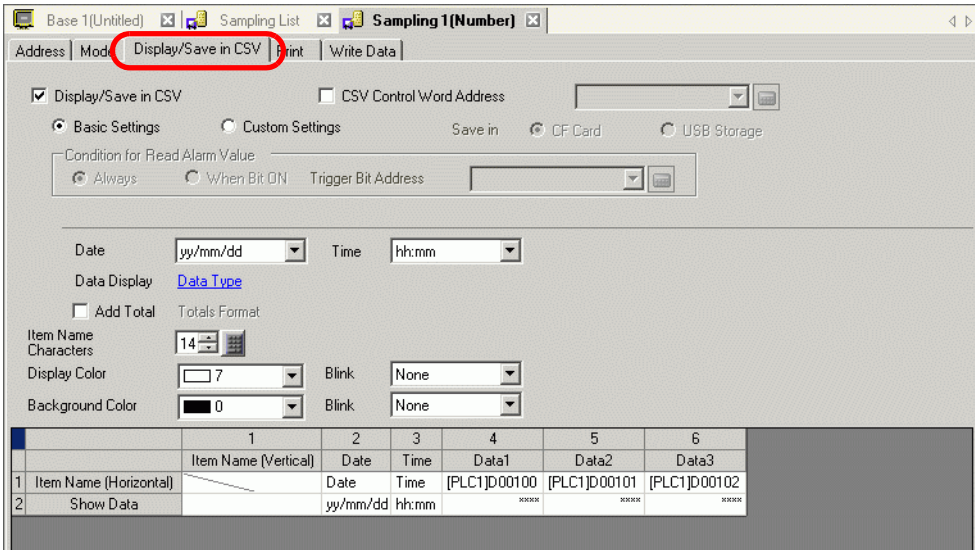

3 Select the display format for the date and time.

4 Click [Data Type Settings] to open the [Data Settings] dialog box. Set the data type, input range, number of display digits, and so on. The settings are applied to all the data columns.

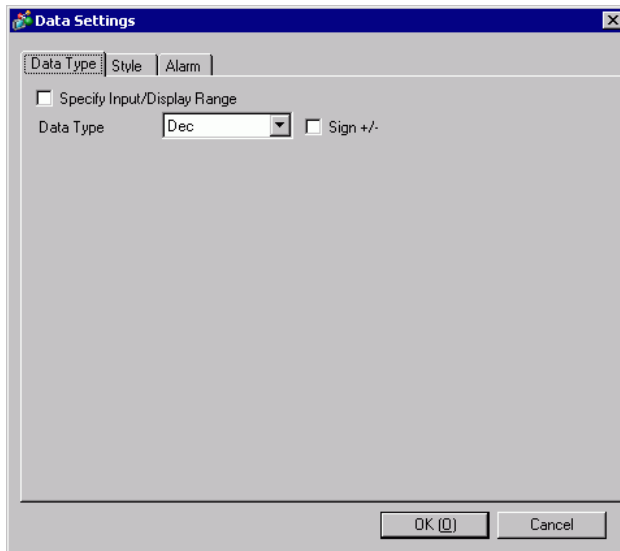

Click [OK] to close the dialog box.

5 Select a color and background color for the displayed text. The display format settings are complete.

6 Open the editing screen, and on the [Parts (P)] menu select [Sampling Data Display (S)], or click , to place the Part on the screen.

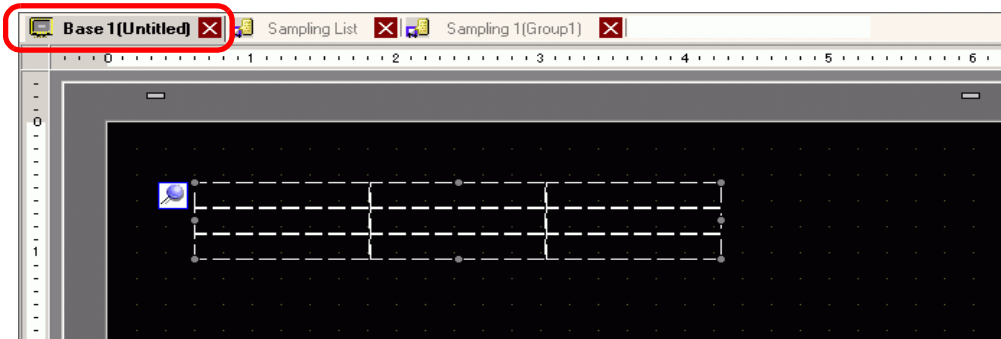

7 Double-click the placed Sampling Data Display. The [Sampling Data Display] dialog box appears.

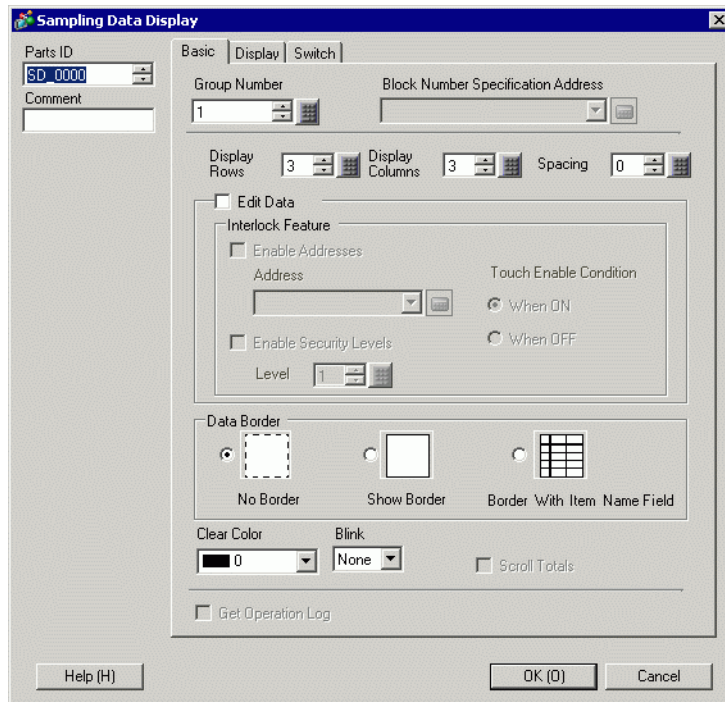

8 Define the sampling group you want to display on the screen. Set Sampling Group to "1".

NOTE

- In the [Common Settings (R)] workspace's [Sampling] node, click the [Mode] tab. In the [Extended] settings, after you clear the [Overwrite old data after finishing the specified cycles] check box, use [Block Number Specification Address] to display the sampling group.

9 Set the [Display Rows] and [Display Columns].

NOTE

- When you wish to edit the sampling data on the GP screen, select the [Edit Data] check box. The screen will change to the editing screen by touching the data, and the data can be edited by the keypad to be displayed.

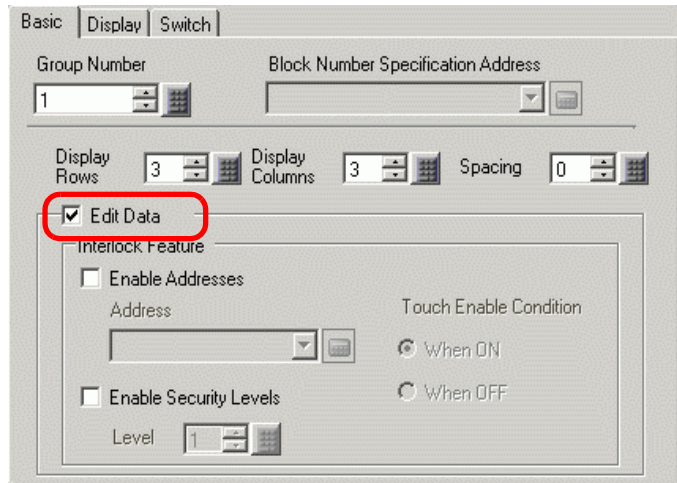

10 Select whether or not to show Ruled Line/Border and select the [Clear Color].



11 Select the [Display] tab, and set the font type and size.

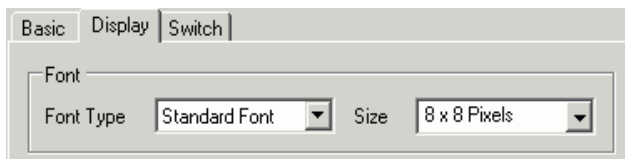

12 Select the [Switch] tab, and select the necessary scroll switches.

With [Select Shape], select the switch shapes, set the label and text color as needed, and click [OK].

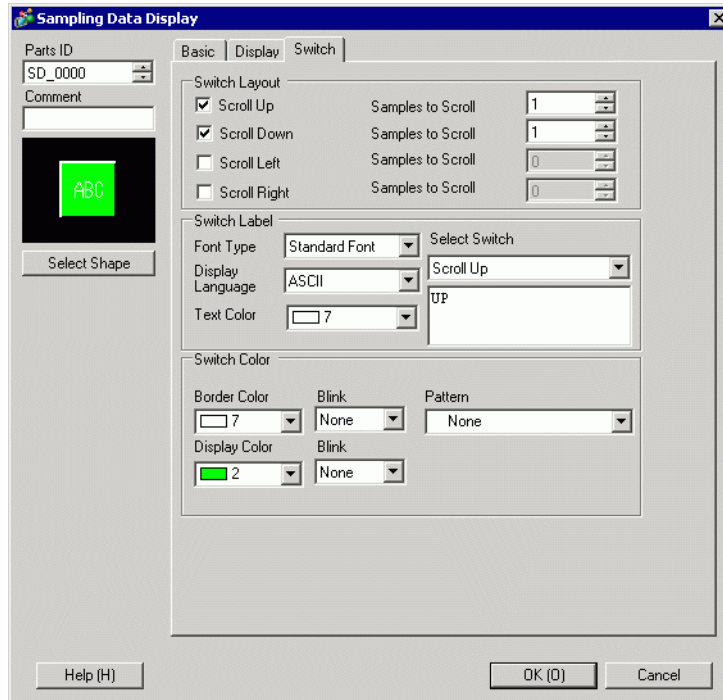

The Sampling Data Display is now set. You can move the switches independently to the desired location.

NOTE

- For the attached [Sampling Data Display] switches, you cannot set the shape or color independently. To set a different shape or color for each switch, use the Switch Lamp Part [Special Switch] - [Sampling Data Display Switch].

24.6 Saving Sampling Data to CF Card/USB Storage

24.6.1 Introduction

The data (sampling data) sampled by sampling feature is saved in CSV format on a CF Card or USB storage device.

The sampling data (SA*****.csv) saved on a CF card/USB storage device can be analyzed using general spreadsheet software (such as Microsoft Excel) on a computer or used in databases.

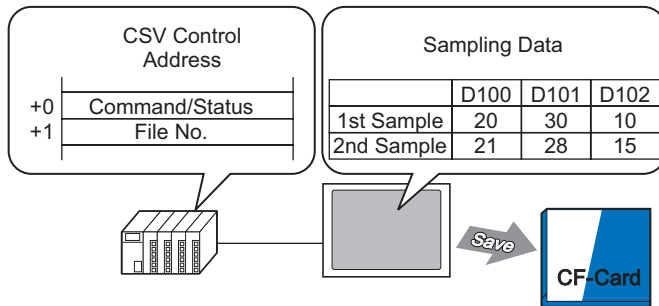

Store the File in the designated Control Address + 1, write a command to the Control Address and...

Sampling data in the GP is written in CSV format to the CF Card.

NOTE

- Sampling data (SA*****.csv) in the CF Card can be displayed on the GP using a Special Data Display [File Manager] and Special Data Display [Show CSV].
 ☞ "25.6 Displaying/Editing CSV data on the Screen" (page 25-29)
- If there is not enough free space on the CF Card, allocate more disk space by moving non-urgent data to USB memory.
 ☞ "A.5 Transferring Data Between a CF Card and a USB Memory Device" (page A-82)
- For more detailed information about CSV saving of sampling data, refer to the following.
 ☞ "24.9.4 About Save in CF Card/USB Storage" (page 24-138)

24.6.2 Setup Procedure

NOTE

- Please refer to the Settings Guide for details.
 ☞ "24.8.1 Common (Sampling) Settings Guide ■ Display/Save in CSV" (page 24-64)

Configure settings to save data from Sampling Group "1" to the CF Card.

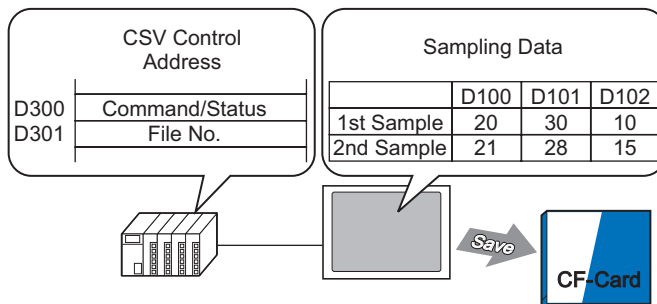

1 In the [Common Settings (R)] menu, select [Sampling (D)] or click , and a list of registered sampling groups appear. Double-click row 1 and the sampling group 1 setup screen appears.

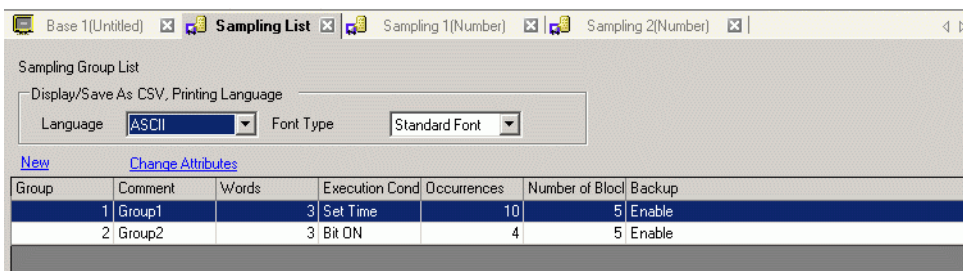

For information about Address/Action, see "24.3.2 Setup Procedure" (page 24-6)

2 Open the [Display/Save in CSV] tab. Select the [Display/Save in CSV] check box.

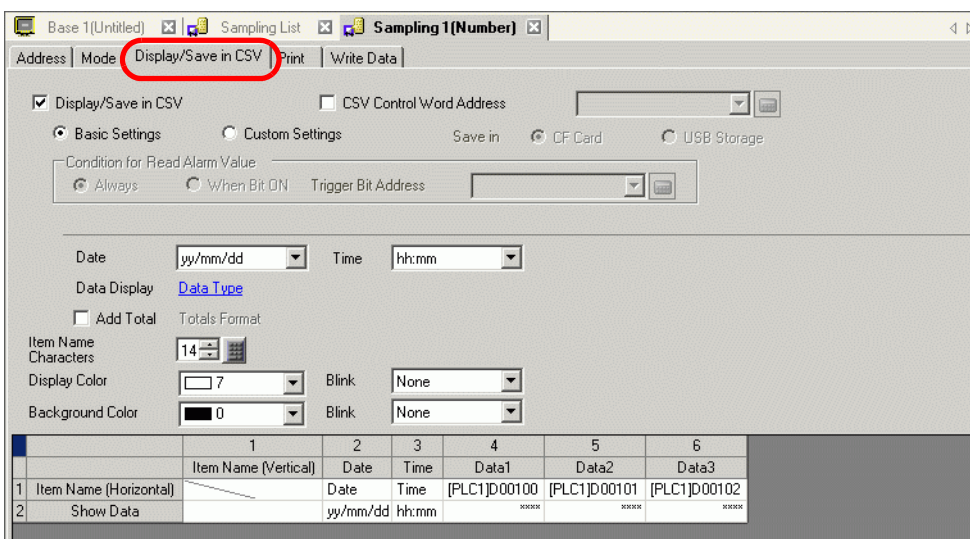

- 3 To control the save, select the [CSV Save Control Word Address] check box and click [Save in]-[CF Card] to set the word address (for example, D300).
Two consecutive words from the specified address are used.

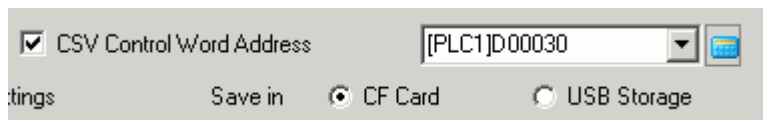

- 4 Click [Data Type Settings] to open the [Data Settings] dialog box. Set the data type and number of display digits as needed. The settings are applied to all the data columns.

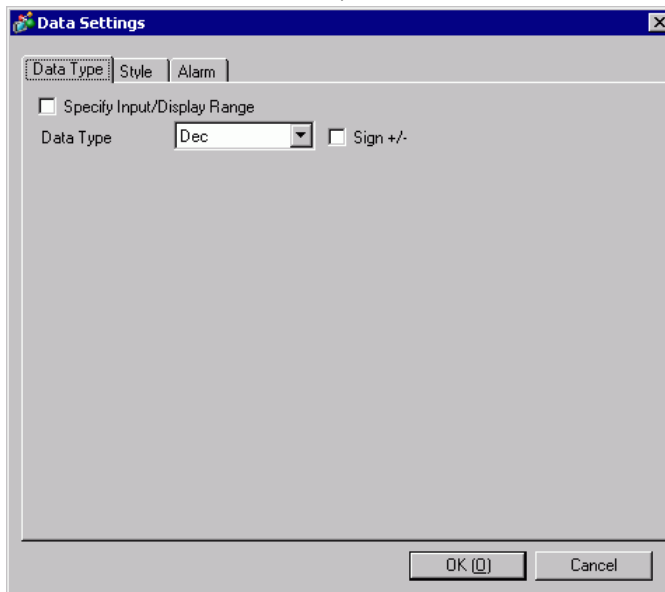
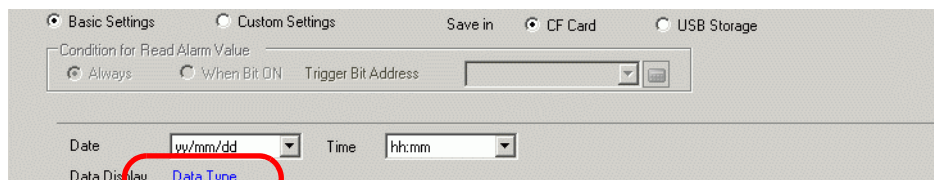

Click [OK] to close the dialog box.

- 5 Set the [Item Name Characters].

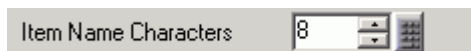

The CSV format is now complete.

NOTE

- Regardless of the [Date] and [Time] display settings, the CSV file will be outputted with the [yy:mm:dd] and [hh:mm:ss] format ([hh:mm:ss.ms] when the sampling cycle unit is [ms]).
- Regardless of whether a [Total] row is designated or not, calculation data will not be exported with the CSV file.

24.6.3 CF Card/USB Storage Save Operation

There are two save operations for CF Cards/USB storage devices.

- Normal Save
When the command is written to the [CSV Control Word Address], data stored in the GP is output as a CSV file.
☞ " ◆ Process for Normal Save" (page 24-24)
- Automatic Save
When the defined number of samples are stored in the GP and the sampling cycle is complete, data stored in the GP is output as a CSV file. This option is available when in the [Mode] tab, [Extended] dialog box, you select the [Overwrite old data after finishing the specified cycles] check box.
☞ " ◆ Process for Auto Save" (page 24-25)

■ CSV Control Word Address

This address controls the writing of data to a CF Card/USB storage device. It writes a command to the address after designating a file number.

CSV Control Word Address	Command/Status
+1	File No.

- Command/Status
Write the command with the specified file number to write the data to a CF Card/USB storage device. The processing results (status) are reflected in the address.

Mode	Word Data	Description
Command	0001h	Normal Save
	0020h	Start Auto Save (Only when data is stored by overwriting old data *1)
	0021h	End Auto Save (Only when data is stored by overwriting old data *1)
Status	0000h	Completed Successfully
	0100h	Write Error
	0200h	The CF Card is not inserted / CF Card hatch is open (access switch is OFF) / USB storage device is not inserted
	0300h	No data to be loaded (when no data is specified)
	0400h	File Error
	2000h	The GP is in the normal Auto Save mode. While the [CSV Save Control Address] is this value, the Auto Save action continues. When the value changes, the Auto Save mode finishes.

*1 For methods to store data, refer to "24.9.2 The Sampling Action ■ sampling" (page 24-128).

NOTE

- When you change the value of status "2000h" or change the file number in the process, the Auto Save is exited and the data up to then is written to the CF Card/USB storage device. The written value (command) is not processed.

- File Number

Designates the portion ***** the file name "SA*****.csv" when save to CF Card/USB storage. The file number can be from 0 to 65535. Set the file number before writing the command.

The CSV File is saved to the folder created in the CF Card/USB storage device automatically. The folder is created with a fixed folder name for each sampling group.

Data to be saved	Folder	File Name
Sampling Group 1's data	\SAMP01	SA*****.CSV
* * *	* * *	
Sampling Group 64's data	\SAMP64	SA*****.CSV

◆ **Process for Normal Save**

Save data from Sampling Group1 as file name "SA00001.csv" in the CF Card.

D300	Command/Status	←Store command "0001h"
D301	File No.	←Store "1"

- 1 In D301, store the File 1.
- 2 Write the command "0001h" to D300. The CSV output begins.
- 3 When the data is successfully saved to the CF Card, the status value "0000h" is written from the GP to D300.
"SA00001.csv" is created in the CF Card's "SAMP01" folder.

File Save Image

For example, [Overwrite old data after finishing the specified cycles] is selected,
Sampling Occurrences = 4

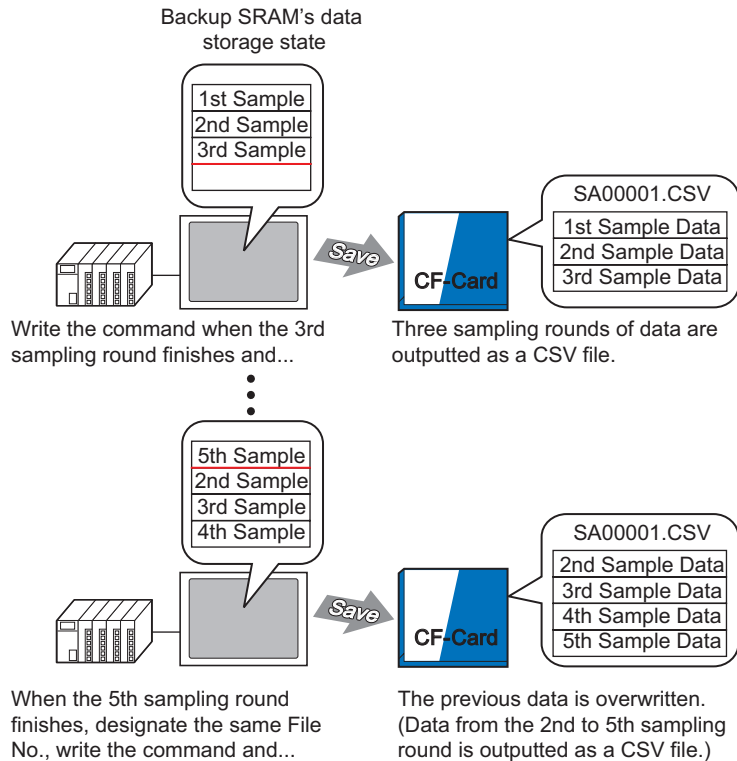

◆ Process for Auto Save

Save data from Sampling Group 1 as file name "SA00000.csv" in the CF Card.

D300	Command/Status	← Store command "0020h"
D301	File No.	← Store "0"

- 1 In D301, store the File 0.
- 2 Write the command "0020h" to D300. If the GP enters the Auto Save mode normally, the status "2000h" will be written from the GP to D300.
- 3 When data is sampled for the designated Occurrences, the CSV data is exported to the CF Card.
"SA00000.csv" is created in the CF Card's "SAMP01" folder.
- 4 When data is sampled for the designated Occurrences again, that period's CSV data is automatically exported and added to the existing "SA00000.csv" file in the "SAMP01" folder.
While D300 is "2000h" the Auto Save mode will continue.
- 5 Write the command "0021h" to D300, and the auto save mode ends. When the GP ends Auto Save mode, 0000h is written to D300.

File Save Image

For example, Sampling Occurrences = 4

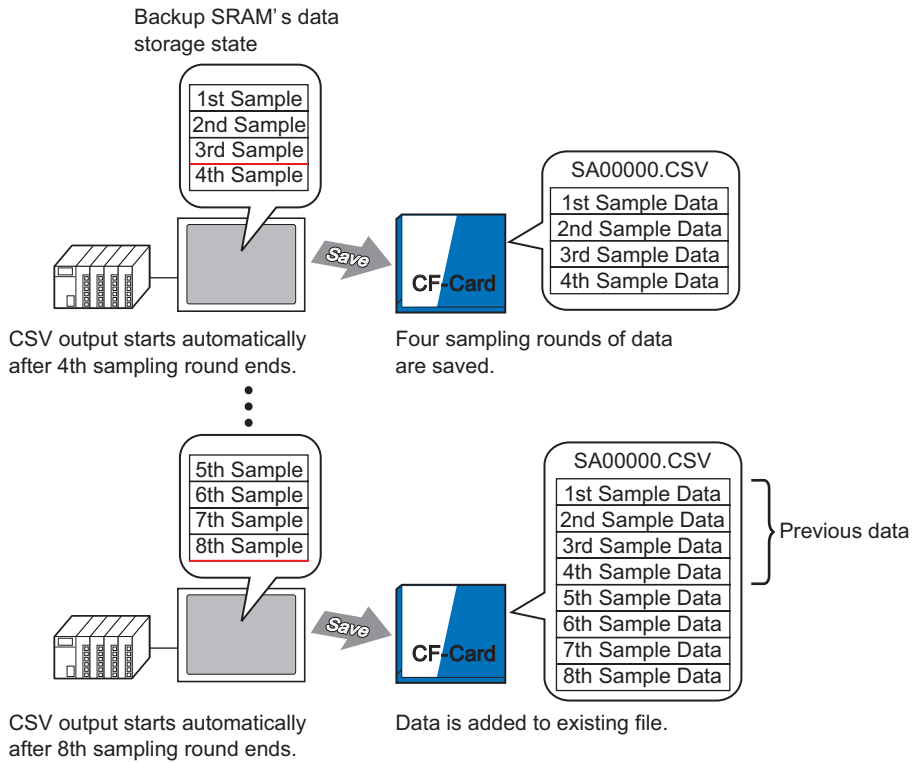

When Auto Save mode ends, even if there are contents still on the way to the GP (when the current sampling cycle has not completed), sampling data from up to that point will be written to the CF Card.

Also, when starting or resuming Auto Save (a Start Auto Save command is written), sampling data in the GP is written to the CF Card from the start data (the oldest data), regardless of the previous data save status.

NOTE

- When resuming Auto Save while contents are on the way to the GP, that cycle will finish sampling before the data is collected and written to the CF Card. After the Auto Save start command is written, overwritten data is not saved until it is written to the CF Card.

Auto Save Exiting and Resuming - File Save Image

For example, Sampling Occurrences = 4

Auto Save Exit

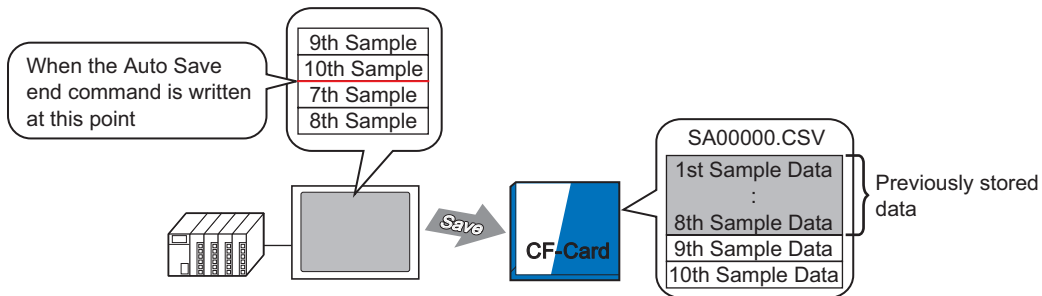

Write the Auto Save end command after the 10th sampling round and...

9th and 10th sample data is added to the previous data.

Auto Save Resume

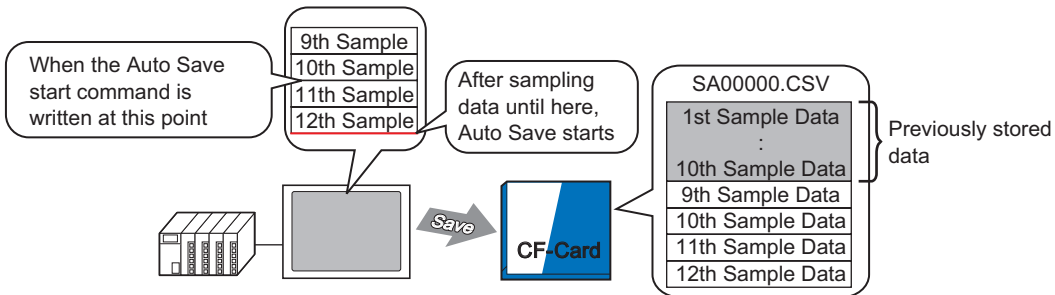

If you write the Auto Save start command during a sample cycle, system waits for that cycle to finish, then saves to the CF-card.

All data stored at this point (9th to 12th Sample) is added to previous data

■ CSV File Displayed in Excel

The following example will introduce the contents of a sampling data file (*.csv) saved to the CF Card and opened in Excel.

NOTE

- If the CSV file size is too large, Excel or other software may not be able to open it.
- Sampling data (*.csv) is outputted partly in a fixed format, regardless of the settings on the [Display/Save in CSV] tab. For more details, please refer to the following.
 "24.9.4 About Save in CF Card/USB Storage" (page 24-138)

◆ Automatic Save

(For example, Occurrences is 4 and data sampled for 2 cycles.)

CSV File

```

"" Date", " Time", " D00100", " D00200", " D00300", " D00301"
"05/03/31", "09:00:00", "3228", "30.3", "25.3", "6.1"
"05/03/31", "12:00:00", "3236", "26.4", "26.4", "6.4"
"05/03/31", "15:00:00", "3244", "28.6", "27.6", "6.2"
"05/03/31", "18:00:00", "3202", "30.7", "28.7", "6.5"
"05/04/01", "09:00:00", "3210", "26.9", "29.9", "6.3"
"05/04/01", "12:00:00", "3219", "29.2", "24.0", "6.0"
"05/04/01", "15:00:00", "3227", "31.1", "25.1", "6.3"
"05/04/01", "18:00:00", "3235", "27.3", "26.3", "6.1"
    
```

} 1st Cycle's Data
} 2nd Cycle Data



When opened in Excel:

Date	Time	D00100	D00200	D00300	D00301
2005/3/31	9:00:00	3228	30.3	25.3	6.1
2005/3/31	12:00:00	3236	26.4	26.4	6.4
2005/3/31	15:00:00	3244	28.6	27.6	6.2
2005/3/31	18:00:00	3202	30.7	28.7	6.5
2005/4/1	9:00:00	3210	26.9	29.9	6.3
2005/4/1	12:00:00	3219	29.2	24	6
2005/4/1	15:00:00	3227	31.1	25.1	6.3
2005/4/1	18:00:00	3235	27.3	26.3	6.1

◆ **Normal Save**

Normal Save occurs when the [Overwrite old data after finishing the specified cycles] check box is cleared in the [Mode] tab's Extended area.

CSV File

```

"" , "" , " Date" , " Time" , " D00001" , " D00002" , " D00003" , " D00004"
" " Group1" , "05/03/31" , "09:00:00" , "123.4" , "123" , "12.345" , "1234"
" " Group2" , "05/03/31" , "12:00:00" , "***.*" , "****" , " ** .****" , "*****"
" " Group3" , "05/03/31" , "15:00:00" , "234.5" , "234" , "23.456" , "2345"
" " Group4" , "05/03/31" , "18:00:00" , "-123.4" , "-123" , "-12.345" , "-1234"
"" , "" , "" , "" , "" , "" , ""
" " Group1" , "05/04/01" , "09:00:00" , "345.6" , "345" , "3.456" , "3456"
...
    
```

 When opened in Excel:

	Date	Time	D00001	D00002	D00003	D00004
No.1	2005/3/31	9:00:00	123.4	123	12.345	1234
No.2	2005/3/31	12:00:00	***.*	****	** .****	*****
No.3	2005/3/31	15:00:00	234.5	234	23.456	2345
No.4	2005/3/31	18:00:00	-123.4	-123	-12.345	-1234
No.1	2005/4/1	9:00:00	345.6	345	3.456	3456

24.7 Display/Save Sampled Data in CSV with a Custom Format

24.7.1 Introduction

You can use a customized format when displaying/saving in CSV.

You can set a customized format: sort data columns, set multiple calculation rows (Total, Average, Maximum, Minimum), input desired item names

Data displayed on the GP screen can be edited by touch.

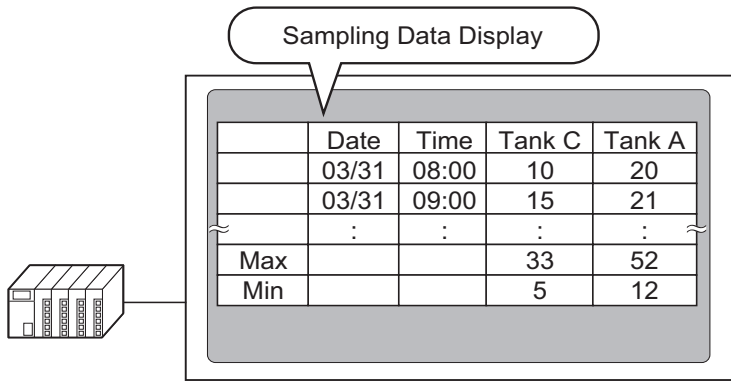

Sampling Data Display Format

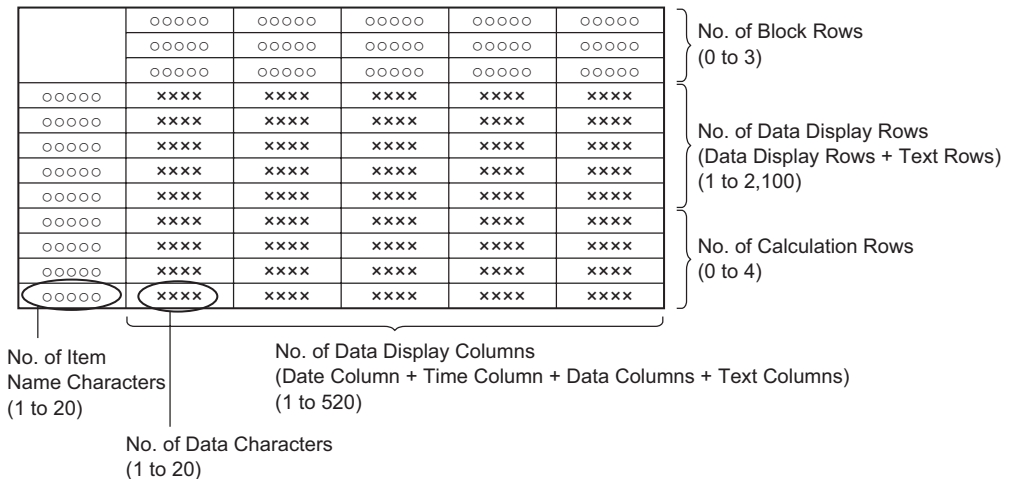

NOTE

- Text for the Item Name Rows and Item Name Columns can be set in the same manner as the Text Rows/Text Columns. Text can only be entered in the language set in the [Sampling List] [Language].
- The maximum number of columns is 521, and the maximum number of rows is 2107.

24.7.2 Setup Procedure

NOTE

- Please refer to the Settings Guide for details.
 - ☞ "24.8.1 Common (Sampling) Settings Guide ■ Display/Save in CSV (Custom Settings)" (page 24-77)
 - ☞ "24.8.2 Sampling Data Display Guide" (page 24-108)
- For details of the part placement method and the address, shape, color, and label setting method, refer to the "Part Editing Procedure".
 - ☞ "8.6.1 Editing Parts" (page 8-44)

Configure settings so that the display format for Sampling Group 1 is as follows.

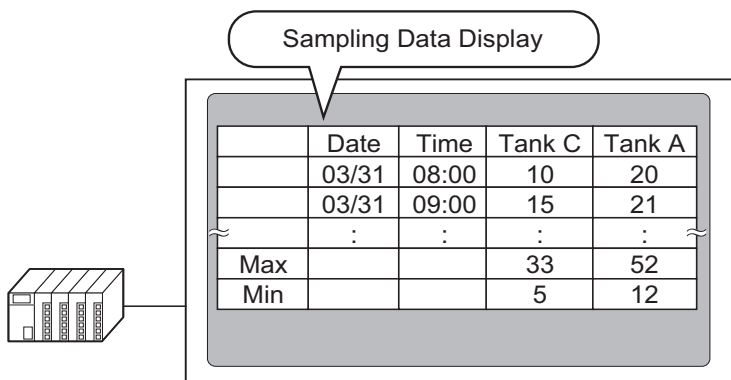

1 In the [Common Settings (R)] menu, select [Sampling (D)] or click , and a list of registered sampling groups appear. Double-click row 1 and the sampling group 1 setup screen appears.

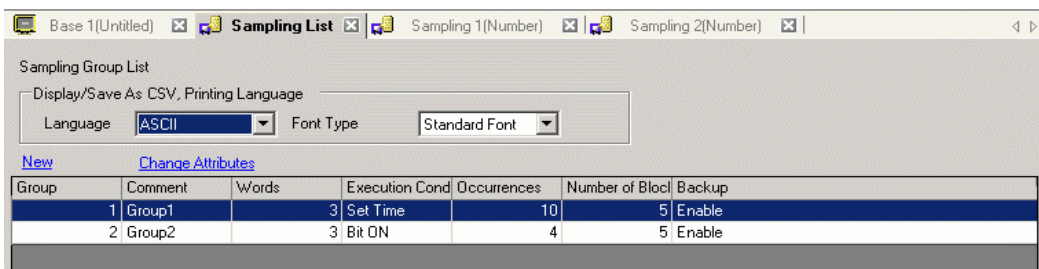

For information about Address/Action, see "24.3.2 Setup Procedure" (page 24-6)

2 Open the [Display/Save in CSV] tab.

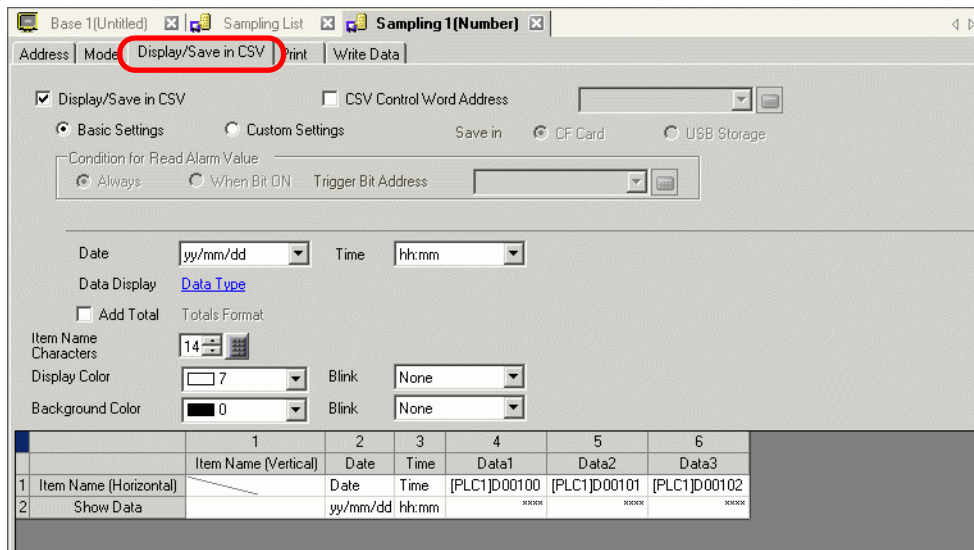

3 Select the [Display/Save in CSV] check box, and select [Custom Settings].

4 Set [Item Name (Horizontal) Rows] to 1, and [Calculation Result] to 2.

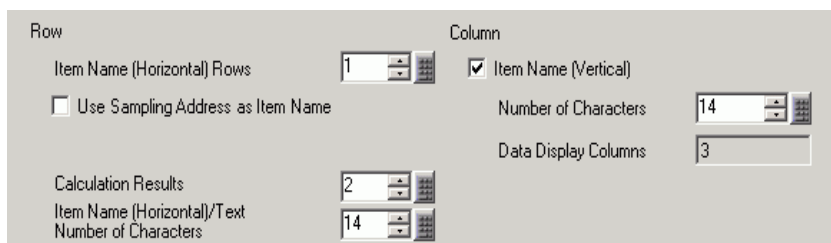

IMPORTANT

- When the [Overwrite old data after finishing the specified cycles] check box is cleared, set the [Data Display Rows]. Adjust the number of data display rows to match the number of sample occurrences.

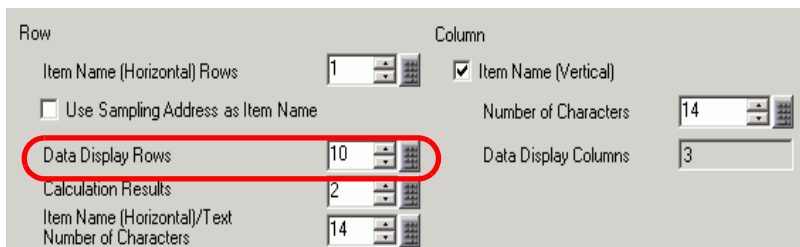

5 Select the Date column in the Preview area and click [Detail Settings]. The [Date Set] dialog box appears. Change the date form to [mm/dd].

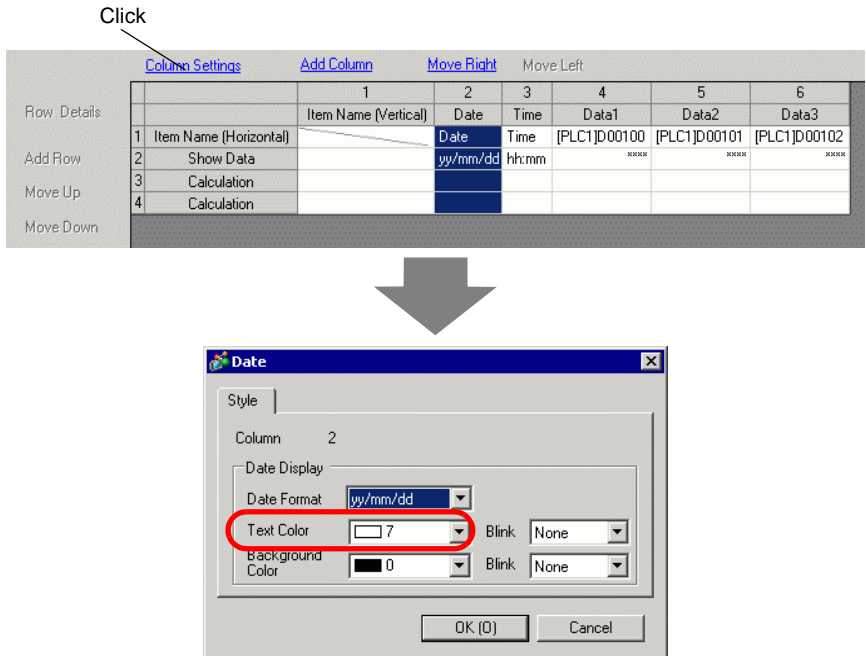

Click [OK] and the dialog box closes.

6 Delete the address D101 data column from the display format. Select the fifth column (Data 2) and click [Delete] key.

NOTE • It can be deleted by right-clicking the fifth column (Data 2) and clicking [Delete] in the menu

7 Double-click each Item Name (Horizontal) cell and input the Item Name.

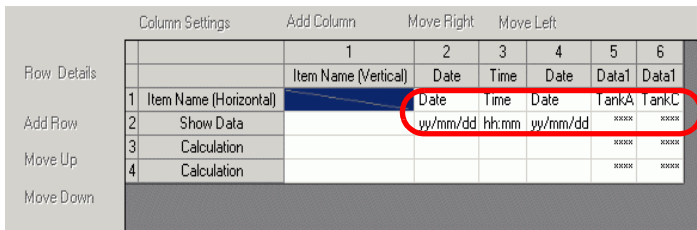

You can input text in the language designated in the Sampling List [Language].

8 Move the column. Select the fourth column (Data 1) and click [Move Right].

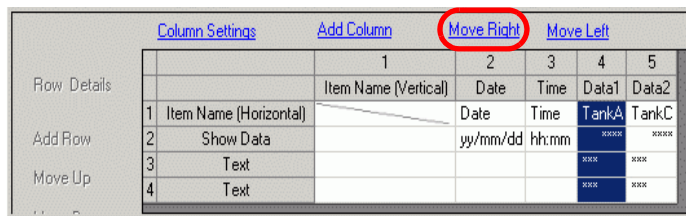

9 Select the third row and click [Row Details]. The [Calculation Settings] dialog box appears. Change the [Calculated Data] to [Max].

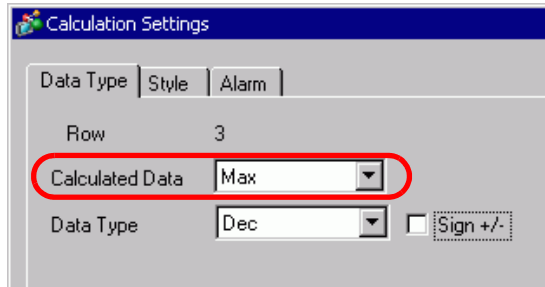
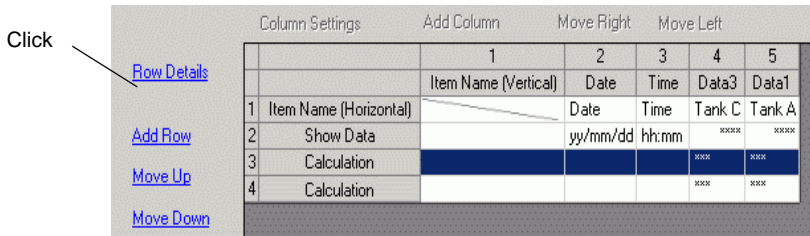

As needed, set the calculation row [Data Type], [Total Display Digits] and click [OK].

- NOTE**
- If you select a data column's calculation cell and click [Row Details], you can set [Data Type], or [Total Display Digits] independently.

10 Select the calculation data in the fourth row and set [Min] in the same way.

11 Double-click the calculation cells in the Item Name (Vertical) column and input the Item Name for each row.

The customized Display/Save in CSV format is now set.

- NOTE**
- The format of CSV files saved in a CF Card differs slightly from the state displayed on the setting screen. Refer to the following.
 - ☞ "24.9.4 About Save in CF Card/USB Storage ◆ Excel Display Example for Basic Settings" (page 24-140)
 - You can save sampling data to a CF card and USB storage device.

12 Open the editing screen, and on the [Parts (P)] menu select [Sampling Data Display (S)], or click , to place the Part on the screen.

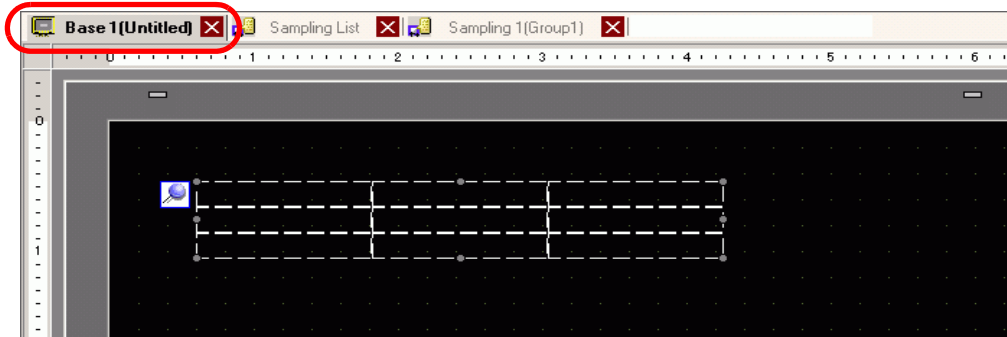

13 Double-click the placed Sampling Data Display. The settings dialog box appears.

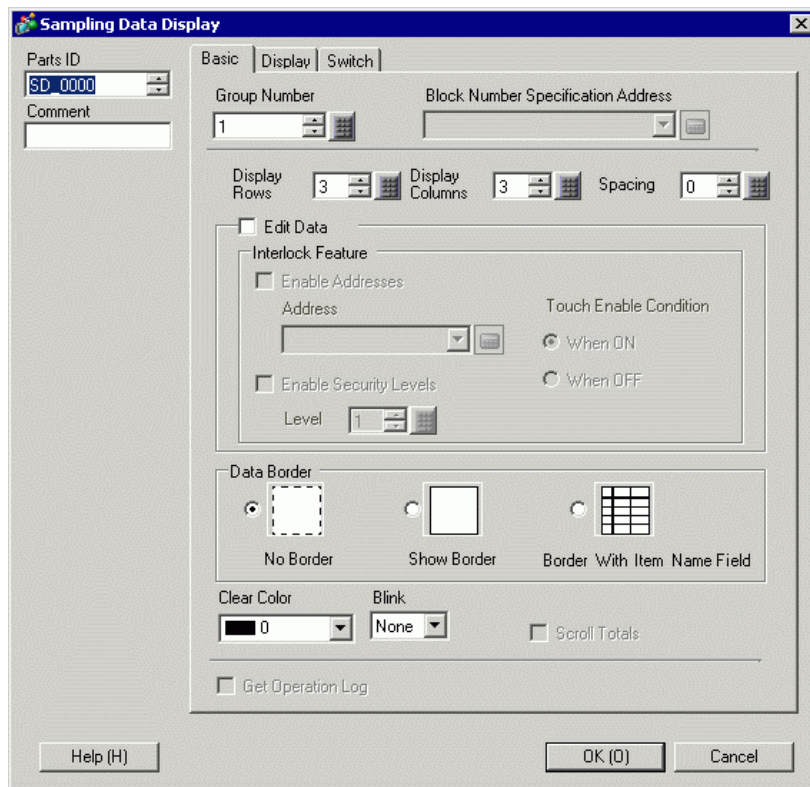

14 Define the sampling group you want to display on the screen. Set Sampling Group to "1".

NOTE	<ul style="list-style-type: none"> To display the sampling group, use the [Block Number Specification Address] to define which block to display. This field is enabled if in the [Common Settings (R)] workspace, [Sampling] screen, [Mode] tab, [Extended] area, the [Overwrite old data after finishing the specified cycles] check box is cleared.
-------------	--

15 Set the [Display Rows] and [Display Columns].

NOTE

- When you wish to edit the sampling data on the GP screen, select the [Edit Data] check box. The screen will change to the editing screen by touching the data, and the data can be edited by the keypad to be displayed.

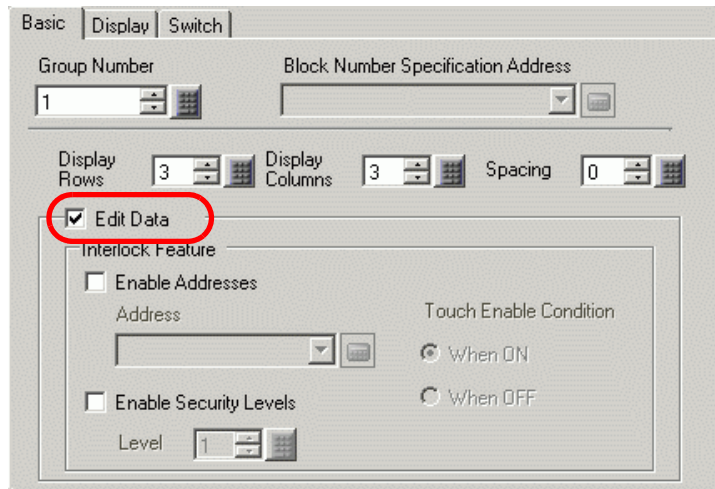

16 Select whether or not to show Ruled Line/Border and select the [Clear Color].



17 As needed, set the font size and scroll switch layout on the [Display] and [Switch] tabs and click [OK].

24.8 Settings Guide

24.8.1 Common (Sampling) Settings Guide

■ Sampling List

This screen is used to register new Sampling Groups. All registered Sampling Group settings are displayed in a list.

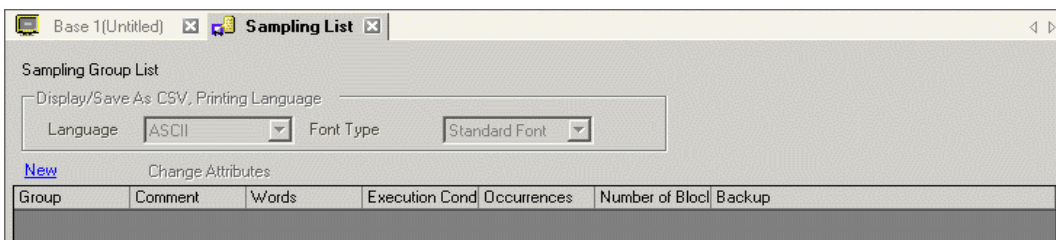

Setting	Description
Display/Save As CSV, Printing Language	Set the language used for display, saving to a CF card/USB storage, or printing.
Language	Choose from [Japanese], [ASCII], [Chinese (Traditional)], [Chinese (Simplified)], [Korean], [Cyrillic], or [Thai]. All registered sampling groups follow this setting.
Font Type	Select the font type, [Standard Font] or [Stroke Font], for saving to a CF Card/USB storage device (CSV Save) or printing. <ul style="list-style-type: none"> • Standard Font This is a Bitmap font. Choose the character height and width magnification ratio. When you magnify/shrink characters, the outline may become rough or the letter may appear compressed. • Stroke Font This is an outline font where the ratio of the character height/width is fixed. The letters will have a smooth outline even if you magnify/shrink them. However, this font uses more disk space on the GP.
New	Create a new Sampling Group. The following dialog box appears. <div data-bbox="595 1319 1044 1547" data-label="Image"> </div> <p>Set the [Group] from 1 to 64 and input a [Comment] of up to 30 single-byte characters. Click [OK] and the Sampling Group settings screen will appear.</p>
Change Attribute	Change the number and comment for the group selected in [Sampling Group List].

Continued

Setting	Description																												
Sampling Group List	<p>The registered Sampling Group settings are displayed in a list. Select and double-click a row and the Sampling Group setting screen appears.</p> <table border="1" data-bbox="399 278 1254 363"> <thead> <tr> <th>Number</th> <th>Comment</th> <th>Words</th> <th>Execution Cond</th> <th>Occurrences</th> <th>Number of Blocl</th> <th>Backup</th> </tr> </thead> <tbody> <tr> <td>1</td> <td>Group1</td> <td>3</td> <td>Set Time</td> <td>10</td> <td>1</td> <td>Enable</td> </tr> <tr> <td>2</td> <td>Group2</td> <td></td> <td>Bit ON</td> <td>4</td> <td>1</td> <td>Enable</td> </tr> <tr> <td>3</td> <td>Number</td> <td></td> <td>Set Time</td> <td>1</td> <td>5</td> <td>Enable</td> </tr> </tbody> </table> <ul style="list-style-type: none"> • Number Displays the Sampling Group • Comment Displays the Sampling Group comment. Comments can be edited and can be up to 30 single-byte characters. • Words Displays the [Sampling Words] (number of data sampled at one time) set on the [Address] tab. • Execution Condition Displays the [Execution Condition] set on the [Mode] tab. • Occurrences Displays the cycles when data sampling will occur, as set on the [Mode] tab. • Blocks Displays the [Number of Blocks] set in the [Mode] tab [Extended] dialog. If the [Overwrite old data after finishing the specified cycles] check box is selected, 1 will be displayed. However, if [Time Specification] is selected in Action, the [Number of Days] set in [Extended] is displayed. • Backup Displays whether [Backup to Internal Memory] is selected in the [Mode] tab. 	Number	Comment	Words	Execution Cond	Occurrences	Number of Blocl	Backup	1	Group1	3	Set Time	10	1	Enable	2	Group2		Bit ON	4	1	Enable	3	Number		Set Time	1	5	Enable
Number	Comment	Words	Execution Cond	Occurrences	Number of Blocl	Backup																							
1	Group1	3	Set Time	10	1	Enable																							
2	Group2		Bit ON	4	1	Enable																							
3	Number		Set Time	1	5	Enable																							

■ Address

Set the address to sample the data. Select the addressing method as [Sequential] or [Random].

NOTE

- When you change between [Random] [Sequential], all address fields and the [Display/Save in CSV] and [Print] settings are initialized.
- If [Random] is selected, it will take longer to communicate with the device than when [Sequential] is selected.

◆ Sequential

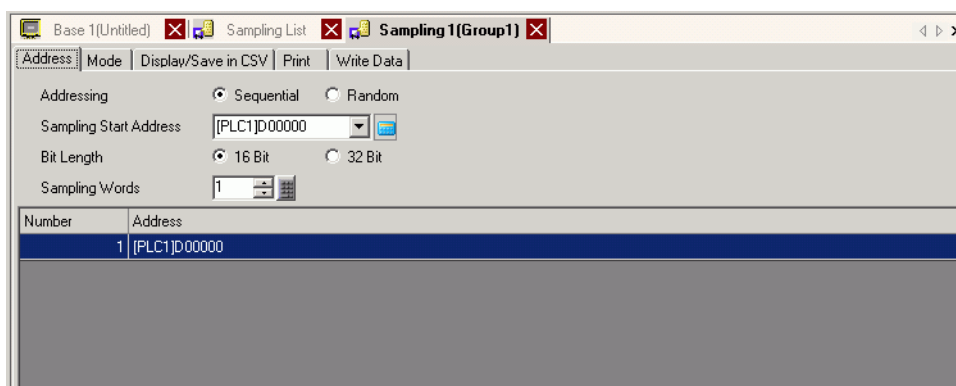

Setting	Description
Addressing	<p>Select the designation method for the addresses.</p> <ul style="list-style-type: none"> • Sequential Set the sequential addresses starting from the designated [Sampling Start Address]. • Random Set up to 512 addresses independently.
Sampling Start Address	Designate the top address to sample data.
Bit Length	<p>Choose which bit length the designated address data will be stored as, from either [16 Bit] or [32 Bit].</p> <p>NOTE</p> <ul style="list-style-type: none"> • If you change this setting, contents on the [Display/Save in CSV] tab and [Print] will be reset. • If the defined [Sampling Words] is above 256 16 Bit addresses, all addresses above 256 will be deleted when you change the [Bit Length] from [16 Bit] [32 Bit].
Sampling Words	<p>Set the number of data items (number of addresses) to sample. Each [Bit Length] has a different size range.</p> <p>16 Bit: 1 to 512 32 Bit: 1 to 256</p>
Address List	The number of addresses in [Sampling Words] are displayed in a list, starting from the designated [Sampling Start Address].

◆ Random

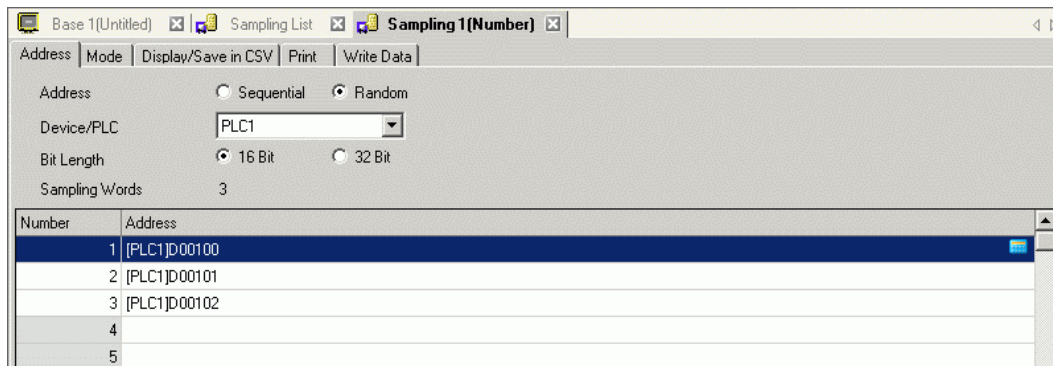

Setting	Description
Device/PLC	Designate the device/PLC where data will be sampled.
Bit Length	<p>Choose which bit length the designated address data will be stored as, from either [16 Bit] or [32 Bit].</p> <p>NOTE</p> <ul style="list-style-type: none"> • If you change this setting, contents on the [Display/Save in CSV] tab and [Print] will be reset. • If the defined [Sampling Words] is above 256 16 Bit addresses, all addresses above 256 will be deleted when you change the [Bit Length] from [16 Bit] [32 Bit].
Sampling Words	The set number of address will be displayed in [Address List].
Address List	<p>The number of addresses in [Sampling Words] are displayed in a list, starting from the designated [Sampling Start Address]. Each [Bit Length] has a different size range.</p> <p>16 Bit: 1 to 512 rows 32 Bit: 1 to 256 rows</p>

NOTE

- When you select the row you want to delete from the address list and press the [Delete] key, the delete confirmation dialog box will appear. You can delete it by clicking [Yes].

■ **Mode**

Configure the timing and Occurrences settings for data sampling. You can select the Sampling action's execution condition from [Time Specification], [Constant Cycle], [Constant Cycle when Bit is ON], [Bit ON], or [Bit Change].

◆ **Time Specification**

Sample data at constant cycles starting from the designated time.

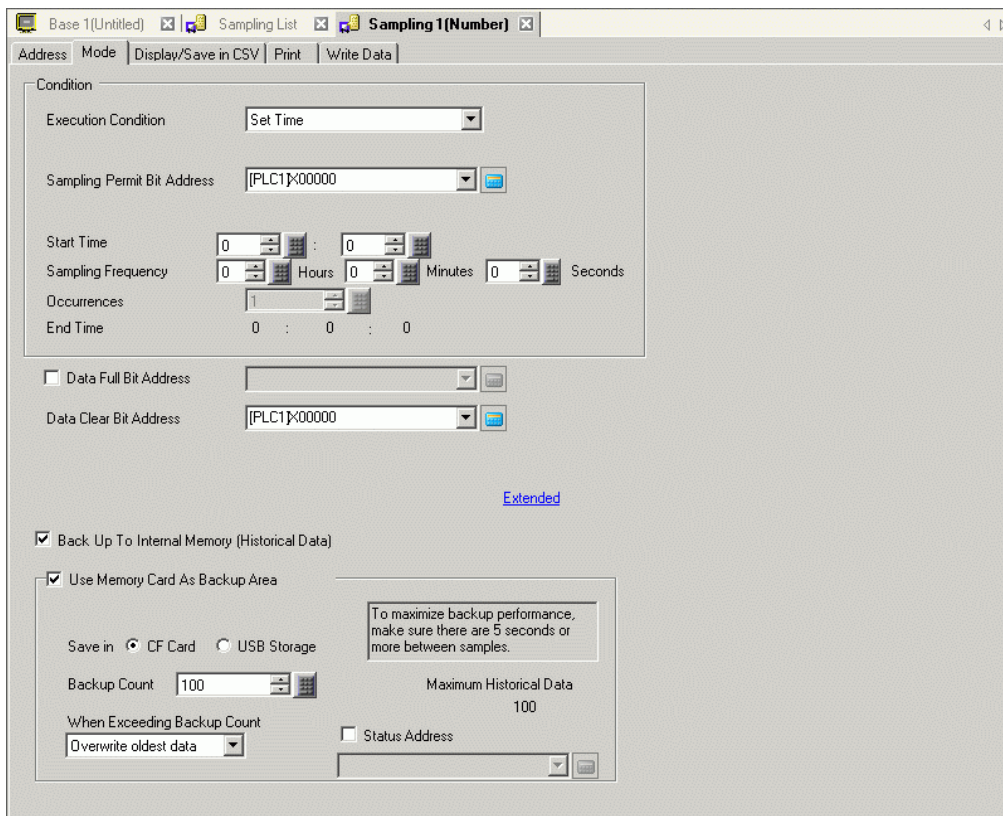

Setting	Description
Execution Condition	Select the sampling action execution condition. Select [Time Specification].
Sampling Permit Bit Address	Select the address which will control whether or not sampling will execute. When this address is ON, sampling will begin at the designated [Start Time], and after that, read in data at each cycle of the set [Sampling Cycle]. When this address is OFF, sampling will not occur even when the [Start Time] is reached.
Start Time	Designate the sampling action's start time. Set the time from 0 to 23 (hour), and 0 to 59 (minute).
Sampling Frequency	Set the period that sampling will occur in 15-second increments from 0 sec. to 23 hours, 59 minutes, 45 sec.

Continued

Setting	Description
Occurrences	<p>Select the number of times sampling will occur. If in the [Extended] area the [Overwrite old data after finishing the specified cycles] check box is selected, this can be from 1 to 65535 times. If the check box is cleared, the range is from 1 to 2048 times.</p> <p>IMPORTANT</p> <ul style="list-style-type: none"> The settings range will be limited to ensure that the period from [Start Time] to [End Time] is within 24 hours. As well, the number of sampling groups and number of addresses (number of words) in the whole system will also be limited.
End Time	<p>Set the [Start Time], [Sampling Cycle], [Number of Times], and the sampling end time will be displayed.</p>
Data Full Bit Address	<p>After all the sampling is completed (after the designated [Number of Times] * [Blocks], or [Number of Times] * [Number of Days]) this bit address will turn ON to confirm that the operation is finished. To confirm, set this address.</p> <p>In the Extended area, when the [Overwrite old data after finishing the specified cycles] check box is selected, this bit tells when a data sampling cycle has been done. The sampling action will continue running even when this bit is ON.</p> <p>If not designated, the sampling action will end when this bit turns ON. Please turn ON the [Data Clear Bit Address] to resume.</p> <p>NOTE</p> <ul style="list-style-type: none"> This address is not turned OFF automatically. If the [Overwrite old data after finishing the specified cycles] check box is selected, please ensure that the bit is turned OFF in order to confirm the next sampling cycle.
Data Clear Bit Address	<p>Designate the bit address to control the clearing of the sampling data. When this address turns ON, all the Sampling Group data stored in the GP will be erased. After clearing the data, this bit will turn OFF.</p>
Backup to Internal Memory (Display Historical Data)	<p>Select whether or not to save the sampling data to the backup SRAM. If the sampling data is not saved, the data will be deleted when the power to the GP unit is turned OFF or reset.</p> <p>☞ "24.9.1 Summary ■ Backup SRAM" (page 24-116)</p>
Use Memory Card as Backup Area	<p>Indicates whether data saved in the backup SRAM is written to the location specified in [Save in]. The data is saved in Bin format.</p> <p>☞ "24.9.1 Summary ◆ Backup Sampled Data" (page 24-119)</p> <p>NOTE</p> <ul style="list-style-type: none"> When selecting this item, precautions on backup to a memory card and the maximum number of historical data that can be displayed in the Historical Trend Graph are displayed on the right-hand side. The maximum number is "Number of Times" of the condition x "Backup Count".

Continued

Setting	Description
Save in	<p>Select the "Save in" location of the backup data, from [CF card] and [USB storage].</p> <p>Folders are automatically created for each sampling group in the "Save in" location. The saved file name will be Time Stamp (year/month/day/hour/minute/second when saved).</p> <p>For example, when it is saved at 14:30:5 on July 2 in 2007 SAMP**T070702_143005.bin ("**" means sampling group number and "" means index number)</p> <p>NOTE</p> <ul style="list-style-type: none"> The index number for file names is from 0 to 9. You can save up to 10 files at the same time.
Backup Count	Specify the number of times (1 to 500) to write the backup data. The number specified here is the number of files that will be created.
When Exceeding Backup Count	<p>Select an action when the number of backup files exceeds the value set in the Backup Count.</p> <ul style="list-style-type: none"> Overwrite oldest data Delete the oldest file and add a new file. Interrupt Backup Stops backup. "1001" (number of files exceeded) is stored in the status address.

Continued

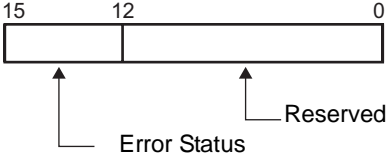
Setting	Description																											
Status Address	<p>Indicates whether the saved operation status and error information are stored in the specified address.</p>																											
																												
	<p>The error status indicates the following error codes. (Error Code)</p>																											
	<table border="1"> <thead> <tr> <th data-bbox="399 523 563 556">Bit 12 to 15</th> <th data-bbox="563 523 814 556">Description</th> <th data-bbox="814 523 1226 556">Details</th> </tr> </thead> <tbody> <tr> <td data-bbox="399 556 563 620">0000</td> <td data-bbox="563 556 814 620">Completed Successfully</td> <td data-bbox="814 556 1226 620">Transfer completed successfully.</td> </tr> <tr> <td data-bbox="399 620 563 653">0001 to 0011</td> <td data-bbox="563 620 814 653">Reserved</td> <td data-bbox="814 620 1226 653">-</td> </tr> <tr> <td data-bbox="399 653 563 774">0100</td> <td data-bbox="563 653 814 774">No CF Card/USB storage</td> <td data-bbox="814 653 1226 774">The CF card/USB drive is not inserted or the hatch of the CF card is opened while saving a backup data file (Bin format).</td> </tr> <tr> <td data-bbox="399 774 563 973">0101</td> <td data-bbox="563 774 814 973">Write error to CF Card/USB storage</td> <td data-bbox="814 774 1226 973">The capacity of the CF card/USB drive is insufficient or the CF card/USB drive was removed while saving a backup data file in Bin format. 10 backup data files with the same time stamp already exist because the GP time set was restored, etc.</td> </tr> <tr> <td data-bbox="399 973 563 1006">0110</td> <td data-bbox="563 973 814 1006">Reserved</td> <td data-bbox="814 973 1226 1006">-</td> </tr> <tr> <td data-bbox="399 1006 563 1070">0111</td> <td data-bbox="563 1006 814 1070">CF Card Error</td> <td data-bbox="814 1006 1226 1070">Occurs when the CF card is unformatted.</td> </tr> <tr> <td data-bbox="399 1070 563 1103">1000</td> <td data-bbox="563 1070 814 1103">Reserved</td> <td data-bbox="814 1070 1226 1103">-</td> </tr> <tr> <td data-bbox="399 1103 563 1166">1001</td> <td data-bbox="563 1103 814 1166">Excess Number of Files</td> <td data-bbox="814 1103 1226 1166">Exceeded number of files set</td> </tr> </tbody> </table>	Bit 12 to 15	Description	Details	0000	Completed Successfully	Transfer completed successfully.	0001 to 0011	Reserved	-	0100	No CF Card/USB storage	The CF card/USB drive is not inserted or the hatch of the CF card is opened while saving a backup data file (Bin format).	0101	Write error to CF Card/USB storage	The capacity of the CF card/USB drive is insufficient or the CF card/USB drive was removed while saving a backup data file in Bin format. 10 backup data files with the same time stamp already exist because the GP time set was restored, etc.	0110	Reserved	-	0111	CF Card Error	Occurs when the CF card is unformatted.	1000	Reserved	-	1001	Excess Number of Files	Exceeded number of files set
	Bit 12 to 15	Description	Details																									
	0000	Completed Successfully	Transfer completed successfully.																									
	0001 to 0011	Reserved	-																									
	0100	No CF Card/USB storage	The CF card/USB drive is not inserted or the hatch of the CF card is opened while saving a backup data file (Bin format).																									
	0101	Write error to CF Card/USB storage	The capacity of the CF card/USB drive is insufficient or the CF card/USB drive was removed while saving a backup data file in Bin format. 10 backup data files with the same time stamp already exist because the GP time set was restored, etc.																									
	0110	Reserved	-																									
0111	CF Card Error	Occurs when the CF card is unformatted.																										
1000	Reserved	-																										
1001	Excess Number of Files	Exceeded number of files set																										

Extended

Click [Extended] and the following dialog box will open. The contents is different depending on whether the [Overwrite old data after finishing the specified cycles] check box is selected or cleared.

When [Overwrite old data after finishing the specified cycles] is selected

When [Overwrite old data after finishing the specified cycles] is cleared

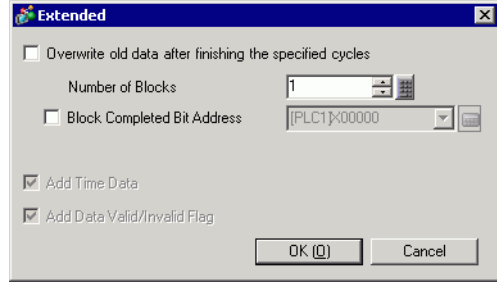
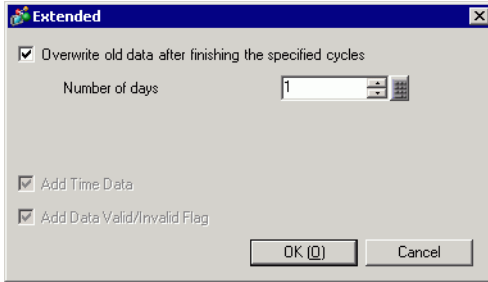

Setting	Description
<p>Overwrite old data after finishing the specified cycles</p>	<p>Select whether or not the data will be overwritten and stored, starting with the oldest data, after data has been sampled the designated number of times.</p> <p>If this is set, even when all the data sampling has completed ([Number of Times] x [Number of Days]), sampling will continue and data, starting with old data, will be overwritten.</p> <p>If this is not set, previous data will not be overwritten. The new rounds of data will be stored as separate blocks. After all data has been stored ([Number of Times] x [Blocks]), sampling will not occur until all stored data has been deleted.</p> <div style="display: flex; justify-content: space-around; align-items: flex-start;"> <div style="text-align: center;"> <p><input checked="" type="checkbox"/> Overwrite old data after finishing the specified cycles</p> <p>(n: No. of Times, m: No. of Days)</p> </div> <div style="text-align: center;"> <p><input type="checkbox"/> Overwrite old data after finishing the specified cycles</p> <p>(n: No. of Times, m: No. of Blocks)</p> </div> </div>

Continued

Setting	Description
Number of Days	Designate how much sampling data should be maintained inside backup SRAM (or DRAM). Data from the designated number of days is stored, and then overwritten in order, starting with data on the first day. The setting range is from 1 to 2048. The setting range is limited to ensure that the amount of [Number of Times] x [Number of Days] is 65535 or less.
Blocks	The complete set of data collected in the designated number of times is called a [block]. Designate the number of blocks to set inside one Sampling Group. The setting range is from 1 to 2048. The setting range will automatically be limited to ensure that the amount of [Number of Times] x [Blocks] is 65535 or less.
Block Full Bit Address	<p>After the sampling for one block of data (the designated number of times) is completed, this bit address will turn ON to confirm that the operation is finished. To confirm, set this address.</p> <p>This tells that one block's sampling has completed. The sampling action will still continue for the designated [Blocks].</p> <p>NOTE</p> <ul style="list-style-type: none"> • This address is not turned OFF automatically. In order to verify the completion of the next block, please ensure that this bit is returned to OFF.
Add Time Data	The sample time will be stored along with the sampled data. This setting is fixed.
Add Data Valid/Invalid Flag	Stores an observation flag along with the data which monitors if the data has been saved properly. This setting is fixed.

◆ **Constant Cycle**

Sample data at constant cycles starting from when the GP is turned ON.

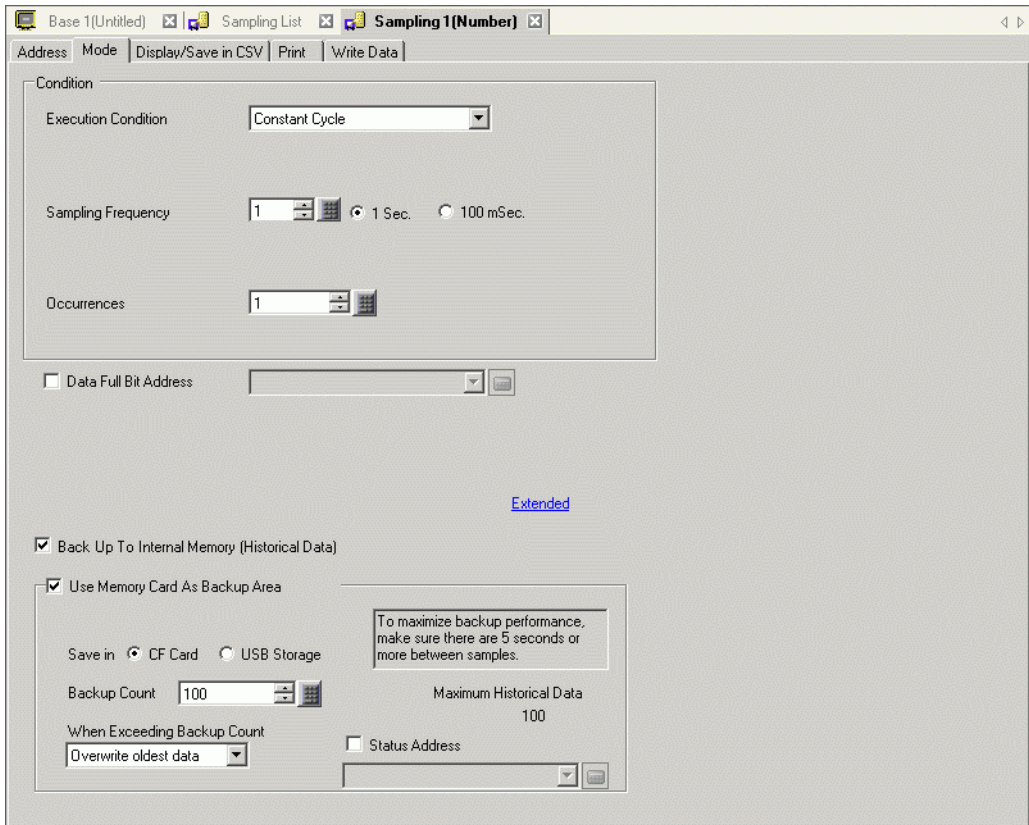

Setting	Description
Execution Condition	Select the sampling action execution condition. Select [Constant Cycle].
Sampling Frequency	Specify the sampling cycle at 1 sec (1 second) or 100 ms (100 millisecond). Set 1 to 65535 when the unit is 1 sec and 100 to 900 when the unit is 100ms. NOTE <ul style="list-style-type: none"> • Even when 100ms (millisecond) is set, only first sampling will begin at 1 sec (second) timing.
Occurrences	Select the number of times sampling will occur. The setting range is from 1 to 65535. IMPORTANT <ul style="list-style-type: none"> • The setting range is limited by the number of sampling groups and addresses (words) registered in the entire system.

Continued

Setting	Description
Data Full Bit Address	<p>After the designated number of data samples are completed, this address will be used to confirm that the operation is finished. Select whether or not to verify this bit address.</p> <p>This bit tells when a data sampling cycle is complete. The sampling operation will continue running even when this bit is ON.</p> <p>NOTE</p> <ul style="list-style-type: none"> This address is not turned OFF automatically. In order to verify the next sampling cycle, please ensure that this bit is returned to the OFF state.
Backup to Internal Memory (Display Historical Data)	<p>Select whether or not to save the sampling data to the backup SRAM. If the sampling data is not saved, the data will be deleted when the power to the GP unit is turned OFF or reset.</p> <p>☞ "24.9.1 Summary ■ Backup SRAM" (page 24-116)</p>
Use Memory Card as Backup Area	<p>Indicates whether data saved in the backup SRAM is written to the location specified in [Save in]. The data is saved in Bin format.</p> <p>☞ "24.9.1 Summary ◆ Backup Sampled Data" (page 24-119)</p> <p>NOTE</p> <ul style="list-style-type: none"> When selecting this item, precautions on backup to a memory card and the maximum number of historical data that can be displayed in the Historical Trend Graph are displayed on the right-hand side. The maximum number is "Number of Times" of the condition x "Backup Count".
Save in	<p>Select the "Save in" location of the backup data, from [CF card] and [USB storage].</p> <p>Folders are automatically created for each sampling group in the "Save in" location. The saved file name will be Time Stamp (year/month/day/hour/minute/second when saved).</p> <p>For example, when it is saved at 14:30:5 on July 2 in 2007 SAMP**T070702_143005.bin ("**" means sampling group number and "" means index number)</p> <p>NOTE</p> <ul style="list-style-type: none"> The index number for file names is from 0 to 9. You can save up to 10 files at the same time.
Backup Count	<p>Specify the number of times (1 to 500) to write the backup data. The number specified here is the number of files that will be created.</p>
When Exceeding Backup Count	<p>Select an action when the number of backup files exceeds the value set in the Backup Count.</p> <ul style="list-style-type: none"> Overwrite oldest data Delete the oldest file and add a new file. Interrupt Backup Stops backup. "1001" (number of files exceeded) is stored in the status address.

Continued

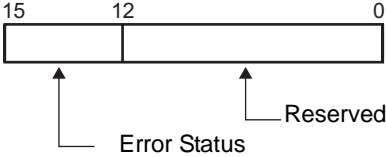
Setting	Description																											
Status Address	<p>Indicates whether the saved operation status and error information are stored in the specified address.</p>																											
																												
	<p>The error status indicates the following error codes. (Error Code)</p>																											
	<table border="1"> <thead> <tr> <th data-bbox="408 498 573 537">12 to 15</th> <th data-bbox="573 498 825 537">Description</th> <th data-bbox="825 498 1237 537">Details</th> </tr> </thead> <tbody> <tr> <td data-bbox="408 537 573 595">0000</td> <td data-bbox="573 537 825 595">Completed Successfully</td> <td data-bbox="825 537 1237 595">Transfer completed successfully.</td> </tr> <tr> <td data-bbox="408 595 573 633">0001 to 0011</td> <td data-bbox="573 595 825 633">Reserved</td> <td data-bbox="825 595 1237 633">-</td> </tr> <tr> <td data-bbox="408 633 573 749">0100</td> <td data-bbox="573 633 825 749">No CF Card/USB storage</td> <td data-bbox="825 633 1237 749">The CF card/USB drive is not inserted or the hatch of the CF card is opened while saving a backup data file (Bin format).</td> </tr> <tr> <td data-bbox="408 749 573 950">0101</td> <td data-bbox="573 749 825 950">Write Error</td> <td data-bbox="825 749 1237 950">The capacity of the CF card/USB drive is insufficient or the CF card/USB drive was removed while saving a backup data file in Bin format. 10 backup data files with the same time stamp already exist because the GP time set was restored, etc.</td> </tr> <tr> <td data-bbox="408 950 573 989">0110</td> <td data-bbox="573 950 825 989">Reserved</td> <td data-bbox="825 950 1237 989">-</td> </tr> <tr> <td data-bbox="408 989 573 1047">0111</td> <td data-bbox="573 989 825 1047">CF Card Error</td> <td data-bbox="825 989 1237 1047">Occurs when the CF card is unformatted.</td> </tr> <tr> <td data-bbox="408 1047 573 1085">1000</td> <td data-bbox="573 1047 825 1085">Reserved</td> <td data-bbox="825 1047 1237 1085">-</td> </tr> <tr> <td data-bbox="408 1085 573 1147">1001</td> <td data-bbox="573 1085 825 1147">Excess Number of Files</td> <td data-bbox="825 1085 1237 1147">Exceeded number of files set</td> </tr> </tbody> </table>	12 to 15	Description	Details	0000	Completed Successfully	Transfer completed successfully.	0001 to 0011	Reserved	-	0100	No CF Card/USB storage	The CF card/USB drive is not inserted or the hatch of the CF card is opened while saving a backup data file (Bin format).	0101	Write Error	The capacity of the CF card/USB drive is insufficient or the CF card/USB drive was removed while saving a backup data file in Bin format. 10 backup data files with the same time stamp already exist because the GP time set was restored, etc.	0110	Reserved	-	0111	CF Card Error	Occurs when the CF card is unformatted.	1000	Reserved	-	1001	Excess Number of Files	Exceeded number of files set
	12 to 15	Description	Details																									
	0000	Completed Successfully	Transfer completed successfully.																									
	0001 to 0011	Reserved	-																									
	0100	No CF Card/USB storage	The CF card/USB drive is not inserted or the hatch of the CF card is opened while saving a backup data file (Bin format).																									
	0101	Write Error	The capacity of the CF card/USB drive is insufficient or the CF card/USB drive was removed while saving a backup data file in Bin format. 10 backup data files with the same time stamp already exist because the GP time set was restored, etc.																									
	0110	Reserved	-																									
0111	CF Card Error	Occurs when the CF card is unformatted.																										
1000	Reserved	-																										
1001	Excess Number of Files	Exceeded number of files set																										

Extended

Click [Extended] and the following dialog box appears.

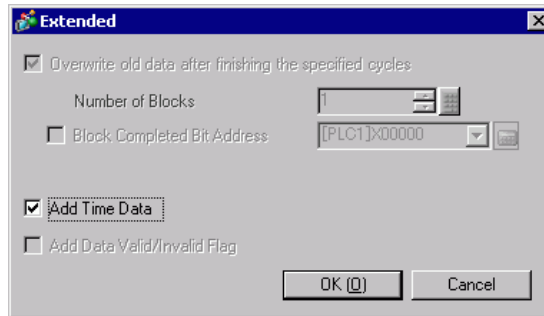

Setting	Description
Overwrite old data after finishing the specified cycles	Data will be overwritten and stored, starting with the oldest data, after data has been sampled the designated number of times. This setting is fixed.
Add Time Data	<p>Select whether or not to store the sample time along with the sampled data. If this is not designated, when displaying/saving in CSV or printing, the date/time columns will be blank.</p> <p>NOTE</p> <ul style="list-style-type: none"> When using the [Show Cursor] feature for the [Historical Trend Graph], this setting must be used for the Show Cursor feature to function. <ul style="list-style-type: none"> ☞ "18.12.2 Historical Trend Graph Settings Guide ◆ Display Historical Data" (page 18-81)

◆ **Constant Cycle when Bit is ON**

Sample data at constant cycles starting from when the GP is turned ON, but only when the designated bit is ON.

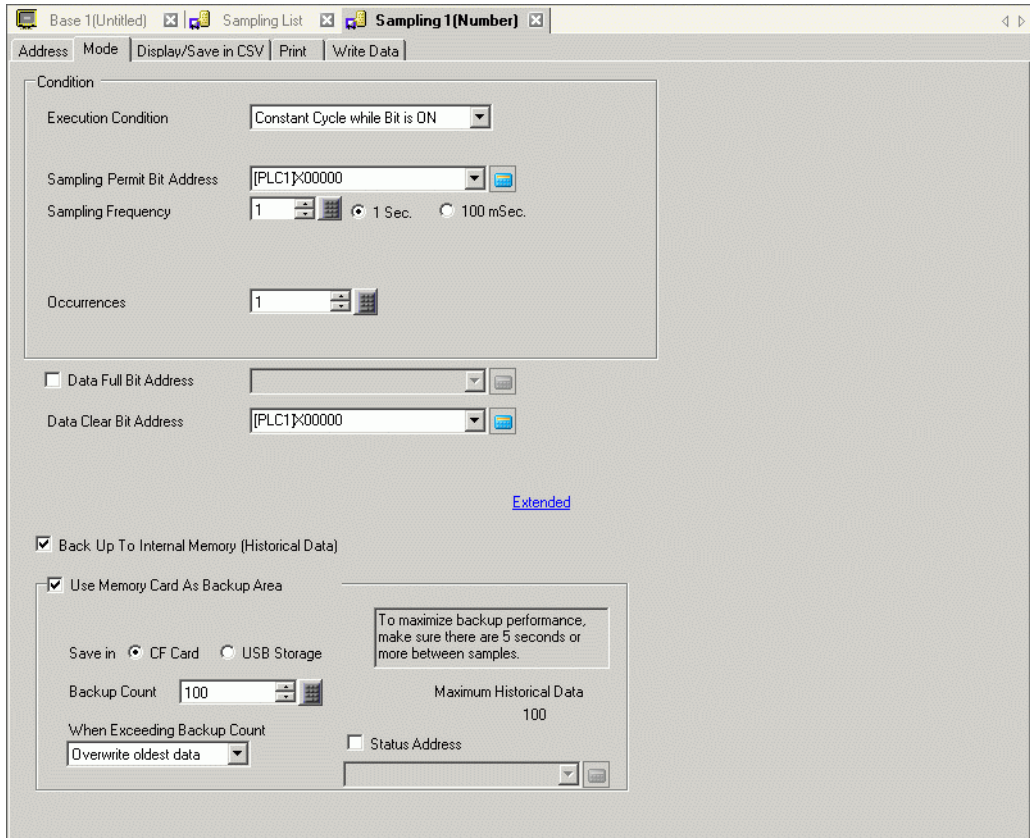

Setting	Description
Execution Condition	Select the sampling action execution condition. Select [Constant Cycle when Bit is ON].
Sampling Permit Bit Address	Select the address which will control whether or not sampling will execute. While this address is ON, data will be read each cycle.
Sampling Frequency	Specify the sampling cycle at 1 sec (second) or 100ms (millisecond). Set 1 to 65535 when the unit is 1 sec and 100 to 900 when the unit is 100ms. NOTE <ul style="list-style-type: none"> • Even when 100ms (millisecond) is set, only first sampling will begin at 1 sec (second) timing.
Occurrences	Select the number of times sampling will occur. The setting range is from 1 to 65535. IMPORTANT <ul style="list-style-type: none"> • The setting range is limited by the number of sampling groups and addresses (words) registered in the entire system.

Continued

Setting	Description
Data Full Bit Address	<p>After the designated number of data samples are completed, this address will be used to confirm that the operation is finished. Select whether or not to verify this bit address.</p> <p>This bit tells when a data sampling cycle is complete. The sampling operation will continue running even when this bit is ON.</p> <p>NOTE</p> <ul style="list-style-type: none"> This address is not turned OFF automatically. In order to verify the next sampling cycle, please ensure that this bit is returned to the OFF state.
Data Clear Bit Address	<p>Designate the bit address to control the clearing of the sampling data. When this address turns ON, all the Sampling Group data stored in the GP will be erased. After clearing the data, this bit will turn OFF.</p>
Backup to Internal Memory (Display Historical Data)	<p>Select whether or not to save the sampling data to the backup SRAM. If the sampling data is not saved, the data will be deleted when the power to the GP unit is turned OFF or reset.</p> <p>☞ "24.9.1 Summary ■ Backup SRAM" (page 24-116)</p>
Use Memory Card as Backup Area	<p>Indicates whether data saved in the backup SRAM is written to the location specified in [Save in]. The data is saved in Bin format.</p> <p>☞ "24.9.1 Summary ◆ Backup Sampled Data" (page 24-119)</p> <p>NOTE</p> <ul style="list-style-type: none"> When selecting this item, precautions on backup to a memory card and the maximum number of historical data that can be displayed in the Historical Trend Graph are displayed on the right-hand side. The maximum number is "Number of Times" of the condition x "Backup Count".
Save in	<p>Select the "Save in" location of the backup data, from [CF card] and [USB storage].</p> <p>Folders are automatically created for each sampling group in the "Save in" location. The saved file name will be Time Stamp (year/month/day/hour/minute/second when saved).</p> <p>For example, when it is saved at 14:30:5 on July 2 in 2007 SAMP**T070702_143005.bin ("**" means sampling group number and "" means index number)</p> <p>NOTE</p> <ul style="list-style-type: none"> The index number for file names is from 0 to 9. You can save up to 10 files at the same time.
Backup Count	<p>Specify the number of times (1 to 500) to write the backup data. The number specified here is the number of files that will be created.</p>

Continued

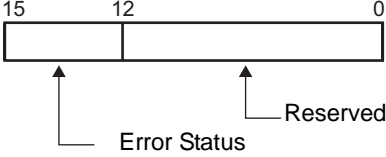
Setting	Description																											
When Exceeding Backup Count	<p>Select an action when the number of backup files exceeds the value set in the Backup Count.</p> <ul style="list-style-type: none"> • Overwrite oldest data Delete the oldest file and add a new file. • Interrupt Backup Stops backup. "1001" (number of files exceeded) is stored in the status address. 																											
Status Address	<p>Indicates whether the saved operation status and error information are stored in the specified address.</p> <div style="text-align: center;">  </div> <p>The error status indicates the following error codes. (Error Code)</p> <table border="1" data-bbox="411 745 1238 1387"> <thead> <tr> <th>12 to 15</th> <th>Description</th> <th>Details</th> </tr> </thead> <tbody> <tr> <td>0000</td> <td>Completed Successfully</td> <td>Transfer completed successfully.</td> </tr> <tr> <td>0001 to 0011</td> <td>Reserved</td> <td>-</td> </tr> <tr> <td>0100</td> <td>No CF Card/USB storage</td> <td>The CF card/USB drive is not inserted or the hatch of the CF card is opened while saving a backup data file (Bin format).</td> </tr> <tr> <td>0101</td> <td>Write Error</td> <td>The capacity of the CF card/USB drive is insufficient or the CF card/USB drive was removed while saving a backup data file in Bin format. 10 backup data files with the same time stamp already exist because the GP time set was restored, etc.</td> </tr> <tr> <td>0110</td> <td>Reserved</td> <td>-</td> </tr> <tr> <td>0111</td> <td>CF Card Error</td> <td>Occurs when the CF card is unformatted.</td> </tr> <tr> <td>1000</td> <td>Reserved</td> <td>-</td> </tr> <tr> <td>1001</td> <td>Excess Number of Files</td> <td>Exceeded number of files set</td> </tr> </tbody> </table>	12 to 15	Description	Details	0000	Completed Successfully	Transfer completed successfully.	0001 to 0011	Reserved	-	0100	No CF Card/USB storage	The CF card/USB drive is not inserted or the hatch of the CF card is opened while saving a backup data file (Bin format).	0101	Write Error	The capacity of the CF card/USB drive is insufficient or the CF card/USB drive was removed while saving a backup data file in Bin format. 10 backup data files with the same time stamp already exist because the GP time set was restored, etc.	0110	Reserved	-	0111	CF Card Error	Occurs when the CF card is unformatted.	1000	Reserved	-	1001	Excess Number of Files	Exceeded number of files set
12 to 15	Description	Details																										
0000	Completed Successfully	Transfer completed successfully.																										
0001 to 0011	Reserved	-																										
0100	No CF Card/USB storage	The CF card/USB drive is not inserted or the hatch of the CF card is opened while saving a backup data file (Bin format).																										
0101	Write Error	The capacity of the CF card/USB drive is insufficient or the CF card/USB drive was removed while saving a backup data file in Bin format. 10 backup data files with the same time stamp already exist because the GP time set was restored, etc.																										
0110	Reserved	-																										
0111	CF Card Error	Occurs when the CF card is unformatted.																										
1000	Reserved	-																										
1001	Excess Number of Files	Exceeded number of files set																										

Extended

Click [Extended] and the following dialog box appears.

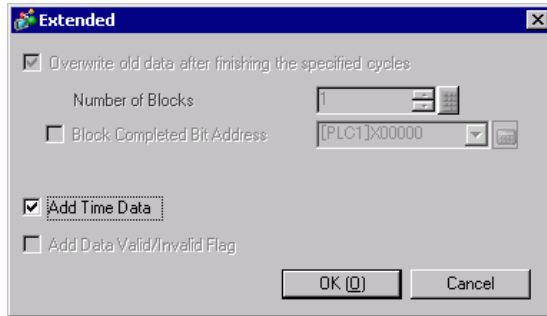

Setting	Description
Overwrite old data after finishing the specified cycles	Data will be overwritten and stored, starting with the oldest data, after data has been sampled the designated number of times. This setting is fixed.
Add Time Data	<p>Select whether or not to store the sample time along with the sampled data. If this is not designated, when displaying/saving in CSV or printing, the date/time columns will be blank.</p> <p>NOTE</p> <ul style="list-style-type: none"> When using the [Show Cursor] feature for the [Historical Trend Graph], this setting must be used for the Show Cursor feature to function. <p>☞ "18.12.2 Historical Trend Graph Settings Guide ◆ Display Historical Data" (page 18-81)</p>

◆ **Bit ON**

Data is collected every time the designated bit turns ON.

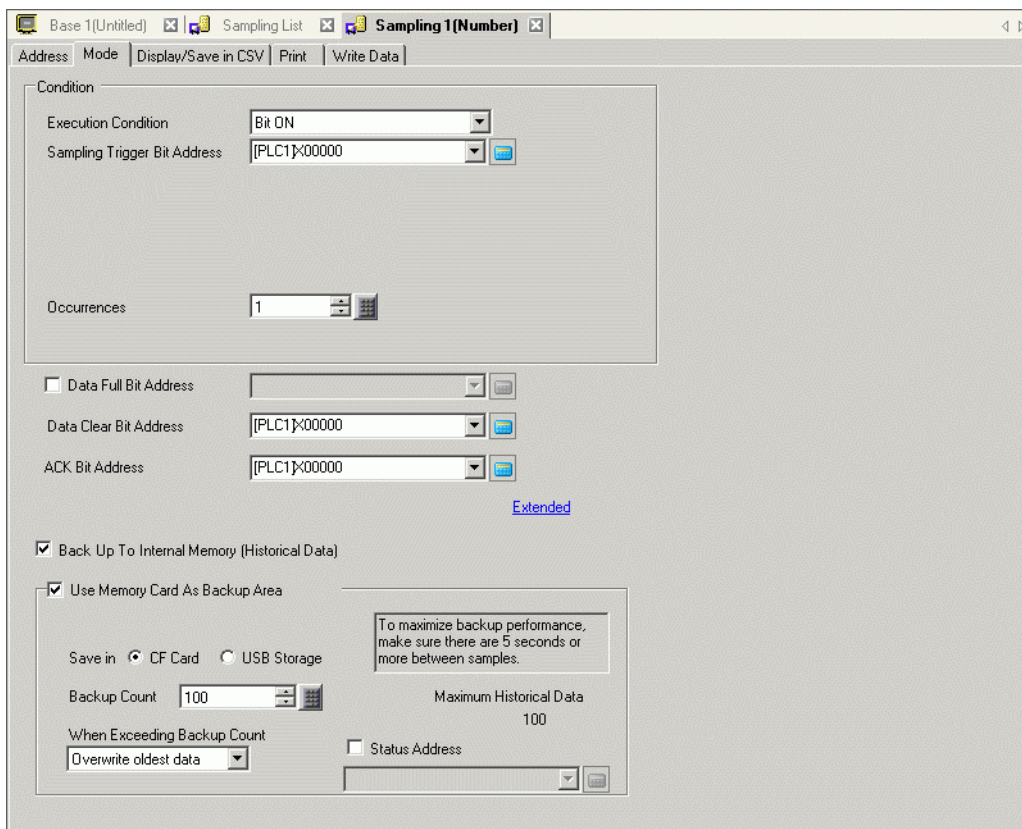

Setting	Description
Execution Condition	Select the sampling action execution condition. Select [Bit ON].
Sampling Trigger Bit Address	Select the address which will control the sampling's timing. The sampling will execute every time this address turns ON.
Occurrences	Select the number of times sampling will occur. If in the [Extended] area the [Overwrite old data after finishing the specified cycles] check box is selected, this can be from 1 to 65535 times. If the check box is cleared, the range is from 1 to 2048 times. IMPORTANT <ul style="list-style-type: none"> The setting range is limited by the number of sampling groups and addresses (words) registered in the entire system.

Continued

Setting	Description
Data Full Bit Address	<p>After all the sampling is completed (the set [Number of Times] * [Blocks]) this address will be used to confirm that the operation is finished. Select whether or not to verify this bit address.</p> <p>In the Extended area, when the [Overwrite old data after finishing the specified cycles] check box is selected, this bit tells when a data sampling cycle has been done. The sampling operation will continue running even when this bit is ON. If not designated, the sampling action will end when this bit turns ON. Please turn ON the [Data Clear Bit Address] to resume.</p> <p>NOTE</p> <ul style="list-style-type: none"> • This address is not turned OFF automatically. If the [Overwrite old data after finishing the specified cycles] check box is selected, please ensure that the bit is turned OFF in order to confirm the next sampling cycle.
Data Clear Bit Address	<p>Designate the bit address to control the clearing of the sampling data. When this address turns ON, all the Sampling Group data stored in the GP will be erased. After clearing the data, this bit will turn OFF.</p>
ACK Bit Address	<p>Select the address which will confirm when the data reading is finished. When the data reading is finished, the GP will turn this bit ON.</p> <p>When this address receives a [Bit ON] state, please turn OFF the device/PLC [Sampling Trigger Bit Address]. When the [Sampling Trigger Bit Address] turns OFF, this bit will turn OFF.</p>
Backup to Internal Memory (Display Historical Data)	<p>Select whether or not to save the sampling data to the backup SRAM. If the sampling data is not saved, the data will be deleted when the power to the GP unit is turned OFF or reset.</p> <p>☞ "24.9.1 Summary ■ Backup SRAM" (page 24-116)</p>
Use Memory Card as Backup Area	<p>Indicates whether data saved in the backup SRAM is written to the location specified in [Save in]. The data is saved in Bin format.</p> <p>☞ "24.9.1 Summary ◆ Backup Sampled Data" (page 24-119)</p> <p>NOTE</p> <ul style="list-style-type: none"> • When selecting this item, precautions on backup to a memory card and the maximum number of historical data that can be displayed in the Historical Trend Graph are displayed on the right-hand side. The maximum number is "Number of Times" of the condition x "Backup Count".

Continued

Setting	Description
Save in	<p>Select the "Save in" location of the backup data, from [CF card] and [USB storage].</p> <p>Folders are automatically created for each sampling group in the "Save in" location. The saved file name will be Time Stamp (year/month/day/hour/minute/second when saved).</p> <p>For example, when it is saved at 14:30:5 on July 2 in 2007 SAMP**T070702_143005.bin ("**" means sampling group number and "" means index number)</p> <p>NOTE</p> <ul style="list-style-type: none"> • The index number for file names is from 0 to 9. You can save up to 10 files at the same time.
Backup Count	<p>Specify the number of times (1 to 500) to write the backup data. The number specified here is the number of files that will be created.</p>
When Exceeding Backup Count	<p>Select an action when the number of backup files exceeds the value set in the Backup Count.</p> <ul style="list-style-type: none"> • Overwrite oldest data Delete the oldest file and add a new file. • Interrupt Backup Stops backup. "1001" (number of files exceeded) is stored in the status address.

Continued

Setting	Description																										
Status Address	<p>Indicates whether the saved operation status and error information are stored in the specified address.</p>																										
	<div data-bbox="628 247 1012 401" style="text-align: center;"> </div> <p>The error status indicates the following error codes. (Error Code)</p> <table border="1" data-bbox="411 517 1237 1163"> <thead> <tr> <th>12 to 15</th> <th>Description</th> <th>Details</th> </tr> </thead> <tbody> <tr> <td>0000</td> <td>Completed Successfully</td> <td>Transfer completed successfully.</td> </tr> <tr> <td>0001 to 0011</td> <td>Reserved</td> <td>-</td> </tr> <tr> <td>0100</td> <td>No CF Card/USB storage</td> <td>The CF card/USB drive is not inserted or the hatch of the CF card is opened while saving a backup data file (Bin format).</td> </tr> <tr> <td>0101</td> <td>Write Error</td> <td>The capacity of the CF card/USB drive is insufficient or the CF card/USB drive was removed while saving a backup data file in Bin format. 10 backup data files with the same time stamp already exist because the GP time set was restored, etc.</td> </tr> <tr> <td>0110</td> <td>Reserved</td> <td>-</td> </tr> <tr> <td>0111</td> <td>CF Card Error</td> <td>Occurs when the CF card is unformatted.</td> </tr> <tr> <td>1000</td> <td>Reserved</td> <td>-</td> </tr> <tr> <td>1001</td> <td>Excess Number of Files</td> <td>Exceeded number of files set</td> </tr> </tbody> </table>	12 to 15	Description	Details	0000	Completed Successfully	Transfer completed successfully.	0001 to 0011	Reserved	-	0100	No CF Card/USB storage	The CF card/USB drive is not inserted or the hatch of the CF card is opened while saving a backup data file (Bin format).	0101	Write Error	The capacity of the CF card/USB drive is insufficient or the CF card/USB drive was removed while saving a backup data file in Bin format. 10 backup data files with the same time stamp already exist because the GP time set was restored, etc.	0110	Reserved	-	0111	CF Card Error	Occurs when the CF card is unformatted.	1000	Reserved	-	1001	Excess Number of Files
12 to 15	Description	Details																									
0000	Completed Successfully	Transfer completed successfully.																									
0001 to 0011	Reserved	-																									
0100	No CF Card/USB storage	The CF card/USB drive is not inserted or the hatch of the CF card is opened while saving a backup data file (Bin format).																									
0101	Write Error	The capacity of the CF card/USB drive is insufficient or the CF card/USB drive was removed while saving a backup data file in Bin format. 10 backup data files with the same time stamp already exist because the GP time set was restored, etc.																									
0110	Reserved	-																									
0111	CF Card Error	Occurs when the CF card is unformatted.																									
1000	Reserved	-																									
1001	Excess Number of Files	Exceeded number of files set																									

Extended

Click [Extended] and the following dialog box appears.

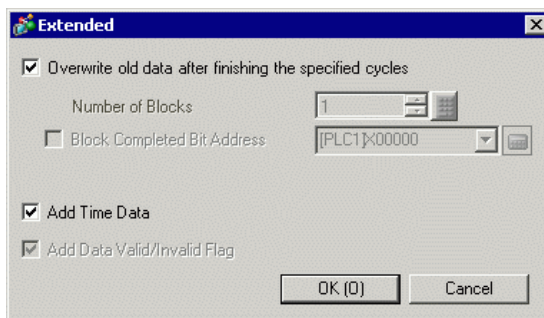

Setting	Description
Overwrite old data after finishing the specified cycles	<p>Select whether or not the data will be overwritten and stored, starting with the oldest data, after data has been sampled the designated number of times.</p> <p>When this is selected, sampling will continue even after the number of times has completed. Old data will not remain.</p> <p>If this is not set, previous data will not be overwritten. The new rounds of data will be stored as separate blocks. After data from ([Number of Times] x [Blocks]) has been stored, sampling will not occur until all stored data has been deleted.</p>
Blocks	<p>All the data collected in the sampled in the designated number of times is called a [block]. Designate the number of blocks to set inside one sampling group, only if [Overwrite old data after finishing the specified cycles] is not set. The setting range is from 1 to 2048. The settings range is limited to ensure that the amount of [Number of Times] x [Blocks] is less than 65535.</p>
Block Full Bit Address	<p>After the sampling for one block of data (the designated number of times) is completed, this bit address will turn ON to confirm that the operation is finished. To confirm, set this address.</p> <p>This tells that one block's sampling has completed. The sampling action will still continue for the designated [Blocks].</p> <p>NOTE</p> <ul style="list-style-type: none"> This address is not turned OFF automatically. In order to verify the completion of the next block, please ensure that this bit is returned to OFF.
Add Time Data	<p>Select whether or not to store the time when the data read finished, along with the sampled data. If this is not designated, when displaying/saving in CSV or printing, the date/time columns will be blank.</p> <p>NOTE</p> <ul style="list-style-type: none"> You must set [Show Cursor] in the [Historical Trend Graph] for Show Cursor to operate. <p> "18.12.2 Historical Trend Graph Settings Guide ◆ Display Historical Data" (page 18-81)</p>
Add Data Valid/Invalid Flag	<p>Stores an observation flag along with the data which monitors if the data has been saved properly. This setting is fixed.</p>

◆ **Bit Change**

Sample data every time the designated bit changes state (ON/OFF).

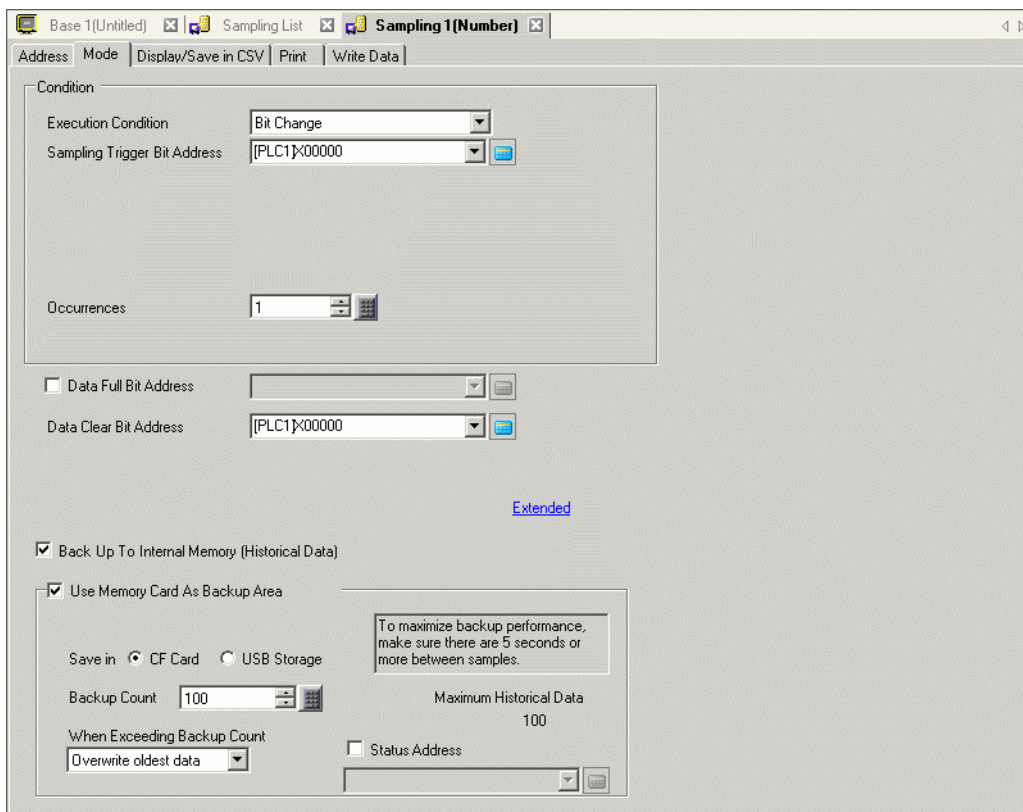

Setting	Description
Execution Condition	Select the sampling action execution condition. Select [Bit Change].
Sampling Trigger Bit Address	Select the address which will control the sampling's timing. The sampling will execute every time this address changes (ON/OFF).
Occurrences	Select the number of times sampling will occur. The setting range is from 1 to 65535. IMPORTANT <ul style="list-style-type: none"> The setting range is limited by the number of sampling groups and addresses (words) registered in the entire system.
Data Full Bit Address	After the designated number of data samples are completed, this address will be used to confirm that the operation is finished. Select whether or not to verify this bit address. This bit tells when a data sampling cycle is complete. The sampling operation will continue running even when this bit is ON. NOTE <ul style="list-style-type: none"> This address is not turned OFF automatically. In order to verify the next sampling cycle, please ensure that this bit is returned to the OFF state.

Continued

Setting	Description
Data Clear Bit Address	Designate the bit address to control the clearing of the sampling data. When this address turns ON, all the Sampling Group data stored in the GP will be erased. After clearing the data, this bit will turn OFF.
Backup to Internal Memory (Display Historical Data)	Select whether or not to save the sampling data to the backup SRAM. If the sampling data is not saved, the data will be deleted when the power to the GP unit is turned OFF or reset. ☞ "24.9.1 Summary ■ Backup SRAM" (page 24-116)
Use Memory Card as Backup Area	Indicates whether data saved in the backup SRAM is written to the location specified in [Save in]. The data is saved in Bin format. ☞ "24.9.1 Summary ◆ Backup Sampled Data" (page 24-119) NOTE • When selecting this item, precautions on backup to a memory card and the maximum number of historical data that can be displayed in the Historical Trend Graph are displayed on the right-hand side. The maximum number is "Number of Times" of the condition x "Backup Count".
Save in	Select the "Save in" location of the backup data, from [CF card] and [USB storage]. Folders are automatically created for each sampling group in the "Save in" location. The saved file name will be Time Stamp (year/month/day/hour/minute/second when saved). For example, when it is saved at 14:30:5 on July 2 in 2007 SAMP**T070702_143005.bin ("**" means sampling group number and "" means index number) NOTE • The index number for file names is from 0 to 9. You can save up to 10 files at the same time.
Backup Count	Specify the number of times (1 to 500) to write the backup data. The number specified here is the number of files that will be created.
When Exceeding Backup Count	Select an action when the number of backup data file exceeds the value set in the Backup Count • Overwrite oldest data Delete the oldest file and add a new file. • Interrupt Backup Stops backup. "1001" (number of files exceeded) is stored in the status address.

Continued

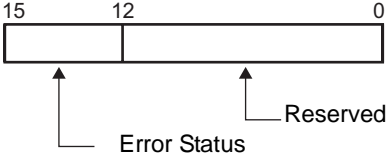
Setting	Description																											
Status Address	<p>Indicates whether the saved operation status and error information are stored in the specified address.</p>																											
																												
	<p>The error status indicates the following error codes.</p>																											
	<p>(Error Code)</p>																											
	<table border="1"> <thead> <tr> <th data-bbox="399 500 563 531">12 to 15</th> <th data-bbox="563 500 814 531">Description</th> <th data-bbox="814 500 1226 531">Details</th> </tr> </thead> <tbody> <tr> <td data-bbox="399 531 563 595">0000</td> <td data-bbox="563 531 814 595">Completed Successfully</td> <td data-bbox="814 531 1226 595">Transfer completed successfully.</td> </tr> <tr> <td data-bbox="399 595 563 633">0001 to 0011</td> <td data-bbox="563 595 814 633">Reserved</td> <td data-bbox="814 595 1226 633">-</td> </tr> <tr> <td data-bbox="399 633 563 749">0100</td> <td data-bbox="563 633 814 749">No CF Card/USB storage</td> <td data-bbox="814 633 1226 749">The CF card/USB drive is not inserted or the hatch of the CF card is opened while saving a backup data file (Bin format).</td> </tr> <tr> <td data-bbox="399 749 563 948">0101</td> <td data-bbox="563 749 814 948">Write Error</td> <td data-bbox="814 749 1226 948">The capacity of the CF card/USB drive is insufficient or the CF card/USB drive was removed while saving a backup data file in Bin format. 10 backup data files with the same time stamp already exist because the GP time set was restored, etc.</td> </tr> <tr> <td data-bbox="399 948 563 987">0110</td> <td data-bbox="563 948 814 987">Reserved</td> <td data-bbox="814 948 1226 987">-</td> </tr> <tr> <td data-bbox="399 987 563 1051">0111</td> <td data-bbox="563 987 814 1051">CF Card Error</td> <td data-bbox="814 987 1226 1051">Occurs when the CF card is unformatted.</td> </tr> <tr> <td data-bbox="399 1051 563 1089">1000</td> <td data-bbox="563 1051 814 1089">Reserved</td> <td data-bbox="814 1051 1226 1089">-</td> </tr> <tr> <td data-bbox="399 1089 563 1141">1001</td> <td data-bbox="563 1089 814 1141">Excess Number of Files</td> <td data-bbox="814 1089 1226 1141">Exceeded number of files set</td> </tr> </tbody> </table>	12 to 15	Description	Details	0000	Completed Successfully	Transfer completed successfully.	0001 to 0011	Reserved	-	0100	No CF Card/USB storage	The CF card/USB drive is not inserted or the hatch of the CF card is opened while saving a backup data file (Bin format).	0101	Write Error	The capacity of the CF card/USB drive is insufficient or the CF card/USB drive was removed while saving a backup data file in Bin format. 10 backup data files with the same time stamp already exist because the GP time set was restored, etc.	0110	Reserved	-	0111	CF Card Error	Occurs when the CF card is unformatted.	1000	Reserved	-	1001	Excess Number of Files	Exceeded number of files set
	12 to 15	Description	Details																									
	0000	Completed Successfully	Transfer completed successfully.																									
	0001 to 0011	Reserved	-																									
	0100	No CF Card/USB storage	The CF card/USB drive is not inserted or the hatch of the CF card is opened while saving a backup data file (Bin format).																									
	0101	Write Error	The capacity of the CF card/USB drive is insufficient or the CF card/USB drive was removed while saving a backup data file in Bin format. 10 backup data files with the same time stamp already exist because the GP time set was restored, etc.																									
0110	Reserved	-																										
0111	CF Card Error	Occurs when the CF card is unformatted.																										
1000	Reserved	-																										
1001	Excess Number of Files	Exceeded number of files set																										

Extended

Click [Extended] and the following dialog box appears.

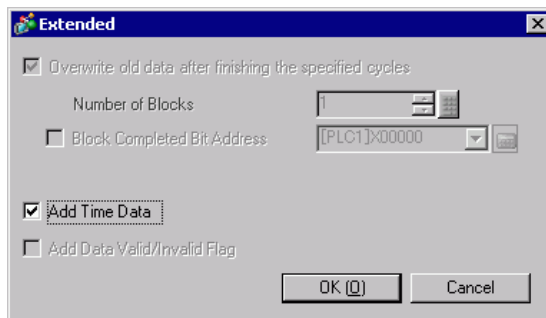

Setting	Description
Overwrite old data after finishing the specified cycles	Data will be overwritten and stored, starting with the oldest data, after data has been sampled the designated number of times. This setting is fixed.
Add Time Data	<p>Select whether or not to store the sample time along with the sampled data. If this is not designated, when displaying/saving in CSV or printing, the date/time columns will be blank.</p> <p>NOTE</p> <ul style="list-style-type: none"> When using the [Show Cursor] feature for the [Historical Trend Graph], this setting must be used for the Show Cursor feature to function. <p>☞ "18.12.2 Historical Trend Graph Settings Guide ◆ Display Historical Data" (page 18-81)</p>

■ Display/Save in CSV

Set the format in which to display the sampling data on the GP screen and to save on the CF Card/USB storage device as a CSV file. Settings will differ between the [Basic Settings] or [Custom] format settings mode.

The following is a settings guide for [Basic]. For [Custom Settings], see " ■ Display/Save in CSV (Custom Settings)" (page 24-77).

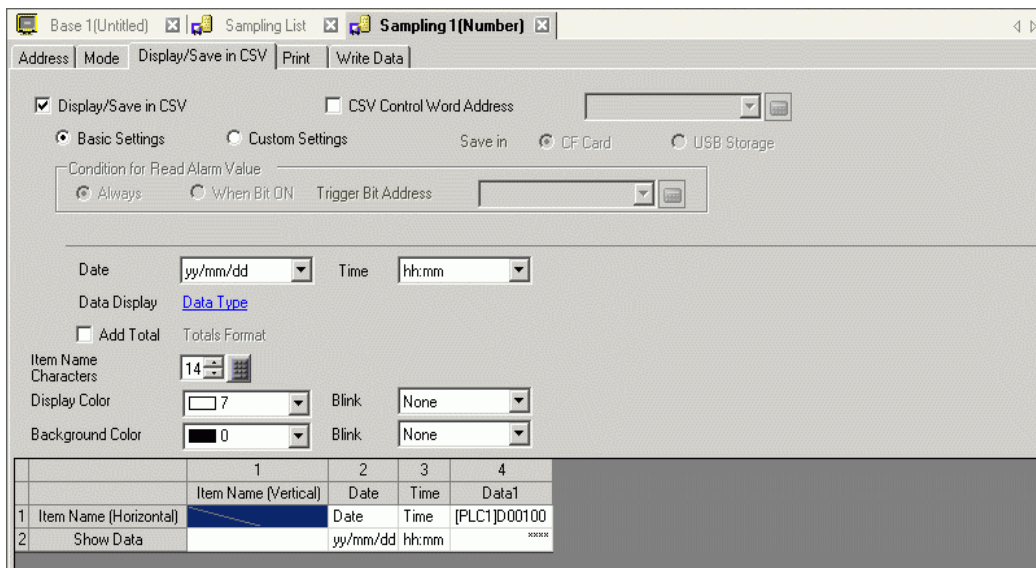



Setting	Description		
Display/Save in CSV	Specifies whether to display the sampling data on the GP screen or to save to the CF Card/USB storage device. When you display using the Sampling Data Display, or save the data to the CF Card/USB storage device, you must check and set the format.		
CSV Control Word Address	Specifies whether to save as a CSV file. When you save, set the control address to write the data to a CF Card/USB storage device. Two sequential word addresses are used as the area to write the command and its result (status), and File (the *****portion in "SA*****.csv".) The File can be from 0 to 65535. Control Word Address +1 <table border="1" style="display: inline-table; vertical-align: middle;"><tr><td>Command/Status</td></tr><tr><td>File No.</td></tr></table>	Command/Status	File No.
Command/Status			
File No.			
Save in	Select the save destination for the sampling data. <ul style="list-style-type: none"> • CF Card Write data to a CF card. • USB Storage Write data to a USB storage device. 🖱️ "24.6.3 CF Card/USB Storage Save Operation ■ CSV Control Word Address" (page 24-23)		

Continued

Setting	Description
Basic Settings/ Custom Settings	Select the format setting mode. <ul style="list-style-type: none"> • Basic Settings Use a preset format to easily configure settings. • Custom Settings Set a customized format.
Condition for Reading Alarm Addresses	When you enable [Alarm Settings] with the [Alarm] tab in the [Data Style Settings], and set the [Alarm Action], you set the conditions for reading that address. <ul style="list-style-type: none"> • Continuous Read Continuous read the alarm address. • Bit ON Read it when the [Trigger Bit Address] is ON.
Trigger Bit Address	Set the address that controls the timing for reading the alarm address.
Date	Select the date format as: [yy/mm/dd], [mm/dd/yy], [dd/mm/yy], [mm/dd] "yy" displays the last two digits of the year, and "mm" and "dd" use two digits to display the month and date. <p>NOTE</p> <ul style="list-style-type: none"> • No matter which display format you select, it is output in CSV format as [yy/mm/dd] when you save to a CF Card/USB storage device. • [yy/mm/dd] and [mm/dd] can be selected only when the [language] in the sampling list is [Japanese].
Time	Select the time format [hh:mm], [hh:mm:ss], or [hh:mm:ss.ms]. "hh" displays the hours, "mm" displays the minutes, and "ss" displays the seconds, all using two digits. "ms" uses three digits to display the milliseconds. <p>NOTE</p> <ul style="list-style-type: none"> • No matter which display format you select, it is output in CSV format as [hh:mm:ss] when you save to CF Card/USB storage. (If the sampling cycle unit is set [milliseconds], output is [hh:mm:ss.000].) • [hh/mm] and [hh/mm/ss] can be selected only when the [language] in the sampling list is [Japanese].
Data Display	Click [Data Type Settings] to open the [Data Settings] dialog box. The data type, input range, number of display digits can now be set. <p> " ◆ [Data Settings] Dialog Box" (page 24-68)</p>

Continued

Setting	Description
Total	<p>Select whether or not the totals row will be displayed. Values calculated from the data of the designated Number of Times stored in the GP are displayed.</p> <p>Click on [Data Type Settings] and open the [Calculation Settings] dialog box. The data type and style for the totals rows can now be set.</p> <p> " ◆ [Calculation Settings] Dialog Box" (page 24-73)</p> <p>NOTE</p> <ul style="list-style-type: none"> • Regardless of whether a Total row is designated or not, calculation data will not be exported with the CSV file.
Item Name Characters	<p>Set the number of item name characters from 1 to 20 (single-byte).</p> <p>NOTE</p> <ul style="list-style-type: none"> • You cannot set a value that is less than the Date Column/Time Column display format or the data column's display format
Text Color	<p>Select a color for the text and values to be displayed.</p>
Background Color	<p>Select a background color for the text.</p>
Blink	<p>Select the blink and blink speed. You can choose different blink settings for the [Display Color], and [Background Color].</p> <p>NOTE</p> <ul style="list-style-type: none"> • There are cases where you can and cannot set Blink depending on the Display Unit and System Settings' [Color Settings]. <p> "8.5.1 Setting Colors ■ List of Compatible Colors" (page 8-36)</p>

Continued

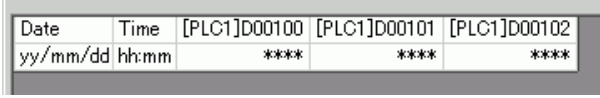
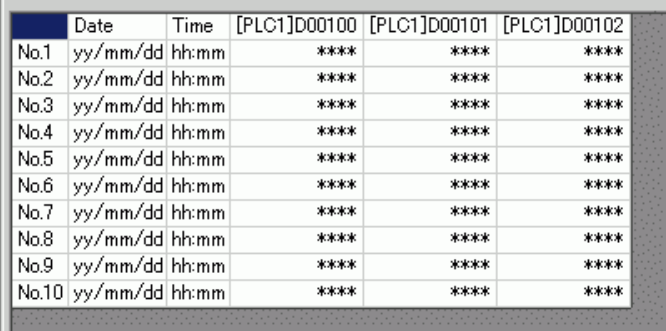
Setting	Description																																																																	
Preview area	<p>Displays the set contents with the selected format. If [Overwrite old data after finishing the specified cycles] is selected on the [Mode] tab's Extended settings, only one data row will display. If the [Overwrite old data after finishing the specified cycles] check box is cleared, the data rows equal the designated [Number of Times].</p> <p>When [Overwrite old data after finishing the specified cycles] check box is selected</p>																																																																	
	 <table border="1" data-bbox="491 459 1089 556"> <thead> <tr> <th>Date</th> <th>Time</th> <th>[PLC1]D00100</th> <th>[PLC1]D00101</th> <th>[PLC1]D00102</th> </tr> </thead> <tbody> <tr> <td>yy/mm/dd</td> <td>hh:mm</td> <td>****</td> <td>****</td> <td>****</td> </tr> </tbody> </table>	Date	Time	[PLC1]D00100	[PLC1]D00101	[PLC1]D00102	yy/mm/dd	hh:mm	****	****	****																																																							
	Date	Time	[PLC1]D00100	[PLC1]D00101	[PLC1]D00102																																																													
yy/mm/dd	hh:mm	****	****	****																																																														
<p>When [Overwrite old data after finishing the specified cycles] check box is cleared</p>  <table border="1" data-bbox="491 668 1155 996"> <thead> <tr> <th>No.</th> <th>Date</th> <th>Time</th> <th>[PLC1]D00100</th> <th>[PLC1]D00101</th> <th>[PLC1]D00102</th> </tr> </thead> <tbody> <tr><td>No.1</td><td>yy/mm/dd</td><td>hh:mm</td><td>****</td><td>****</td><td>****</td></tr> <tr><td>No.2</td><td>yy/mm/dd</td><td>hh:mm</td><td>****</td><td>****</td><td>****</td></tr> <tr><td>No.3</td><td>yy/mm/dd</td><td>hh:mm</td><td>****</td><td>****</td><td>****</td></tr> <tr><td>No.4</td><td>yy/mm/dd</td><td>hh:mm</td><td>****</td><td>****</td><td>****</td></tr> <tr><td>No.5</td><td>yy/mm/dd</td><td>hh:mm</td><td>****</td><td>****</td><td>****</td></tr> <tr><td>No.6</td><td>yy/mm/dd</td><td>hh:mm</td><td>****</td><td>****</td><td>****</td></tr> <tr><td>No.7</td><td>yy/mm/dd</td><td>hh:mm</td><td>****</td><td>****</td><td>****</td></tr> <tr><td>No.8</td><td>yy/mm/dd</td><td>hh:mm</td><td>****</td><td>****</td><td>****</td></tr> <tr><td>No.9</td><td>yy/mm/dd</td><td>hh:mm</td><td>****</td><td>****</td><td>****</td></tr> <tr><td>No.10</td><td>yy/mm/dd</td><td>hh:mm</td><td>****</td><td>****</td><td>****</td></tr> </tbody> </table>	No.	Date	Time	[PLC1]D00100	[PLC1]D00101	[PLC1]D00102	No.1	yy/mm/dd	hh:mm	****	****	****	No.2	yy/mm/dd	hh:mm	****	****	****	No.3	yy/mm/dd	hh:mm	****	****	****	No.4	yy/mm/dd	hh:mm	****	****	****	No.5	yy/mm/dd	hh:mm	****	****	****	No.6	yy/mm/dd	hh:mm	****	****	****	No.7	yy/mm/dd	hh:mm	****	****	****	No.8	yy/mm/dd	hh:mm	****	****	****	No.9	yy/mm/dd	hh:mm	****	****	****	No.10	yy/mm/dd	hh:mm	****	****	****
No.	Date	Time	[PLC1]D00100	[PLC1]D00101	[PLC1]D00102																																																													
No.1	yy/mm/dd	hh:mm	****	****	****																																																													
No.2	yy/mm/dd	hh:mm	****	****	****																																																													
No.3	yy/mm/dd	hh:mm	****	****	****																																																													
No.4	yy/mm/dd	hh:mm	****	****	****																																																													
No.5	yy/mm/dd	hh:mm	****	****	****																																																													
No.6	yy/mm/dd	hh:mm	****	****	****																																																													
No.7	yy/mm/dd	hh:mm	****	****	****																																																													
No.8	yy/mm/dd	hh:mm	****	****	****																																																													
No.9	yy/mm/dd	hh:mm	****	****	****																																																													
No.10	yy/mm/dd	hh:mm	****	****	****																																																													

◆ [Data Settings] Dialog Box

[Data Type] Tab

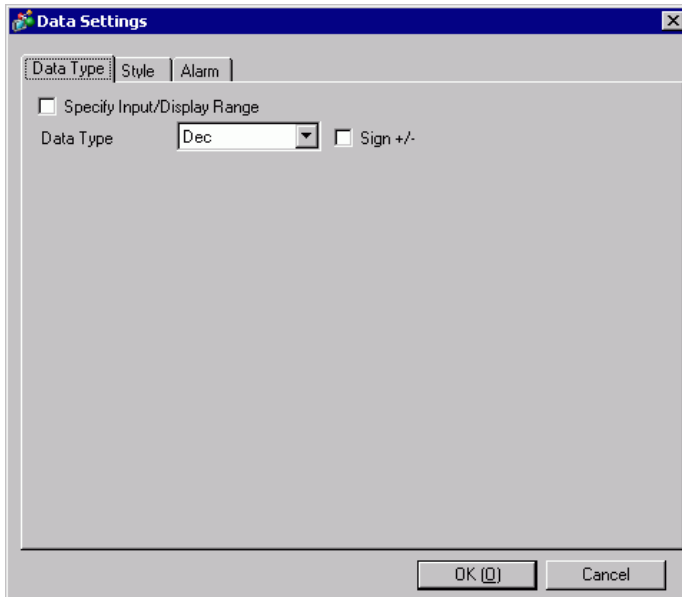

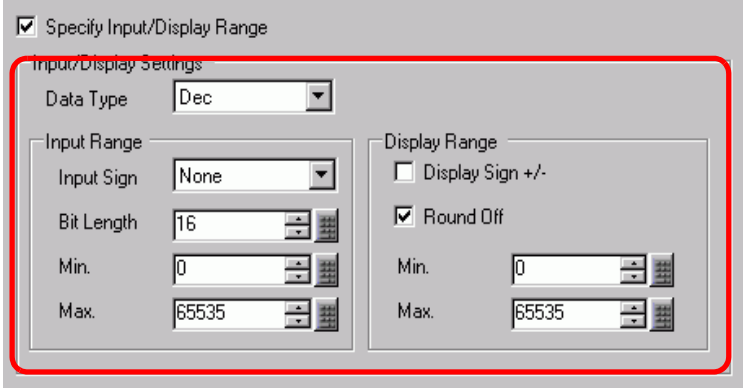
Setting	Description
Specify Input/Display Range	<p>Designate whether or not an input range and display range of the sampling data will be set. If designated, the following setting items will appear.</p> 
Data Type	<p>Choose the data type from [Dec], [BCD], [Hex], or [Float]. [Float] can only be selected when the set [Bit Length] is [32 Bit] on the [Address] tab.</p> <p>NOTE</p> <ul style="list-style-type: none"> When [BCD] is selected, sampling data containing the digits A-F (hexadecimal) other than BCD will be displayed/saved in CSV with "----" (Number of digits "-").
Sign +/-	<p>Designate whether or not to attach a minus sign to data. This can only be set when the [Data Type] is [Dec].</p> <p>NOTE</p> <ul style="list-style-type: none"> This is fixed when the [Data Type] is [Float].

Continued

Setting		Description																																			
Input Range	Input Sign	<p>If [Specify Input/Display Range] is designated and [Data Type] is [Dec], select whether or not to handle negative numbers.</p> <ul style="list-style-type: none"> • None Only positive numeric data. • 2's Complement Negative numbers are handled with 2's complement. • MSB Sign Negative numbers are handled with MSB sign (highest bit). 																																			
	Bit Length	If [Specify Input/Display Range] is designated and [Data Length] is [16 Bit] on the [Address] tab, set the bit length for one word from 1 to 16.																																			
	Min. Value/ Max. Value	<p>If [Specify Input/Display Range] is designated, set the data input range. Each [Data Type] and [Input Sign] has a different size range.</p> <table border="1"> <thead> <tr> <th>Bit Length</th> <th>Data Type</th> <th>Input Sign</th> <th>Input Range</th> </tr> </thead> <tbody> <tr> <td rowspan="4">16 bit</td> <td rowspan="3">Dec</td> <td>None</td> <td>0 to 65535</td> </tr> <tr> <td>2's Complement</td> <td>-32768 to 32767</td> </tr> <tr> <td>MSB Sign</td> <td>-32767 to 32767</td> </tr> <tr> <td>Hex</td> <td>-</td> <td>0 to FFFF(h)</td> </tr> <tr> <td></td> <td>BCD</td> <td>-</td> <td>0 to 9999</td> </tr> <tr> <td rowspan="6">32 bit</td> <td rowspan="3">Dec</td> <td>None</td> <td>0 to 4294967295</td> </tr> <tr> <td>2's Complement</td> <td>-2147483648 to 2147483647</td> </tr> <tr> <td>MSB Sign</td> <td>-2147483647 to 2147483647</td> </tr> <tr> <td>Hex</td> <td>-</td> <td>BCD</td> </tr> <tr> <td>BCD</td> <td>-</td> <td>0 to 99999999</td> </tr> <tr> <td>Float</td> <td>-</td> <td>-9.9e¹⁶ to 9.9e¹⁶</td> </tr> </tbody> </table>	Bit Length	Data Type	Input Sign	Input Range	16 bit	Dec	None	0 to 65535	2's Complement	-32768 to 32767	MSB Sign	-32767 to 32767	Hex	-	0 to FFFF(h)		BCD	-	0 to 9999	32 bit	Dec	None	0 to 4294967295	2's Complement	-2147483648 to 2147483647	MSB Sign	-2147483647 to 2147483647	Hex	-	BCD	BCD	-	0 to 99999999	Float	-
Bit Length	Data Type	Input Sign	Input Range																																		
16 bit	Dec	None	0 to 65535																																		
		2's Complement	-32768 to 32767																																		
		MSB Sign	-32767 to 32767																																		
	Hex	-	0 to FFFF(h)																																		
	BCD	-	0 to 9999																																		
32 bit	Dec	None	0 to 4294967295																																		
		2's Complement	-2147483648 to 2147483647																																		
		MSB Sign	-2147483647 to 2147483647																																		
	Hex	-	BCD																																		
	BCD	-	0 to 99999999																																		
	Float	-	-9.9e ¹⁶ to 9.9e ¹⁶																																		
Display Range	Display Sign +/-	If [Specify Input/Display Range] is designated and [Data Type] is [Dec], select whether or not to attach a sign to display data.																																			
	Round Off	Designate whether or not to round off fractions when converting input values to the display range. Fractions will be discarded if rounding off is not selected.																																			
	Min. Value/ Max. Value	<p>If you select [Specify an Input/Display Range], select the Min/Max for the display range. The settings range is different, depending on the [Data Type] and whether [Display Sign +/-] is set.</p> <table border="1"> <thead> <tr> <th>Bit Length</th> <th>Data Type</th> <th>Display Sign +/-</th> <th>Display Range</th> </tr> </thead> <tbody> <tr> <td rowspan="4">16 bit</td> <td rowspan="2">Dec</td> <td>Enable</td> <td>-32768 to 32767</td> </tr> <tr> <td>Disable</td> <td>0 to 65535</td> </tr> <tr> <td>Hex</td> <td>-</td> <td>0 to FFFF(h)</td> </tr> <tr> <td>BCD</td> <td>-</td> <td>0 to 9999</td> </tr> <tr> <td rowspan="5">32 bit</td> <td rowspan="2">Dec</td> <td>Enable</td> <td>-2147483648 to 2147483647</td> </tr> <tr> <td>Disable</td> <td>0 to 4294967295</td> </tr> <tr> <td>Hex</td> <td>-</td> <td>BCD</td> </tr> <tr> <td>BCD</td> <td>-</td> <td>0 to 99999999</td> </tr> <tr> <td>Float</td> <td>Checked (Fixed)</td> <td>-9.9e¹⁶ to 9.9e¹⁶</td> </tr> </tbody> </table>	Bit Length	Data Type	Display Sign +/-	Display Range	16 bit	Dec	Enable	-32768 to 32767	Disable	0 to 65535	Hex	-	0 to FFFF(h)	BCD	-	0 to 9999	32 bit	Dec	Enable	-2147483648 to 2147483647	Disable	0 to 4294967295	Hex	-	BCD	BCD	-	0 to 99999999	Float	Checked (Fixed)	-9.9e ¹⁶ to 9.9e ¹⁶				
Bit Length	Data Type	Display Sign +/-	Display Range																																		
16 bit	Dec	Enable	-32768 to 32767																																		
		Disable	0 to 65535																																		
	Hex	-	0 to FFFF(h)																																		
	BCD	-	0 to 9999																																		
32 bit	Dec	Enable	-2147483648 to 2147483647																																		
		Disable	0 to 4294967295																																		
	Hex	-	BCD																																		
	BCD	-	0 to 99999999																																		
	Float	Checked (Fixed)	-9.9e ¹⁶ to 9.9e ¹⁶																																		

[Style] Tab

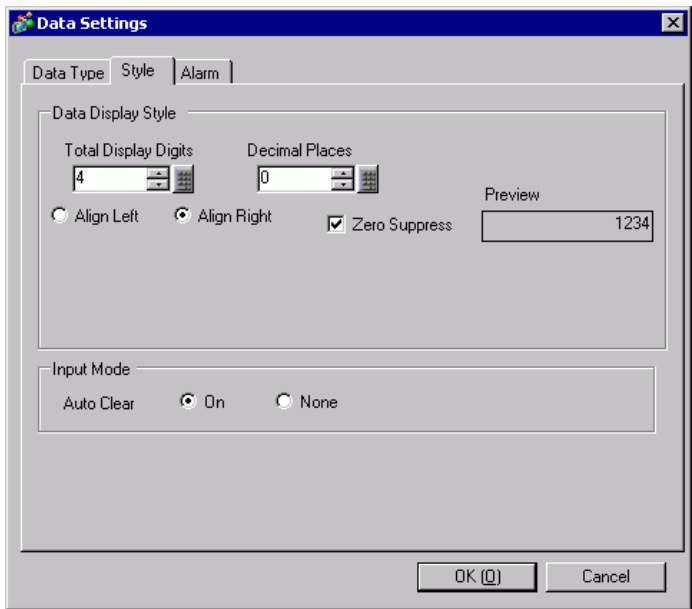

Setting	Description
Total Display Digits	Select the number of display digits for the data from 1 to 17. This can be designated to within the number of characters set in [Item Name Characters]. The numbers displayed after the decimal point are also included in the number of digits. (For example, Total Display Digits is "5", and the Decimal Places is "2") <div style="text-align: center; border: 1px solid gray; width: 100px; margin: 10px auto;">123.45</div>
Decimal Places	Set the number of display digits after the decimal point, from: 0 to [Total Display Digits]-1. This cannot be set when the [Data Type] is [Hex].
Align Right/Align Left	Select the data display position.
Zero Suppress	If this option is selected, leading zeros are not displayed. (For example, Number of Display Digits = 4) <div style="display: flex; justify-content: space-around; align-items: center; margin-top: 10px;"> <div style="text-align: center;"> <input checked="" type="checkbox"/> Zero Suppress <div style="border: 1px solid gray; width: 40px; height: 20px; display: flex; align-items: center; justify-content: center; margin: 5px auto;">25</div> <p>Leading zeroes are not displayed</p> </div> <div style="text-align: center;"> <input type="checkbox"/> Zero Suppress <div style="border: 1px solid gray; width: 40px; height: 20px; display: flex; align-items: center; justify-content: center; margin: 5px auto;">0025</div> <p>Leading zeroes are added to correspond to the length of Display Digits</p> </div> </div>
Preview	Preview the selected style.

Continued

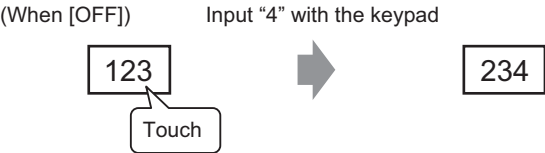
Setting	Description
Auto Clear	<p>Select whether or not to clear previously inputted values when correcting data on the screen. If [ON] is set, previous values are deleted when a value is inputted, and only the new value is displayed. If [None] is set, previous data remains, and the new value is added to the end.</p> <p>(For example, Number of Display Digit = 3)</p> <p>(When [ON])</p>  <p>(When [OFF]) Input "4" with the keypad</p> 

[Alarm] Tab

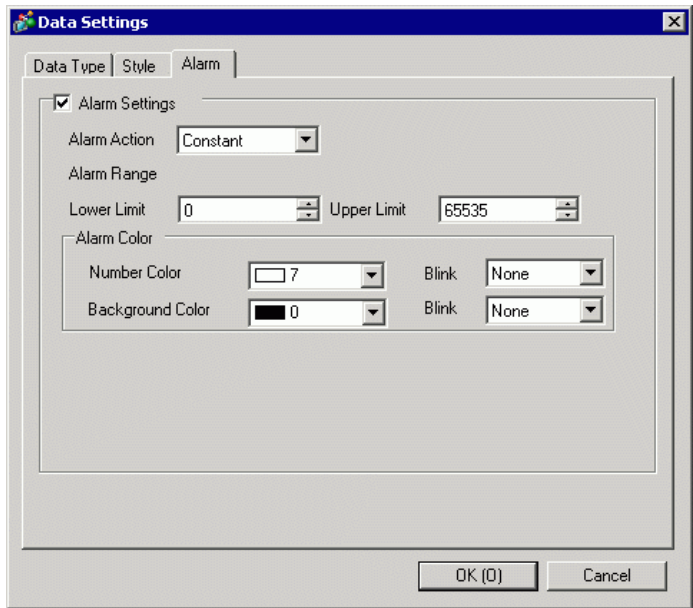



Setting	Description
Alarm	Designate whether or not to display an alarm (change the data color when the value goes outside of the alarm range).
Alarm Action	Select the action when the alarm is active from [Constant] or [Address]. The [Alarm Range] settings will vary, depending on the selected action.

Continued

Setting	Description																															
Alarm Range	<ul style="list-style-type: none"> When [Alarm Action] is [Constant] When [Designate the Input/Display Range] in [Data Style] tab is not designated, set the [Upper Limit] and [Lower Limit] within the following range. 																															
	<table border="1"> <thead> <tr> <th>Bit Length</th> <th>Data Type</th> <th>Sign +/-</th> <th>Display Range</th> </tr> </thead> <tbody> <tr> <td rowspan="4" style="text-align: center;">16 bit</td> <td rowspan="2" style="text-align: center;">Dec</td> <td style="text-align: center;">Enable</td> <td style="text-align: center;">-32768 to 32767</td> </tr> <tr> <td style="text-align: center;">Disable</td> <td style="text-align: center;">0 to 65535</td> </tr> <tr> <td style="text-align: center;">Hex</td> <td style="text-align: center;">-</td> <td style="text-align: center;">0 0 to FFFF(h)</td> </tr> <tr> <td style="text-align: center;">BCD</td> <td style="text-align: center;">-</td> <td style="text-align: center;">0 to 9999</td> </tr> <tr> <td rowspan="5" style="text-align: center;">32 bit</td> <td rowspan="2" style="text-align: center;">Dec</td> <td style="text-align: center;">Enable</td> <td style="text-align: center;">-2147483648 to 2147483647</td> </tr> <tr> <td style="text-align: center;">Disable</td> <td style="text-align: center;">0 to 4294967295</td> </tr> <tr> <td style="text-align: center;">Hex</td> <td style="text-align: center;">-</td> <td style="text-align: center;">0 0 to FFFFFFFF(h)</td> </tr> <tr> <td style="text-align: center;">BCD</td> <td style="text-align: center;">-</td> <td style="text-align: center;">0 to 99999999</td> </tr> <tr> <td style="text-align: center;">Float</td> <td style="text-align: center;">Checked (Fixed)</td> <td style="text-align: center;">-9.9e16 to 9.9e16</td> </tr> </tbody> </table>	Bit Length	Data Type	Sign +/-	Display Range	16 bit	Dec	Enable	-32768 to 32767	Disable	0 to 65535	Hex	-	0 0 to FFFF(h)	BCD	-	0 to 9999	32 bit	Dec	Enable	-2147483648 to 2147483647	Disable	0 to 4294967295	Hex	-	0 0 to FFFFFFFF(h)	BCD	-	0 to 99999999	Float	Checked (Fixed)	-9.9e16 to 9.9e16
	Bit Length	Data Type	Sign +/-	Display Range																												
	16 bit	Dec	Enable	-32768 to 32767																												
			Disable	0 to 65535																												
		Hex	-	0 0 to FFFF(h)																												
		BCD	-	0 to 9999																												
	32 bit	Dec	Enable	-2147483648 to 2147483647																												
			Disable	0 to 4294967295																												
		Hex	-	0 0 to FFFFFFFF(h)																												
BCD		-	0 to 99999999																													
Float		Checked (Fixed)	-9.9e16 to 9.9e16																													
<p>When [Designate the Input/Display Range] in [Data Style] tab is specified, the [Upper Limit] and [Lower Limit] will not be set.</p>																																
<ul style="list-style-type: none"> When [Address] is selected for [Alarm Action], set the [Upper Limit] Address. The [Lower Limit] will be the sequential address from the [Upper Limit] word address. 																																
<p>When the specified address is 16 bit</p>																																
<ul style="list-style-type: none"> When the [Bit Length] is [16 Bit] 																																
<ul style="list-style-type: none"> When the [Bit Length] is [32 Bit] 																																

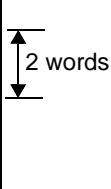
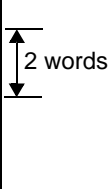
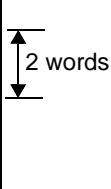
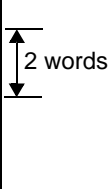
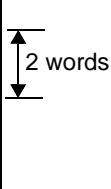
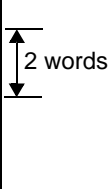
Continued

Setting	Description														
Alarm Range	<p>When the specified address is 32 bit</p> <ul style="list-style-type: none"> When the [Bit Length] is [16 Bit] <table border="1" data-bbox="463 272 1071 459"> <tr> <td data-bbox="463 272 687 363">Specified Address+0</td> <td data-bbox="687 272 824 363">0 Fixed</td> <td data-bbox="824 272 961 363">Upper Limit</td> <td data-bbox="961 272 1071 459" rowspan="2" style="text-align: center; vertical-align: middle;">  </td> </tr> <tr> <td data-bbox="463 363 687 459">Specified Address+1</td> <td data-bbox="687 363 824 459">0 Fixed</td> <td data-bbox="824 363 961 459">Lower Limit</td> </tr> </table> <ul style="list-style-type: none"> When the [Bit Length] is [32 Bit] <table border="1" data-bbox="463 562 1071 749"> <tr> <td data-bbox="463 562 687 653">Specified Address+0</td> <td colspan="2" data-bbox="687 562 961 653">Data of the Upper Limit of the Alarm Range</td> <td data-bbox="961 562 1071 749" rowspan="2" style="text-align: center; vertical-align: middle;">  </td> </tr> <tr> <td data-bbox="463 653 687 749">Specified Address+1</td> <td colspan="2" data-bbox="687 653 961 749">Data of the Lower Limit of the Alarm Range</td> </tr> </table> <p>NOTE</p> <ul style="list-style-type: none"> Whether you select [16 Bit] or [32 Bit] in [Address], the range of sequential address varies. 	Specified Address+0	0 Fixed	Upper Limit		Specified Address+1	0 Fixed	Lower Limit	Specified Address+0	Data of the Upper Limit of the Alarm Range			Specified Address+1	Data of the Lower Limit of the Alarm Range	
Specified Address+0	0 Fixed	Upper Limit													
Specified Address+1	0 Fixed	Lower Limit													
Specified Address+0	Data of the Upper Limit of the Alarm Range														
Specified Address+1	Data of the Lower Limit of the Alarm Range														
Numeral Value Color	Select the numeric value color for when the Alarm is displayed.														
Background Color	Select the background color for when the Alarm is displayed.														
Blink	<p>Select the blink and blink speed. You can choose different blink settings for the Alarm's [Numeral Value Color] and [Background Color].</p> <p>NOTE</p> <ul style="list-style-type: none"> There are cases where you can and cannot set Blink depending on the Display Unit and System Settings' [Color Settings].  "8.5.1 Setting Colors ■ List of Compatible Colors" (page 8-36) 														

NOTE • [Alarm Action] only supports types for which GP-3300 type is Rev.4 or later.

◆ **[Calculation Settings] Dialog Box**

When displaying the total rows, the [Calculation Settings] dialog box will appear by clicking [Data Type].

[Data Type] Tab

The [Total] row data type conforms to the data type set in the [Data Type Settings] dialog box.

(There is no item to set on this tab.)

[Style] Tab

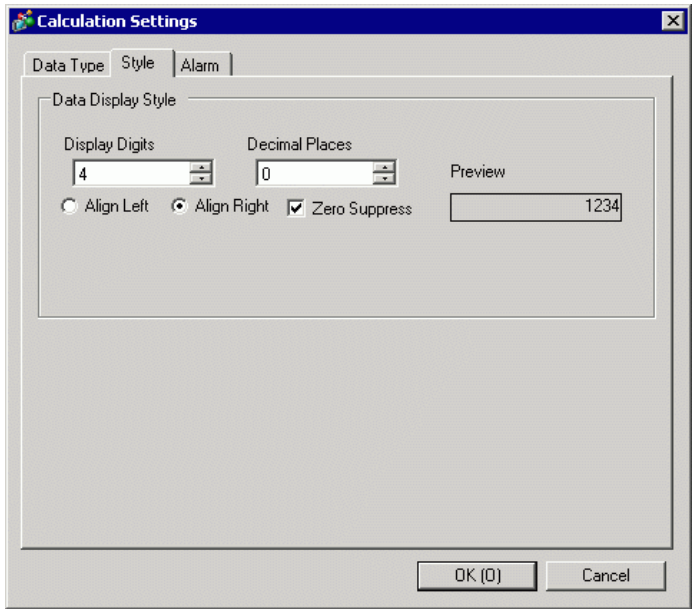

Setting	Description
Total Display Digits	Select the number of display digits for the calculation data from 1 to 17. This can be designated to within the number of characters set in [Item Name Characters]. The numbers displayed after the decimal point are also included in the number of digits. For example, Total Display Digits is "5", and the Decimal Places is "2". <div style="text-align: center; border: 1px solid gray; width: 100px; margin: 10px auto;">123.45</div>
Decimal Places	Set the number of display digits after the decimal point for the calculation data, from 0 to [Total Display Digits]-1. This cannot be set when the [Data Type] is [Hex].
Align Right/Align Left	Select the calculation data display position.
Zero Suppress	If this option is selected, leading zeros are not displayed. For example, Number of Display Digits = 4. <div style="display: flex; justify-content: space-around; align-items: center; margin-top: 10px;"> <div style="text-align: center;"> <input checked="" type="checkbox"/> Zero Suppress <div style="border: 1px solid gray; width: 40px; height: 20px; margin: 5px auto; display: flex; align-items: center; justify-content: center;">25</div> <p>Leading zeroes are not displayed</p> </div> <div style="text-align: center;"> <input type="checkbox"/> Zero Suppress <div style="border: 1px solid gray; width: 40px; height: 20px; margin: 5px auto; display: flex; align-items: center; justify-content: center;">0025</div> <p>Leading zeroes are added to correspond to the length of Display Digits</p> </div> </div>
Preview	Preview the selected style.

[Alarm] Tab

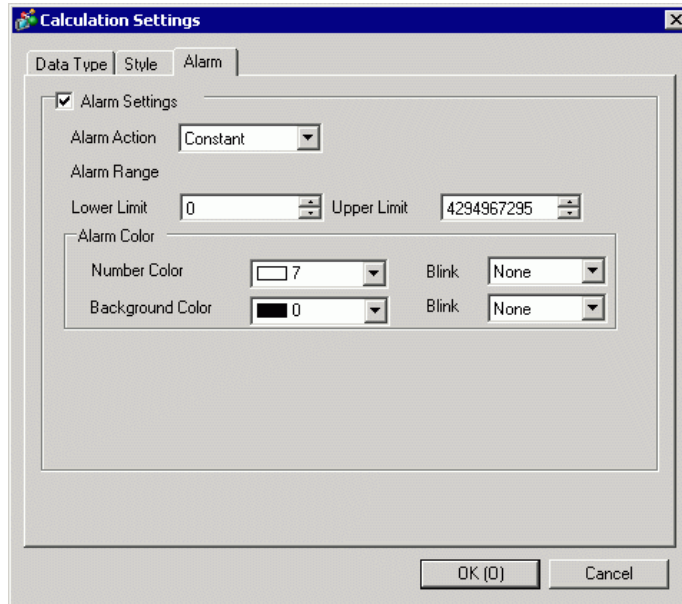

Setting	Description
Alarm	Designate whether or not the use alarm display (change the calculation data color when the value goes outside of the alarm range).
Alarm Action	Select the action when the alarm is active from [Constant] or [Address].

Continued

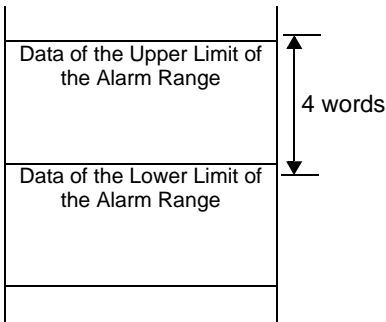
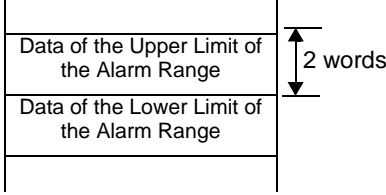
Setting	Description																	
Alarm Range	<ul style="list-style-type: none"> When [Constant] is selected for [Alarm Action], set the [Upper Limit] and the [Lower Limit] within the following range. <table border="1" data-bbox="477 253 1177 488"> <thead> <tr> <th>Data Type</th> <th>Sign +/-</th> <th>Display Range</th> </tr> </thead> <tbody> <tr> <td rowspan="2">Dec</td> <td>Enable</td> <td>-2147483648 to 2147483647</td> </tr> <tr> <td>Disable</td> <td>0 to 4294967295</td> </tr> <tr> <td>Hex</td> <td>-</td> <td>0 0 to FFFFFFFF(h)</td> </tr> <tr> <td>BCD</td> <td>-</td> <td>0 to 99999999</td> </tr> <tr> <td>Float</td> <td>Checked (Fixed)</td> <td>-9.9e16 to 9.9e16</td> </tr> </tbody> </table> When [Address] is selected for [Alarm Action], set the [Upper Limit] Address. The [Lower Limit] will be the sequential address from the [Upper Limit] word address. When the specified address is 16 bit <div style="display: flex; align-items: center; margin-top: 10px;"> <div style="margin-right: 10px;"> Specified Address+0 Specified Address+1 Specified Address+2 Specified Address+3 </div> <div style="border-left: 1px solid black; border-right: 1px solid black; padding: 5px;"> <div style="border-bottom: 1px solid black; padding: 2px 5px;">Data of the Upper Limit of the Alarm Range</div> <div style="border-bottom: 1px solid black; padding: 2px 5px;">Data of the Lower Limit of the Alarm Range</div> </div> <div style="margin-left: 10px; text-align: center;">  <p>4 words</p> </div> </div> <p style="margin-top: 10px;">When the specified address is 32 bit</p> <div style="display: flex; align-items: center; margin-top: 10px;"> <div style="margin-right: 10px;"> Specified Address+0 Specified Address+1 </div> <div style="border-left: 1px solid black; border-right: 1px solid black; padding: 5px;"> <div style="border-bottom: 1px solid black; padding: 2px 5px;">Data of the Upper Limit of the Alarm Range</div> <div style="border-bottom: 1px solid black; padding: 2px 5px;">Data of the Lower Limit of the Alarm Range</div> </div> <div style="margin-left: 10px; text-align: center;">  <p>2 words</p> </div> </div> <div style="margin-top: 10px;"> <p>NOTE</p> <ul style="list-style-type: none"> Even if you select [16 Bit] or [32 Bit] for the [Bit Length] in the [Address] tab, the numeric value will be 32 bit. </div>	Data Type	Sign +/-	Display Range	Dec	Enable	-2147483648 to 2147483647	Disable	0 to 4294967295	Hex	-	0 0 to FFFFFFFF(h)	BCD	-	0 to 99999999	Float	Checked (Fixed)	-9.9e16 to 9.9e16
	Data Type	Sign +/-	Display Range															
Dec	Enable	-2147483648 to 2147483647																
	Disable	0 to 4294967295																
Hex	-	0 0 to FFFFFFFF(h)																
BCD	-	0 to 99999999																
Float	Checked (Fixed)	-9.9e16 to 9.9e16																
Numeral Value Color	Select the numeric value color for when the Alarm is displayed.																	
Background Color	Select the background color for when the Alarm is displayed.																	
Blink	Select the blink and blink speed. You can choose different blink settings for the Alarm's [Numeral Value Color] and [Background Color]. <div style="margin-top: 10px;"> <p>NOTE</p> <ul style="list-style-type: none"> There are cases where you can and cannot set Blink depending on the Display Unit and System Settings' [Color Settings]. "8.5.1 Setting Colors ■ List of Compatible Colors" (page 8-36) </div>																	

NOTE

- [Alarm Action] only supports types for which GP-3300 type is Rev.4 or later.

■ Display/Save in CSV (Custom Settings)

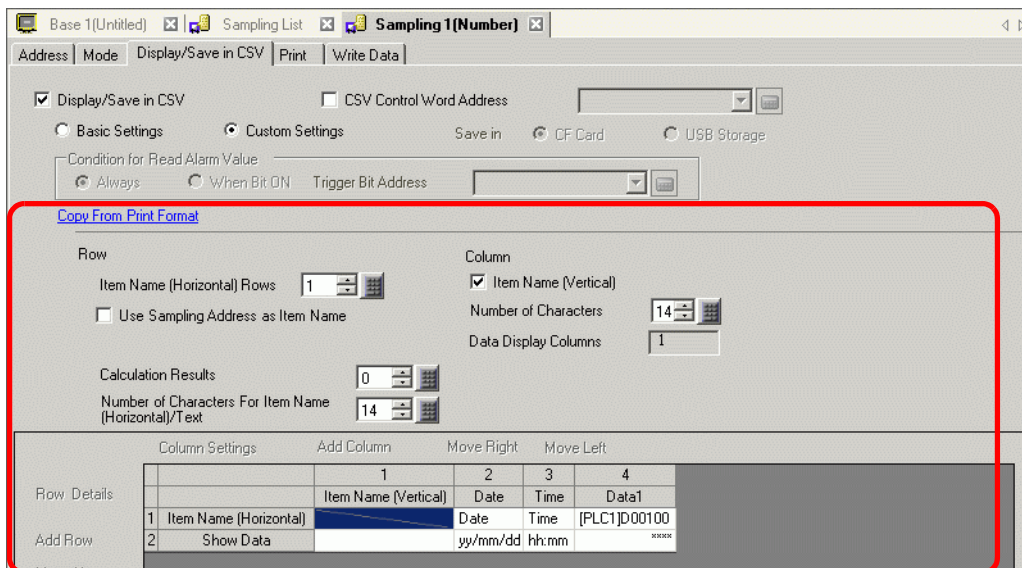

Setting		Description
Copy From Print Format		When the print format is set on the [Print] tab, copy the settings from the [Print] tab. Use this feature when you want to display/save in CSV using the print format. The border row and border column are not copied.
Row	Item Name (Horizontal) Rows	The number of item name rows can be from 0 to 3. "Date" and "Time" will be displayed in the first row of the Date and Time columns.
	Use Sampling Address as Item Name	If the [Item Name (Horizontal) Rows] is not "0", select whether or not to display the sampling address as the data column item name. If selected, cells that have an address displayed in the Preview area cannot be edited.
	Data Display Rows	If in the [Mode] tab's Extended area the [Overwrite old data after finishing the specified cycles] check box is selected, set the number of data rows from 1 to the [Number of Days] set on the [Mode] tab. IMPORTANT • Adjust the number of data display rows to the [Number of Times].
	Calculation Results	The number of calculation rows can be from 0 to 4. In the Calculation rows, values calculated (Total, Average, Max, Min) from data from the designated [Number of Times] can be displayed. NOTE • The calculation line is not output when it is saved to CF Card/USB storage (CSV Output).
Number of Characters For Item Name (Horizontal)/Text		Set the number of display characters for the item names (horizontal) and text rows from 1 to 20 single-byte characters. When you double-click an item name row/text row cell in the Preview area, you can input text that is within the number of characters set here.

Continued

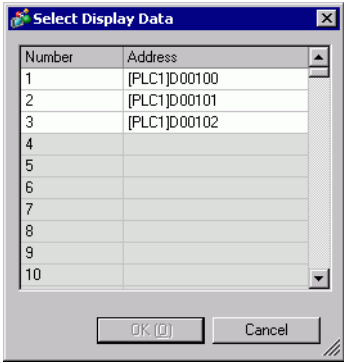
Setting		Description
Column Settings	Item Name (Vertical) Characters	Designate whether or not to display the item name column. If designated, set the number of item name column's characters from 1 to 20 single-byte characters.
	Data Display Columns	Displays the number of data columns.
Column Settings Row Details		<p>Select and click the column, calculation row, or item name (vertical)/ (horizontal) in the Preview area, and a dialog box to configure detailed settings appears.</p> <ul style="list-style-type: none"> ☞ " ◆ Column's Details [Date Set] Dialog Box" (page 24-80) ☞ " ◆ Column's Details [Time Set] Dialog Box" (page 24-81) ☞ " ◆ Column's Details [Data Settings] Dialog Box" (page 24-82) ☞ " ◆ Detail Settings [Text Settings] Dialog Box" (page 24-103) ☞ " ◆ Row's Details [Calculation Settings] Dialog Box" (page 24-85) ☞ " ◆ Column/Row Detail Settings [Item Name (vertical)] [Item Name (horizontal)] dialog box" (page 24-87)
Add this Column		<p>Insert a column in front of the column selected in the Preview area. Choose from a [Date], [Time], [Data], or [Text] column. You can directly input the desired text in the [Text] column.</p> <p>When inserting a [Data] column, the [Select Display Data] dialog box appears and you can select a data column (address) you want to add.</p> <div style="display: flex; align-items: center;">  <div style="margin-left: 20px;"> <p>To add multiple addresses, drag the mouse to select consecutive columns. If you click columns to add while pressing the [Ctrl] key, you can select separate addresses.</p> </div> </div> <p>NOTE</p> <ul style="list-style-type: none"> • The [Text] line is not output when saved to CF Card/USB storage (CSV Output). Also, when [Date] line and [Time] line are multiple set, each line is output to a fixed position.
Move Right/Move Left		Move the column you selected in the preview area to the right/left.
Add this Row		<p>Insert a [Text] row in front of the row selected in the Preview area. You can directly input the desired text in the [Text] row.</p> <p>NOTE</p> <ul style="list-style-type: none"> • The [Text] line is not output when saved to CF Card/USB storage (CSV Output). • When multiple calculation rows are set, you cannot input a Text row between two calculation rows.

Continued

Setting	Description																																																																													
Move Up/ Down	Move the [Text] row you selected in the preview area upward/downward.																																																																													
Preview area	<p data-bbox="395 214 1258 382">Displays the set contents with the selected format. If [Overwrite old data after finishing the specified cycles] is selected on the [Mode] tab's Extended settings, only one data row will display. If the [Overwrite old data after finishing the specified cycles] check box is cleared, the data rows equal the designated [Number of Times].</p> <p data-bbox="395 401 1258 465">When [Overwrite old data after finishing the specified cycles] check box is selected</p> <table border="1" data-bbox="422 484 1249 585"> <thead> <tr> <th></th> <th>1</th> <th>2</th> <th>3</th> <th>4</th> <th>5</th> <th>6</th> </tr> </thead> <tbody> <tr> <td></td> <td>Item Name (Vertical)</td> <td>Date</td> <td>Time</td> <td>Data1</td> <td>Data1</td> <td>Data1</td> </tr> <tr> <td>1</td> <td>Item Name (Horizontal)</td> <td>Date</td> <td>Time</td> <td>[PLC1]D00100</td> <td>[PLC1]D00101</td> <td>[PLC1]D00102</td> </tr> <tr> <td>2</td> <td>Show Data</td> <td>No.1</td> <td>yy/mm/dd hh:mm</td> <td>xxxx</td> <td>xxxx</td> <td>xxxx</td> </tr> </tbody> </table> <p data-bbox="395 662 1258 726">When [Overwrite old data after finishing the specified cycles] check box is cleared</p> <table border="1" data-bbox="422 745 1236 958"> <thead> <tr> <th></th> <th>1</th> <th>2</th> <th>3</th> <th>4</th> <th>5</th> <th>6</th> </tr> </thead> <tbody> <tr> <td></td> <td>Item Name (Vertical)</td> <td>Date</td> <td>Time</td> <td>Data1</td> <td>Data2</td> <td>Data3</td> </tr> <tr> <td>1</td> <td>Item Name (Horizontal)</td> <td>Date</td> <td>Time</td> <td>[PLC1]D00100</td> <td>[PLC1]D00101</td> <td>[PLC1]D00102</td> </tr> <tr> <td>2</td> <td>No.1</td> <td>No.1</td> <td>yy/mm/dd hh:mm</td> <td>xxxx</td> <td>xxxx</td> <td>xxxx</td> </tr> <tr> <td>3</td> <td>No.2</td> <td>No.2</td> <td>yy/mm/dd hh:mm</td> <td>xxxx</td> <td>xxxx</td> <td>xxxx</td> </tr> <tr> <td>4</td> <td>No.3</td> <td>No.3</td> <td>yy/mm/dd hh:mm</td> <td>xxxx</td> <td>xxxx</td> <td>xxxx</td> </tr> <tr> <td>5</td> <td>No.4</td> <td>No.4</td> <td>yy/mm/dd hh:mm</td> <td>xxxx</td> <td>xxxx</td> <td>xxxx</td> </tr> </tbody> </table>		1	2	3	4	5	6		Item Name (Vertical)	Date	Time	Data1	Data1	Data1	1	Item Name (Horizontal)	Date	Time	[PLC1]D00100	[PLC1]D00101	[PLC1]D00102	2	Show Data	No.1	yy/mm/dd hh:mm	xxxx	xxxx	xxxx		1	2	3	4	5	6		Item Name (Vertical)	Date	Time	Data1	Data2	Data3	1	Item Name (Horizontal)	Date	Time	[PLC1]D00100	[PLC1]D00101	[PLC1]D00102	2	No.1	No.1	yy/mm/dd hh:mm	xxxx	xxxx	xxxx	3	No.2	No.2	yy/mm/dd hh:mm	xxxx	xxxx	xxxx	4	No.3	No.3	yy/mm/dd hh:mm	xxxx	xxxx	xxxx	5	No.4	No.4	yy/mm/dd hh:mm	xxxx	xxxx	xxxx
	1	2	3	4	5	6																																																																								
	Item Name (Vertical)	Date	Time	Data1	Data1	Data1																																																																								
1	Item Name (Horizontal)	Date	Time	[PLC1]D00100	[PLC1]D00101	[PLC1]D00102																																																																								
2	Show Data	No.1	yy/mm/dd hh:mm	xxxx	xxxx	xxxx																																																																								
	1	2	3	4	5	6																																																																								
	Item Name (Vertical)	Date	Time	Data1	Data2	Data3																																																																								
1	Item Name (Horizontal)	Date	Time	[PLC1]D00100	[PLC1]D00101	[PLC1]D00102																																																																								
2	No.1	No.1	yy/mm/dd hh:mm	xxxx	xxxx	xxxx																																																																								
3	No.2	No.2	yy/mm/dd hh:mm	xxxx	xxxx	xxxx																																																																								
4	No.3	No.3	yy/mm/dd hh:mm	xxxx	xxxx	xxxx																																																																								
5	No.4	No.4	yy/mm/dd hh:mm	xxxx	xxxx	xxxx																																																																								

◆ Column's Details [Date Set] Dialog Box

Select a Date column in the Preview area, click [Detail Settings], and the following dialog box will be displayed.

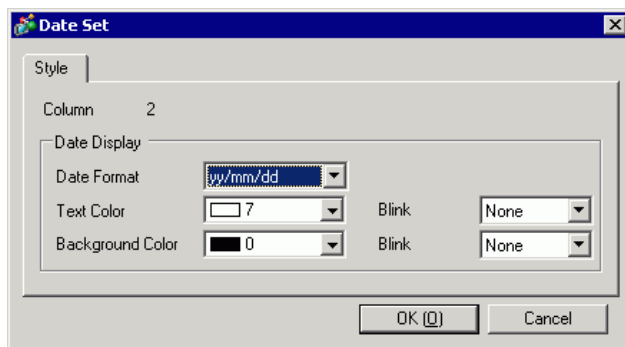

Setting	Description
Column	Displays the selected column's number.
Date Format	Select the date format as: [yy/mm/dd], [mm/dd/yy], [dd/mm/yy], [mm/dd] "yy" displays the last two digits of the year, and "mm" and "dd" use two digits to display the month and date. NOTE <ul style="list-style-type: none"> No matter which display format you select, it is output in CSV format as [yy/mm/dd] when you save to CF Card/USB storage (CSV Save).
Text Color	Select the text's color.
Background Color	Set the background color for the text.
Blink	Select the blink and blink speed. You can choose different blink settings for the [Display Color], and [Background Color]. NOTE <ul style="list-style-type: none"> There are cases where you can and cannot set Blink depending on the Display Unit and System Settings' [Color Settings]. ☞ "8.5.1 Setting Colors ■ List of Compatible Colors" (page 8-36)

◆ **Column's Details [Time Set] Dialog Box**

Select a Time column in the Preview area and click [Detail Settings]. The following dialog box appears.

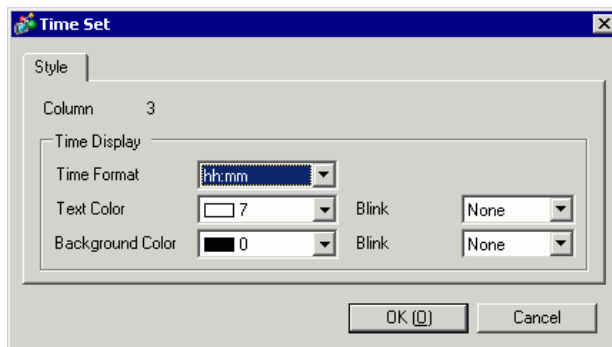



Setting	Description
Column	Displays the selected column's number.
Time Format	<p>Select the time format [hh:mm], [hh:mm:ss], or [hh:mm:ss.ms]. "hh" displays the hours, "mm" displays the minutes, and "ss" displays the seconds, all using two digits. "ms" uses three digits to display the milliseconds.</p> <p>NOTE</p> <ul style="list-style-type: none"> • No matter which display format you select, it is output in CSV format as [hh:mm:ss] when you save to CF Card/USB storage. (If the sampling cycle unit is set [milliseconds], output is[hh:mm:ss.000].) • [hh/mm] and [hh/mm/ss] can be selected only when [Language] in the sampling group list is [Japanese].
Text Color	Select the text's color.
Background Color	Set the background color for the text.
Blink	<p>Select the blink and blink speed. You can choose different blink settings for the [Display Color], and [Background Color].</p> <p>NOTE</p> <ul style="list-style-type: none"> • There are cases where you can and cannot set Blink depending on the Display Unit and System Settings' [Color Settings]. <p> "8.5.1 Setting Colors ■ List of Compatible Colors" (page 8-36)</p>

◆ **Column's Details [Data Settings] Dialog Box**

Select a Data column in the Preview area and click [Column Settings]. The following dialog box appears.

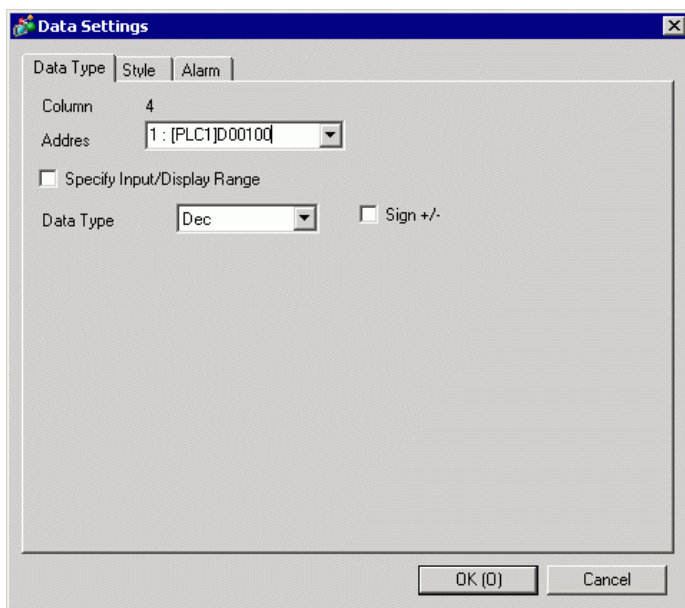
[Data Type] Tab

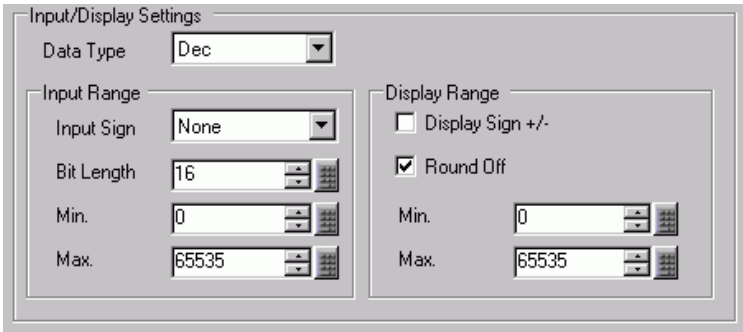

Setting	Description
Column	Displays the selected column's number.
Address	Displays the selected column address. Display the list and you can change the registered address in the sampling group.
Specify Input/Display Range	<p>Designate whether or not an input range and display range will be set. If designated, the following setting items will appear.</p>  <p>NOTE</p> <ul style="list-style-type: none"> Each setting for the input range/display range is the same as [Basic] mode, [Data Type Settings], in the displayed [Data Settings] dialog box.  ◆ [Data Settings] Dialog Box" (page 24-68)

Continued

Setting	Description
Data Type	<p>Choose the data type from [Dec], [BCD], [Hex], or [Float]. [Float] can only be selected when the set [Bit Length] is [32 Bit] on the [Address] tab.</p> <p>NOTE</p> <ul style="list-style-type: none"> When [BCD] is selected, sampling data containing the digits A-F (hexadecimal) other than BCD will be displayed/saved in CSV with "----" (Number of digits "-").
Sign +/-	<p>Designate whether or not to attach a minus sign to data. This can only be set when the [Data Type] is [Dec].</p> <p>NOTE</p> <ul style="list-style-type: none"> This is fixed when the [Data Type] is [Float].
Round Off	<p>Designate whether or not to round off fractions when converting input values to the display range. Fractions will be discarded if rounding off is not selected. [Data Type] = [Float] when this setting is available.</p>

[Style] Tab

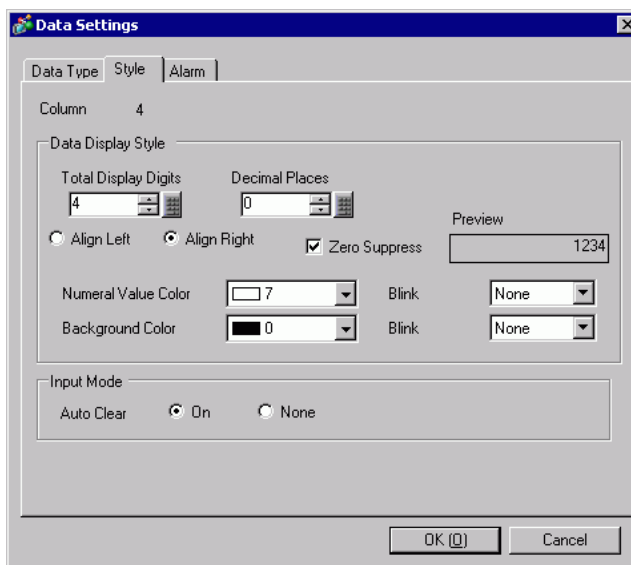

Setting	Description
Total Display Digits	<p>Select the number of display digits for the data from 1 to 17. This can be designated to within the number of characters set in [Item Name (Vertical) Characters]. The numbers displayed after the decimal point are also included in the number of digits. For example, when the Total Display Digits is 5, and the Decimal Places is 2.</p> <p style="text-align: center;">123.45</p>
Decimal Places	<p>Set the number of display digits after the decimal point, from: 0 to [Total Display Digits]-1. This cannot be set when the [Data Type] is [Hex].</p>
Align Right/Align Left	<p>Select the data display position.</p>

Continued

Setting	Description
Zero Suppress	<p>If this option is selected, leading zeros are not displayed. (For example, Number of Display Digits = 4)</p> <div style="display: flex; justify-content: space-around; align-items: center;"> <div style="text-align: center;"> <input checked="" type="checkbox"/> Zero Suppress <div style="border: 1px solid black; padding: 2px 10px; width: 40px; margin: 5px auto;">25</div> <p>Leading zeroes are not displayed</p> </div> <div style="text-align: center;"> <input type="checkbox"/> Zero Suppress <div style="border: 1px solid black; padding: 2px 10px; width: 40px; margin: 5px auto;">0025</div> <p>Leading zeroes are added to correspond to the length of Display Digits</p> </div> </div>
Preview	Preview the selected style.
Numeral Value Color	Set the numeric value color.
Background Color	Select a background color for the numeric values.
Blink	<p>Select the blink and blink speed. You can choose different blink settings for the [Numeral Value Color] and [Background Color].</p> <p>NOTE</p> <ul style="list-style-type: none"> There are cases where you can and cannot set Blink depending on the Display Unit and System Settings' [Color Settings]. <small>☞ "8.5.1 Setting Colors ■ List of Compatible Colors" (page 8-36)</small>
Auto Clear	<p>Select whether or not to clear previously inputted values when correcting data on the screen. If [ON] is set, previous values are deleted when a value is inputted, and only the new value is displayed. If [None] is set, previous data remains, and the new value is added to the end.</p> <p>(For example, Number of Display Digit = 3)</p> <div style="text-align: center;"> <p>(When [ON])</p> <div style="display: flex; align-items: center; justify-content: center;"> <div style="text-align: center;"> <div style="border: 1px solid black; padding: 2px 10px; width: 40px;">123</div> <div style="border: 1px solid black; padding: 2px 5px; width: 40px; margin-top: 5px;">Touch</div> </div> <div style="margin: 0 20px;">➔</div> <div style="text-align: center;"> <div style="border: 1px solid black; padding: 2px 10px; width: 40px;">4</div> </div> </div> <p>(When [OFF]) Input "4" with the keypad</p> <div style="display: flex; align-items: center; justify-content: center;"> <div style="text-align: center;"> <div style="border: 1px solid black; padding: 2px 10px; width: 40px;">123</div> <div style="border: 1px solid black; padding: 2px 5px; width: 40px; margin-top: 5px;">Touch</div> </div> <div style="margin: 0 20px;">➔</div> <div style="text-align: center;"> <div style="border: 1px solid black; padding: 2px 10px; width: 40px;">234</div> </div> </div> </div>

[Alarm] Tab

This is the same as the [Alarm] tab in the [Data Settings] dialog box, displayed by clicking [Data Type Settings] in [Basic] mode.

☞ "◆ [Data Settings] Dialog Box" (page 24-68)

◆ Row's Details [Calculation Settings] Dialog Box

Select a calculation row in the Preview area, click [Row Detail Settings], and the following dialog box will be displayed.

[Data Type] Tab

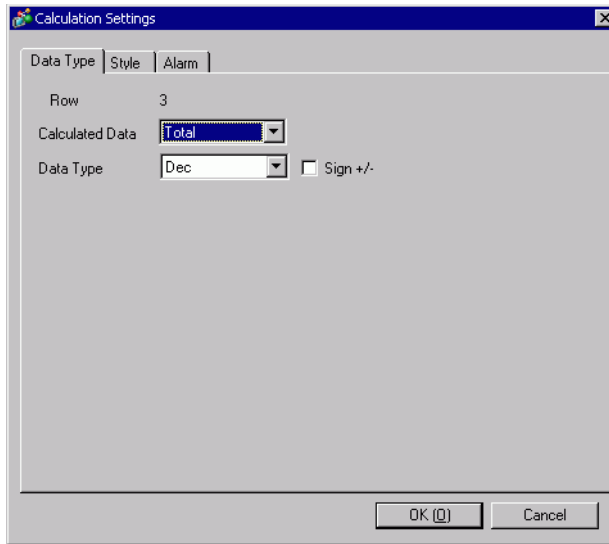

Setting	Description
Row Number/ Column	Displays the selected Calculation row or Calculation cell row number/ column number.
Calculated Data	Choose the data calculation type from [Total], [Average], [Max], or [Min]. Values calculated from the data of the designated Number of Times stored in the GP are displayed.
Data Type	Choose the data type from [Dec], [BCD], [Hex], or [Float]. [Float] can only be selected when the set [Bit Length] is [32 Bit] on the [Address] tab. NOTE <ul style="list-style-type: none"> When [BCD] is selected, sampling data containing the digits A-F (hexadecimal) other than BCD will be displayed/saved in CSV with "----" (Number of digits "-").
Sign +/-	Designate whether or not to attach a minus sign to data. This can only be set when the [Data Type] is [Dec]. NOTE <ul style="list-style-type: none"> This is fixed when the [Data Type] is [Float].

[Style] Tab

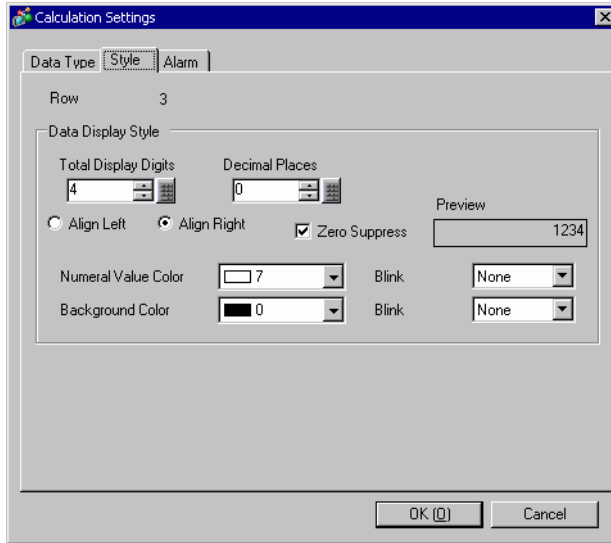

Setting	Description
Total Display Digits	Select the number of display digits for the calculation data from 1 to 17. This can be designated to within the number of characters set in [Item Name (Horizontal)/Text Characters]. The numbers displayed after the decimal point are also included in the number of digits. (For example, Total Display Digits is "5", and the Decimal Places is "2") <div style="text-align: center; border: 1px solid gray; width: 100px; margin: 5px auto;">123.45</div>
Decimal Places	Set the number of display digits after the decimal point for the calculation data, from 0 to [Total Display Digits]-1. This cannot be set when the [Data Type] is [Hex].
Align Right/Align Left	Select the calculation data display position.
Zero Suppress	If this option is selected, leading zeros are not displayed. (For example, Number of Display Digits = 4) <div style="display: flex; justify-content: space-around; align-items: center; margin-top: 10px;"> <div style="text-align: center;"> <input checked="" type="checkbox"/> Zero Suppress <div style="border: 1px solid gray; width: 40px; height: 25px; margin: 5px auto; display: flex; align-items: center; justify-content: center;">25</div> <p>Leading zeroes are not displayed</p> </div> <div style="text-align: center;"> <input type="checkbox"/> Zero Suppress <div style="border: 1px solid gray; width: 40px; height: 25px; margin: 5px auto; display: flex; align-items: center; justify-content: center;">0025</div> <p>Leading zeroes are added to correspond to the length of Display Digits</p> </div> </div>
Preview	Preview the selected style.
Numeral Value Color	Set the calculation data color.
Background Color	Set the calculation data background color.
Blink	Select the blink and blink speed. You can choose different blink settings for the [Numeral Value Color] and [Background Color]. <div style="border: 1px solid black; padding: 2px; margin-top: 10px;">NOTE</div> <ul style="list-style-type: none"> There are cases where you can and cannot set Blink depending on the Display Unit and System Settings' [Color Settings]. <p> "8.5.1 Setting Colors ■ List of Compatible Colors" (page 8-36)</p>

[Alarm] Tab

Same as the [Calculation Settings] dialog box which displays when you click [Total Type Settings] in the [Basic] mode.

☞ " ◆ [Calculation Settings] Dialog Box" (page 24-73)

◆ **Column/Row Detail Settings [Item Name (vertical)] [Item Name (horizontal)] dialog box**

In the Preview area, when you select an Item Name column/row and click [Column/Row Detail Settings], the following dialog box will be displayed.

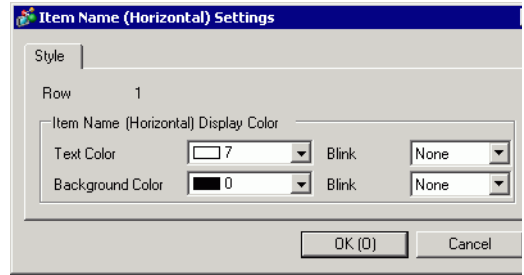
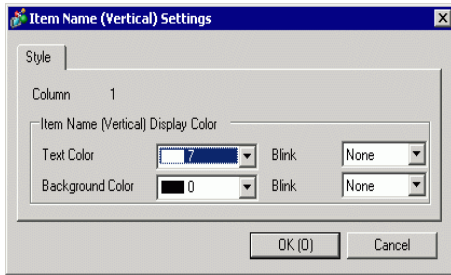



Setting	Description
Row	Displays the selected Item Name column/row number.
Text Color	Select the text's color.
Background Color	Set the background color for the text.
Blink	<p>Select the blink and blink speed. You can choose different blink settings for the [Display Color], and [Background Color].</p> <p>NOTE</p> <ul style="list-style-type: none"> There are cases where you can and cannot set Blink depending on the Display Unit and System Settings' [Color Settings]. <p>☞ "8.5.1 Setting Colors ■ List of Compatible Colors" (page 8-36)</p>

■ Print

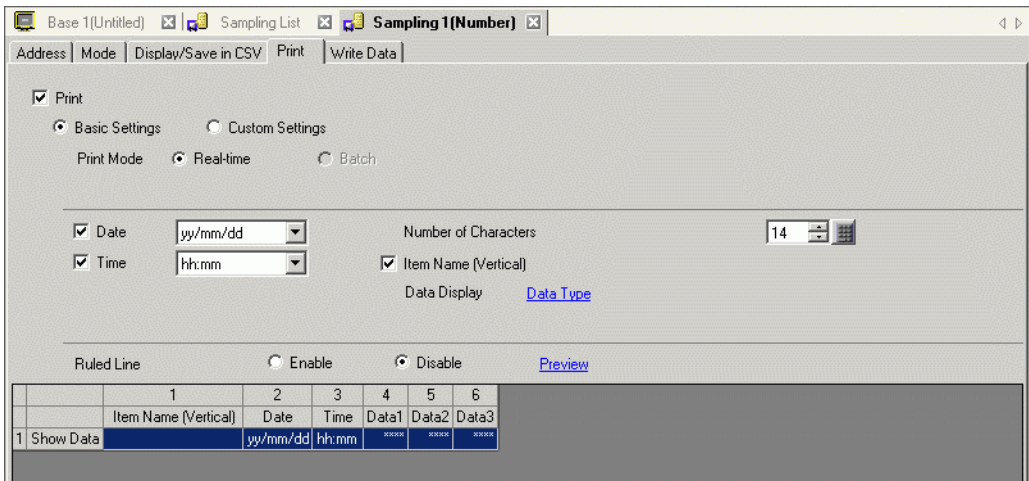

Set the format for printing sampling data from a printer connected to the GP.

The following is a settings guide for [Basic]. For [Custom Settings], see "■ Print (Custom Settings)" (page 24-95).

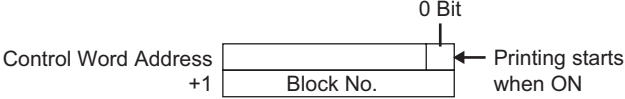

Setting	Description
Print	Select whether or not to print. When printing sampling data, ensure that this option is checked, and select the print format.  "24.9.5 Printing" (page 24-141)
Basic Settings/ Custom Settings	Select the print format setting mode. <ul style="list-style-type: none"> Basic Settings Use a preset format to easily configure settings. Custom Settings Set a customized format.
Print Mode	Select the print timing. <ul style="list-style-type: none"> Real-time Print Printing is performed every time sampling occurs. Batch Data is printed in block units. This can only be set when in the [Mode] tab's Extended area the [Overwrite old data after finishing the specified cycles] check box is cleared. Printing is started via the [Print Control Word Address]. <div style="border: 1px solid gray; padding: 5px; margin-top: 10px;"> <input checked="" type="radio"/> Batch Print Control Word Address <input type="text" value="[PLC1]D00000"/> Print Completion Bit Address <input type="text" value="[PLC1]X00000"/> </div>

Continued

Setting		Description
Print mode	Print Control Word Address	<p>When the [Print Mode] is set to [Batch], select an address to control the start of printing. When 0 bit of the designated address turns ON the printing starts.</p> <p>Two sequential Words are used to store the Word Address: the control Word and the block number. Select the block number and start the printing.</p>  <p style="text-align: center;">Control Word Address +1 0 Bit Block No. ← Printing starts when ON</p>
	Print Completion Bit Address	<p>When the [Print Mode] is set to [Batch], select an address to confirm the completion of the printing.</p> <p>Designates the Bit Address to be turned ON when data is printed out for each block. After confirming that this Bit Address is turned ON, perform the next printing.</p>
Date	<p>Defines whether or not to print the date, as: [yy/mm/dd], [mm/dd/yy], [dd/mm/yy], or [mm/dd]. "yy" prints the last two digits of the year, and "mm" and "dd" use two digits to print the month and date. "yy" displays the last two digits of the year, and "mm" and "dd" use two digits to display the month and date.</p> <p>NOTE</p> <ul style="list-style-type: none"> • [yy/mm/dd] and [mm/dd] can be selected only when the [language] in the sampling list is [Japanese]. 	
Time	<p>Select the time format [hh:mm], [hh:mm:ss] or [hh:mm:ss.ms]. "hh" displays the hours, "mm" displays the minutes, and "ss" displays the seconds, all using two digits. "ms" uses three digits to display the milliseconds.</p> <p>NOTE</p> <ul style="list-style-type: none"> • [hh/mm] and [hh/mm/ss] can be selected only when the [language] in the sampling list is [Japanese]. 	
Number of Characters	<p>If in the [Mode] tab's Extended area the [Overwrite old data after finishing the specified cycles] check box is selected, set the number of characters to display in a cell.</p>	
Item Name (Horizontal) Characters	<p>If in the [Mode] tab's Extended area the [Overwrite old data after finishing the specified cycles] check box is cleared, designate whether or not to print the Item Name row. If printing, the number of characters in the block name can be from 1 to 20 (single-byte).</p> <p>For the Date and Time columns, the item names will be printed as [Date] and [Time]. For a Data column, the address will be printed.</p>	
Item Name (Vertical) Characters	<p>Select whether or not the Item Name column will be printed.</p>	
Data Display	<p>Click [Data Type Settings] to open the [Data Settings] dialog box. The data type, input range, number of display digits can now be set.</p> <p> " ◆ [Data Settings] Dialog Box" (page 24-91)</p>	

Continued

Setting	Description																																																																		
Total	<p>If in the [Mode] tab's Extended area the [Overwrite old data after finishing the specified cycles] check box is cleared, designate whether or not to print the Total row. Click on [Data Type Settings] and open the [Calculation Settings] dialog box. The number of display digits for the Totals rows can now be set.</p> <p>☞ " ◆ [Calculation Settings] Dialog Box" (page 24-94)</p>																																																																		
Ruled Line	<p>Select whether or not the ruled line will be printed.</p>																																																																		
Preview	<p>Opens a preview screen to confirm the print image.</p>																																																																		
Preview area	<p>Displays the set contents with the selected print format.</p> <p>If in the [Mode] tab's Extended area the [Overwrite old data after finishing the specified cycles] check box is selected, only one data row will be displayed. If the [Overwrite old data after finishing the specified cycles] check box is cleared, the data rows equal the designated [Number of Times].</p> <p>When [Overwrite old data after finishing the specified cycles] check box is selected</p> <div data-bbox="451 794 824 842" style="border: 1px solid black; padding: 2px; margin: 10px 0;"> yy/mm/dd hh:mm **** * </div> <p>When [Overwrite old data after finishing the specified cycles] check box is cleared</p> <table border="1" data-bbox="451 962 1094 1263" style="width: 100%; border-collapse: collapse; text-align: center;"> <thead> <tr> <th></th> <th>Date</th> <th>Time</th> <th>[PLC1]D00100</th> <th>[PLC1]D00101</th> <th>[PLC1]D00102</th> </tr> </thead> <tbody> <tr><td>No.1</td><td>yy/mm/dd</td><td>hh:mm</td><td>****</td><td>****</td><td>****</td></tr> <tr><td>No.2</td><td>yy/mm/dd</td><td>hh:mm</td><td>****</td><td>****</td><td>****</td></tr> <tr><td>No.3</td><td>yy/mm/dd</td><td>hh:mm</td><td>****</td><td>****</td><td>****</td></tr> <tr><td>No.4</td><td>yy/mm/dd</td><td>hh:mm</td><td>****</td><td>****</td><td>****</td></tr> <tr><td>No.5</td><td>yy/mm/dd</td><td>hh:mm</td><td>****</td><td>****</td><td>****</td></tr> <tr><td>No.6</td><td>yy/mm/dd</td><td>hh:mm</td><td>****</td><td>****</td><td>****</td></tr> <tr><td>No.7</td><td>yy/mm/dd</td><td>hh:mm</td><td>****</td><td>****</td><td>****</td></tr> <tr><td>No.8</td><td>yy/mm/dd</td><td>hh:mm</td><td>****</td><td>****</td><td>****</td></tr> <tr><td>No.9</td><td>yy/mm/dd</td><td>hh:mm</td><td>****</td><td>****</td><td>****</td></tr> <tr><td>No.10</td><td>yy/mm/dd</td><td>hh:mm</td><td>****</td><td>****</td><td>****</td></tr> </tbody> </table>		Date	Time	[PLC1]D00100	[PLC1]D00101	[PLC1]D00102	No.1	yy/mm/dd	hh:mm	****	****	****	No.2	yy/mm/dd	hh:mm	****	****	****	No.3	yy/mm/dd	hh:mm	****	****	****	No.4	yy/mm/dd	hh:mm	****	****	****	No.5	yy/mm/dd	hh:mm	****	****	****	No.6	yy/mm/dd	hh:mm	****	****	****	No.7	yy/mm/dd	hh:mm	****	****	****	No.8	yy/mm/dd	hh:mm	****	****	****	No.9	yy/mm/dd	hh:mm	****	****	****	No.10	yy/mm/dd	hh:mm	****	****	****
	Date	Time	[PLC1]D00100	[PLC1]D00101	[PLC1]D00102																																																														
No.1	yy/mm/dd	hh:mm	****	****	****																																																														
No.2	yy/mm/dd	hh:mm	****	****	****																																																														
No.3	yy/mm/dd	hh:mm	****	****	****																																																														
No.4	yy/mm/dd	hh:mm	****	****	****																																																														
No.5	yy/mm/dd	hh:mm	****	****	****																																																														
No.6	yy/mm/dd	hh:mm	****	****	****																																																														
No.7	yy/mm/dd	hh:mm	****	****	****																																																														
No.8	yy/mm/dd	hh:mm	****	****	****																																																														
No.9	yy/mm/dd	hh:mm	****	****	****																																																														
No.10	yy/mm/dd	hh:mm	****	****	****																																																														

◆ [Data Settings] Dialog Box

[Data Type] Tab

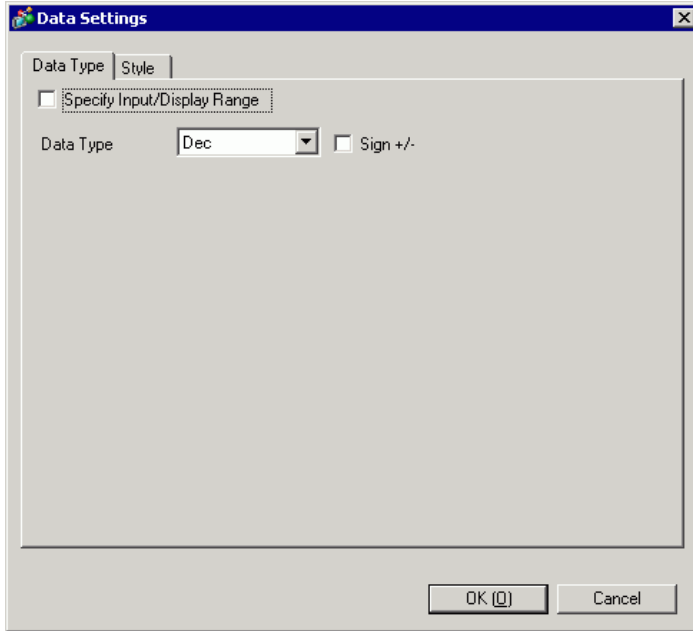

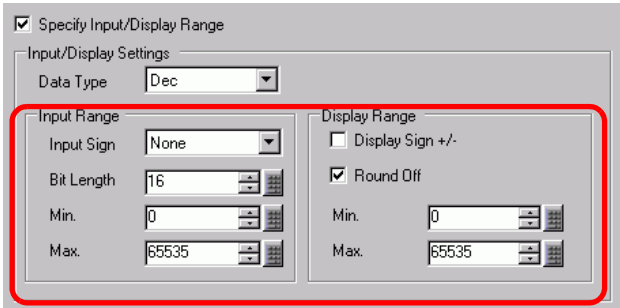

Setting	Description
Specify Input/Display Range	<p>Designate whether or not an input range and display range of the data will be set. If designated, the following setting items will appear.</p> 
Data Type	<p>Choose the data type from [Dec], [BCD], [Hex], or [Float]. [Float] can only be selected when the set [Bit Length] is [32 Bit] on the [Address] tab.</p> <p>NOTE</p> <ul style="list-style-type: none"> When [BCD] is selected, sampling data that contains the digits A-F (hexadecimal) rather than BCD is printed as "----" (Number of digits "-").
Sign +/-	<p>Designate whether or not to attach a minus sign to data. This can only be set when the [Data Type] is [Dec].</p> <p>NOTE</p> <ul style="list-style-type: none"> This is fixed when the [Data Type] is [Float].

Continued

Setting		Description																																		
Input Range	Input Sign	<p>If [Specify Input/Display Range] is designated and [Data Type] is [Dec], select whether or not to handle negative numbers.</p> <ul style="list-style-type: none"> • None Only positive numeric data. • 2's Complement Negative numbers are handled with 2's complement. • MSB Sign Negative numbers are handled with MSB sign (highest bit). 																																		
	Bit Length	If [Specify Input/Display Range] is designated and [Data Length] is [16 Bit] on the [Address] tab, set the bit length for one word from 1 to 16.																																		
	Min. Value/ Max. Value	<p>If [Specify Input/Display Range] is designated, set the data input range. Each [Data Type] and [Input Sign] has a different size range.</p> <table border="1" style="width: 100%; border-collapse: collapse;"> <thead> <tr> <th>Bit Length</th> <th>Data Type</th> <th>Input Sign</th> <th>Input Range</th> </tr> </thead> <tbody> <tr> <td rowspan="5">16 bit</td> <td rowspan="3">Dec</td> <td>None</td> <td>0 to 65535</td> </tr> <tr> <td>2's Complement</td> <td>-32768 to 32767</td> </tr> <tr> <td>MSB Sign</td> <td>-32767 to 32767</td> </tr> <tr> <td>Hex</td> <td>-</td> <td>0 0 to FFFF(h)</td> </tr> <tr> <td>BCD</td> <td>-</td> <td>0 to 9999</td> </tr> <tr> <td rowspan="5">32 bit</td> <td rowspan="3">Dec</td> <td>None</td> <td>0 to 4294967295</td> </tr> <tr> <td>2's Complement</td> <td>-2147483648 to 2147483647</td> </tr> <tr> <td>MSB Sign</td> <td>-2147483647 to 2147483647</td> </tr> <tr> <td>Hex</td> <td>-</td> <td>0 0 to FFFFFFFF(h)</td> </tr> <tr> <td>BCD</td> <td>-</td> <td>0 to 99999999</td> </tr> <tr> <td>Float</td> <td>-</td> <td>-9.9e16 to 9.9e16</td> </tr> </tbody> </table> <p>If [Specify Input/Display Range] is designated, Min. Value/Max. Value for the [Display Range] is displayed.</p>	Bit Length	Data Type	Input Sign	Input Range	16 bit	Dec	None	0 to 65535	2's Complement	-32768 to 32767	MSB Sign	-32767 to 32767	Hex	-	0 0 to FFFF(h)	BCD	-	0 to 9999	32 bit	Dec	None	0 to 4294967295	2's Complement	-2147483648 to 2147483647	MSB Sign	-2147483647 to 2147483647	Hex	-	0 0 to FFFFFFFF(h)	BCD	-	0 to 99999999	Float	-
Bit Length	Data Type	Input Sign	Input Range																																	
16 bit	Dec	None	0 to 65535																																	
		2's Complement	-32768 to 32767																																	
		MSB Sign	-32767 to 32767																																	
	Hex	-	0 0 to FFFF(h)																																	
	BCD	-	0 to 9999																																	
32 bit	Dec	None	0 to 4294967295																																	
		2's Complement	-2147483648 to 2147483647																																	
		MSB Sign	-2147483647 to 2147483647																																	
	Hex	-	0 0 to FFFFFFFF(h)																																	
	BCD	-	0 to 99999999																																	
Float	-	-9.9e16 to 9.9e16																																		
Display Range	Display Sign +/-	If [Specify Input/Display Range] is designated and [Data Type] is [Dec], select whether or not to attach a sign to display data. This is fixed when the [Data Type] is [Float].																																		
	Round Off	Designate whether or not to round off fractions when converting input values to the display range. Fractions will be discarded if rounding off is not selected.																																		
	Min. Value/ Max. Value	<p>If you select [Specify an Input/Display Range], select the Min/Max for the display range. The settings range is different, depending on the [Data Type] and whether [Display Sign +/-] is set.</p> <table border="1" style="width: 100%; border-collapse: collapse;"> <thead> <tr> <th>Bit Length</th> <th>Data Type</th> <th>Display Sign +/-</th> <th>Display Range</th> </tr> </thead> <tbody> <tr> <td rowspan="4">16 bit</td> <td rowspan="2">Dec</td> <td>Enable</td> <td>-32768 to 32767</td> </tr> <tr> <td>Disable</td> <td>0 to 65535</td> </tr> <tr> <td>Hex</td> <td>-</td> <td>0 0 to FFFF(h)</td> </tr> <tr> <td>BCD</td> <td>-</td> <td>0 to 9999</td> </tr> <tr> <td rowspan="5">32 bit</td> <td rowspan="2">Dec</td> <td>Enable</td> <td>-2147483648 to 2147483647</td> </tr> <tr> <td>Disable</td> <td>0 to 4294967295</td> </tr> <tr> <td>Hex</td> <td>-</td> <td>0 0 to FFFFFFFF(h)</td> </tr> <tr> <td>BCD</td> <td>-</td> <td>0 to 99999999</td> </tr> <tr> <td>Float</td> <td>Checked (Fixed)</td> <td>-9.9e16 to 9.9e16</td> </tr> </tbody> </table>	Bit Length	Data Type	Display Sign +/-	Display Range	16 bit	Dec	Enable	-32768 to 32767	Disable	0 to 65535	Hex	-	0 0 to FFFF(h)	BCD	-	0 to 9999	32 bit	Dec	Enable	-2147483648 to 2147483647	Disable	0 to 4294967295	Hex	-	0 0 to FFFFFFFF(h)	BCD	-	0 to 99999999	Float	Checked (Fixed)	-9.9e16 to 9.9e16			
Bit Length	Data Type	Display Sign +/-	Display Range																																	
16 bit	Dec	Enable	-32768 to 32767																																	
		Disable	0 to 65535																																	
	Hex	-	0 0 to FFFF(h)																																	
	BCD	-	0 to 9999																																	
32 bit	Dec	Enable	-2147483648 to 2147483647																																	
		Disable	0 to 4294967295																																	
	Hex	-	0 0 to FFFFFFFF(h)																																	
	BCD	-	0 to 99999999																																	
	Float	Checked (Fixed)	-9.9e16 to 9.9e16																																	

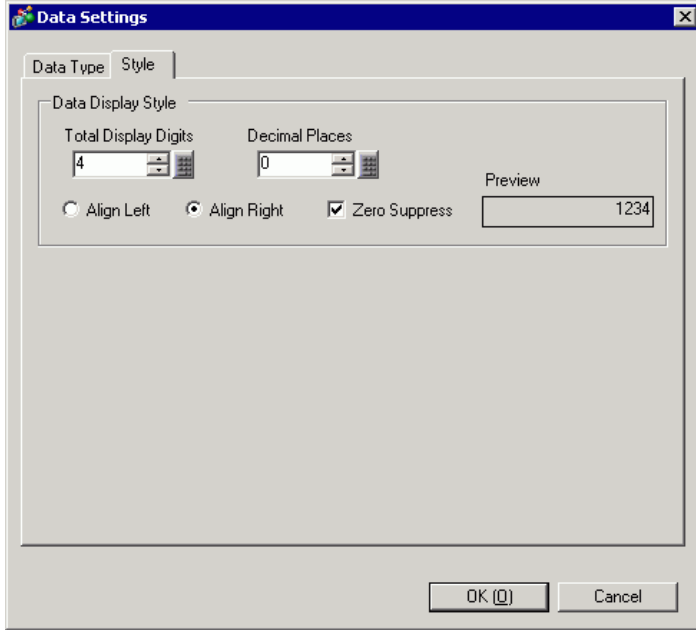
[Style] Tab

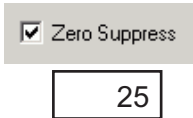
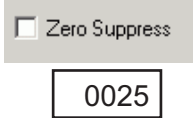

Setting	Description
Total Display Digits	Select the number of display digits for the data from 1 to 17. This can be designated to within the number of characters set in [Characters] or [Item Name (Horizontal) Characters]. The numbers displayed after the decimal point are also included in the number of digits. (For example, Total Display Digits is "5", and the Decimal Places is "2") 
Decimal Places	Set the number of display digits after the decimal point, from: 0 to [Total Display Digits]-1. This cannot be set when the [Data Type] is [Hex].
Align Right/Align Left	Select the data display position.
Zero Suppress	If this option is selected, leading zeros are not displayed. (For example, Number of Display Digits = 4)  Leading zeroes are not displayed  Leading zeroes are added to correspond to the length of Display Digits
Preview	Preview the selected style.

◆ **[Calculation Settings] Dialog Box**

To display a Total row, click [Data Type Settings]. The [Calculation Settings] dialog box appears.

[Data Type] Tab

The [Total] row data type conforms to the settings in the [Data Settings] dialog box. (There is no item to set on this tab.)

[Style] Tab

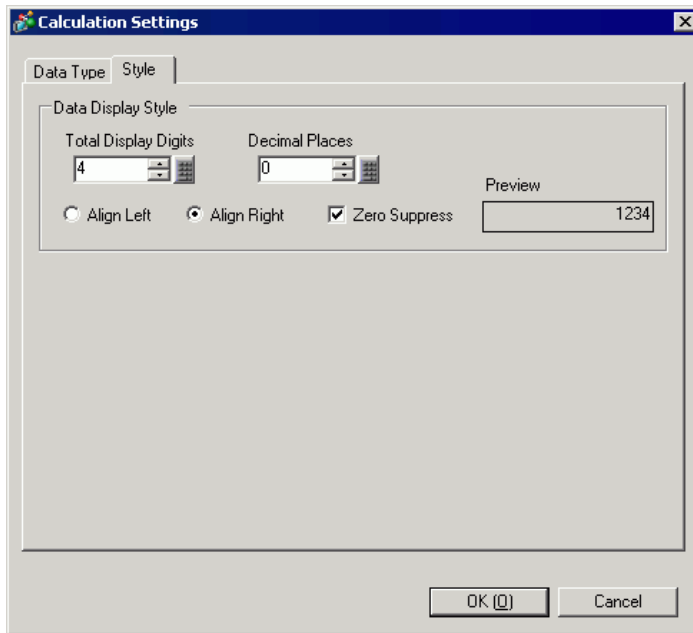

Setting	Description
Total Display Digits	Select the number of display digits for the calculation data from 1 to 17. This can be designated to within the number of characters set in [Item Name (Horizontal) Characters]. The numbers displayed after the decimal point are also included in the number of digits. For example, when the Total Display Digits is 5, and the Decimal Places is 2. <div style="border: 1px solid gray; padding: 2px; display: inline-block; margin: 5px;">123.45</div>
Decimal Places	Set the number of display digits after the decimal point for the calculation data, from 0 to [Total Display Digits]-1. This cannot be set when the [Data Type] is [Hex].
Align Right/Align Left	Select the calculation data display position.
Zero Suppress	If this option is selected, leading zeros are not displayed. (For example, Number of Display Digits = 4) <div style="display: flex; justify-content: space-around; align-items: center; margin-top: 10px;"> <div style="text-align: center;"> <input checked="" type="checkbox"/> Zero Suppress <div style="border: 1px solid gray; padding: 2px 10px;">25</div> Leading zeroes are not displayed </div> <div style="text-align: center;"> <input type="checkbox"/> Zero Suppress <div style="border: 1px solid gray; padding: 2px 10px;">0025</div> Leading zeroes are added to correspond to the length of Display Digits </div> </div>
Preview	Preview the selected style.

■ Print (Custom Settings)

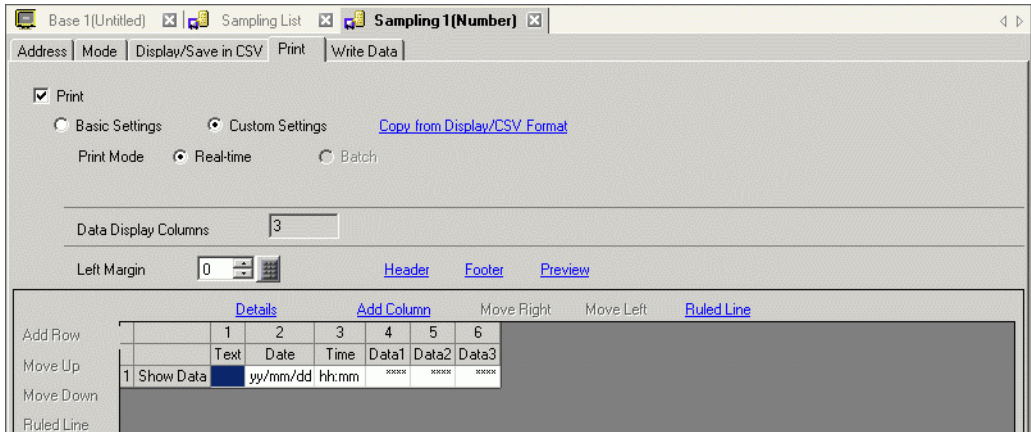

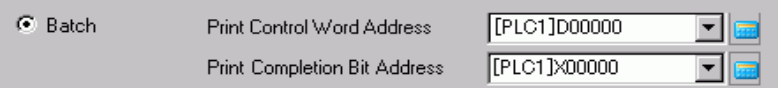
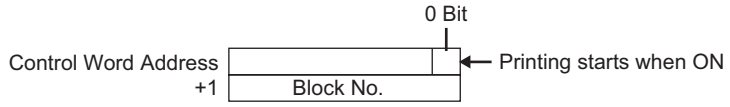
Setting	Description
Print Mode	<p>Select the print timing.</p> <ul style="list-style-type: none"> • Real-time Print Printing is performed every time sampling occurs. • Batch Data is printed in block units. This can only be set when in the [Mode] tab's Extended area the [Overwrite old data after finishing the specified cycles] check box is cleared. Printing is started via the [Print Control Word Address]. 
Print Control Word Address	<p>When the [Print Mode] is set to [Batch], select an address to control the printing. When 0 bit of the designated address turns ON the printing starts. Two sequential Words are used to store the Word Address: the control Word and the block number. Select the block number and start the printing.</p> 
Print Completion Bit Address	<p>When the [Print Mode] is set to [Batch], select an address to confirm the completion of the printing. Designates the Bit Address to be turned ON when data is printed out for each block. After confirming that this Bit Address is turned ON, perform the next printing.</p>
Copy from Display/CSV Format	<p>When the format is set on the [Display/Save in CSV] tab, copy the settings from the [Display/Save in CSV] tab. Use this feature when you want to print data using the Display/Save in CSV format.</p> <p>NOTE</p> <ul style="list-style-type: none"> • The Display/Save in CSV format Item Name (Horizontal)/Block Name (Vertical) are handled as a Text row/Text column in the print settings.

Continued

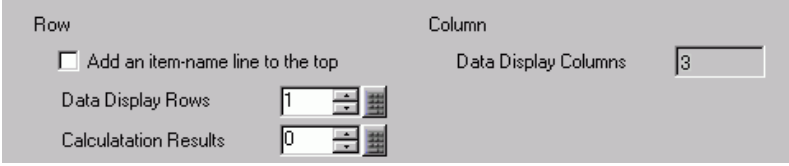
Setting	Description
Data Display Columns	Displays the number of data columns.
Row/Column	<p>You can set the following items when in the [Mode] tab's Extended area the [Overwrite old data after finishing the specified cycles] check box is cleared.</p> 
Add an item-name line to the top	Designate whether or not to add text rows on top of the Data row. The sampling addresses are displayed in the editing area as the Data column item names. Cells that have an address displayed cannot be edited.
Data Display Rows	<p>Set the number of data rows to print from 1 to the [Number of Times] set on the [Mode] tab.</p> <p>IMPORTANT</p> <ul style="list-style-type: none"> Adjust the number of data display rows to the [Number of Times].
Calculation Results	The number of calculation rows can be from 0 to 4. In the Calculation rows, values calculated (Total, Average, Max, Min) from data from the designated [Number of Times] can be displayed.
Data Display Columns	Displays the number of data columns.
Left Margin	The left margin when printing can be from 0 to 80 single-byte characters.
Header/Footer	<p>Opens the [Edit Header]/[Edit Footer] dialog box. Input text you wish to print as a header/footer. The number of characters that can be entered is 160 char./line x 40 lines.</p> <p>IMPORTANT</p> <ul style="list-style-type: none"> When [Overwrite old data when designated block count finishes] is set in the Action, printing will not be performed even if the Header/Footer is set. Only the Data rows will be printed.
Preview	Opens a preview screen to confirm the print image.
Details	<p>Opens up a dialog box to configure detail settings for the column or Calculation row selected in the Preview area.</p> <ul style="list-style-type: none"> ☞ " ◆ Detail Settings [Date Set] Dialog Box" (page 24-99) ☞ " ◆ Detail Settings [Time Set] Dialog Box" (page 24-100) ☞ " ◆ Detail Settings [Data Settings] Dialog Box" (page 24-101) ☞ " ◆ Detail Settings [Text Settings] Dialog Box" (page 24-103) ☞ " ◆ Detail Settings [Calculation Settings] Dialog Box" (page 24-104)

Continued

Setting	Description
<p>Add this Column</p>	<p>Insert a column in front of the column selected in the Preview area. Choose from a [Date], [Time], [Data], or [Text] column. You can directly input the desired text in each cell of an inserted [Text] column. When adding a [Data] column, the [Select Print Data] dialog box opens and you can select a data column (address) you want to add.</p> <div data-bbox="488 355 828 697" style="text-align: center;"> </div> <p>To add multiple addresses, drag the mouse to select consecutive columns. If you click columns to add while pressing the [Ctrl] key, you can select separate addresses.</p>
<p>Move Right/Move Left</p>	<p>Move the column you selected in the preview area to the right/left.</p>
<p>Ruled Line</p>	<p>Set the ruled line to print. Select from [Right Border], [Left Border], [Right+Left Border], or [Vertical Borders]</p>
<p>Add this Row</p>	<p>Insert a [Text] row in front of the row selected in the Preview area. You can directly input the desired text in each cell of an inserted [Text] row.</p> <div data-bbox="385 981 474 1020" style="border: 1px solid black; padding: 2px; width: fit-content;"> <p>NOTE</p> </div> <ul style="list-style-type: none"> • When multiple calculation rows are set, you cannot input a [Text] row between two calculation rows.
<p>Move Up/ Down</p>	<p>Move the [Text] row selected in the Preview area upward/downward.</p>
<p>Ruled Line</p>	<p>Set the ruled line to print. Select from [Top Border], [Bottom Border], [Top+Bottom], [Horizontal Borders].</p>

Continued

Setting	Description																																																
Preview area	<p>Displays the set contents with the selected format.</p> <p>If [Overwrite old data after finishing the specified cycles] is selected on the [Mode] tab's Extended settings, only one data row will display. If the [Overwrite old data after finishing the specified cycles] check box is cleared, the data rows equal the designated [Number of Times].</p> <p>When [Overwrite old data after finishing the specified cycles] check box is selected</p>																																																
	<table border="1" data-bbox="450 440 1061 548"> <thead> <tr> <th></th> <th>1</th> <th>2</th> <th>3</th> <th>4</th> <th>5</th> <th>6</th> </tr> </thead> <tbody> <tr> <td></td> <td>Text</td> <td>Date</td> <td>Time</td> <td>Data1</td> <td>Data2</td> <td>Data3</td> </tr> <tr> <td>1 Show Data</td> <td></td> <td>yy/mm/dd</td> <td>hh:mm</td> <td>xxxx</td> <td>xxxx</td> <td>xxxx</td> </tr> </tbody> </table>		1	2	3	4	5	6		Text	Date	Time	Data1	Data2	Data3	1 Show Data		yy/mm/dd	hh:mm	xxxx	xxxx	xxxx																											
		1	2	3	4	5	6																																										
		Text	Date	Time	Data1	Data2	Data3																																										
1 Show Data		yy/mm/dd	hh:mm	xxxx	xxxx	xxxx																																											
<p>When [Overwrite old data after finishing the specified cycles] check box is cleared</p>																																																	
<table border="1" data-bbox="450 672 1196 875"> <thead> <tr> <th></th> <th>1</th> <th>2</th> <th>3</th> <th>4</th> <th>5</th> <th>6</th> </tr> </thead> <tbody> <tr> <td></td> <td>Item Name (Vertical)</td> <td>Date</td> <td>Time</td> <td>Data1</td> <td>Data2</td> <td>Data3</td> </tr> <tr> <td>1 Item Name (Horizontal)</td> <td></td> <td>Date</td> <td>Time</td> <td>[PLC1]D00100</td> <td>[PLC1]D00101</td> <td>[PLC1]D00102</td> </tr> <tr> <td>2 No.1</td> <td></td> <td>yy/mm/dd</td> <td>hh:mm</td> <td>xxxx</td> <td>xxxx</td> <td>xxxx</td> </tr> <tr> <td>3 No.2</td> <td></td> <td>yy/mm/dd</td> <td>hh:mm</td> <td>xxxx</td> <td>xxxx</td> <td>xxxx</td> </tr> <tr> <td>4 No.3</td> <td></td> <td>yy/mm/dd</td> <td>hh:mm</td> <td>xxxx</td> <td>xxxx</td> <td>xxxx</td> </tr> <tr> <td>5 No.4</td> <td></td> <td>yy/mm/dd</td> <td>hh:mm</td> <td>xxxx</td> <td>xxxx</td> <td>xxxx</td> </tr> </tbody> </table>		1	2	3	4	5	6		Item Name (Vertical)	Date	Time	Data1	Data2	Data3	1 Item Name (Horizontal)		Date	Time	[PLC1]D00100	[PLC1]D00101	[PLC1]D00102	2 No.1		yy/mm/dd	hh:mm	xxxx	xxxx	xxxx	3 No.2		yy/mm/dd	hh:mm	xxxx	xxxx	xxxx	4 No.3		yy/mm/dd	hh:mm	xxxx	xxxx	xxxx	5 No.4		yy/mm/dd	hh:mm	xxxx	xxxx	xxxx
	1	2	3	4	5	6																																											
	Item Name (Vertical)	Date	Time	Data1	Data2	Data3																																											
1 Item Name (Horizontal)		Date	Time	[PLC1]D00100	[PLC1]D00101	[PLC1]D00102																																											
2 No.1		yy/mm/dd	hh:mm	xxxx	xxxx	xxxx																																											
3 No.2		yy/mm/dd	hh:mm	xxxx	xxxx	xxxx																																											
4 No.3		yy/mm/dd	hh:mm	xxxx	xxxx	xxxx																																											
5 No.4		yy/mm/dd	hh:mm	xxxx	xxxx	xxxx																																											

◆ Detail Settings [Date Set] Dialog Box

Select the Date column and click [Detail Settings]. The following dialog box appears.

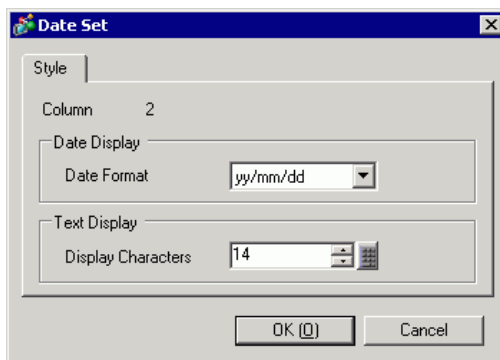

Setting	Description
Column	Displays the selected column number.
Date Format	<p>Select the date format as: [yy/mm/dd], [mm/dd/yy], [dd/mm/yy], [mm/dd]</p> <p>"yy" displays the last two digits of the year, and "mm" and "dd" use two digits to display the month and date.</p> <p>NOTE</p> <ul style="list-style-type: none"> • [yy/mm/dd] and [mm/dd] can be selected only when the [language] in the sampling list is [Japanese].
Display Characters	Set the number of characters to 20 single-byte characters or less for display in the Date column cells.

◆ Detail Settings [Time Set] Dialog Box

Select the Date column and click [Detail Settings]. The following dialog box appears.

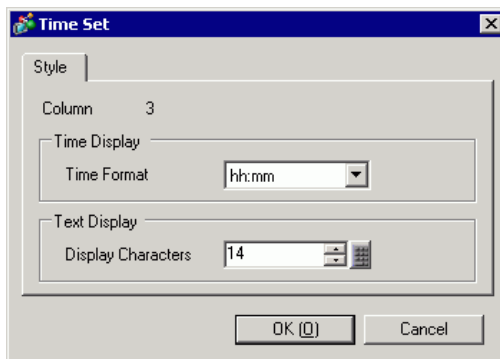

Setting	Description
Column	Displays the selected column number.
Time Format	<p>Select the time format [hh:mm], [hh:mm:ss], or [hh:mm:ss.ms]. "hh" displays the hours, "mm" displays the minutes, and "ss" displays the seconds, all using two digits. "ms" uses three digits to display the milliseconds.</p> <p>NOTE</p> <ul style="list-style-type: none"> • [hh/mm] and [hh/mm/ss] can be selected only when the [language] in the sampling list is [Japanese].
Display Characters	Set the number of characters to 20 single-byte characters or less for display in the Time column cells.

◆ **Detail Settings [Data Settings] Dialog Box**

Select a Data column in the Preview area and click [Detail Settings]. The following dialog box appears.

[Data Type] Tab

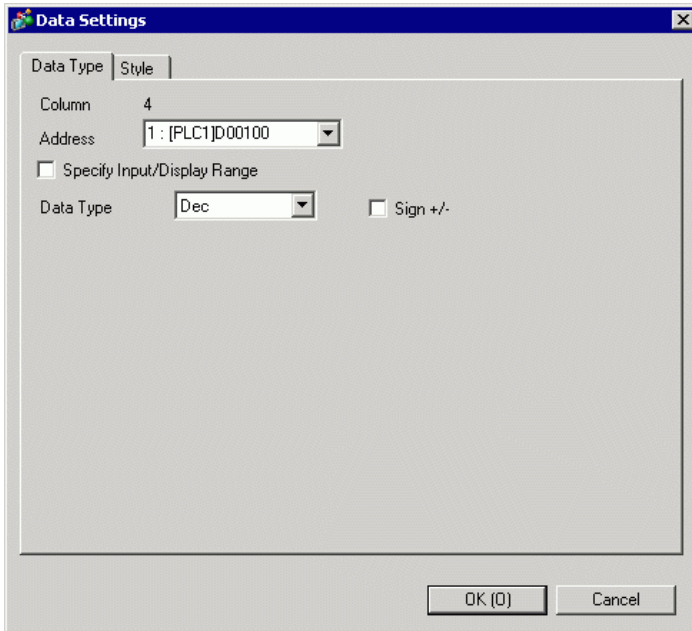

Setting	Description
Column	Displays the selected column's number.
Address	Displays the selected column address. Display the list and you can change the registered address in the sampling group.
Specify Input/Display Range	<p>Designate whether or not an input range and display range will be set. If designated, the following setting items will appear.</p> <p>NOTE</p> <ul style="list-style-type: none"> Each setting for the input range/display range is the same as [Basic] mode, [Data Type Settings], in the displayed [Data Settings] dialog box. "◆ [Data Settings] Dialog Box" (page 24-91)

Continued

Setting	Description
Data Type	<p>Choose the data type from [Dec], [BCD], [Hex], or [Float]. [Float] can only be selected when the set [Bit Length] is [32 Bit] on the [Address] tab.</p> <p>NOTE</p> <ul style="list-style-type: none"> When [BCD] is selected, sampling data that contains the digits A-F (hexadecimal) rather than BCD is printed as "----" (Number of digits "-").
Sign +/-	<p>Designate whether or not to attach a minus sign to data. This can only be set when the [Data Type] is [Dec].</p> <p>NOTE</p> <ul style="list-style-type: none"> This is fixed when the [Data Type] is [Float].

[Style] Tab

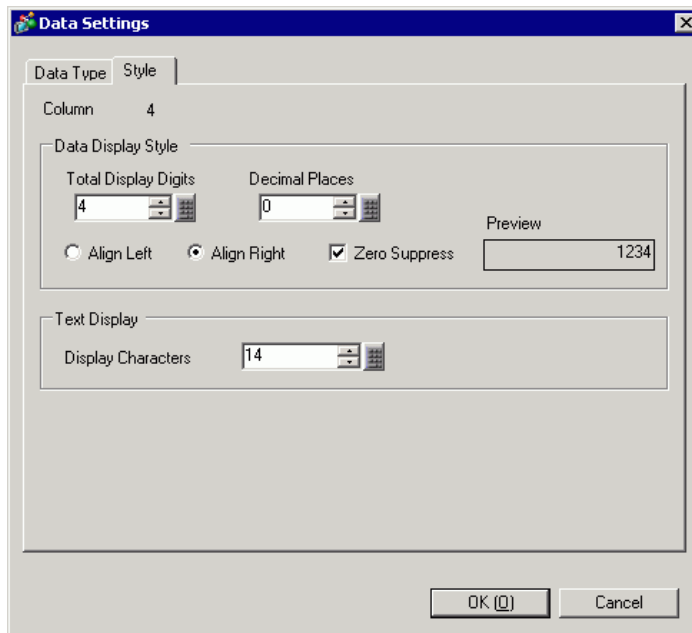

Setting	Description
Total Display Digits	<p>Select the number of display digits for the data from 1 to 17. This can be designated to within the number of characters set in [Display Characters]. The numbers displayed after the decimal point are also included in the number of digits. (For example, Total Display Digits is "5", and the Decimal Places is "2")</p> <p style="text-align: center;">123.45</p>
Decimal Places	<p>Set the number of display digits after the decimal point, from: 0 to [Total Display Digits]-1. This cannot be set when the [Data Type] is [Hex].</p>
Align Right/Align Left	<p>Select the data display position.</p>

Continued

Setting	Description
Zero Suppress	<p>If this option is selected, leading zeros are not displayed. (For example, Number of Display Digits = 4)</p> <div style="display: flex; justify-content: space-around; align-items: center;"> <div style="text-align: center;"> <input checked="" type="checkbox"/> Zero Suppress <div style="border: 1px solid black; padding: 2px 10px;">25</div> <p>Leading zeroes are not displayed</p> </div> <div style="text-align: center;"> <input type="checkbox"/> Zero Suppress <div style="border: 1px solid black; padding: 2px 10px;">0025</div> <p>Leading zeroes are added to correspond to the length of Display Digits</p> </div> </div>
Preview	Preview the selected style.
Display Characters	Set the number of characters to be displayed in the Data column cells from 1 to 20 single-byte characters.

◆ **Detail Settings [Text Settings] Dialog Box**

If you add a [Text] column, select the column and click [Detail Settings]. The following dialog box appears.

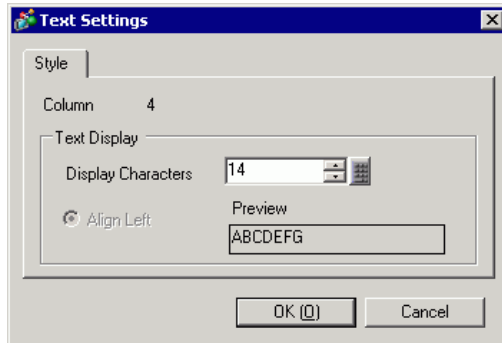

Setting	Description
Column	Displays the selected column number.
Display Characters	Set the number of characters to 20 single-byte characters or less for display in the [Text] column cells.
Align Left	The display of the text is fixed as left-aligned.
Preview	Previews the selected text column style.

◆ Detail Settings [Calculation Settings] Dialog Box

If the [Number of Calculation Display Rows] in [Block Print] is not zero, select the Calculation row or Data column Calculation cell, and click [Detail Settings]. The following dialog box appears.

[Data Type] Tab

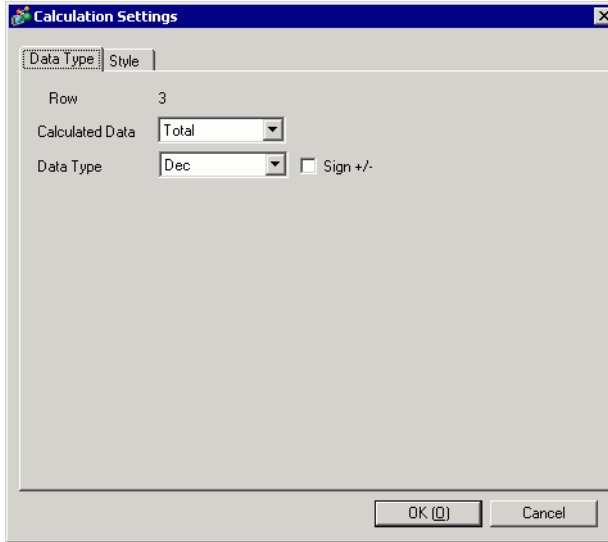

Setting	Description
Row	Displays the selected row number.
Calculated Data	Choose the data calculation type from [Total], [Average], [Max], or [Min].
Data Type	Choose the data type from [Dec], [BCD], [Hex], or [Float]. [Float] can only be selected when the set [Bit Length] is [32 Bit] on the [Address] tab. NOTE <ul style="list-style-type: none"> When [BCD] is selected, sampling data that contains the digits A-F (hexadecimal) rather than BCD is printed as "----" (Number of digits "-").
Sign +/-	Designate whether or not to attach a minus sign to data. This can only be set when the [Data Type] is [Dec]. NOTE <ul style="list-style-type: none"> This is fixed when the [Data Type] is [Float].

[Style] Tab

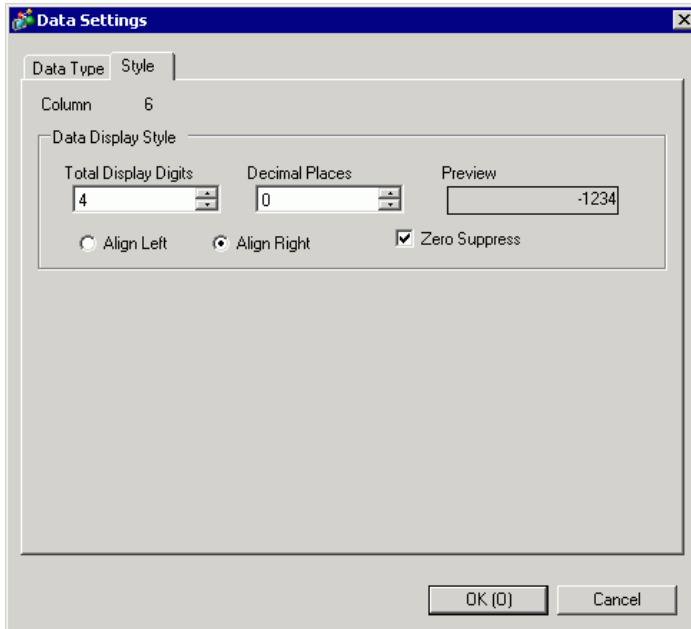

Setting	Description
Total Display Digits	Select the number of display digits for the calculation data from 1 to 17. This can be designated to within the number of characters set in the [Style Type] tab's [Display Characters]. The numbers displayed after the decimal point are also included in the number of digits. For example, when the Total Display Digits is 5, and the Decimal Places is 2. <div style="text-align: center; border: 1px solid black; width: 100px; margin: 5px auto;">123.45</div>
Decimal Places	Set the number of display digits after the decimal point for the calculation data, from 0 to [Total Display Digits]-1. This cannot be set when the [Data Type] is [Hex].
Align Right/Align Left	Select the calculation data display position.
Zero Suppress	If this option is selected, leading zeros are not displayed. (For example, Number of Display Digits = 4) <div style="display: flex; justify-content: space-around; align-items: center;"> <div style="text-align: center;"> <input checked="" type="checkbox"/> Zero Suppress <div style="border: 1px solid black; width: 40px; height: 25px; margin: 5px auto; display: flex; align-items: center; justify-content: center;">25</div> <p>Leading zeroes are not displayed</p> </div> <div style="text-align: center;"> <input type="checkbox"/> Zero Suppress <div style="border: 1px solid black; width: 40px; height: 25px; margin: 5px auto; display: flex; align-items: center; justify-content: center;">0025</div> <p>Leading zeroes are added to correspond to the length of Display Digits</p> </div> </div>
Preview	Preview the selected style.

■ Write Data

Select the settings for writing sampling data to the GP internal device. For more information about this function, please refer to the following.

☞ "24.9.6 Writing to the Internal Device" (page 24-148)

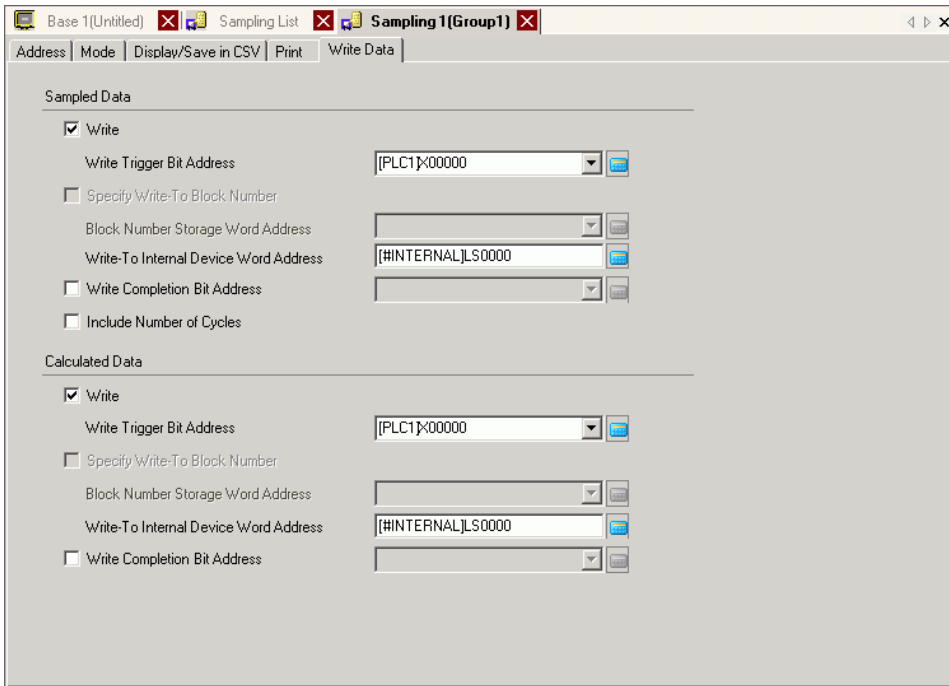

Setting		Description
Sampled Data	Write	Select whether or not to write the sampling data stored in backup SRAM (or DRAM) to the GP internal device.
	Write Trigger Bit Address	Set the address to control data writing to internal device addresses. When the bit address is set to ON, sampling data is sent to the internal device.
	Specify Write-To Block Number	If in the [Mode] tab's Extended area the [Overwrite old data after finishing the specified cycles] check box is cleared, designate whether or not to set the block number to write to the internal device.
	Block Number Storage Word Address	When [Specify Write-To Block Number] is designated, set a word address in order to store the block number. The data stored in this address block will be outputted to the internal device. If no block number is specified, data from Block Number "0" will be outputted.
	Write-To Internal Device Word Address	Select the internal device address where the data will be stored. The sampling data will be stored starting from this address. ☞ " ◆ The Structure of Sampled Data Stored in the Internal Device" (page 24-149)

Continued

Setting		Description
Sampled Data	Write Completion Bit Address	Designate whether or not to confirm the completion of writing to the internal device. If you want to confirm it, set a bit address. When the data write is finished, this bit will turn ON. NOTE <ul style="list-style-type: none"> This bit will not be turned OFF automatically. After confirming that the writing was completed, please turn OFF this bit.
	Include Number of Cycles	Designate whether or not to output the number of data sampled to the internal device along with the data.
Calculated Data	Write	Select whether or not to read total values for each data column, set on the [Display/Save in CSV] tab, to the internal device.
	Write Trigger Bit Address	Set the address to control the writing of calculation data to the internal device. When this bit address turns ON, the calculation values for each Data column set on the [Display/Save in CSV] tab are written to the internal device.
	Specify Write-To Block Number	If in the [Mode] tab's Extended area the [Overwrite old data after finishing the specified cycles] check box is selected, designate whether or not to set the block number to write to the internal device.
	Block Number Storage Word Address	When [Specify Write-To Block Number] is designated, set a word address in order to store the block number. The totals data stored in this address block will be outputted to the internal device. If no block number is specified, totals data from block number [0] will be outputted.
	Write-To Internal Device Word Address	Select the internal device address where the totals data will be stored. The calculation data will be stored starting from this address. ☞ " ◆ The Structure of Sampled Data Stored in the Internal Device" (page 24-149)
	Write Completion Bit Address	Designate whether or not to confirm the completion of calculation data writing to the internal device. If you want to confirm it, set a bit address. When the data write is finished, this bit will turn ON. NOTE <ul style="list-style-type: none"> This bit will not be turned OFF automatically. After confirming that the writing was completed, please turn OFF this bit.

24.8.2 Sampling Data Display Guide

Displays the sampling group data with the display format set in the Common - [Sampling] on the GP screen. One data item can be placed per screen.

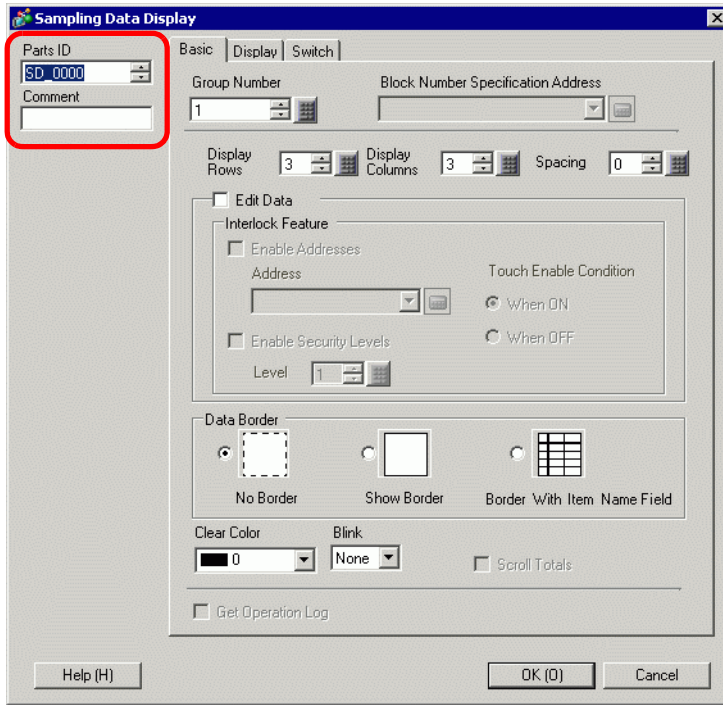

Setting	Description
Parts ID	Parts are automatically assigned an ID number. Sampling Data Display's ID: SD_**** (4 digits) The letter portion is fixed. You can change the number portion within the range of 0000-9999.
Comment	The comment for each Part can be up to 20 characters.

■ Basic

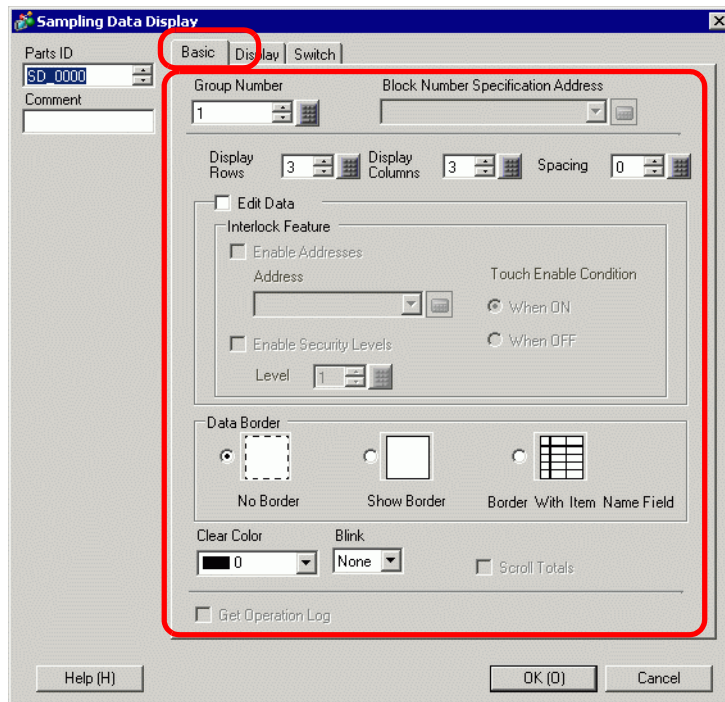

Setting	Description
Sampling Group	Set the sampling group number you want to display on the screen from among the sampling groups created in [Common] - [Sampling].
Block Number Specification Address	<p>When the designated sampling group has multiple blocks, this address will designate which block's data will be displayed. Time data are specified with binary input.</p> <p>You can change the displayed data by changing the block number stored here.</p> <p>NOTE</p> <ul style="list-style-type: none"> • If a block number that does not exist is specified, data will not be displayed. • If in the [Mode] tab's Extended area the [Overwrite old data after finishing the specified cycles] check box is selected, this address is disabled.
Display Rows	Set the number of lines to be displayed on the screen from 1 to 50.
Display Columns	Set the number of columns to be displayed on the screen from 1 to 25.
Spacing	Select the spacing between rows and columns displayed on the screen from 0 to 10 pixels. This can only be set when the [Data Border] is set to [No Border]. When drawing a ruled line freely, draw a line within the width of the spacing so that it may not overlap the cells.

Continued

Setting	Description																																
Edit Data	<p>Specify whether or not displayed data can be edited. If this is designated, touching a displayed Date/Time or numeric value cell on the screen directly will allow you to change the value.</p> <p>NOTE</p> <ul style="list-style-type: none"> If you change the block number while editing data or move a cell being edited off the screen with a scroll switch, the value will not be changed and data edit mode will be canceled. 																																
<table border="1" style="width: 100%; border-collapse: collapse;"> <tr> <td data-bbox="150 442 385 519">Interlock</td> <td data-bbox="385 442 1264 519">When [Edit Data] is designated, select whether to use the Interlock feature (allows data editing only when a condition is satisfied).</td> </tr> <tr> <td data-bbox="150 519 385 625"> <table border="1" style="width: 100%; border-collapse: collapse;"> <tr> <td data-bbox="196 519 385 625">Enable Addresses</td> <td data-bbox="385 519 1264 625">This function only allows input when a bit designated via [Interlock Address] is in a state that has been selected via [Touch Enable Condition]. Select the check box to use Interlock.</td> </tr> <tr> <td data-bbox="196 625 385 736">Address</td> <td data-bbox="385 625 1264 736">Specify the bit address that represents an Enable condition for allowing cell touch. Touch is enabled (disabled) depending on the state of this address.</td> </tr> <tr> <td data-bbox="196 736 385 1159">Touch Enable Condition</td> <td data-bbox="385 736 1264 1159"> <p>Select the enable condition for allowing the cell touch</p> <table border="1" style="width: 100%; border-collapse: collapse; text-align: center;"> <thead> <tr> <th style="width: 33%;">Touch Enable Condition</th> <th style="width: 33%;">Address Status</th> <th style="width: 33%;">Touch Enabled/Disabled</th> </tr> </thead> <tbody> <tr> <td rowspan="2">When Bit is ON</td> <td>ON</td> <td>Touch enabled</td> </tr> <tr> <td>OFF</td> <td>Touch disabled</td> </tr> <tr> <td rowspan="2">When Bit is OFF</td> <td>ON</td> <td>Touch disabled</td> </tr> <tr> <td>OFF</td> <td>Touch enabled</td> </tr> </tbody> </table> <p>NOTE</p> <ul style="list-style-type: none"> When [Touch Enable Condition] of the interlock is disabled while editing data on the screen, the Edit Data mode will be cancelled. </td> </tr> <tr> <td data-bbox="196 1159 385 1257">Enable Security Levels</td> <td data-bbox="385 1159 1264 1257">Select to use the security function. The touch operation is enabled when logged in with a level higher than the security level set for the part.</td> </tr> <tr> <td data-bbox="196 1257 385 1298">Level</td> <td data-bbox="385 1257 1264 1298">Specify the security level of the part within the range of 1 to 15.</td> </tr> </table> </td> <td data-bbox="385 442 1264 1298"></td> </tr> <tr> <td data-bbox="105 1298 385 1373">Data Border</td> <td data-bbox="385 1298 1264 1373">Select the type of data border from [No Border], [Border], or [Border with Item Name Fields].</td> </tr> <tr> <td data-bbox="105 1373 385 1416">Clear Color</td> <td data-bbox="385 1373 1264 1416">Select a color for the portion with no text displayed.</td> </tr> <tr> <td data-bbox="105 1416 385 1622">Blink</td> <td data-bbox="385 1416 1264 1622"> <p>Select the blink and blink speed.</p> <p>NOTE</p> <ul style="list-style-type: none"> There are cases where you can and cannot set Blink depending on the Display Unit and System Settings' [Color Settings]. <p> "8.5.1 Setting Colors ■ List of Compatible Colors" (page 8-36)</p> </td> </tr> </table>	Interlock	When [Edit Data] is designated, select whether to use the Interlock feature (allows data editing only when a condition is satisfied).	<table border="1" style="width: 100%; border-collapse: collapse;"> <tr> <td data-bbox="196 519 385 625">Enable Addresses</td> <td data-bbox="385 519 1264 625">This function only allows input when a bit designated via [Interlock Address] is in a state that has been selected via [Touch Enable Condition]. Select the check box to use Interlock.</td> </tr> <tr> <td data-bbox="196 625 385 736">Address</td> <td data-bbox="385 625 1264 736">Specify the bit address that represents an Enable condition for allowing cell touch. Touch is enabled (disabled) depending on the state of this address.</td> </tr> <tr> <td data-bbox="196 736 385 1159">Touch Enable Condition</td> <td data-bbox="385 736 1264 1159"> <p>Select the enable condition for allowing the cell touch</p> <table border="1" style="width: 100%; border-collapse: collapse; text-align: center;"> <thead> <tr> <th style="width: 33%;">Touch Enable Condition</th> <th style="width: 33%;">Address Status</th> <th style="width: 33%;">Touch Enabled/Disabled</th> </tr> </thead> <tbody> <tr> <td rowspan="2">When Bit is ON</td> <td>ON</td> <td>Touch enabled</td> </tr> <tr> <td>OFF</td> <td>Touch disabled</td> </tr> <tr> <td rowspan="2">When Bit is OFF</td> <td>ON</td> <td>Touch disabled</td> </tr> <tr> <td>OFF</td> <td>Touch enabled</td> </tr> </tbody> </table> <p>NOTE</p> <ul style="list-style-type: none"> When [Touch Enable Condition] of the interlock is disabled while editing data on the screen, the Edit Data mode will be cancelled. </td> </tr> <tr> <td data-bbox="196 1159 385 1257">Enable Security Levels</td> <td data-bbox="385 1159 1264 1257">Select to use the security function. The touch operation is enabled when logged in with a level higher than the security level set for the part.</td> </tr> <tr> <td data-bbox="196 1257 385 1298">Level</td> <td data-bbox="385 1257 1264 1298">Specify the security level of the part within the range of 1 to 15.</td> </tr> </table>	Enable Addresses	This function only allows input when a bit designated via [Interlock Address] is in a state that has been selected via [Touch Enable Condition]. Select the check box to use Interlock.	Address	Specify the bit address that represents an Enable condition for allowing cell touch. Touch is enabled (disabled) depending on the state of this address.	Touch Enable Condition	<p>Select the enable condition for allowing the cell touch</p> <table border="1" style="width: 100%; border-collapse: collapse; text-align: center;"> <thead> <tr> <th style="width: 33%;">Touch Enable Condition</th> <th style="width: 33%;">Address Status</th> <th style="width: 33%;">Touch Enabled/Disabled</th> </tr> </thead> <tbody> <tr> <td rowspan="2">When Bit is ON</td> <td>ON</td> <td>Touch enabled</td> </tr> <tr> <td>OFF</td> <td>Touch disabled</td> </tr> <tr> <td rowspan="2">When Bit is OFF</td> <td>ON</td> <td>Touch disabled</td> </tr> <tr> <td>OFF</td> <td>Touch enabled</td> </tr> </tbody> </table> <p>NOTE</p> <ul style="list-style-type: none"> When [Touch Enable Condition] of the interlock is disabled while editing data on the screen, the Edit Data mode will be cancelled. 	Touch Enable Condition	Address Status	Touch Enabled/Disabled	When Bit is ON	ON	Touch enabled	OFF	Touch disabled	When Bit is OFF	ON	Touch disabled	OFF	Touch enabled	Enable Security Levels	Select to use the security function. The touch operation is enabled when logged in with a level higher than the security level set for the part.	Level	Specify the security level of the part within the range of 1 to 15.		Data Border	Select the type of data border from [No Border], [Border], or [Border with Item Name Fields].	Clear Color	Select a color for the portion with no text displayed.	Blink	<p>Select the blink and blink speed.</p> <p>NOTE</p> <ul style="list-style-type: none"> There are cases where you can and cannot set Blink depending on the Display Unit and System Settings' [Color Settings]. <p> "8.5.1 Setting Colors ■ List of Compatible Colors" (page 8-36)</p>
Interlock	When [Edit Data] is designated, select whether to use the Interlock feature (allows data editing only when a condition is satisfied).																																
<table border="1" style="width: 100%; border-collapse: collapse;"> <tr> <td data-bbox="196 519 385 625">Enable Addresses</td> <td data-bbox="385 519 1264 625">This function only allows input when a bit designated via [Interlock Address] is in a state that has been selected via [Touch Enable Condition]. Select the check box to use Interlock.</td> </tr> <tr> <td data-bbox="196 625 385 736">Address</td> <td data-bbox="385 625 1264 736">Specify the bit address that represents an Enable condition for allowing cell touch. Touch is enabled (disabled) depending on the state of this address.</td> </tr> <tr> <td data-bbox="196 736 385 1159">Touch Enable Condition</td> <td data-bbox="385 736 1264 1159"> <p>Select the enable condition for allowing the cell touch</p> <table border="1" style="width: 100%; border-collapse: collapse; text-align: center;"> <thead> <tr> <th style="width: 33%;">Touch Enable Condition</th> <th style="width: 33%;">Address Status</th> <th style="width: 33%;">Touch Enabled/Disabled</th> </tr> </thead> <tbody> <tr> <td rowspan="2">When Bit is ON</td> <td>ON</td> <td>Touch enabled</td> </tr> <tr> <td>OFF</td> <td>Touch disabled</td> </tr> <tr> <td rowspan="2">When Bit is OFF</td> <td>ON</td> <td>Touch disabled</td> </tr> <tr> <td>OFF</td> <td>Touch enabled</td> </tr> </tbody> </table> <p>NOTE</p> <ul style="list-style-type: none"> When [Touch Enable Condition] of the interlock is disabled while editing data on the screen, the Edit Data mode will be cancelled. </td> </tr> <tr> <td data-bbox="196 1159 385 1257">Enable Security Levels</td> <td data-bbox="385 1159 1264 1257">Select to use the security function. The touch operation is enabled when logged in with a level higher than the security level set for the part.</td> </tr> <tr> <td data-bbox="196 1257 385 1298">Level</td> <td data-bbox="385 1257 1264 1298">Specify the security level of the part within the range of 1 to 15.</td> </tr> </table>	Enable Addresses	This function only allows input when a bit designated via [Interlock Address] is in a state that has been selected via [Touch Enable Condition]. Select the check box to use Interlock.	Address	Specify the bit address that represents an Enable condition for allowing cell touch. Touch is enabled (disabled) depending on the state of this address.	Touch Enable Condition	<p>Select the enable condition for allowing the cell touch</p> <table border="1" style="width: 100%; border-collapse: collapse; text-align: center;"> <thead> <tr> <th style="width: 33%;">Touch Enable Condition</th> <th style="width: 33%;">Address Status</th> <th style="width: 33%;">Touch Enabled/Disabled</th> </tr> </thead> <tbody> <tr> <td rowspan="2">When Bit is ON</td> <td>ON</td> <td>Touch enabled</td> </tr> <tr> <td>OFF</td> <td>Touch disabled</td> </tr> <tr> <td rowspan="2">When Bit is OFF</td> <td>ON</td> <td>Touch disabled</td> </tr> <tr> <td>OFF</td> <td>Touch enabled</td> </tr> </tbody> </table> <p>NOTE</p> <ul style="list-style-type: none"> When [Touch Enable Condition] of the interlock is disabled while editing data on the screen, the Edit Data mode will be cancelled. 	Touch Enable Condition	Address Status	Touch Enabled/Disabled	When Bit is ON	ON	Touch enabled	OFF	Touch disabled	When Bit is OFF	ON	Touch disabled	OFF	Touch enabled	Enable Security Levels	Select to use the security function. The touch operation is enabled when logged in with a level higher than the security level set for the part.	Level	Specify the security level of the part within the range of 1 to 15.										
Enable Addresses	This function only allows input when a bit designated via [Interlock Address] is in a state that has been selected via [Touch Enable Condition]. Select the check box to use Interlock.																																
Address	Specify the bit address that represents an Enable condition for allowing cell touch. Touch is enabled (disabled) depending on the state of this address.																																
Touch Enable Condition	<p>Select the enable condition for allowing the cell touch</p> <table border="1" style="width: 100%; border-collapse: collapse; text-align: center;"> <thead> <tr> <th style="width: 33%;">Touch Enable Condition</th> <th style="width: 33%;">Address Status</th> <th style="width: 33%;">Touch Enabled/Disabled</th> </tr> </thead> <tbody> <tr> <td rowspan="2">When Bit is ON</td> <td>ON</td> <td>Touch enabled</td> </tr> <tr> <td>OFF</td> <td>Touch disabled</td> </tr> <tr> <td rowspan="2">When Bit is OFF</td> <td>ON</td> <td>Touch disabled</td> </tr> <tr> <td>OFF</td> <td>Touch enabled</td> </tr> </tbody> </table> <p>NOTE</p> <ul style="list-style-type: none"> When [Touch Enable Condition] of the interlock is disabled while editing data on the screen, the Edit Data mode will be cancelled. 	Touch Enable Condition	Address Status	Touch Enabled/Disabled	When Bit is ON	ON	Touch enabled	OFF	Touch disabled	When Bit is OFF	ON	Touch disabled	OFF	Touch enabled																			
Touch Enable Condition	Address Status	Touch Enabled/Disabled																															
When Bit is ON	ON	Touch enabled																															
	OFF	Touch disabled																															
When Bit is OFF	ON	Touch disabled																															
	OFF	Touch enabled																															
Enable Security Levels	Select to use the security function. The touch operation is enabled when logged in with a level higher than the security level set for the part.																																
Level	Specify the security level of the part within the range of 1 to 15.																																
Data Border	Select the type of data border from [No Border], [Border], or [Border with Item Name Fields].																																
Clear Color	Select a color for the portion with no text displayed.																																
Blink	<p>Select the blink and blink speed.</p> <p>NOTE</p> <ul style="list-style-type: none"> There are cases where you can and cannot set Blink depending on the Display Unit and System Settings' [Color Settings]. <p> "8.5.1 Setting Colors ■ List of Compatible Colors" (page 8-36)</p>																																

Continued

Setting	Description
Calculation Part Scroll	<p>Designate whether or not to scroll the calculation data portion together with the data portion. If this is not designated, the data calculation portion will be displayed on the screen.</p> <p>This cannot be set when [Overwrite old data when designated block count finishes] is set to the sampling data. The calculation data is not scrolled.</p>
Get Operation Log	<p>Specify whether to record the operation log. You can specify only when you select the [Edit Data] check box.</p> <p>NOTE</p> <ul style="list-style-type: none">• When [Enable Operation Log Function] is not selected in the common settings [Operation Log Settings], the message "Unable to record the operation log for individual parts" will appear. [Enable Operation Log Function] check box is selected to enable the operation log settings.

■ Display

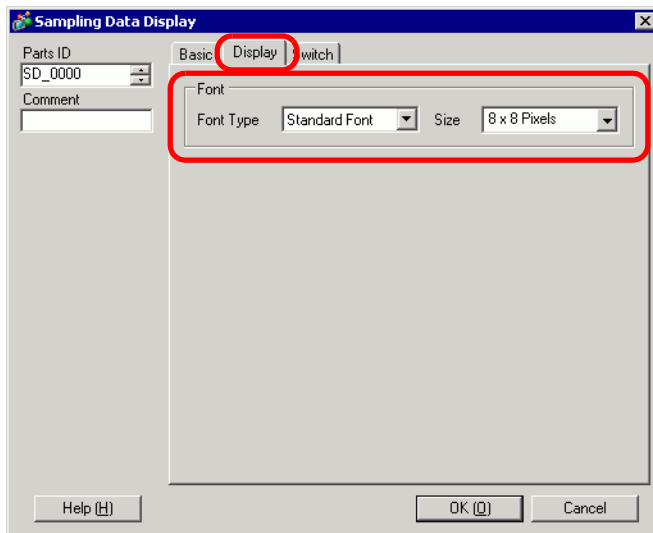

Setting	Description
Font Type	<p>Choose a font type for the characters and numeric values from [Standard Font] or [Stroke Font].</p> <ul style="list-style-type: none"> • Standard Font This is a Bitmap font. Choose the character height and width magnification ratio. When you magnify/shrink characters, the outline may become rough or the letter may appear compressed. • Stroke Font This is an outline font where the ratio of the character height/width is fixed. The letters will have a smooth outline even if you magnify/shrink them. However, this font uses more disk space on the GP.
Size	<p>Select a font size for the format of characters and numeric values.</p> <p>Standard Font: [8 x 8 pixels] to [64 x 64 pixels] in 8 dot increments. Fixed Size: select from [6x10], [8x13], or [13x23]. Stroke Font: 6 to 127 pixels</p>

■ Switch

Set the Switches to scroll the display of the Sampling Data Display.

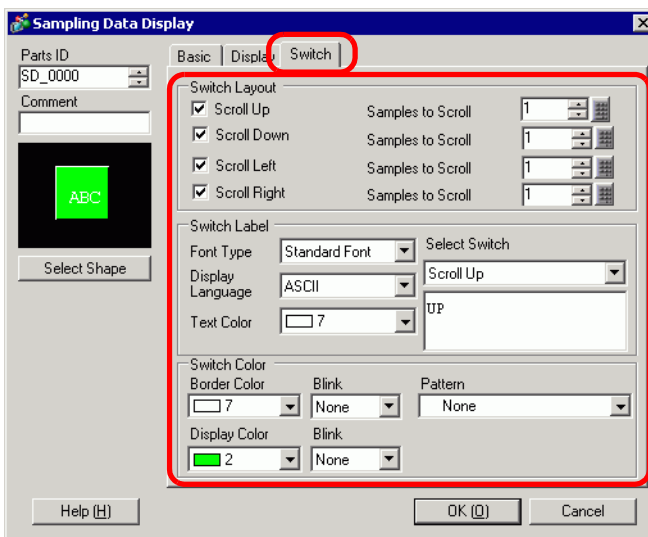

Setting		Description
Part Shape		Displays the shape that you chose for the switch with [Select Shape].
Select Shape		Open the [Select Shape] dialog box to choose the switch shape.
Switches Layout	Scroll Up/ Scroll Down/ Scroll Left/ Scroll Right	Select whether or not to place switches to scroll the display data in each direction.
	Samples to Scroll	When selecting a switch to place, set how many rows or columns it will scroll when pressed.
Switches Label	Font Type	Choose the label font for the switches from [Standard Font] or [Stroke Font].
	Display Language	Select a language for the label on the switch from [Japanese], [West], [Chinese (Traditional)], [Chinese (Simplified)], [Korean], [Cyrillic], or [Thai].
	Text Color	Select the font color that will display on the switch labels.
	Select Switch	Select a switch whose label you will set from among the placed switches.
	Label	Enter the text that you want to display on the switch selected in [Select Switch].

Continued

Setting		Description
Switches Color	Border Color	Select a color and border color for the Switch.
	Display Color	
	Pattern	Select the switch pattern from 9 types.
	Pattern Color	Select the switch pattern color.
	Blink	<p>Select whether or not the Part will blink and the blink speed. You can choose different blink settings for the [Display Color], [Pattern Color], [Border Color], and [Text Color].</p> <p>NOTE</p> <ul style="list-style-type: none"> There are cases where you can and cannot set Blink depending on the Display Unit and System Settings' [Color Settings]. <p> "8.5.1 Setting Colors ■ List of Compatible Colors" (page 8-36)</p>

NOTE

- Depending on the shape of the switch you selected in [Select Shape], [Switch Color] may not be changed.
- When you select a switch and press the [F2] key you can directly edit the text on the label.

24.9 Sampling Structure

24.9.1 Summary

Select which address data and which timing will be used for sampling. The sampled data is handled as a group based on those settings (called a "Sampling Group").

A maximum of 64 sampling groups can be set in each project. The number of groups that can be set in a system depends on the Cycles and the Addresses.

When there is only one sampling group, the maximum number of data (number of addresses) that can be sampled at one time is 512 for 16 bit length, and 256 for 32 bit length.

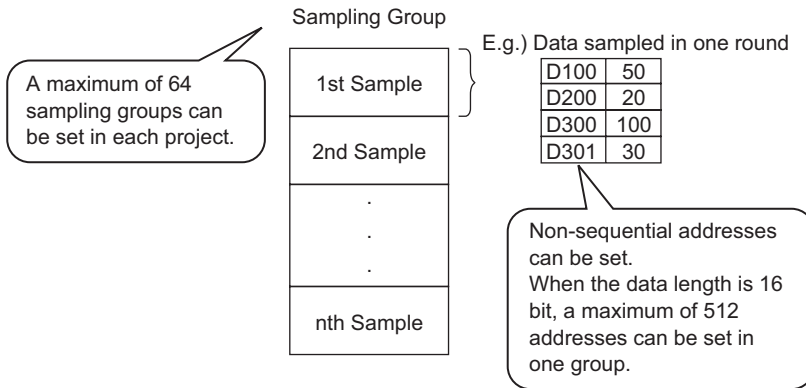

Sampled data is displayed by group unit on the GP screen, and saved to CF Card or USB storage.

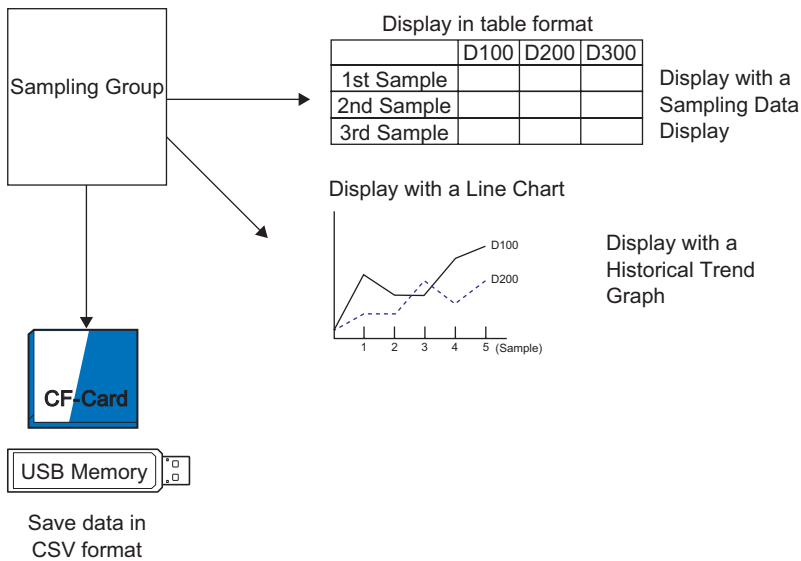

NOTE • Same structure as when you save to the USB storage device.

■ Data Sampling Flow

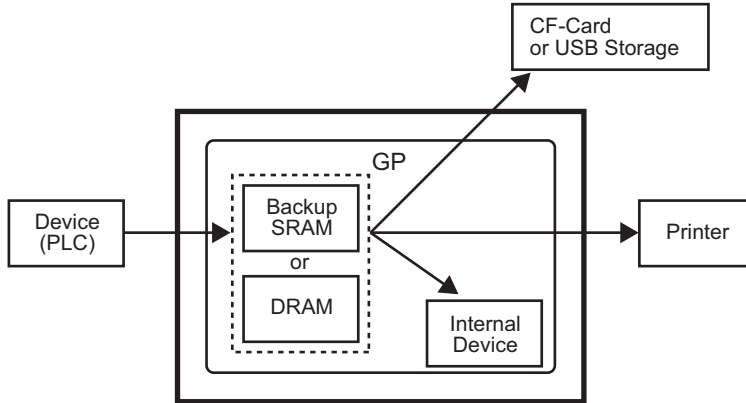

■ Backup SRAM

This memory will save data even when the GP unit is OFF.

The SRAM backup is used for operation log data, alarm history data, backup data in internal devices, filing data, and sampling data.

The amount of internal memory that sampling data can use depends on the GP model and the amount of memory used by other data.

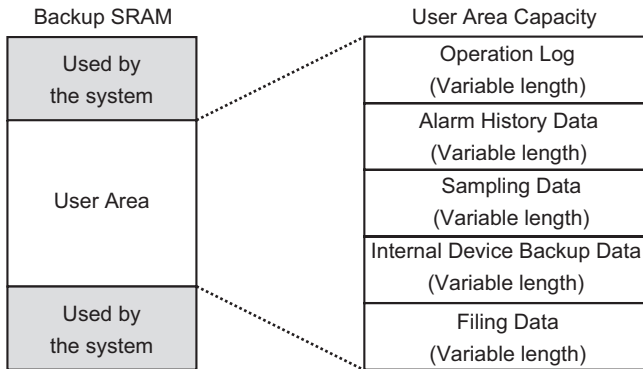

Backup SRAM has the following usage priorities:

- (1) Operation Log data
- (2) Alarm History data
- (3) Sampled data
- (4) Backup data in internal devices
- (5) Filing Data

NOTE

- The priority order within the Sampling feature goes in order of the smallest Sampling Group

IMPORTANT

- Sampling data stored in backup SRAM is erased when:
 - On Screen Transfer
 - Memory is reset (Offline)
 - Internal memory is initialized (Offline)
 - The designated [Data Clear Bit Address] turns ON

◆ **DRAM**

This memory is used for temporary storage and all data stored here will be erased when the GP is turned OFF or reset.

When you clear the [Mode] tab's [Backup to Internal Memory] check box, sampling data will be stored in this DRAM.

IMPORTANT

- Sampling data stored in DRAM is erased when:
 - GP is turned OFF
 - GP is reset
 - On Screen Transfer
 - The designated [Data Clear Bit Address] turns ON

◆ **Usage Capacity of Sampled Data**

Sampling data backup SRAM (or DRAM) usage capacity differs depending on the Number of Sampling Groups, Data Length, Number of Data (Addresses) and the contents of the action settings.

Without the sampling settings, the usage capacity is 0 bytes.

Calculation

- Usage capacity per group (in bytes)

$$20 + \text{Blocks} \times \text{Cycles}^{*2} \times \left[\frac{(\text{Number of Data} + 31)}{32} \times 4^{*3} + 2^{*5} \times \text{Number of Data}^{*1} + 12^{*4} \right]$$

- *1 When the Number of Data is an odd number, this value becomes [Data Items] (the portion in bold)+1.
- *2 When in the [Mode] tab's Extended area the [Overwrite old data after finishing the specified cycles] check box is selected, this value becomes [Cycles] + 1.
- *3 When [Add Data Valid/Invalid Flag] is selected in the action settings, this portion size (the underlined portion) is added.
- *4 When [Add Time Data] is designated in the 4 action settings, 12 bytes will be added to each sample as time data.
- *5 When the 5 data length is 16 bits equals 2 bytes; when the data length is 32 bits equals 4 bytes.

- Usage capacity for whole system (in bytes)

$$(4 + 4 \times \text{Number of Groups}) + \text{each Sampling Group's total usage capacity}$$

Calculation Example

Setting	Description
Number of Groups	1
Data Type	16 Bit
Blocks	1
Occurrences	100
Number of Data (Addresses)	7

Example 1) [Overwrite old data after finishing the specified cycles] is cleared, [Add Time Data] is cleared, [Add Data Valid/Invalid Flag] is selected

$$[\text{Calculation}] (4 + 4 \times \text{Number of Groups}) + [20 + \text{Blocks} \times (\text{Cycles} + 1) \times \{(\text{Number of Data} + 31)/32 \times 4 + 2 \times (\text{Number of Data Items} + 1)\}]$$

$$[\text{Calculation Result}] (4 + 4 \times 1) + [20 + 1 \times 100 \times \{(7 + 31)/32 \times 4 + 2 \times (7 + 1)\}] = 2103 \text{ bytes}$$

Example 2) [Overwrite old data after finishing the specified cycles] is selected, [Add Time Data] is selected, [Add Data Valid/Invalid Flag] is selected

$$[\text{Calculation}] (4 + 4 \times \text{Number of Groups}) + [20 + \text{Blocks} \times (\text{Cycles} + 1) \times \{(\text{Number of Data} + 31)/32 \times 4 + 2 \times (\text{Number of Data} + 1) + 12\}] + 42 \times (\text{Number of Data Items} + 1) + 12\}$$

$$[\text{Calculation Result}] (4 + 4 \times 1) + [20 + 1 \times (100 + 1) \times \{(7 + 31)/32 \times 4 + 2 \times (7 + 1) + 12\}] = 3260 \text{ bytes}$$

Indication of the number of sampling data you can save

Set the following high limit as an indication of the occurrences of sampling (or Occurrences x Number of Blocks) for whole system when the sampling data number at one time (Address) is one.

(The following indicates the number of sampling data you can save when you use the GP model with an SRAM capacity of 320 KB. You can set up to 65535 times the occurrences of sampling.)

Condition	Sampled Data storage area		
	Backup SRAM	DRAM	Combining Backup SRAM and DRAM
Only Sampled Data	for 81332	for 81912	for 163244
Sampled Data + Time Data	for 20332	for 20476	for 40808
Sampled Data + Data Valid/Invalid Flag	for 40664	for 40954	for 81618
Sampled Data + Time Data + Data Valid/Invalid Flag	for 16264	for 16380	for 32644

◆ **Backup Sampled Data**

You can display sampling data saved in the backup SRAM as historical data in the [Historical Trend Graph]. By backing up data in the SRAM to CF card or USB storage, you can confirm more historical data on the graph.

To back up data from the SRAM to the CF card or USB storage, a file name is automatically assigned in Bin format when data for specified times is saved in the SRAM.

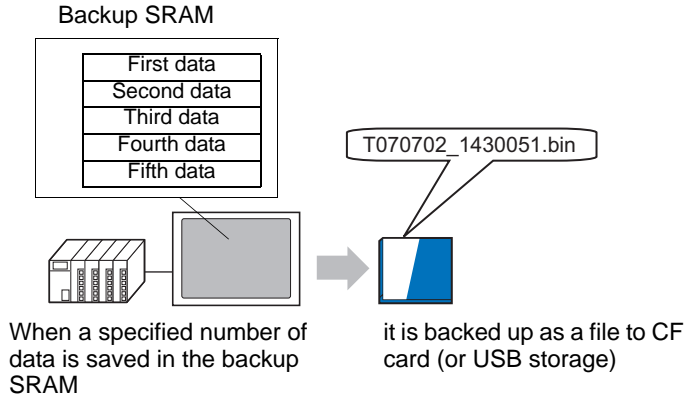

After you back up the specified [Backup Count], select whether to stop the backup or delete an old file and save new backup data.

☞ "18.9 Using a Trend Graph to View Historical Data" (page 18-32)

■ **Sampling Flow**

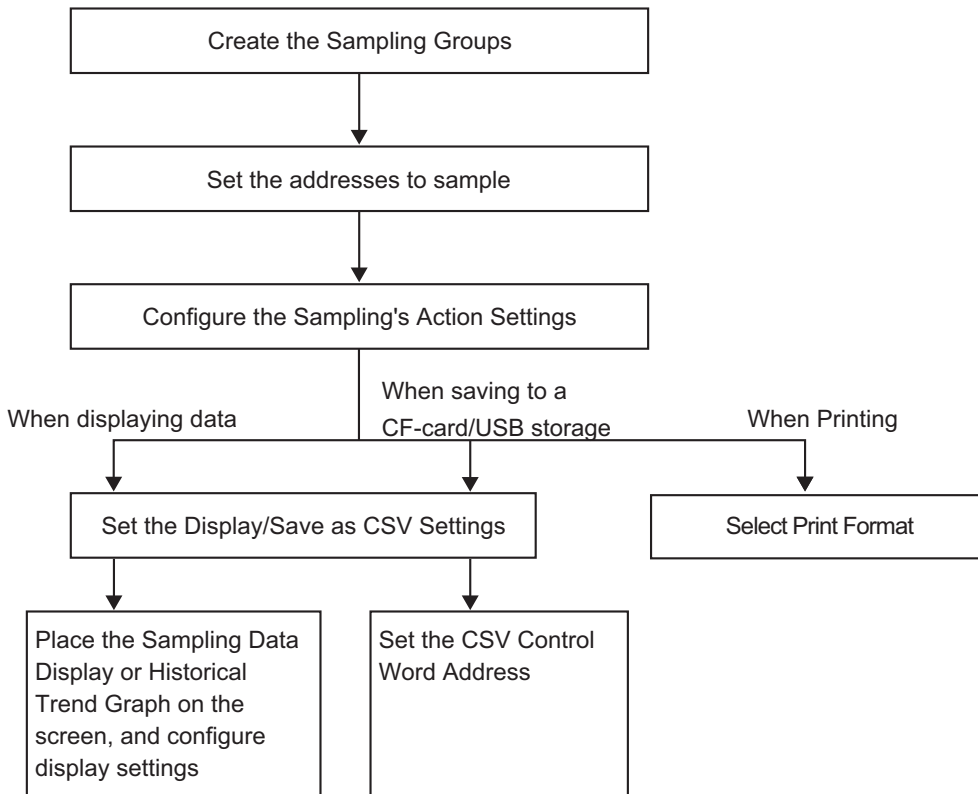

24.9.2 The Sampling Action

■ sampling

There are two methods of sampling, by time period or bit state.

The following shows the execution conditions for the Sampling, and the characteristic of each action.

Timing	Sampling Execution Condition	Attribute
Time Period	Time Specification Sampling begins at the designated time and continues for the designated period.	<ul style="list-style-type: none"> You can set the start time. Sampling cycles are set in 15 second increments. After collecting data for the specified number of times, select whether to store them by overwriting the oldest data or store them as another new block without overwriting. ^{*1}
	Constant Cycle ^{*2} Sample data at constant cycles starting from when the GP is turned ON.	<ul style="list-style-type: none"> You can set the sampling cycle 100 ms (millisecond) or 1 s (second) units. Data will be overwritten and stored, starting with the oldest data, after data has been sampled the designated number of times.
	Constant Cycle when Bit is ON ^{*2} Sample data at constant cycles starting from when the GP is turned ON, but only when the designated bit is ON.	<ul style="list-style-type: none"> You can set the sampling cycle 100 ms (millisecond) or 1 s (second) units. While the designated bit is OFF, data will not be sampled even when a cycle starts. Data will be overwritten and stored, starting with the oldest data, after data has been sampled the designated number of times.
Bit	Bit ON Data is collected every time the designated bit turns ON.	<ul style="list-style-type: none"> After collecting data for the specified number of times, select whether to store them by overwriting the oldest data or store them as another new block without overwriting. ^{*1}
	Bit Change ^{*2} Data is collected every time the designated bit changes state (ON/OFF).	<ul style="list-style-type: none"> Data will be overwritten and stored, starting with the oldest data, after data has been sampled the designated number of times.

*1 A group of sampling data over a specified number of times is called a "Block".

" ■ sampling" (page 24-128)

*2 [Constant Cycle], [Constant Cycle when Bit is ON], and [Bit Change], all the set address data is read) at the time the execution condition becomes satisfied, and stored in backup SRAM (or DRAM).

NOTE

- After the GP is powered ON and the internal programs are prepared, one second maximum of delay time may occur before the sampling starts.
 - When using [Constant Cycle], [Constant Cycle while Bit is ON], or [Bit Change], after powering up these sampling groups read in data for all the defined addresses before starting sampling operations.
 - For [Constant Cycle], [Constant Cycle when Bit is ON], and [Bit Change], because all the set address data is being read, the communication may put a burden on the system if the number of addresses to sample is large.
 - The data's display state when a communication error occurs during sampling depends on the execution condition.
 - ☞ "24.9.3 Sampling Data Display ■ If data cannot be sampled" (page 24-137)
-

◆ Time Specification

When a device/PLC [Sampling Permit Bit Address] is ON and the designated [Start Time] begins, the data from the designated addresses is read. After that, the data is read at the designated cycle.

The sampling cycle's time monitor is operated by the GP's internal clock.

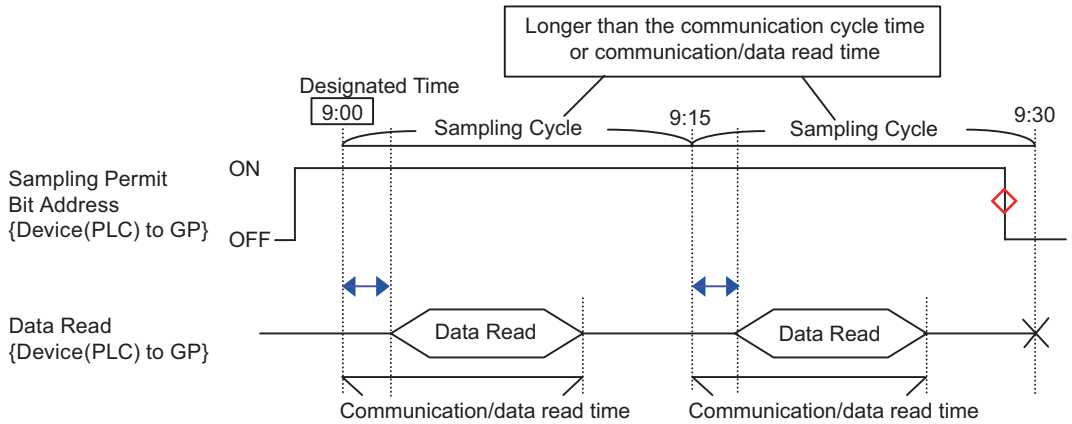

↔ =Communication time lag

◇ =Return the bit to the OFF state when action finishes (e.g. "Stop action after 9:15 sampling").

NOTE

- The above image shows the timing of the GP reading data from the designated address. It doesn't show accurate time intervals.
- Please set the [Sampling Cycle] to either the communication cycle time or the time taken to read the communication data, whichever is longer. Communication cycle time is stored in the GP internal device's (Special Relay Area) LS2037.
- Sampled data will also have the sample time added to it. The start time of the data read at the designated [Start Time] and each [Sampling Cycle] will become the "time data".

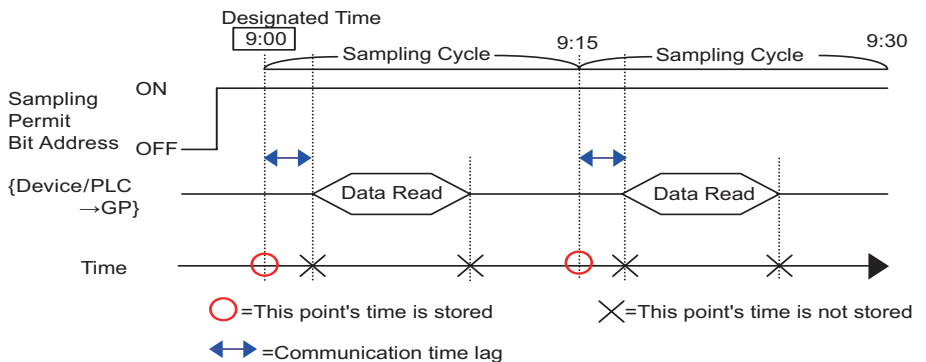

◆ **Constant Cycle**

Read data at the designated fixed cycle starting from when the GP unit is turned ON. The sampling cycle's time monitor is operated by the GP's internal clock.

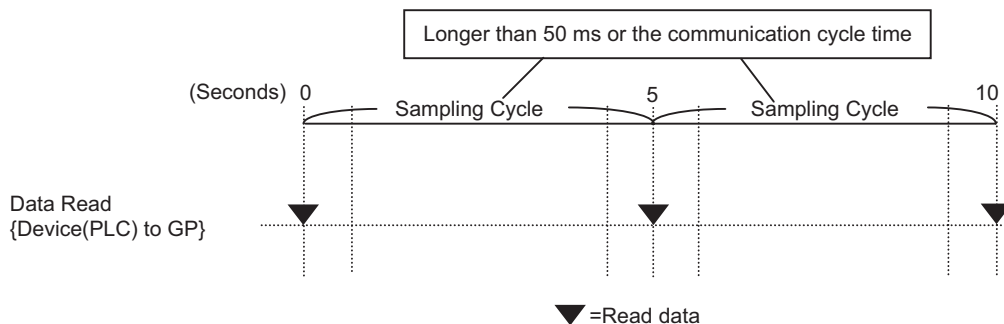

NOTE

- The image above shows the timing to read the data at the address specified by GP. It doesn't show accurate time intervals.
- When using the Direct Access method to communicate with the device/PLC, set the [Sampling Cycle] to the communication cycle time or 50 ms, whichever is longer. For the Memory Link method, set the [Sampling Cycle] to 50 ms or more. Communication cycle time is stored in the GP internal device's (Special Relay Area) LS2037.

◆ **Constant Cycle when Bit is ON**

When the device/PLC [Sampling Trigger Bit Address] is ON, data is read at the designated fixed cycle. The sampling cycle's time monitor is operated by the GP's internal clock.

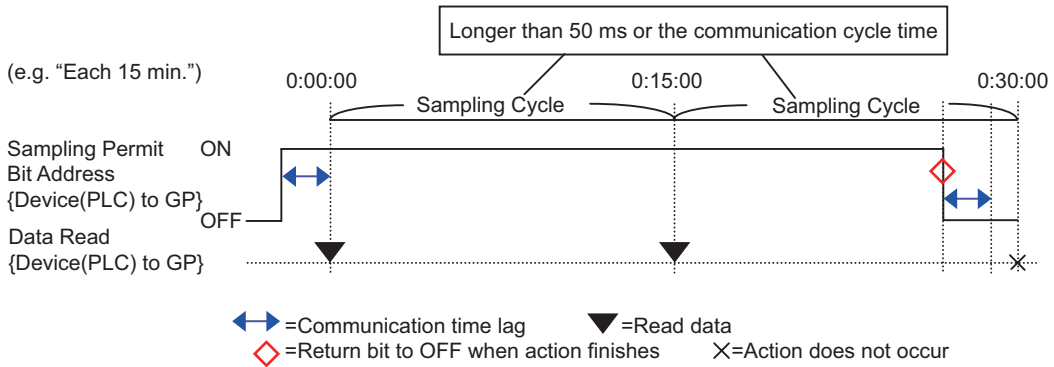

NOTE

- The image above shows the timing to read the data at the address specified by GP. It doesn't show accurate time intervals.
- The time period from when the [Sampling Permit Bit Address] turns ON to the time the sampling actually begins can be up to one second.
- When using the Direct Access method to communicate with the device/PLC, set the [Sampling Cycle] to the communication cycle time or 50 ms, whichever is longer. For the Memory Link method, set the [Sampling Cycle] to 50 ms or more. Communication cycle time is stored in the GP internal device's (Special Relay Area) LS2037.
- Please plan the action settings to take into consideration cases where the GP's power is turned OFF while an action is running. Please ensure that each Bit Address such as the [Sampling Permit Bit Address] and [Data Full Bit Address] is in the OFF state when power is turned ON.

◆ **Bit ON**

When the device/PLC [Sampling Trigger Bit Address] turns ON, the designated address data is read to the GP. When the GP finishes reading data, the [ACK Bit Address] is turned ON. When you detect that the device/PLC [ACK Bit Address] has turned ON, please turn OFF the [Sampling Trigger Bit Address]. When you turn OFF the [Sampling Trigger Bit Address], the [ACK Bit Address] will be turned OFF. When you turn OFF the [Sampling Trigger Bit Address], the [ACK Bit Address] will be automatically turned OFF.

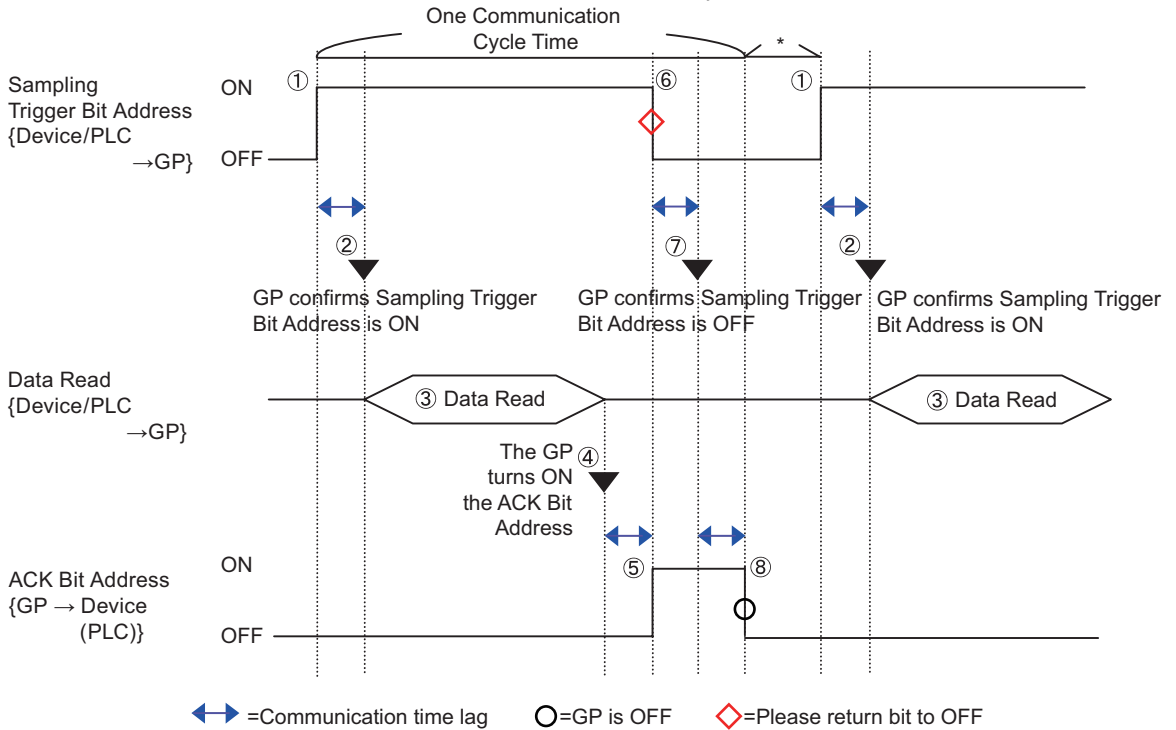

*Can be set to desired setting.

NOTE

- The image above shows the timing to read the data at the address specified by GP. It doesn't show accurate time intervals.
- Please plan the action settings to take into consideration cases where the GP's power is turned OFF while an action is running.
- Please ensure that each bit address such as the [Sampling Trigger Bit Address] and [ACK Bit Address] is in the OFF state when power is turned ON.
- When adding the acquisition time (time data) to sampling data, the time data is not the time when [Sampling Trigger Bit Address] is ON, but the time when the data reading is completed.

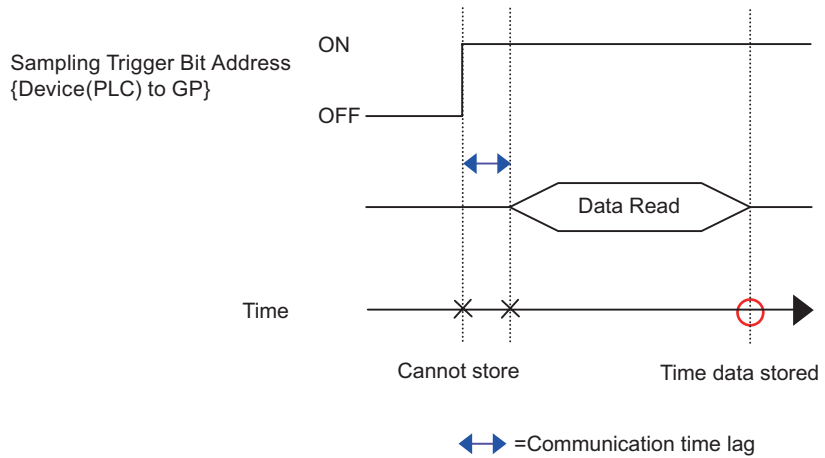

◆ **Bit Change**

When the device/PLC [Sampling Trigger Bit Address] turns ON or OFF, the designated address data is read to the GP.

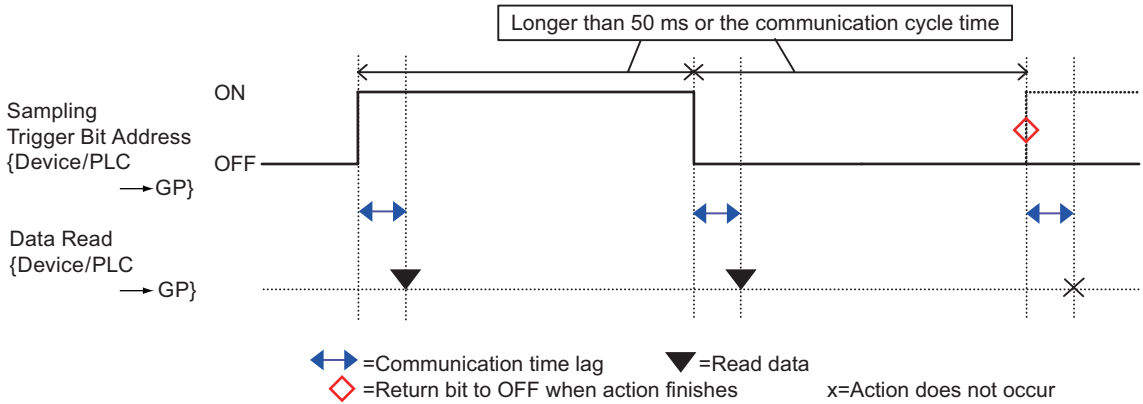

NOTE

- The image above shows the timing to read the data at the address specified by GP. It doesn't show accurate time intervals.
- Please plan the action settings to take into consideration cases where the GP's power is turned OFF while an action is running. Please ensure that each bit address such as the [Sampling Trigger Bit Address] and [Data Full Bit Address] is in the OFF state when power is turned ON.
- The [Sampling Trigger Bit Address] will not function correctly if turned OFF immediately after being turned ON. Please wait until the GP can recognize the bit state as ON or OFF. (When using the Direct Access method, the wait time should be the communication cycle time or 50 ms, whichever is longer. For the Memory Link method, 50 ms or more.)

■ **sampling**

Sampled data is stored in the GP backup SRAM (or DRAM) in Sampling Group units. Data sampled from the designated Cycles is stored with one of the following two methods.

- (1) Overwrite old data and store the latest data.
- (2) Do not overwrite data and store as a separate block.

The above storage methods are set by the [Overwrite old data after finishing the specified cycles] check box in the [Mode] tab's Extended area.

When the execution condition is [Constant Cycle], [Constant Cycle when Bit is ON], or [Bit Change], only method (1) is possible.

When the execution condition is [Time Specification] or [Bit ON], you can select method (1) or (2).

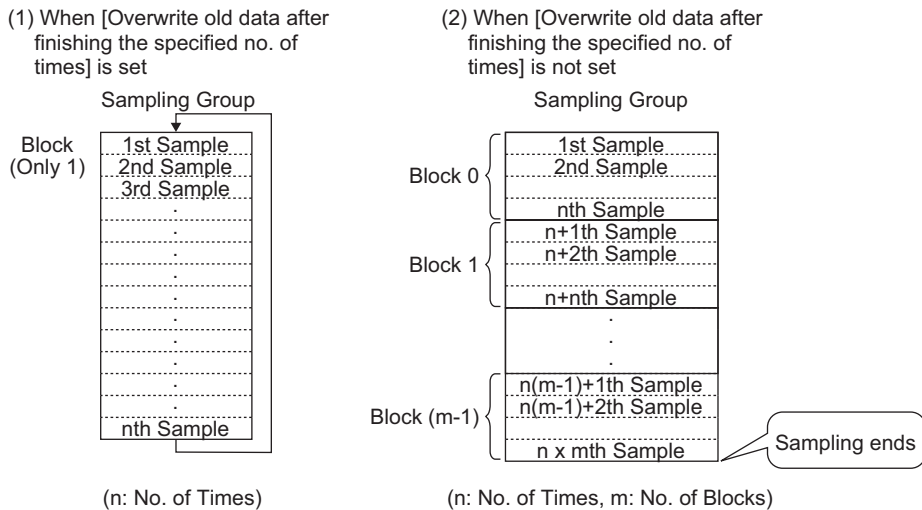

When [Overwrite old data after finishing the specified cycles] is selected

Even after data has been sampled the designated Cycles, because old data stored in the GP is overwritten with new data, sampling automatically continues.

NOTE

- After sampling for the designated Cycles finished, the [Data Full Bit Address] turns ON. This only indicates that data has been stored for one round. Sampling will automatically continue. After confirming that one round of data sampling has finished, please turn OFF the [Data Full Bit Address] so that it can detect when the next round finishes.

When [Overwrite old data after finishing the specified cycles] is cleared

After data has been sampled the designated Cycles, the next data is stored as a separate block. (A block is the sampling data collected from the designated Cycles.) Data from the designated Cycles x Blocks is stored. After that, data is not sampled.

When you store data into multiple, separate blocks, you can display and print each block. For example, if you want to sample data 10 times per day from Monday to Friday, store Monday's data in "block 0", Tuesday's data in "block 1", and so on. You can now print data for each day's information.

NOTE

- When one block finishes, the [Block Termination Bit Address] is turned ON. After you confirm that the block has finished, please turn OFF the [Block Termination Bit Address] so that it can detect when the next block finishes. Also, please confirm that the [Block Termination Bit Address] is turned OFF before sampling.
- When all data sampling finishes (Cycles x Blocks), the [Data Full Bit Address] turns ON and further sampling will not occur. To start the sampling action again, turn ON the designated [Data Clear Bit Address] and erase the stored data.

 " ■ Deleting Data" (page 24-130)

■ Deleting Data

If in the [Mode] tab's Extended area the [Overwrite old data after finishing the specified cycles] check box is cleared, sampling will not occur after data has been stored for the designated Cycles x Blocks. To start sampling again, you must delete sampling data stored in the GP.

When data has been sampled from the Cycles x Blocks, the designated [Data Full Bit Address] is turned ON. Please confirm that this bit is ON and turn ON the [Data Clear Bit Address].

(For example, Execution Condition: Time Specification)

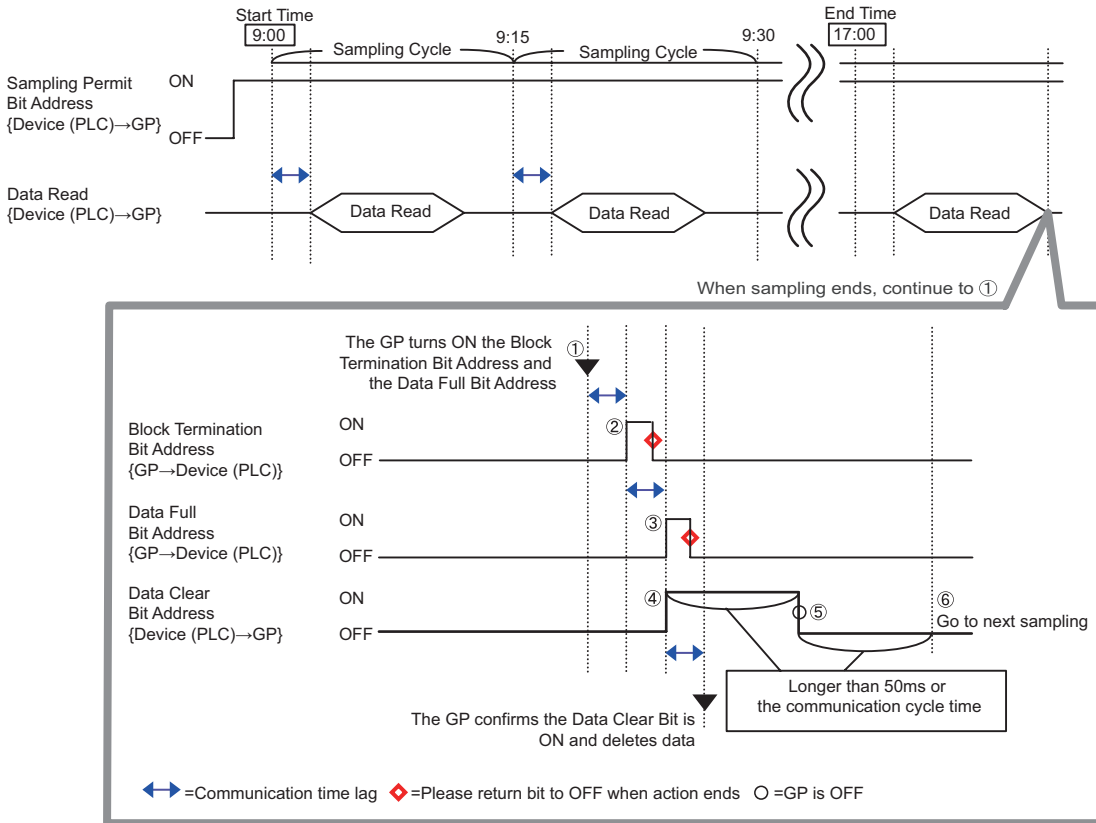

- (1) When data has been sampled from the Cycles x Blocks, the GP turns ON the [Block Termination Bit Address] and [Data Full Bit Address].
- (2) The [Block Termination Bit Address] turns ON.
- (3) The [Data Full Bit Address] turns ON.
- (4) Confirm that [Data Full Bit Address] is set to ON and set [Data Clear Bit Address] to ON. GP recognizes this and starts to delete sampling data.
- (5) When the data deletion completes, the GP automatically turns OFF the [Data Clear Bit Address].
- (6) You can now start the sampling action again. Data will be stored starting from the top (the first sample cycle in "block 0").

NOTE

- The [Data Clear Bit Address] will not function correctly if turned OFF immediately after being turned ON (or if turned ON immediately after being turned OFF). When using the Direct Access method to communicate with the device/PLC, maintain the bit's state for the communication cycle time or 50ms, whichever is longer.
-

24.9.3 Sampling Data Display

Data is displayed on a Sampling Data Display on the GP screen every time sampling occurs. When the data surpasses the designated [Display Rows], the old data will shift up and the new data will be added.

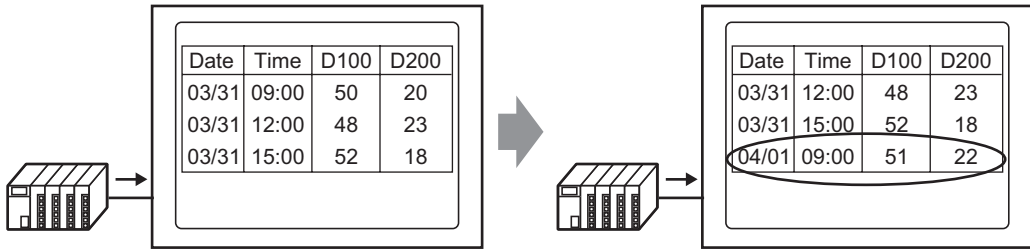

Each time data is sampled, old data is shifted up and the new data is added and displayed.

If [Overwrite old data when designated block count finishes] is not set in the Action, only the sampling data from the block number stored in the [Block Number Storage Address] will be displayed. When the last data from the block is displayed, the display will not be updated again.

To display another block's data, change the value in the [Block Completed Bit Address] and the display will change.

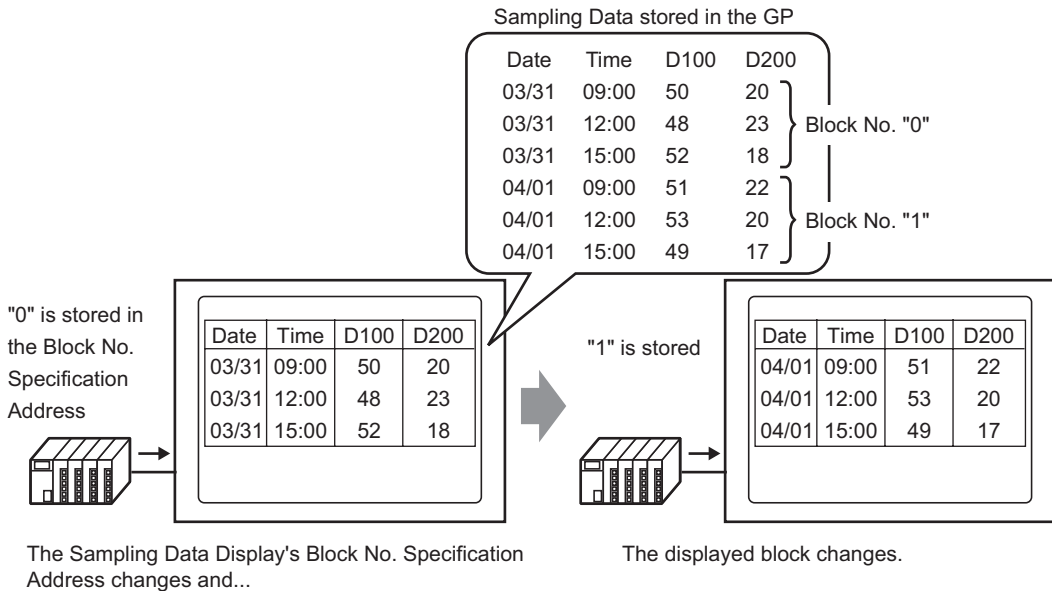

NOTE

- If a block number that does not exist is specified, data will not be displayed.

■ Display Example for Basic Settings

In the Basic Settings mode, a fixed preset format (such as the following) can be used to create a simple format.

- Data columns and Time columns are displayed sequentially line by line, then data columns for all of the Addresses set after the Date/Time are displayed.
- The 1st row displays the Item Name row. The Data columns' item names each display an address.
- When the Total row is displayed, it appears in the row after the data display rows. The item name is displayed as "Total".
- If in the [Mode] tab's Extended area the [Overwrite old data after finishing the specified cycles] check box is selected, only one data row will be displayed. If it is not checked, the data rows will equal the designated Cycles.

NOTE • The data, except Item Name in a Data column, Time column, and Data column, are displayed in the center of each cell on the Sampling Data Display.
 (For example, Display Format Settings: Number of Item Name Characters = 8, Number of Display Digits = 4, Align Right)

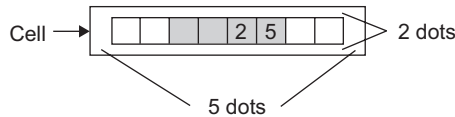

◆ When [Overwrite old data when designated block count finishes] is Set Display Format Settings

(For example, Total row = checked, Number of Item Name Characters = 8)

Date	Time	D00100	D00200	D00300	D00301
yy/mm/dd	hh:mm	****	****	****	****
Total		****	****	****	****



Sampling Data Display

(For example, Display Rows = 6, Display Columns = 7)

	Date	Time	D00100	D00200	D00300	D00301
	05/03/31	12:00	323.6	26.4	26.4	6.4
	05/03/31	15:00	324.4	28.6	27.6	6.2
	05/03/31	18:00	320.2	30.7	28.7	6.5
	05/04/01	09:00	321.0	26.9	29.9	6.3
Total			1289.2	112.6	112.6	25.4

↑ To shift the old data up, every time sampling occurs, the data display rows are shifted up and the new data is displayed.

Calculated data is the value of data calculated at the time when they are stored in GP. Overwritten data is not the target.

◆ When [Overwrite old data after finishing the specified cycles] is Cleared

Display Format Settings

(For example, Total row = checked, Number of Item Name Characters = 8)

	Date	Time	D00100	D00200	D00300	D00301
No.1	yy/mm/dd	hh:mm	****	****	****	****
No.2	yy/mm/dd	hh:mm	****	****	****	****
No.3	yy/mm/dd	hh:mm	****	****	****	****
No.4	yy/mm/dd	hh:mm	****	****	****	****
Total			*****	*****	*****	*****



Sampling Data Display

(For example, Display Rows = 6, Display Columns = 7)

	Date	Time	D00100	D00200	D00300	D00301
No.1	05/03/31	09:00	322.8	30.3	25.3	6.1
No.2	05/03/31	12:00	323.8	26.4	26.4	6.4
No.3	05/03/31	15:00	324.4	28.6	27.6	6.2
No.4	05/03/31	18:00	320.2	30.7	28.7	6.5
Total			1291.0	116.0	108.0	25.2

Only the designated block's data is displayed.

The calculation data are values calculated from data from the designated Cycles.

■ Display Example for Custom Settings

You can create a customized format with Custom Settings.

- You can set each data column's Display Range and Total Display Digits.
- You can add Date columns, Time columns, Data columns, Text columns, and Text rows.
- You can directly input text in Text columns, Text rows, and Item Name rows.
- When in the [Mode] tab's Extended area the [Overwrite old data after finishing the specified cycles] check box is cleared, you can set the calculation rows (Total, Average, Max, Min).

NOTE

- The data, except Item Name and Text in a Data column, Time column, and Data column, are displayed in the center of each cell on the Sampling Data Display.
(For example, Display Format Settings: Number of Item Name Characters = 8, Number of Display Digits = 4, Align Right)

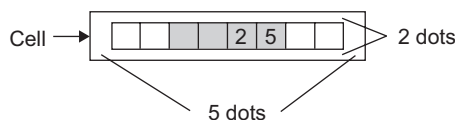

◆ When [Overwrite old data when designated block count finishes] is Set
Display Format Settings

	1	2	3	4	5	6
	Item Name (Vertical)	Data1	Time	Data2	Data3	Data4
1 Item Name (Horizontal)	Voltage	Time	Temp.1	Temp.2	Pressure	
2 Show Data	Data	xxxx	hh:mm	xx x	xx x	xx x
3 Calculation	Sum	xxxxx		xxx x	xxx x	xxx x
4 Calculation	Average	xxxx		xx x	xx x	xx x



Sampling Data Display

	Voltage	Time	Temp. 1	Temp. 2	Pressure
Data	3236	12:00	26.4	26.4	6.4
Data	3244	15:00	28.6	27.6	6.2
Data	3202	18:00	30.7	28.7	6.5
Data	3210	09:00	26.9	29.9	6.3
Sum	12692		112.6	112.6	25.4
Average	3223		28.1	28.1	6.3

↑ To shift the old data up, every time sampling occurs, the data display rows are shifted up and the new data is displayed.

Calculated data is the value of data calculated at the time when they are stored in GP. Overwritten data is not the target.

NOTE

- Text rows are not displayed even if you set them.

◆ When [Overwrite old data after finishing the specified cycles] is Cleared
 Display Format Settings

	1	2	3	4	5	6
	Item Name (Vertical)	Data1	Time	Data2	Data3	Data4
1 Item Name (Horizontal)	1	Voltage	Time	Temp.1	Temp.2	Pressure
2 No.1	1	xxxx	hh:mm	xx x	xx x	xx x
3 No.2	2	xxxx	hh:mm	xx x	xx x	xx x
4 No.3	3	xxxx	hh:mm	xx x	xx x	xx x
5 No.4	4	xxxx	hh:mm	xx x	xx x	xx x
6 Calculation	Sum	xxxxx		xxxx x	xxxx x	xx x
7 Calculation	Average	xxxx		xx x	xx x	xx x



Sampling Data Display

	Voltage	Time	Temp. 1	Temp. 2	Pressure
1	3228	09:00	30.3	25.3	6.1
2	3236	12:00	26.4	26.4	6.4
3	3244	15:00	28.6	27.6	6.2
4	3202	18:00	30.7	28.7	6.5
Sum	12910		116.0	108.0	25.2
Average	3227		29.0	27.0	6.3

The designated block's data is displayed.

The calculation data are values calculated from data from the designated Cycles.

■ **If data cannot be sampled**

If data sampling cannot occur, for example due to a communication error occurring during sampling, that round of data will be saved in CSV as follows according to the execution condition.

◆ **When the Execution Condition is [Time Specification] or [Bit ON]**

As a read error, [***] is displayed.

(For example, Execution Condition = Time Designation, Start Time = 17:00, Sampling Cycle = 30 min., Cycles = 5)

When a communication error occurs at 18:00		When the GP is turned ON after 17:30	
17:00	100	17:00	***
17:30	200	17:30	***
18:00	***	18:00	300
18:30	400	18:30	400
19:00	500	19:00	500

◆ **When the Execution Condition is [Constant Cycle], [Constant Cycle when Bit is ON], or [Bit Change]**

The read data will appear immediately before a communication error occurs.

(For example, A communication error occurred right after the second sampling round, and the error state continued until right before the third sampling round)

1st Sample	100	← Data that existed before the error is displayed
2nd Sample	200	
3rd Sample	200	
4th Sample	400	
5th Sample	500	

NOTE

- The previous sampling cycle data will remain displayed if the [Sampling Cycle] is shorter than the communication cycle time, or the communication cycle time becomes longer due to a screen change/scroll display occurring and exceeds the [Sampling Cycle], or because sampling is performed before the device/PLC data is read.
- When the [Sampling Cycle] is short (1 to 2 sec., or 100 ms), and a large process occurs such as a screen change, sampling will be omitted for a set period of time. As shown above, the previous data will also be treated as the omitted round of data.

24.9.4 About Save in CF Card/USB Storage

The sampling data saved in CF Card/USB storage (SA*****.csv) is not same as the [Display/Save in CSV] tab setting. The format is partially fixed as follows.

- Regardless of the settings, the calculation rows will not be output as CSV. Only the Item Name row and data display rows will be outputted.
- One Date column and one Time column will be displayed in a fixed position. When outputting as CSV, the Display Format is fixed as "yy/mm/dd" and "hh:mm:ss". However, when the [Sampling Cycle] is set to milliseconds in the Action, the Time column will be fixed as "hh:mm:ss.000".
- The Date/Time column item names are fixed as "Date" and "Time". In Custom Settings, the Item Name row is not set and will appear in the first row. In that case, the data column item name will be blank.
- Even if you set a Text row or Text column in the Custom Settings, they will not be outputted in the CSV file.

■ **Displays the data saved in CF Card/USB storage with Excel.**

You can edit a CSV file saved on a CF Card/USB storage device using general spreadsheet software (such as Excel) on a computer.

When a sampling data CSV file is opened in Excel

	Date	Time	D00100	D00200	D00300	D00301
Group1	2005/3/31	9:00:00	123.4	123	12.345	1234
Group2	2005/3/31	12:00:00	234.5	234	23.456	2345
Group3	2005/3/31	15:00:00	-321	-321	-32.1	-3210

- NOTE**
- If [Add Time Data] is not designated in the Action, the Date column and Time column will be blank and only the item name will be displayed.
 - In Custom Settings, if the Item Name column is not set, the far left is the Date column, the 2nd is the Time column, and the 3rd and other columns are the Data columns. The order of the data columns will follow the order set in the Custom Settings.
 - When two or more rows are set for the item row, one row will be displayed in the CSV file. A space will be appended between the items set for the first row and the second row.

◆ **Excel Display Example for Basic Settings**

The following example shows how data is saved to the CF Card with custom settings (CSV save), and how the CSV file looks in Excel.

Action

- Action: Time Specification, [Overwrite old data after finishing the specified cycles] is cleared
- Start Time:
- Sampling Cycle: 3 hours
- Cycles:
- Blocks:

Display/Save in CSV Settings

	Date	Time	[PLC1]D00100	[PLC1]D00200	[PLC1]D00300	[PLC1]D00301
No.1	mm/dd	hh:mm	*****	*****	*****	*****
No.2	mm/dd	hh:mm	*****	*****	*****	*****
No.3	mm/dd	hh:mm	*****	*****	*****	*****
No.4	mm/dd	hh:mm	*****	*****	*****	*****
Total			*****	*****	*****	*****



Excel Display

	Date	Time	D00100	D00200	D00300	D00301
No.1	2005/3/31	9:00:00	322.8	30.3	25.3	6.1
No.2	2005/3/31	12:00:00	*****	*****	*****	*****
No.3	2005/3/31	15:00:00	324.4	28.6	27.6	6.2
No.4	2005/3/31	18:00:00	320.2	30.7	28.7	6.5
No.1	2005/4/1	9:00:00	321	26.9	29.9	6.3
No.2	2005/4/1	12:00:00	323.6	26.4	26.4	6.4

When a read error occurs, [****] is displayed.

A blank row is inserted between blocks.

Date is output to the CSV file as "2005/04/01", but gets displayed as "2005/4/1" in Microsoft Excel.

The data is outputted in CSV format as "321.0". However, in Excel the final "0" after the decimal point is dropped, and "321" is displayed.

◆ **Excel Display Example for Basic Settings**

The following will introduce an example for when data is saved to the CF Card with custom settings (CSV save) and the CSV file is then opened in Excel.

- When [Overwrite old data when designated block count finishes] is set

Display/Save in CSV Settings

	1	2	3	4	5	6
	Item Name (Vertical)	Data1	Time	Data2	Data3	Data4
1 Item Name (Horizontal)		Voltage	Time	Temp.1	Temp.2	Pressure
2 Show Data	Data	xxxx	hh:mm	xx.x	xx.x	xx.x
3 Calculation	Sum	xxxx		xx.x	xx.x	xx.x
4 Calculation	Average	xxxx		xx.x	xx.x	xx.x



Excel Display

	Date	Time	Voltage	Temp1	Temp2	Pressure
Data	2005/3/31	9:00:00	3228	30.3	25.3	6.1
Data	2005/3/31	12:00:00	3236	26.4	26.4	6.4
Data	2005/3/31	15:00:00	3244	28.6	27.6	6.2
Data	2005/3/31	18:00:00	3202	30.7	28.7	6.5
Data	2005/4/1	9:00:00	3210	26.9	29.9	6.3

- When [Overwrite old data after finishing the specified cycles] is cleared

Display/Save in CSV Settings

	1	2	3	4	5	6
	Item Name (Vertical)	Data1	Time	Data2	Data3	Data4
1 Item Name (Horizontal)		Voltage	Time	Temp.1	Temp.2	Pressure
2 No.1	1	xxxx	hh:mm	xx.x	xx.x	xx.x
3 No.2	2	xxxx	hh:mm	xx.x	xx.x	xx.x
4 No.3	3	xxxx	hh:mm	xx.x	xx.x	xx.x
5 No.4	4	xxxx	hh:mm	xx.x	xx.x	xx.x
6 Calculation	Sum	xxxx		xx.x	xx.x	xx.x
7 Calculation	Average	xxxx		xx.x	xx.x	xx.x



Excel Display

	Date	Time	Voltage	Temp1	Temp2	Pressure
1	2005/3/31	9:00:00	3228	30.3	25.3	6.1
2	2005/3/31	12:00:00	3236	26.4	26.4	6.4
3	2005/3/31	15:00:00	3244	28.6	27.6	6.2
4	2005/3/31	18:00:00	3202	30.7	28.7	6.5
1	2005/4/1	9:00:00	3210	26.9	29.9	6.3

24.9.5 Printing

There are two methods for printing sampling data:

NOTE

- (Real Time Printing) prints data every time sampling occurs and (Block Unit Printing) prints data in collected groups. Use Block Unit Printing if the printers don't support paper feed per line.

Real-time Print

Data is printed each time sampling occurs.

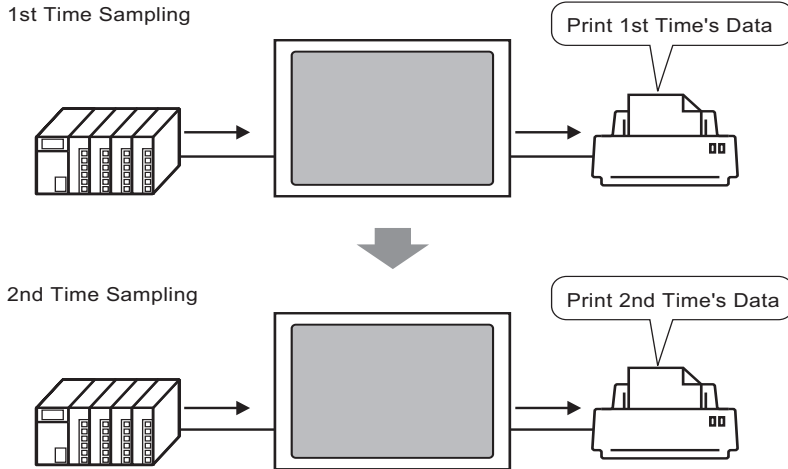

Block Unit Print

Designate the block number, turn ON bit 0 of the [Print Control Word Address], and all the data from the designated block will be outputted.

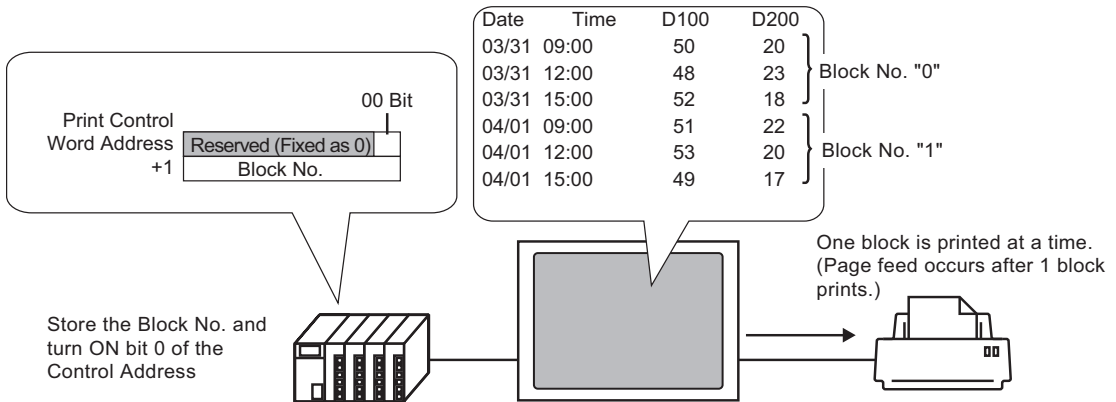

A daily report can be printed.

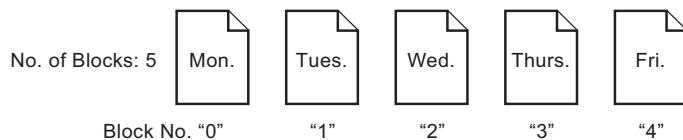

NOTE

- When in the [Mode] tab's Extended area the [Overwrite old data after finishing the specified cycles] check box is selected, only the Real Time Print option can be selected.
- Before printing data, you must connect a printer to the GP and configure the printer settings.
 ☞ "34.3.2 Printer Setup Procedure" (page 34-14)
- If [Add Time Data] is not set in the Action, the Date column and Time column will be blank.
- You cannot configure the Position Settings (Align Right/Align Left) for Date columns and Time columns. Item Names are always aligned left and data is printed in the center.

For example, Display Characters = 12

Date	Time
05/03/31	09:00
05/03/31	12:00

2 8 2 4 5 3

■ **Print Example for Basic Settings**

In the Basic Settings, a simple printing format can be created with only a few settings using the fixed preset formats.

The format is different depending on whether the [Overwrite old data after finishing the specified cycles] is selected or cleared.

◆ **When [Overwrite old data after finishing the specified cycles] is Selected (Real-time Print)**

Print Format Settings

Real-time Print

Item Name (Vertical): checked

Ruled Line: Enable

		yy/mm/dd	hh:mm	***.***	***.***	***.***	***.***	
--	--	----------	-------	---------	---------	---------	---------	--



Print Image

		05/03/31 09:00		322.8	30.3	25.3	6.1	
		05/03/31 12:00		323.6	26.4	26.4	6.4	
		05/03/31 15:00		324.4	28.6	27.6	6.2	
		05/03/31 18:00		320.2	30.7	28.7	6.5	
		05/04/01 09:00		321.0	26.9	29.9	6.3	
		05/04/01 12:00		321.9	29.2	24.0	6.0	
		05/04/01 15:00		322.7	31.1	25.1	6.3	
		05/04/01 18:00		323.5	27.3	26.3	6.1	

- All of the selected addresses data is printed.

◆ When [Overwrite old data after finishing the specified cycles] is Cleared

Print Format Settings

Print Mode: Real-time Print/Batch

Item Name (Horizontal): checked

Item Name (Vertical): checked

Total row: checked

Ruled Line: Enable

	Date	Time	D00100	D00200	D00300	D00301
No.1	yy/mm/dd	hh:mm	***.*	***.*	***.*	***.*
No.2	yy/mm/dd	hh:mm	***.*	***.*	***.*	***.*
No.3	yy/mm/dd	hh:mm	***.*	***.*	***.*	***.*
No.4	yy/mm/dd	hh:mm	***.*	***.*	***.*	***.*
Total			***.*	***.*	***.*	***.*



Print Image

	Date	Time	D00100	D00200	D00300	D00301
No. 1	05/03/31	09:00	322.8	30.3	25.3	6.1
No. 2	05/03/31	12:00	323.6	26.4	26.4	6.4
No. 3	05/03/31	15:00	324.4	28.6	27.6	6.2
No. 4	05/03/31	18:00	320.2	30.7	28.7	6.5
Total			1291.0	116.0	108.0	25.2

These values are calculated from data sampled from the designated No. of Times (1 block)

- The Item Name row is printed in the 1st row. The Date column and Time column appear as [Date] and [Time]. Each data column has an address printed as its item name.
- All of the selected addresses data is printed.
- In the Item Name column is printed the sampling round. (For example, 3rd round "Number 3")
- The Total row is printed after the data display rows.
- Regardless of whether Real-time Print or Batch is used, a form feed occurs after printing.

■ **Print Example for Custom Settings**

You can create the following type of customized format with Custom Settings.

- You can set each data column's Display Range and Total Display Digits.
- You can add Date columns, Time columns, Data columns, Text columns, and Ruled Line.
- You can directly input text in Text columns, Text rows, and Item Name rows.
- When the [Overwrite old data after finishing the specified cycles] check box is cleared, you can print the header/footer and calculation rows (Total, Average, Max, Min).

NOTE

- The maximum number of columns is 521, and the maximum number of rows 4,204.
- Text in the Text row or Text column can only be inputted in the language set in the [Sampling List] tab's [Language].

◆ **When [Overwrite old data after finishing the specified cycles] is Selected (Real-time Print)**

Print Format Settings

Print Mode: Real-time Print

	1	2	3	4	5	6	7	8	9	10	11	12			
		Time		Text		Data1		Text		Data2		Text		Data4	
1	Text	Time			D100			D200			D301				
2		+	+	+	+	+	+	+	
3	Show Data	hh:mm		Voltage	****		Temp.1	**.*		Pressure	**.*				



Print Image

	09:00		Voltage	3228		Temp. 1	30.3		Pressure	6.1	
	12:00		Voltage	3236		Temp. 1	26.4		Pressure	6.4	
	15:00		Voltage	3244		Temp. 1	28.6		Pressure	6.2	
	18:00		Voltage	3202		Temp. 1	30.7		Pressure	6.5	
	09:00		Voltage	3210		Temp. 1	26.9		Pressure	6.3	
	12:00		Voltage	3219		Temp. 1	29.2		Pressure	6.0	
	15:00		Voltage	3227		Temp. 1	31.1		Pressure	6.3	
	18:00		Voltage	3235		Temp. 1	27.3		Pressure	6.1	

NOTE

- Only the data display rows will be printed. Ruled Line rows and Text rows are not printed. When the Header/Footer is set, printing will not be performed.

◆ When [Overwrite old data after finishing the specified cycles] is Cleared

Print Format Settings

Print Mode: Real-time Print/Batch

Header is set.

	1	2	3	4	5	6	7	8	9	10	11	12
		Date	Time		Data1	Data2	Data3	Data4		Text		
1	+	+	+	+	+
2	Text	Date	Time		Voltage	Temp1	Temp2	Pressure				
3	+	+	+	+	+
4	Number1	yy/mm/dd	hh:mm								Monday	
5	Number2	yy/mm/dd	hh:mm								Monday	
6	Number3	yy/mm/dd	hh:mm								Monday	
7	Number4	yy/mm/dd	hh:mm								Monday	
8	+	+	+	+	+
9	Calculation										Total	
10	Calculation										Average	
11	Calculation										Maximum	
12	Calculation										Minimum	
13	+	+	+	+	+



(Print Image)

Ack. Examine Create						
Date	Time	Volt.	Temp. 1	Temp. 2	Pr.	
05/03/31	09:00	3228	30.3	25.3	6.1	Monday
05/03/31	12:00	3236	26.4	26.4	6.4	Monday
05/03/31	15:00	3244	28.6	27.6	6.2	Monday
05/03/31	18:00	3202	30.7	28.7	6.5	Monday
		12910	116.0	108.0	25.2	Total
		3227	29.0	27.0	6.3	Average
		3244	30.7	28.7	6.5	Max
		3202	26.4	25.3	6.1	Min

Calculation Rows

The calculation data are values calculated from data sampled from the designated No. of Times (1 block).

NOTE

- The printing format consists of the three areas: the header, the main area, and the footer.

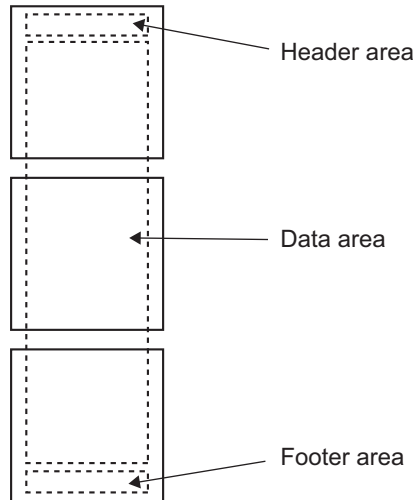

- For Real-time Print, the header area is printed when the block's initial data is printed. The calculation row(s) and the footer are printed when the block's final data is printed.
 - Regardless of whether Real-time Print or Batch is used, a form feed occurs after printing.
 - If you changed the [Occurrence] in the Action after setting the Print Format, reset the [Number of Data Display Rows] according to the number of times.
-

24.9.6 Writing to the Internal Device

By writing sampling data to the GP internal device (LS Area, USR Area), you can display one data item from among the sampled data using a Data Display or Graph Part, and use that data independently.

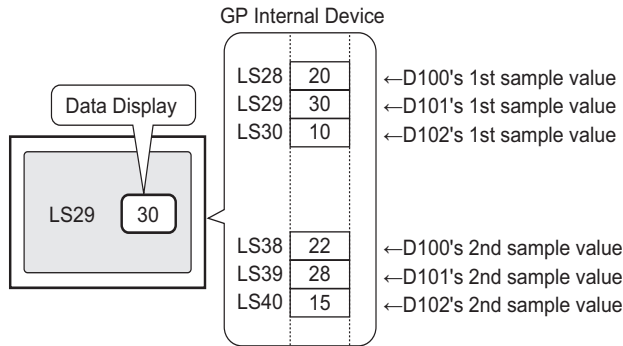

■ Writing to the Internal Device

Turn ON the designated [Write Trigger Bit Address], and sampling data stored in backup SRAM (or DRAM) is written to the internal device.

If in the [Action Setting] tab's Extended area the [Overwrite old data after finishing the specified cycles] check box is cleared, you can write each block.

Writing Sampled Data

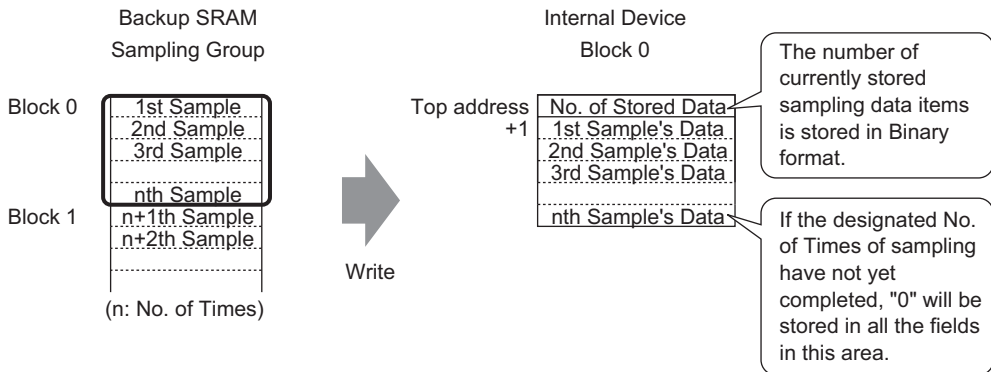

When storing sampling data to the internal device, the stored data of the current sampling round is saved in the top address in Binary format.

For example, if the Cycles is 5, and the current sampling round is 2, then [Number of Stored Data] will be "2". At that time, "0" will be stored in sampling data storage area for sample 3 and later.

NOTE

- If the [Overwrite old data after finishing the specified cycles] check box is selected, sampling data will be transferred, in order, starting with old data.

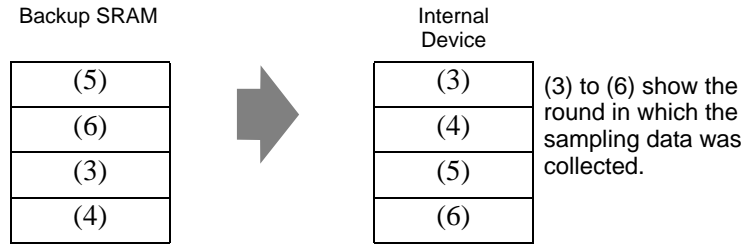

- If no block number is stored, data from block number "0" will be written.
- If you set a calculation row with the [Display/Save in CSV] tab, you can also write calculation data to the internal device. Sampling data and calculation data are written separately.
- If the size of blocks or calculation data to be written is larger than the internal device's storage area, they cannot be written.

◆ **The Structure of Sampled Data Stored in the Internal Device**

When the internal device is 16 bit

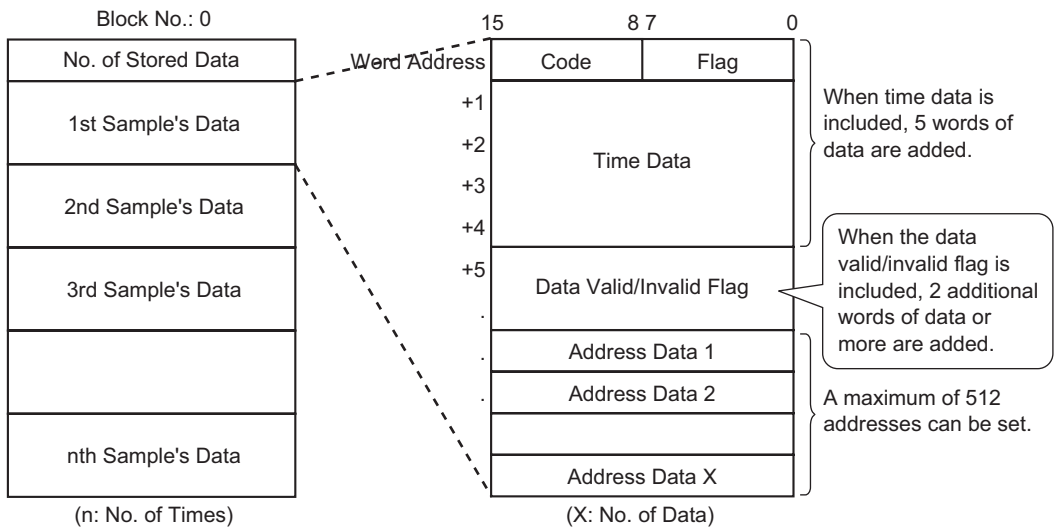

• **Code/Flag**

If the [Add Time Data] check box is selected in the [Mode] tab's Extended settings, you can monitor whether sampling is completed and whether the sampling was read normally or a read error occurred.

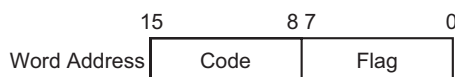

Flag

The flag's value is "1" when sampling is complete, and "0" when sampling is not occurring.

Code

The code's value is "0" when data is being read correctly, and "1" when there is a read error.

- Time Data

If the [Add Time Data] check box is selected in the [Mode] tab's Extended settings, the sample's time data is stored as in the following picture. The data is 2 digits long and saved in BCD format.

When the sampling cycle is set in seconds:

	15	8	7	0
+1			Year	
+2	Month		Day	
+3	Hour		Minute	
+4	Second			

When the sampling cycle is set in milliseconds:

	15	8	7	0
+1			Year	
+2	Month		Day	
+3	Hour		Minute	
+4	Second		Millisecond	

NOTE

- When the Execution Condition is set to [Bit ON], the Time data will represent the time when the data read completes.
- When the sampling cycle is set in milliseconds, the data will be stored in 10 ms units.

For example, March, 31, 2005 17h 30m 25s 600ms

	15	8	7	0
+1			05	
+2	03		31	
+3	17		30	
+4	25		60	

60 x 10ms

- Data Valid/Invalid Flag

The [Data Valid/Invalid Flag], which monitors whether address data is valid or invalid, is added to the sampling data if the Execution Condition is set to [Time Specification] or [Bit ON]. Valid data is marked with "1" invalid data with "0".

For example, when a read error occurs during sampling, "1" is stored in [Code], and each address's valid/invalid bit is "0". When the value of erroneous sampling data (data displayed with "****") is corrected, that data changes from invalid to valid, and the corrected address's valid/invalid bit changes from "0" to "1".

The storage area for the data valid/disabled flags fluctuates from 2 to 32 addresses.

Each address' data valid/invalid bit

	15	14	13	12	11	10	9	8	7	6	5	4	3	2	1	0
+1	16	15	14	13	12	11	10	9	8	7	6	5	4	3	2	1
+2	32	31	30	29	28	27	26	25	24	23	22	21	20	19	18	17

+32	512	511	510	509	508	507	506	505	504	503	502	501	500	499	498	497
-----	-----	-----	-----	-----	-----	-----	-----	-----	-----	-----	-----	-----	-----	-----	-----	-----

◆ The Structure of Calculated Data Stored in the Internal Device

The structure of calculation data (Total, Average, Max, Min) is set according to settings in the [Display/Save in CSV] tab and is shown in the following diagram. Bit length is 32 bit and data is stored in the internal device.

Calculated values are stored in order from the top down, starting with the left most data column designated in the [Display/Save in CSV] format.

When Total and Average are set

	1	2	3	4	5	6
	Item Name (Vertical)	Time	Data1	Data2	Data3	Data4
1	Item Name (Horizontal)	Time	Voltage	Temp.1	Temp.2	Pressure
2	No.1	hh:mm	xxxx	xx x	xx x	xx x
3	No.2	hh:mm	xxxx	xx x	xx x	xx x
4	No.3	hh:mm	xxxx	xx x	xx x	xx x
5	No.4	hh:mm	xxxx	xx x	xx x	xx x
6	Calculation	Sum	xxxx	xxx x	xxx x	xxx x
7	Calculation	Average	xxxx	xxx x	xxx x	xxx x

1st 2nd 3rd

Save in	Internal Device
Word Address +1	Data column 1's total
+2	Data column 1's average
+3	
+4	Data column 2's total
+5	Data column 2's average
+6	
+7	Data column 3's total
+8	
+9	Data column 3's average
+10	
+11	

24.10 Restrictions

24.10.1 Data Sampling Restrictions

- Up to 64 Sampling Groups can be set in the system.
- The maximum number of data item (number of addresses) that can be sampled at one time is 512 for 16 bit length, and 256 for 32 bit length.
- The number of times settings can be made in a sampling group (or Occurrences x Number of Blocks) depends on the check or non check of [Backup to Internal Memory] in the [Mode]^{*1}, the number of sampling data in one time (number of address), data length and the mode.
- Please read the following for details on the backup SRAM and DRAM, and how to calculate the sampled data capacity.
 " ■ Backup SRAM" (page 24-116)
- When you use a display unit with 320 KB of SRAM, the estimated number of samples you can save is as follows.

Only one sampling group

Specified Addresses	Data Length: 16 bit	Data Length: 32 bit
1	for 81332	for 81,332
16	for 10166	for 5,082
64	for 2540	for 1270
256	for 634	for 316
512	for 316	-

(The number provided is the estimation calculated from the backup SRAM capacity, and the actual sampling occurrence that you can set is Max 65535.)

The capacity of the backup SRAM can be confirmed by selecting the [SRAM Information] for the [Property] - [Project Information] from the [Project] menu.

- After the GP is powered ON and the internal programs are prepared, one second maximum of delay time may occur before the sampling starts.
- If a large amount of data is set to be sampled in a short cycle, then display updates and screen changes will slow down and the communication cycle time^{*2} will increase. In this case, because the next sampling occurs before reading data from the device/PLC, the previous data is treated as that round's sampling data.

*1 To store sampling data in the internal memory, select the [Backup to Internal Memory] check box in [Mode]. To store the data in the DRAM, clear the check box. You can change the storage option for each set of sampling data.

*2 The Communication Cycle Time is the time it takes from the point the GP requests data until the GP receives the data from the device. The time value is stored in the internal device LS2037 as binary data. Units are 10 milliseconds.

- For the Execution Condition - [Constant Cycle], [Constant Cycle when Bit is ON], and [Bit Change], because all the set address data is being read, the communication may put a burden on the system if the number of addresses to sample is large.
- If the Execution Condition is [Constant Cycle], or [Constant Cycle when Bit is ON], even if the [Sampling Cycle] is longer than the communication cycle time, the communication cycle time^{*2} may exceed the [Sampling Cycle], due to a screen change or scroll display. In that case, because sampling occurs before reading data from the device/PLC, the previous data is treated as that round's sampling data.
- When the [Sampling Cycle] is short (1 to 2 sec., or 100 ms), and a large process occurs such as a screen change, sampling will be unavailable for a set period of time. As shown above, the previous data will be displayed as that round's data. If [Random] is selected, it will take longer to communicate with the device than when [Sequential] is selected.
- When [Random] is selected, you cannot set a symbol variable to the address.
- When [Always] is selected for [Conditions for Read Alarm Address], the number of alert indirect address is up to 512. The upper and lower limits are a sequence of two words and one device.
An indirect address exceeding 512 is invalid, and an alarm will not be operated.
- Alarm action can be activated for the historical data.

■ To backup sampling data in SRAM

- The file name of the file (Bin format) backed up in CF card or USB storage will be a time stamp with the hour/minute/second. However, you can set the sampling cycle by 100 ms, and the file may save at the same time depending on the settings. If the file name is the same as an existing file, an error is generated and the new file will not be saved.
- When you back up sampling data to a CF card or USB drive and the save operation performs in less than 1 second, the file names in the backup file may be duplicated and are not saved properly, or sampling data is saved in multiple sampling groups and are not saved properly. This depends on the frequency of saving, which affects the increased number of sampling data.

24.10.2 Display Restrictions

- One Sampling Data Display can be placed per screen. If multiple Displays are on one screen, only the Display set first is active.
- A Sampling Data Display cannot be set to the same screen as a Special Data Display [Show CSV] or a Data Display which uses a pop-up keypad.
- The calculation operations are carried out in 32 bit length. If the calculation data has more digits (exceeds 32 bits), the calculation will not display correctly.
- When the [Overwrite old data after finishing the specified cycles] check box is selected, the calculation rows (Total, Average, Max, Min) will show the calculated value of the data housed in the GP. Overwritten data is not included in the calculations.
- In the sampling group's Address, if the [Bit Length] or [Addressing] change, the [Display/Save in CSV] format will be reset.
- When changing the [Display/Save in CSV] settings from [Custom Settings], [Basic], all customized settings will be reset.

24.10.3 Restrictions on CF Card/USB Storage Save

- Set [CSV Save Control Word Address] with no overlap among each sampling group or control word address to save on a CF Card/USB storage device. If you set overlapped, it will not operate normally and the status cannot be obtained.

System Settings [Display Unit] - [Action tab]

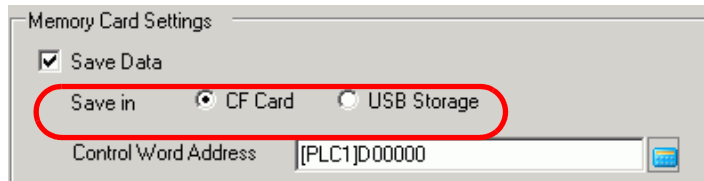

- You cannot run automatic save on multiple sampling groups at the same time.
- When you save automatically, and the sampling cycle time is short (sampling frequency is short or number of times is small), the sampling cycle may be complete while writing to the CF Card/USB storage device. If so, the sampling operation continues only after the writing process for the sampled data is complete.
- When you save automatically, do not set very short sampling cycles (sampling frequency is short or the number of times is small). This can cause increased writing of data and shortens the life of the CF Card/USB storage.
- In the sampling group's Address, if the [Bit Length] or [Addressing] change, the [Display/Save in CSV] format will be reset.
- When changing the [Display/Save in CSV] settings from [Custom Settings], [Basic], all customized settings will be reset.

■ Caution for Saving to a CF Card or USB Storage Device

- While data is written to the CF Card, changes in the display of parts and screens may slow down.
- It may take several seconds to write data, depending on the amount.
- After the Status data is read out from the GP and before the next command can be written, be sure to allow time equal to at least one communication cycle^{*1} or one Display Scan Time^{*2} period, whichever is longer.
- Do not operate a screen configured with a CF Card if the CF Card is not inserted in the GP. The screen will not work properly.
- If a write error occurs, any file that has not finished loading may remain on the CF Card.
- When overwriting a file by transferring data to the CF Card, the CF Card must have enough free room to allow the data. If the data is larger than the available space, a write error will occur.

*1 The Communication Cycle Time is the time from when the display unit requests data from the device/PLC, until the display unit receives the data. The time value is stored in the internal device LS2037 as binary data. Units are 10 milliseconds.

*2 Display Scan Time is the time required to process one screen. The time value is stored in the internal device LS2036 as binary data. Units are in milliseconds.

- When saving to the CF Card, if the target folder (\SAMP01) does not exist, a folder will be created, and the data will be saved there. However, if the CF Card cannot be initialized or the folder cannot be created, a read error will occur.
- The number of times that data can be written on a CF Card is limited. (Approximately 100,000 times for rewriting 500 KB.)
- To format the CF Card/USB storage on your PC, select FAT or FAT32. If you use NTFS for formatting, GP does not recognize the CF Card/USB storage.
- Do not connect more than one USB storage device. If you do so, the USB devices may not be recognized properly.

■ CF Card Cautions for Use

- When ejecting a CF Card, make sure that the CF Card access LED lamp turns OFF. Otherwise, the data on the CF Card may be damaged.
- When accessing a CF Card, be sure not to power OFF or reset the GP, or eject the CF Card. Create an application screen on which the CF Card cannot be accessed, and on that application screen, you may power OFF or reset the GP, open and close the CF Card cover, and eject the CF Card.
- When inserting a CF Card, check the front and back sides and the connector position of the card. If the CF Card is inserted the wrong way, the data, the CF Card, or the GP may be damaged.
- Use a CF Card manufactured by Digital Electronics Corporation. If a CF Card manufactured by another company is used, the contents of the CF Card may be damaged.
- Please make sure to back up all CF Card data.
- Please refrain from doing the following, as it can result in damage to data and equipment:
 - Bending the CF Card
 - Dropping the CF Card
 - Spilling water on the card
 - Touching the CF Card's connectors directly
 - Disassembling or modifying the CF Card

■ USB Storage Cautions for Use

- While accessing the USB device, do not reset the display unit or remove the USB storage device. Data on the USB storage device may become corrupted.
To remove the USB storage device safely, design the system to remove the device only after turning ON system variable #H_Control_USBDetachTrigger and after confirming #H_Status_USBUsing is OFF.
 "A.6.2 HMI system variables (#H system variables) n Bit type" (page A-107)
- Please make sure to backup the data on the USB storage device.

24.10.4 Restrictions on Printing

- Up to 160 single-byte characters can be printed in a single line.
- You cannot designate the size of the characters to print.
- When printing sampling data, any portion wider than A4 will not be printed. The number of characters that can be printed on one line depends on the printer.
- Regardless of the printer color settings (monochrome/color), all data is printed in black and white.
- When the sampling group font type is set to [Stroke Font] and the language is set to [Standard Font] of [Chinese (Traditional)], [Chinese (Simplified)], or [Korean], text will be printed out as image data, and it may take some time to print.
- DO NOT enter other printing commands during real-time printing. If an Alarm History printing command occurs during real-time printing, the alarm history and other data will be mixed together during printing.
- (Real Time Printing) prints data every time sampling occurs and (Block Unit Printing) prints data in collected groups. Use Block Unit Printing if the printers don't support paper feed per line.
- If sampling data is deleted during printing, printing will not continue. If the GP is turned OFF during printing, jobs in the queue are lost.
- The calculation operations are carried out in 32 bit length. If the calculation data has more digits (exceeds 32 bits), the correct value will not be printed.
- If sampling data changes when the [Overwrite old data after finishing the specified number of times] check box is selected, the printing speed can be slower than the data overwrite and store speed if the [Number of Times] is small or a short Sampling Cycle is being used. When sampling data is overwritten before printing, the data prior to the overwrite cannot be printed.
- In the sampling group's Address, if the [Bit Length] or [Addressing] change, the print format will be reset.
- When changing the print mode between [Custom Settings], [Basic], all customized settings will be reset.
- When using Custom Settings, the maximum number of columns that can be set with the print format is 521 columns. The maximum number of rows is 4204. The maximum number of columns is the total of the Date, Time, Data, Text, and Ruled Line columns. Calculation rows and the header/footer areas are not included.

