

36



Display or Operate a Computer from the GP

This section reviews how to remotely access a server computer from a display unit. First, read the general overview about this feature in "36.1 Action Environment" (page 36-2), then go to "36.2 Settings Menu" (page 36-3) to find explanations of individual features.

36.1	Action Environment	36-2
36.2	Settings Menu	36-3
36.3	Display or Operate a Computer from the GP	36-4
36.4	Settings Guide.....	36-21
36.5	Restrictions	36-29

36.1 Action Environment

36.1.1 Summary

■ Remote PC Access (RPA)

Remote PC Access (RPA) displays server computer data on the display unit using UltraVNC. With the Remote PC Access Display, you can view Microsoft Excel and PDF documents from the server computer on the display unit. You can also work with the mouse or keyboard on the server from the display unit. Remote PC Access is well-suited for computer maintenance and for viewing documents saved on the server computer.

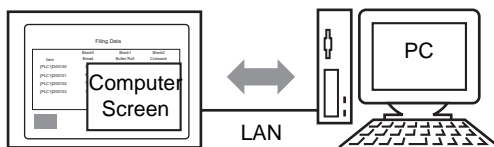

IMPORTANT

- Before using this feature, purchase the Remote PC Access key code (Type: EX-RPA) and provide the code for each display unit that uses Remote PC Access.
- The key code cannot be reissued if you lose it. Please keep it at hand.
- For more information on key code input, see ["36.3.2 Setup Procedure ■ Detailed Procedure" \(page 36-7\)](#)
- You can use this feature when the GP is connected to the computer by a LAN port.

NOTE

- Only some models can use RPA features. ["1.3 Supported Features" \(page 1-5\)](#)

36.1.2 VNC Server

To use the RPA feature, you must first install UltraVNC (Version 1.0.2) on the server computer.

UltraVNC (Version 1.0.2) is in the following folder on the install CD.

\RPA\UltraVNC\UltraVNC-102-Setup.exe (Ultra VNC set up file)

IMPORTANT

- Other VNC software will not function properly. UltraVNC (Version 1.02) has been confirmed to run correctly.
- UltraVNC (Version 1.02) has been confirmed to run correctly. However, there is no guarantee that the application can run in all environments and setups. Before using this tool, make sure you test the application.

36.2 Settings Menu

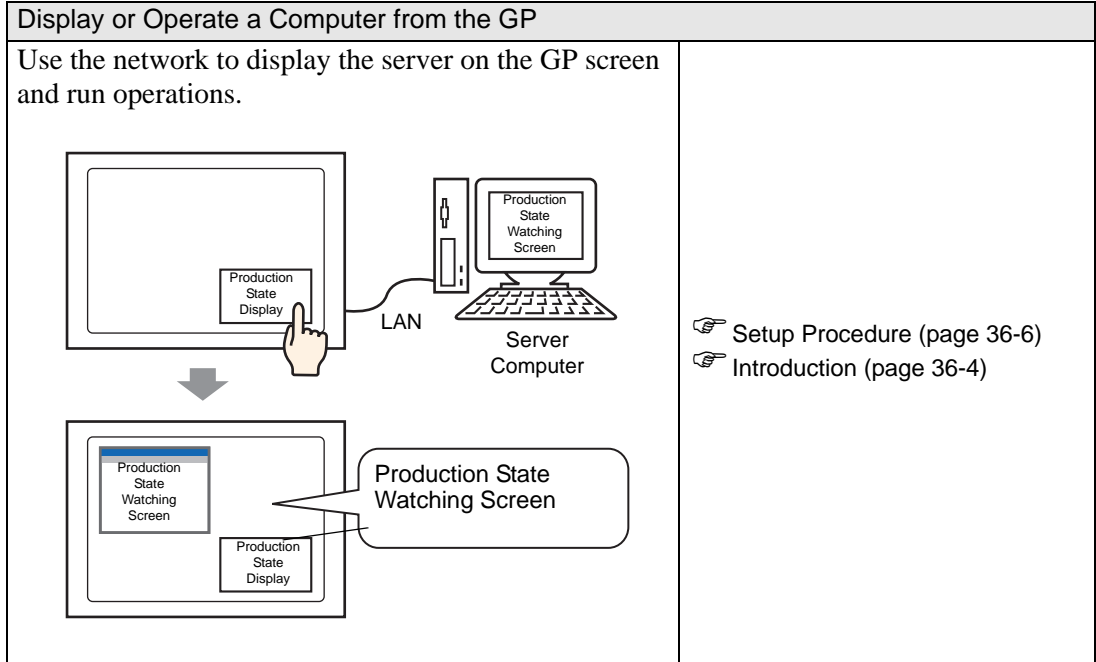

36.3 Display or Operate a Computer from the GP

36.3.1 Introduction

When you connect a server computer and display unit, you can view files such as Microsoft Excel and PDFs using the RPA Display feature.

At the production site, you can display an Excel file that lists production values, PDF files used to illustrate operation procedures, or PDF manuals.

For example, the show window displays the Excel screen of a desired production state when you touch the "Production State Display" switch.

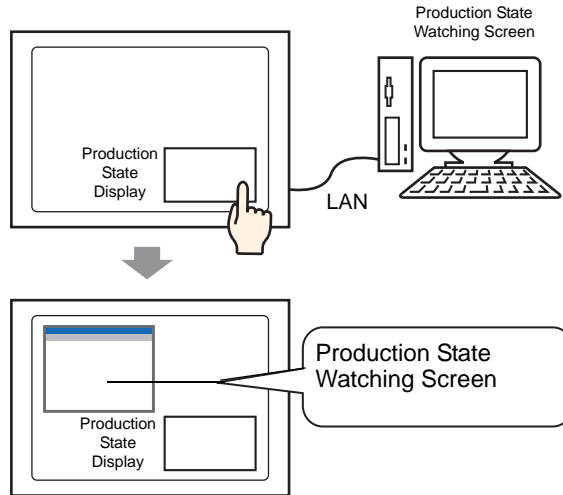

IMPORTANT

- Before using this feature, purchase a Remote PC Access key code (Type: EX-RPA) for each display that will use remote PC access.
- The key code cannot be reissued if you lose it. Please keep it at hand.
- For more information on key code input, see ["36.3.2 Setup Procedure ■ Detailed Procedure"](#) (page 36-7)
- If you open a project file created in a previous version and set up with the Remote Access Key Code, a message prompting for key code registration appears in the display unit's offline screen. Register the Remote PC Access Key Code from offline mode.

NOTE

- When you display the popup keypad for the RPA function on the display unit, you can operate the server computer screen with the touch display.

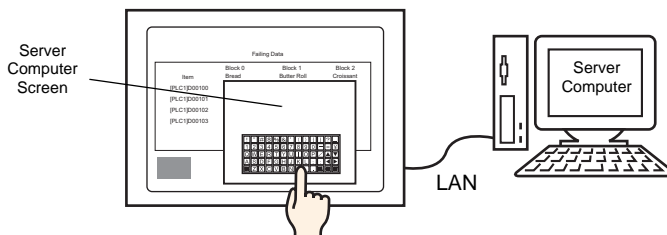

- On the display unit, you can operate the server computer screen if you connect the mouse and keypad registration to the USB port of the unit.

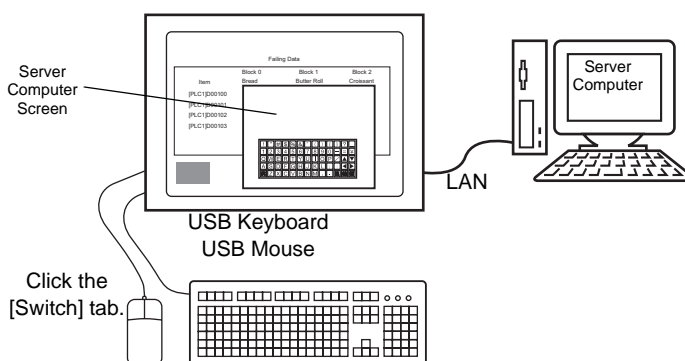

This supports Japanese type 106 keypad registration or English type 101 keypad registration.

- When you use Windows Server 2003, you can log in from multiple displays to one server computer.
 ☞ "36.3.2 Setup Procedure ■ Log in from Multiple Display Units" (page 36-14)

36.3.2 Setup Procedure

NOTE

- Please refer to the Settings Guide for details.
 - ☞ "36.4.1 Remote PC Access Window Display Settings Guide" (page 36-21)
 - ☞ "5.17.6 [System Settings] Setting Guide ◆ Extended Settings" (page 5-176)
 - Browse "Editing procedure for parts" for parts placement and details on settings for address, shape, color, and label.
 - ☞ "8.6.1 Editing Parts" (page 8-44)
-

■ Necessary Device

- Display Unit. (See "1.3 Supported Features" (page 1-5) for supported models.)
- GP-Pro EX (Ver2.00 or later)
- Key code for RPA (Our available product. Type: EX-RPA)
- Server computer on which Ultra VNC has been installed
- LAN cable and HUB (Commercial product)

■ Procedure Outline

- 1 Set up the server computer.
- 2 Enter the key code in the display unit's offline mode.
- 3 Connect the display unit and server computer over the LAN.
- 4 Set up the remote PC access window display on the base screen.
- 5 Set up the switch to display the RPA window.

■ Detailed Procedure

1 Set up the server computer.

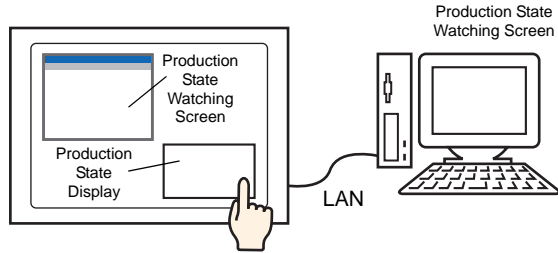

Install the following software on the server computer.

	Ultra VNC
Access Method	Included in the folder in the install CD. \\RPA\UltraVNC\UltraVNC-102-Setup.exe (Ultra VNC set up file)
Install Procedure	http://www.uvnc.com/install/installation.html (English)
License	http://www.uvnc.com/general/index.html
Supported OS	http://www.uvnc.com/
Connection Configuration	You can connect up to eight server computers to a display unit. However, you cannot connect multiple display units to one server computer. Please connect display units one at a time.

IMPORTANT

- This software was developed by the Ultra VNC TEAM. UltraVNC (Version 1.02) has been confirmed to run correctly. However, there is no guarantee that the application can run in all environments and setups. Before using this tool, make sure you test the application.

NOTE

- When using Windows Server 2003 on the server, in addition to Ultra VNC, you can also purchase and install a terminal server.
☞ 36.3.2 Setup Procedure ■ Log in from Multiple Display Units 36-14

2 Starts the Ultra VNC Server application.

3 In [Authentication], under [Win VNC Current User Properties] set the [VNC Password] up to a maximum of 30 single-byte characters.
 Define other settings as required.

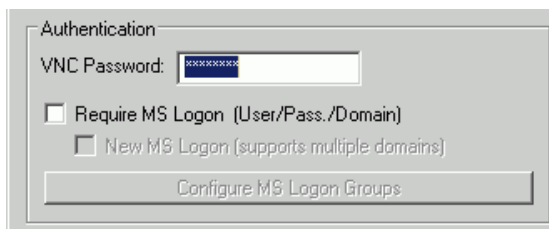

IMPORTANT

- Disable the Video Hook Driver settings. The mouse cursor may not display. Procedure
Right-click the UltraVNC icon in the task tray and select [Properties]. The following [Win VNC: Current User Properties] dialog box appears. Clear the [Video Hook Driver] check box.

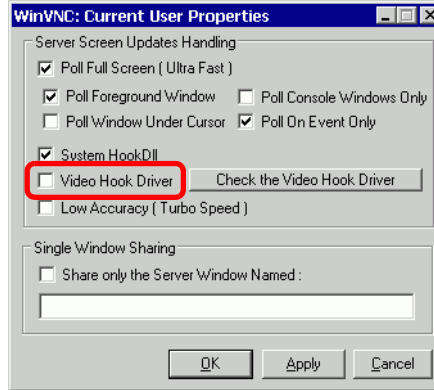

- On the server computer, select [Screen Properties], point to [Settings], and click [Screen Color (C)] and select at least 16-bit color. Other color settings will prevent the display unit from connecting.

4 Move to the display unit's offline mode.

To display the GP system menu, touch the top-right corner and the bottom-left corner of the GP screen (or top-left corner and bottom-right corner) within 0.5 seconds of each touch.

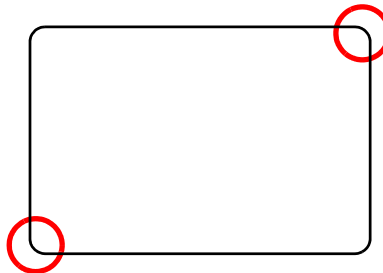

5 Touch [Offline].



NOTE

- To move directly to offline mode when you start up the GP, after the initial screen displays, immediately touch and hold the top right corner (or top left corner) for more than three seconds.

6 Select [Main Unit Settings] and then select [Extended Settings]. Touch the key code input area of [PRA Function Key Code] and enter the key code. Touch [OK] to set up the input.

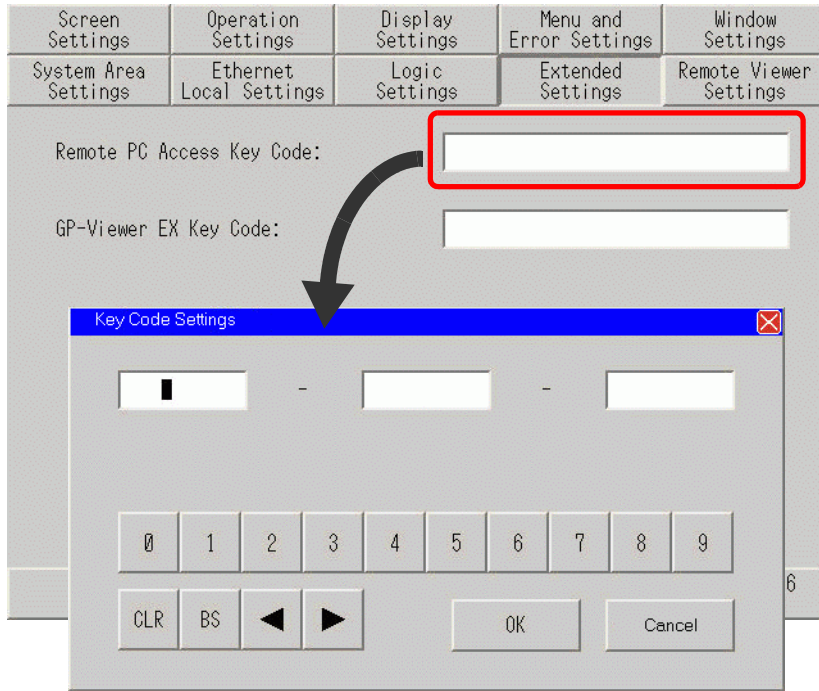

Touch [End] to return to [Main Unit Settings].

IMPORTANT

- The key code cannot be reissued if you lose it. Please keep it at hand.

NOTE

- 1st entered keycode is saved. Unnecessary to input keycode for the second time.

7 Select [Save] and point to [End] on the Display Unit screen to move offline.

8 Connect the display unit and server computer via the LAN.

NOTE

- On the server PC, set up the [Default Gateway]. Without this set up, the display unit's connection to the server PC might fail.

9 Open a Base Screen, and from the [Parts (P)] menu select [Remote PC Access Window Display (I)], or click  to place the Remote PC Access Window Display.

10 Double-click the allocated remote PC access window display to open the Settings dialog box.

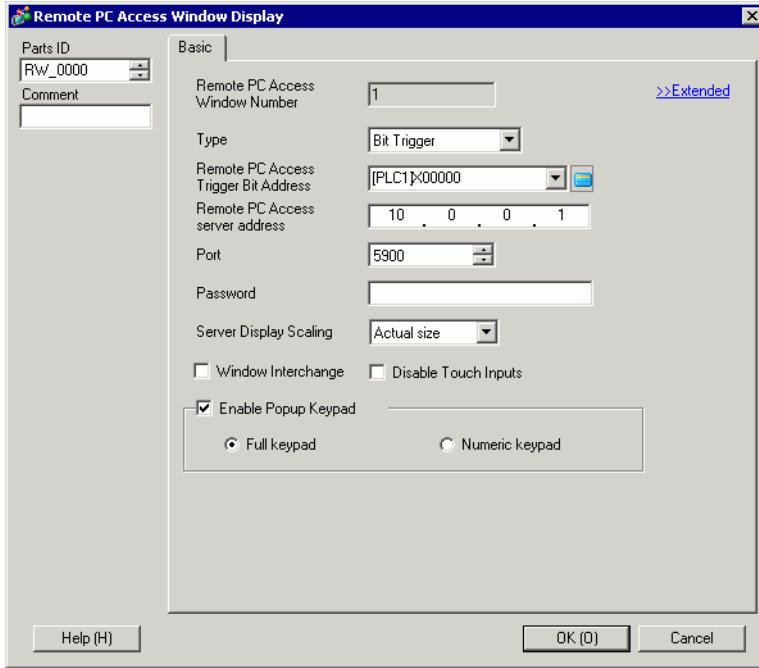

11 From [Type], select either [Bit Trigger] or [Activate Switch]. (For example, switch)

12 Enter the IP address and port number of the server computer connected to the [Remote PC Access Server Address] and [Port Number], respectively.
For example, IP Address 192.168.0.1, Port Number 5900

13 In [Password], enter a password up to a maximum of 30 characters. For example, "remote"

- NOTE**
- You must enter the same password in [Remote PC Access Window Display] as the [VNC Password], defined in the [Win VNC Current User Properties] dialog box. This dialog box displays when the server PC's Ultra VNC Server starts up.

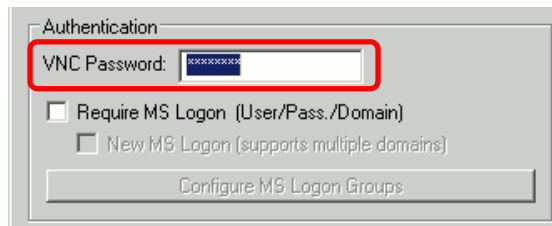

When the Remote PC Access window displays on the GP, password authentication is performed on both the server PC and GP. If the password is authenticated, you are connected automatically and future password inputs on the GP are not required.

14 Select the server display screen size in [Server Display Scaling].

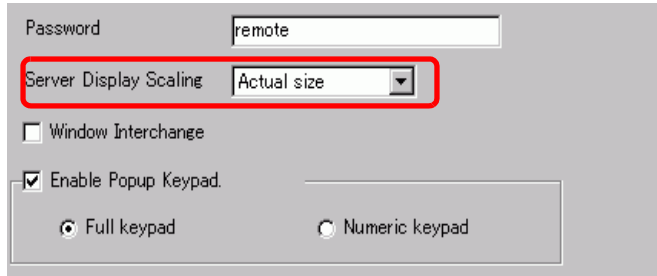

15 Select the [Enable Popup Keypad] check box and select the type of keypad from [Full Keypad] or [Numeric keypad].

NOTE

- Refer to the following setup to operate the mouse or keypad connected to the display unit. For more details, please refer to the following.
 - ☞ "36.4.2 System Settings [Input Equipment Settings] - [Remote PC Access Input] Settings Guide" (page 36-27)
- Operating the mouse or keypad connected to the USB port on the display unit can occur only when the Remote PC Access Window is displayed. In such a scenario, there is no need to pop up a keypad.

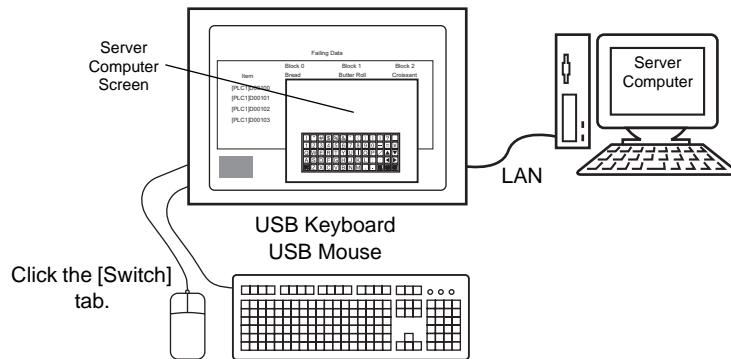

- 16 Select the [Use Remote PC Access Window Switch] check box. Set each item on [Switch Label] and [Switch Color] as necessary. For example, Production State Watching Screen

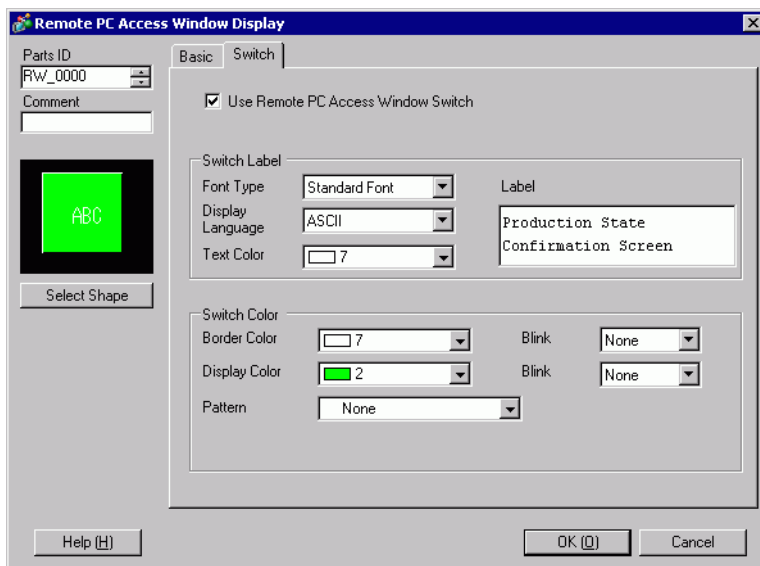

NOTE

- Only the [Switch] tab displays when [Activate Switch] is selected as the [Type]. In case of a bit trigger, designate the ON switch for the bit by [Remote PC Access Bit Address], D-Script, Logic Program etc.



- Depending on the shape, you may not be able to change the color.
- When you select a switch and press the [F2] key you can directly edit the text on the label.
- You can set this switch by [Special Switch] for switch parts and [RPA Window Display Switch].
 ☞ "10.15.4 Special Switch" (page 10-70)

17 Click [OK].

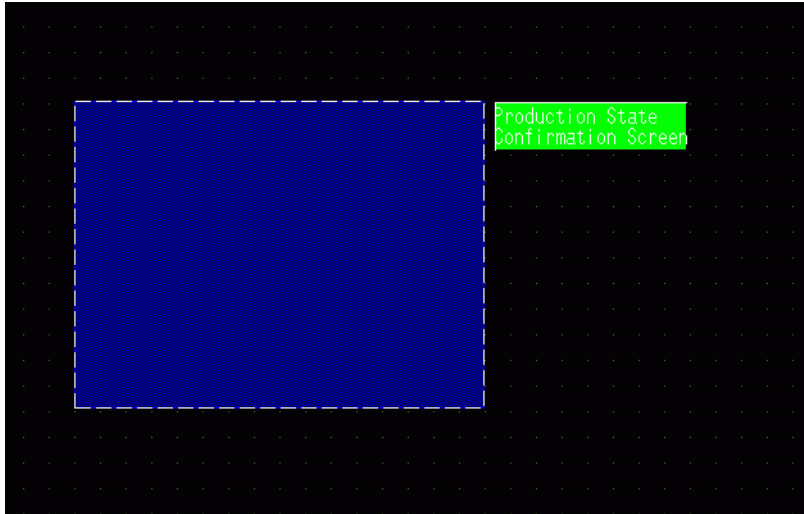

18 Transfer the system settings.

◆ Method for Moving the Popup Keypad

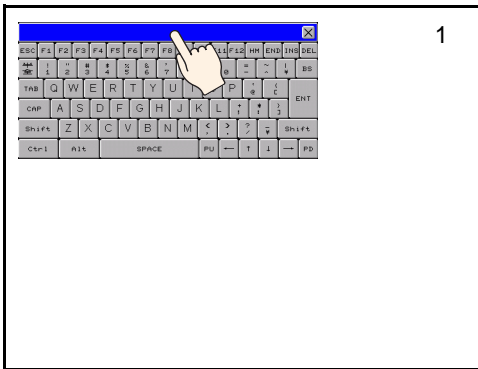

- 1 Touch the upper part of the popup keypad.
- 2 Touch the desired position on the screen where you want the display to move.
- 3 The popup keypad displays in the position that was touched.

NOTE

- If the popup keypad is larger than the specified position allows, the keypad is adjusted to a position where it can appear.

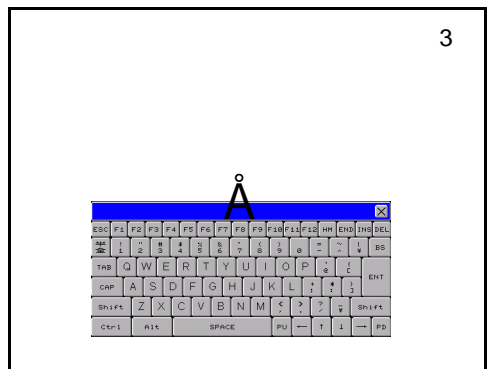
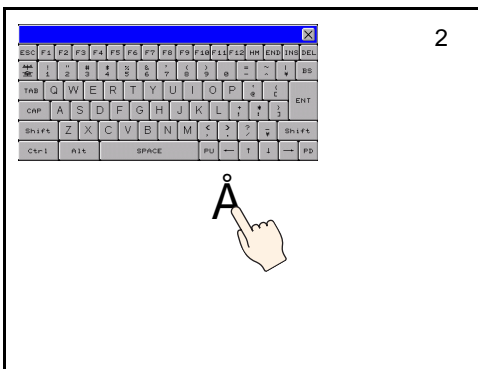

■ Log in from Multiple Display Units

When you use Windows Server 2003 as the server computer, you can use it as a terminal server and allow users to log in from multiple display units.

◆ Setup Procedure

Terminal Server Setup

NOTE

- To perform the steps listed below, your environment must have an Internet connection available.

- 1 From the task bar click [Start], point to [Setup] and click [Control Panel]. Double-click [Add and Remove Programs] and in the Add or Remove Programs dialog box click [Add/Remove Windows Components]. Select the [Terminal Server] and [Terminal Server License] check boxes, and click [Next].

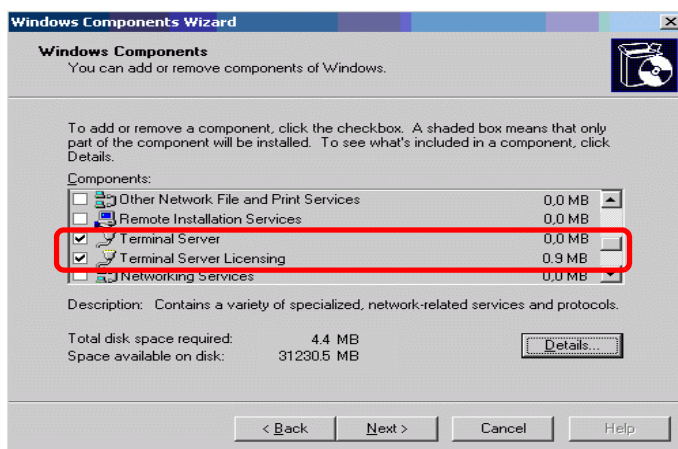

Installation starts.

- 2 When installation is complete, the [Terminal Server License] appears and the program starts.

In the following dialog box, select a server name to register, right-click the menu and then select [Server Activation].

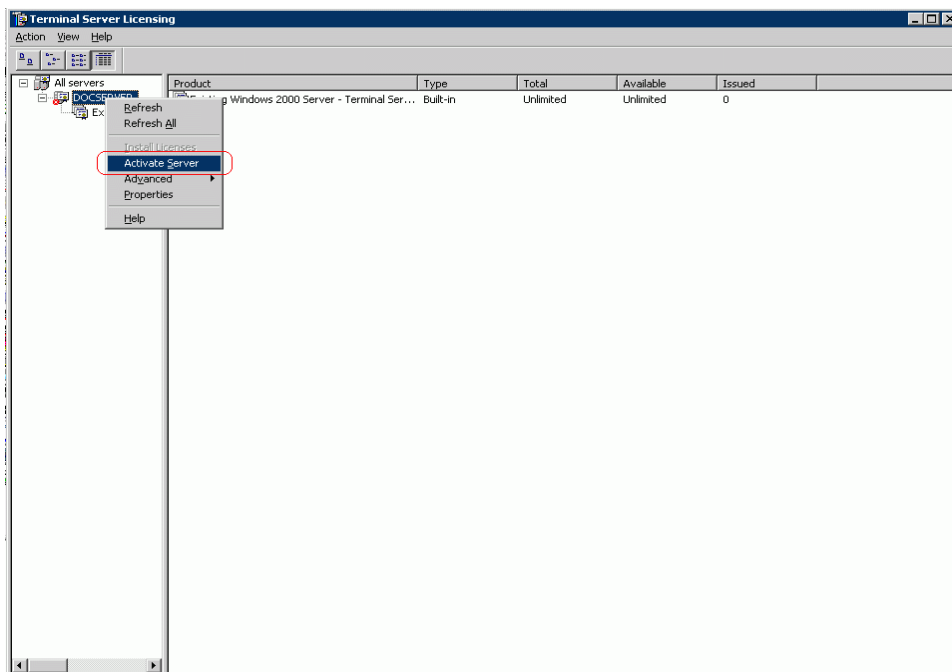

NOTE

- During activation, setup of the client license is also required. Please prepare the following licenses in advance:
 - Windows Server Client Access License (CAL)
 - Microsoft Windows Server OPEN Business User CAL
 - Microsoft Windows Server OPEN Business Device CAL
- Terminal Service Client Access License (TS CAL)
 - Microsoft Windows Server 2003 Terminal Service CAL OPEN Business User CAL
 - Microsoft Windows Server 2003 Terminal Service CAL OPEN Business Device CAL

Setup for OpenSSL

3 Download the latest "Win32OpenSSL" to any location in the server computer from the following Web page:

<http://www.shininglightpro.com/products/Win32OpenSSL.html>

NOTE

- The URL is current as of June in 2007; however the URL and contents of the site may change without notice.
- Although operational checks have been done on "Win32OpenSSL", its operations are not guaranteed in all environments. Please test the "Win32OpenSSL" operations in the environment you are planning to use.

4 Double-click the downloaded file to begin installation. Specify any location for the installation.

Setup for rdp2vnc

- 5 Copy the "rdp2vnc.exe" file from the following root folder on the installation CD and paste it into a folder on the server computer.
 \RPA\rdp2vnc\rdp2vnc.exe
- 6 Double-click "rdp2vnc.exe" on the server computer to decompress the file and create a "rdp2vnc" folder. From the "rdp2vnc" folder, double-click "installXP.bat". The Command prompt launches and installation begins.
- 7 Enter the name of the server computer you are installing the program on.

```

C:\WINDOWS\system32\cmd.exe
C:\keymaps\fr
C:\keymaps\fr-be
C:\keymaps\fr-ca
C:\keymaps\fr-ch
C:\keymaps\hr
C:\keymaps\hu
C:\keymaps\it
C:\keymaps\ja
C:\keymaps\lt
C:\keymaps\lv
C:\keymaps\mk
C:\keymaps\modifiers
C:\keymaps\no
C:\keymaps\pl
C:\keymaps\pt
C:\keymaps\pt-br
C:\keymaps\ru
C:\keymaps\sl
C:\keymaps\sv
C:\keymaps\th
C:\keymaps\tr
40 File(s) copied
1 file(s) copied.
--- Now Setting for rdp2vnc! ---
Please enter name of your PC >
    
```

- 8 Enter a user name with administrative privileges, and then enter the password.

```

C:\WINDOWS\system32\cmd.exe
C:\keymaps\fr-ca
C:\keymaps\fr-ch
C:\keymaps\hr
C:\keymaps\hu
C:\keymaps\it
C:\keymaps\ja
C:\keymaps\lt
C:\keymaps\lv
C:\keymaps\mk
C:\keymaps\modifiers
C:\keymaps\no
C:\keymaps\pl
C:\keymaps\pt
C:\keymaps\pt-br
C:\keymaps\ru
C:\keymaps\sl
C:\keymaps\sv
C:\keymaps\th
C:\keymaps\tr
40 File(s) copied
1 file(s) copied.
--- Now Setting for rdp2vnc! ---
Please enter name of your PC >test_servu
Please enter user's ID to administer your PC >test_user
Please enter password of user's ID to administer your PC >
    
```

NOTE

- If the password is empty, installation will end. Please set up a password.

- 9 When installation is complete, press the "Enter" key to exit the command prompt.

10 In the Control Panel, select [Administrative Tools] and double-click [Service] to check whether "rdp2vnc Server" is registered as a service.

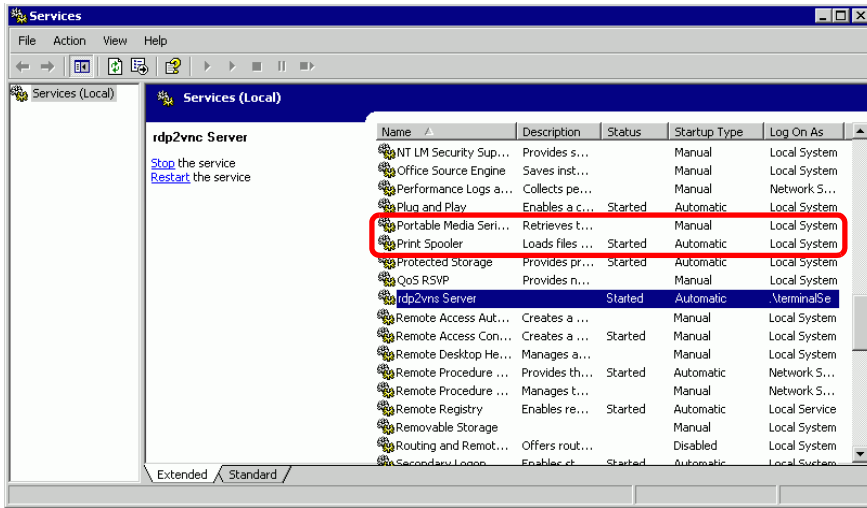

11 Click the [Recovery] tab, and select [Restart the Service] for the following items: [First failure], [Next failure] and [Subsequent failure].

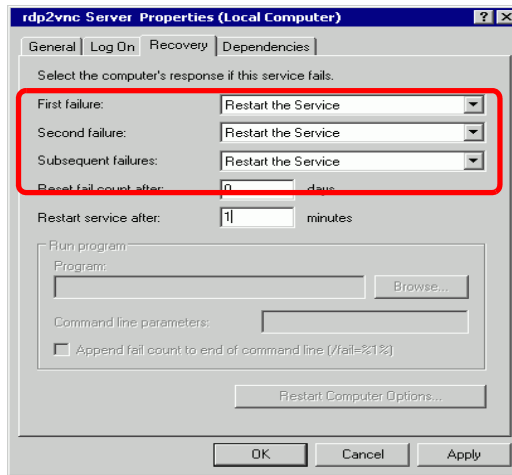

NOTE

- When [Restart the Service] is set, the service automatically restarts in the case of program errors of rdp2vnc for any reason, and it allows you to reconnect from the GP.

- 12 In the Control Panel, double-click [System]. In the System Properties dialog box, click the [Remote] tab and select the [Allow users to connect remotely to this computer] check box.

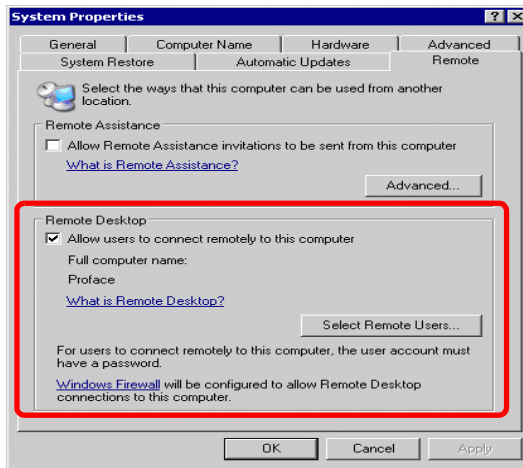

Setup for GP-Pro EX

- 13 Double-click [Remote PC Access Window Display] to display the dialog box settings. For the [Remote PC Access Server Address], enter the IP address of the server computer that rdp2vnc was set up for. Enter "5923" for [Port Number] and leave the [Password] field blank.

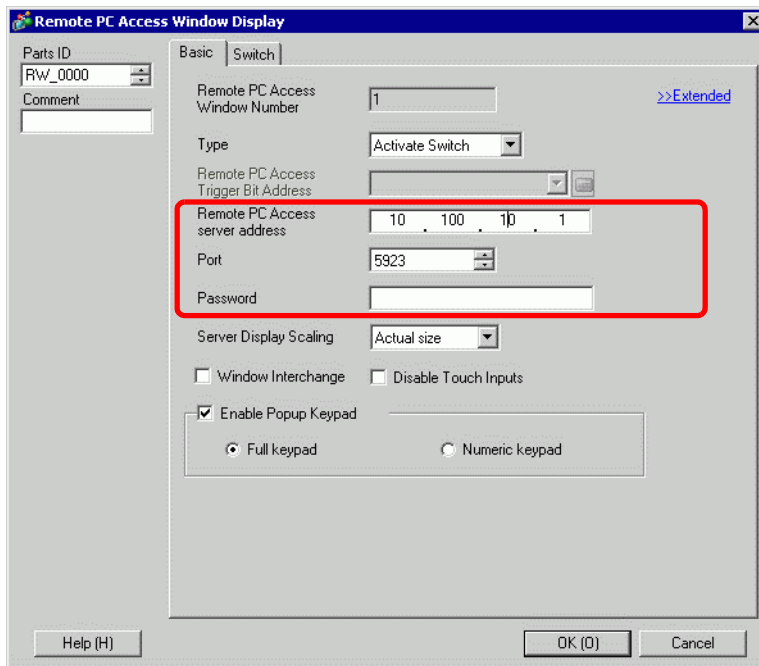

NOTE

- Password authentication is not performed when connecting to rdp2vnc.

- 14 Transfer the project to the GP.

Auto Log on

To log in from multiple displays with the Remote PC Access display unit, you can automate the log in account process.

- 1 In the [Remote PC Access Display] dialog box, click the [Basic] tab and click [Extended].
- 2 Select the [Automatically Log in to Terminal Server] check box and define the [User Name] and [Password].

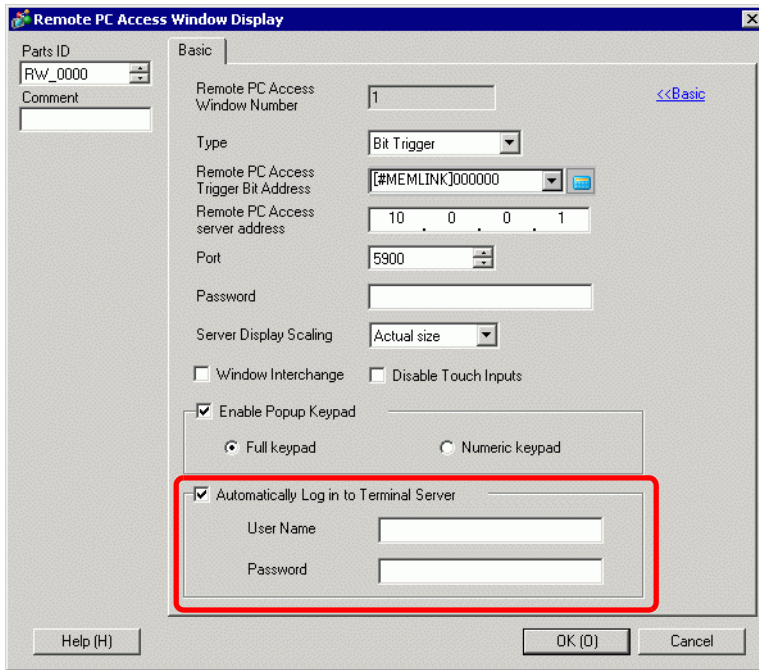

NOTE

- During login, if the User Name or Password is incorrect, a server login failure message appears, but the program does not disconnect.
- When using Automatic Log in, set the application to display the login screen immediately after connecting. Additionally, set a shortcut to display the input boxes for the User Name [Alt+U] and Password [Alt+P].
- If there are no login screens immediately after connecting, unexpected behavior may occur.
For example, if your application does not go to a login screen after connecting and the application is running, when the shortcuts [Alt+U] and [Alt+P] are pressed, they run functions allocated to them and fill out the User Name and Password.

36.3.3 Operating Procedure

- 1 When you touch [RPA Window Display Switch], the RPA window screen and the server computer screen display.

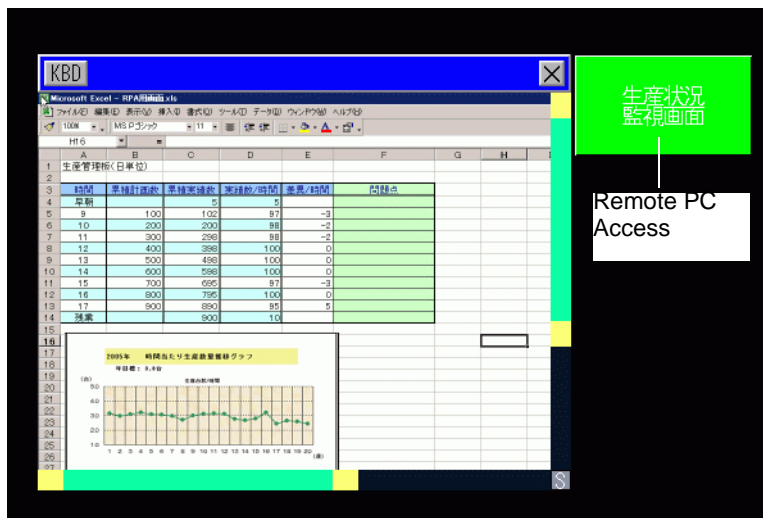

- 2 You can scroll the screen area that cannot display in the remote PC access window display with the scroll bar.

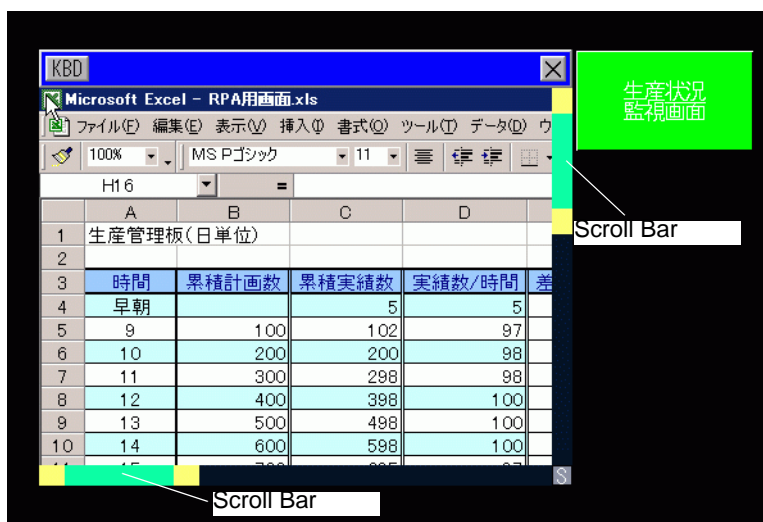



- 3 To enter data from the keyboard, touch the **KBD** button to display the keypad associated with the [Remote PC Access Window Display].
- 4 To close the window, touch the [RPA Window Display Switch] again or touch the **X** button. If you start the remote PC access window display by the "Bit Trigger", the bit address turns OFF automatically when you press the **X** button.

36.4 Settings Guide

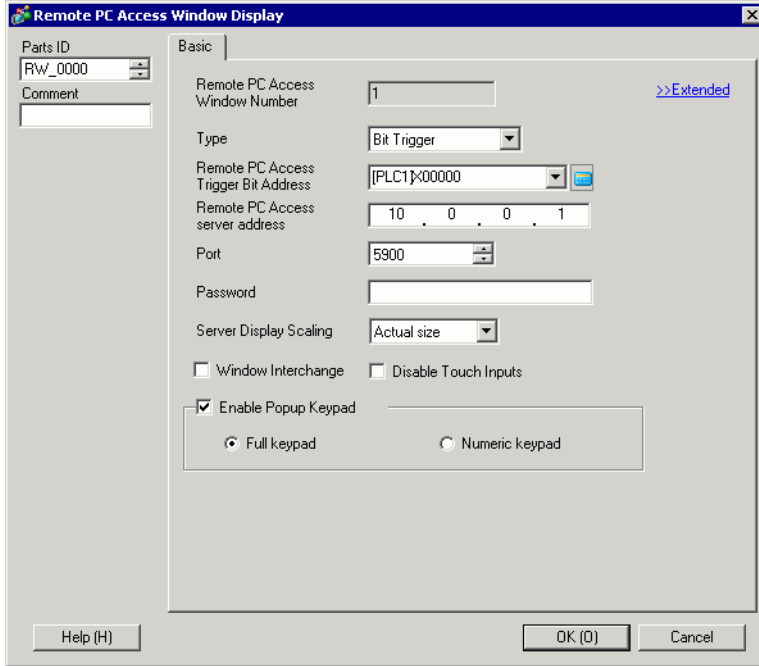

36.4.1 Remote PC Access Window Display Settings Guide

■ Basic Tab/Basic



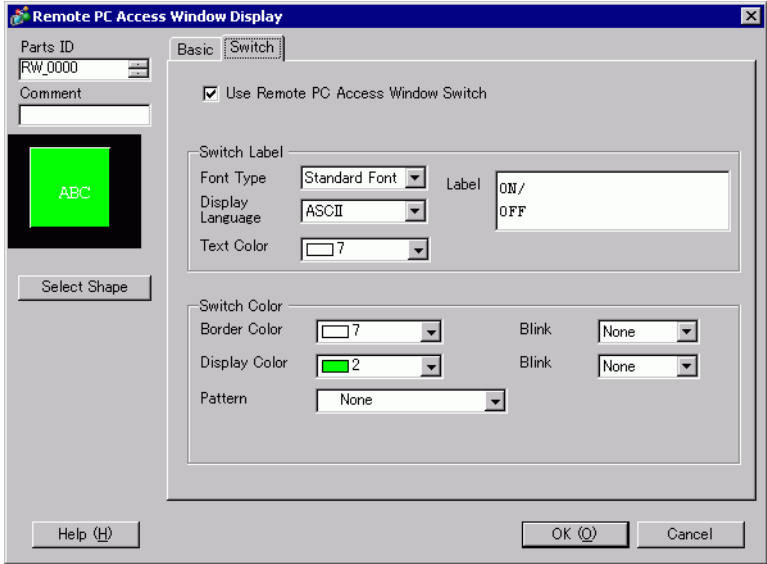

Setting	Description
Parts ID	Parts are automatically assigned an ID number. Key part ID: RW_****(4-digit numbers) The letter portion is fixed. The number portion can be modified from 0000 to 9999.
Comment	The comment for each Part can be up to 20 characters.
Remote PC Access Window Number	The RPA window screens for display are automatically assigned 1 to 8 in the order of RPA window display allocation.
Type	Select the trigger method for the RPA Window Screens from [Bit Trigger] or [Activate Switch].
Bit Trigger	When the bit designated by [Remote PC Access Bit Address] is on, the server computer screen displays in a window. NOTE <ul style="list-style-type: none"> If you start the remote PC access window display by [Bit Trigger], the remote PC access trigger bit address turns OFF automatically when you push the  button in the remote PC access window display. Also the RPA start bit turns OFF when you switch the screen.

Continued

Setting	Description
<p>Activate Switch</p>	<p>The [Switch] tab is added to the dialog box. The [Remote PC Access Window Display Switch] is located beside the RPA window parts.</p> <p>When you touch this switch, the server computer screen displays as a window on the GP.</p> 
<p>Remote PC Access Trigger Bit Address</p>	<p>When you select [Bit Trigger] in [Type], set the bit address to control the start of window screens.</p>
<p>User Name</p>	<p>Set the login User Name with up to 20 single-byte characters.</p>
<p>Password</p>	<p>Set the login Password with up to 30 single-byte characters.</p>
<p>Remote PC Access server address</p>	<p>Set up the connected server with any IP address other than 0.0.0.0, 127.0.0.1, or 255.255.255.255.</p>
<p>Port</p>	<p>Set the port number of the destination server from 1024 to 65535.</p>
<p>Password</p>	<p>Set the password to connect the server software up to a maximum of 30 characters. You must set the same password as the one for the UltraVNC software.</p>
<p>Server Display Scaling</p>	<p>Select the server screen size from [Actual size], [1/4 Display], or [1/9 Display].</p>
<p>Window Interchange</p>	<p>Select this check box to allow the selected window to move on top of another window.</p>
<p>Disable Touch Inputs</p>	<p>Specify whether touch inputs are restricted for the computer.</p> <p>NOTE</p> <ul style="list-style-type: none"> • USB keyboard and USB mouse can operate even when touch input is prohibited. <p> "36.4.2 System Settings [Input Equipment Settings] - [Remote PC Access Input] Settings Guide" (page 36-27)</p>
<p>Enable Popup Keypad.</p>	<p>Specify whether the popup keypad is enabled. Each key on the popup keypad corresponds to the keys on the computer keyboard.</p>

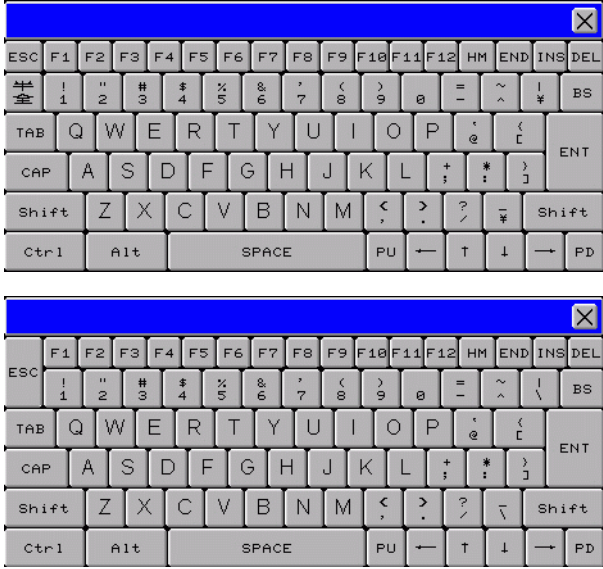
Continued

Setting	Description
<p>Full keypad, Numeric keypad</p>	<p>Select the displayed popup keypad from [Full keypad] or [Numeric keypad].</p> <ul style="list-style-type: none"> • Full keypad The text keypad for A - Z and the special keys such as ENT, Shift, Ctrl key etc. display.  <ul style="list-style-type: none"> • Numeric keypad The numeric keypad (0-9), the arrow keys pointing right, left, up and down, and the DEL and ENT keys display.  <p>NOTE</p> <ul style="list-style-type: none"> • When Remote PC Access Window Display is grouped with other objects, you cannot select and move the display area of popup keyboard.

■ Basic Tab/Extended

The screenshot shows the 'Remote PC Access Window Display' configuration window with the 'Basic' tab selected. The window contains the following fields and options:

- Parts ID:** A dropdown menu showing 'Rw_0000'.
- Comment:** An empty text input field.
- Remote PC Access Window Number:** A text input field containing '1'.
- Type:** A dropdown menu showing 'Bit Trigger'.
- Remote PC Access Trigger Bit Address:** A dropdown menu showing '#MEMLINKJ000000'.
- Remote PC Access server address:** A text input field containing '10 . 0 . 0 . 1'.
- Port:** A text input field containing '5900'.
- Password:** An empty text input field.
- Server Display Scaling:** A dropdown menu showing 'Actual size'.
- Window Interchange:** An unchecked checkbox.
- Disable Touch Inputs:** An unchecked checkbox.
- Enable Popup Keypad:** A checked checkbox. Below it are two radio buttons: 'Full keypad' (selected) and 'Numeric keypad'.
- Automatically Log in to Terminal Server:** A checked checkbox. Below it are two text input fields: 'User Name' and 'Password'.

Buttons at the bottom include 'Help (H)', 'OK (O)', and 'Cancel'.

Setting	Description
Automatically Log in to Terminal Server	<p>Specify whether to log in automatically when connecting to the server.</p> <p>NOTE</p> <ul style="list-style-type: none"> When using terminal servers, specify the automatic login settings. If Automatic Login is not specified and you are using a terminal server, a login screen appears where you can enter the login User Name and Password through the keypad.
User Name	Set the login User Name with up to 20 single-byte characters.
Password	Set the login Password with up to 30 single-byte characters.

■ Switch

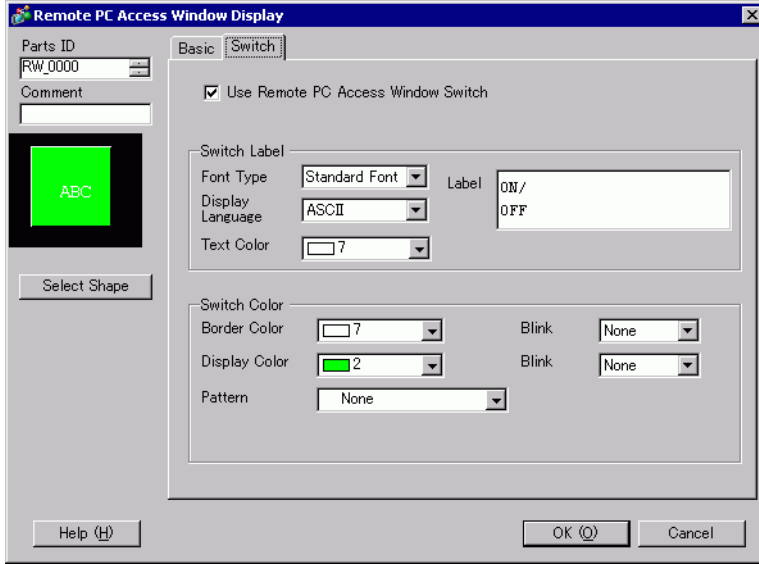

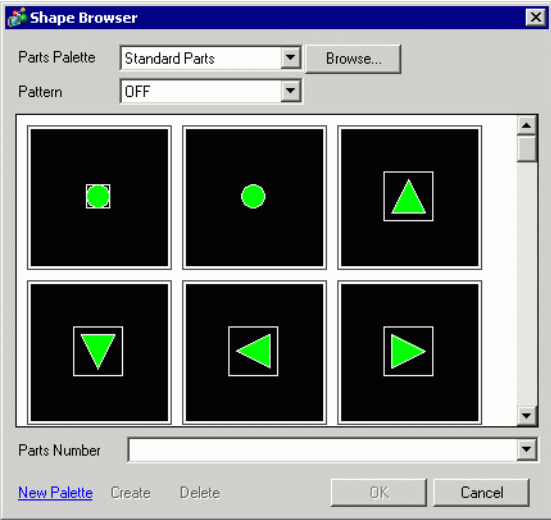
Setting	Description
<p>Select Shape</p>	<p>Open the Select Shape dialog box to choose the shape.</p>  <p>Depending on the shape, you may not be able to change the color.</p>
<p>Use Remote PC Access Window Switch</p>	<p>Set whether to place switches for control of the remote PC access window display or clear the remote PC access window display. The switches are automatically placed on the top right of the remote PC access window. However you can select and move them individually.</p>

Continued

Setting		Description
Switch Label	Font Type	<p>Select the font type for the label that displays on the switch.</p> <ul style="list-style-type: none"> • Standard Font The vertical and horizontal dimensions of a character can be specified in bitmap font. When a character is enlarged or reduced, the outline of the character may appear grainy or smudged. • Stroke Font This is the outline font (with the lines defined together) for which the vertical and horizontal dimensions of a character are fixed. Even when a character is enlarged or reduced, the outline clearly displays. However, due to the large required capacity, this font may put a burden on the GP.
	Display Language	Select the display language to display the switch label from [Japanese], [ASCII], [Chinese (Traditional)], [Chinese (Simplified)], [Korean], [Cyrillic] or [Thai].
	Text Color	Select a color for the label text.
	Label	<p>Enter the text to display on the switch.</p> <p>NOTE</p> <ul style="list-style-type: none"> • When you select a switch and press the [F2] key you can directly edit the text of the label.
Switch Color	Border Color	If it exists, select a color for the Part Shape border.
	Display Color	Select the Switch color.
	Pattern	Select from the 8 patterns or choose [No Pattern].
	Pattern Color	<p>Select the color of the pattern, if you selected a pattern other than [Pattern], [No Pattern].</p> <p>The switch color displays by [Display Color] and [Pattern Color].</p>
	Blink	<p>Select the Part blink and blink speed. You can choose blink settings for the [Border Color], [Display Color], and [Pattern Color].</p> <p>NOTE</p> <ul style="list-style-type: none"> • There are cases where you can and cannot set Blink depending on the Display Unit and System Settings' [Color Settings]. ☞ "8.5.1 Setting Colors ■ List of Compatible Colors" (page 8-36)

36.4.2 System Settings [Input Equipment Settings] - [Remote PC Access Input] Settings Guide

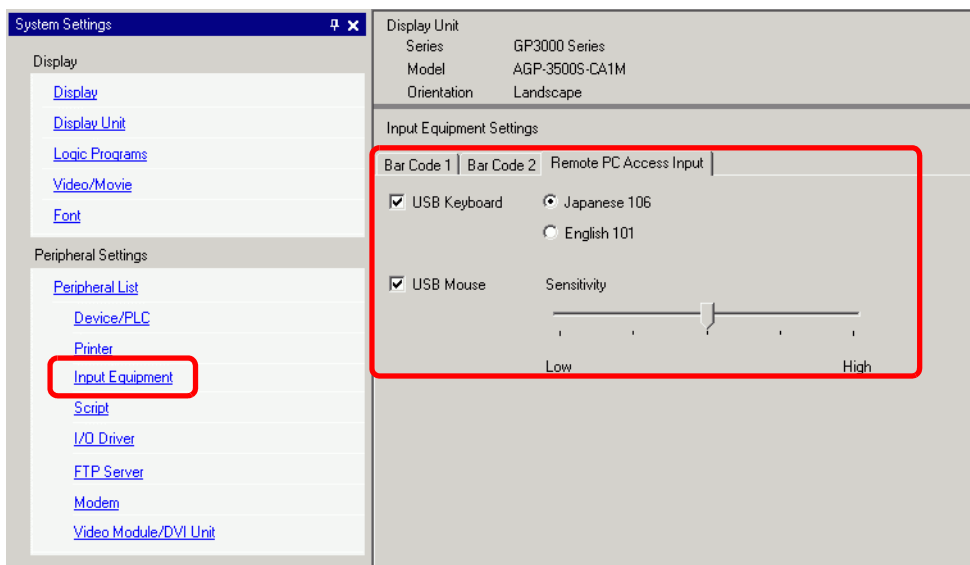

Setting	Description
USB Keyboard	Set whether to use the USB ports connected keypad when you operate the server screen from the display.
Japanese 106 Keypad	Select when to enable keypad registration for Japanese.
English 101 Keypad	Select when you enable keypad registration for English.
USB Mouse	Set whether to use the USB ports connected to the mouse when you operate the server screen from the display.
Sensitivity	Adjusts the sensitivity of the USB mouse.

36.4.3 Remote PC Access Window Display Setting Guide



Setting	Description
KBD	Define popup keypad use.
Menu Bar	[Show/Hide Popup Keypad], [Close the Window] buttons display.
Close Window Screen 	Close the RPA display window. If you started [Bit Address] on the RPA display window, press the [Close the Window] button to turn OFF the bit address.
Scroll Bar	When you touch the yellow area, the scroll bar moves by 10 pixels at a time. When you scroll by touching the black part, the screen moves page by page. When you click the green area, you can drag the mouse to move the screen.
Display Area	Display the contents of server computer.

36.5 Restrictions

- The server computer display data is appears with a color number decreased according to the color specified in the display unit.
- If you set the USB keyboard to be used with [Input Device Settings], [RPA Input] other than the RPA feature, the settings will not be not used.
- The Remote PC Access Window may not be able to display everything viewed on the server PC. For example, protected movies from a Web site will not appear on the display unit.
- There may be a short time delay between the GP display and the display on the server computer. For example, in the [Date and Time Properties], the seconds display for the [Time (T)] object may not match.
- Using the Remote PC Access feature, if you set the Orientation to [Portrait], the screen displays the same as [Landscape]. Set [Orientation] to [Landscape].
- When displaying the Remote PC Access Window, overall performance is reduced.
- You can connect each USB keyboard or USB mouse for remote PC access input. To connect or disconnect with the server computer may take time.
- Connection and disconnection to the server computer may take time. On the server PC, make sure the display settings are set to 16 bit color quality.
- In the Window Control Panel's [Display Properties] dialog box, see the [Settings] tab. Other color settings will prevent the display unit from connecting.
- A project other than the current project cannot be transferred to the GP itself using the RPA feature. This is because GP transits to offline while being transferred and the GP feature is interrupted.

36.5.1 Remote PC Access Window Display Unit Restrictions

- You can set up one Remote PC Access Window Display on one screen. Do not use [Call Screen] or any other features and display multiple Remote PC Access Window Displays. The entire project is limited to eight displays.
- You can set the remote PC access window display for only base screen display. The remote PC access window display does not work on the window screen.
- In "Bit Address", the window opens when the bit is ON, and closes when the bit is OFF. To turn ON or OFF the start bit takes more than one communication cycle or display scan time to find the bit state.
- Remote PC access window display uses one local window. Therefore, you can display up to 2 (if you use the global window in the local window, you can display up to 3.) on the window parts and remote PC access window display at the same time. If you display 2 on the window parts, you cannot display on the remote PC access window display.
- If you display the remote PC access window display, only one window part can be allocated to the same screen. The start sequence for the window part and the remote PC access window display must have the start bit turned on first. If the start bit is turned on at the same time, the order of when parts display cannot be controlled.
- Remote PC access window display displays in the same direction as [Landscape], even if you set [Portrait] in for the [Orientation].

36.5.2 Remote PC Access Window Restrictions

- You cannot change the size or contents of the window settings that display on the remote PC access window display.
- If the displayed window size and display position on the remote PC access window display exceeds the display range, it automatically displays within the display range. The popup keypad is also displayed within the display range. The order is as follows.

Change the display position to display the whole window screen.

If the window screen exceeds the display range, change the window screen size.

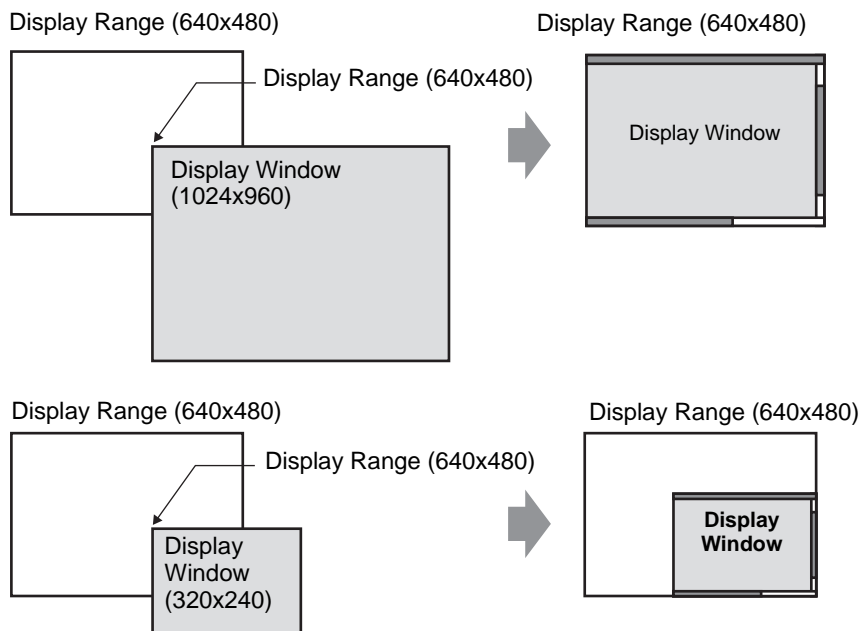

- If you specify a remote PC access window display other than the supported models, even if you save the screen, the settings cannot be used.
- Connection and disconnection to the server computer may take time. The remote PC access window display appears in black until connected. The extra space appears in black if the server computer display is smaller than the remote PC access window display when displayed on the server computer.
- Even if the window designated [Continuous Read] does not display, if it is set at the maximum display number (2 for using the global window, 3 for only local window), then the RPA window screen cannot display.

Refer to the following for show window restrictions.

☞ "12.8.2 Restrictions for Window Screens" (page 12-30)

36.5.3 Server Computer Connection Restrictions

- The GP is not able to connect to the server PC when it uses the Windows Firewall. Disable the Firewall.
- The time-out of the server computer and display unit is set at 75 seconds. If you cannot connect with the server computer, the display unit searches the network for 75 seconds and the remote PC access window display appears as a black screen. After 75 seconds, the error message "The server cannot be found, or unable to connect to server" appears on the display unit.
- If you cannot connect even after the display unit connects to the server (for example, the IP address of the server cannot be found or a cable is unplugged), you cannot restart the server computer or input to the RPA window screen for up to 75 seconds.
- If you cannot connect to the server computer (for example, a disconnected cable exists), you cannot update the RPA window screen display or input because the connection times out based on the time-out settings on the server computer. In this case, the time-out error message does not display on the server computer. Turn off the remote PC access window display to end the RPA connection.
- If you cannot connect to the server computer, you can update and operate the screen if the connection is recovered before the server times out. The input entered during the disconnection is sent to the server computer after the connection is recovered.
- If communication between the GP and server PC fails after a connection had been established, turn off the Remote PC Access Window Display. However, you will be unable to use the Remote PC Access Window Display on other server computers for up to 75 seconds. appears on the display unit.
- While you cannot connect to the server, even if you shift to offline mode or transfer project (when it is not reset by automated transfer) then shift back to online, you cannot connect to the server computer up to 75 seconds after connecting to the RPA. After returning to online and starting the remote PC access window display, the error message "Connection to the server in progress" appears on the display unit.
- When the Remote PC Access server connection is not established, you cannot run the LAN self-diagnosis check in the offline mode's [Maintenance Menu]. After the Remote PC Access server connection is made, wait 75 seconds and then check the LAN ports.
- When using UltraVNC, it is impossible for multiple GPs to connect to one server computer at the same time. When using rdp2vnc, it is possible to connect from multiple GPs.
- When connecting from multiple GPs using rdp2vnc at the same time, the allowable number of devices depends on the CPU or memory of the server computer. Refer to the following:

CPU	Memory	Number of simultaneous connections
Pentium III 600 MHz or equivalent or higher	256MB or more	1 only
Pentium D 840 (3.2 GHz) or equivalent or higher	More than 1GB	Up to 5

Continued

CPU	Memory	Number of simultaneous connections
Pentium D 840 (3.2 GHz) or equivalent or higher	More than 2GB	Up to 10
Xeon 3.4 (2 way) or equivalent	More than 4GB	Up to 50

36.5.4 RPA Popup Keypad Restrictions

- If the special window screen (such as the popup keypad for data display parts) displays first, the keypad registration does not display when you touch the keypad for the RPA window screen. However, if the keypad registration for the RPA window screen displays, the special window screen can be displayed and operated.

Refer to the following for the special window screen:

 12.8.2 Restrictions for Window Screens ■ Displaying Multiple Windows on a Single Screen 12-31

- The popup keypad closes when you change screens, turn off the RPA display window, or go to offline mode.
- You cannot use the auto repeat input function (inputs while you hold the key) with the popup keypad.
- The [Single Byte/Double Byte] key displays only when the [System Settings] [Display Unit] [Menu and Error Settings] [System Language] is set to Japanese.
- The popup keypad display is not supported when the display unit's [Orientation] is set to [Portrait].
- When [Caps Lock] is enabled on a USB keyboard, it affects inputs to the popup keypad (type as if the [Shift] key is pressed).
- When [Caps Lock] is enabled on a popup keypad and you type [Ctrl]+any key, it inputs [Ctrl]+[Shift]+any key. When typing [Alt]+any key, it inputs [Alt]+[Shift]+any key.

36.5.5 USB Keyboard for RPA Restrictions

- A USB keyboard and a USB bar code cannot be used simultaneously. Set up connections for only one of these USB devices.
- Only Japanese and English keyboard are accepted for the external connection keyboard.
- You can use the popup keyboard for RPA at the same time, however keys such as Shift and Caps Lock will be separate on each keyboard.

For example, if you type "A" using a USB keyboard with Caps Lock ON and the Remote PC Access popup keypad has Caps Lock OFF, the lower case "a" appears.

- Even if the window screen displays on top of the show window on the remote PC access window display, you can input on the keyboard. However, the remote PC access window display does not automatically appear on top when you start to input on the keyboard.
- You can connect only one USB keyboard. To connect or disconnect with the server computer may take time.
- If you attempt to [Enable] a USB keyboard other than the RPA feature models, the settings cannot be used.
- You cannot use the auto repeat input (function for input while holding down the key) by the USB keyboard.
- When using a USB keyboard, if you type a large amount of data at one time, some of the characters input may be dropped or keys might remain depressed. For example, if you continuously toggle between the [Alt] and [Ctrl] keys, they system buttons [ALT] and [CTRL] may remain colored yellow. When a key remains depressed, close then redisplay the Remote PC Access Window.

- Using the USB keyboard, the [Convert], [Do not convert], [katakana], and [hiragana] keys on a Japanese 106 keyboard do not work.
- In normal computer operations, when you push the numeric keypad while holding the Shift key with NumLock ON, the cursor moves. However, when you use the RPA feature, it is same as pushing the numeric keypad while holding down the Shift key with NumLock OFF to select the cursor.
- In normal computer operations, if you push the cursor key with ScrollLock ON, the page moves. However, when you use the RPA feature, the cursor moves line by line just as the normal cursor key.
- When the display unit is in standby mode (and therefore OFF), as you type from the USB keyboard, the display unit turns back on.

36.5.6 USB mouse for RPA Restrictions

- You can only input the right button, left button, wheel button, wheel coordinates and mouse coordinates with the USB mouse. If you use a higher function mouse, you cannot operate the other functions, such as back and forward.
- You can connect only one USB mouse.
- The red frame in the following illustration indicates how much you can move the mouse cursor. It cannot be moved outside the following range.

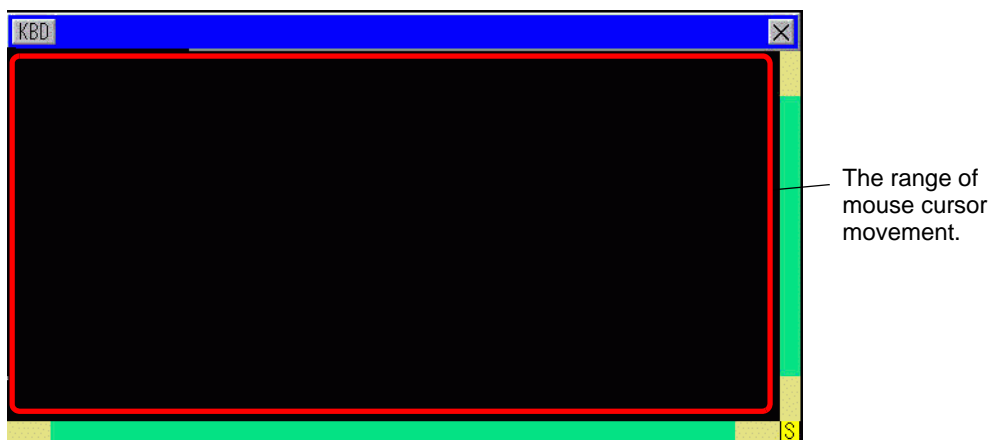

- Even if the window screen displays on top of the show window on the remote PC access window display, you can input with the mouse. However, the remote PC access window display does not automatically appear on top when you start inputting with the mouse.
- If you specify a USB mouse other than the RPA feature models to be used in [Input Device Settings], [RPA Input], the settings cannot be used.
- When the display unit is on standby mode (therefore OFF), inputs from the USB mouse will turn the display on.
- When you use a USB mouse connected to the display unit, the mouse cursor might leave a trail, but this does not appear on the server PC.
- When there is a communication error between the Remote PC Access Window Display and another object on the same screen, the Remote PC Access Window Display will not run. Either restore the communication error, or draw the Remote PC Access Window Display on its own screen.