



PROVISOR TC200 Driver

1	System Configuration.....	3
2	Selection of External Device	6
3	Example of Communication Setting.....	7
4	Setup Items	22
5	Cable Diagram	27
6	Supported Device.....	29
7	Device Code and Address Code.....	35
8	Error Messages.....	39

Introduction

This manual describes how to connect the Display and the External Device (target PLC).

In this manual, the connection procedure will be described by following the below sections:

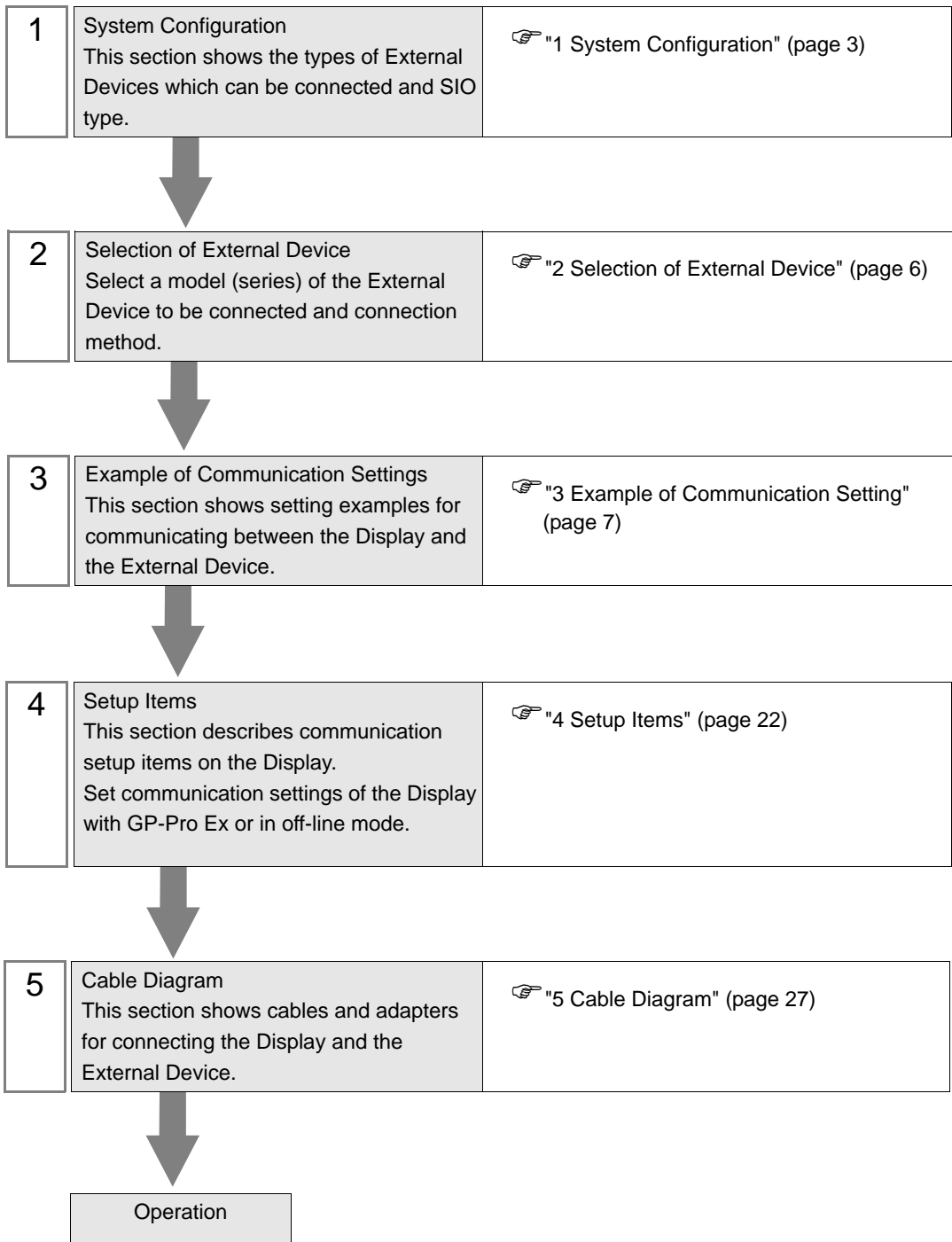

1 System Configuration

The system configuration in the case when the External Device of TOSHIBA MACHINE CO., LTD. and the Display are connected is shown.

Series	CPU	Link I/F	SIO Type	Setting Example	Cable Diagram
TC200	TCCUH	TCCMW	RS232C	"Setting Example 1" (page 7)	"Cable Diagram 1" (page 27)
		TCCMO		"Setting Example 2" (page 10)	
		RS232C connector on CPU Module *1		"Setting Example 3" (page 12)	
TC200S	TCCUHS TCCUSS	TCCMWA	RS232C	"Setting Example 4" (page 14)	"Cable Diagram 1" (page 27)
		TCCMOA		"Setting Example 5" (page 17)	
		RS232C connector on CPU Module *1		"Setting Example 6" (page 19)	
TCmini	TC3-01 TC3-02 TC5-02 TC6-00 TC8-00	Port on CPU Module	RS232C	"Setting Example 7" (page 21)	"Cable Diagram 2" (page 28)

*1 To connect Display directly with External Device, set PC No. to 64 in the device settings dialog box of GP-Pro EX.

■ Connection Configuration

- 1:1 Connection

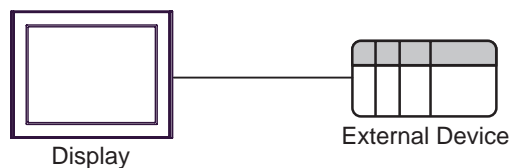

NOTE

- In this case, Display can communicate with the port on CPU module or PC link Module.

- 1:n Connection (Case of using TC200 Series / TC200S Series' External Device)

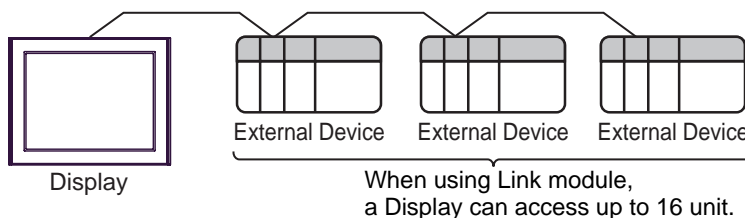

■ COM Port of IPC

When connecting IPC with External Device, the COM port which can be used changes with series and SIO type. Please refer to the manual of IPC for details.

Usable port

Series	Usable port		
	RS-232C	RS-422/485(4 wire)	RS-422/485(2 wire)
PS-2000B	COM1 ^{*1} , COM2, COM3 ^{*1} , COM4	-	-
PS-3450A, PS-3451A	COM1, COM2 ^{*1*2}	COM2 ^{*1*2}	COM2 ^{*1*2}
PS-3650A, PS-3651A	COM1 ^{*1}	-	-
PS-3700A (Pentium®4-M) PS-3710A	COM1 ^{*1} , COM2 ^{*1} , COM3 ^{*2} , COM4	COM3 ^{*2}	COM3 ^{*2}
PS-3711A	COM1 ^{*1} , COM2 ^{*2}	COM2 ^{*2}	COM2 ^{*2}
PL-3000B	COM1 ^{*1*2} , COM2 ^{*1} , COM3, COM4	COM1 ^{*1*2}	COM1 ^{*1*2}

*1 The RI/5V can be switched. Please switch with the change switch of IPC.

*2 It is necessary to set up the SIO type with the Dip switch. Please set up as follows according to SIO type to be used.

Dip switch setting: RS-232C

Dip switch	Setting	Description
1	OFF ^{*1}	Reserve (always OFF)
2	OFF	SIO type: RS-232C
3	OFF	
4	OFF	Output mode of SD (TXD) data: Always output
5	OFF	Terminal resistance (220Ω) insertion to SD (TXD): None
6	OFF	Terminal resistance (220Ω) insertion to RD (RXD): None
7	OFF	Short-circuit of SDA (TXA) and RDA (RXA): Does not Exist
8	OFF	Short-circuit of SDB (TXB) and RDB (RXB): Does not Exist
9	OFF	RS (RTS) Auto control mode: Disable
10	OFF	

*1 It is necessary to turn ON the set value, only when using PS-3450A and PS-3451A.

Dip switch setting: RS-422/485 (4 wire)

Dip switch	Setting	Description
1	OFF	Reserve (always OFF)
2	ON	SIO type: RS-422/485
3	ON	
4	OFF	Output mode of SD (TXD) data: Always output
5	OFF	Terminal resistance (220Ω) insertion to SD (TXD): None
6	OFF	Terminal resistance (220Ω) insertion to RD (RXD): None
7	OFF	Short-circuit of SDA (TXA) and RDA (RXA): Does not Exist
8	OFF	Short-circuit of SDB (TXB) and RDB (RXB): Does not Exist
9	OFF	RS (RTS) Auto control mode: Disable
10	OFF	

Dip switch setting: RS-422/485 (2 wire)

Dip switch	Setting	Description
1	OFF	Reserve (always OFF)
2	ON	SIO type: RS-422/485
3	ON	
4	OFF	Output mode of SD (TXD) data: Always output
5	OFF	Terminal resistance (220Ω) insertion to SD (TXD): None
6	OFF	Terminal resistance (220Ω) insertion to RD (RXD): None
7	ON	Short-circuit of SDA (TXA) and RDA (RXA): Exist
8	ON	Short-circuit of SDB (TXB) and RDB (RXB): Exist
9	ON	RS (RTS) Auto control mode: Enable
10	ON	

2 Selection of External Device

Select the External Device to be connected to the Display.

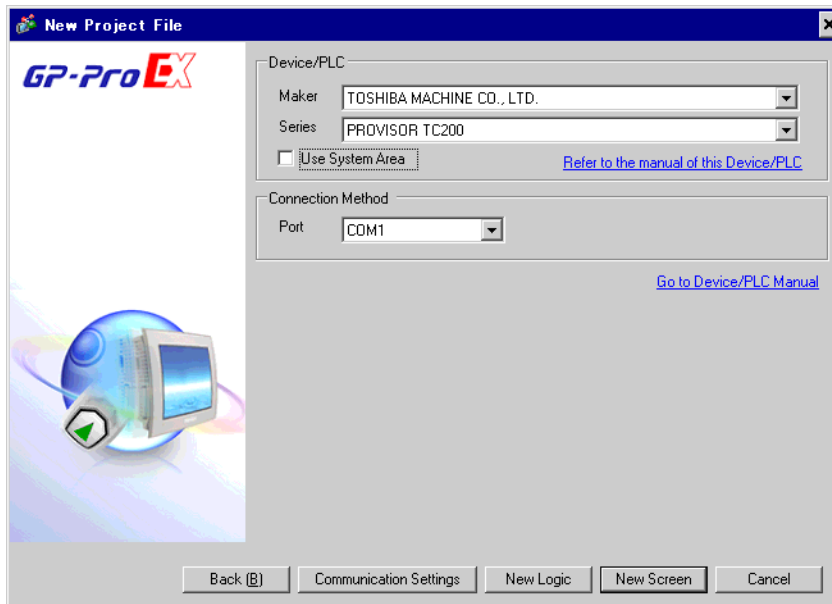

Setup Items	Setup Description
Maker	Select the maker of the External Device to be connected. Select "TOSHIBA MACHINE CO., LTD.".
Series	Select a model (series) of the External Device to be connected and connection method. Select "PROVISOR TC200". Check the External Device which can be connected in "PROVISOR TC200" in system configuration. ☞ "1 System Configuration" (page 3)
Use System Area	Check this option when you synchronize the system data area of the Display and the device (memory) of the External Device. When synchronized, you can use the ladder program of the External Device to switch the display or display the window on the Display. Cf. GP-Pro EX Reference Manual "Appendix 1.4 LS Area (Direct Access Method)" This can be also set with GP-Pro EX or in off-line mode of the Display. Cf. GP-Pro EX Reference Manual " 5.17.6 Setting Guide of [System Setting Window]■[Main Unit Settings] Settings Guide◆System Area Setting" Cf. Maintenance/Troubleshooting "2.15.1 Settings common to all Display models◆System Area Settings"
Port	Select the Display port to be connected to the External Device.

3 Example of Communication Setting

Examples of communication settings of the Display and the External Device, recommended by Pro-face, are shown.

3.1 Setting Example 1

■ Settings of GP-Pro EX

◆ Communication Settings

To display the setting screen, select [Device/PLC Settings] from [System setting window] in workspace.

◆ Device Setting

To display the setting screen, click  ([Setting]) of External Device you want to set from [Device-Specific Settings] of [Device/PLC Settings].

When you connect multiple External Device, click  from [Device-Specific Settings] of [Device/PLC Settings] to add another External Device.

■ Settings of External Device

Set PC No. of the External Device using DIP switches and the rotary switch of External Device.

Please refer to the manual of the External Device for more details.

After setting, reboot the External Device to enable the setting.

◆ Setup Items

- DIP switch

DIP switch	Settings ^{*1}	Setup Description
SW1	OFF	Set PC No. by combining with the rotary switch.
SW2	OFF	
SW3	ON	Link Master
SW4	OFF	Link Slave
SW5	OFF	Remote Master
SW6	OFF	Remote Slave

*1 For SW3 to SW6, if two or more than two switches are turned on, there will be a set error.
SW3 must be turned ON when connect to Display.

- Rotary switch

Settings	Setup Description
0	PC No.

NOTE

- Set PC No. using DIP switches 1 and 2 and the rotary switch. Combination of possible settings is as follows.

DIP switch		PC No. that can be set with the rotary switch
SW1	SW2	
OFF	OFF	0 - 15
OFF	ON	16 - 31
ON	OFF	32 - 47
ON	ON	48 - 63

◆ Caution

In the case of a 1:n connection, the terminating resistance switch and shield grounding switch need to be set.

- Setting of the terminating resistance switch (ON/OFF) (LINE T)

Always turn on the terminating resistance on both end stations of the communication circuit. Always turn off the terminating resistance of the way station.

IMPORTANT

- Turning off the terminating resistance on both end stations or turning on the terminating resistance of the way station disables normal communication.

- Setting of the shield grounding switch (grounding/isolating) (LINE G) of communication cable

Turn on the shield grounding switch (grounding) on the shield side of the communication cable.

IMPORTANT

If there is 4V or more grounding electric potential difference between the other control panel and this module control panel, take the following steps.

- Turn off the shield grounding switch(isolating) .
- If the total extension of communication cable exceeds 100m, turn on one or more switch(es) (grounding) every 100m. Select a place with 4V or lower grounding electric potential difference for grounding.
- If the total extension of the communication cable is 100m or less, turn on a switch (grounding) in the intermediate position.

3.2 Setting Example 2

■ Settings of GP-Pro EX

◆ Communication Settings

To display the setting screen, select [Device/PLC Settings] from [System setting window] in workspace.

Device/PLC 1

Summary [Change Device/PLC](#)

Maker: TOSHIBA MACHINE CO., LTD. Series: PROVISOR TC200 Port: COM1

Text Data Mode: 4 [Change](#)

Communication Settings

SIQ Type: RS232C RS422/485(2wire) RS422/485(4wire)

Speed: 9600

Data Length: 7 8

Parity: NONE EVEN ODD

Stop Bit: 1 2

Flow Control: NONE ER(DTR/CTS) XON/XOFF

Timeout: 3 (sec)

Retry: 2

Wait To Send: 0 (ms)

RI / VCC: RI VCC

In the case of RS232C, you can select the 9th pin to RI (Input) or VCC (5V Power Supply). If you use the Digital's RS232C Isolation Unit, please select it to VCC.

Default

Device-Specific Settings

Allowable Number of Devices/PLCs: 16

Number	Device Name	Settings
1	PLC1	Series=TC200 Series,PC No.=0

◆ Device Setting

To display the setting screen, click ([Setting]) of External Device you want to set from [Device-Specific Settings] of [Device/PLC Settings].

When you connect multiple External Device, click from [Device-Specific Settings] of [Device/PLC Settings] to add another External Device.

Individual Device Settings

PLC1

Series: TC200 Series

Please reconfirm all of address settings that you are using if you have changed the series.

PC No.: 0

Default

OK (O) Cancel

■ Settings of External Device

Set PC No. of the External Device using DIP switches and the rotary switch of External Device.

Please refer to the manual of the External Device for more details.

After setting, reboot the External Device to enable the setting.

◆ Setup Items

- DIP switch

DIP switch	Settings ^{*1}	Setup Description
SW1	OFF	Set PC No. by combining with the rotary switch.
SW2	OFF	
SW3	ON	Link Master
SW4	OFF	Link Slave
SW5	OFF	Remote Master
SW6	OFF	Remote Slave

*1 For SW3 to SW6, if two or more than two switches are turned on, there will be a set error.
SW3 must be turned ON when connect to Display.

- Rotary switch

Settings	Setup Description
0	PC No.

NOTE

- Set PC No. using DIP switches 1 and 2 and the rotary switch.
Combination of possible settings is as follows.

DIP switch		PC No. that can be set with the rotary switch
SW1	SW2	
OFF	OFF	0 - 15
OFF	ON	16 - 31
ON	OFF	32 - 47
ON	ON	48 - 63

3.3 Setting Example 3

■ Settings of GP-Pro EX

◆ Communication Settings

To display the setting screen, select [Device/PLC Settings] from [System setting window] in workspace.

Device/PLC 1

Summary [Change Device/PLC](#)

Maker Series Port

Text Data Mode [Change](#)

Communication Settings

SIO Type RS232C RS422/485(2wire) RS422/485(4wire)

Speed

Data Length 7 8

Parity NONE EVEN ODD

Stop Bit 1 2

Flow Control NONE ER[DTR/CTS] XON/XOFF

Timeout (sec)

Retry

Wait To Send (ms)

RI / VCC RI VCC

In the case of RS232C, you can select the 9th pin to RI (Input) or VCC (5V Power Supply). If you use the Digital's RS232C Isolation Unit, please select it to VCC.

Device-Specific Settings

Number	Device Name	Settings
1	PLC1	Series=TC200 Series,PC No.=64

◆ Device Setting

To display the setting screen, click  ([Setting]) of External Device you want to set from [Device-Specific Settings] of [Device/PLC Settings].

Individual Device Settings

PLC1

Series

Please reconfirm all of address settings that you are using if you have changed the series.

PC No.

■ Settings of External Device

Communication setting of External Device by ladder software (TCPRGOS-W (J)).

Please refer to the manual of the External Device for more details.

◆ Procedure

- 1 Start the ladder software of the computer.
- 2 Select [Register editor] in the [Tool] menu.
[Register data [online]] window is displayed.
- 3 Click [A].
- 4 Double click the special auxiliary relay (A00F) to set communication speed.

Communication speed	A00F
9600bps	OFF

NOTE

- The other setting of communication speed is as follows.

Communication speed	A00F
19200bps	ON

3.4 Setting Example 4

■ Settings of GP-Pro EX

◆ Communication Settings

To display the setting screen, select [Device/PLC Settings] from [System setting window] in workspace.

◆ Device Setting

To display the setting screen, click  ([Setting]) of External Device you want to set from [Device-Specific Settings] of [Device/PLC Settings].

When you connect multiple External Device, click  from [Device-Specific Settings] of [Device/PLC Settings] to add another External Device.

■ Settings of External Device

Set PC No. of the External Device using DIP switches and the rotary switch of External Device.

Please refer to the manual of the External Device for more details.

After setting, reboot the External Device to enable the setting.

◆ Setup Items

- DIP switch

DIP switch	Settings ^{*1}	Setup Description
SW1	OFF	Set PC No. by combining with the rotary switch.
SW2	OFF	
SW3	ON	Link Master
SW4	OFF	Link Slave
SW5	OFF	Remote Master
SW6	OFF	Remote Slave

*1 For SW3 to SW6, if two or more than two switches are turned on, there will be a set error.
SW3 must be turned ON when connect to Display.

- Rotary switch

Settings	Setup Description
0	PC No.

NOTE

- Set PC No. using DIP switches 1 and 2 and the rotary switch.
Combination of possible settings is as follows.

DIP switch		PC No. that can be set with the rotary switch
SW1	SW2	
OFF	OFF	0 - 15
OFF	ON	16 - 31
ON	OFF	32 - 47
ON	ON	48 - 63

◆ Caution

In the case of a 1:n connection, the terminating resistance switch and shield grounding switch need to be set.

- Setting of the terminating resistance switch (ON/OFF) (LINE T)

Always turn on the terminating resistance on both end stations of the communication circuit. Always turn off the terminating resistance of the way station.

IMPORTANT

- Turning off the terminating resistance on both end stations or turning on the terminating resistance of the way station disables normal communication.

- Setting of the shield grounding switch (grounding/isolating) (LINE G) of communication cable

Turn on the shield grounding switch (grounding) on the shield side of the communication cable.

IMPORTANT

If there is 4V or more grounding electric potential difference between the other control panel and this module control panel, take the following steps.

- Turn off the shield grounding switch (isolating).
- If the total extension of communication cable exceeds 100m, turn on one or more switch(es) (grounding) every 100m. Select a place with 4V or lower grounding electric potential difference for grounding.
- If the total extension of the communication cable is 100m or less, turn on a switch (grounding) in the intermediate position.

3.5 Setting Example 5

■ Settings of GP-Pro EX

◆ Communication Settings

To display the setting screen, select [Device/PLC Settings] from [System setting window] in workspace.

Device/PLC 1

Summary [Change Device/PLC](#)

Maker: TOSHIBA MACHINE CO., LTD. Series: PROVISOR TC200 Port: COM1

Text Data Mode: 4 [Change](#)

Communication Settings

SIQ Type: RS232C RS422/485(2wire) RS422/485(4wire)

Speed: 9600

Data Length: 7 8

Parity: NONE EVEN ODD

Stop Bit: 1 2

Flow Control: NONE ER(DTR/CTS) XON/XOFF

Timeout: 3 (sec)

Retry: 2

Wait To Send: 0 (ms)

RI / VCC: RI VCC

In the case of RS232C, you can select the 9th pin to RI (Input) or VCC (5V Power Supply). If you use the Digital's RS232C Isolation Unit, please select it to VCC.

Default

Device-Specific Settings

Allowable Number of Devices/PLCs: 16

Number	Device Name	Settings
1	PLC1	Series=TC200S Series.PC No.=0

◆ Device Setting

To display the setting screen, click ([Setting]) of External Device you want to set from [Device-Specific Settings] of [Device/PLC Settings].

When you connect multiple External Device, click from [Device-Specific Settings] of [Device/PLC Settings] to add another External Device.

Individual Device Settings

PLC1

Series: TC200S Series

Please reconfirm all of address settings that you are using if you have changed the series.

PC No.: 0

Default

OK (O) Cancel

■ Settings of External Device

Set PC No. of the External Device using DIP switches and the rotary switch of External Device.

Please refer to the manual of the External Device for more details.

After setting, reboot the External Device to enable the setting.

◆ Setup Items

- DIP switch

DIP switch	Settings ^{*1}	Setup Description
SW1	OFF	Set PC No. by combining with the rotary switch.
SW2	OFF	
SW3	ON	Link Master
SW4	OFF	Link Slave
SW5	OFF	Remote Master
SW6	OFF	Remote Slave

*1 For SW3 to SW6, if two or more than two switches are turned on, there will be a set error.
SW3 must be turned ON when connect to Display.

- Rotary switch

Settings	Setup Description
0	PC No.

NOTE

- Set PC No. using DIP switches 1 and 2 and the rotary switch.
Combination of possible settings is as follows.

DIP switch		PC No. that can be set with the rotary switch
SW1	SW2	
OFF	OFF	0 - 15
OFF	ON	16 - 31
ON	OFF	32 - 47
ON	ON	48 - 63

3.6 Setting Example 6

■ Settings of GP-Pro EX

◆ Communication Settings

To display the setting screen, select [Device/PLC Settings] from [System setting window] in workspace.

Device/PLC 1

Summary [Change Device/PLC](#)

Maker Series Port

Text Data Mode [Change](#)

Communication Settings

SI0 Type RS232C RS422/485(2wire) RS422/485(4wire)

Speed

Data Length 7 8

Parity NONE EVEN ODD

Stop Bit 1 2

Flow Control NONE ER[DTR/CTS] XON/XOFF

Timeout (sec)

Retry

Wait To Send (ms)

RI / VCC RI VCC

In the case of RS232C, you can select the 9th pin to RI (Input) or VCC (5V Power Supply). If you use the Digital's RS232C Isolation Unit, please select it to VCC.

Device-Specific Settings

Allowable Number of Devices/PLCs 16

Number	Device Name	Settings
1	PLC1	<input type="button" value="Settings"/> Series=TC200S Series,PC No.=64

◆ Device Setting

To display the setting screen, click  ([Setting]) of External Device you want to set from [Device-Specific Settings] of [Device/PLC Settings].

Individual Device Settings

PLC1

Series

Please reconfirm all of address settings that you are using if you have changed the series.

PC No.

■ Settings of External Device

Communication setting of External Device by ladder software (TCPRGOS-W (J)).

Please refer to the manual of the External Device for more details.

◆ Procedure

- 1 Start the ladder software of the computer.
- 2 Select [Register editor] in the [Tool] menu.
[Register data [online]] window is displayed.
- 3 Click [A].
- 4 Double click the special auxiliary relay (A00F, A154, A155) to set communication speed.

Communication speed	A00F	A154	A155
9600bps	OFF	OFF	OFF

NOTE

- The other settings of communication speed is as follows.

Communication speed	A00F	A154	A155
19200bps	ON	OFF	OFF
38400bps	*1	ON	OFF
57600bps		OFF	ON
115200bps		ON	ON

*1 Either ON or OFF can be set.

3.7 Setting Example 7

■ Settings of GP-Pro EX

◆ Communication Settings

To display the setting screen, select [Device/PLC Settings] from [System setting window] in workspace.

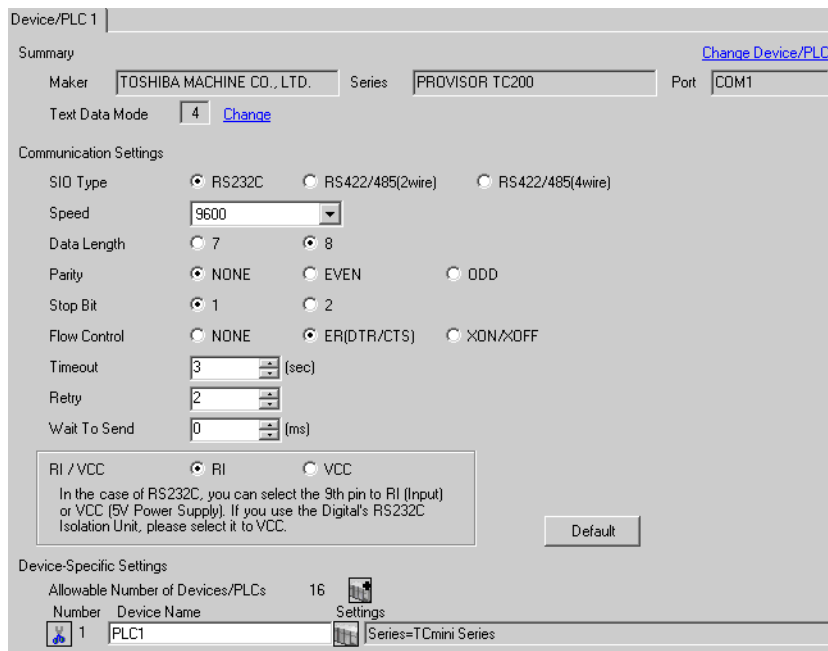

◆ Device Setting

To display the setting screen, click  ([Setting]) of External Device you want to set from [Device-Specific Settings] of [Device/PLC Settings].



◆ Caution

When the TCmini series is used, please be sure to set a stop bit as "1."

■ Settings of External Device

There is no setting for the External Device side. The communication speed automatically switches in accordance with the setting of the Display.

4 Setup Items

Set communication settings of the Display with GP-Pro EX or in off-line mode of the Display.

The setting of each parameter must be identical to that of External Device.

 "3 Example of Communication Setting" (page 7)

4.1 Setup Items in GP-Pro EX

■ Communication Settings

To display the setting screen, select [Device/PLC Settings] from [System setting window] in workspace.

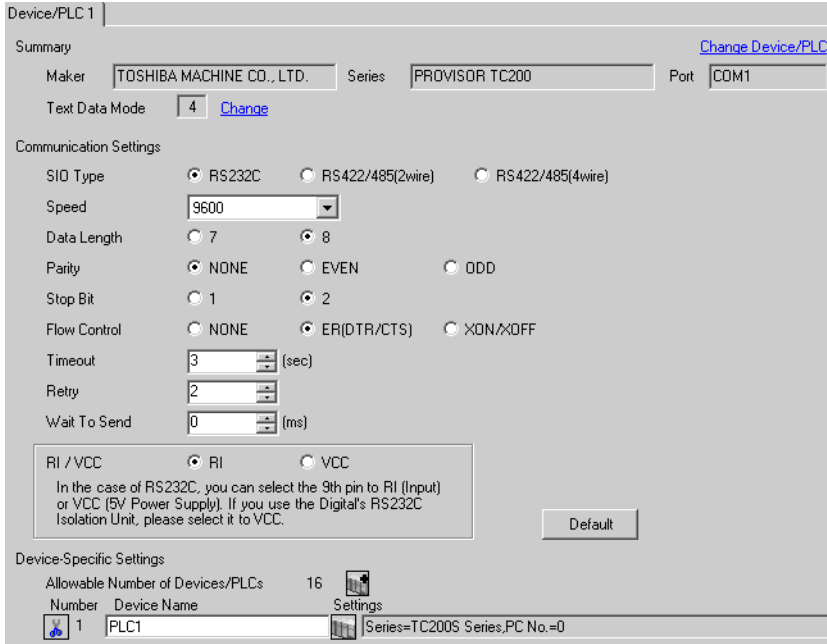

Device/PLC 1

Summary [Change Device/PLC](#)

Maker Series Port

Text Data Mode [Change](#)

Communication Settings

SIO Type RS232C RS422/485(2wire) RS422/485(4wire)

Speed

Data Length 7 8

Parity NONE EVEN ODD

Stop Bit 1 2

Flow Control NONE ER(DTR/CTS) XON/XOFF

Timeout (sec)

Retry

Wait To Send (ms)

RI / VCC RI VCC

In the case of RS232C, you can select the 9th pin to RI (Input) or VCC (5V Power Supply). If you use the Digital's RS232C Isolation Unit, please select it to VCC.

Device-Specific Settings

Allowable Number of Devices/PLCs 

Number Device Name 

Setup Items	Setup Description
SIO Type	Select the SIO type to communicate with the External Device.
Speed	Select speed between the External Device and the Display.
Data Length	Select data length.
Parity	Select how to check parity.
Stop Bit	Select stop bit length.
Flow Control	Select the communication control method to prevent overflow of transmission and reception data.
Timeout	Use an integer from 1 to 127 to enter the time (s) for which the Display waits for the response from the External Device.
Retry	In case of no response from the External Device, use an integer from 0 to 255 to enter how many times the Display retransmits the command.
Wait To Send	Use an integer from 0 to 255 to enter standby time (ms) for the Display from receiving packets to transmitting next commands.
RI/VCC	You can switch RI/VCC of the 9th pin when you select RS232C for SIO type. It is necessary to change RI/5V by changeover switch of IPC when connect with IPC. Please refer to the manual of the IPC for more detail.

■ Device Setting

To display the setting screen, click  ([Setting]) of External Device you want to set from [Device-Specific Settings] of [Device/PLC Settings].

When you connect multiple External Device, click  from [Device-Specific Settings] of [Device/PLC Settings] to add another External Device.



Setup Items	Setup Description
Series	Select the External Device series.
PC No	Use an integer from 0 to 64 to enter the PC No. of the External Device. *1

- *1 In the case of TC200 series or TC200S series, set "0 to 63" when using a communication module, and set "64" when using RS-232C connector on CPU.
In the case of a TCmini series, the PC number cannot be set.

4.2 Setup Items in Off-Line Mode

NOTE

- Refer to the Maintenance/Troubleshooting manual for information on how to enter off-line mode or about the operation.

Cf. Maintenance/Troubleshooting Manual "2.2 Off-line Mode"

■ Communication Settings

To display the setting screen, touch [Device/PLC Settings] from [Peripheral Settings] in off-line mode. Touch the External Device you want to set from the displayed list.

Comm.	Device	Option		
PROVISOR TC200			[COM1]	Page 1/1
SIO Type		RS232C		
Speed		9600		
Data Length		<input type="radio"/> 7 <input checked="" type="radio"/> 8		
Parity		<input checked="" type="radio"/> NONE <input type="radio"/> EVEN <input type="radio"/> ODD		
Stop Bit		<input type="radio"/> 1 <input checked="" type="radio"/> 2		
Flow Control		NONE		
Timeout(s)		3	▼ ▲	
Retry		2	▼ ▲	
Wait To Send(ms)		0	▼ ▲	
	Exit		Back	2007/04/01 22:16:58

Setup Items	Setup Description
SIO Type	Select the SIO type to communicate with the External Device. IMPORTANT To make the communication settings correctly, confirm the serial interface specifications of Display unit for [SIO Type]. We cannot guarantee the operation if a communication type that the serial interface does not support is specified. For details concerning the serial interface specifications, refer to the manual for Display unit.
Speed	Select speed between the External Device and the Display.
Data Length	Select data length.
Parity	Select how to check parity.
Stop Bit	Select stop bit length.
Flow Control	Select the communication control method to prevent overflow of transmission and reception data.
Timeout	Use an integer from 1 to 127 to enter the time (s) for which the Display waits for the response from the External Device.

Continues to the next page.

Setup Items	Setup Description
Retry	In case of no response from the External Device, use an integer from 0 to 255 to enter how many times the Display retransmits the command.
Wait To Send	Use an integer from 0 to 255 to enter standby time (ms) for the Display from receiving packets to transmitting next commands.

■ Device Setting

To display the setting screen, touch [Device/PLC Settings] from [Peripheral Settings]. Touch the External Device you want to set from the displayed list, and touch [Device].

Comm.	Device	Option		
PROVISOR TC200			[COM1]	Page 1/1
Device/PLC Name	[PLC1] ▼			
Series	TC200 Series			
PC No.	[] 0 ▼ ▲			
	Exit		Back	2007/04/01 22:17:00

Setup Items	Setup Description
Device/PLC name	Select the External Device to set. Device name is a title of the External Device set with GP-Pro EX. (Initial value [PLC1])
Series	Display the External Device series.
PC No.	Enter the PC No. of the External Device.*1

*1 In the case of TC200 series or TC200S series, set "0 to 63" when using a communication module, and set "64" when using RS-232C connector on CPU.
In the case of a TCmini series, the PC number cannot be set.

■ Option

To display the setting screen, touch [Device/PLC Settings] from [Peripheral Equipment Settings]. Touch the External Device you want to set from the displayed list, and touch [Option].

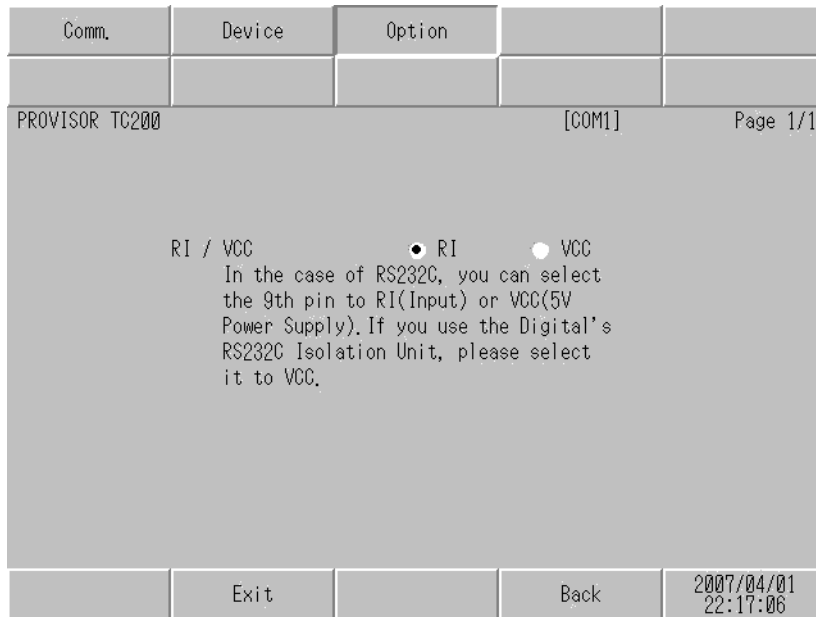

Setup Items	Setup Description
RI/VCC	Switches RI/VCC of the 9th pin. It is necessary to change RI/5V by changeover switch of IPC when connect with IPC. Please refer to the manual of the IPC for more detail.

5 Cable Diagram

The cable diagram shown below may be different from the cable diagram recommended by TOSHIBA MACHINE CO., LTD.. Please be assured there is no operational problem in applying the cable diagram shown in this manual.

- The FG pin of the External Device body must be D-class grounded. Please refer to the manual of the External Device for more details.
- SG and FG are connected inside the Display. When connecting SG to the External Device, design the system not to form short-circuit loop.
- Connect the isolation unit, when communication is not stabilized under the influence of a noise etc.

Cable Diagram 1

Display (Connection Port)	Cable	Notes
GP (COM1) ST (COM1) IPC*1 PC/AT	Your own cable	The cable length must be 15m or less.

*1 Only the COM port which can communicate by RS-232C can be used.

 ■ "COM Port of IPC" (page 4)

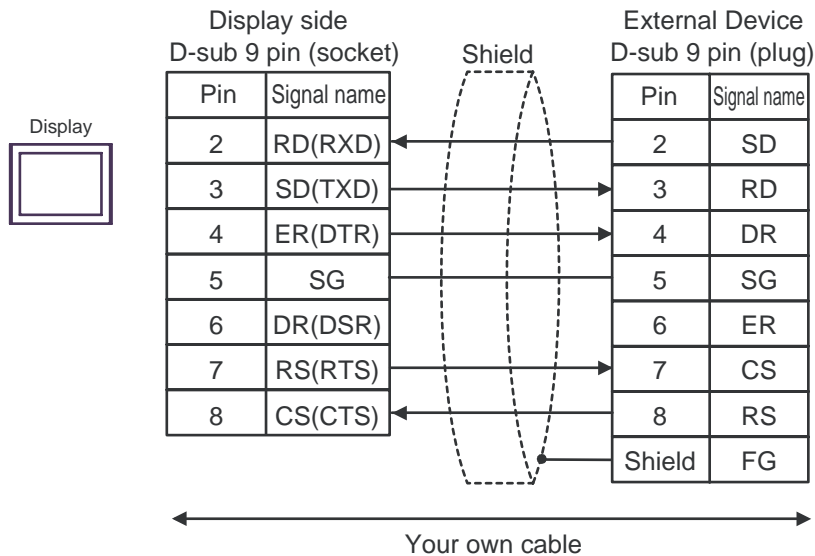

Cable Diagram 2

Display (Connection Port)	Cable	Notes
GP (COM1) ST (COM1) IPC* ¹ PC/AT	Your own cable	The cable length must be 15m or less.

*1 Only the COM port which can communicate by RS-232C can be used.

 "■ COM Port of IPC" (page 4)

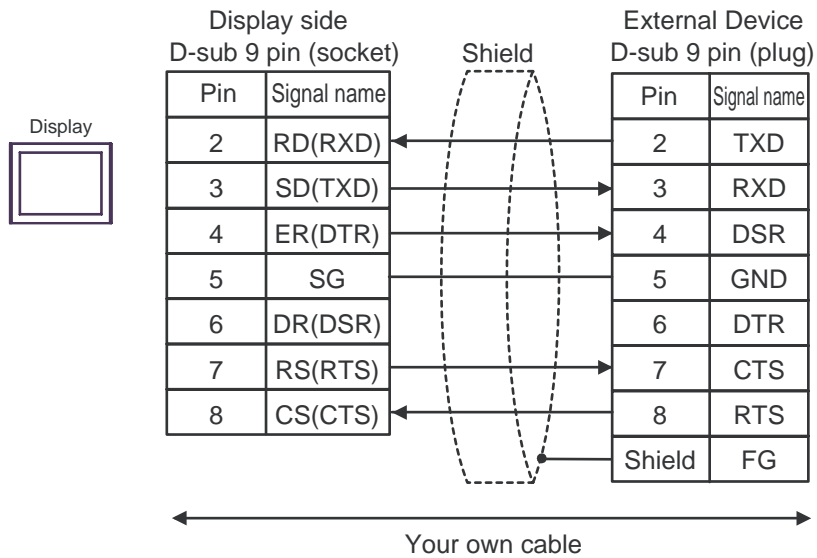







6 Supported Device

Range of supported device address is shown in the table below. Please note that the actually supported range of the devices varies depending on the External Device to be used. Please check the actual range in the manual of your connecting equipment.

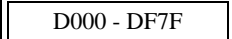
6.1 TC200 series

 This address can be specified as system data area.

Device	Bit Address	Word Address	32 bits	Notes
Input Relay 1	X000 - XF7F	X00W - XF7W		*1
Output Relay 1	Y000 - YF7F	Y00W - YF7W		*1
Internal Relay	R000 - R77F	R00W - R77W		*1
Extended Internal Relay 1	G000 - GF7F	G00W - GF7W		*1
Extended Internal Relay 2	H000 - HF7F	H00W - HF7W		*1
Special AUX Relay	A000 - A16F	A00W - A16W		*1
Latch Relay	L000 - L07F	L00W - L07W		*1
Shift Register	S000 - S07F	S00W - S07W		*1
Edge Relay	E000 - E77F	E00W - E77W		*1
Timer (contact)	T000 - T77F	T00W - T77W		*1 *2
Counter (contact)	C000 - C77F	C00W - C77W		*1 *3
Timer/Counter (current value)	-----	P000 - P77F		 *1
Timer/Counter (setup value)	-----	V000 - V77F		 *1
Generic Register 1	-----	 D000 - DF7F		 *1
Generic Register 2	-----	 B000 - BF7F	 *1	

*1 Device format is as follows:
Please refer to the manual of external device for more detail.

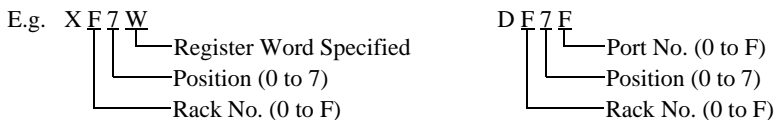

*2 The addresses of the timer (contact) range from T00W to T77W, however the internal memory area is not consecutive. This range is divided into two areas, e.g., T00W to T37W and T40W to T77W.

*3 The addresses of the counter (contact) range from C00W to C77W, however the internal memory area is not consecutive. This range is divided into two areas, e.g., C00W to C37W and C40W to C77W.











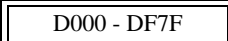

NOTE

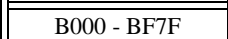
- Please refer to the GP-Pro EX Reference Manual for system data area.
Cf. GP-Pro EX Reference Manual "Appendix 1.4 LS Area (Direct Access Method)"
- Please refer to the precautions on manual notation for icons in the table.

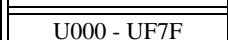
 "Manual Symbols and Terminology"

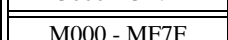
6.2 TC200S series

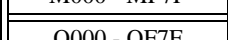
 This address can be specified as system data area.

Device	Bit Address	Word Address	32 bits	Notes
Input Relay 1	X000 - XF7F	X00W - XF7W	L / H	*1
Input Relay 2	I000 - IF7F	I00W - IF7W		*1
Output Relay 1	Y000 - YF7F	Y00W - YF7W		*1
Output Relay 2	O000 - OF7F	O00W - OF7W		*1
Internal Relay	R000 - R77F	R00W - R77W		*1
Extended Internal Relay 1	G000 - GF7F	G00W - GF7W		*1
Extended Internal Relay 2	H000 - HF7F	H00W - HF7W		*1
Extended Internal Relay 3	J000 - JF7F	J00W - JF7W		*1
Extended Internal Relay 4	K000 - KF7F	K00W - KF7W		*1
Special AUX Relay	A000 - A16F	A00W - A16W		*1
Latch Relay	L000 - L07F	L00W - L07W		*1
Shift Register	S000 - S07F	S00W - S07W		*1
Edge Relay	E000 - E77F	E00W - E77W		*1
Timer (contact)	T000 - T77F	T00W - T77W		*1 *2
Counter (contact)	C000 - C77F	C00W - C77W		*1 *3
Timer/Counter (current value)	-----	P000 - P77F		 *1
Timer/Counter (setup value)	-----	V000 - V77F		 *1
Generic Register 1	-----	 D000 - DF7F		 *1
Generic Register 2	-----	 B000 - BF7F		 *1
Generic Register 3	-----	 U000 - UF7F		 *1
Generic Register 4	-----	 M000 - MF7F	 *1	
Generic Register 5	-----	 Q000 - QF7F	 *1	

*1 Device format is as follows:
Please refer to the manual of external device for more detail.

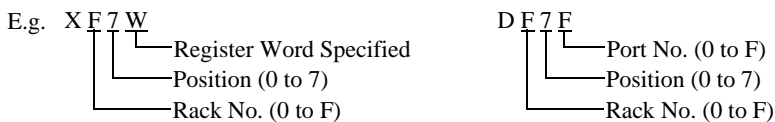

*2 The addresses of the timer (contact) range from T00W to T77W, however the internal memory area is not consecutive. This range is divided into two areas, e.g., T00W to T37W and T40W to T77W.

*3 The addresses of the counter (contact) range from C00W to C77W, however the internal memory area is not consecutive. This range is divided into two areas, e.g., C00W to C37W and C40W to C77W.

NOTE

- Please refer to the GP-Pro EX Reference Manual for system data area.
Cf. GP-Pro EX Reference Manual "Appendix 1.4 LS Area (Direct Access Method)"
- Please refer to the precautions on manual notation for icons in the table.
 "Manual Symbols and Terminology"

6.3 TCmini series

■ TC8-00/TC5-02

 This address can be specified as system data area.

Device		Bit Address	Word Address	32 bits	Notes
External Input Relay	Photo coupler	X000 - X00F	X00W - X00W	L/H	*1
	Dip Switch	X010 - X017	X01W - X01W		*1
	Extended Panel Switch	X100 - X11F	X10W - X11W		*1
External Output Relay	Transistor	Y020 - Y02B	Y02W - Y02W		*1
	Relay Contact	Y02C - Y02F	Y02W - Y02W		*1
	Extended Panel LED	Y140 - Y14F	Y14W - Y14W		*1
Internal Relay		R000 - R77F	R00W - R77W		*1
Edge Relay		E000 - E17F	E00W - E17W		*1
Latch Relay		L000 - L07F	L00W - L07W		*1
Timer Relay		T000 - T27F	T00W - T27W		*1
Counter Relay		C000 - C27F	C00W - C27W		*1
Special AUX Relay		A000 - A16F	A00W - A16W		*1
Data Register		-----	D000 - D77F		Bit F *1
T/C Register 1		-----	P000 - P27F	Bit F *1	
T/C Register 2		-----	V000 - V27F	Bit F *1	

*1 Device format is as follows:
Please refer to the manual of external device for more detail.

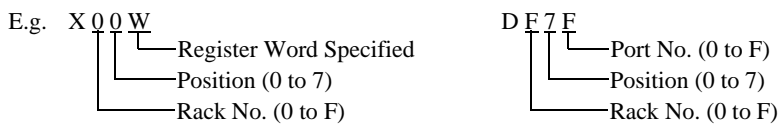

NOTE

- Please refer to the GP-Pro EX Reference Manual for system data area.
Cf. GP-Pro EX Reference Manual "Appendix 1.4 LS Area (Direct Access Method)"
- Please refer to the precautions on manual notation for icons in the table.
☞ "Manual Symbols and Terminology"

■ TC6-00

 This address can be specified as system data area.

Device		Bit Address	Word Address	32 bits	Notes
External Input Relay	Photo coupler	X000 - X00F	X00W - X00W	L/H	*1
	Push-button switch	X100 - X11F	X10W - X11W		*1
External Output Relay	Relay	Y020 - Y02F	Y02W - Y02W		*1
	Panel LED	Y160 - Y16F	Y16W - Y16W		*1
External Input Output Relay		X030 - X13F	X03W - X13W		*1
		X148 - XF7F	X14W - XF7W		*1
		Y030 - Y13F	Y03W - Y13W		*1
		Y148 - YF7F	Y14W - YF7W		*1
		I000 - IF7F	I00W - IF7W		*1
		O000 - OF7F	O00W - OF7W		*1
Internal Relay		R000 - R77F	R00W - R77W		*1
Extended Internal Relay 1		G000 - GF7F	G00W - GF7W		*1
Extended Internal Relay 2		H000 - HF7F	H00W - HF7W		*1
Extended Internal Relay 3		J000 - JF7F	J00W - JF7W		*1
Extended Internal Relay 4		K000 - KF7F	K00W - KF7W		*1
Edge Relay		E000 - E77F	E00W - E77W		*1
Latch Relay		L000 - L07F	L00W - L07W		*1
Shift Register		S000 - S07F	S00W - S07W		*1
Timer Relay		T000 - T77F	T00W - T77W		*1
Counter Relay		C000 - C77F	C00W - C77W		*1
T/C Register 1		-----	P000 - P77F	Bit F *1	
T/C Register 2		-----	V000 - V77F	Bit F *1	
Generic Register 1		-----	D000- DF7F	Bit F *1	
Generic Register 2		-----	B000- BF7F	Bit F *1	
Generic Register 3		-----	U000- UF7F	Bit F *1	
Generic Register 4		-----	M000- MF7F	Bit F *1	
Generic Register 5		-----	Q000- QF7F	Bit F *1	

*1 Device format is as follows:
Please refer to the manual of external device for more detail.

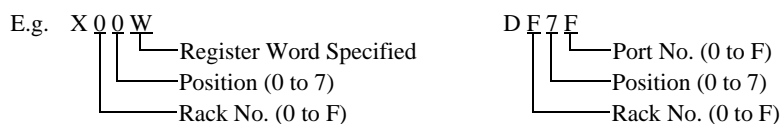

NOTE

- Please refer to the GP-Pro EX Reference Manual for system data area.
Cf. GP-Pro EX Reference Manual "Appendix 1.4 LS Area (Direct Access Method)"
- Please refer to the precautions on manual notation for icons in the table.
☞ "Manual Symbols and Terminology"

■ TC3-01

 This address can be specified as system data area.

Device	Bit Address	Word Address	32 bits	Notes
External Input Relay	X000 - X00B	X00W - X00W	L / H	*1
External Output Relay	Y000 - Y00B	Y00W - Y00W		*1
Internal Relay	R000 - R17F	R00W - R17W		*1
Timer Relay	T000 - T05F	T00W - T05W		*1
Counter Relay	C000 - C05F	C00W - C05W		*1
Latch Relay	L000 - L01F	L00W - L01W		*1
Data Register	-----	D000 - D22F		Bit F *1
T/C Register 1	-----	P000 - P05F	Bit F *1	
T/C Register 2	-----	V000 - V05F	Bit F *1	

*1 Device format is as follows:
Please refer to the manual of external device for more detail.

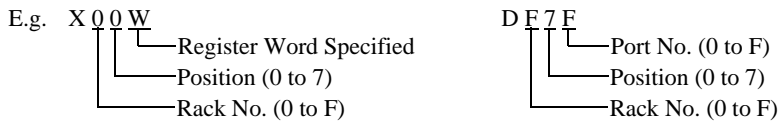

NOTE

- Please refer to the GP-Pro EX Reference Manual for system data area.
Cf. GP-Pro EX Reference Manual "Appendix 1.4 LS Area (Direct Access Method)"
- Please refer to the precautions on manual notation for icons in the table.
☞ "Manual Symbols and Terminology"

■ TC3-02

 This address can be specified as system data area.

Device	Bit Address	Word Address	32 bits	Notes
External Input Relay	X000 - X00F	X00W - X00W	L / H	*1
External Output Relay	Y000 - Y00F	Y00W - Y00W		*1
Internal Relay	R000 - R37F	R00W - R37W		*1
Timer Relay	T000 - T13F	T00W - T13W		*1
Counter Relay	C000 - C13F	C00W - C13W		*1
Latch Relay	L000 - L03F	L00W - L03W		*1
Data Register	-----	D000 - D24C		Bit F *1
T/C Register 1	-----	P000 - P13F		Bit F *1
T/C Register 2	-----	V000 - V15F		Bit F *1

*1 Device format is as follows:
Please refer to the manual of external device for more detail.

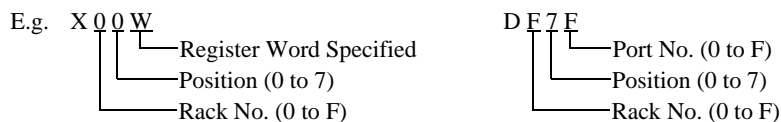

NOTE

- Please refer to the GP-Pro EX Reference Manual for system data area.
Cf. GP-Pro EX Reference Manual "Appendix 1.4 LS Area (Direct Access Method)"
- Please refer to the precautions on manual notation for icons in the table.
☞ "Manual Symbols and Terminology"

7 Device Code and Address Code

Use device code and address code when you select "Device Type & Address" for the address type in data displays.

7.1 TC200 series

Device	Device Name	Device Code (HEX)	Address Code ^{*1}
Input Relay 1	X	0080	Rack No. × 0x08 + Position
Output Relay 1	Y	0082	Rack No. × 0x08 + Position
Internal Relay	R	0084	Rack No. × 0x08 + Position
Extended Internal Relay 1	G	0085	Rack No. × 0x08 + Position
Extended Internal Relay 2	H	0086	Rack No. × 0x08 + Position
Special AUX Relay	A	0089	Rack No. × 0x08 + Position
Latch Relay	L	008A	Rack No. × 0x08 + Position
Shift Register	S	008B	Rack No. × 0x08 + Position
Edge Relay	E	008C	Rack No. × 0x08 + Position
Timer (contact)	T	008D	Rack No. × 0x08 + Position
Counter (contact)	C	008E	Rack No. × 0x08 + Position
Timer/Counter (current value)	P	0002	Rack No. × 0x08 + Position
Timer/Counter (setup value)	V	0003	Rack No. × 0x08 + Position
Generic Register 1	D	0000	Rack No. × 0x08 + Position
Generic Register 2	B	0001	Rack No. × 0x08 + Position

*1 Please refer to the *1 in "6 Supported Device" for the Rack No. and the Position.

7.2 TC200S series

Device	Device Name	Device Code (HEX)	Address Code *1
Input Relay 1	X	0080	Rack No. × 0x08 + Position
Input Relay 2	I	0081	Rack No. × 0x08 + Position
Output Relay 1	Y	0082	Rack No. × 0x08 + Position
Output Relay 2	O	0083	Rack No. × 0x08 + Position
Internal Relay	R	0084	Rack No. × 0x08 + Position
Extended Internal Relay 1	G	0085	Rack No. × 0x08 + Position
Extended Internal Relay 2	H	0086	Rack No. × 0x08 + Position
Extended Internal Relay 3	J	0087	Rack No. × 0x08 + Position
Extended Internal Relay 4	K	0088	Rack No. × 0x08 + Position
Special AUX Relay	A	0089	Rack No. × 0x08 + Position
Latch Relay	L	008A	Rack No. × 0x08 + Position
Shift Register	S	008B	Rack No. × 0x08 + Position
Edge Relay	E	008C	Rack No. × 0x08 + Position
Timer (contact)	T	008D	Rack No. × 0x08 + Position
Counter (contact)	C	008E	Rack No. × 0x08 + Position
Timer/Counter (current value)	P	0002	Rack No. × 0x08 + Position
Timer/Counter (setup value)	V	0003	Rack No. × 0x08 + Position
Generic Register 1	D	0000	Rack No. × 0x08 + Position
Generic Register 2	B	0001	Rack No. × 0x08 + Position
Generic Register 3	U	0004	Rack No. × 0x08 + Position
Generic Register 4	M	0005	Rack No. × 0x08 + Position
Generic Register 5	Q	0006	Rack No. × 0x08 + Position

*1 Please refer to the *1 in "6 Supported Device" for the Rack No. and the Position.

7.3 TCmini series

■ TC8-00/TC5-02

Device	Device Name	Device Code (HEX)	Address Code *1
Input Relay 1	X	0080	Rack No. × 0x08 + Position
Output Relay 1	Y	0082	Rack No. × 0x08 + Position
Internal Relay	R	0084	Rack No. × 0x08 + Position
Special AUX Relay	A	0089	Rack No. × 0x08 + Position
Latch Relay	L	008A	Rack No. × 0x08 + Position
Edge Relay	E	008C	Rack No. × 0x08 + Position
Timer (contact)	T	008D	Rack No. × 0x08 + Position
Counter (contact)	C	008E	Rack No. × 0x08 + Position
T/C Register 1	P	0002	Rack No. × 0x08 + Position
T/C Register 2	V	0003	Rack No. × 0x08 + Position
Data Register	D	0000	Rack No. × 0x08 + Position

*1 Please refer to the *1 in "6 Supported Device" for the Rack No. and the Position.

■ TC6-00

Device	Device Name	Device Code (HEX)	Address Code *1
Input Relay 1	X	0080	Rack No. × 0x08 + Position
Input Relay 2	I	0081	Rack No. × 0x08 + Position
Output Relay 1	Y	0082	Rack No. × 0x08 + Position
Output Relay 2	O	0083	Rack No. × 0x08 + Position
Internal Relay	R	0084	Rack No. × 0x08 + Position
Extended Internal Relay 1	G	0085	Rack No. × 0x08 + Position
Extended Internal Relay 2	H	0086	Rack No. × 0x08 + Position
Extended Internal Relay 3	J	0087	Rack No. × 0x08 + Position
Extended Internal Relay 4	K	0088	Rack No. × 0x08 + Position
Latch Relay	L	008A	Rack No. × 0x08 + Position
Shift Register	S	008B	Rack No. × 0x08 + Position
Edge Relay	E	008C	Rack No. × 0x08 + Position
Timer (contact)	T	008D	Rack No. × 0x08 + Position
Counter (contact)	C	008E	Rack No. × 0x08 + Position
Timer/Counter (current value)	P	0002	Rack No. × 0x08 + Position
Timer/Counter (setup value)	V	0003	Rack No. × 0x08 + Position
Generic Register 1	D	0000	Rack No. × 0x08 + Position

Continues to the next page.

Device	Device Name	Device Code (HEX)	Address Code *1
Generic Register 2	B	0001	Rack No. × 0x08 + Position
Generic Register 3	U	0004	Rack No. × 0x08 + Position
Generic Register 4	M	0005	Rack No. × 0x08 + Position
Generic Register 5	Q	0006	Rack No. × 0x08 + Position

*1 Please refer to the *1 in "6 Supported Device" for the Rack No. and the Position.

■ TC3-01

Device	Device Name	Device Code (HEX)	Address Code *1
Input Relay 1	X	0080	Rack No. × 0x08 + Position
Output Relay 1	Y	0082	Rack No. × 0x08 + Position
Internal Relay	R	0084	Rack No. × 0x08 + Position
Latch Relay	L	008A	Rack No. × 0x08 + Position
Timer (contact)	T	008D	Rack No. × 0x08 + Position
Counter (contact)	C	008E	Rack No. × 0x08 + Position
T/C Register 1	P	0002	Rack No. × 0x08 + Position
T/C Register 2	V	0003	Rack No. × 0x08 + Position
Data Register	D	0000	Rack No. × 0x08 + Position

*1 Please refer to the *1 in "6 Supported Device" for the Rack No. and the Position.

■ TC3-02

Device	Device Name	Device Code (HEX)	Address Code *1
Input Relay 1	X	0080	Rack No. × 0x08 + Position
Output Relay 1	Y	0082	Rack No. × 0x08 + Position
Internal Relay	R	0084	Rack No. × 0x08 + Position
Latch Relay	L	008A	Rack No. × 0x08 + Position
Timer (contact)	T	008D	Rack No. × 0x08 + Position
Counter (contact)	C	008E	Rack No. × 0x08 + Position
T/C Register 1	P	0002	Rack No. × 0x08 + Position
T/C Register 2	V	0003	Rack No. × 0x08 + Position
Data Register	D	0000	Rack No. × 0x08 + Position

*1 Please refer to the *1 in "6 Supported Device" for the Rack No. and the Position.

8 Error Messages

Error messages are displayed on the screen of Display as follows: "No. : Device Name: Error Message (Error Occurrence Area)". Each description is shown below.

Item	Description
No.	Error No.
Device Name	Name of External Device where error occurs. Device name is a title of External Device set with GP-Pro EX. (Initial value [PLC1])
Error Message	Displays messages related to the error which occurs.
Error Occurrence Area	<p>Displays IP address or device address of External Device where error occurs, or error codes received from External Device.</p> <p>NOTE</p> <ul style="list-style-type: none"> • IP address is displayed such as "IP address (Decimal): MAC address (Hex)". • Device address is displayed such as "Address: Device address". • Received error codes are displayed such as "Decimal [Hex]".

Display Examples of Error Messages

"RHAA035: PLC1: Error has been responded for device write command (Error Code: 2 [02H])"

NOTE

- Refer to your External Device manual for details on received error codes.
- Refer to "When an error is displayed (Error Code List)" in "Maintenance/Troubleshooting Manual" for details on the error messages common to the driver.