

12 | Windows

This chapter explains the "Window Display" feature in GP-Pro EX and the basic management information. Please start by reading "12.1 Settings Menu" (page 12-2) and then turn to the corresponding page.

12.1	Settings Menu	12-2
12.2	Creating Windows	12-4
12.3	Displaying Windows	12-7
12.4	Changing the Displayed Window	12-11
12.5	Displaying the Same Window on All Screens	12-14
12.6	Changing the Displayed Window on All Screens	12-17
12.7	Window Part Settings Guide	12-21
12.8	Restrictions for Windows	12-29

12.1 Settings Menu

Creating Windows

Create and register the contents to display on the Window.

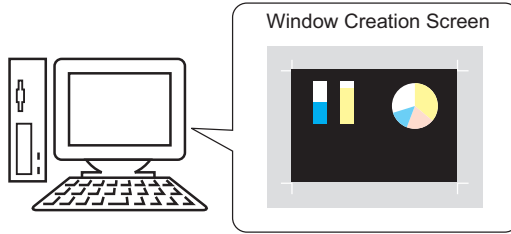

- ☞ Setup Procedure (page 12-5)
- ☞ Introduction (page 12-4)

Displaying Windows

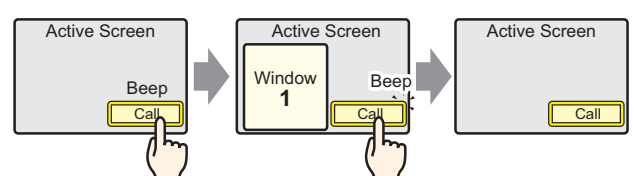

Touch and...

The Window is called and displayed. Check the Window, touch the switch again and...

The Window disappears.

- ☞ Setup Procedure (page 12-8)
- ☞ Introduction (page 12-7)

Changing the Displayed Window

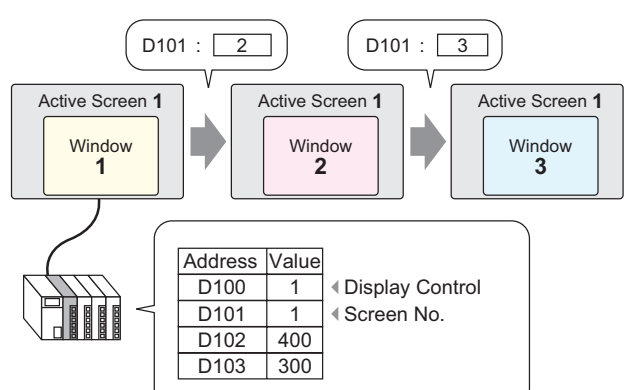

Address	Value	
D100	1	◀ Display Control
D101	1	◀ Screen No.
D102	400	
D103	300	

- ☞ Setup Procedure (page 12-12)
- ☞ Introduction (page 12-11)

Displaying the Same Window on All Screens

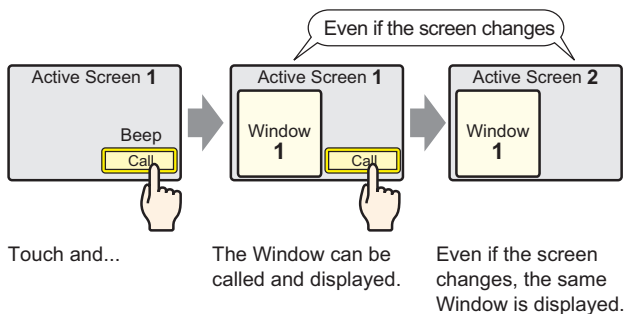

- ☞ Setup Procedure (page 12-15)
- ☞ Introduction (page 12-14)

Changing the Displayed Window on All Screens

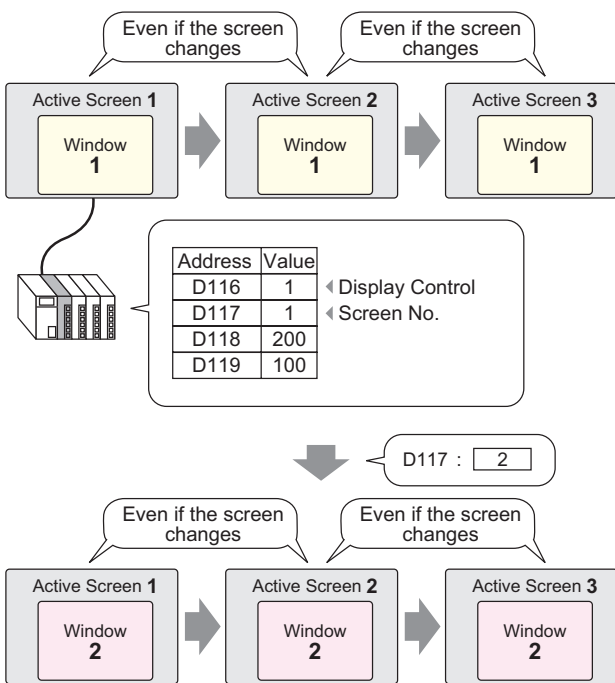

- ☞ Setup Procedure (page 12-18)
- ☞ Introduction (page 12-17)

12.2 Creating Windows

What is a Window?

You can register occasionally viewed screens as Window screens and use a switch to view or hide the screen. Window screens are suitable for displaying reference or error handling information.

12.2.1 Introduction

Create up to 2000 Window screens in a project to display information inside a window.

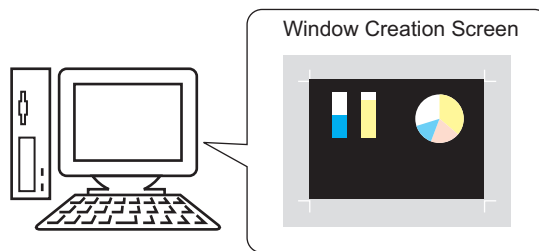

Windows can be set as Local or Global.

Display Method	
<p>Display as a Local Window</p> <p>Displays the set Window on a single screen.</p>	<p>☞ "12.3 Displaying Windows" (page 12-7)</p>
<p>Display as a Global Window</p> <p>Displays the Window on all screens.</p>	<p>☞ "12.5 Displaying the Same Window on All Screens" (page 12-14)</p>

12.2.2 Setup Procedure

Create a new Window Screen.

- 1 From the [Screen (S)] menu, select [New Screen (N)] or click . The [New Screen] dialog box appears.

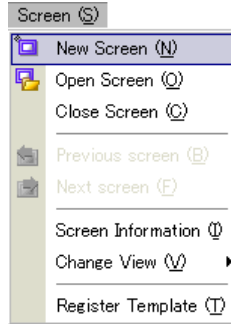

- 2 From [Screens of Type], select [Window Screens]. The [Screen] number field is filled in starting from 1. You can change this number, but it cannot be duplicated.

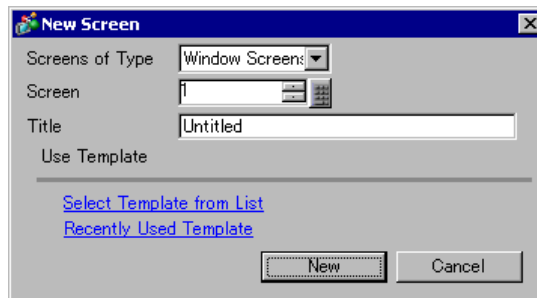

- 3 Click [New]. The window appears.

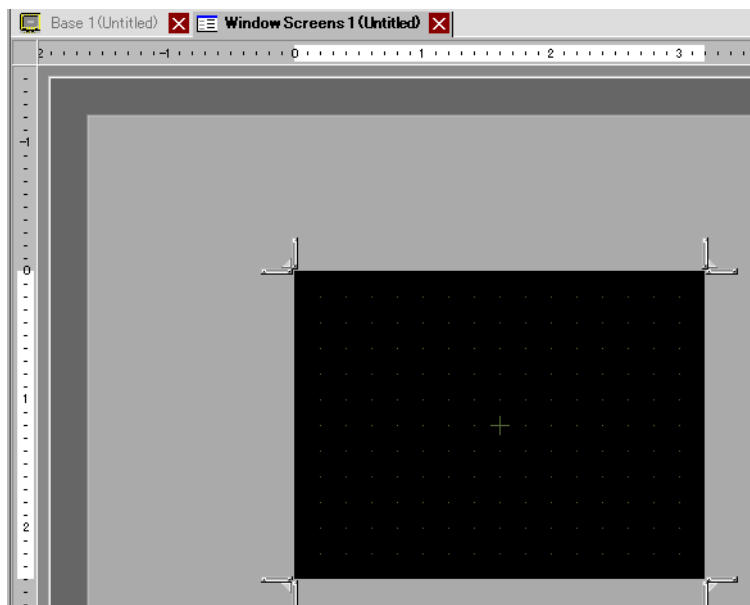

4 Adjust the window size.

Hover over a corner, the cursor changes to . Drag to change the size.

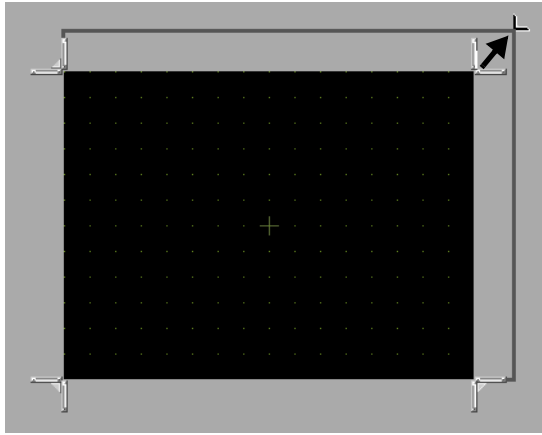
**NOTE**

- Ensure that the Window does not exceed the size of the Base Screen.

5 Place parts on the screen as necessary. You can use the same steps as creating a base screen. Save the window.

Click  to close the Window.

NOTE

- The Window appears in the [Screen List]. Click the Window to view and edit it.

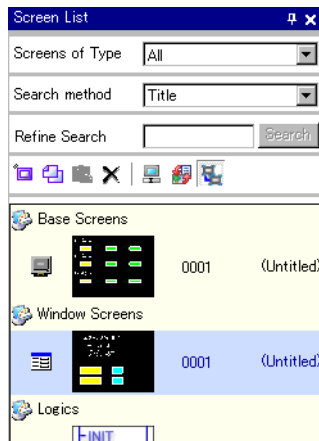

12.3 Displaying Windows

What is a Local Window?

A local Window can be referenced from one Base screen. You can use up to three Windows on a Base screen.

12.3.1 Introduction

A Local Window is used as a reference window or error window from one Base screen. The Base screen remains and the Local Window appears on top.

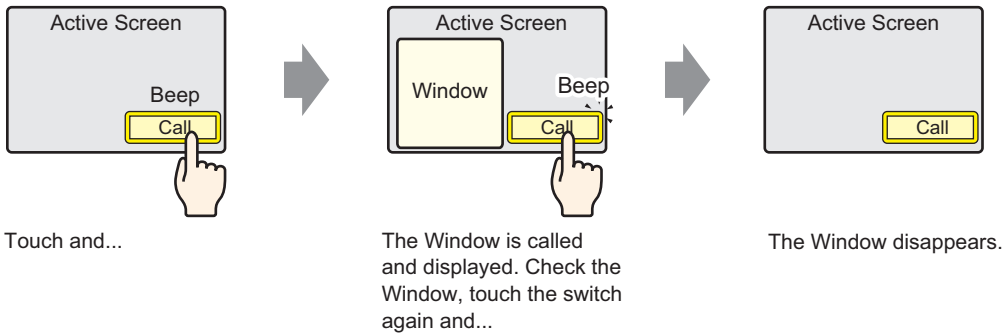

NOTE • You can use a switch or a designated address in the device/PLC to turn the Window ON or OFF.

When using multiple Windows on a Base screen, the most recently displayed Window is on top. You can move to another Window by touching the Window you want to view.

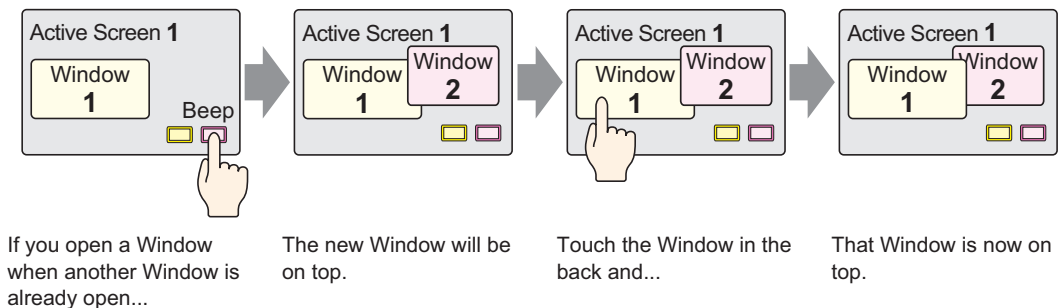



12.3.2 Setup Procedure

NOTE

- Please refer to the Settings Guide for details.
 - ☞ "12.7 Window Part Settings Guide" (page 12-21)
- For details of the part placement method and the address, shape, color, and label setting method, refer to the "Part Editing Procedure".
 - ☞ "8.6.1 Editing Parts" (page 8-52)

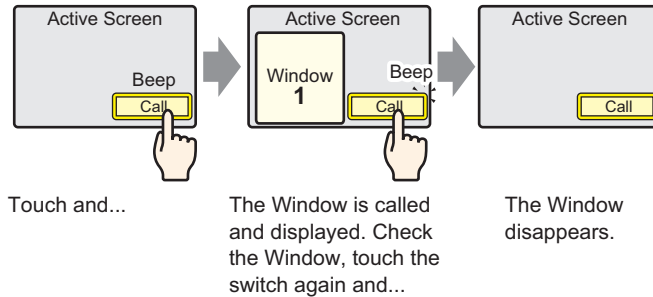
Create a Window to call from a Base screen.



- 1 From the [Part (P)] menu, select [Window (W)] or click . Place the Window on the Base screen. On the GP, the window is represented as a rectangle with a dotted line.

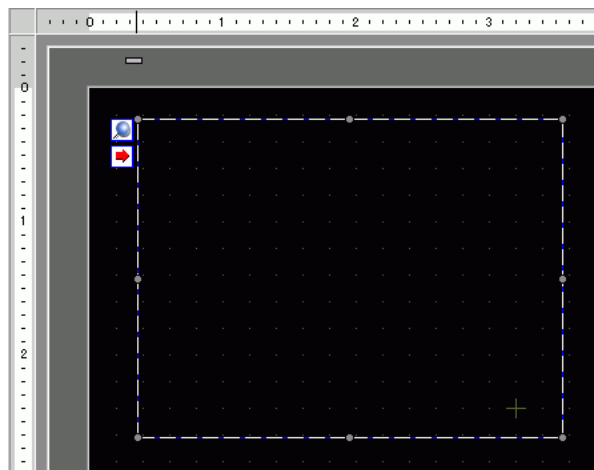

NOTE

- If the window parts are enabled, the  icon displays in the loading area on the Window Screen. Click the icon to display the loading screen for changing or confirming the settings.

2 Click the new part. The following dialog box appears. On the [Basic] tab, from [Window Type], select [Activate Switch].

Select [Activate Switch] from [Window Type].

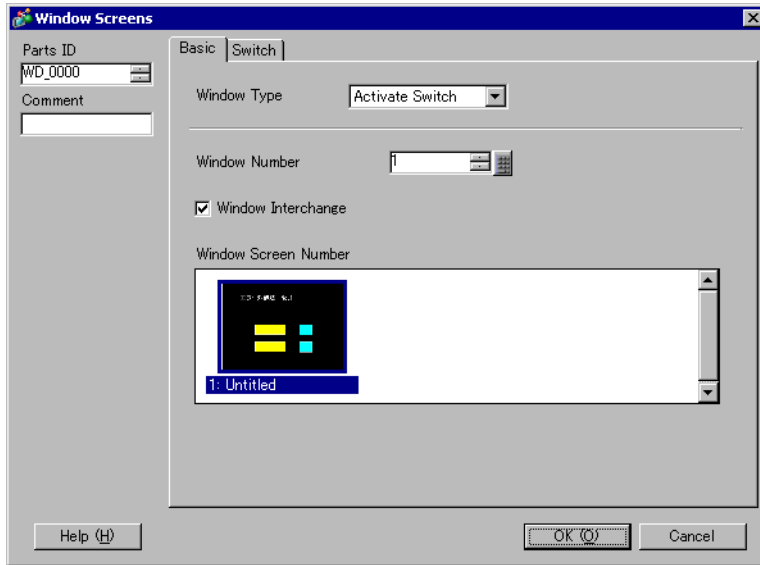

3 Set the [Window Number] to "1". (Or click the scaled-down window to display from the [Window Screen Number].)

4 On the [Switch] tab, set the switch shape, color, and label.

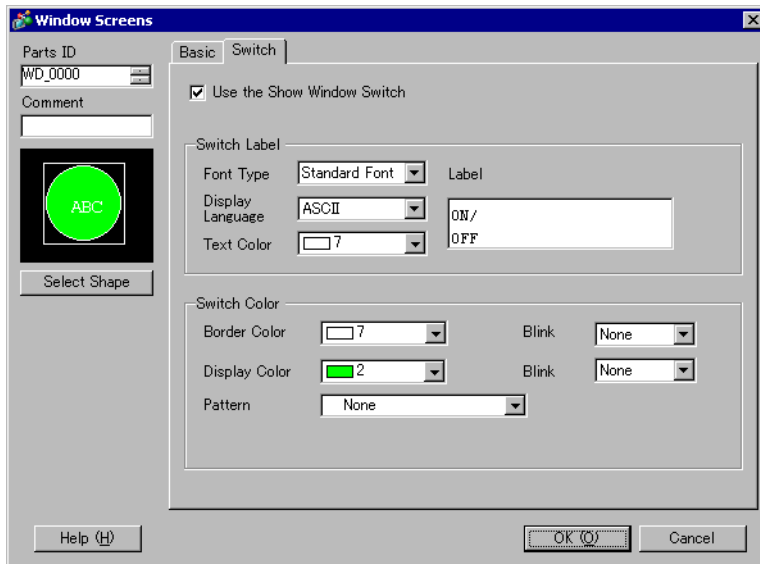

5 Click [OK]. A window with a switch attached is now set.

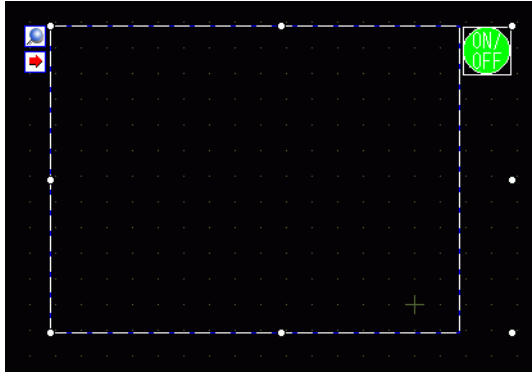

NOTE

- You can select the switch individually and move it to anywhere on the screen.

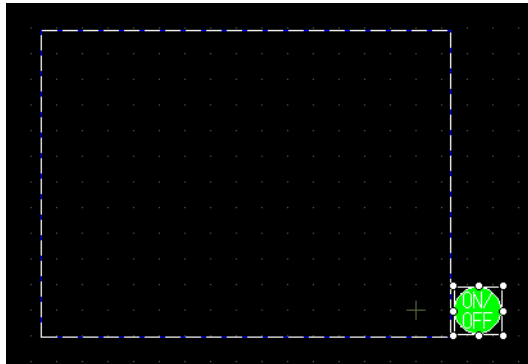

12.4 Changing the Displayed Window

12.4.1 Introduction

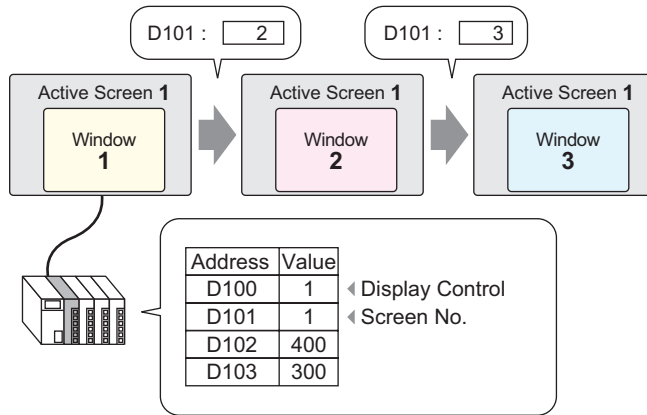

You can set up multiple Windows for one Base screen.

NOTE

- If a switch calls an undefined Window number, the Window is not displayed. If another Window displays, it remains on the screen. Also, only one Window appears at a time. If a Window displays, it is closed before another Window appears.

12.4.2 Setup Procedure

NOTE

- Please refer to the Settings Guide for details.
 ➔ "12.7 Window Part Settings Guide" (page 12-21)

Change the displayed Window Screen according to the value stored in the word address (D101).

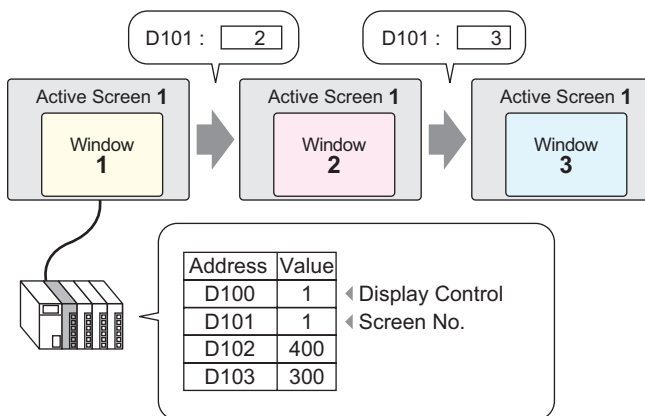

1 From the [Parts (P)] menu, select [Window (W)]. Or click the icon . Place a window on the screen.

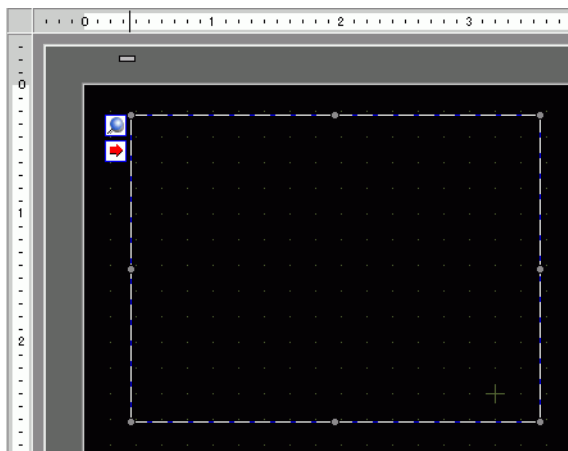

NOTE

- If the window parts are enabled, the  icon displays in the loading area on the Window Screen. Click the icon to display the loading screen for changing or confirming the settings.

- Click the new part. The following dialog box appears. On the [Basic] tab, from [Window Type], select [Activate Switch].
Select [Word Action] from [Window Type].

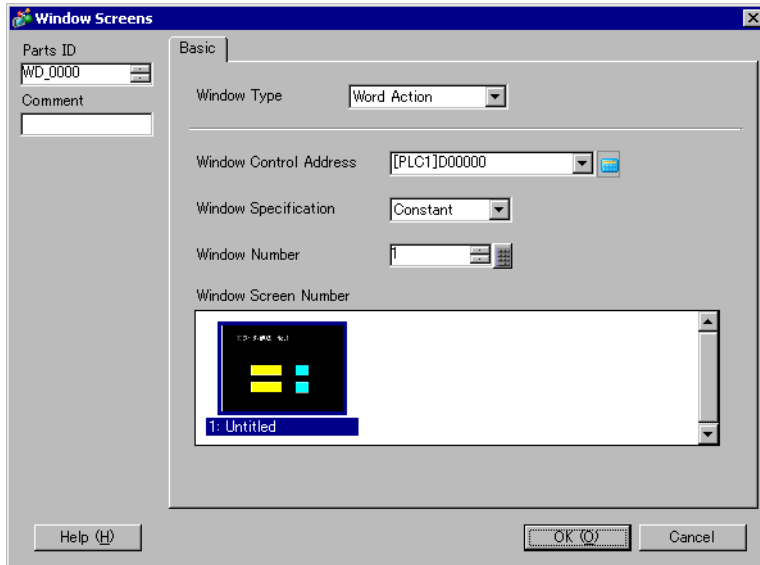

- In [Window Control Address], set the word address (D100) that controls the window.



- From [Window Specification], select [Address]. Set the [Data Type].



- Click [OK]. The Window is configured according to the value stored in the address.

If you turn ON Bit 0 of the Window Control Address (D100), the Window displays. When word address D101's value changes, the Window changes. When the value of word address D102 or D103 changes, the window position changes.

12.5 Displaying the Same Window on All Screens

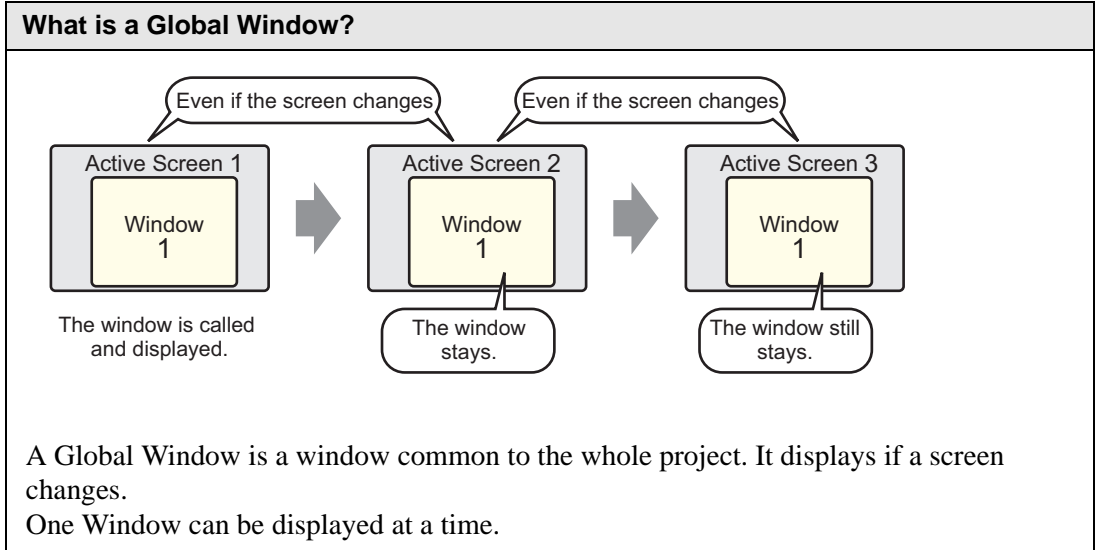

12.5.1 Introduction

A Global Window remains displayed when a Base screen changes.

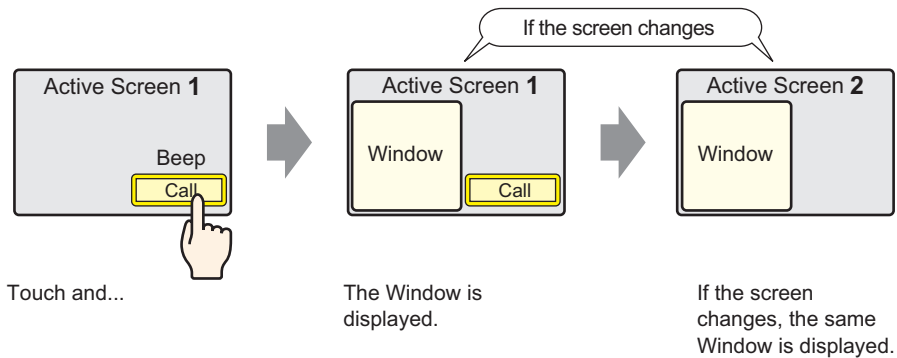

12.5.2 Setup Procedure

NOTE

- Please refer to the Settings Guide for details.
 ☞ "5.15.6 [System Settings] Setting Guide ■ [Display Unit] Settings Guide" (page 5-130)
- For details about placing switches or setting addresses, shapes, colors, and labels, please refer to "Part Editing Procedure".
 ☞ "8.6.1 Editing Parts" (page 8-52)

When you touch a switch placed on the Base screen, the same Window displays on all screens.

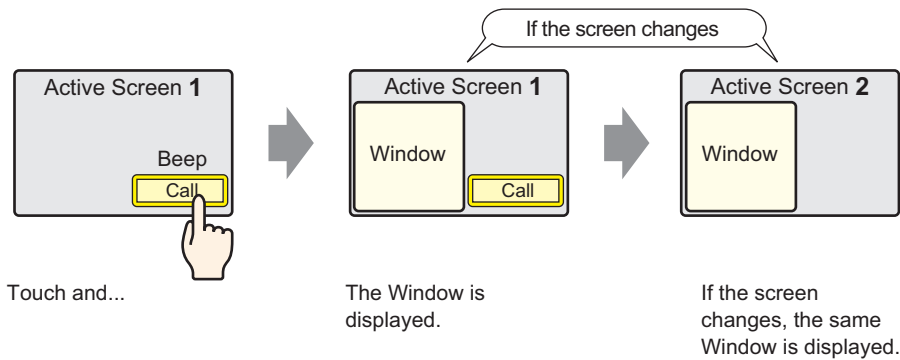

1 From [System Settings], point to [Display Unit] and open the [Mode] tab.

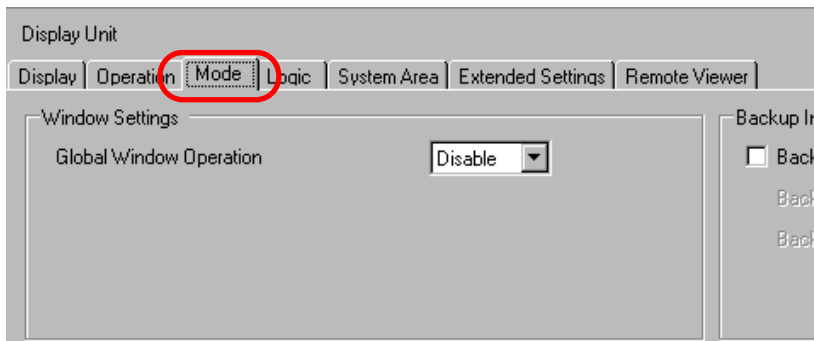

2 From [Global Window Operation], select [Direct].

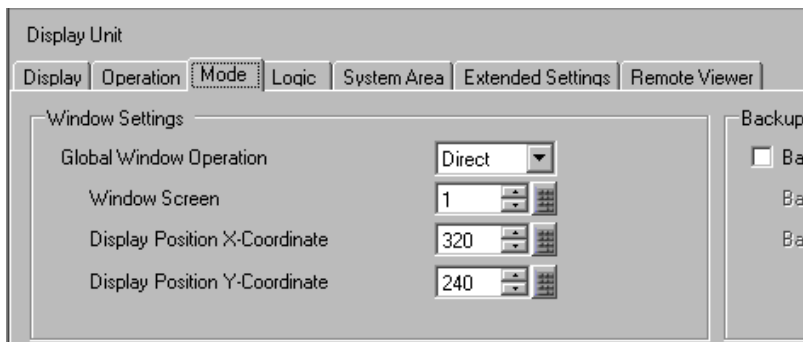

3 Set the [Window Screen] to "1". Set the [Display Position X-Coordinate] and [Display Position Y-Coordinate] of the Window on the Base screen.
The Global Window settings are complete.

4 Place the switch on the Base screen. Double-click the switch. The Settings dialog box appears.

NOTE • Do not place overlapping switches when displaying a Global Window.

5 Set the [Bit Address]. From [Device/PLC], select [#INTERNAL] and designate LS0016 bit 0.

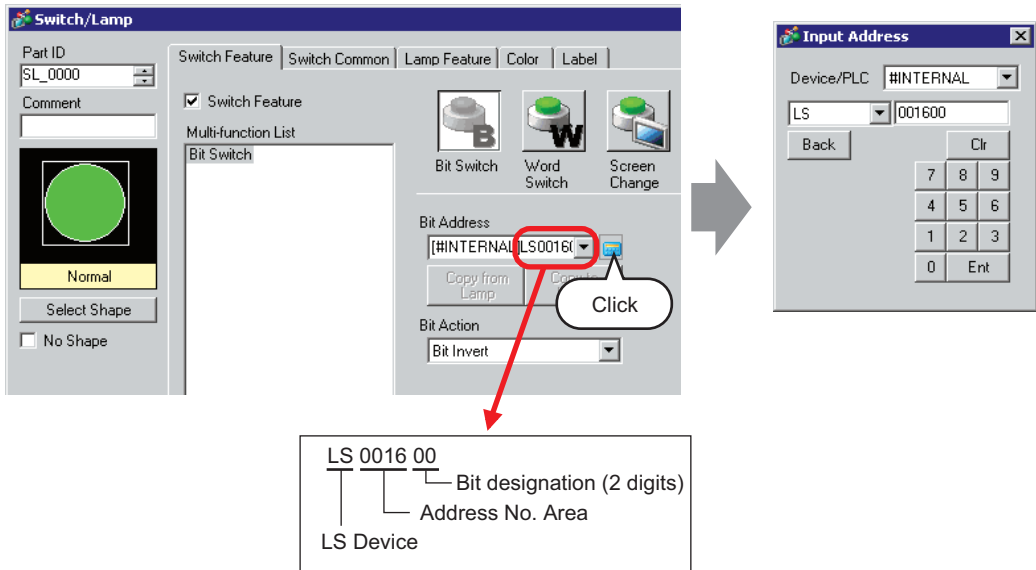

6 From [Bit Action], select [Bit Invert]. Click [OK].

12.6 Changing the Displayed Window on All Screens

12.6.1 Introduction

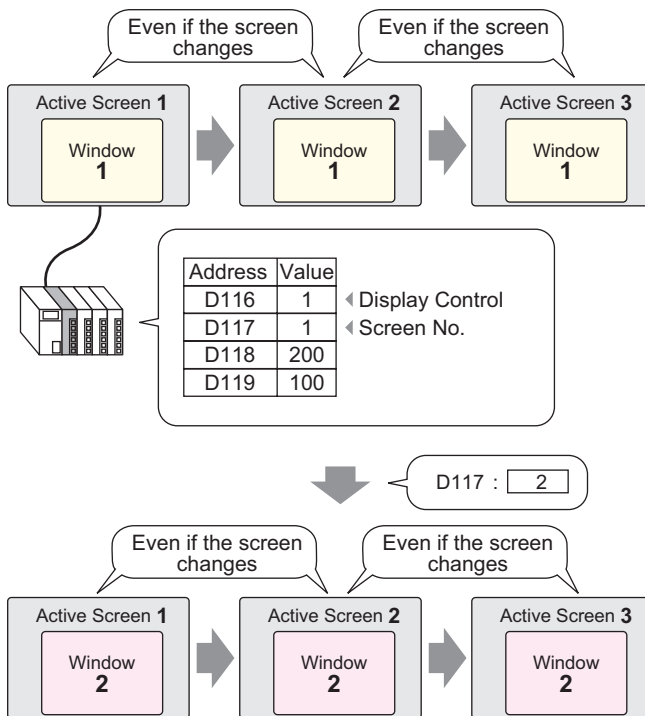

NOTE

- If a switch calls an undefined Window number, the Window is not displayed. If another Window displays, it remains on the screen. Also, only one Window appears at a time. If a Window displays, it is closed before another Window appears.

12.6.2 Setup Procedure

NOTE

- Please refer to the Settings Guide for details.
 ☞ "5.15.6 [System Settings] Setting Guide ■ [Display Unit] Settings Guide" (page 5-130)

Change the Global Window according to the value stored in the word address (for example, D117).

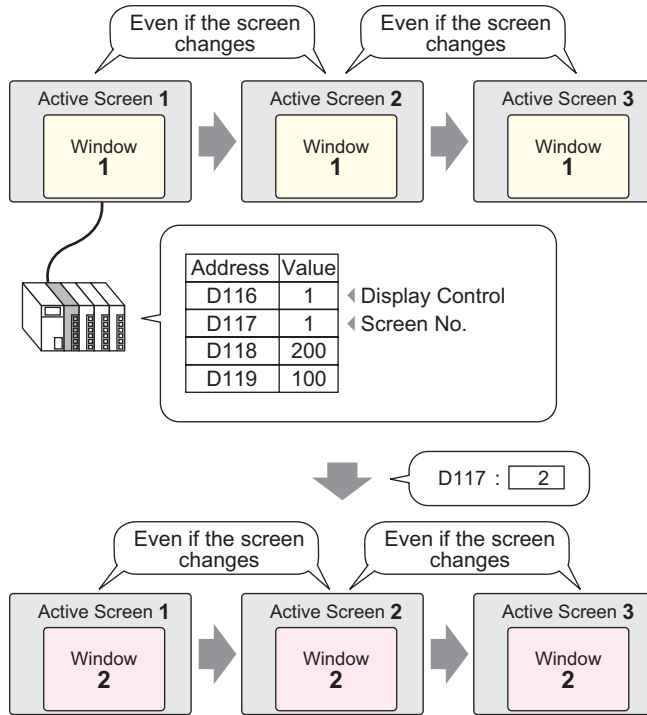

1 From [System Settings], point to [Display Unit] and open the [Mode] tab.

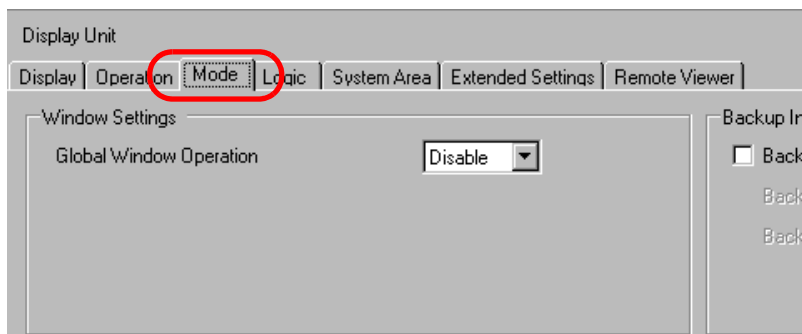

2 From [Global Window Operation], select [Indirect].

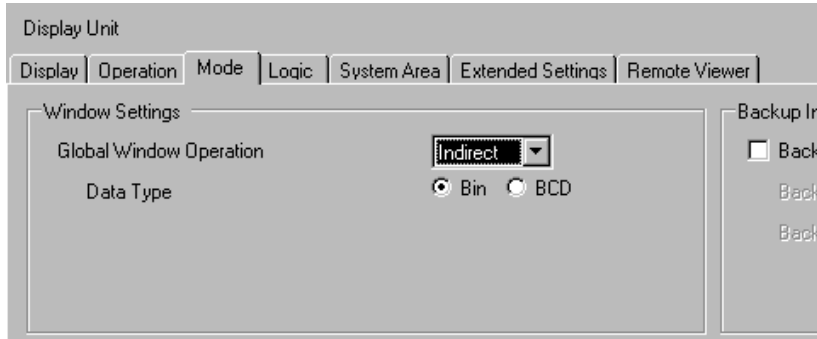

3 Set the [Data Type].

4 Select the [System Area] tab.

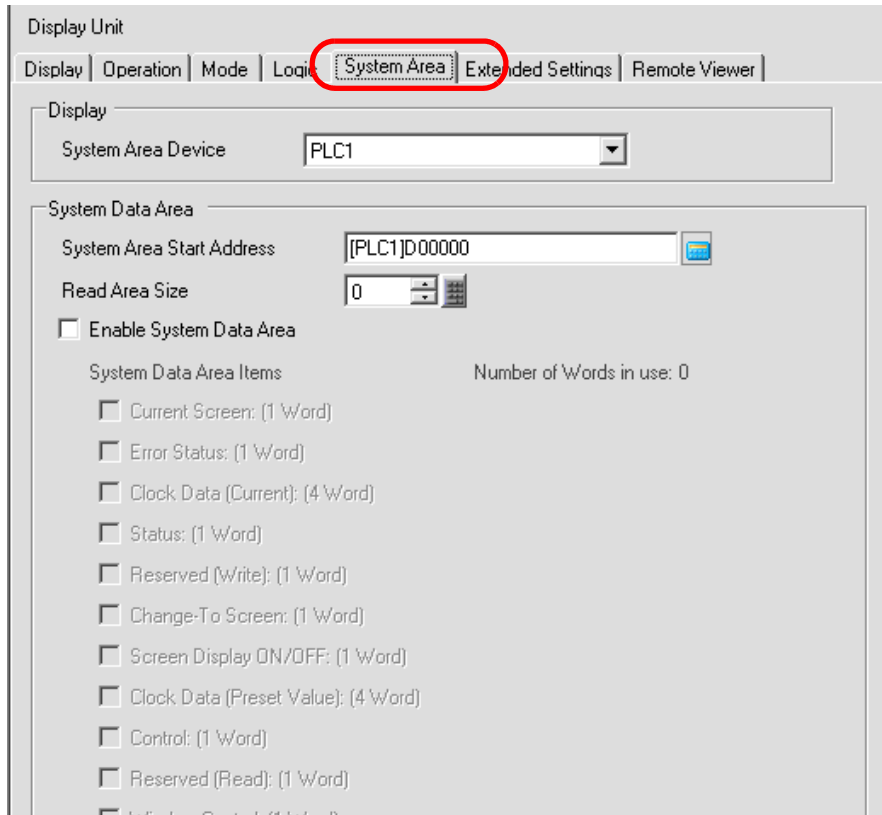

- 5 In [System Area Device], select the appropriate device that uses the system area. In [System Area Start Address], define the top address.

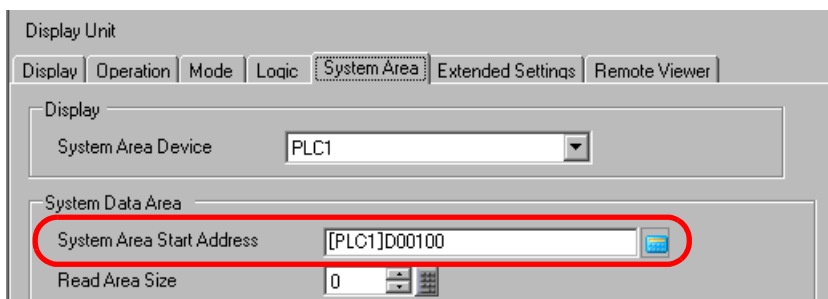

- 6 Select the following check boxes: [Enable System Data Area], [Window Control], [Window Screen], and [Window Display Position].

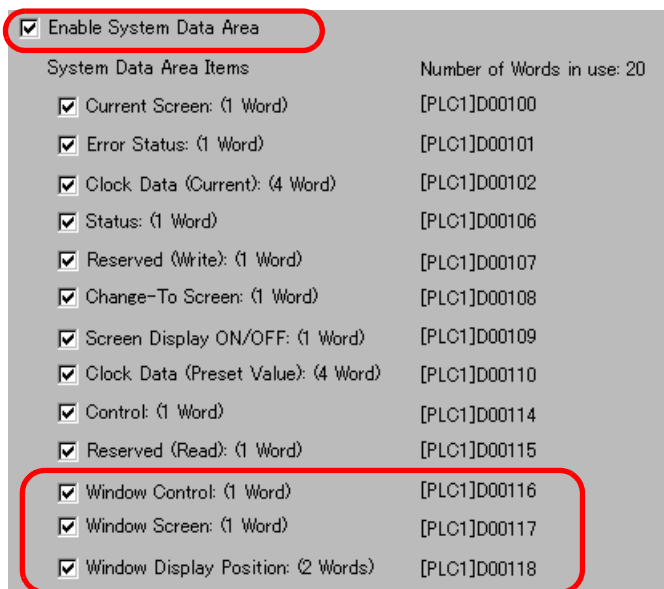

The Global Window (Indirect designation) settings are complete.

When bit 0 of the Window Control Address (example, D116) specified in [System Area Device] turns ON, the Window displays. When the Window address (example, D117) value changes, the screen changes. When the value of the display coordinate address (example, X-coordinate is D118, Y-coordinate is D119) changes, the Window position changes.

NOTE

- For details on the System Data Area, please refer the pages relevant to your connected device in the "GP-Pro EX Connection Device Manual".

12.7 Window Part Settings Guide

The Window part is used to display a Local Window on a Base Screen.
Place a Window part on the Base Screen to display the Window in that location.

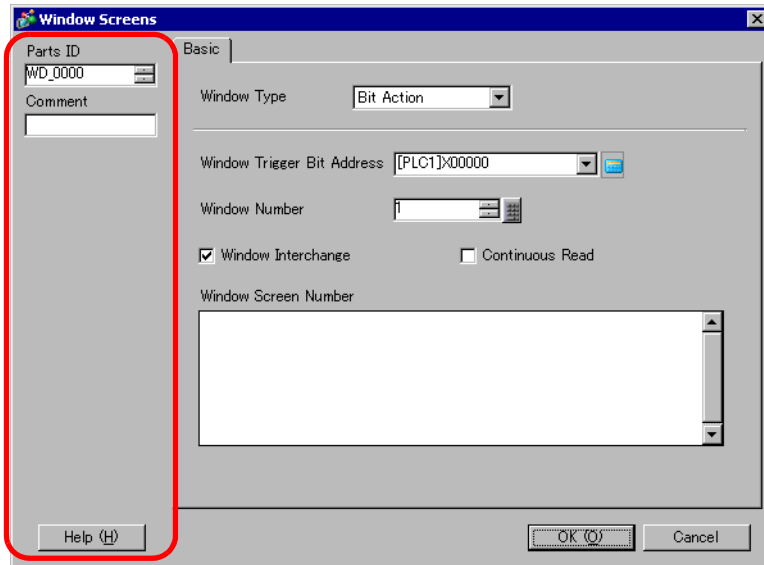

Setting	Description
Parts ID	Parts are automatically assigned an ID number. Window ID: WD_****(4 digits) The letter portion is fixed. The number portion can be modified from 0000 to 9999.
Comment	The comment for each Part can be up to 20 characters long.
Window Type	Choose the control method for displaying/hiding the Window. <ul style="list-style-type: none"> • Bit Action The Window display is controlled by a specific bit address turning ON/OFF. ☞ "12.7.1 Bit Action" (page 12-22) • Word Action The Window display is controlled by a specific word address. ☞ "12.7.2 Word Action" (page 12-23) • Activate Switch The Window display is controlled by touching an exclusive switch. ☞ "12.7.3 Activate Switch" (page 12-26)

12.7.1 Bit Action

■ Basic Settings

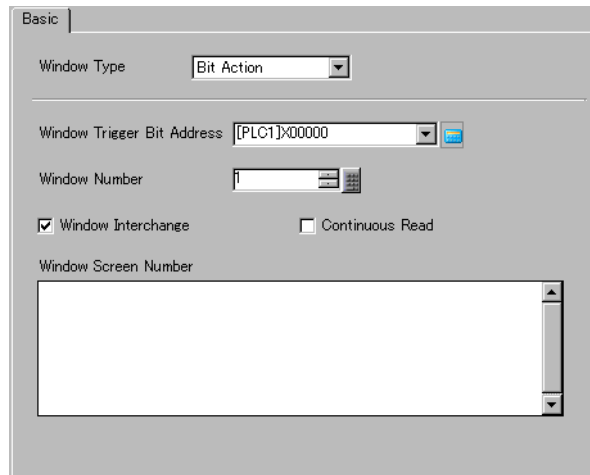

Setting	Description
Window Trigger Bit Address	<p>Specify the bit address to control the window display. This can be set to either a PLC address or GP internal device (System Data Editor).</p> <p>NOTE</p> <ul style="list-style-type: none"> When many parts are running from a window, you can sometimes speed up screen display by designating GP internal device addresses.
Window Number	Specify the number of the Window Screen you want to display from 1 to 2,000.
Window Interchange	Select this check box to allow the selected Window to move on top of another Window.
Continuous Read	<p>Select to continually read data from a part regardless of the Window displayed. This does not apply to touch input parts. When a window displays, the part's Data Display speed is increased.</p> <p>NOTE</p> <ul style="list-style-type: none"> When the Window is not displayed, part data specified on the window and screen is read. All the other screen display speeds decrease. Up to three Windows with [Continuous Read] can be placed on a single Base screen. Other Windows where [Continuous Read] is not set cannot be displayed. When using Global Windows, you can place up to two windows on a Base screen. Windows with the [Continuous Read] option set are read before Windows without this option are read. Any scripts set on a Window execute if the script condition is satisfied, even if the Window is not displayed. If you do want to execute the script, make sure the [Continuous Read] check box is cleared.
Window Screen Number	Display a list of the Windows.

12.7.2 Word Action

■ Basic

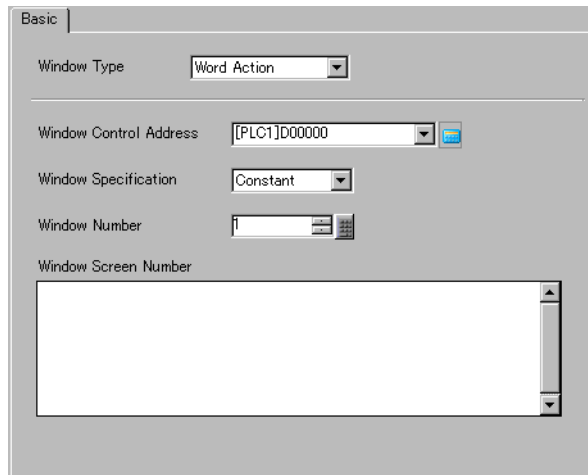

Setting	Description
Window Control Address	<p>Specify the word address to control the Window. This can be set to either a PLC address or GP internal device (System Data Editor).</p> <div style="text-align: center;"> <p style="margin-left: 100px;"> Window Interchange "0": Interchange enabled "1": Interchange disabled "0"→"1"Display window </p> </div> <p>NOTE</p> <ul style="list-style-type: none"> When many parts are running from a window, you can sometimes speed up screen display by designating GP internal device addresses.

Continued

Setting	Description																				
Window Specification	<p>Select the method to display the Window.</p> <table border="1" data-bbox="432 208 1241 440"> <thead> <tr> <th colspan="2" data-bbox="577 208 820 237">For [Constant]</th> <th colspan="2" data-bbox="1005 208 1241 237">For [Address]</th> </tr> <tr> <th data-bbox="432 237 577 266">Word Address</th> <th data-bbox="577 237 820 266">Control Address</th> <th data-bbox="857 237 1005 266">Word Address</th> <th data-bbox="1005 237 1241 266">Control Address</th> </tr> </thead> <tbody> <tr> <td data-bbox="541 266 577 295">+1</td> <td data-bbox="577 266 820 295">Reserved</td> <td data-bbox="967 266 1005 295">+1</td> <td data-bbox="1005 266 1241 324">Window Screen Number</td> </tr> <tr> <td data-bbox="541 324 577 353">+2</td> <td data-bbox="577 324 820 353">Reserved</td> <td data-bbox="967 324 1005 353">+2</td> <td data-bbox="1005 324 1241 382">Display Position (X Coordinate)</td> </tr> <tr> <td data-bbox="541 382 577 411">+3</td> <td data-bbox="577 382 820 411">Reserved</td> <td data-bbox="967 382 1005 411">+3</td> <td data-bbox="1005 382 1241 440">Display Position (Y Coordinate)</td> </tr> </tbody> </table> <ul style="list-style-type: none"> • Constant Set the Window Number • Address Four consecutive words are used starting from [Window Control Address], the Window Number and position are stored and designated indirectly. <p> " ◆ Address Designation" (page 12-25)</p>	For [Constant]		For [Address]		Word Address	Control Address	Word Address	Control Address	+1	Reserved	+1	Window Screen Number	+2	Reserved	+2	Display Position (X Coordinate)	+3	Reserved	+3	Display Position (Y Coordinate)
For [Constant]		For [Address]																			
Word Address	Control Address	Word Address	Control Address																		
+1	Reserved	+1	Window Screen Number																		
+2	Reserved	+2	Display Position (X Coordinate)																		
+3	Reserved	+3	Display Position (Y Coordinate)																		
Window Number	Specify the number of the Window to display. The value can be from 1 to 2,000.																				
Window Screen Number	Displays a list of existing Windows. Select a Window by clicking it.																				

◆ Address Designation

Window Control Address: [PLC1]D00000

Window Specification: Address

Window Number: D00001

Window Display Position: X: D00002, Y: D00003

Data Type: Bin

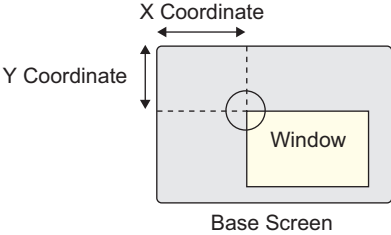
Setting	Description
Window Number	Shows the address ([Window Control Address] + 1) that stores the Window to display.
Window Display Position (X Coordinate/Y Coordinate)	Displays the address that stores the window position. The X Coordinate: [Window Control Address] + 2. The Y Coordinate: [Window Control Address] + 3. This stores the coordinate data of the Window's top-left corner.
	 <p>The diagram illustrates a 'Base Screen' containing a smaller 'Window'. A dashed circle marks the top-left corner of the window. A horizontal double-headed arrow labeled 'X Coordinate' indicates the distance from the left edge of the base screen to the vertical dashed line passing through the top-left corner of the window. A vertical double-headed arrow labeled 'Y Coordinate' indicates the distance from the top edge of the base screen to the horizontal dashed line passing through the top-left corner of the window.</p>
Data Type	Select the type of data to store in the address from [Bin] or [BCD].

12.7.3 Activate Switch

■ Basic Settings

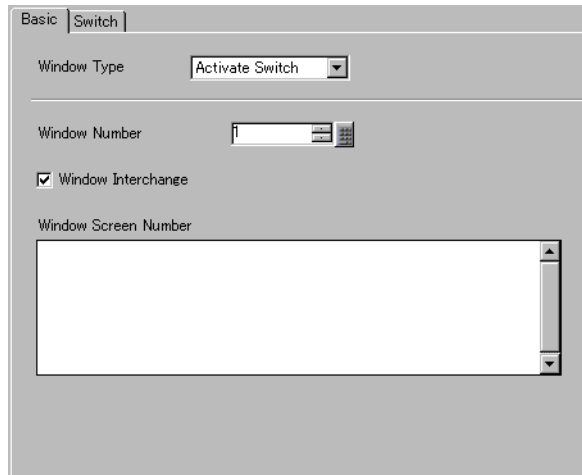

Setting	Description
Window Number	Specify the number of the Window Screen you want to display from 1 to 2,000.
Window Interchange	Select this check box to allow the selected Window to move on top of another Window.
Window Screen Number	Display a list of the Windows.

■ Switch Settings

When the [Window Type] is set to [Activate Switch], a switch can be used with the Window.

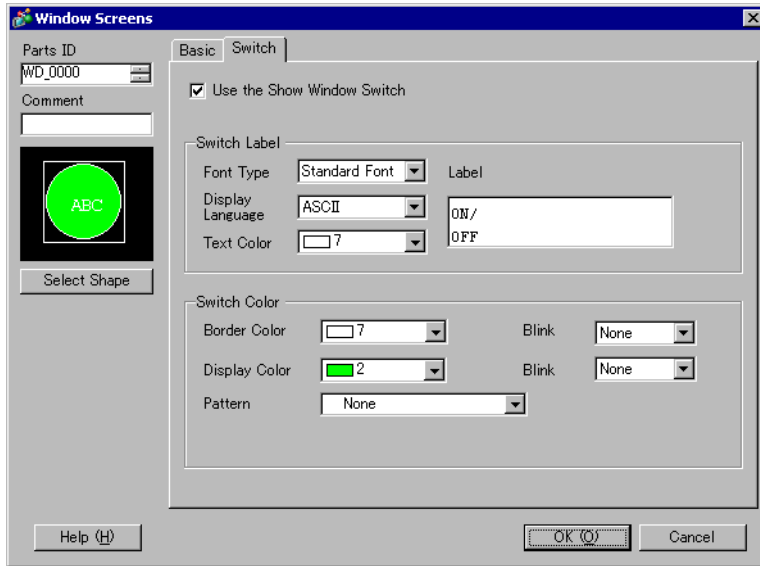

Setting		Description
Use the Show Window Switch		Select a switch to display/hide the Window. The switch is automatically placed in the top-right of the window. You can move it by selecting it.
Switch Label	Font Type	Select the font type that will be displayed on the Switch label. <ul style="list-style-type: none"> • Standard Font For a bit map font, you can choose the magnification level of the letters' height and width. When you magnify/shrink the letters, the outline may become rough or the letter may appear condensed. • Stroke Font This is an outline font where the ratio of the character height/width is fixed. The letters will have a smooth outline even if you magnify/shrink them. However, this font uses more disk space on the GP.
	Display Language	Select the display language for the label from [ASCII], [Japanese], [Chinese (Traditional)], [Chinese (Simplified)], [Korean], [Cyrillic], or [Thai].
	Text Color	Select a color for the label text.
	Label	Type the switch text.

Continued

Setting		Description
Switch Color	Border Color	If the Part Shape is set to have a border, select a color for it.
	Display Color	Select the Switch color.
	Pattern	Select from the 8 patterns or choose [No Pattern].
	Pattern Color	If a pattern has been selected, choose a pattern color. The Switch color appears as a combination of the [Display Color] and [Pattern Color].
	Blink	Select the Part blink and blink speed. You can choose different blink settings for the [Border Color], [Display Color], and [Pattern Color]. <div style="border: 1px solid black; padding: 2px; display: inline-block;">NOTE</div> <ul style="list-style-type: none"> • There are cases where you can and cannot set Blink depending on the Display Unit and System Settings' [Color Settings]. <p> "8.5.1 Setting Colors ■ List of Available Colors" (page 8-42)</p>

12.8 Restrictions for Windows

12.8.1 Restrictions for Window Screens

- Up to 2,000 Window Screens can be registered.
- New windows cannot be placed over the window display. A window part, Special Data Display [File Manager], Video Module Display, Remote PC Access Window Display cannot be placed on the window display.
- When placing a Historical Trend Graph, Data Block Display Graph, Data Display, or Special Data Display [Show CSV] on a Window, the following restrictions apply.
 - **Historical Trend Graph, Data Block Display Graph**
A maximum of 8 Historical Trend Graphs and Data Block Display Graphs can be displayed at the same time on a single screen.
Also, up to 40 channels can be displayed on one Window.
 - **Data Display**
You cannot input from a popup keypad into a Data Display placed on a Window. To input data into a Data Display on a Window, directly place the keypad in the Window.
 - **Special Data Display [Show CSV]**
You cannot edit data. (CSV edit screen will not function.)
- When 384 parts are already placed on the Base screen and Window combined, additional placed parts will not function. Parts become disabled starting with parts placed on the last displayed window screen.
- When more than 512 Moving Mark display positions are on the Base screen and Window, subsequent positions are disabled. They become disabled starting with marks placed on the last displayed window screen.

12.8.2 Restrictions for Window Screens

- Multiple Local Windows can be placed on the same Base screen, but a maximum of three Local Windows can be displayed at the same time. One Global Window and two Local Windows can be displayed simultaneously on the same screen. For more details, please refer to " ■ Displaying Multiple Windows on a Single Screen" (page 12-31) .

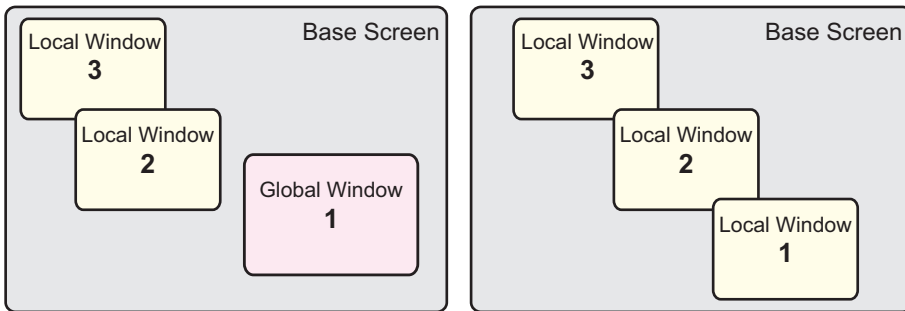

- Only one Global Window is allowed in each project.
- When the Window Number is not set, the Window cannot be displayed.
- When a Window has been positioned to stick out past its Base screen, the Window is adjusted to fit inside the Base screen.
- A window's size and display position go in four dot increments for the X coordinate and one dot increments for the Y coordinate. When the designated X coordinate is not a four dot increment, the left side is adjusted to display as a four dot increment.

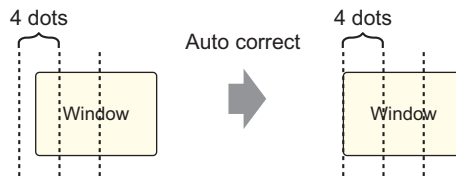

- If multiple devices/PLCs are connected, only the device/PLC specified in the GP System Data Area can display Global Windows.
- A Global Window cannot be displayed when the device monitor is on.
- When using a Switch to display a window, if the Window part specified in [Window ID] is used multiple times on the same screen, the first window displays. All other registered windows do not function.
- Parts on screens that are completely hidden by an active Window cannot be activated by touch. However, if only a portion of a part is hidden by a Window, the viewable portion can be activated by touching it.
- Up to three Windows with [Continuous Read] can be placed on a single Base screen. Other Windows where [Continuous Read] is not set cannot be displayed. When using Global Windows, you can place up to two windows on a Base screen.
- Any scripts set on a Window execute if the script condition is satisfied, even if the Window is not displayed. If you do want to execute the script, make sure the [Continuous Read] check box is cleared.

■ Displaying Multiple Windows on a Single Screen

In addition to the Global Windows/Local Windows that can be created, there are also screens that are handled as a system window.

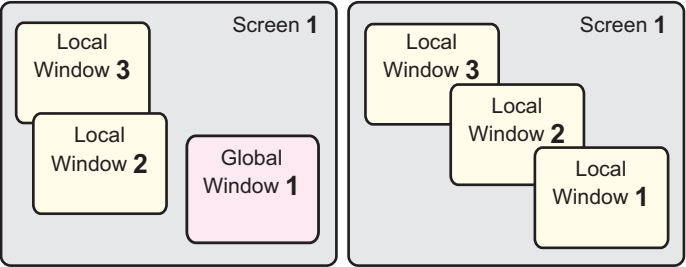
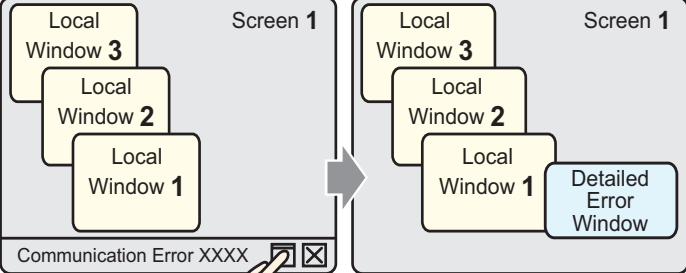
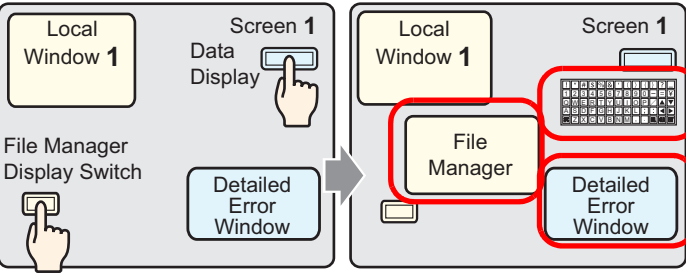
	Target	No. of Windows that can be displayed on 1 screen
<p>User Window</p>	<ul style="list-style-type: none"> Local Window Global Window Remote PC Access Window Display 	<p>One Global Window and two Local Windows can be displayed simultaneously on the same screen.</p> 
<p>Special Window</p>	<ul style="list-style-type: none"> Security Password Input Screen Detailed Error Window Data Display Pop-up keypad Special Data Display [Show CSV] edit screen Special Data Display [File Manager] Video Module Display Remote PC Access Window Display's popup keypad 	<p>You can only display one Special Window.</p>  <p>Touch the error message to display the error details.</p> <p>However, if the maximum number of User Windows are not currently displayed, multiple Special Windows can be displayed by using Local Windows.</p>  <p>Up to two more Function Windows can be displayed with a Local Window...</p> <p>You can display the File Manager and a Pop-up keypad.</p> <p>IMPORTANT</p> <ul style="list-style-type: none"> When the Security Password Input Screen displays, other features cannot be displayed in a Window.

Continued

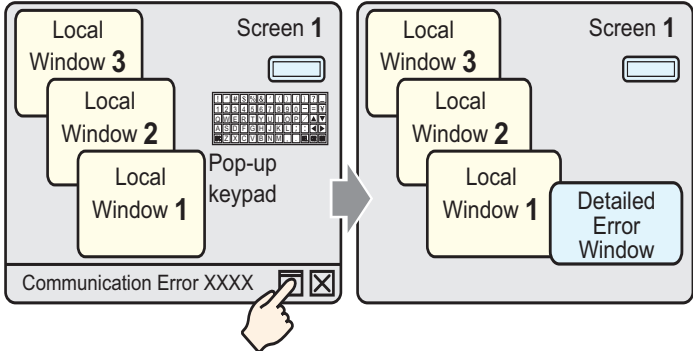
	Target	No. of Windows that can be displayed on 1 screen						
<p>Special Window</p>	<ul style="list-style-type: none"> • Security Password Input Screen • Detailed Error Window • Data Display Pop-up keypad • Special Data Display [Show CSV] edit screen • Special Data Display [File Manager] • Video Module Display • Remote PC Access Window Display 	<p>When a high-priority function on a Window occurs, a low-priority function on another Window is stopped and the Window is closed. The Window with the high-priority function appears.</p> <p>Function Priority Order</p> <table border="1" data-bbox="532 374 1078 529"> <tr> <td>1</td> <td>Security Password Input Screen</td> </tr> <tr> <td>2</td> <td>Detailed Error Window</td> </tr> <tr> <td>3</td> <td> <ul style="list-style-type: none"> • Data Display Pop-up keypad • Special Data Display [Show CSV] edit screen • Special Data Display [File Manager] </td> </tr> </table>  <p>Touch the error message while a pop-up keypad is displayed and...</p> <p>The pop-up keypad closes and a detailed error window displays.</p> <p>IMPORTANT</p> <ul style="list-style-type: none"> • A Special Window has a higher priority display function than a Global or Local Window. Therefore if a File Manager (displayed as a Local Window) overlaps a Detailed Error Window, the File Manager is hidden under the Detailed Error Window. 	1	Security Password Input Screen	2	Detailed Error Window	3	<ul style="list-style-type: none"> • Data Display Pop-up keypad • Special Data Display [Show CSV] edit screen • Special Data Display [File Manager]
1	Security Password Input Screen							
2	Detailed Error Window							
3	<ul style="list-style-type: none"> • Data Display Pop-up keypad • Special Data Display [Show CSV] edit screen • Special Data Display [File Manager] 							
<p>System Window</p>	<ul style="list-style-type: none"> • Error Messages • Banner Alarm Message • System Menu • Japanese keypad 	<p>These Windows are displayed regardless of the status of the Global, Local, or Special Windows. These System Windows are created by the system and do not affect the number of allowable Windows per Base screen.</p>						