



QnA Series CPU Direct Driver

1	System Configuration.....	3
2	Selection of External Device	6
3	Example of Communication Setting.....	7
4	Setup Items	9
5	Cable Diagram	13
6	Supported Device.....	17
7	Device Code and Address Code.....	19
8	Error Messages.....	21

Introduction

This manual describes how to connect the Display and the External Device (target PLC).

In this manual, the connection procedure will be described by following the below sections:

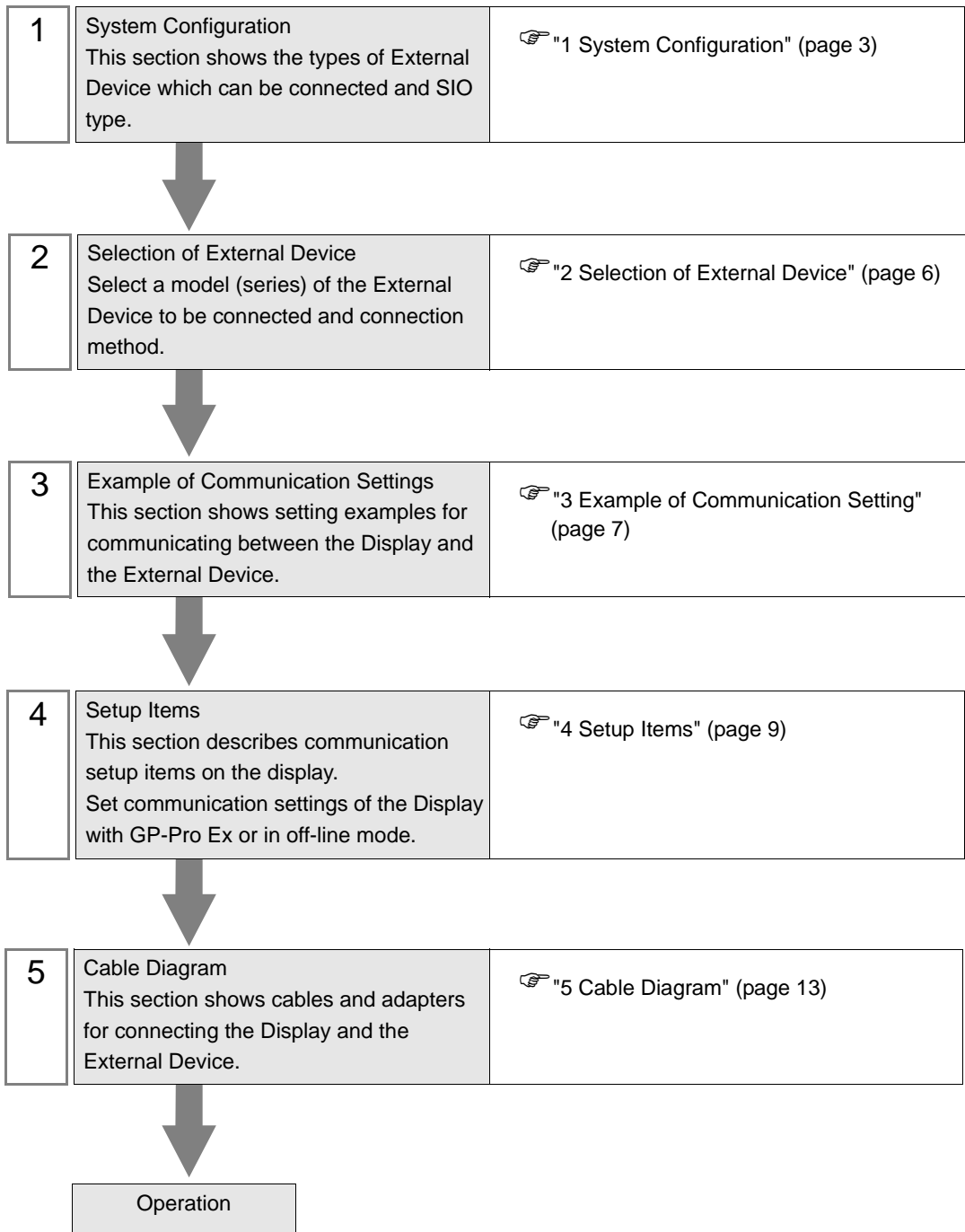

1 System Configuration

The system configuration in the case when the External Device of Mitsubishi Electric Corp. and the Display are connected is shown.

Series	CPU	Link I/F	SIO Type	Setting Example	Cable Diagram
MELSEC QnA Series	Q4A CPU Q3A CPU Q2A CPU -S1	CPU Direct	RS232C	Setting Example 1 (page 7)	Cable Diagram 1 (page 13)
	Q2A CPU Q2ASH CPU -S1 Q2ASH CPU		RS422/485 (4wire)	Setting Example 2 (page 8)	Cable Diagram 2 (page 14)
	Q2AS CPU -S1 Q2AS CPU Q4AR CPU	2-port adapter II by Pro-face *1 (Model: GP070-MD11)	RS422/485 (4wire)	Setting Example 2 (page 8)	Cable Diagram 3 (page 15)

*1 Supported by 2-port adapter II Rev. B or later. 2-port adapter II does not support the communication in 38,400. Please use it in 19,200.

■ COM Port of IPC

When connecting IPC with External Device, the COM port which can be used changes with series and SIO type. Please refer to the manual of IPC for details.

Usable port

Series	Usable port		
	RS-232C	RS-422/485(4 wire)	RS-422/485(2 wire)
PS-2000B	COM1 ^{*1} , COM2, COM3 ^{*1} , COM4	-	-
PS-3450A, PS-3451A	COM1, COM2 ^{*1*2}	COM2 ^{*1*2}	COM2 ^{*1*2}
PS-3650A, PS-3651A	COM1 ^{*1}	-	-
PS-3700A (Pentium®4-M) PS-3710A	COM1 ^{*1} , COM2 ^{*1} , COM3 ^{*2} , COM4	COM3 ^{*2}	COM3 ^{*2}
PS-3711A	COM1 ^{*1} , COM2 ^{*2}	COM2 ^{*2}	COM2 ^{*2}
PL-3000B	COM1 ^{*1*2} , COM2 ^{*1} , COM3, COM4	COM1 ^{*1*2}	COM1 ^{*1*2}

*1 The RI/5V can be switched. Please switch with the change switch of IPC.

*2 It is necessary to set up the SIO type with the Dip switch. Please set up as follows according to SIO type to be used.

Dip switch setting: RS-232C

Dip switch	Setting	Description
1	OFF	Reserve (always OFF)
2	OFF	SIO type: RS-232C
3	OFF	
4	OFF	Output mode of SD (TXD) data: Always output
5	OFF	Terminal resistance (220Ω) insertion to SD (TXD): None
6	OFF	Terminal resistance (220Ω) insertion to RD (RXD): None
7	OFF	Short-circuit of SDA (TXA) and RDA (RXA): Does not Exist
8	OFF	Short-circuit of SDB (TXB) and RDB (RXB): Does not Exist
9	OFF	RS (RTS) Auto control mode: Disable
10	OFF	

Dip switch setting: RS-422/485 (4 wire)

Dip switch	Setting	Description
1	OFF	Reserve (always OFF)
2	ON	SIO type: RS-422/485
3	ON	
4	OFF	Output mode of SD (TXD) data: Always output
5	OFF	Terminal resistance (220Ω) insertion to SD (TXD): None
6	OFF	Terminal resistance (220Ω) insertion to RD (RXD): None
7	OFF	Short-circuit of SDA (TXA) and RDA (RXA): Does not Exist
8	OFF	Short-circuit of SDB (TXB) and RDB (RXB): Does not Exist
9	OFF	RS (RTS) Auto control mode: Disable
10	OFF	

Dip switch setting: RS-422/485 (2 wire)

Dip switch	Setting	Description
1	OFF	Reserve (always OFF)
2	ON	SIO type: RS-422/485
3	ON	
4	OFF	Output mode of SD (TXD) data: Always output
5	OFF	Terminal resistance (220Ω) insertion to SD (TXD): None
6	OFF	Terminal resistance (220Ω) insertion to RD (RXD): None
7	ON	Short-circuit of SDA (TXA) and RDA (RXA): Exist
8	ON	Short-circuit of SDB (TXB) and RDB (RXB): Exist
9	ON	RS (RTS) Auto control mode: Enable
10	ON	

2 Selection of External Device

Select the External Device to be connected to the Display.

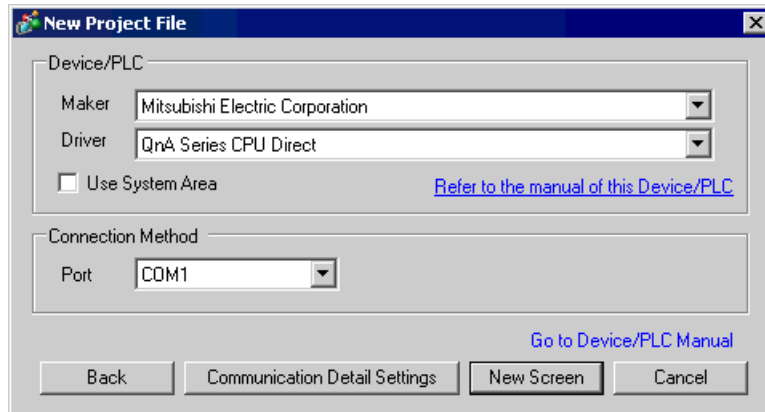

Setup Items	Setup Description
Maker	Select the maker of the External Device to be connected. Select "Mitsubishi Electric Corporation".
Driver	Select a model (series) of the External Device to be connected and connection method. Select " QnA Series CPU Direct". Check the External Device which can be connected in " QnA Series CPU Direct" in system configuration. ☞ "1 System Configuration" (page 3)
Use System Area	Check this option when you synchronize the system data area of Display and the device (memory) of External Device. When synchronized, you can use the ladder program of External Device to switch the display or display the window on the display. Cf. GP-Pro EX Reference Manual "Appendix 1.4 LS Area (only for direct access method)" This can be also set with GP-Pro EX or in off-line mode of Display. Cf. GP-Pro EX Reference Manual " 5.14.6 Setting Guide of [System Setting Window]■[Main Unit Settings] Settings Guide◆System Area Setting" Cf. Maintenance/Troubleshooting "2.14.1 Settings common to all Display models◆System Area Settings"
Port	Select the Display port to be connected to the External Device.

3 Example of Communication Setting

Examples of communication settings of the Display and the External Device, recommended by Pro-face, are shown.

3.1 Setting Example 1

■ Setting of GP-Pro EX

◆ Communication Settings

To display the setting screen, select [Device/PLC Settings] from [System setting window] in workspace.

Device/PLC 1 [Change Device/PLC](#)

Summary

Maker Series Port

Text Data Mode [Change](#)

Communication Settings

SID Type RS232C RS422/485(2wire) RS422/485(4wire)

Speed

Data Length 7 8

Parity NONE EVEN ODD

Stop Bit 1 2

Flow Control NONE ER(DTR/CTS) XON/XOFF

Timeout (sec)

Retry

Wait To Send (ms)

RI / VCC RI VCC

In the case of RS232C, you can select the 9th pin to RI (Input) or VCC (5V Power Supply). If you use the Digital's RS232C Isolation Unit or CPU I/F Cable for Mitsubishi PLC A Series (Digital's:GP430-IP10-0), please select it to VCC.

Device-Specific Settings

Allowable No. of Device/PLCs 1 Unit(s)

No.	Device Name	Settings
1	PLC1	

■ Settings of External Device

There is no setting on the External Device. The speed automatically switches according to the Display setting.

3.2 Setting Example 2

■ Setting of GP-Pro EX

◆ Communication Settings

To display the setting screen, select [Device/PLC Settings] from [System setting window] in workspace.

Device/PLC 1

Summary [Change Device/PLC](#)

Maker Series Port

Text Data Mode [Change](#)

Communication Settings

RS232C
 RS422/485(2wire)
 RS422/485(4wire)

Speed

Data Length 7 8

Parity NONE EVEN ODD

Stop Bit 1 2

Flow Control NONE ER(DTR/CTS) XON/XOFF

Timeout (sec)

Retry

Wait To Send (ms)

RI
 VCC

In the case of RS232C, you can select the 9th pin to RI (Input) or VCC (5V Power Supply). If you use the Digital's RS232C Isolation Unit or CPU I/F Cable for Mitsubishi PLC A Series (Digital's:GP430HP10-0), please select it to VCC.

Device-Specific Settings

Allowable No. of Device/PLCs 1 Unit(s)

No.	Device Name	Settings
1	PLC1	<input type="button" value="Settings"/>

■ Device Setting

There is no setting on the External Device. The speed automatically switches according to the Display setting.

4 Setup Items

Set communication settings of the Display with GP-Pro Ex or in off-line mode of the Display.

The setting of each parameter must be identical to that of External Device.

☞ "3 Example of Communication Setting" (page 7)

4.1 Setup Items in GP-Pro EX

■ Communication Settings

To display the setting screen, select [Device/PLC Settings] from [System setting window] in workspace.

Device/PLC 1 [Change Device/PLC](#)

Summary
 Maker: Mitsubishi Electric Corporation Series: QnA Series CPU Direct Port: COM1
 Text Data Mode: 2 [Change](#)

Communication Settings
 SIO Type: RS232C RS422/485(2wire) RS422/485(4wire)
 Speed: 19200
 Data Length: 7 8
 Parity: NONE EVEN ODD
 Stop Bit: 1 2
 Flow Control: NONE ER(DTR/CTS) XON/XOFF
 Timeout: 3 (sec)
 Retry: 2
 Wait To Send: 0 (ms)

RI / VCC: RI VCC
 In the case of RS232C, you can select the 9th pin to RI (Input) or VCC (5V Power Supply). If you use the Digital's RS232C Isolation Unit or CPU I/F Cable for Mitsubishi PLC A Series (Digital's:GP430-IP10-D), please select it to VCC. Default

Device-Specific Settings
 Allowable No. of Device/PLCs: 1 Unit(s)

No.	Device Name	Settings
1	PLC1	

Setup Items	Setup Description
SIO Type	Select the SIO type to communicate with the External Device.
Speed	Select speed between the External Device and the Display.
Data Length	Select data length.
Parity	Select how to check parity.
Stop Bit	Select stop bit length.
Flow Control	Select the communication control method to prevent overflow of transmission and reception data.

continued to next page

Setup Items	Setup Description
Timeout	Use an integer from 1 to 127 to enter the time (s) for which the Display waits for the response from the External Device.
Retry	In case of no response from the External Device, use an integer from 0 to 255 to enter how many times the Display retransmits the command.
Wait To Send	Use an integer from 0 to 255 to enter standby time (ms) for the Display from receiving packets to transmitting next commands.
RI/VCC	You can switch RI/VCC of the 9th pin when you select RS232C for SIO type. It is necessary to change RI/5V by changeover switch of IPC when connect with IPC. Please refer to the manual of the IPC for more detail.

4.2 Settings in Off-Line Mode

- NOTE** • Please refer to Maintenance/Troubleshooting for more information on how to enter off-line mode or about operation.
Cf. Maintenance/Troubleshooting "2.2 Offline Mode"

■ Communication Settings

To display the setting screen, touch [Device/PLC Settings] from [Peripheral Settings] in off-line mode. Touch the External Device you want to set from the displayed list.

(Page 1/2)

Comm.				
QnA Series CPU Direct		[COM1]	Page 1/2	
SIO Type	RS232C			
Speed	19200			
Data Length	8			
Parity	ODD			
Stop Bit	1			
Flow Control	NONE			
Timeout(s)		3	▼	▲
Retry		2	▼	▲
Wait to Send(ms)		0	▼	▲
				➔
Exit		Back		2005/09/02 12:42:15

Setup Items	Setup Description
SIO Type	Select the SIO type to communicate with the External Device. IMPORTANT To make the communication settings correctly, confirm the serial interface specifications of Display unit for [SIO Type]. We cannot guarantee the operation if a communication type that the serial interface does not support is specified. For details concerning the serial interface specifications, refer to the manual for Display unit.
Speed	Select speed between the External Device and the Display.
Data Length	Data length is displayed.
Parity	The parity check method is displayed.
Stop Bit	Stop bit length is displayed.
Flow Control	The communication control method to prevent overflow of transmission and reception data is displayed.

continued to next page

Setup Items	Setup Description
Timeout (s)	Use an integer from 1 to 127 to enter the time (s) for which the Display waits for the response from the External Device.
Retry	In case of no response from the External Device, use an integer from 0 to 255 to enter how many times the Display retransmits the command.
Wait to Send (ms)	Use an integer from 0 to 255 to enter standby time (ms) for the Display from receiving packets to transmitting next commands.

(Page 2/2)

Comm.				
QnA Series CPU Direct		[COM1]	Page 2/2	
RI / VCC <input checked="" type="radio"/> RI <input type="radio"/> VCC In the case of RS232C, if you use the Digital's RS232C Isolation Unit or CPU I/F Cable for Mitsubishi PLC A Series (Digital's:GP430-IP10-0), please select it to VCC.				
				←
	Exit	Back	2006/12/08 09:24:07	

Setup Items	Setup Description
RI/VCC	You can switch RI/VCC of the 9th pin when you select RS232C for SIO type. It is necessary to change RI/5V by changeover switch of IPC when connect with IPC. Please refer to the manual of the IPC for more detail.

5 Cable Diagram

The cable diagram shown below may be different from the cable diagram recommended by Mitsubishi Electric Corp. Please be assured there is no operational problem in applying the cable diagram shown in this manual.

- The FG pin of the main body of the External Device must be D-class grounded. Please refer to the manual of the External Device for more details.
- SG and FG are connected inside the Display. When connecting SG to the External Device, design the system not to form short-circuit loop.
- Connect the isolation unit, when communication is not stabilized under the influence of a noise etc..

Cable Diagram 1

Display (Connection Port)	Cable	Notes
GP (COM1) IPC*1 PC/AT	Interface internal cable for Mitsubishi FA equipments by Diatrend Corp. DAFXIH-CABV (3m)	Available to order the length up to 15 m

*1 Only the COM port which can communicate by RS-232C can be used.

 ■ COM Port of IPC (page 4)

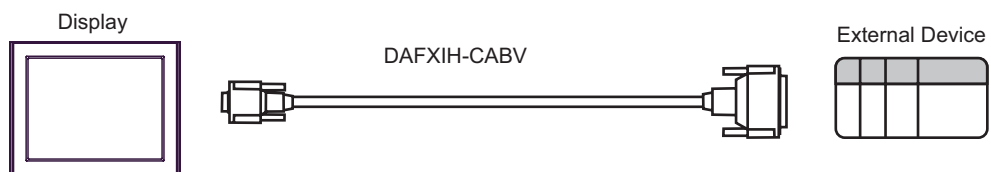

Cable Diagram 2

Display (Connection Port)	Cable		Notes
GP*1 (COM1) AGP-3302B (COM2) IPC*2	A	Mitsubishi A connection cable by Pro-face CA3-CBLA-01 (5m)	
	B	Your own cable	The cable length must be 5m or less.

*1 All GP models except AGP-3302B

*2 Only the COM port which can communicate by RS-422/485 (4 wire) can be used.

☞ ■ COM Port of IPC (page 4)

A) When using Mitsubishi A connection cable (CA3-CBLA-01) by Pro-face.

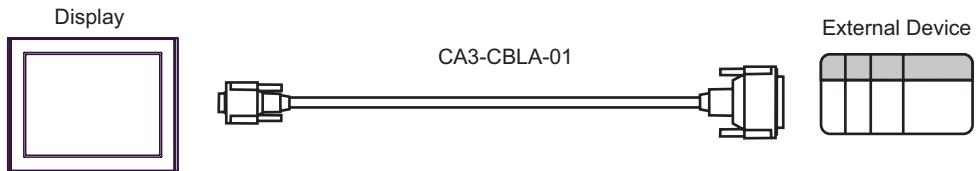

B) When using your own cable

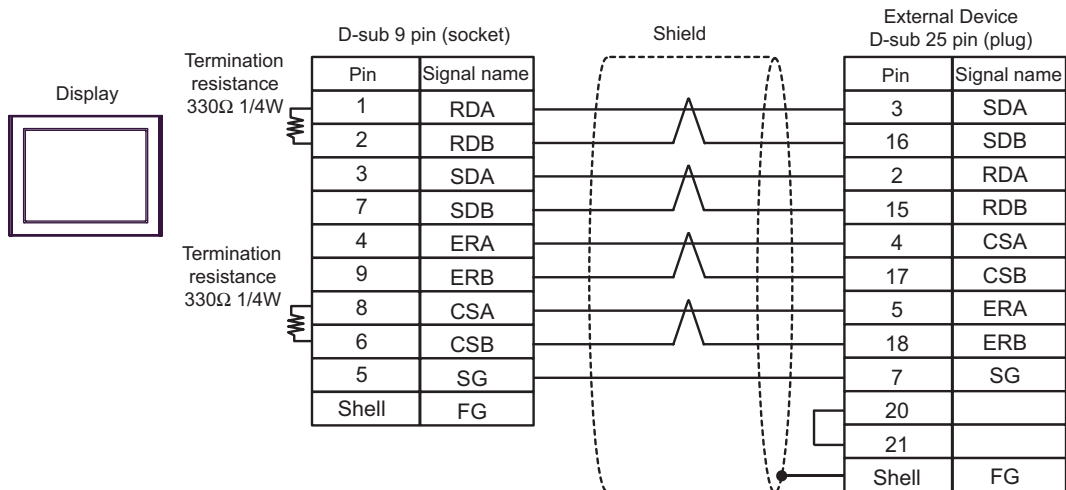

Cable Diagram 3

Display (Connection Port)	Cable		Notes
GP* ¹ (COM1) AGP-3302B (COM2) IPC* ²	A	COM port conversion adapter by Pro-face CA3-ADPCOM-01 + 2-port adapter cable for AGP by Pro-face CA3-MDCB11 (5m) + 2-port adapter II by Pro-face GP070-MD11	
	B	Your own cable + 2-port adapter II by Pro-face GP070-MD11	The cable length must be 600m or less.
GP* ³ (COM2)	C	Online adapter by Pro-face CA4-ADPONL-01 + 2-port adapter cable for AGP by Pro-face CA3-MDCB11 (5m) + 2-port adapter II by Pro-face GP070-MD11	
	D	Online adapter by Pro-face CA4-ADPONL-01 + Your own cable + 2-port adapter II by Pro-face GP070-MD11	The cable length must be 600m or less.

*1 All GP models except AGP-3302B

*2 Only the COM port which can communicate by RS-422/485 (4 wire) can be used.

 ■ COM Port of IPC (page 4)

*3 All GP models except GP-3200 series and AGP-3302B

A) When using COM port conversion adapter (CA3-ADPCOM-01), 2-port adapter cable for AGP (CA3-MDCB11) by Pro-face and 2-port adapter II (GP070-MD11) by Pro-face

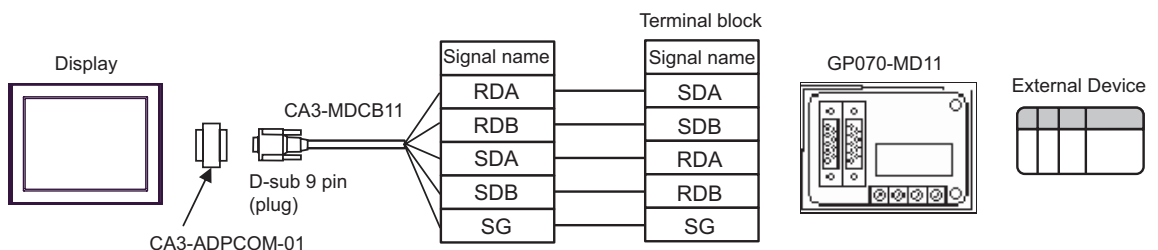

B) When using your own cable and 2-port adapter II (GP070-MD11) by Pro-face.

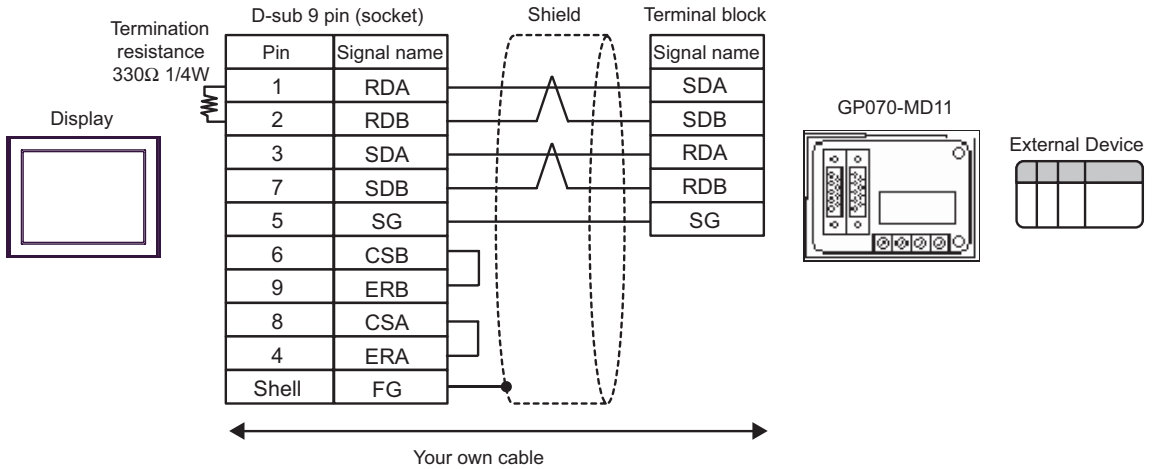

C) When using online adapter (CA4-ADPONL-01), 2-port adapter cable for AGP (CA3-MDCB11) by Pro-face and 2-port adapter II (GP070-MD11) by Pro-face.

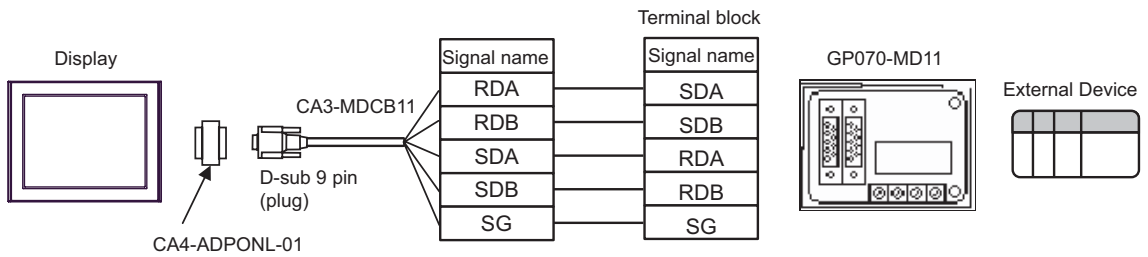



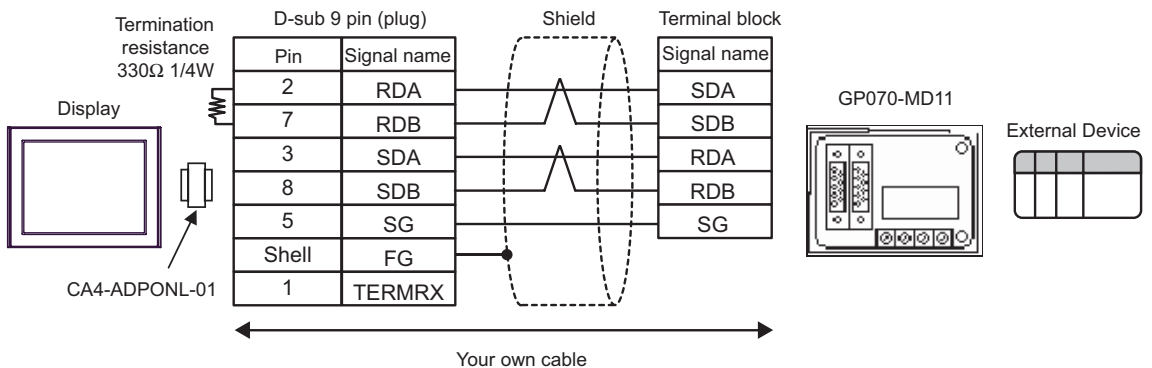









D) When using online adapter (CA4-ADPONL-01) by Pro-face, your own cable and 2-port adapter II (GP070-MD11) by Pro-face.



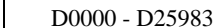

6 Supported Device

Range of supported device address is shown in the table below.

 This address can be specified as system data area.

Device	Bit Address	Word Address	32 bits	Notes
Input Relay	X0000 - X1FFF	X0000 - X1FF0	[L/H]	
Output Relay	Y00000 - Y1FFF	Y0000 - Y1FF0		
Internal Relay	M00000 - M32767	M00000 - M32752		
Special Relay	SM0000 - SM2047	SM0000 - SM2032		
Latch Relay	L000000 - L32767	L00000 - L32752		
Annunciator	F00000 - F32767	F00000 - F32752		
Edge Relay	V00000 - V32767	V00000 - V32752		
Step Relay	S0000 - S8191	S0000 - S8176		
Link Relay	B0000 - B7FFF	B0000 - B7FF0		
Special Link Relay	SB000 - SB7FF	SB000 - SB7F0		
Timer (Contact)	TS00000 - TS23087	-----		
Timer (Coil)	TC00000 - TC23087	-----		
Retentive Timer (Contact)	SS00000 - SS23087	-----		
Retentive Timer (Coil)	SC00000 - SC23087	-----		
Counter (Contact)	CS00000 - CS23087	-----		
Counter (Coil)	CC00000 - CC23087	-----		
Timer (Current Value)	-----	TN0000 - TN23087		
Retentive Timer (Current Value)	-----	SN0000 - SN23087		
Counter (Current Value)	-----	CN0000 - CN23087		
Data Register	-----	 D0000 - D25983		
Special Register	-----	SD0000 - SD2047		
Link Register	-----	W0000 - W657F		
Special Link Register	-----	SW000 - SW7FF		

continued to next page

Device	Bit Address	Word Address	32 bits	Notes
File Register (Normal)	-----	R00000 - R32767	[L/H]	 *1
File Register (Block switching is not necessary)	-----	ZR0000000 - ZR1042431		 *1
File Register*2 (0R - 31R)	-----	0R00000 - 0R32767		 *1
	-----	1R00000 - 1R32767		
	-----	2R00000 - 2R32767		
	-----	3R00000 - 3R32767		
	:	:		
	-----	28R00000 - 28R32767		
	-----	29R00000 - 29R32767		
-----	30R00000 - 30R32767			
-----	31R00000 - 31R26623			

*1 You need the memory card when using the file register.

*2 Set the block No. on the head of device name. This is the device name for conversion with GP-Pro/PB III for Windows. When you newly specify the device, we recommend that you should use the file register (Block switching is not necessary).

NOTE

- Please refer to the GP-Pro EX Reference Manual for system data area.
Cf. GP-Pro EX Reference Manual "Appendix 1.4 LS Area (only for direct access method)"
- Please refer to the precautions on manual notation for icons in the table.
 "Manual Symbols and Terminology"
- Even if you use an address not existing in the External Device, no read error may be displayed. In this case, the read-out data keeps 0.
In writing, an error is displayed.

7 Device Code and Address Code

Use device code and address code when you select "Device Type & Address" for the address type in data displays.

Device	Device Name	Device Code (HEX)	Address Code
Input Relay	X	0080	Value of word address divided by 0x10
Output Relay	Y	0081	Value of word address divided by 0x10
Internal Relay	M	0082	Value of word address divided by 16
Special Relay	SM	0083	Value of word address divided by 16
Latch Relay	L	0084	Value of word address divided by 16
Annunciator	F	0085	Value of word address divided by 16
Edge Relay	V	0086	Value of word address divided by 16
Step Relay	S	0087	Value of word address divided by 16
Link Relay	B	0088	Value of word address divided by 0x10
Special Link Relay	SB	0089	Value of word address divided by 0x10
Timer (Current Value)	TN	0060	Word Address
Retentive Timer (Current Value)	SN	0062	Word Address
Counter (Current Value)	CN	0061	Word Address
Data Register	D	0000	Word Address
Special Register	SD	0001	Word Address
Link Register	W	0002	Word Address
Special Link Register	SW	0003	Word Address
File Register (Normal)	R	000F	Word Address
File Register (Block switching is not necessary)	ZR	000E	Word Address

Device	Device Name	Device Code (HEX)	Address Code
File Register (0R - 31R)	0R	0010	Word Address
	1R	0011	Word Address
	2R	0012	Word Address
	3R	0013	Word Address
	:	:	:
	28R	002C	Word Address
	29R	002D	Word Address
	30R	002E	Word Address
	31R	002F	Word Address

8 Error Messages

Error messages are displayed on the screen of Display as follows: "No. : Device Name: Error Message (Error Occurrence Area)". Each description is shown below.

Item	Description
No.	Error No.
Device Name	Name of External Device where error occurs. Device name is a title of External Device set with GP-Pro EX.(Initial value [PLC1])
Error Message	Displays messages related to the error which occurs.
Error Occurrence Area	<p>Displays IP address or device address of External Device where error occurs, or error codes received from External Device.</p> <p>NOTE</p> <ul style="list-style-type: none"> • IP address is displayed such as "IP address(Decimal): MAC address(Hex)". • Device address is displayed such as "Address: Device address". • Received error codes are displayed such as "Decimal[Hex]".

Display Examples of Error Messages

"RHAA035: PLC1: Error has been responded for device write command (Error Code: 2 [02])"

NOTE

- Please refer to the manual of External Device for more detail of received error codes.
- Please refer to "When an error message is displayed (Error code list)" of "Maintenance/Troubleshooting" for a common error message to the driver.

