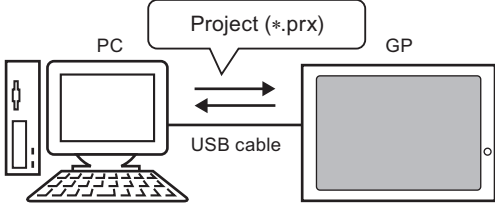

33 | Transferring Data

This chapter explains how to transfer project files you created in GP-Pro EX to GP and how to transfer project files currently stored in the GP to your PC to display the project on the GP. Please start by reading “33.1 Settings Menu” (page 33-2) and then turn to the corresponding page.

33.1	Settings Menu	33-2
33.2	Transferring Project Files via USB Cable Transfer	33-5
33.3	Transferring Project Files via Ethernet (LAN)	33-12
33.4	Comparing Project Changes Prior to Transfer	33-25
33.5	Transferring Data Only to a CF Card	33-28
33.6	Transferring with Passwords	33-31
33.7	Transferring project files using a CF Card or USB storage	33-36
33.8	Updating Remote Screen Data via Modem	33-49
33.9	Checking Errors	33-54
33.10	Setting Up Transfer Tool	33-57
33.11	Restrictions	33-70

33.1 Settings Menu

Transferring Project Files via USB Cable Transfer	
<p>Use a USB transfer cable to transfer project files (*.prx).</p> 	<ul style="list-style-type: none"> ☞ Setup Procedure (page 33-6) ☞ Introduction (page 33-5)

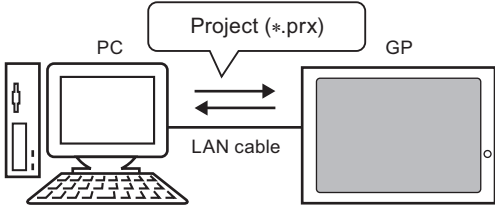
Transferring Project Files via Ethernet (LAN)	
<p>Use a LAN cable to transfer project files (*.prx).</p> 	<ul style="list-style-type: none"> ☞ Setup Procedure (page 33-13) ☞ Introduction (page 33-12)

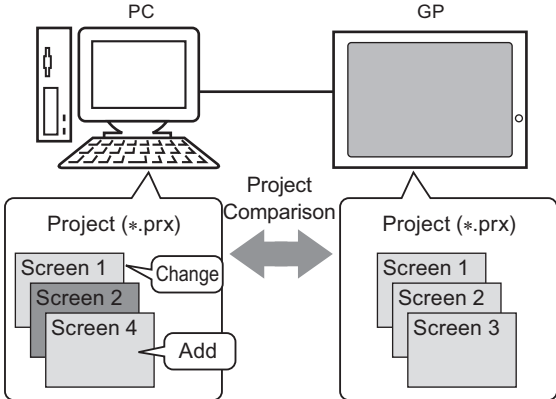
Comparing Project Changes Prior to Transfer	
<p>Compare the project files (*.prx) on the PC and GP to check which screens have been updated.</p> 	<ul style="list-style-type: none"> ☞ Setup Procedure (page 33-26) ☞ Introduction (page 33-25)

Transferring Data Only to a CF Card	
<p>Without transferring the project file, copy recipe data to the CF Card in the GP, and alarm data from the CF Card to a PC.</p>	<ul style="list-style-type: none"> ☞ Setup Procedure (page 33-29) ☞ Introduction (page 33-28)

Transferring with Passwords	
<p>When transferring data, a password can be required to prevent unauthorized access and transfer.</p> <p>Try to transfer and...</p>	<ul style="list-style-type: none"> ☞ Setup Procedure (page 33-32) ☞ Introduction (page 33-31)

Transferring project files using a CF Card or USB storage	
<p>Transfers project files between GP and your PC using a CF Card or USB storage.</p> <p>Create Backup Data Download</p>	<ul style="list-style-type: none"> ☞ Setup Procedure (page 33-37) ☞ Introduction (page 33-36)

Updating Remote Screen Data via Modem

Connect the modem to GP and transfer the screen data from your PC to GP.

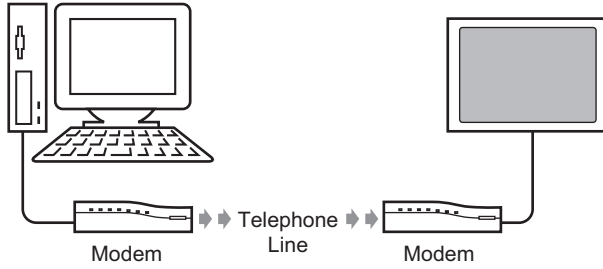

- ☞ Transfer Process (page 33-50)
- ☞ Introduction (page 33-49)

Checking Errors

Check errors before you send the project data.

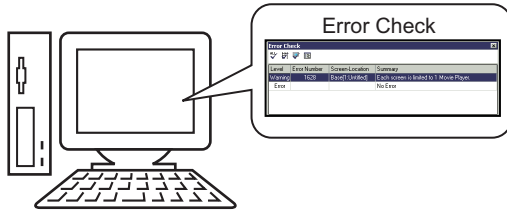

- ☞ Setup Procedure (page 33-55)
- ☞ Introduction (page 33-54)

33.2 Transferring Project Files via USB Cable Transfer

Use a USB transfer cable made by Digital (type: CA3-USBCB-01) to connect a PC to the GP and transfer project files (*.prx).

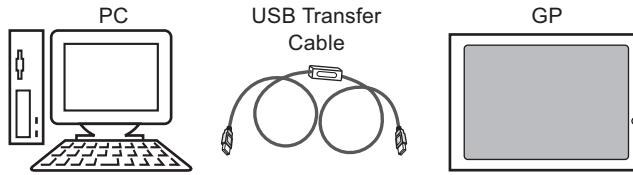

IMPORTANT

- For information on the cable's specifications and usage, refer to the user manual for the USB transfer cable you are using.

33.2.1 Introduction

- Transfer from PC → GP (Send)

You can send the selected project files (*.prx) to the GP for display.

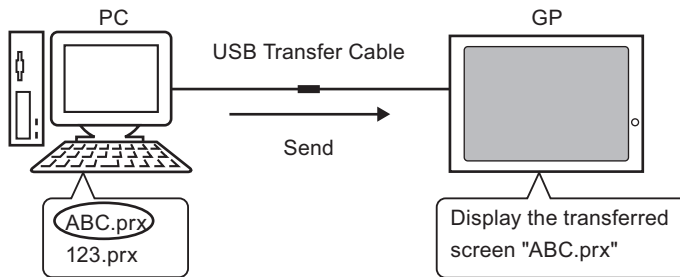

- Transfer from GP → PC (Receive)

Project data stored in the GP can be transferred to the PC as a new project file (*.prx)

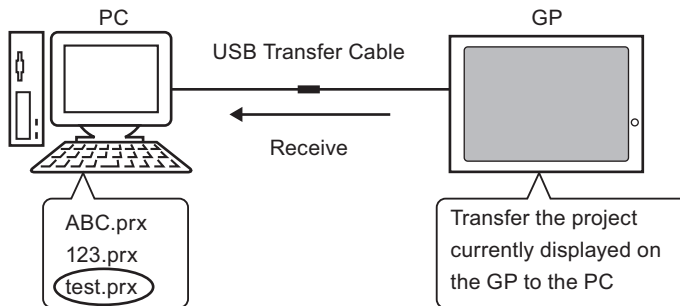

33.2.2 Transfer Process

■ Transfer from PC to GP (Send)

The following explains the procedure for transferring project files to the GP for the first time.

-
- NOTE**
- For more information about the Send function, please refer to “33.10.3 How Sending Data Works” (page 33-66) .
 - Please refer to the settings guide for details.
 ☞ “33.10 Setting Up Transfer Tool” (page 33-57)
-

1 Connect the PC and GP using the USB transfer cable. If the USB cable driver is not installed, a dialog box appears. Install the driver as directed.

-
- NOTE**
- Depending on the security level of WindowsXP, the [Hardware Installation] dialog box below may appear while you are installing the USB driver. Click [Continue (C)] to start installing the CA3-USBCB-01 driver. Click [Finish] when the installation is complete.



2 Turn ON the GP. The [Initial Start Mode] screen appears.
(GP Screen)

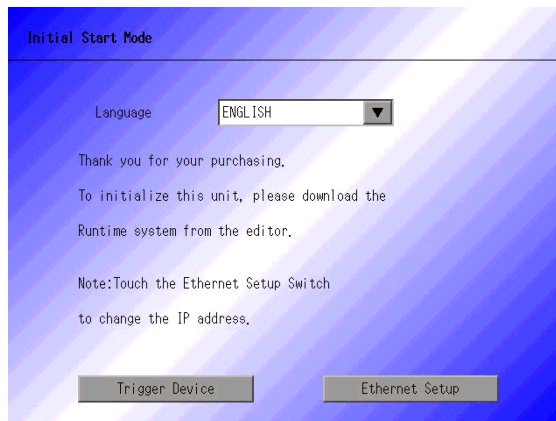

This screen will appear when you first connect the GP's power cord. After transferring a project once, this screen will not appear.

3 On the GP-Pro EX state tool bar, click the Transfer Project icon . The [Transfer Tool] dialog box appears.

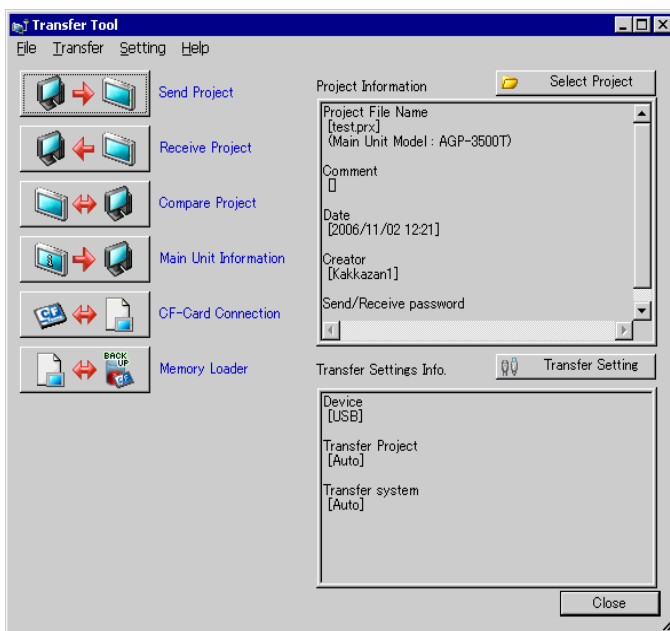

4 Confirm the project details in [Project Information].

To transfer a different project, click the [Select Project] button and choose the appropriate project.

5 In [Transfer Information], acknowledge that [Device] is [USB]. If [USB] is not selected, click [Transfer Settings]. The [Transfer Settings] dialog box appears. In [Communication Port Settings], select [USB] and click [OK].

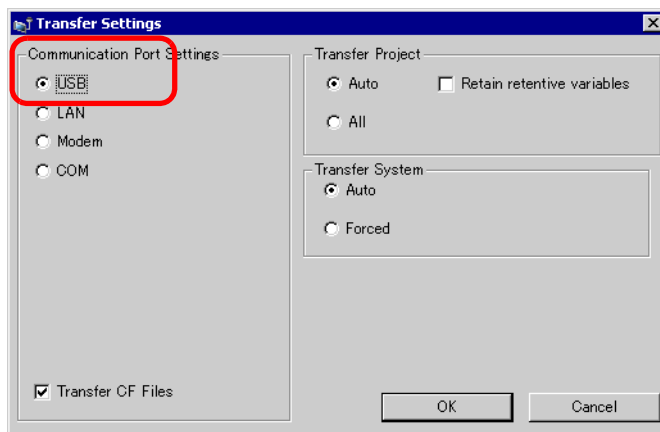

6 In [Transfer Tool], click [Send Project].

The transfer begins. When the following dialog box appears, click [Yes]. This dialog box is not displayed when the same project file is sent again.

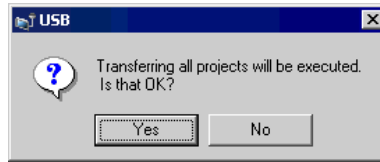

The following dialog box appears during transfer to check the communication status. During the transfer, the GP changes to Transferring mode and communication with the device/PLC is suspended.

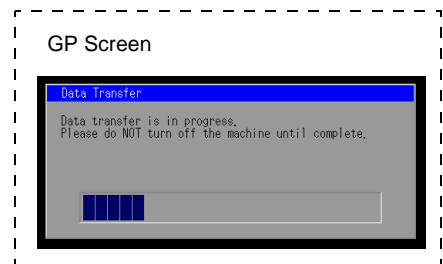
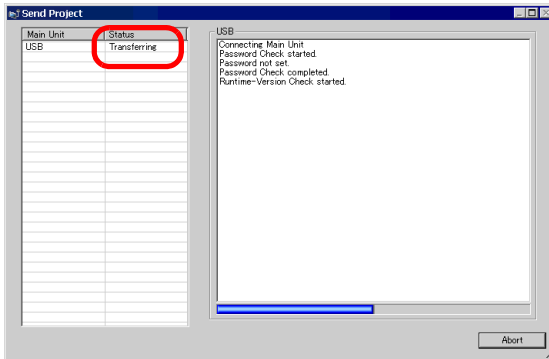

7 When the transfer finishes, the status changes from [Transferring] to [Complete Transfer]. Click [Close]. The GP is reset and the transferred screens are displayed.

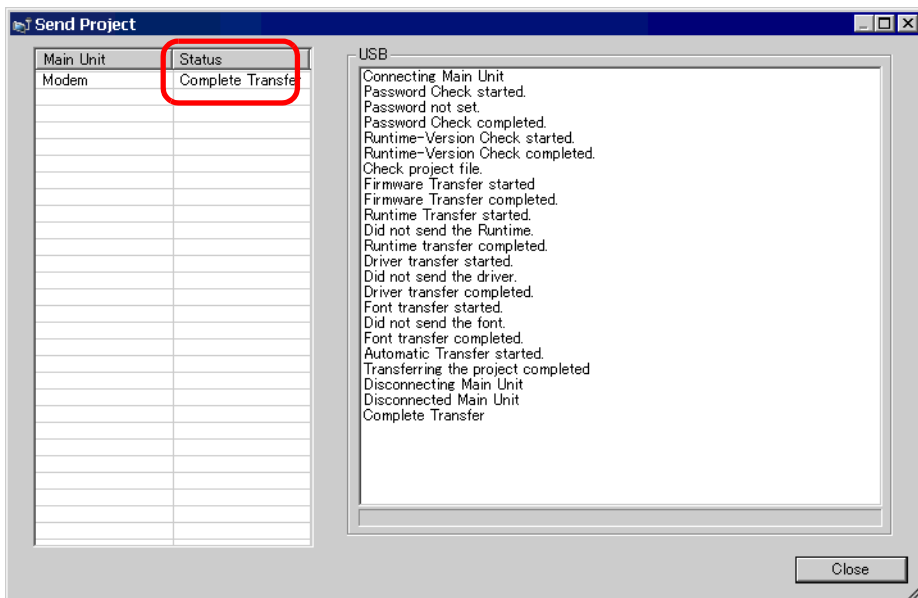



8 Click [Close] to return to the Transfer Tool. Click [Close] again to close the Transfer Tool.

■ Transfer from GP to PC (Receive)

Transfers project data currently stored on the GP to a PC.

NOTE

- For more information about the Receive function, please refer to “33.10.4 How Receive Works” (page 33-67)
- Please refer to the settings guide for details.
 “33.10 Setting Up Transfer Tool” (page 33-57)

- 1 Connect the PC and GP using the optional USB transfer cable set.
- 2 On the GP-Pro EX state tool bar, click the Transfer Project icon  . The [Transfer Tool] dialog appears.

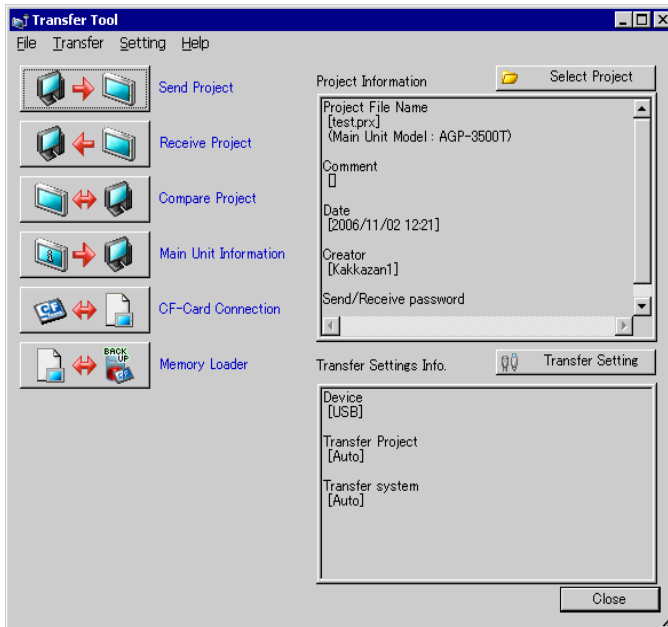

- 3 In [Transfer Information], acknowledge that [Device] is [USB]. If [USB] is not selected, click [Transfer settings] to display the [Transfer settings] dialog box below. In [Communication Port Settings], select [USB] and click [OK].

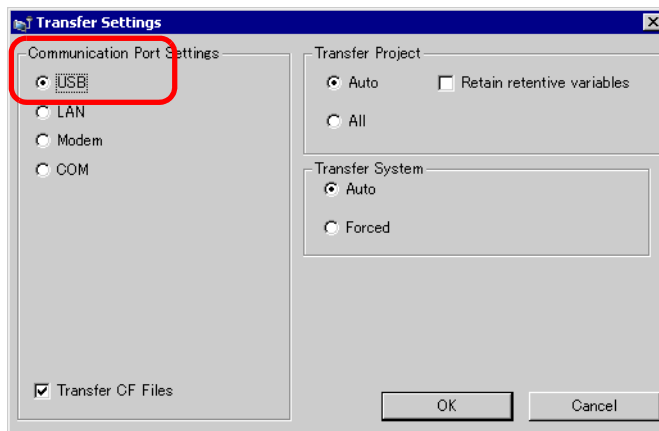

- 4 Click [Receive project]. When the following dialog box appears, specify the location to save the data you are receiving and the project file name. Click [Save (S)] to start the transfer.

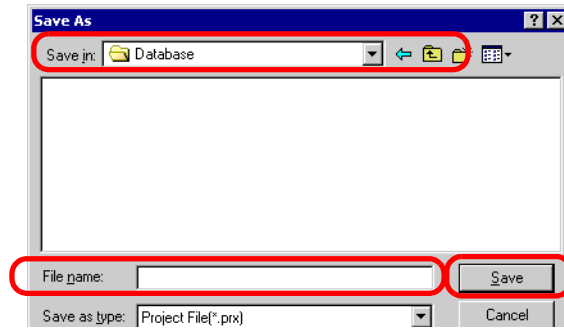

The following dialog box appears during transfer to check the communication status.

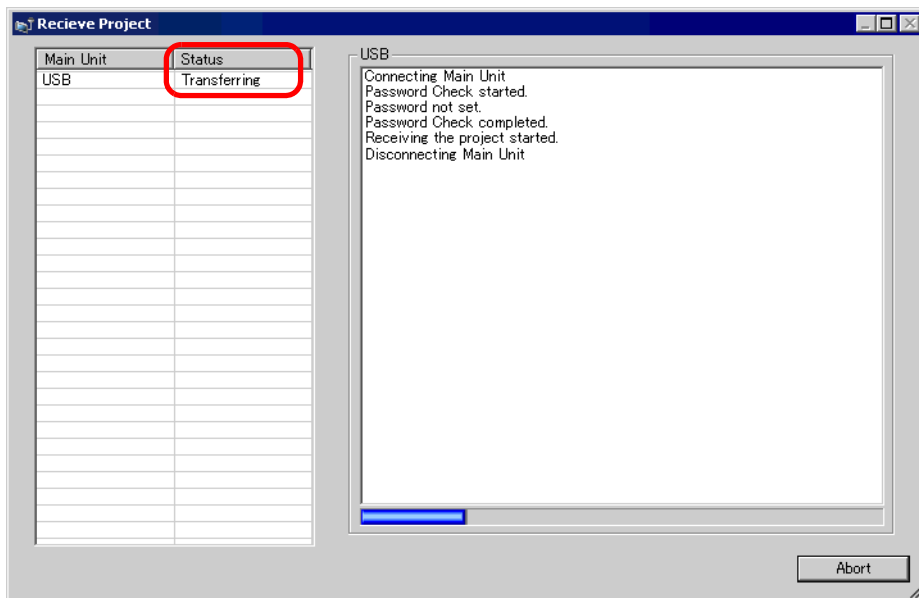

- 5 When the transfer finishes, the status changes from [Transferring] to [Complete Transfer]. Click [Close].

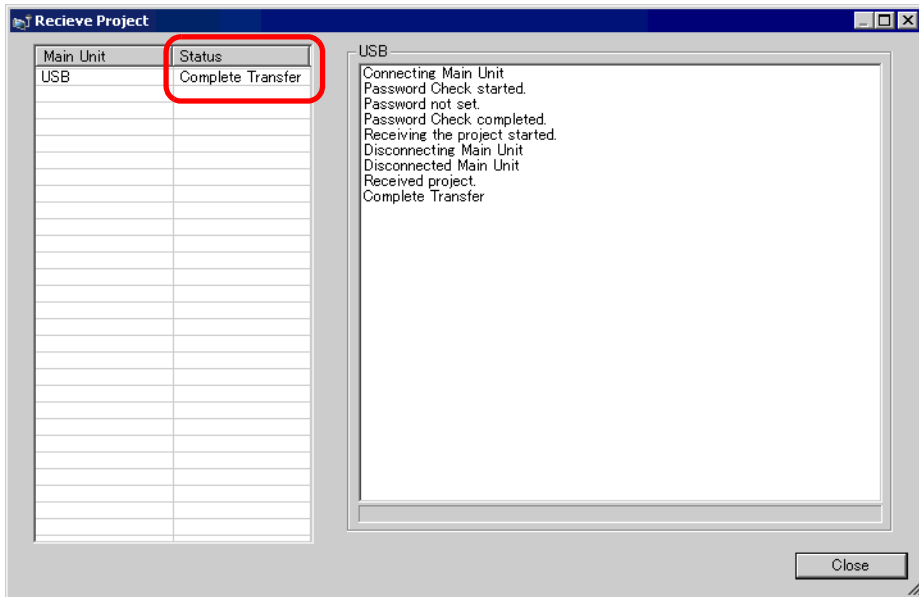

If you receive a project file that uses CSV Data Recipes or other CF Card data, the following dialog box appears. Specify the location to save the CF Card data. Click [OK] to finish the process.

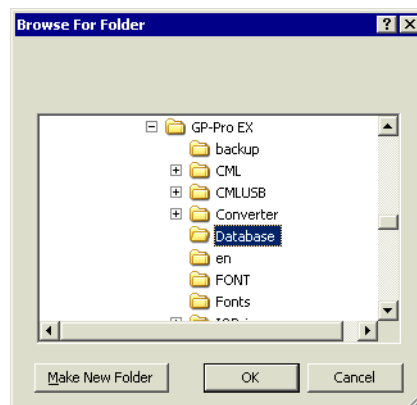

- 6 Click [Close] to return to the Transfer Tool. Click [Close] again to close the Transfer Tool.

33.3 Transferring Project Files via Ethernet (LAN)

Use an Ethernet connection to transfer project files over the LAN.

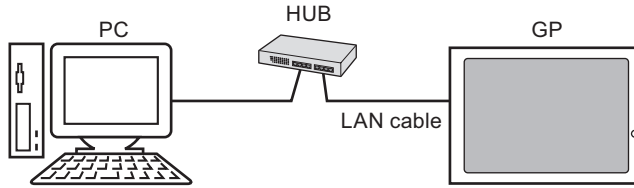

IMPORTANT

- To communicate using Ethernet, Ethernet settings, such as the IP address and port number, must be set up on the GP.

NOTE

- 1:1 connections using a cross cable may not be possible depending on the type of PC and network card you are using. Make sure to use a HUB for Ethernet Communication.

33.3.1 Introduction

- Transfer from PC → GP (Send)
 You can send the selected project files (*.prx) to the GP to display the project.
 The same project can be sent to multiple GPs on the network.

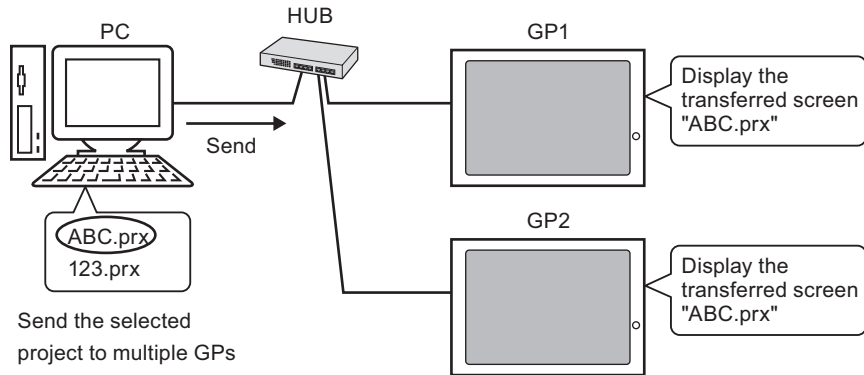

- Transfer from GP → PC (Receive)
 Project data stored in the GP can be saved to the PC as a new project file (*.prx)
 Even if multiple GPs exist on the network, data can only be received from one GP.

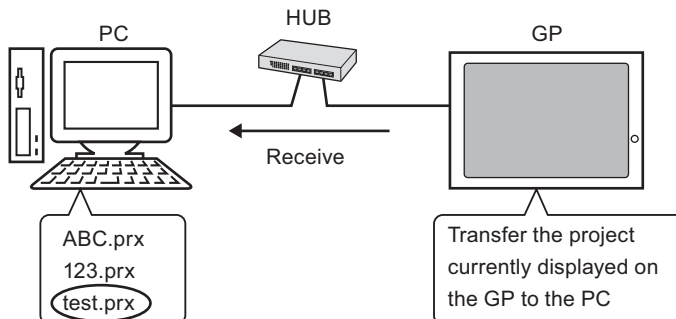

33.3.2 Transfer Process

■ Transfer from PC to GP (Send)

This procedure is used when sending the first project to the GP.

NOTE

- For more information about the Send function, please refer to “33.10.3 How Sending Data Works” (page 33-66) .
- The IP address preset at the time of purchase can be used to transfer data.
 ☞ “ ■ Data Transfer Using the Factory-set IP Address” (page 33-21)
- Please refer to the settings guide for details.
 ☞ “33.10 Setting Up Transfer Tool” (page 33-57)

- 1 Connect the LAN cable to the GP to establish the network with the PC installed with GP-Pro EX. (Designate the same network IP address on your PC).
- 2 Turn ON the GP to display the initial screen.

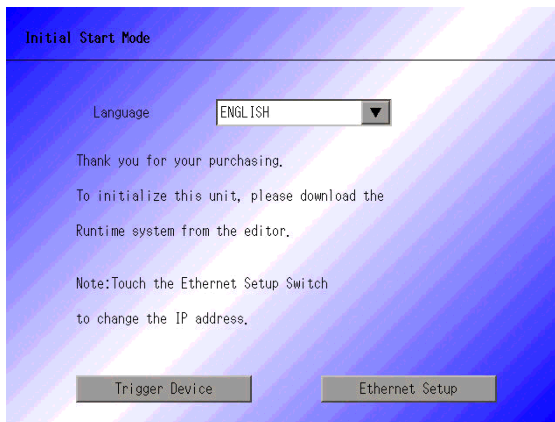

This screen will appear when you first connect the GP's power cord. After transferring a project once, this screen will not appear.

- 3 Set the IP address on the GP. Touch [Ethernet Setup]. The following screen appears and the contents set at the time of transfer are displayed.

NOTE

- The IP address is set by default to 10.***.***.***. The *** part depends on the individual model.

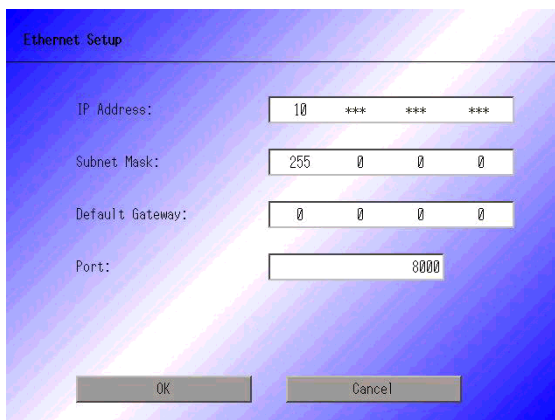

4 Modify the IP address, subnet mask, and touch [OK].

For example, First GP unit: [IP Address] 192.168.0.1; [Subnet Mask] 255.255.255.0)
Set the IP address of the same network also to other GPs.

5 The confirm restart message appears. Touch [Yes] and the system restarts.

After restarting, the [Initial Start Mode] screen is displayed.

NOTE

- Once a project has been transferred, the next time you transfer a project, the [Initial Start Mode] screen does not appear. To change the Ethernet settings, do so on the GP offline screen.

6 On the GP-Pro EX state tool bar, click the Transfer Project icon . The [Transfer Tool] dialog box appears.

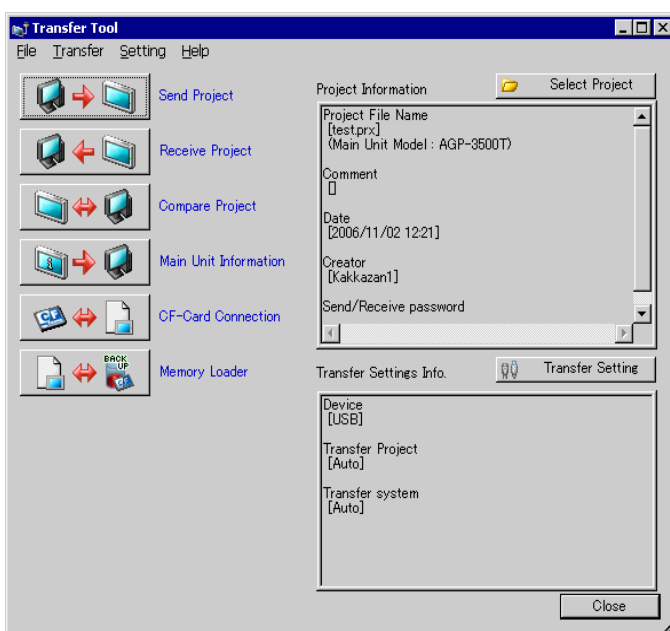

7 Confirm the project details in [Project Information].

To transfer a different project, click the [Select Project] button and choose the appropriate project.

8 Click the [Transfer Setting] button. Ensure that [Communication Port Settings] is set to [LAN]. Select the [LAN Auto Setting] then click [OK].

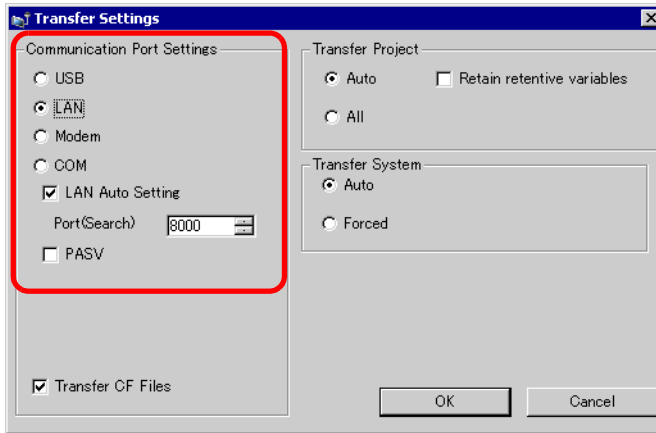

You can also open the dialog box on the [Project (F)] menu by pointing to [Transfer Project (G)] and selecting [Transfer Settings (C)].

9 Click [Send Project]. The [Select Display Unit] dialog box displays the IP addresses of the GPs available on the network.

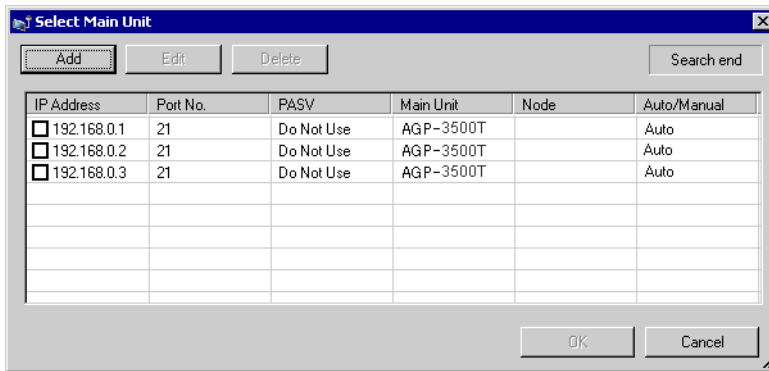

NOTE

- Detects the display units connected to the same subnet mask as the PC.
- If the IP address is not automatically detected, click [Add] and manually enter the IP address. You can change the port number when WinGP is in use.

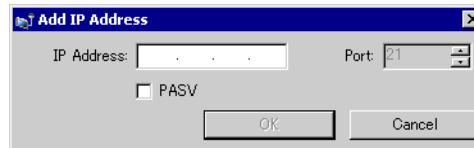

- If you cannot transfer because of firewall or router restrictions, selecting the [PASV] check box sometimes allows you continue with the transfer.

- 10 Select each IP address of the GP you want to transfer to and click [OK]. The transfer begins. When multiple IP addresses are checked, the project is sent to multiple GPs at once.

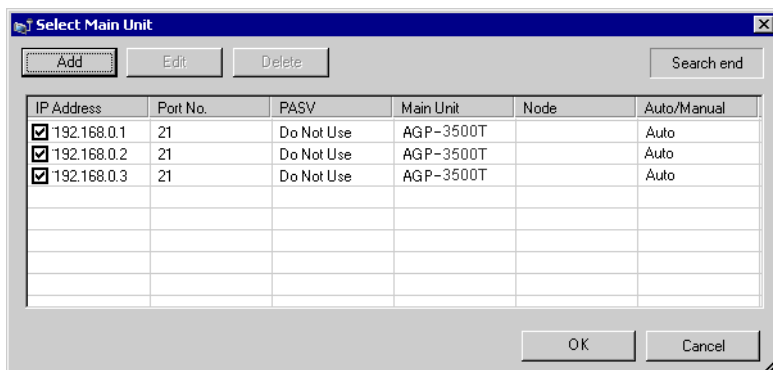

- 11 When the following dialog box appears, click [Yes]. This dialog box is not displayed when the same project file is sent again.

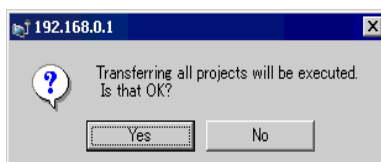

The following dialog box appears during transfer to check the communication status. The following is an example of sending multiple projects. During the transfer, the GP changes to Transferring mode and communication with the device/PLC is suspended.

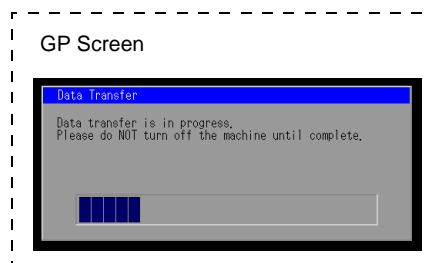
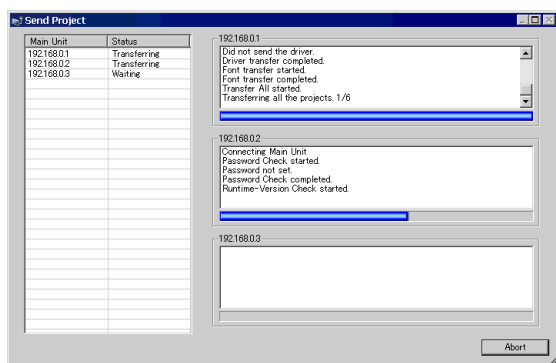

NOTE

- If you select multiple IP addresses, the project is transferred to one GP, then the next, in sequence.
- If a project file is password protected, the transfer cannot start until the password is confirmed.

■ Transfer from GP to PC (Receive)

Receives project data currently stored on the GP to a PC. You must set an IP address on the GP prior to receiving data using Ethernet.

NOTE

- For more information about the Receive function, please refer to “33.10.4 How Receive Works” (page 33-67) .
- Please refer to the settings guide for details.
 ☞ “33.10 Setting Up Transfer Tool” (page 33-57)
- Set an IP address in the "Ethernet Settings" on the offline screen.

1 Connect the LAN cable to the GP to establish the network with the PC installed with GP-Pro EX. (Designate the same network IP address on your PC).

2 On the GP-Pro EX state tool bar, click the Transfer Project  icon to launch the transfer tool.

Make sure that [LAN] is selected for [Device] in [Transfer Settings].

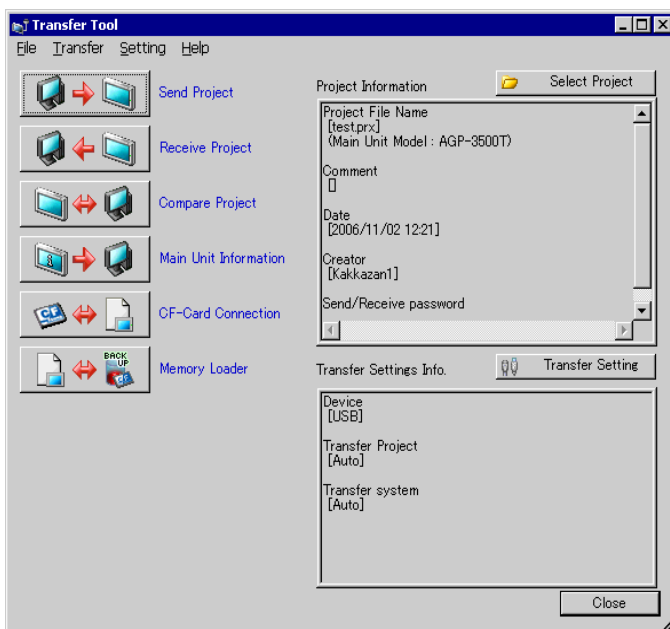

3 Click [Receive Project]. The following dialog box appears. Specify the [Save in] location and [File name] for the data to be received, and click [Save].

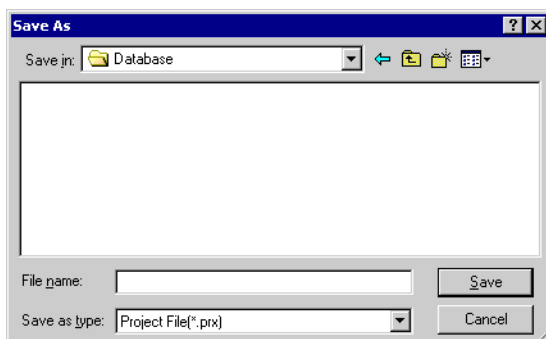

4 The [Select Display Unit] dialog box appears. Select each IP address of the target GP and click [OK]. The transfer begins.

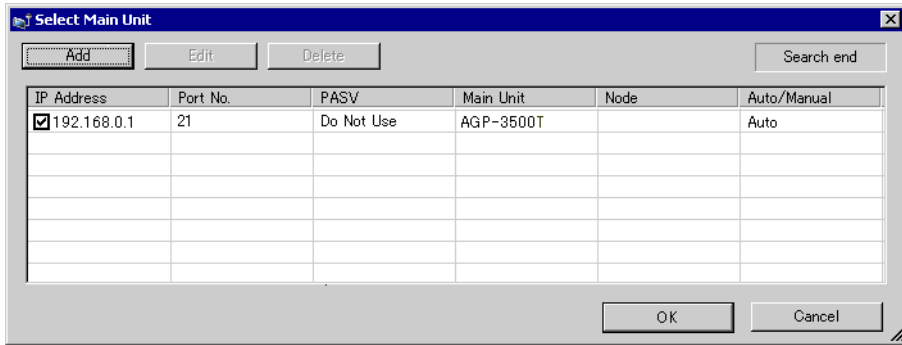

NOTE

- Only GPs corresponding to the subnet masks of the PCs used for transfer are displayed.
- If the IP address was not automatically acquired, click [Add] and manually enter the IP address.

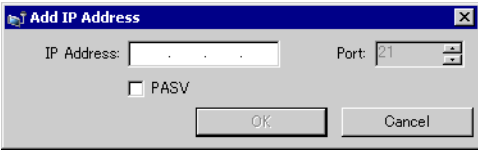

- If you cannot transfer because of firewall or router restrictions, selecting the [PASV] check box sometimes allows you continue with the transfer.

The following dialog box appears during file reception to check the communication status.

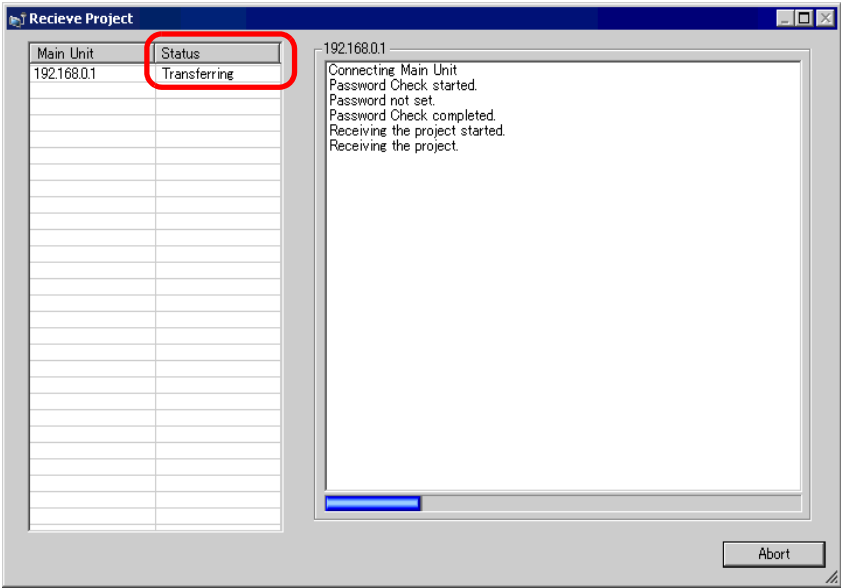

- 5 When the transfer finishes, the status changes from [Transferring] to [Complete Transfer]. Click [Close].

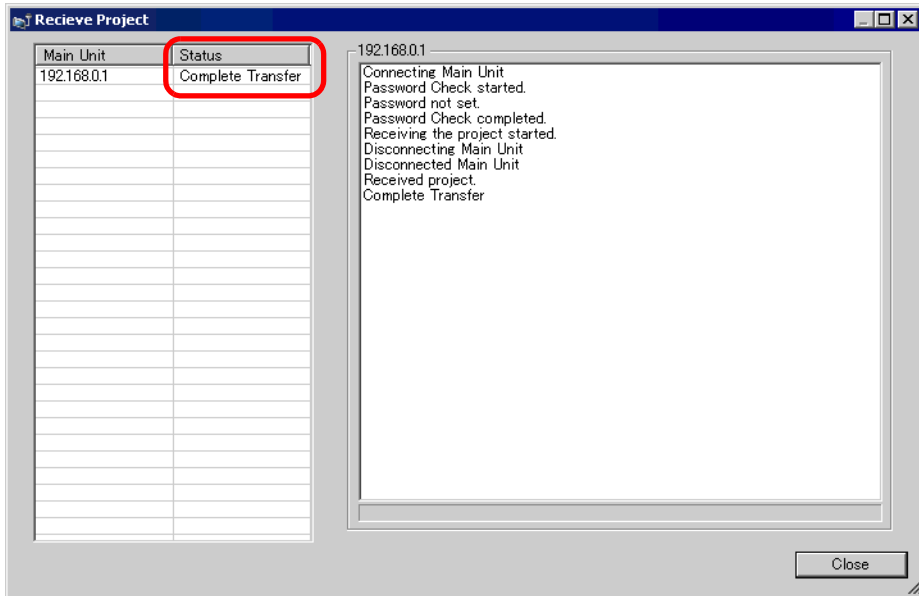

If you receive a project file that uses CSV Data Recipes or other CF Card data, the following dialog box appears. Specify the location to save the CF Card data. Click [OK] to finish the process.

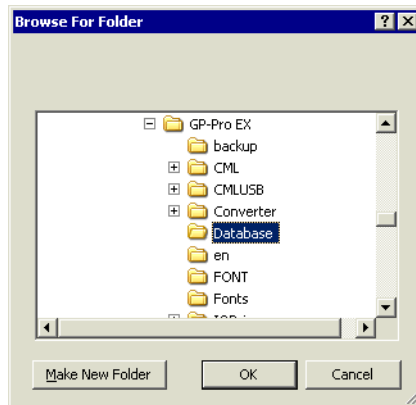

- 6 Click [Close] to return to the Transfer Tool. Click [Close] again to close the Transfer Tool.

■ Data Transfer Using the Factory-set IP Address

The default IP address of the GP is set at the factory. When transferring with this IP address, change the IP address used by the PC to which you are transferring data.

IMPORTANT

- Do not use the factory-set IP address when a private address "10.***.***.***" is used on the same network. A network communication error may occur.

NOTE

- Please refer to the settings guide for details.
☞ "33.10 Setting Up Transfer Tool" (page 33-57)

1 Modify the PC's IP address subnet mask.

Set the IP address within the range of "10.255.255.1" to "10.255.255.254" and the subnet mask to "255.0.0.0".

NOTE

- You may have to restart the PC before the settings take effect.

2 Connect the LAN cable to the GP to establish the network with the PC installed with GP-Pro EX.

3 Turn ON the GP to display the initial screen.

Ethernet settings do not need to be set.

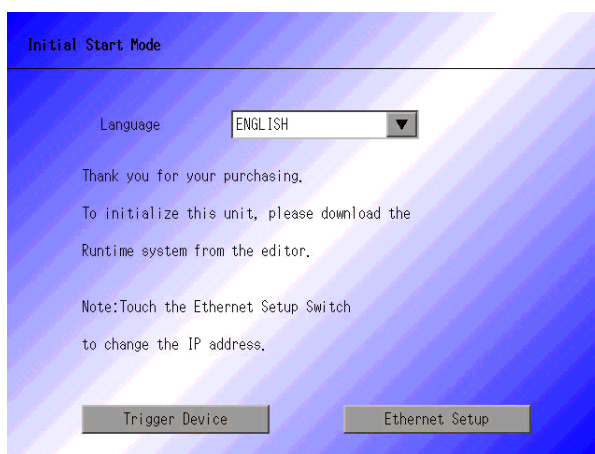

4 On the GP-Pro EX state tool bar, click the Transfer Project icon . The [Transfer Tool] dialog box appears.

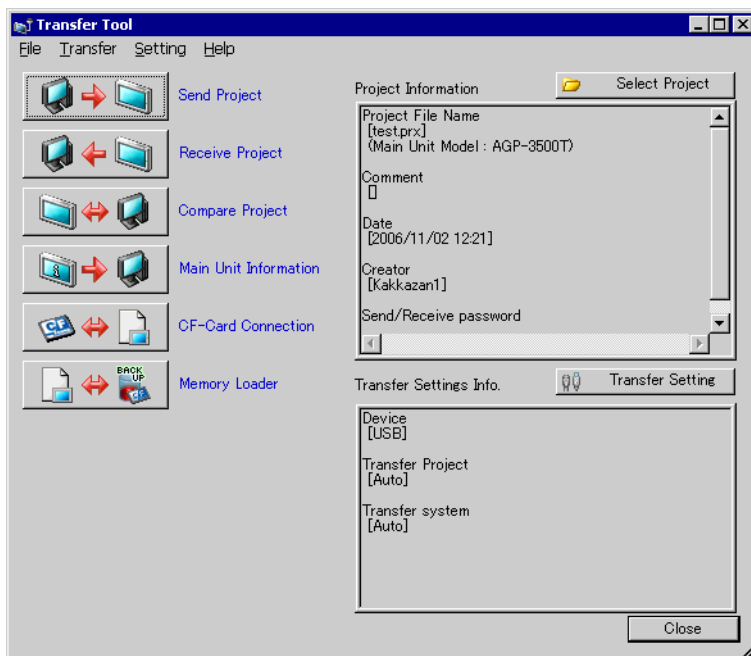

5 Click the [Transfer Settings] button. Ensure that [Communication Port Settings] is set to [LAN]. Select the [LAN Auto Setting] then click [OK].

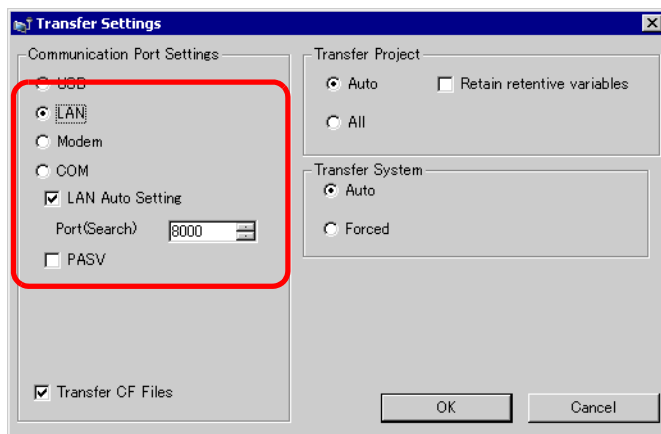

You can also open the dialog box on the [Project (F)] menu by pointing to [Transfer Project (G)] and selecting [Transfer Settings (C)].

6 Click [Send Project]. The [Select Display Unit] dialog box displays the IP addresses of the GPs available on the network. The transfer will begin. When multiple IP addresses are checked, the project are sent to multiple GPs at once.

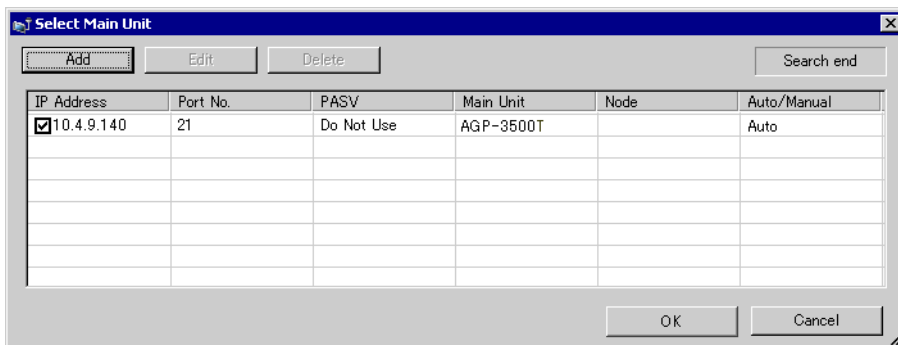

NOTE

- If the GP's IP address and subnet mask have changed, data can not be retrieved. Ensure that you update these items in the PC settings.

The following dialog box appears during transfer to check the communication status. During the transfer, the GP changes to Transferring mode and communication with the device/PLC is suspended.

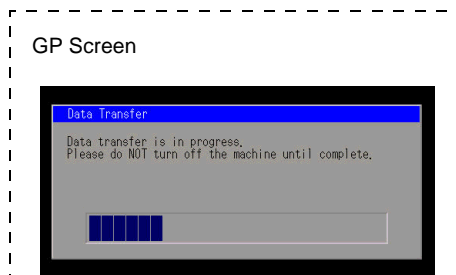
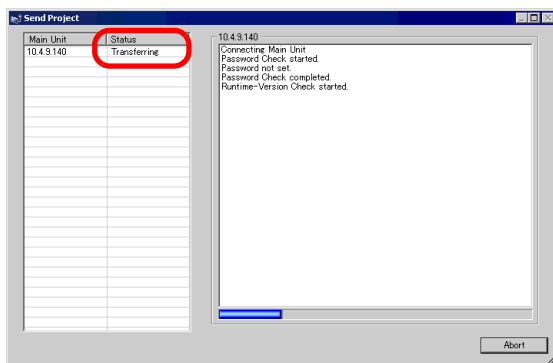

33.4 Comparing Project Changes Prior to Transfer

33.4.1 Introduction

Compares projects currently open in GP-Pro EX (or selected projects) to those stored on the GP. This is useful to acknowledge which screens you have updated before transferring the file.

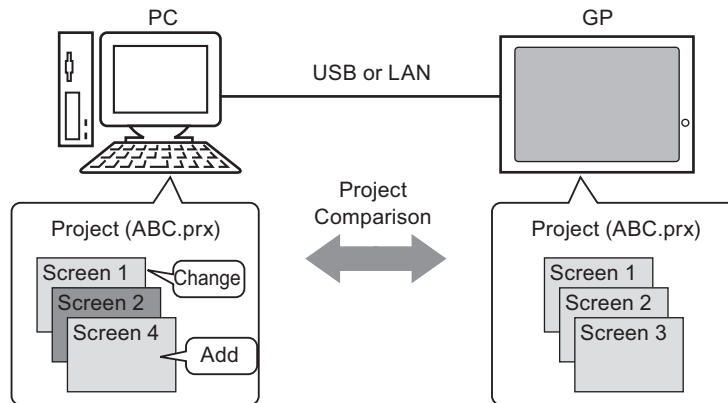

The comparison displays the following information:

- Screen numbers are the same, and screen contents are different. → The screen is updated on the GP.
- Screen(s) exist only on the PC → The screen is added to the GP.
- Screen (s) exist only on the GP → The screen is deleted from the GP.

NOTE

- You can only run a comparison for one GP at a time, even when connected on a LAN.

33.4.2 Comparison Procedure

Compares the project currently open in GP-Pro EX to that stored on the GP connected through LAN.

NOTE

- Please refer to the settings guide for details.
 ☞ “33.10 Setting Up Transfer Tool” (page 33-57)

1 On the GP-Pro EX state tool bar, click the Transfer Project icon . The [Transfer Tool] dialog box appears.

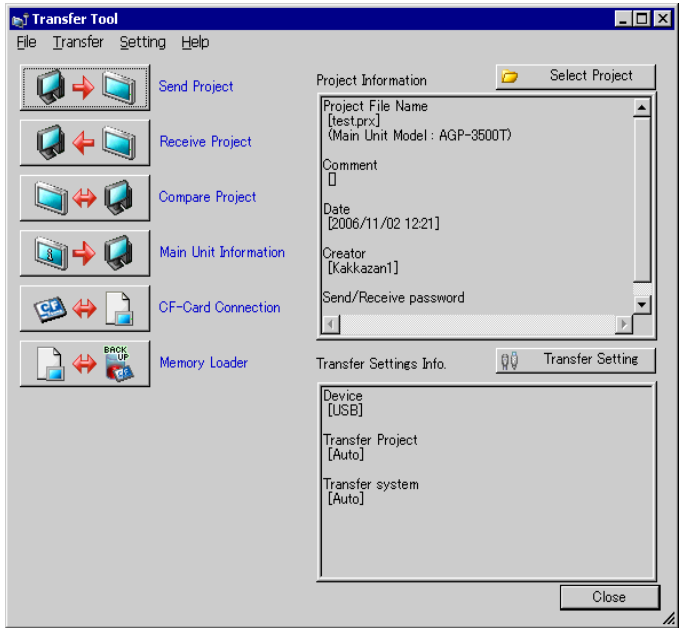

2 Click the [Transfer Setting] button. Ensure that [Communication Port Settings] is set to [LAN]. Select the [LAN Auto Setting] then click [OK].

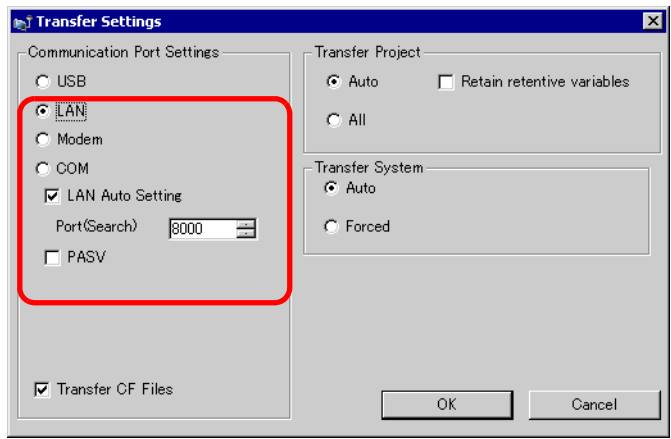

3 Select each IP address of the GP to compare project data and click [OK].

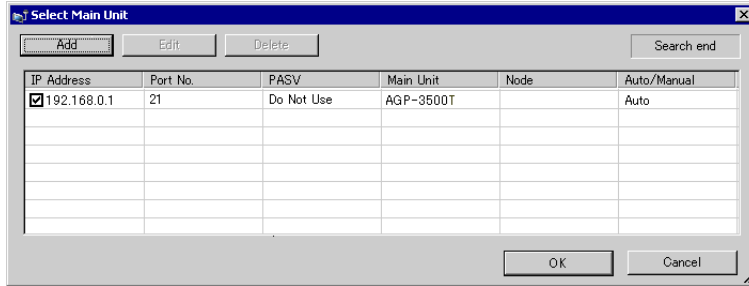

4 The following [Comparison] dialog box appears and display the results of the comparison between the PC and GP.

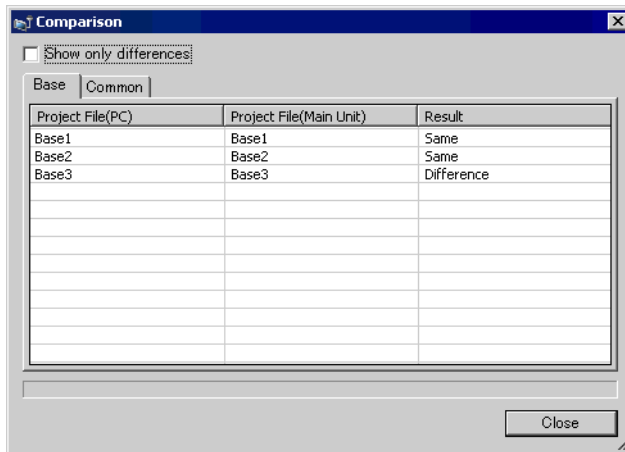

NOTE

- Select the [Show Only Differences] check box. The comparison results show screens that are different.
- The following messages appear when there are no differences in projects and when the projects are completely different.

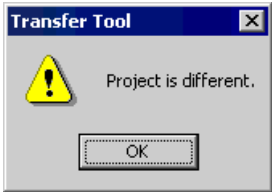

5 After confirming the results, click [Close].

33.5 Transferring Data Only to a CF Card

33.5.1 Introduction

Use the [CF Card Connection] feature on a PC to check data currently stored in the CF Card on the GP.

This feature is used to: copy data between the CF Card folder and the CF Card, to delete the data in a CF Card, or to change a file name.

- Data copy

You can copy Recipe and image data from the CF Card folder to the CF Card without transferring the project.

You can also copy alarm and sample data stored in the CF Card to the PC.

For example, Copy created Recipe data (ZR00000.csv) to the CF Card

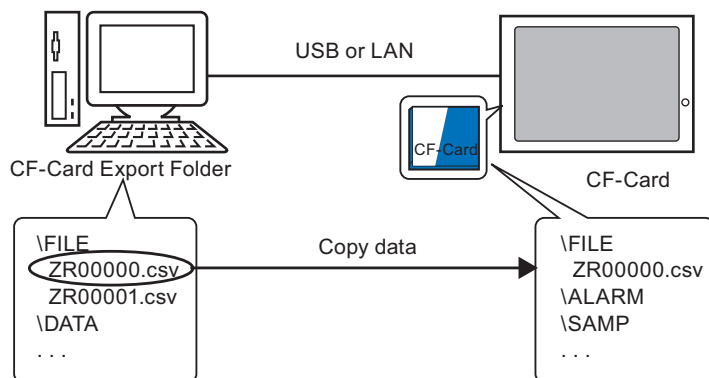

- Delete CF Card data

You can delete data in the CF Card in the GP.

For example, Delete CF Card Alarm data (Z100000.csv)

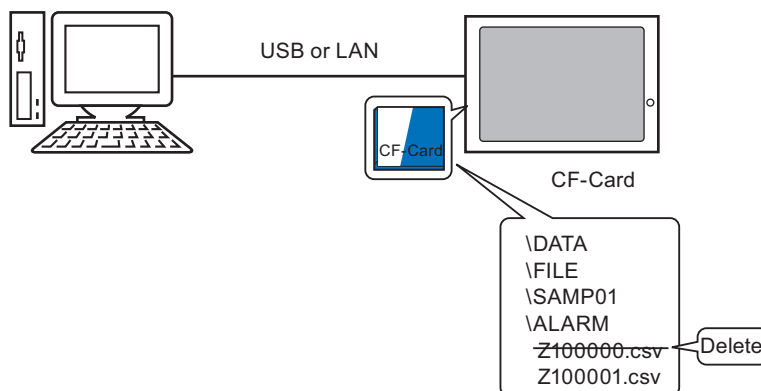

33.5.2 Transfer Process

Copy the recipe data (ZR00000.csv) in the CF Card Folder to the CF Card in GP.

- NOTE**
- Please refer to the settings guide for details.
 “33.10 Setting Up Transfer Tool” (page 33-57)

1 On the GP-Pro EX state tool bar, click the Transfer Project icon . The [Transfer Tool] dialog box appears.

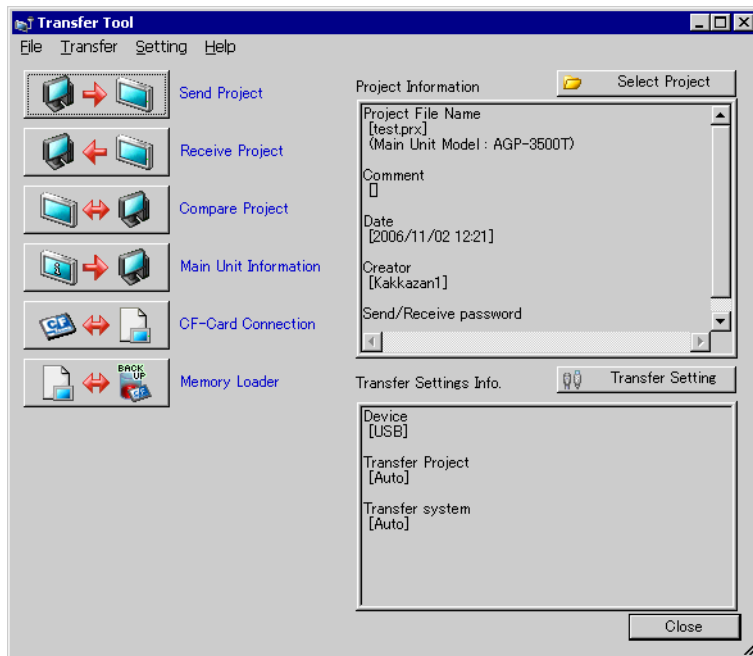

2 Click [CF Card Connection]. The following dialog box appears. Select [Connect Offline] and click [OK].

During the transfer, the GP changes to Transferring mode and communication with the device/PLC is suspended.

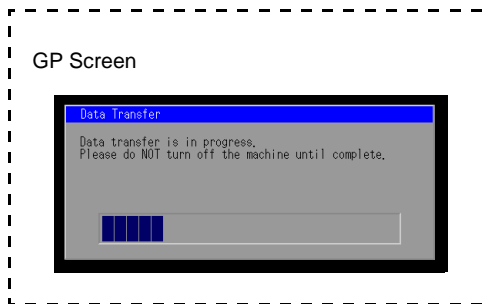
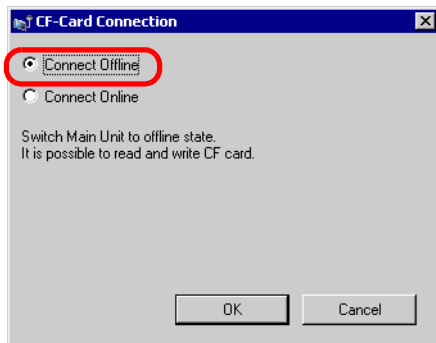

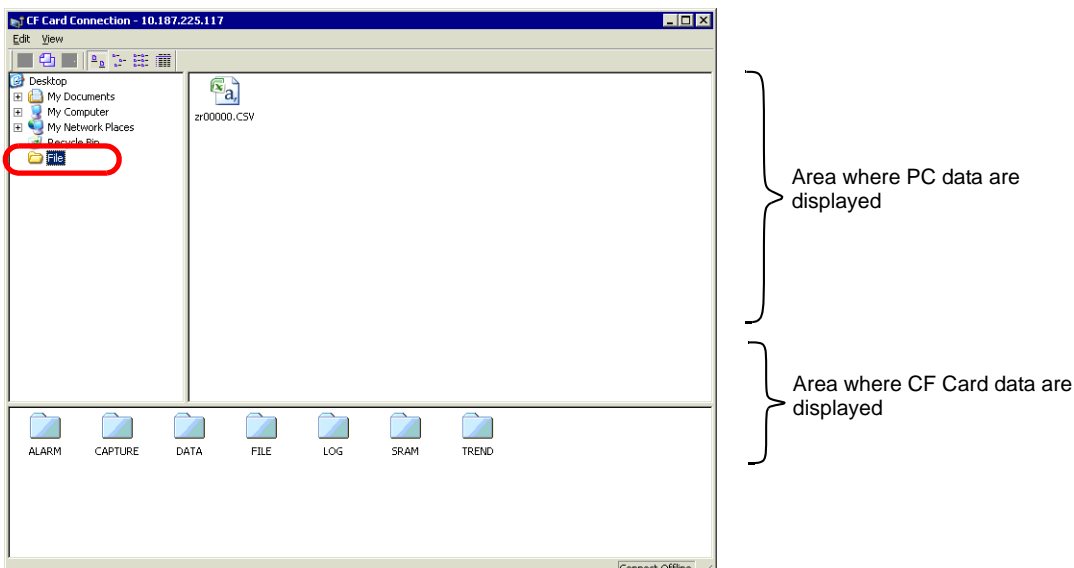

- NOTE**
- When [Online Connection] is selected, you can only check the data information. You cannot copy, delete, or move data on the CF Card.

- 3 When the CF Card connection tool starts, select the **FILE** folder from the folder list on the left. The data in the folder is displayed on the right side.



- 4 Select the Recipe data (ZR00000.csv) from the data displayed on the right-hand side, then drag it to the lower CF Card area.

NOTE

- You can also select the recipe data (ZR00000.csv), click  to copy, then click  in the CF Card area to paste.

- 5 Close the tool with .
Click [Close] to close the Transfer Tool screen.

33.6 Transferring with Passwords

33.6.1 Introduction

You can protect the sending and receiving of projects by setting a password. Requiring a password prevents the transfer if passwords do not match. This feature is a security measure to allow only specific persons to transfer data.

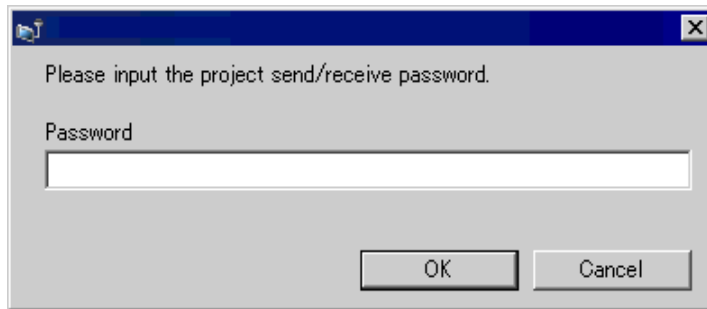

IMPORTANT

- Do not forget the password as you will not be able to transfer data without the password.
- If a wrong password is entered three times, the transfer is canceled.

NOTE

- If a Password Input window remains on the screen for 5 minutes without any input, an alarm message appears. After another 5 minutes, a time-out occurs and the transfer is forcibly canceled.
 - Passwords also apply when comparing projects and transferring data to and from the CF card.
-

33.6.2 Setup Procedure

Set a password.

IMPORTANT

- Do not forget the password as you will not be able to transfer data without the password.

- 1 On the [Project(F)] menu of GP-Pro EX, select [Information(I)]-[Project Information(I)]. The [Project Information] dialog box appears.

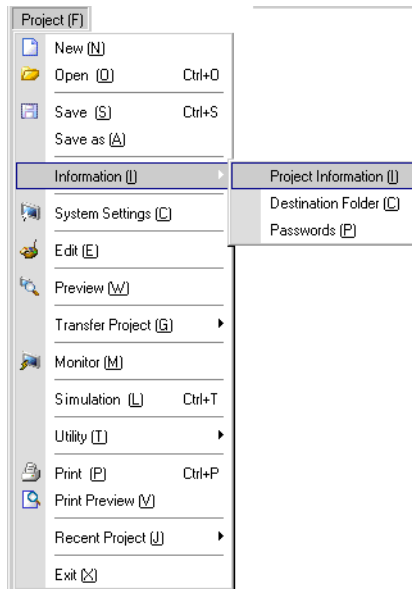

- 2 Select [Passwords] from the item list on the left-hand side.

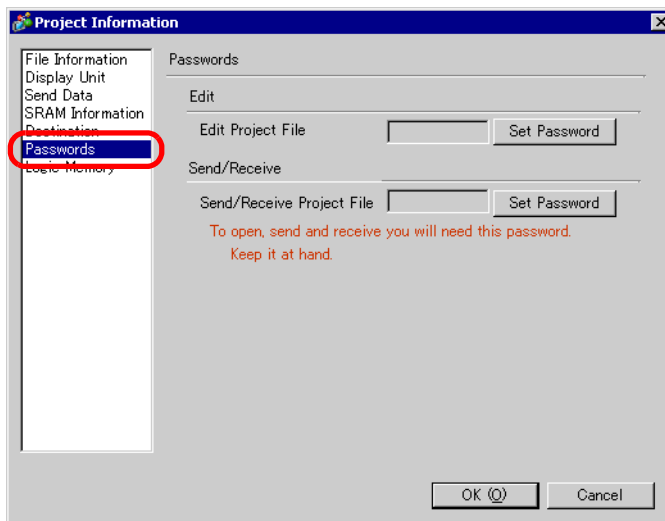

3 Under [Send/Receive], click [Set Password]. The following dialog box appears.

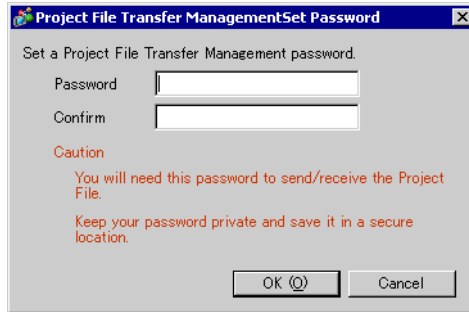

4 Enter a password of up to 24 single-byte characters.
Confirm the password.



5 Click [OK].

33.6.3 Remove/Change Transfer Password

Releases a previously set password.

- 1 From the GP-Pro EX [Project (F)] menu, point to [Information (I)] and then click [Project Information (I)].

The [Project Information] dialog box appears.

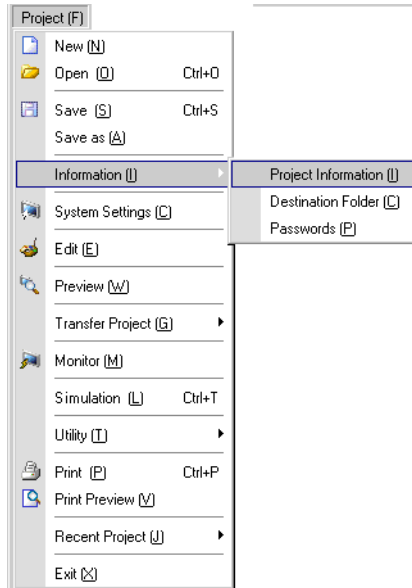

- 2 Select [Passwords] from the item list on the left-hand side.

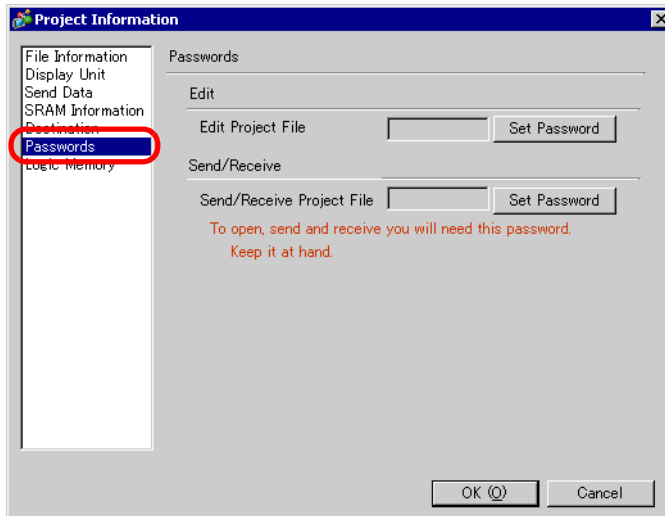

3 Under [Send/Receive], click [Set Password]. The following dialog box appears.



4 Enter the current password.



5 Leave [Password] and [Confirm] blank and click [OK].



NOTE

- To change the password, enter the new password in [Password], enter the same input in [Confirm], and click [OK].
-

33.7 Transferring project files using a CF Card or USB storage

33.7.1 Introduction

Without connecting USB or LAN cables, you can transfer project files between the GP and your PC using an external memory such as a CF Card or USB storage device. You can also use the external memory to copy project files from one GP to another.

- Transfer from PC to GP

On the GP, downloads and displays the project backup data stored on a CF Card or USB storage device.

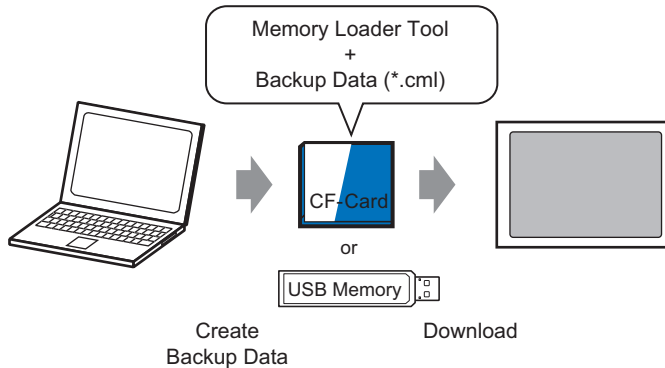

- Transfer from GP to PC

Uploads the backup data from the GP to a CF Card or USB storage device and loads the data to the PC as a project file. You can also download and display the backup data on a different GP.

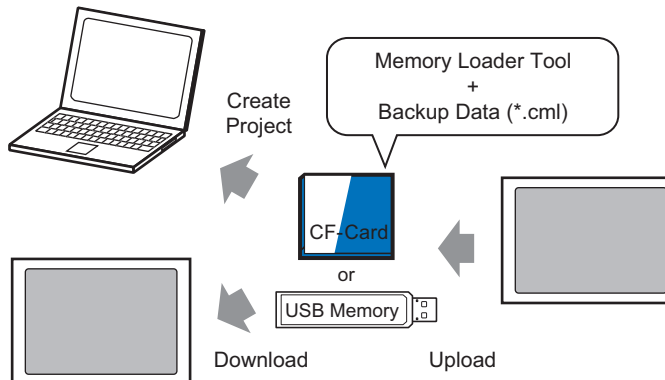

IMPORTANT

- To backup (upload) the project on the GP or start (download) the project from the backup data on a CF Card, the special Memory Loader Tool must also be copied to the CF Card. To backup the project on a USB storage device, a different Memory Loader Tool specific for USB storage devices must be copied to the USB storage device.
- Once the data is saved in the CF Card folder, you cannot use the data in USB storage. Similarly, once the data is saved in the USB destination folder, you cannot use the data on a CF Card.

33.7.2 Transfer Process

NOTE

- Please refer to the settings guide for details.
 ☞ “ ■ [Memory Loader] Settings Guide” (page 33-63)

■ Transferring Project Files from PC to GP

Create project backup data on a CF Card and start the project from the CF Card (or USB memory) on the GP. (When you create backup data on your PC, the "memory loader tool" is automatically saved on the CF Card (or on the USB storage). This tool is necessary for starting up projects on the GP.)

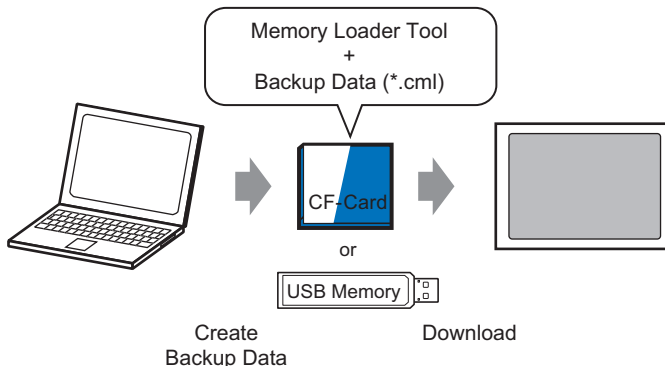

IMPORTANT

- You need to format (initialize) the CF Card and USB storage device in FAT.
- You can initialize the CF Card in GP. For initializing, see "2.7. Initialization of the memory/CF Card" in "Maintenance/Troubleshooting."

The following shows the process for using a CF Card. To use USB Storage, replace "CF Card" with "USB storage" in the process.

- 1 On the GP-Pro EX state tool bar, click the Transfer Project icon  to launch [Transfer Tool].

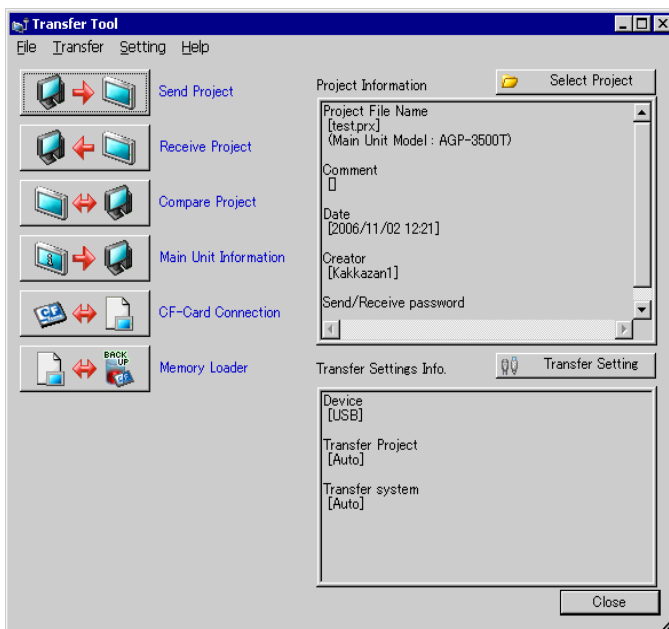

- 2 In [Select project], select the project you wish to transfer.
- 3 Click [Memory loader] to open the next dialog box.
Click [Create backup data].

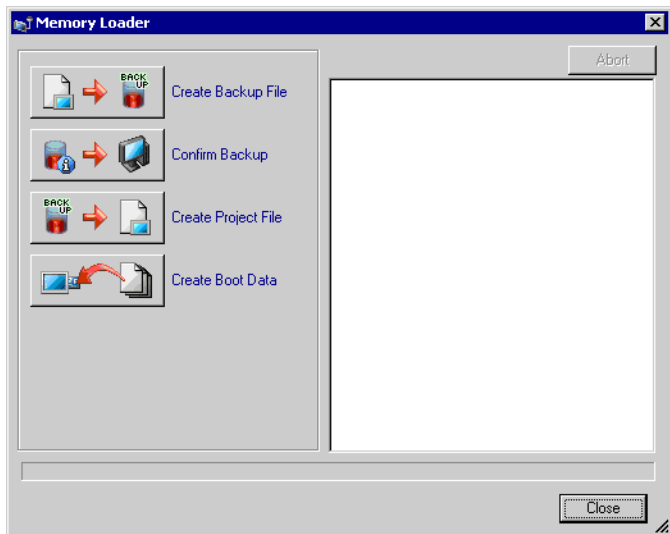

- 4 Select [CF Card] and click [Browse].

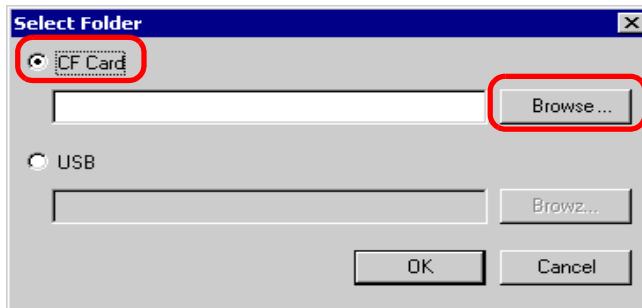
**NOTE**

- When you have selected [CF card], the folder selected in the [Select Folder] dialog box appears.
☞ "5.7.2 Setup Procedure ■ Setting the Destination folder" (page 5-43)

- 5 In the [Browse folder] dialog box, specify the CF card folder for the destination and click [OK].

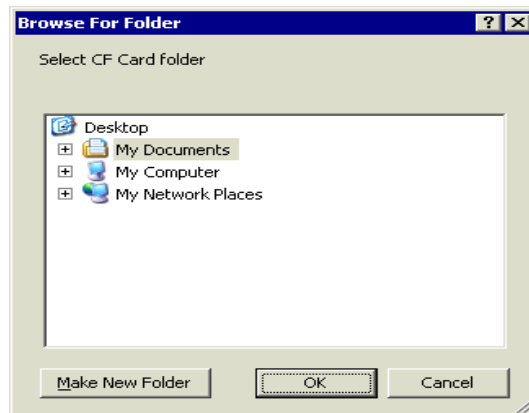

- 6 In the [Select Folder] dialog box, click [OK] to start creating data.
While creating data, the following dialog box appears to show the creation status.

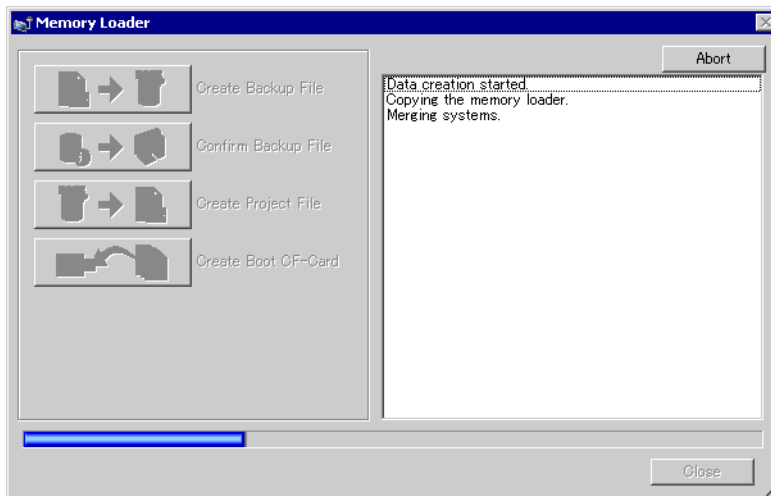

7 When the message "Data Creation Completed" appears, click [Close].

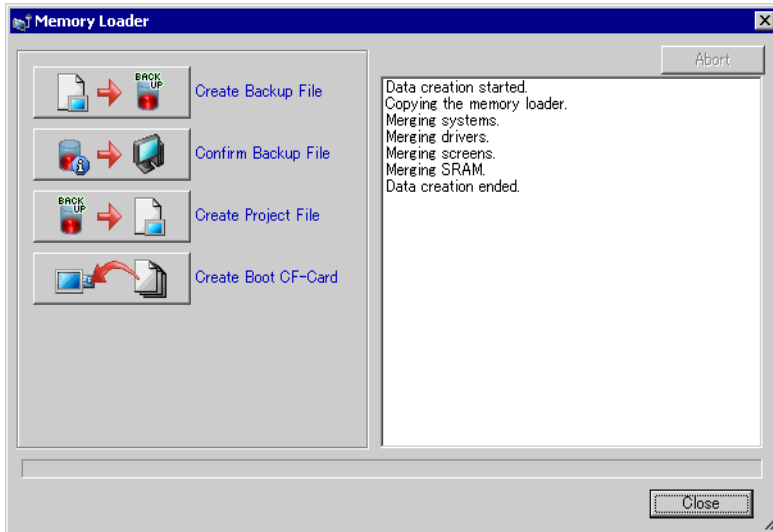

8 Copy or move all data created in the CF Card folder to the CF Card. The project backup data and the memory loader tool for CF Card have now been saved on the CF Card.

9 Insert the created CF Card in the GP.

Touch the top right corner → bottom left corner (or top left corner → bottom right) on the GP screen in this order within 0.5 seconds and switch to offline mode.

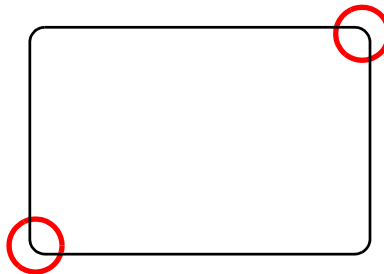

NOTE

- To start the CF Card, you can either use the system menu or the dip switches on the back of the GP. Turn the GP power OFF, turn ON dip switch 1, and then turn the GP power back ON to launch the Memory Loader tool. You cannot use the dip switches to start the CF Card when using USB Storage.
- To transfer project data to the GP for the first time (for a newly purchased GP), the [Initial Transfer Mode] screen appears when you turn the power ON. Touch [Select Startup Device] on the screen to use the memory loader feature.

10 Touch [CF/USB]. Touch [CF startup] to reset GP automatically.

Touch [CF/USB].



11 The Memory Loader Tool launches. The following screen appears. Touch [Download].

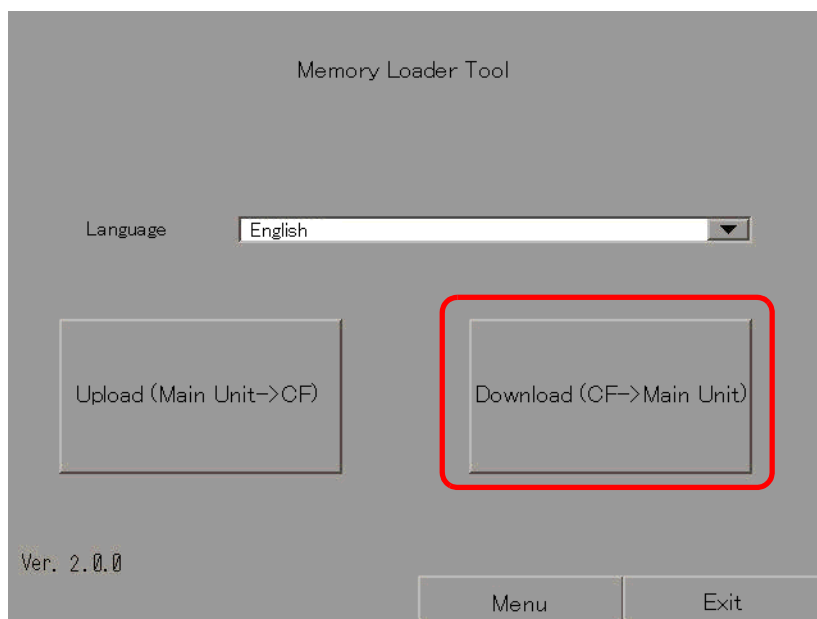

- 12 In [Select File], select a file you want to transfer and touch [Start]. If the transfer password is set, enter the password before touching [Start]).

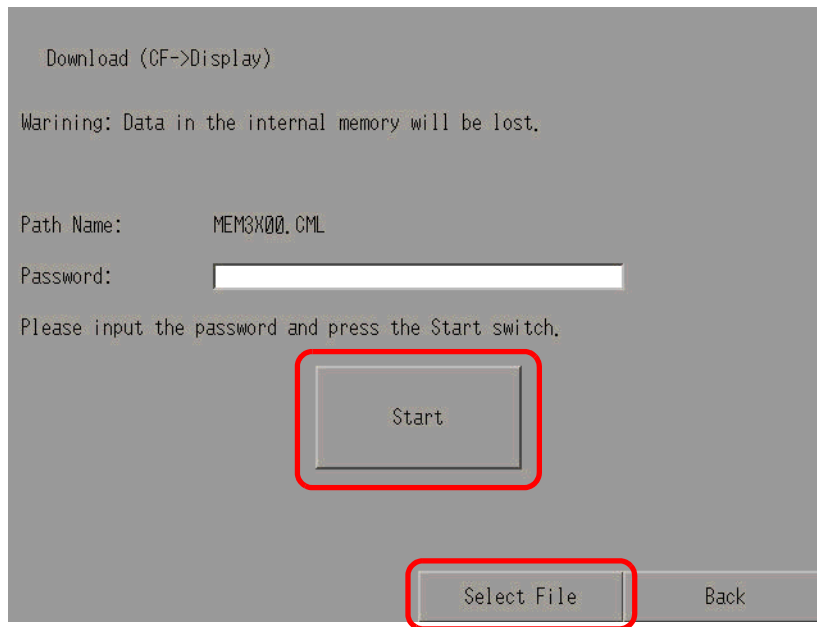

IMPORTANT

- Once you start downloading, all project data on the GP is deleted, including the data in the backup SRAM.
- If you performed CF Start with the dip switch, turn the Number 1 dip switch back OFF.

- 13 Once download is complete, touch [Back]–[Finish] to exit the Memory Loader Tool.

■ Transferring Project Files from GP to PC (or to Another GP)

Backup (upload) the project on the GP to a CF card or USB storage. The backup data (*.cml) can be converted into a project file (*.prx) and edited on a PC, or downloaded for use on another GP.

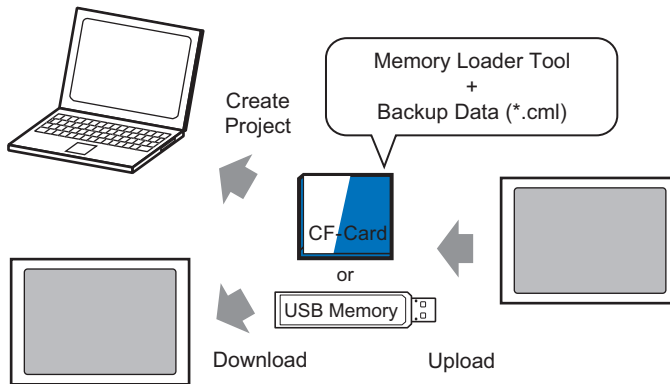

IMPORTANT

- You need to format (initialize) the CF Card and USB storage device in FAT.
- You can initialize the CF Card in GP. For initializing, see "2.7. Initialization of the memory/CF Card" in "Maintenance/Troubleshooting."

◆ Create a startup CF Card/USB

Before you transfer any file, create the memory loader tool on/in the CF Card/USB storage you will be using. To backup (upload) the project on the GP to the CF Card/USB storage device or to start the project (download) from the backup data in the CF Card/USB storage, you need the "memory loader tool."

- 1 On the GP-Pro EX state tool bar, click the Transfer Project icon  to launch [Transfer tool].
- 2 Click [Memory Loader], the following dialog box appears.
- 3 Click [Create Boot Data]. The memory loader tool will be created in the CF Card/USB destination folder you specified.

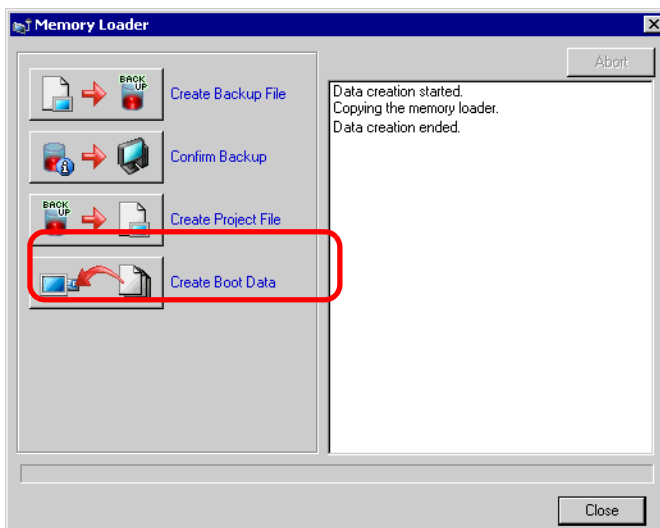

4 Move or copy all the created data to the CF Card/USB storage. The CF Card/USB storage device is now ready.

◆ Transfer (GP → CF Card → PC)

The following shows the process for using a CF Card. To use USB Storage, replace "CF Card" with "USB storage" in the process.

1 To change to offline mode, within 0.5 seconds of each touch, touch the top-right then the bottom-left corner, or touch the top-left then bottom-right corner.

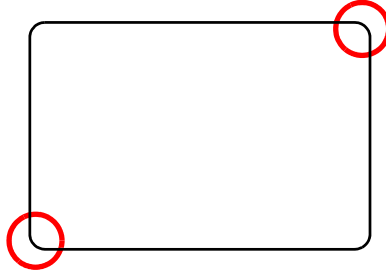

2 Touch [CF/USB]. Touch [CF startup] to reset GP automatically.

Touch [CF/USB].



3 The Memory Loader Tool launches. The following screen opens. Touch [Upload].

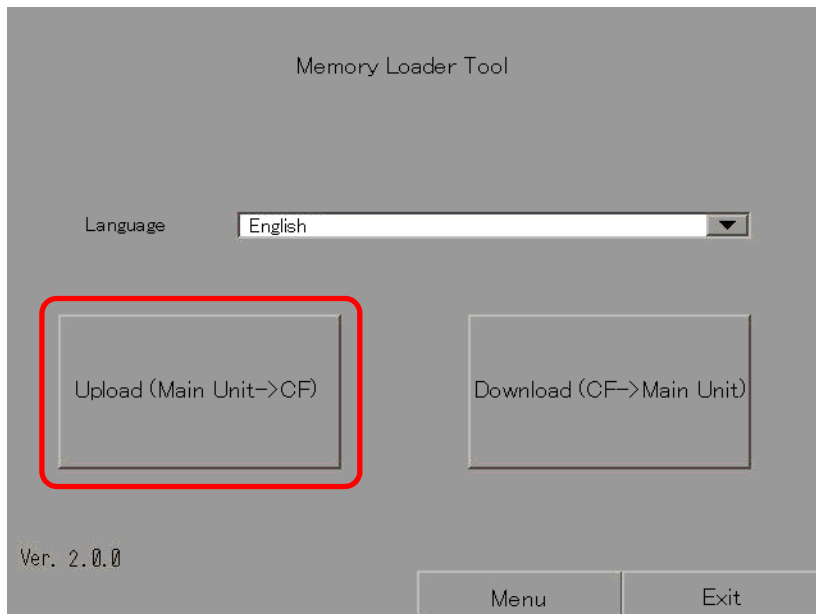

- 4 Touch [Start]. If there is a password for transferring, input the password first, then touch [Start].

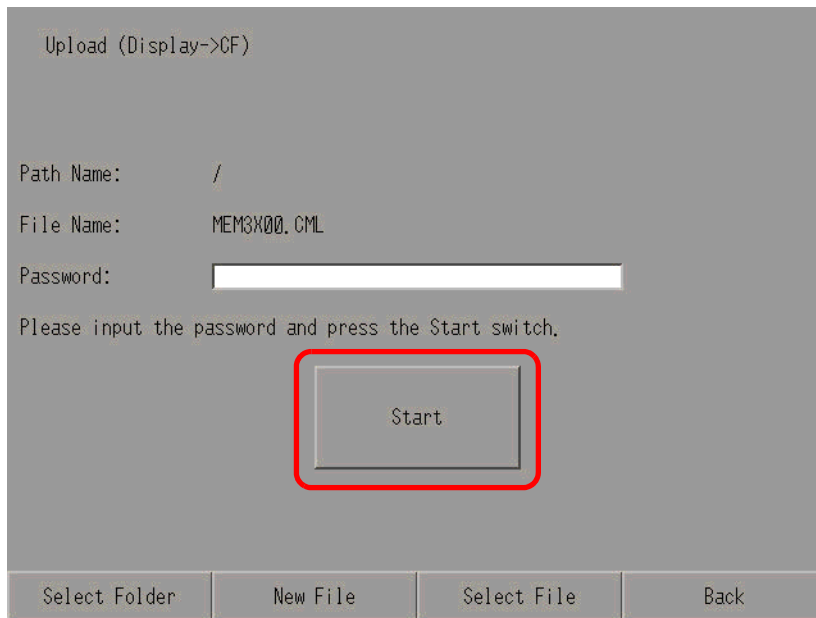

NOTE

- Backup data is saved as displayed [File Name]. If you are using AGP-3500T, by default this is "MEM3X00.CML." If you want to use another file name, touch [New File]. To overwrite an existing file name in the CF Card, touch [Select File].
-

- 5 Once upload is complete, touch [Back] then [Exit] to exist the Memory Loader Tool
- 6 Remove the CF Card from the GP and insert it into the PC.

7 On the GP-Pro EX state tool bar, click the Transfer Project icon  to launch [Transfer Tool].

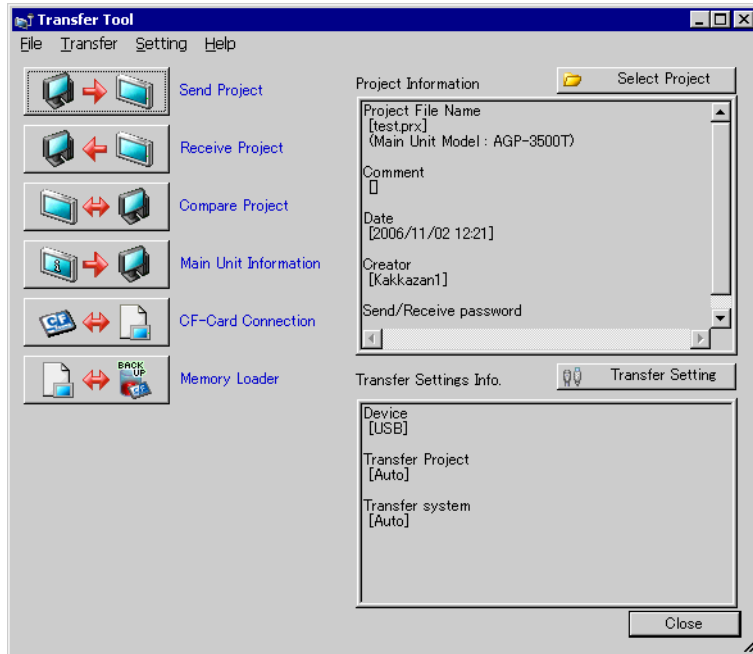

8 Click [Memory Loader]. The following dialog box appears. Click [Create Project].

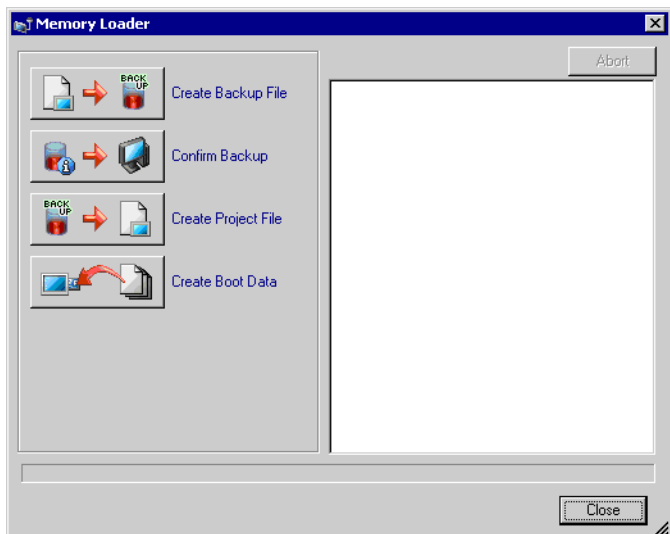

9 In the following dialog box, select a CF Card for the [Look In] location. Select the backup file (*.cml) to convert to a project file (*.prx) and click [Open].

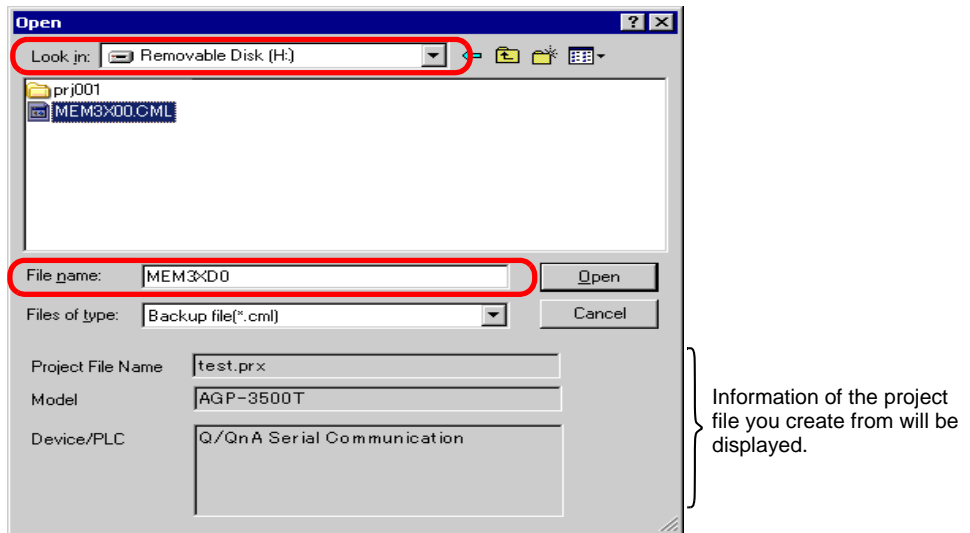

10 Enter the name and the location of the project file going to create and click [Save].

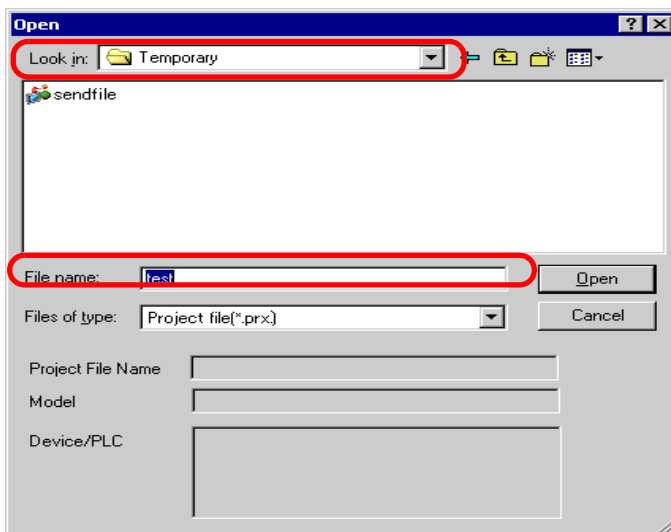

11 Confirm the information in the [Project Create] dialog box then click [Create].

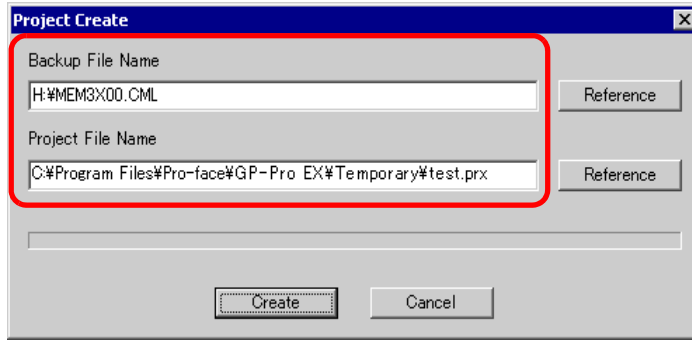

NOTE

- Click [Browse] to edit the settings of the backup file or the project file.

12 The following dialog box appears. When the message "Data Creation Completed" appears, click [Close].

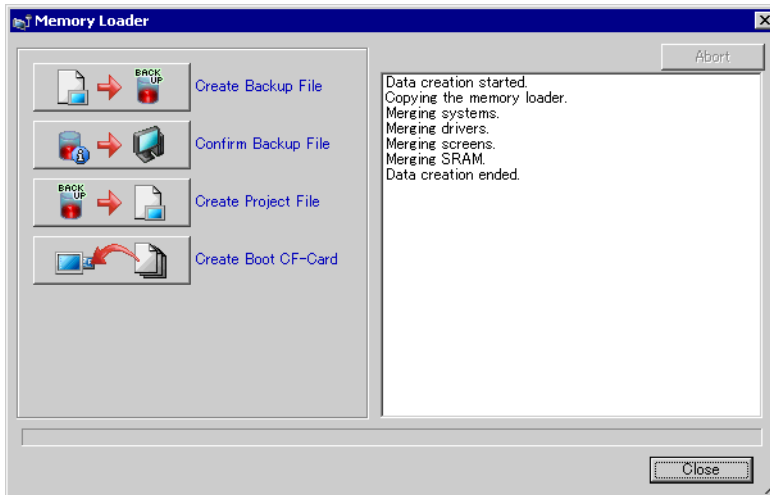

33.8 Updating Remote Screen Data via Modem

33.8.1 Introduction

Using a modem to transfer screen data from the PC to a remote GP. You can also use a modem to transfer from the GP to a PC.

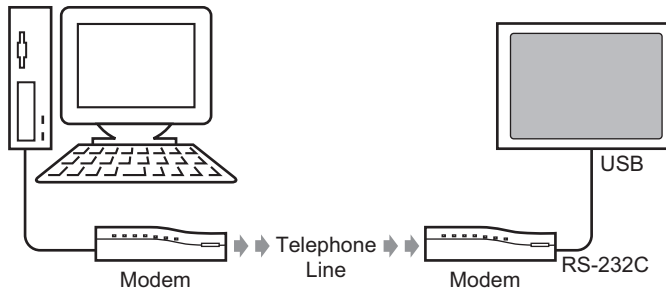

NOTE

- In this transfer, you can only transfer screen information of the project file. You cannot transfer all projects or the system.
 - To connect the GP to a modem, use "CA6-USB232-01", a USB-Serial (RS-232C) conversion cable manufactured by Pro-face (sold separately). The following conversion cable can also be used:
Manufacturer: IO Data Device, Inc. Model: USB-RSAQ3
-

33.8.2 Transfer Process

Connect a modem to your PC and GP to transfer the screen data from your PC to GP.

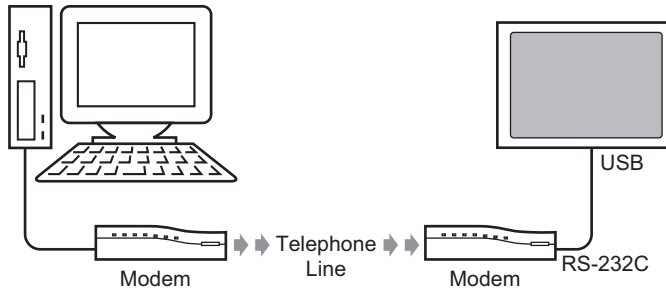

NOTE

- Ensure the PC has the proper communication settings for the modem. In the Windows® [Control Panel], set up the [Phone and Modem Options].
- To connect the GP to a modem, use "CA6-USB232-01", a USB-Serial (RS-232C) conversion cable manufactured by Pro-face (sold separately). The following conversion cable can also be used:
Manufacturer: IO Data Device, Inc. Model: USB-RSAQ3

1 On the GP-Pro EX state tool bar, click the System Settings icon . When the [System Settings] window appears, click [Modem].

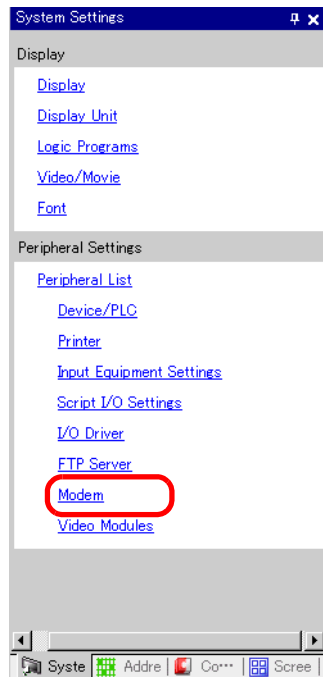

NOTE

- If the [System Settings] tab is not displayed in the workspace, from the [View (V)] menu, point to [Work Space (W)] and select [System Settings (S)].

- 2 Select the modem communication speed. The modem settings for GP-Pro EX are now complete.

**NOTE**

- For the proper modem settings, please read the manual of the modem.

- 3 From the [Project (F)] menu, select [Transfer Project (G)] or click <ICON> from the toolbar. 
- 4 Click [Transfer Settings] and the following dialog box will appear. Select [Modem] in the [Communication Port Settings].

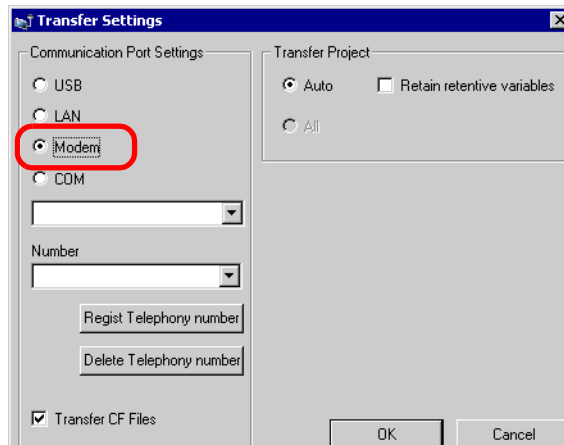

- 5 Select the modem. You can confirm which modems are set up on the PC from the Device Manager dialog box in the Windows Control Panel. Enter the telephonenumber of the modem connected with the GP in the [Number] field.
- 6 If you don't need to transfer data in the CF Card Folder to the CF Card in GP, clear the [Transfer CF Files] check box and click [OK].

Transfer CF Files

7 Click [Send Project].

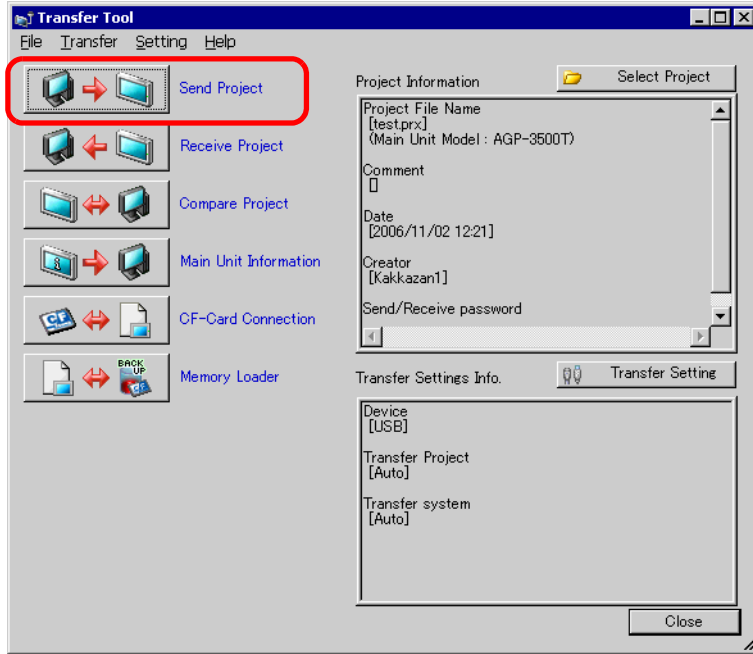

The following dialog box appears during transfer to check the communication status. During the transfer, the GP changes to Transferring mode and communication with the device/PLC is suspended.

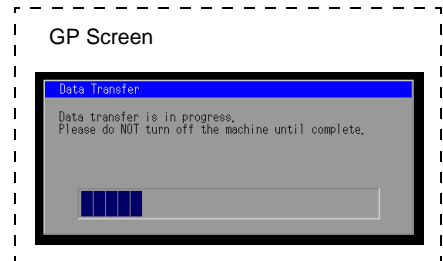
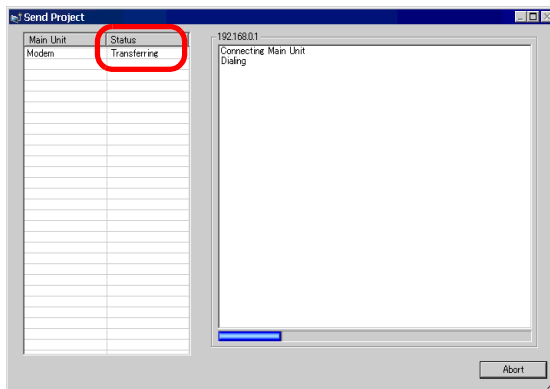

- 8 When the transfer finishes, the status changes from [Transferring] to [Complete Transfer]. Click [Close]. The GP is reset and the transferred screens are displayed.

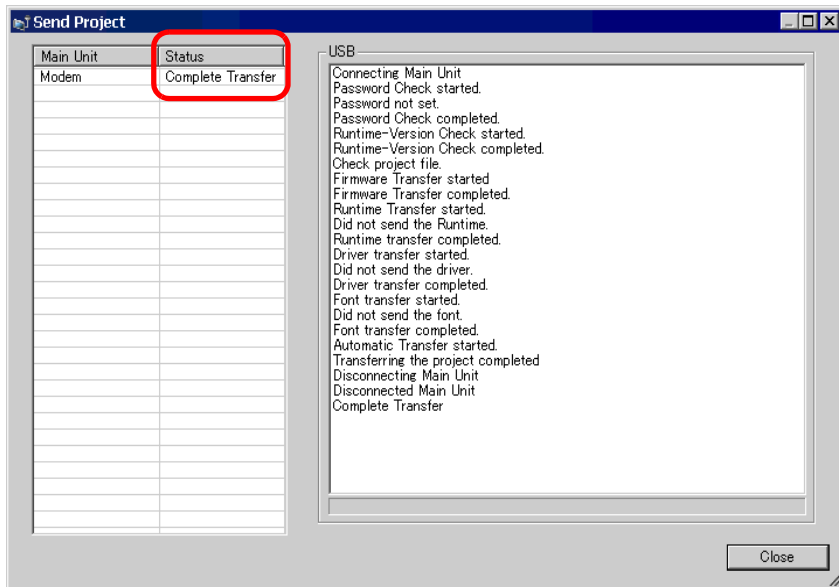

- 9 Click [Close] to return to the Transfer Tool. Click [Close] again to close the Transfer Tool.

33.9.2 Setup Procedure

NOTE

- Please refer to the settings guide for details.
 - ☞ “5.14.7 [Preferences] Settings Guide” (page 5-147)
 - ☞ “5.14.4 [Utility] Settings Guide” (page 5-90)

1 From the [View (V)] menu, select [Preferences (O)]. The following dialog box appears. On the left, select [Error Check] then select the [Display Warnings] check box. Click [OK].

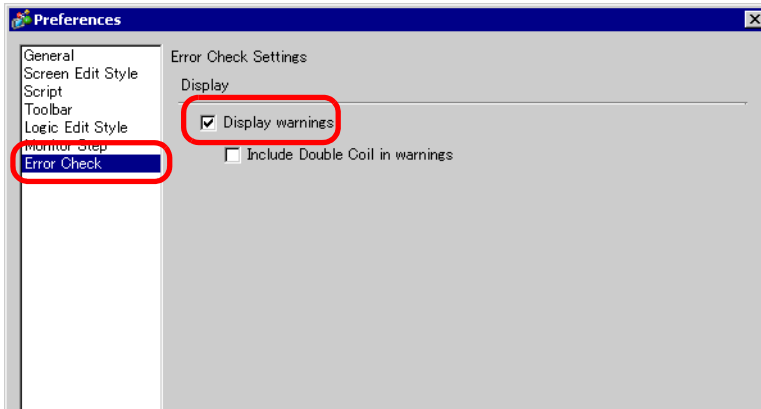

2 To start the error check, from the [Project (F)] menu, point to [Utility (T)] and select [Error Check (E)].

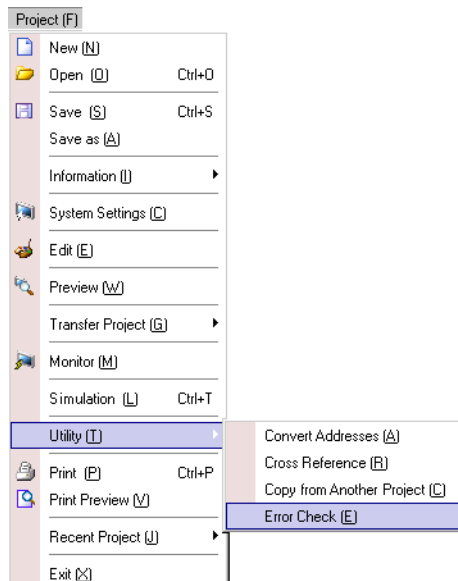

During the Error Check, the following dialog box appears. This dialog box closes when the Error Check is finished.

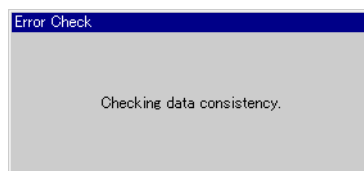

3 If there is an error or a warning, the following screen appears. Check details in the [Summary] column.

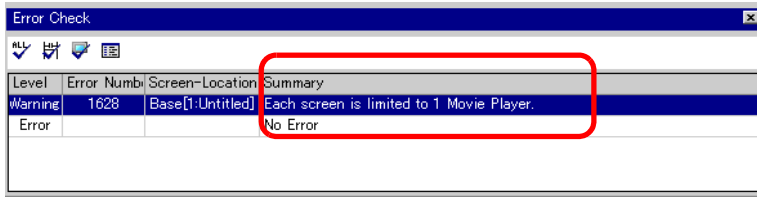

4 Double-click on the selected line in the list to view the screen with the error.

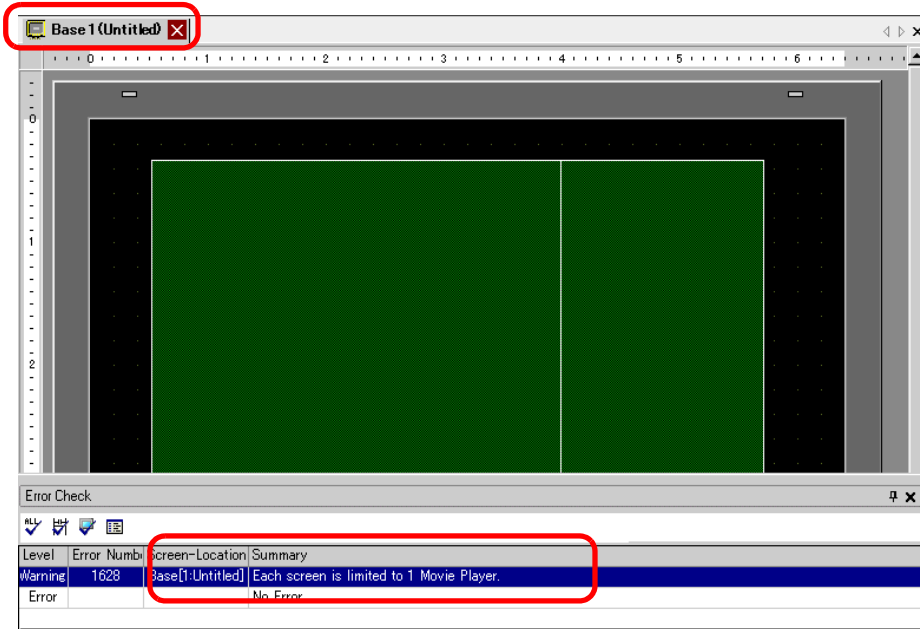

NOTE

- For errors in the logic program, see the following section.
 ➔ "29.11 Correcting Logic Program Errors" (page 29-89)

5 Make corrections in the relevant areas and click  to recheck errors. Once all the errors are fixed, the window appears as:

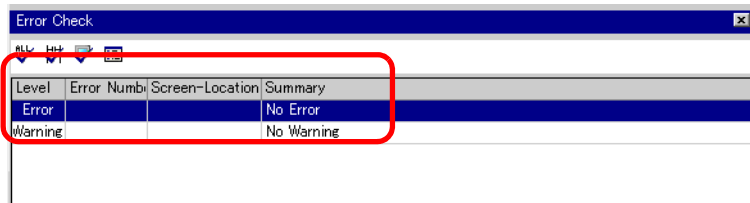

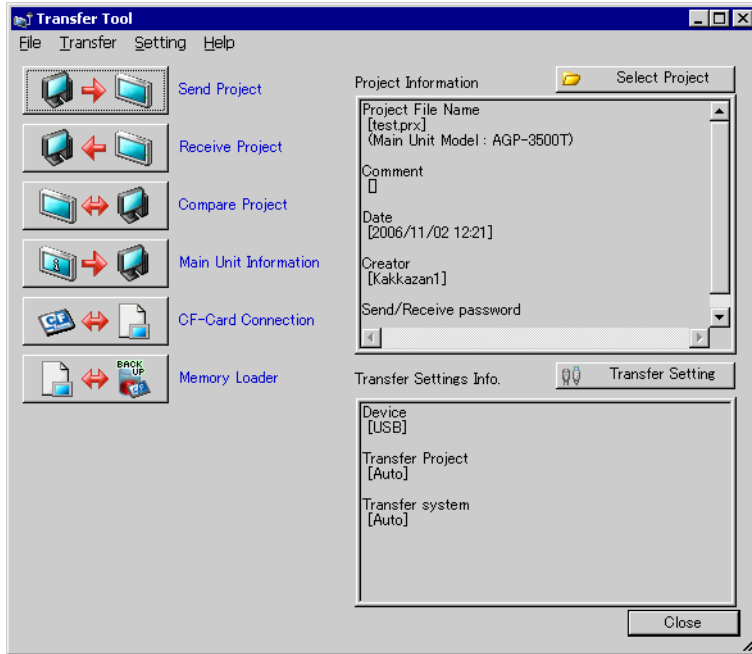

33.10 Setting Up Transfer Tool

The "Transfer Tool" transfers project data between a PC and the GP. On the GP-Pro EX state tool bar, click the [Transfer Project] icon  (or on [Project (F)] menu, select [Transfer Project (G)]-[Other Transfer]) to launch the transfer tool.



- NOTE**
- You can install the transfer tool without installing GP-Pro EX on your PC. This is useful when only transferring files on a PC other than the development PC (the PC used for screen creation).
 "33.10.5 Installing the Transfer Tool" (page 33-68)

Setting	Description
Send Project	<p>Sends the project currently open in GP-Pro (or the project selected in [Select project]) to the GP.</p> <p>If you have selected the CF Card folder for the project, the data in the CF Card folder is sent to the CF Card inserted in the GP. If you do not wish to send the data to the CF Card, clear the [Transfer data to CF Card] checkbox in [Transfer Settings].</p> <p> "33.10.3 How Sending Data Works" (page 33-66)</p> <p>IMPORTANT</p> <ul style="list-style-type: none"> When a send occurs, data stored in GP's backup SRAM is deleted.
Receive Project	<p>Project data stored in a connected GP is received and saved to the PC in the designated location as a new project file (*.prx).</p> <p>For projects using the CF Card, all data on the CF Card in the GP are received and saved in the destination location.</p> <p> "33.10.4 How Receive Works" (page 33-67)</p>

Continued

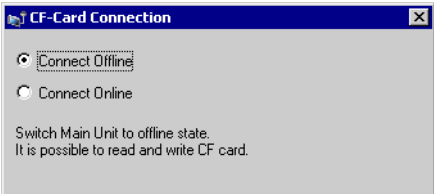
Setting	Description
Compare Project	<p>Compares the project currently open in GP-Pro EX (or the project selected in [Select project]) to the project stored on the connected GP and displays the results.</p> <p>For project set with the CF Card folder, the CF Card folder data and the data on the CF Card inserted in the GP are compared.</p>
Main Unit Information	<p>Reads and displays the system version, stored project information and screen information for the connected GP.</p> <p>System Version : Type and version of the main unit and version of the driver</p> <p>Project Information: Project file name, comment, date, creator</p> <p>Screen List : Screen number and type, comment, size, date</p>
CF Card Connection	<p>Tasks you can perform are different depending on the connection.</p> <div data-bbox="642 625 1074 817" style="border: 1px solid black; padding: 5px; margin: 10px 0;">  </div> <ul style="list-style-type: none"> • Connect Offline While the CF Card is connected, the GP changes to Transferring mode and communication with the device/PLC is suspended. You can copy files between the CF Card Folder and the CF Card, delete and change names of the files. • Connect Online While the CF Card is connected, the GP continues to communicate with other devices/PLCs. You can check the CF Card information such as the file name, file size, and date. <p>NOTE</p> <ul style="list-style-type: none"> • GP is automatically disconnected from the CF Card 10 minutes after the last action.
Memory Loader	<p>Open the [Memory loader] dialog box. This allows you to create and acknowledge the backup data and create project files from backup data.</p> <p>☞ “ ■ [Memory Loader] Settings Guide” (page 33-63)</p>
Select Project	<p>Select the project file (*.prx) you want to transfer to the GP.</p>
Project Information	<p>Information on the project currently open in GP-Pro EX (or the project selected in [Select project]) is displayed.</p> <p>Use [Select Project] to view project information of other projects.</p>
Transfer Setting	<p>Open the [Transfer Settings] dialog box. This allows you to modify the ports or transfer method.</p> <p>☞ “33.10.1 [Transfer Settings] Settings Guide” (page 33-59)</p>
Transfer Settings Info.	<p>Displays setting information about the GP's currently selected communication port and transfer method.</p> <p>Change the [Transfer Settings] to update this information.</p>

33.10.1 [Transfer Settings] Settings Guide

On the [Project (F)] menu in GP-Pro EX, select [Transfer Project(G)]-[Transfer Settings(C)] or click [Transfer Settings] with the transfer tool to display the following dialog box.

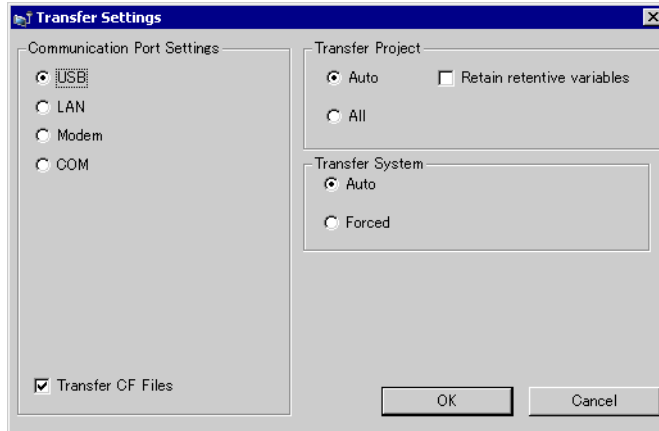

Setting		Description
Communication Port Settings	USB	Select when using a USB transfer cable to transfer screens.
	LAN	Select when using Ethernet (LAN) to transfer screens. <div style="text-align: center;"> </div>
	LAN Auto	Select to automatically search all GPs on the network.
	Port (Search)	When [LAN Auto Setting] is designated, set the port number used during search.
	PASV	Select if [LAN] is selected but data cannot be transferred due to network security.

Continued

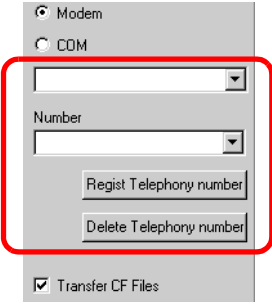
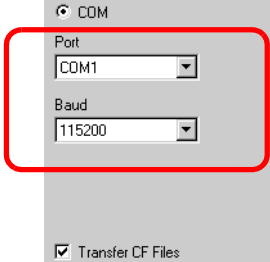
Setting		Description
Communication Port Settings	Modem	Select this option to use a modem to transfer projects. 
	Phone Number	Enter the phone number for the modem.
	Register Phone Number	Register up to 100 phone numbers.
	Delete Phone Number	Delete registered phone numbers.
COM	COM	Specify when transferring projects using a COM port. 
	Port	Select the COM port to use from COM1 to COM9.
	Baud rate	Select the communication speed from 9600/19200/38400/57600/115200. Select the same speed as you selected in [Modem] in the system settings.
	Transferring CF card data	Specify whether to send the data in the CF Card folder to the CF Card in the GP. If you do not wish to replace the data on the CF Card, clear the checkbox.
Transfer Project	Auto	The project to be transferred is compared with the project on the GP. If they are the same project, only updated or added screen data are sent. When sending a new or different project, the whole project is sent after you click [OK] in the confirmation message.
	All	Sends the whole project to be transferred. Overwrites the existing project on the GP.
	Retentive transfer	Transfer the project and retain current variable values. IMPORTANT <ul style="list-style-type: none"> If the check box is not selected, data in the variables will be initialized.

Continued

Setting		Description
Transfer System	Auto	<p>When sending the project, automatically compares the GP-Pro EX and GP system versions and download the system program*¹, protocol program*²and the font*³ to the GP as necessary.</p> <p>These items are downloaded in the following cases:</p> <ul style="list-style-type: none"> • When you perform a transfer when GP has no data (factory default) • If the system program (Runtime) version stored on the GP is older than the GP-Pro EX version. • When old versions of protocol programs (drivers) are stored in the GP, or when project device/PLC settings have been added or changed. • When a font not in the GP was used in GP-Pro EX.
	Forced	<p>When sending a project, after formatting the GP, system programs*¹, protocol programs*², and fonts*³ are forced to download to the GP.</p> <p>These are downloaded if the GP-Pro EX system version to which you are transferring the data is older than the existing system.</p>

*1 Data used to operate the project on the GP

*2 Data needed to communicate with the device/PLC to be used.

*3 Font data used by the project.

■ **Connecting for COM transfer**

Connects the PC and GP with 2 cables.

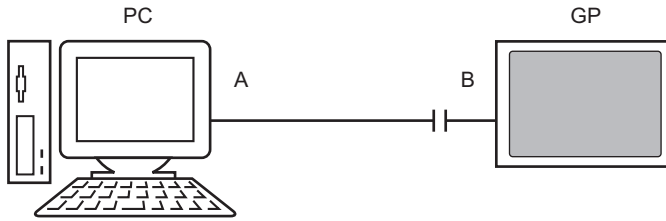

A: Originally created cable

Create the cable based on the diagram below.

DSUB9 pin (EIA-574)

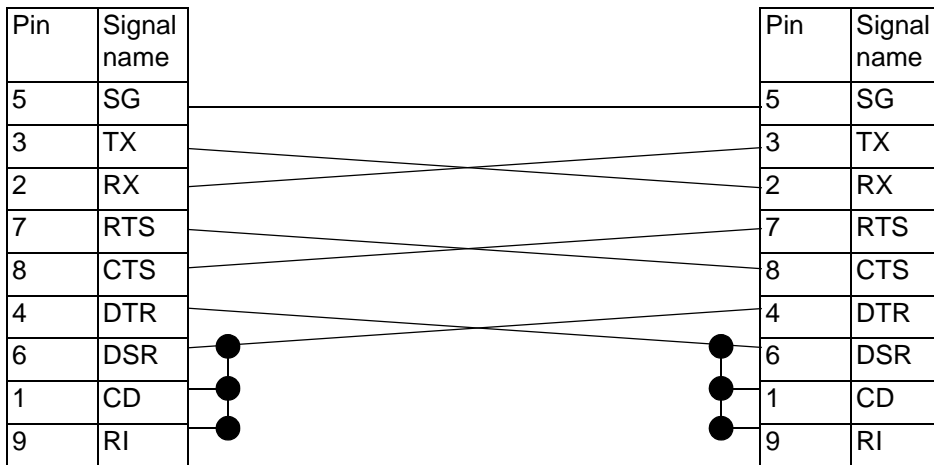

B: RS232C-USB Conversion cable

(Cable commercially available, Type: EC-USBRSAQ3)

■ [Memory Loader] Settings Guide

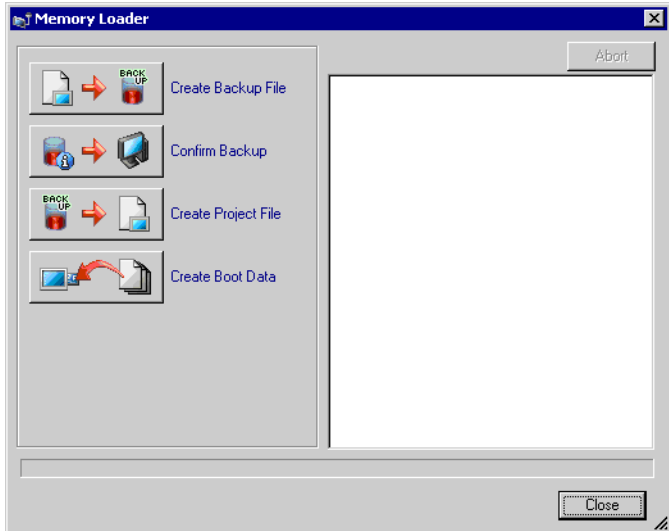

NOTE

- To use [Memory Loader], first set up [Destination Folder].
 “◆ Destination” (page 5-85)

Setting	Description
Create Backup File	<p>In the destination folder you selected in [Select Folder], create backup data (*.cml) for the project currently open in GP-Pro EX (or the project selected in [Select project]) and the memory loader to start the data on the GP. Save the data in the CF Card folder onto the CF Card and the data in the USB folder onto the USB storage device.</p> <div data-bbox="546 1141 1016 1396" style="border: 1px solid black; padding: 5px; margin: 10px auto; width: fit-content;"> </div> <p>NOTE</p> <ul style="list-style-type: none"> • This selection is not available if you selected IPC series as the unit type.

Continued

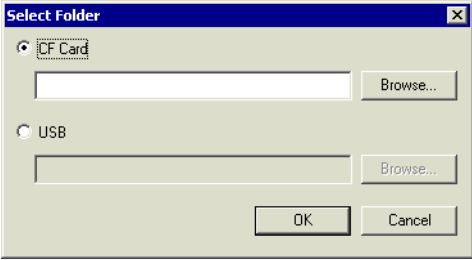
Setting	Description
<p>Confirm Backup Data</p>	<p>Lists the stored backup data: [System Information], [Project Information], [Backup Size], backup file name and date stored in the backup are listed.</p> <ul style="list-style-type: none"> • About Backup File Name The backup file default name depends on the display model. AGP-3600T, 3510T, 3500T, 3500S, 3500L, 3400T, 3400S → MEM3X00.CML AGP-3750T, 3650T, 3560T, 3550T, 3450T → MEM3X50.CML AGP-3300T, 3300S, 3300L, 3301S, 3301L: → MEM330X.CML AGP-3302B → MEM3302.CML AGP-3200T and 3200A → MEM3X0XZ.CML LT-3201A → MEM32XXL.CML
<p>Create Project File</p>	<p>You can create a project file (*.prx) from backup data (*.cml).</p>
<p>Creating startup data</p>	<p>In the destination folder you selected in [Select Folder], create the memory loader tool necessary for upload from the GP to the CF Card/USB storage device and for download from the CF Card/USB storage to the GP. Save the data in the CF Card folder onto the CF Card and the data saved in the USB folder onto the USB storage device.</p> <p>NOTE</p> <ul style="list-style-type: none"> • This selection is not available if you selected IPC series as the unit type. 

33.10.2 [Modem] Settings Guide

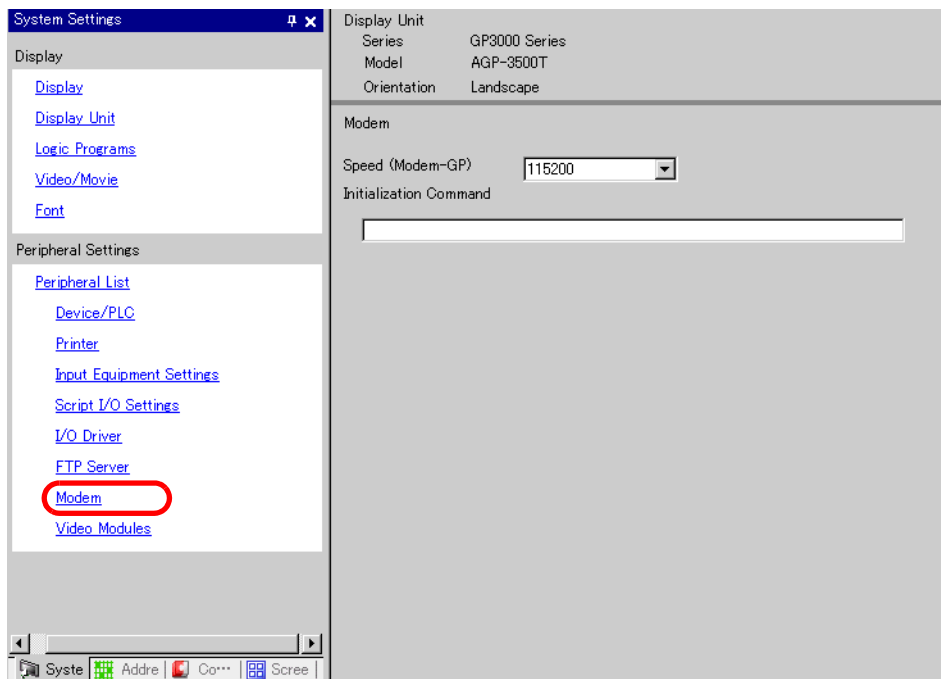

Setting	Description
Speed (Modem-GP)	Set the communication speed between modem and GP.
Initialization Command	Enter the Initialization Command of the modem.

NOTE

- For setting details, please refer to the instruction manual that come with your modem.

33.10.3 How Sending Data Works

Writes the project currently open (or the selected project) in GP-Pro EX to the GP.
 If a project is set with the CF Card folder, the data in the CF Card folder (\DATA and \FILE) are saved to the CF Card in the GP.

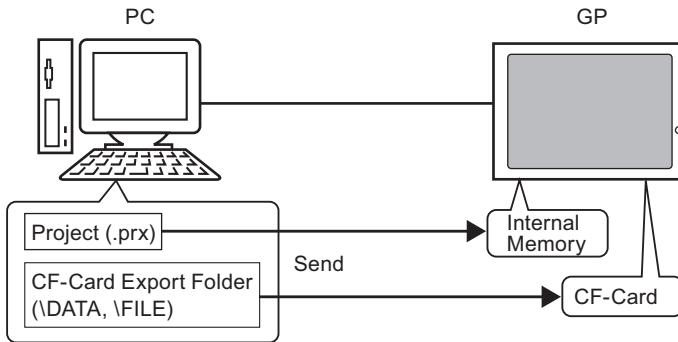

- NOTE**
- Only one project file (*.prx) can be saved on the GP.
 - When sending a project, the necessary system programs, protocol programs, and fonts are downloaded to the GP. For that reason, the transfer will take some time.
 - If the file is already in the CF Card folder, the file is overwritten when transferred. If you do not wish to overwrite the file, clear the [Transfer CF Card data] checkbox in [Transfer Settings] for the transfer tool.

If the same project exists in the GP, only modified or added screens are transferred.
 When there is no project or a different project on the GP, the whole project is transferred.

When a different project is stored in the GP

For example, Transfer "Lesson.prx" to the GP where "Test.prx" is stored.

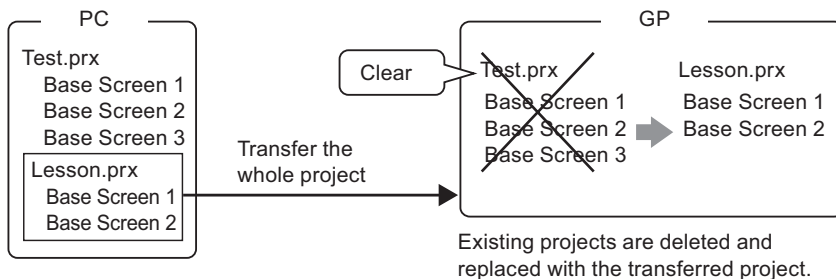

33.10.4 How Receive Works

Project data currently stored in the GP are saved to the destination location on the PC as a new project file (*.prx).

If the project uses the CF Card folder, the data contained in the CF Card (\DATA and \FILE) are saved to the designated location.

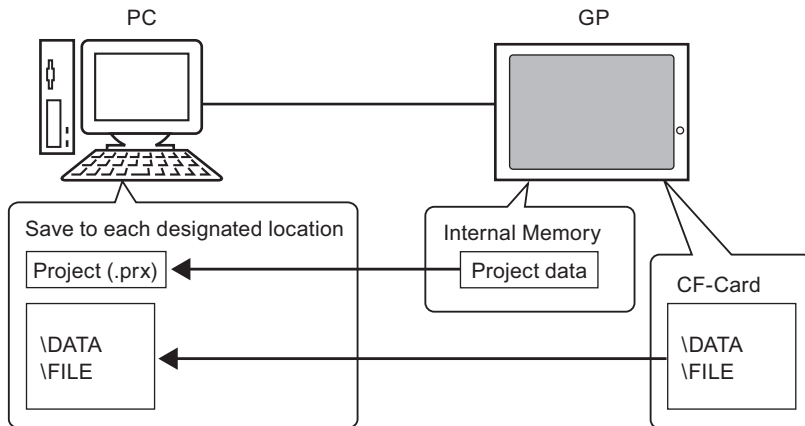

33.10.5 Installing the Transfer Tool

If you want to transfer projects from a PC that does not have GP-Pro EX installed, you can install the Transfer Tool onto this PC.

Operating Systems that support Transfer Tool

- Windows 2000 Professional (SP3 or higher)
- Windows XP
- Windows 98 (Second Edition or higher)
- Windows Me

IMPORTANT

- You cannot install GP-Pro EX onto a PC installed with the transfer tool. Uninstall the transfer tool to install GP-Pro EX.

■ Installing Transfer Tool

- 1 Insert the GP-Pro EX CD-ROM into the PC to which you wish to transfer the data. The following screen appears.



- 2 Click [Transfer Tool].

NOTE

- You cannot run the transfer tool on a computer installed with GP-Pro EX.

- 3 Set the destination folder for the installation. The default location is "Program Files\Pro-face\GP-Pro EX *.*(*.*indicates the version)" being specified.

- 4 The installation begins. When completed restart the PC.

■ Transfer Tool: From Triggering to Sending

- 1 On the PC start menu, select [Program (P)] then select [Pro-face] then [GP-Pro EX *.*] (*.** indicates the version.) then [Transfer tool].

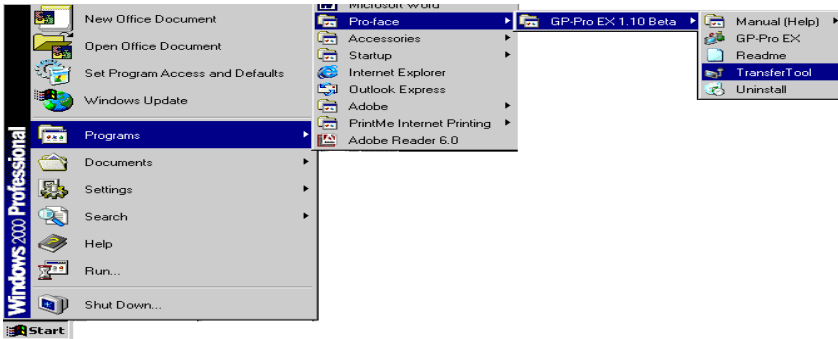

- 2 Transfer Tool launches.

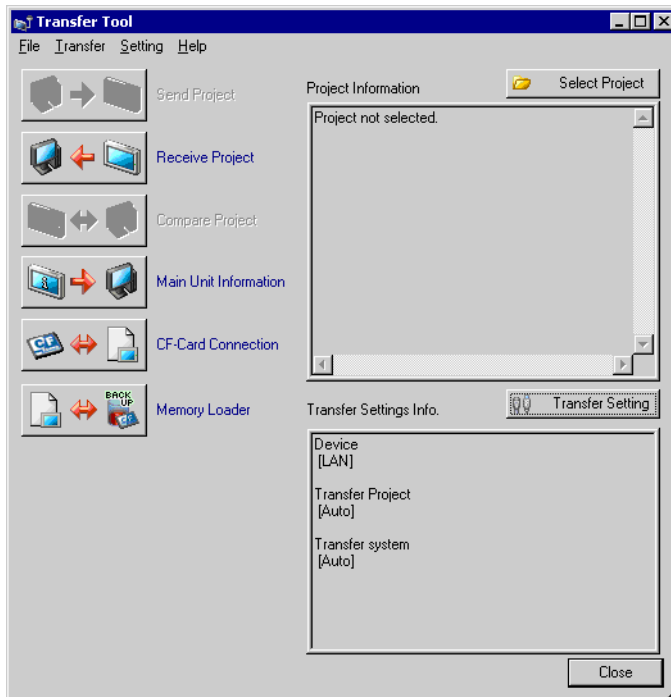

- 3 To retrieve a project from the GP, click [Receive Project].
To send a project or compare projects, select a project with [Select Project].

33.11 Restrictions

33.11.1 Restrictions for Transfer

- When sending a project, data stored in GP's backup SRAM is deleted.
- When sending a project, the necessary system programs, protocols, and fonts are downloaded to the GP as required. The transfer will take some time.

Downloads occur in the following cases:

- When you perform transfer when GP has no data (factory default)
- If the system program (Runtime) version stored on the GP is older than the GP-Pro EX version.
- When old versions of protocol programs (drivers) are stored in the GP, or when project device/PLC settings have been added or changed.
- When a font not in the GP was used in GP-Pro EX.

When a download occurs, the GP is reset. After restarting, the transferred screens appear.

- When the GP unit is offline, the project cannot be transferred.
- During the transfer, the GP changes to Transferring mode and communication with devices/PLCs is suspended.
- When a problem is found with the system program on the GP, an error message appears on the GP. Transfer the project file again.
- You cannot transfer the project file to a different model. To perform transfers even between same model GPs, except for GP3200 Series, one of the following conditions must apply.
 - Models that do not support the control feature.
 - Models equipped with DIO board
 - Models with FLEX NETWORK connections

33.11.2 Restrictions for Transfer Using Ethernet

- You can transfer data between the GP and a PC on a different network by using a router. However, there are cases where the PC cannot automatically search the GP on a different network.
- For a PC that is using two or more Ethernet cards, the desired GP may not be detected even if the PC automatically detects IP addresses. This occurs when the PC searches the GPs connected to the Ethernet card that was previously found. Click [Add] on the [Select Display Unit] dialog box and manually set the IP address of the GP.
- When using the Transfer Tool on a PC running Windows XP SP2 with Windows Firewall enabled, you are prompted to allow the transfer. If you transfer data to more than one GP at the same time, either select [PASV] in the [Transfer Settings]>[Communication Port Settings] or disable Windows Firewall.

33.11.3 Restrictions on Transfer Using a COM port

- Create the special cable before using the port.
 "33.10.1 [Transfer Settings] Settings Guide ■ Connecting for COM transfer" (page 33-62)

- You can only transfer project files to a GP on which the system program (Runtime) created in GP-Pro EX 1.10 is downloaded.
- COM port transfer is not available when using WinGP.

33.11.4 Restrictions on CF Card Connection

- When the GP is offline, the CF Card connection feature cannot be used.
- There is a limit to the frequency that data can be rewritten to the CF Card. 500 KB of data can be rewritten around 100,000 times. Backup to another media.
 - ☞ “A.5 Transferring Data Between a CF Card and a USB Memory Device” (page A-77)
- If there is no action taken for five minutes after you start [CF Card connection], a warning message appears. If you do not take any action for another five minutes, the GP is disconnected.

33.11.5 Restrictions on Modem Transfer

- If GP does not already have a project in it, you cannot transfer via a modem.
- You cannot transfer a new project via a modem. You can only use a modem to update the screen data of the project already on the GP.
- You cannot transfer the project file under the following conditions:
 - When system settings have changed
 - For project files created on a different version of GP-Pro EX (Note that you can transfer files as long as the run-time system, protocol driver, and I/O driver versions are the same.)
- The modem connecting to the GP must meet the following requirements. The modem must:
 - Support AT commands
 - Allow automatic answering
 - Support hardware flow control
 - Return strings with a Result commandA modem can be used only after connecting to a specific operation center.
- Since the GP receiving modem is analog, you cannot use ISDN TA modem.
- The modem connected to your PC must support AT commands. Use a Windows-compatible modem that can establish telephone communication with the modem connected with GP.
- For supported modem models, refer to Pro-face's support site "Otasuke Pro!" (<http://www.pro-face.com/otasuke/>).
- Modem transfer is not available when using WinGP.

33.11.6 Restrictions on Memory Loader

- The CF Card memory size must be at least 64MB.
- There is a limit to the frequency that data can be rewritten to the CF Card. 500 KB of data can be rewritten around 100,000 times. Backup to another media.
- CF Cards and USB storage devices require different "memory loader tools" for startup. Create the respective tools.
- Even if multiple USB storage devices are connected to the GP, you can only use the USB storage that is first recognized.
- When using the memory loader to download the GP-Pro EX project to a GP set up with a Pro-Server EX project file (*.npx), be aware that the .npx file will be deleted. Using the CF card or USB storage device, follow these steps to move .prx and .npx project files to another GP.
 - 1 Transfer the GP-Pro EX project file (.prx) from the PC to the GP.
 - 2 Transfer the Pro-Server EX project file (.npx) from the PC to the GP.
 - 3 Start the memory loader tool on the GP to begin upload operations. The GP-Pro EX (.prx) and Pro-Server EX (.npx) project files on the GP are saved to the CF card or USB storage device.
 - “ ■ Transferring Project Files from GP to PC (or to Another GP)” (page 33-43)
 - 4 From the GP, remove the CF card or USB storage device and load it into a different GP to download the project files.

■ CF Card Usage Warnings

- When removing the CF Card, verify that the access LED lamp is switched off. The CF Card data can be lost or damaged if the access lamp is on.
- While accessing the CF Card, do not turn the GP off, reset the GP, or remove the CF Card. Create a preset verification screen for CF Card access. Turn off power, reset, open the CF Card cover, or remove the CF Card only after verification.
- When inserting the CF Card into the GP, ensure that you have the correct side up and the correct location for the CF Card connector. If installed incorrectly, damage can occur to the data or to the CF Card or the GP.
- Please use a CF Card made by Proface. If using another company's CF Card, damage may occur to the CF Card data.
- Please make sure to back up all CF Card data.
- Refrain from doing the following, as it can result in damage to data and equipment:
 - Bending the CF Card
 - Dropping the CF Card
 - Spilling water on the CF Card
 - Touching the CF Card connectors
 - Disassembling or modifying the CF Card

■ **Restrictions on using USB storage.**

- While accessing a USB storage device, do not reset the display unit or insert/remove the USB storage device. Data in the USB storage may be damaged.
Please design the system to turn ON the system variable "#H_Control_USBDetachTrigger" and then turn off the "#H_Status_USBUsing" in order to remove the USB storage safely.
 "A.6.2 HMI System Variables (#H system variables) ■ Bit type" (page A-102)
- Be sure to backup the data on the USB storage device.

