

31 | Controlling External I/O

This chapter describes how to set up an I/O driver and map I/O terminals for controlling external I/O.

This chapter also provides setup details about each I/O unit. Refer to the page that describes the I/O unit you are using.

31.1	Controlling External I/O	31-2
31.2	Settings Guide.....	31-12
31.3	Mapping I/O to the GP Built-in DIO	31-15
31.4	Mapping I/O to the FLEX NETWORK DIO Unit	31-17
31.5	Mapping I/O to the FLEX NETWORK Analog Unit.....	31-24
31.6	Mapping I/O to the FLEX NETWORK Positioning Unit	31-31
31.7	Mapping I/O to the FLEX NETWORK High-Speed Counter Unit	31-37
31.8	Allocating I/O to DIO Built-in LT	31-43
31.9	Allocating I/O to EX modules on the LT Display.....	31-138

31.1 Controlling External I/O

To run a logic program on the GP, you need to map addresses to external I/O terminals, and identify which addresses send out signals and which addresses take in signals.

However, the procedure for settings differs depending on whether the enabled I/O is an internal or external DIO unit.

■ GP Built-in DIO

The device consists of six inputs and two outputs. When selecting the display model, if you select a model with built-in DIO, the DIO driver is added to the project.

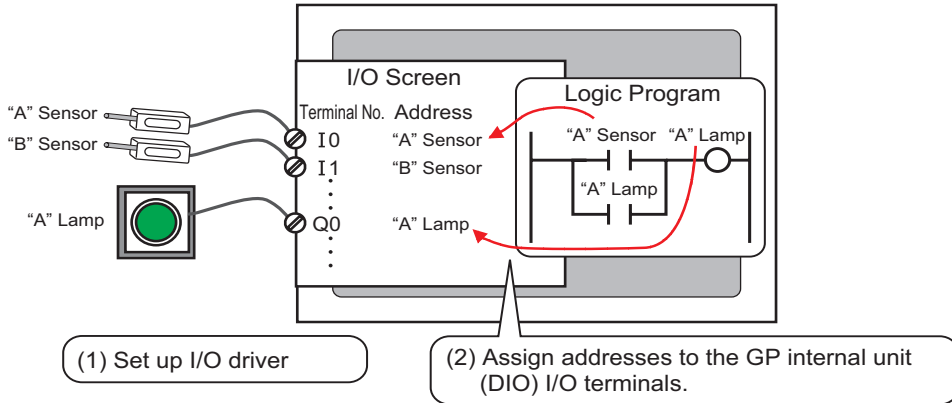

■ FLEX NETWORK

There are two lines connected to the I/O unit. The same communication data is output to line 1 and line 2.

When you use either line both line 1 and line 2 are available. When you are using one line, the maximum number of stations you can connect is 31. When you are using two lines, the maximum number of stations you can connect is 63. One line will support 31 and the other line will support 32.

For details on configuration, refer to Section 1.1 System Configurations in the "FLEX NETWORK Users Manual".

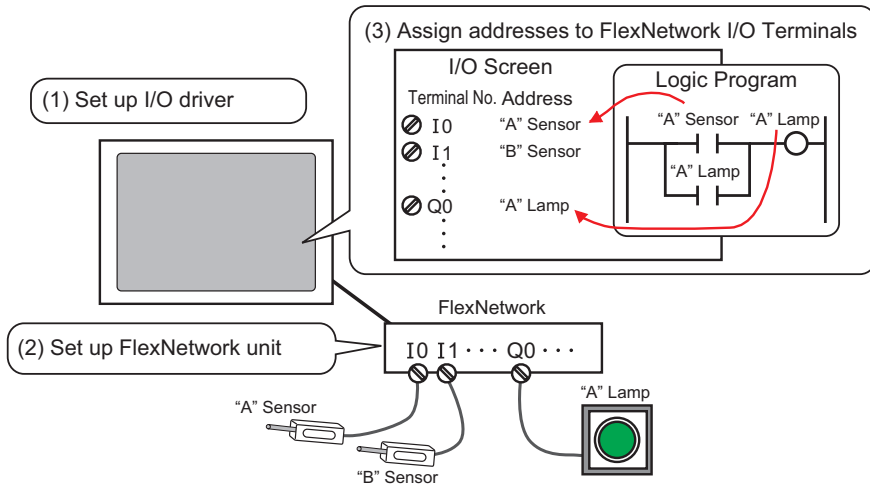

■ LT built-in DIO

The STD driver is added when you select the model.

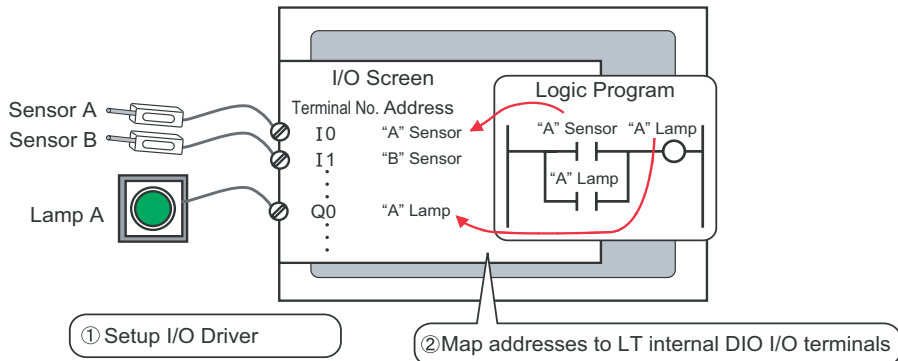

■ Attaching EX Module to the LT

The EX driver is added when you select the model.

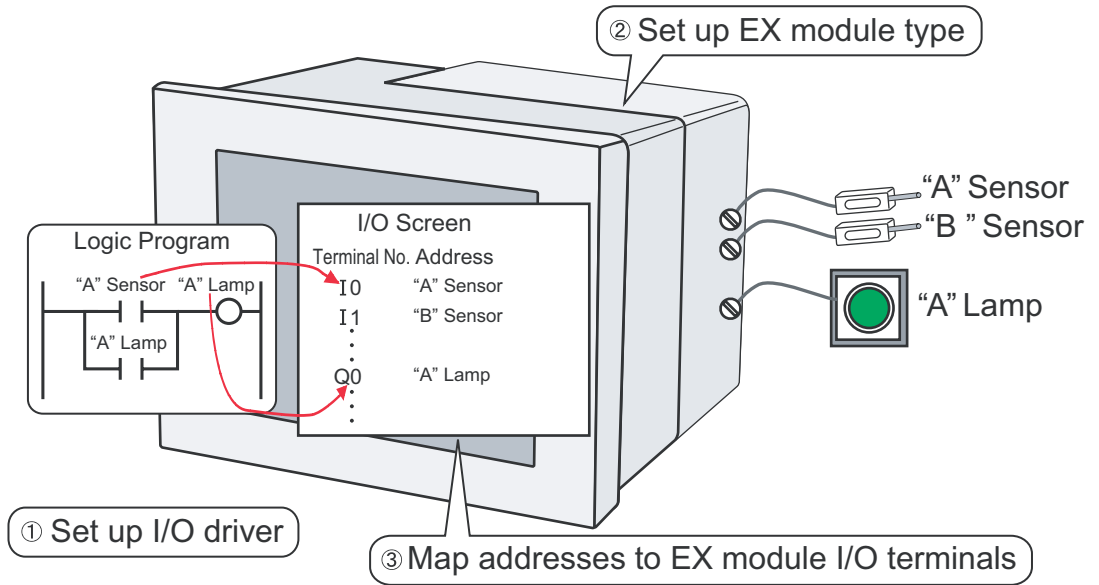

31.1.1 I/O Driver

Set the I/O driver to control the I/O using a built-in DIO or external unit.

When you use an external unit, specify the unit type and the detailed settings in [I/O Driver Settings].

- 1 Select [I/O Driver] in [System Settings].



NOTE

- If the [System Settings] tab is not displayed in the workspace, on the [View (V)] menu, point to [Work Space (W)], and then click [System Settings (S)].

- 2 Click [I/O Driver Settings] to set the detailed I/O driver settings.

NOTE

- For details on I/O driver settings for the GP built-in DIO, refer to the setup guide.
 - ☞ “ ■ DIO Driver” (page 31-12)
- For details on the I/O driver settings for FLEX NETWORK, refer to the setup guide.
 - ☞ “ ■ FLEX NETWORK Driver” (page 31-13)
- The following provides information on I/O driver settings for the LT internal DIO.
 - ☞ “31.8 Allocating I/O to DIO Built-in LT” (page 31-43)
- The following provides information on the I/O Driver Settings for the EX module at the rear of the LT.
 - ☞ “31.9 Allocating I/O to EX modules on the LT Display” (page 31-138)

3 When using an external unit, specify the unit type.

■ Using the FLEX NETWORK

- ☞ “31.4 Mapping I/O to the FLEX NETWORK DIO Unit” (page 31-17)
- ☞ “31.5 Mapping I/O to the FLEX NETWORK Analog Unit” (page 31-24)
- ☞ “31.6 Mapping I/O to the FLEX NETWORK Positioning Unit” (page 31-31)
- ☞ “31.7 Mapping I/O to the FLEX NETWORK High-Speed Counter Unit” (page 31-37)

■ Using the EX module attached to the LT

- ☞ “31.9 Allocating I/O to EX modules on the LT Display” (page 31-138)

4 Allocate the address for each I/O terminal.

NOTE

☞ “31.1.2 Mapping Addresses to I/O Terminals” (page 31-7)

31.1.2 Mapping Addresses to I/O Terminals

Allocate the address to the each I/O terminal after completing the settings for the I/O Driver and external unit models.

IMPORTANT

- When [Register Variable] is [Address Format], addresses starting with "X_", "Y_", "I_", or "Q_" are already mapped. You cannot change this setting.

Name	Variable	IEC Address
S-No.1 (FN-XY16SK)		
I0	X_0000	(%X(1.1.0))
I1	X_0001	(%X(1.1.1))
I2	X_0002	(%X(1.1.2))
I3	X_0003	(%X(1.1.3))
I4	X_0004	(%X(1.1.4))
I5	X_0005	(%X(1.1.5))
I6	X_0006	(%X(1.1.6))
I7	X_0007	(%X(1.1.7))
I8	X_0008	(%X(1.1.8))
I9	X_0009	(%X(1.1.9))
I10	X_0010	(%X(1.1.10))
I11	X_0011	(%X(1.1.11))
I12	X_0012	(%X(1.1.12))
I13	X_0013	(%X(1.1.13))
I14	X_0014	(%X(1.1.14))
I15	X_0015	(%X(1.1.15))
Q0	Y_0000	(%QX(1.1.0))
Q1	Y_0001	(%QX(1.1.1))
Q2	Y_0002	(%QX(1.1.2))

This section outlines the case when the [Register Variable] is [Variable Format].

■ Mapping Addresses to I/O Terminals

There are three ways to map addresses to I/O terminals: directly registering addresses on the I/O, mapping addresses in the Address Window, and mapping addresses in the logic program.

◆ Directly Registering Addresses on the I/O Screen

- 1 Select the I/O terminal variable and click , or double-click the variable.

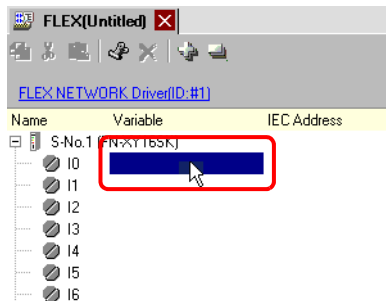

2 To map an address that has already been registered, click  and select the address.

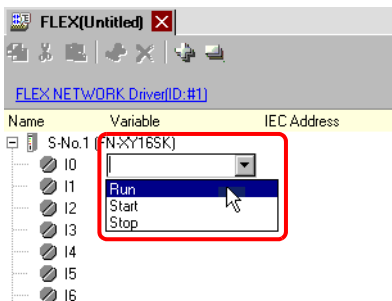

3 Press the [Enter] key to map the address and display the I/O address (IEC Address).

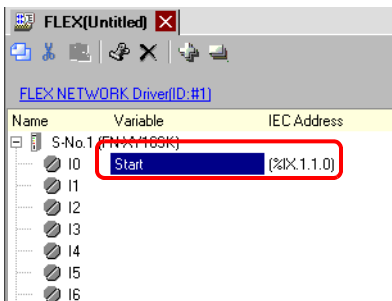

NOTE

- You can register new addresses on the I/O.
 - Type the new address name (for example, start), and press the [Enter] key. The message "Register 'start' as a bit variable" is displayed.

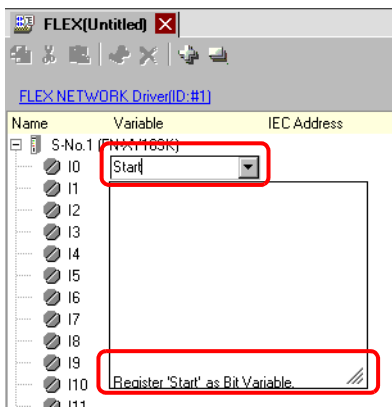

(2) Press the [Enter] key. The [Confirm Symbol Registration] dialog box appears. Click [Yes].

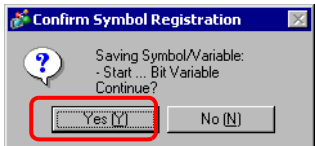

◆ Mapping an Address to I/O Terminals by Dragging the Address from the Address Window

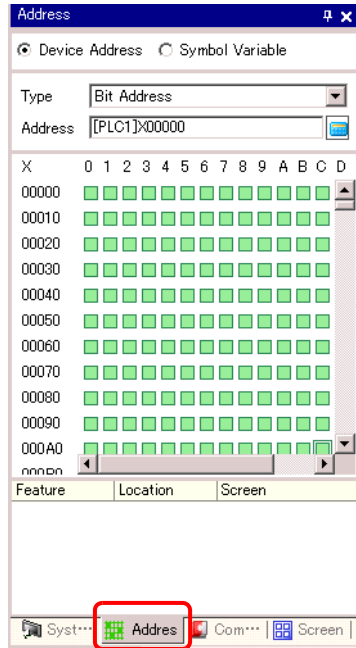

1 Select the [Address] tab to open the [Address] window.

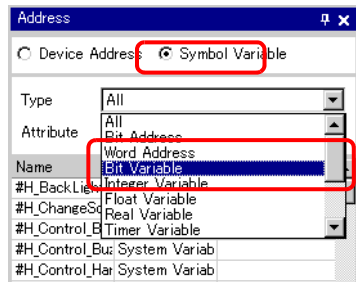

NOTE • If the [Address] tab is not displayed in the Work Space, on the [View (V)] menu, point to [Work Space (W)], and then click [Address (A)].

2 Select [Symbol Variable], and for the [Type] select [Bit Variable].



3 The list displays addresses whose [Type] equals [Bit Variable]. In the list, drag "Start" to the instruction operand you want to map the variable. Release the mouse when the pointer changes from  to .

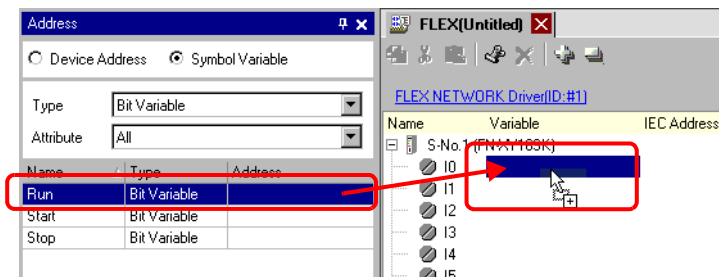

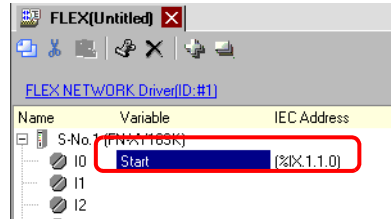

4 The address will be mapped and the I/O address (IEC address) will be displayed.







◆ **Mapping an Address to I/O Terminals by Dragging the Address from the Logic Program**

In this section, the Logic (for example, MAIN) and the IO (for example, FLEX NETWORK) are open and the two screens are displayed vertically.

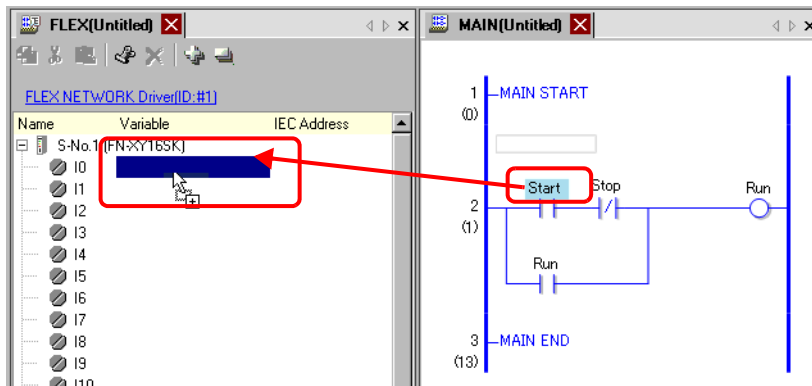
NOTE • To display two screens vertically, on the [View (V)] menu, point to [Editing Area (B)], and then click [Tile Vertically], or click .

1 Click and drag the instruction operand on the Logic and drop the instruction operand on the terminal to be mapped, when the pointer changes from  to .



NOTE • It is not possible to map an address where the pointer is displayed as .
 • Each I/O terminal address on the I/O can be dragged and mapped to an instruction operand in the logic program. Click an address in the I/O, and drag the address to the Logic instruction operand you want to map. Release the mouse where the pointer changes from  to .

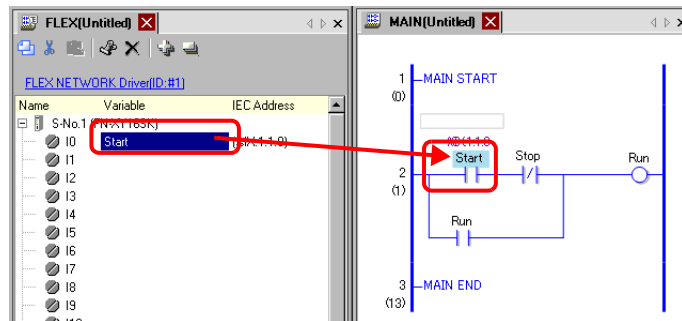

2 The address will be mapped and the I/O address (IEC address) will be displayed.

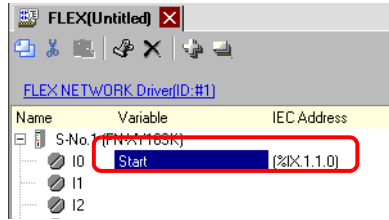

NOTE • The I/O address is also displayed in the logic program.



I/O Address Format

You can check the address mapped to I/O terminals from the logic program. This type of information is called an I/O address, and is displayed above the address in the following way.

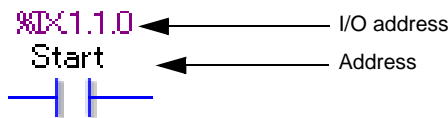

I/O address display: %AB1.C.D
 (The underlined "%" and "1" are fixed.)

Notation	Description						
A	Stores the following ID symbol for an I/O terminal. <table border="1" style="margin-left: 20px;"> <thead> <tr> <th>I/O pin</th> <th>ID symbol</th> </tr> </thead> <tbody> <tr> <td>Input pin</td> <td>I</td> </tr> <tr> <td>Output pin</td> <td>Q</td> </tr> </tbody> </table>	I/O pin	ID symbol	Input pin	I	Output pin	Q
I/O pin	ID symbol						
Input pin	I						
Output pin	Q						
B	Stores "X" for a bit pin and "W" for a word pin.						
C	Stores the FLEX NETWORK S-Number						
D	Stores the pin Number						

31.2 Settings Guide

31.2.1 [I/O Driver] Settings Guide

■ DIO Driver

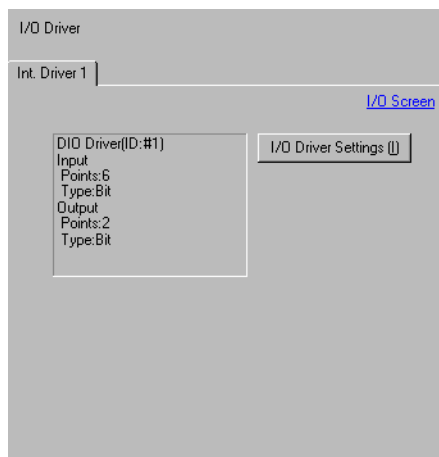

Setting	Description
I/O Driver	The I/O driver settings are shown in the tab. Internal Driver 1: Internal 1 DIO driver
	Click the button. The I/O Driver Setup dialog box appears.
I/O Screen	Click the button to switch to the I/O screen.

◆ I/O Driver Settings

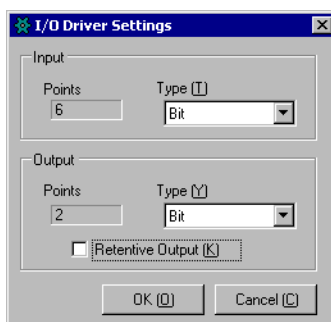

Setting	Description
Input	Select the variable type for the input from either [Bit] or [Word]. The Number of Points is 6 (fixed).
Output	Select the variable type for the output from either [Bit] or [Word]. The Number of Points is 2 (fixed).
Retentive Output	Select whether or not you want to retain output values when the logic is stopped. When this check box is selected, I/O values are retained even when the GP is shut down.

■ FLEX NETWORK Driver

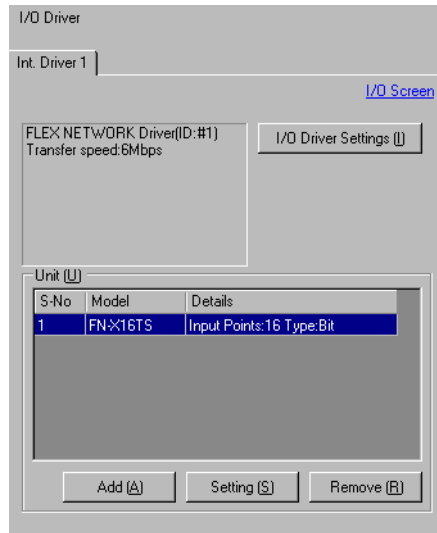

Setting	Description
I/O Driver	The I/O driver settings are shown in the tab. Internal Driver 1: Internal 1 FLEX NETWORK driver
	Click the button. The I/O Driver Settings dialog box appears. FN-X16TS is set by default.
Add	Adds I/O units.
Settings	Click the button. The [Unit Settings] dialog box appears. Use the dialog box to select your I/O unit and define I/O details. ☞ “◆ Unit Settings” (page 31-14)
Delete	Deletes I/O units.
I/O Screen	Click the button to switch to the I/O screen.

◆ I/O Driver Settings

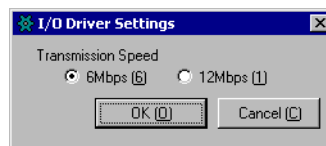

Setting	Description
Transmission Speed	Select the communication speed for FLEX NETWORK as either [6Mbps] or [12Mbps].

◆ Unit Settings

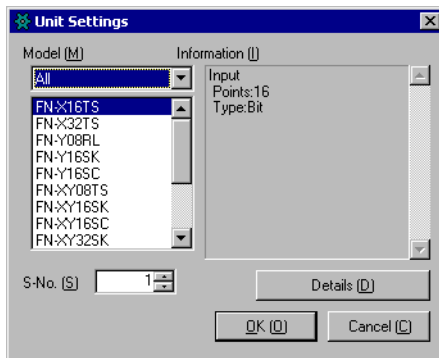

Setting	Description
Model	<p>Select the type of unit from the following options. Only relevant type models are displayed.</p> <p>All : Displays all units.</p> <p>Input : Displays units with inputs only.</p> <p>Output : Displays units with outputs only.</p> <p>I/O : Displays units with both inputs and outputs.</p> <p>Analog : Displays analog units.</p> <p>Special : Displays special units other than the above.</p>
Information	Displays details for the I/O unit settings.
Scroll box	When the I/O unit information cannot be displayed on a single screen, scroll to view all the information.
S-Number	Specify a number (S-Number) to identify the I/O unit connected to the FLEX NETWORK. The settings range from 1 (default) to 63.
Details	<p>Click the button. The [Details] dialog box for the selected I/O unit appears. If the I/O unit does not have settings details, the button cannot be clicked.</p> <ul style="list-style-type: none"> • DIO Unit <ul style="list-style-type: none"> ☞ “31.4.3 Setup Guide for the FLEX NETWORK DIO Unit ■ Unit Detail Settings” (page 31-23) • Analog Unit <ul style="list-style-type: none"> ☞ “31.5.3 Setup Guide for the FLEX NETWORK Analog Unit ■ Unit Detail Settings” (page 31-29) • Fast Counter Unit <ul style="list-style-type: none"> ☞ “31.7.3 Settings Guide for the FLEX NETWORK High-Speed Counter ■ Unit Detail Settings” (page 31-42)