

13 | Lamp

This chapter explains how to display and operate “Lamp” in GP-Pro EX. Please start by reading “13.1 Settings Menu” (page 13-2) and then turn to the corresponding page.

13.1	Settings Menu	13-2
13.2	Turning ON/OFF with the Bit's ON/OFF	13-4
13.3	Switching by Turning Multiple Bits ON/OFF (Up to 5 States)	13-8
13.4	Switching by a Combination of Multiple Bits (Up to 16 States)	13-13
13.5	Switching by the Word Address Bit Change (Bit Settings)	13-18
13.6	Switching by the Word Address Data Change (Up to 16 States)	13-23
13.7	Procedure for Creating a Lamp.....	13-28
13.8	Lamp Settings Guide.....	13-30

13.1 Settings Menu

Turning ON/OFF with the Bit's ON/OFF

Turned ON with the specified bit address ON

X100: ON → Turned ON

Turned OFF with the specified bit address OFF

X100: OFF → Turned OFF

→ Setup Procedure (page 13-5)
 → Details (page 13-4)

Switching by Turning Multiple Bits ON/OFF (Up to 5 States)

Using a device (PLC)'s four bit devices, one lamp displays each device's ON/OFF state with different colors on the GP.

Move right	X101	Green
STOP	X102	Yellow
Move left	X103	Blue
Error	M100	Red

→ Setup Procedure (page 13-9)
 → Details (page 13-8)

Switching by a Combination of Multiple Bits (Up to 16 States)

Using a device (PLC)'s up to four bit devices, one lamp displays each bit address' combination of ON/OFF states with different colors on the GP.

Display with different colors depending on bit combinations

State	Display Color	X104	X103	X102	X101
State 00	Blue	0	0	0	0
State 01	Red	0	0	0	1
State 02	Yellow	0	0	1	0
State 03	Green	0	0	1	1
⋮	⋮	⋮	⋮	⋮	⋮

Changes with up to 16 colors

→ Setup Procedure (page 13-14)
 → Details (page 13-13)

Switching by the Word Address Bit Change (Bit Settings)

Using a device (PLC)'s one word device, one lamp displays the ON/OFF state for each of the 16 bits with different colors on the GP.

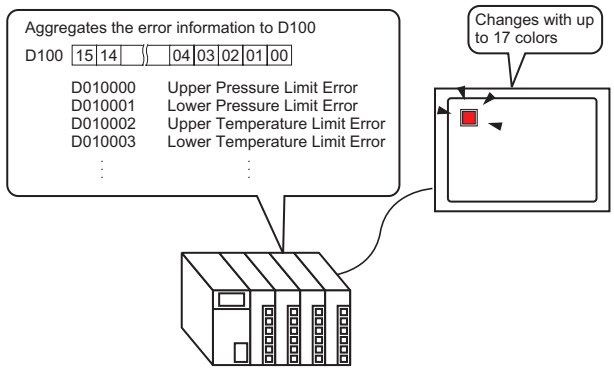

- ☞ Setup Procedure (page 13-19)
- ☞ Details (page 13-18)

Switching by the Word Address Data Change (Up to 16 States)

Seeing the data “0 to 15” stored in the word address, one lamp displays the state with different colors.

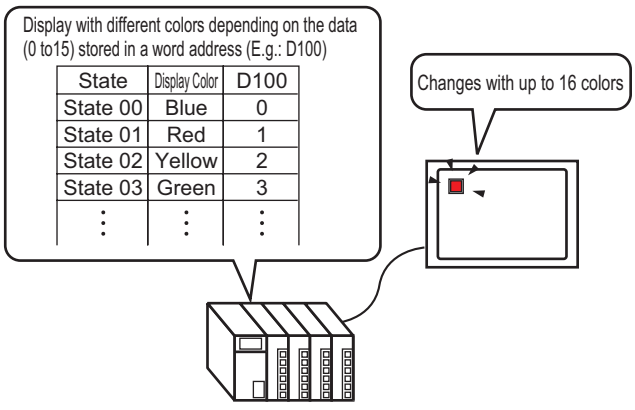

- ☞ Setup Procedure (page 13-24)
- ☞ Details (page 13-23)

13.2 Turning ON/OFF with the Bit's ON/OFF

13.2.1 Details

Displays the device (PLC)'s bit device X100 ON/OFF state on the GP.

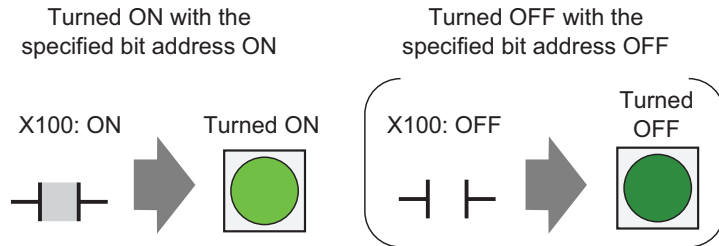
**IMPORTANT**

- If the state display is set for [Interlock Feature] or [Delay Feature] in the [Detail] setting for the [Switch Common] tab in the [Switch/Lamp] dialog box, [Interlocked Condition Display] has the highest priority, followed by [In-Delay Status Display]. Consequently, the lamp may not be displayed properly as expected.

13.2.2 Setup Procedure

- NOTE**
- Please refer to the settings guide for details.
 - ☞ “13.8 Lamp Settings Guide” (page 13-30)
 - For details of the part placement method and the address, shape, color, and label setting method, refer to the “Part Editing Procedure”.
 - ☞ “9.6.1 Editing Parts” (page 9-37)

Displays the device (PLC)'s bit device X100 ON/OFF state on the GP.

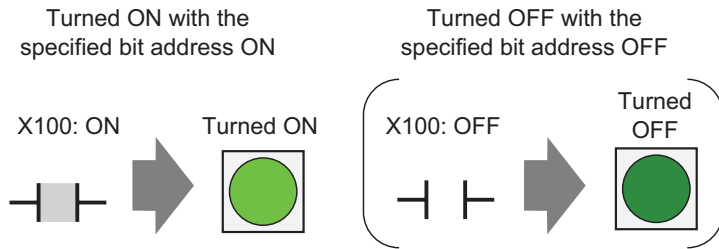

- 1 Select the [Part (P)] menu - [Switch Lamp (C)] option - [Lamp (L)] command or click  to place a lamp on the screen.
- 2 Double-click the placed lamp and the setting dialog box will be displayed.

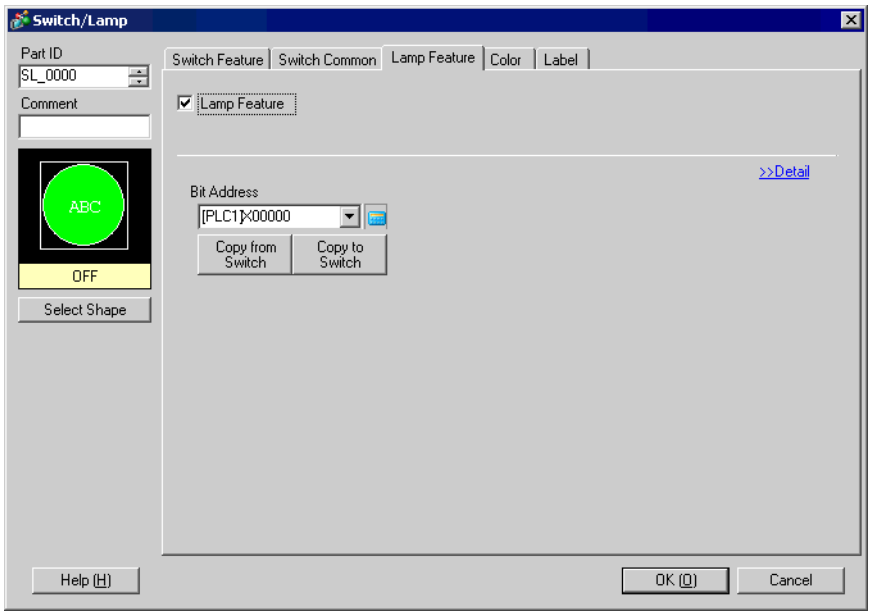

3 Select a shape for when the lamp is ON (State 1) and OFF (State 0) in [Select Shape].

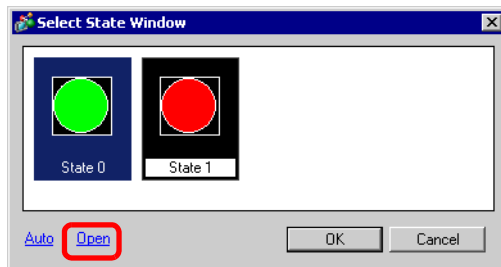

4 Set the bit address to turn ON/OFF the lamp. (e.g.: X100)

Click the icon to display an address input keypad.

Select the device "X", input "100" in the address, and press the "Ent" key.

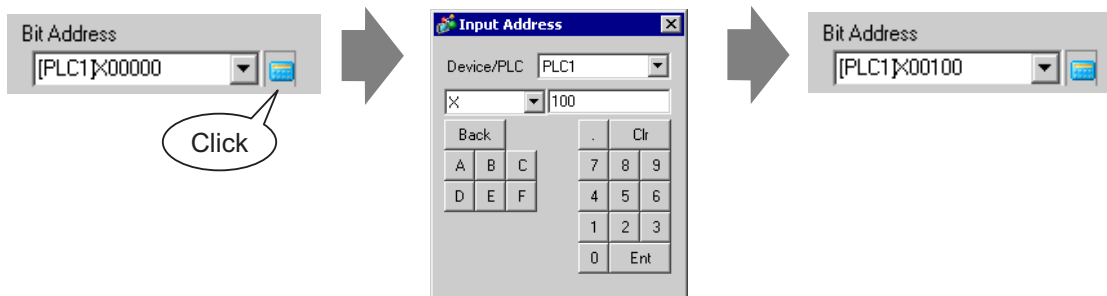

5 Click the [Color] tab and set the Lamp's display colors. Specify a [Display Color], [Pattern] and [Border Color] for each case where the [Select State] is ON or OFF.

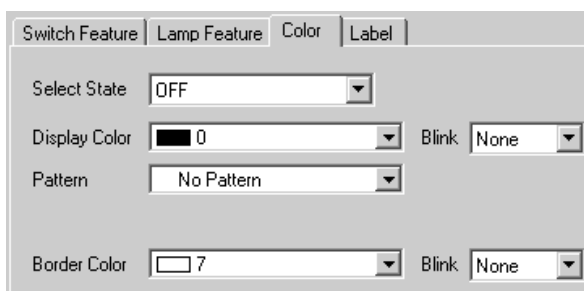

- 6 Click the [Label] tab and set the label displayed at the top of the lamp parts. Specify its font and size, input display text into the rectangle field, and click [OK].

Switch Feature | Lamp Feature | Color | **Label**

Direct Text Text Table

Select State: State 0

Font Settings:

Font Type: Standard Font Size: 8 x 16 dot

Display Language: ASCII Text Attribute: Standard

OFF

Text Color: [White] 7 Blink: None

Shadow Color: [Blue] 1 Blink: None

Background Color: Transparent Blink: None

Copy to All Labels Clear All Labels

Fixed Position Tracking

Row Spacing: 0

The process is complete.

13.3 Switching by Turning Multiple Bits ON/OFF (Up to 5 States)

13.3.1 Details

Using a device (PLC)'s four bit devices, one lamp displays each device's ON/OFF state with different colors on the GP.

In the following example, a total of four bits, including the crane movement directions (Right, Left and Stop) and the error notice bit, and the state with all bits OFF are displayed with one lamp with different colors on the GP.

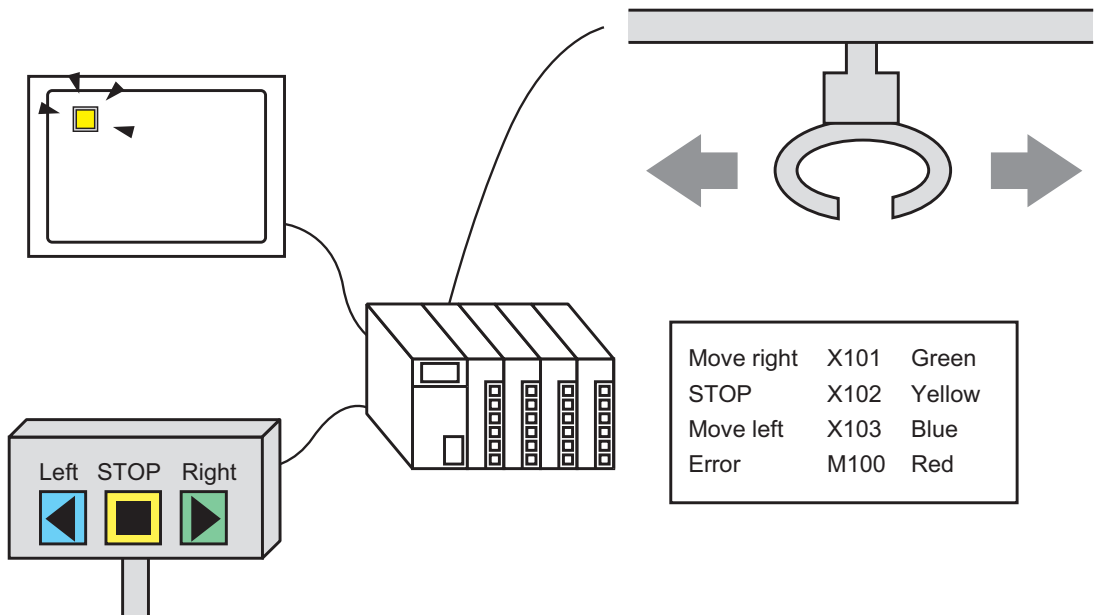

IMPORTANT

- If the state display is set for [Interlock Feature] or [Delay Feature] in the [Detail] setting for the [Switch Common] tab in the [Switch/Lamp] dialog box, [Interlocked Condition Display] has the highest priority, followed by [In-Delay Status Display]. Consequently, the lamp may not be displayed properly as expected.
- The four bit addresses specified to one lamp can be the bit addresses in different devices (PLCs).

13.3.2 Setup Procedure

NOTE

- Please refer to the settings guide for details.
 - ☞ “13.8 Lamp Settings Guide” (page 13-30)
- For details of the part placement method and the address, shape, color, and label setting method, refer to the “Part Editing Procedure”.
 - ☞ “9.6.1 Editing Parts” (page 9-37)

Using a device (PLC)'s four bit devices, one lamp displays each device's ON/OFF state with different colors on the GP.

In the following example, a total of four bits, including the crane movement directions (Right, Left and Stop) and the error notice bit, and the state with all bits OFF are displayed with one lamp with different colors on the GP.

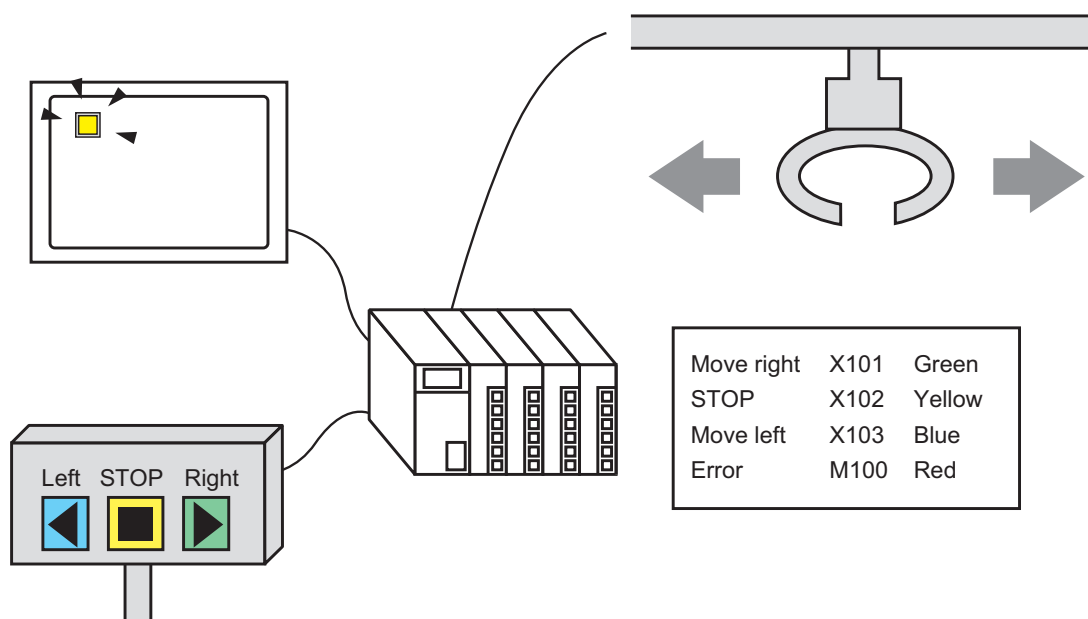

- 1 Select the [Part (P)] menu - [Switch Lamp (C)] option - [Lamp (L)] command, or click  to place a lamp on the screen.

2 Double-click the placed lamp and the setting dialog box will be displayed. Click [Detail].

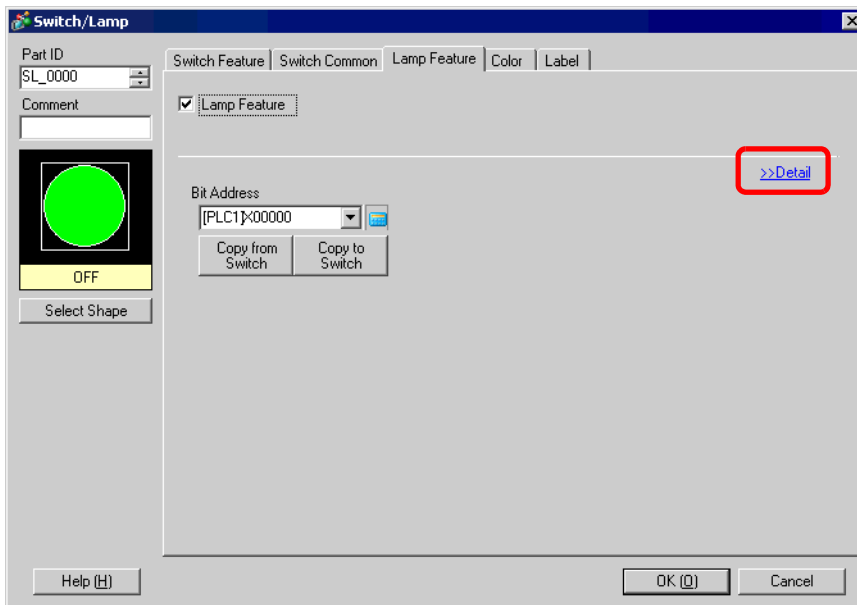

3 Set the [No. of States] and [State Switch Condition]. Setting the [No. of States] to 3 or more allows you to set [State Switch Condition]. (e.g.: [No. of States] 5, [State Switch Condition] Change Condition by Bit)

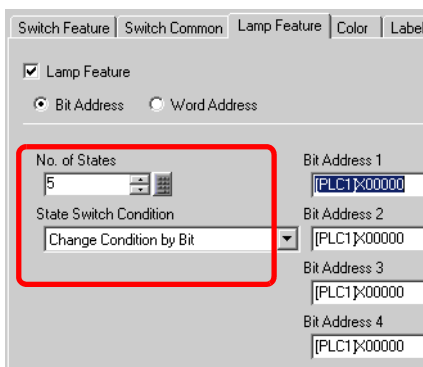

4 Set [Bit Address 1]. In the [Input Address] dialog box, select the device/PLC and set X101 to the device address, and click [Ent]. (e.g.: X101).

Click the icon to display an address input keypad.

Select the device "X", input "101" in the address, and press the "Ent" key.

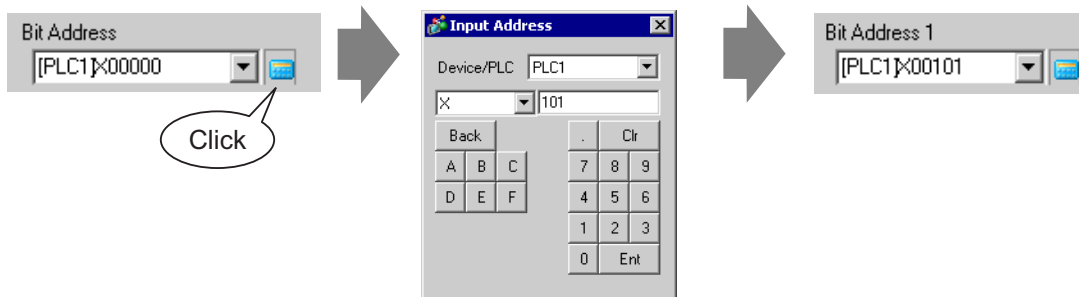

5 Also, set [Bit Address 2] to [Bit Address 4] as follows. (e.g. [Bit Address 2] X102, [Bit Address 3] X103, [Bit Address 4] M100)

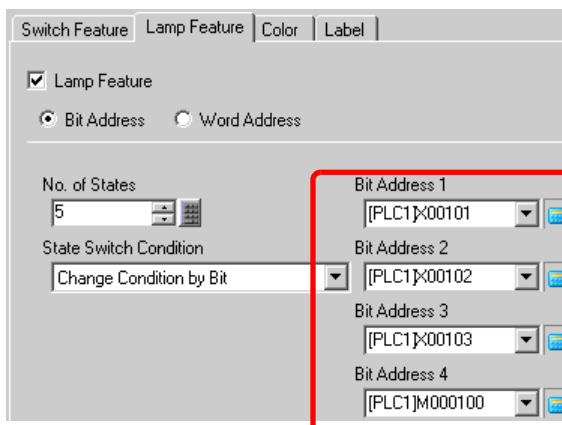

IMPORTANT

- Each [State] is defined as the ON (1)/OFF (0) of the corresponding bit address.

State	Description			
	Bit Address 4	Bit Address 3	Bit Address 2	Bit Address 1
[State 0]	0	0	0	0
[State 1]	0	0	0	1
[State 2]	0	0	1	0
[State 3]	0	1	0	0
[State 4]	1	0	0	0

- When multiple bits turn ON at the same time, a lamp display appears in the ascending order from [Bit Address 1] to [Bit Address 4], giving priority to the smallest number.

6 In [Select Shape], select the lamp shape for each [State].

Switching by Turning Multiple Bits ON/OFF (Up to 5 States)

- 7 Click the [Color] tab and set the Lamp display color for each of the five states. Select [State 0] in [Select State] and set [Display Color] as follows. [State 0] is the state where the specified bit addresses are “All OFF”.

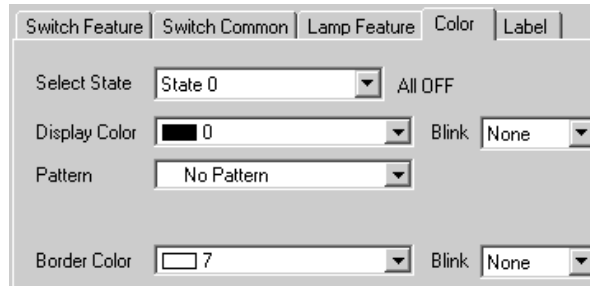

- 8 Select [State 1] in [Select State] and set the [Display Color]. [State 1] is the state where the specified bit address X101 is “ON”.

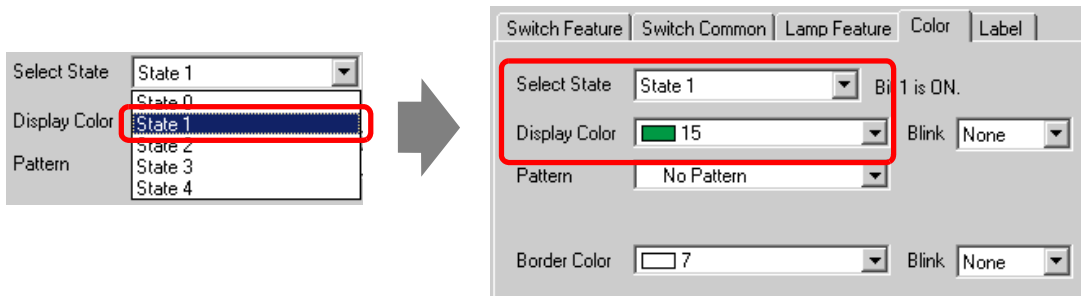

- 9 Also, set [Display Color] for states, from [State 2] to [State 4].

- 10 Click the [Label] tab and set the label displayed at the top of the lamp parts. Specify its font and size, input display text into the rectangle field, and click [OK].

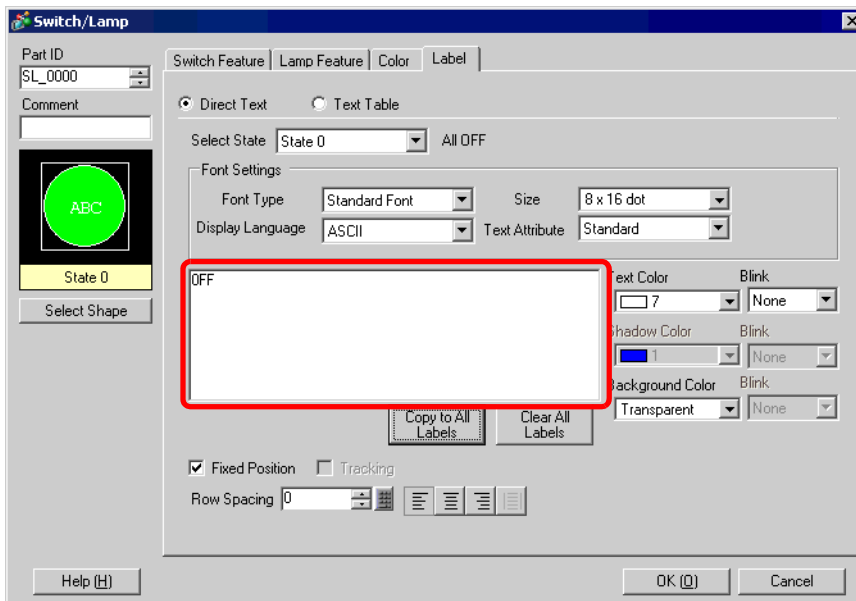

The process is complete.

13.4 Switching by a Combination of Multiple Bits (Up to 16 States)

13.4.1 Details

Use up to four bit devices of a device (PLC) and combine the ON/OFF states of their bit addresses. The resulting 16 [State(s)] are displayed by one lamp with different colors. e.g.) When a lamp displays the 16 combinations of ON/OFF states of bit addresses X101 to X104.

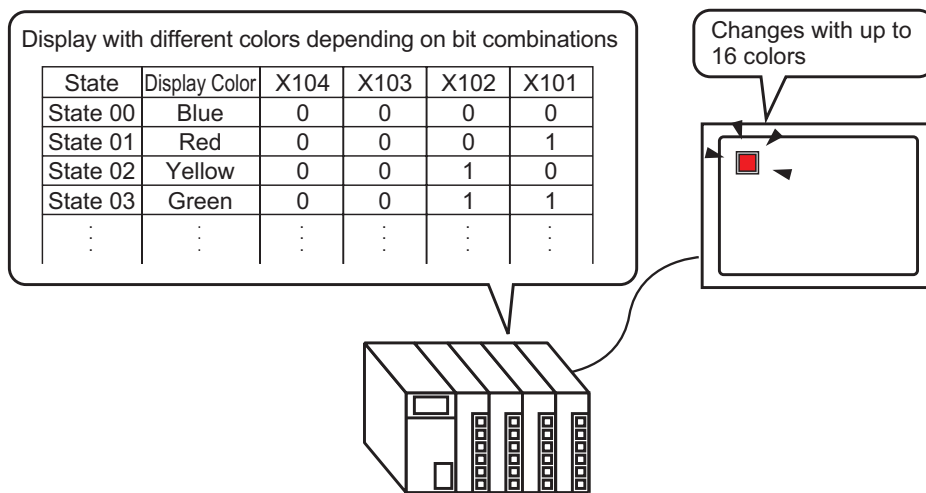

IMPORTANT

- If the state display is set for [Interlock Feature] or [Delay Feature] in the [Detail] setting for the [Switch Common] tab in the [Switch/Lamp] dialog box, [Interlocked Condition Display] has the highest priority, followed by [In-Delay Status Display]. Consequently, the lamp may not be displayed properly as expected.
- The four bit addresses specified to one lamp can be the bit addresses in different devices (PLCs).

13.4.2 Setup Procedure

NOTE

- Please refer to the settings guide for details.
 - ☞ “13.8 Lamp Settings Guide” (page 13-30)
- For details of the part placement method and the address, shape, color, and label setting method, refer to the “Part Editing Procedure”.
 - ☞ “9.6.1 Editing Parts” (page 9-37)

Use up to four bit devices of a device (PLC) and combine the ON/OFF states of their bit addresses. The resulting 16 [State(s)] are displayed by one lamp with different colors. e.g.) When a lamp displays the 16 combinations of ON/OFF states of bit addresses X101 to X104.

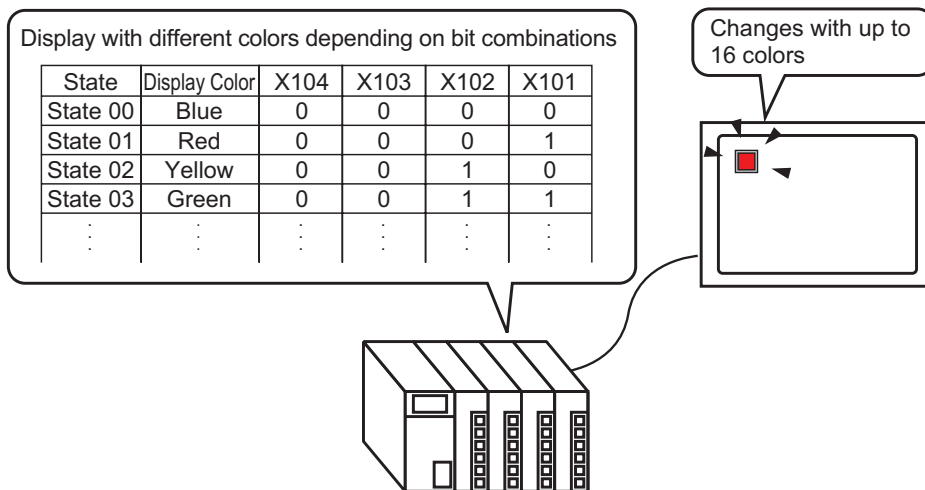

- 1 Select the [Part (P)] menu - [Switch Lamp (C)] option - [Lamp (L)] command or click  to place a lamp on the screen.

2 Double-click the placed lamp and the setting dialog box will be displayed. Click [Detail].

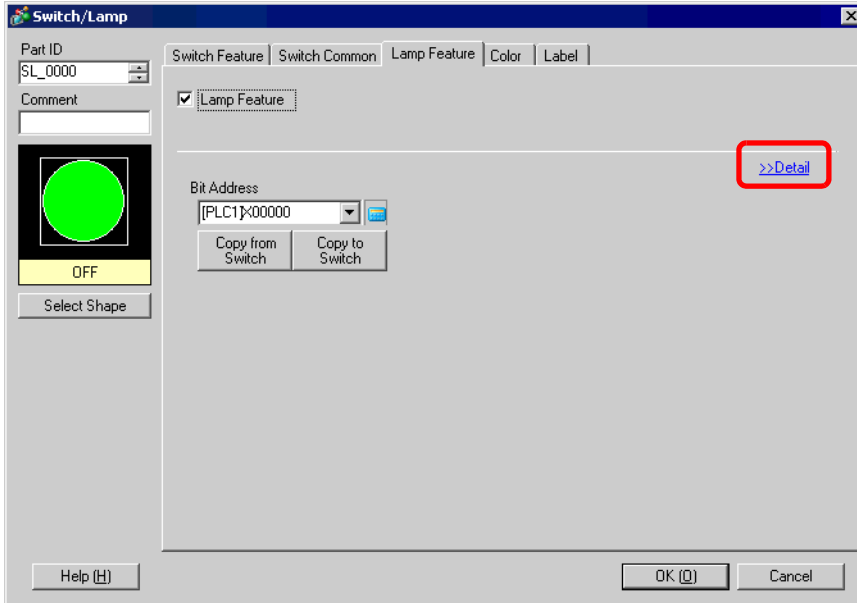

3 Set the [No. of States] and [State Switch Condition]. Setting the [No. of States] to 3 or more allows you to set [State Switch Condition]. (e.g.: [No. of States] 16, [State Switch Condition] Change Condition by Bit Combination)

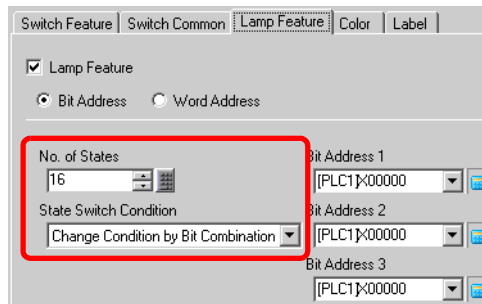

4 Specify the address to display the color coding of the lamp in [Bit Address]. (e.g.: X101)

Click the icon to display an address input keypad.

Select the device "X", input "101" in the address, and press the "Ent" key.

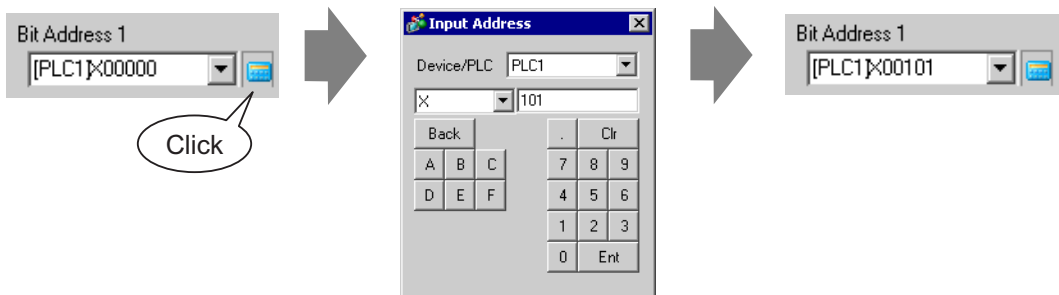

IMPORTANT • Each [State] is defined as the ON (1)/OFF (0) of the corresponding bit address.

State	Description			
	Bit Address 4	Bit Address 3	Bit Address 2	Bit Address 1
[State 0]	0	0	0	0
[State 1]	0	0	0	1
[State 2]	0	0	1	0
[State 3]	0	0	1	1
[State 4]	0	1	0	0
[State 5]	0	1	0	1
[State 6]	0	1	1	0
[State 7]	0	1	1	1
[State 8]	1	0	0	0
[State 9]	1	0	0	1
[State 10]	1	0	1	0
[State 11]	1	0	1	1
[State 12]	1	1	0	0
[State 13]	1	1	0	1
[State 14]	1	1	1	0
[State 15]	1	1	1	1

5 Also, set [Bit Address 2] to [Bit Address 4] as follows.
 (e.g. [Bit Address 2] X102, [Bit Address 3] X103, [Bit Address 4] X104)

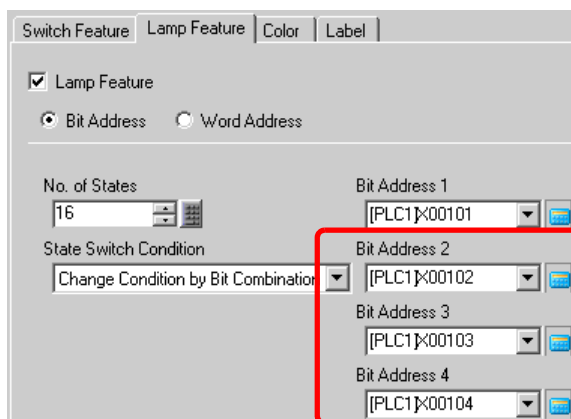

6 In [Select Shape], select the lamp shape for each [State].

- 7 [Click the [Color] tab and set the Lamp display color for each of the sixteen states. Select [State 0] in [Select State] and set the [Display Color]. [State 0] is the state where the specified bit addresses are “All OFF”.

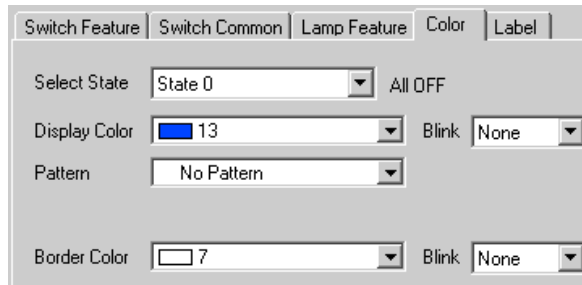

- 8 Select [State 1] in [Select State] and set the [Display Color]. [State 1] is the state where the specified bit address X101 is “ON”.

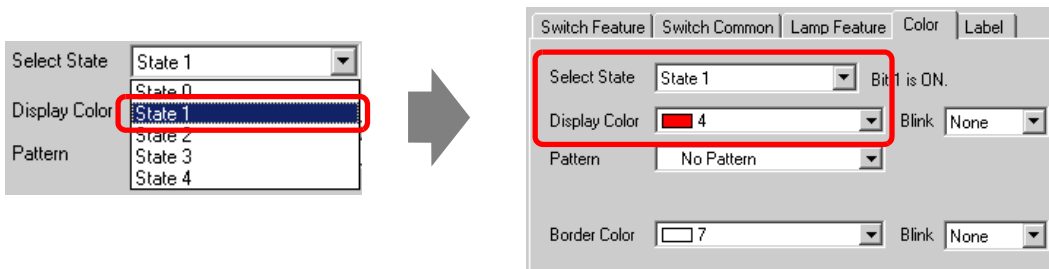

- 9 Also, set the display colors for [State 2] to [State 15].

- 10 Click the [Label] tab and set the label displayed at the top of the lamp parts. Specify its font and size, input display text into the rectangle field, and click [OK].

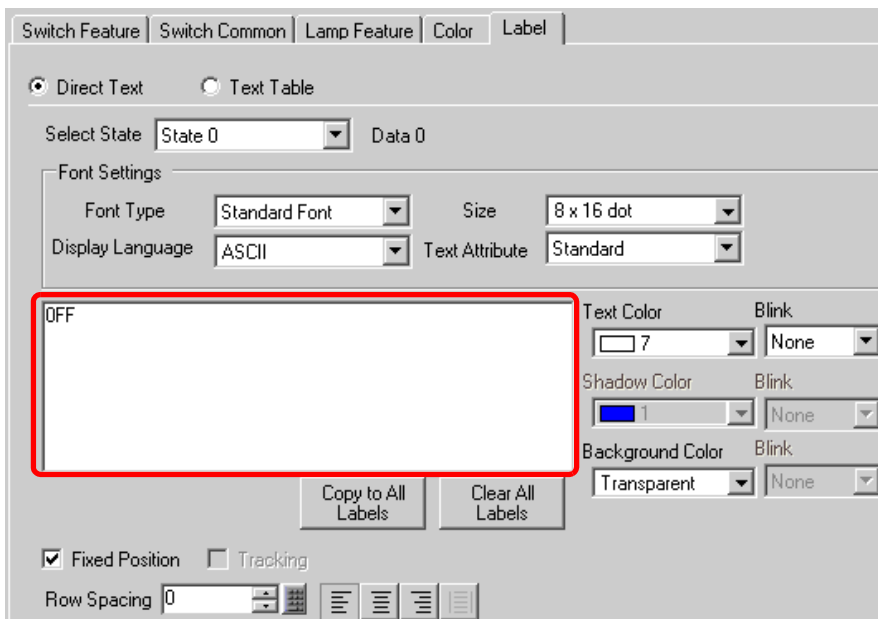

13.5 Switching by the Word Address Bit Change (Bit Settings)

13.5.1 Details

Using a device (PLC)'s one word device, one lamp displays the ON/OFF state for each of the 16 bits with different colors on the GP.

In the following example, the device error information connected to a device (PLC) is allocated to the word address D100's each bit. When an error occurs, each error is displayed with a different color according to the allocated bit with one lamp on the GP.

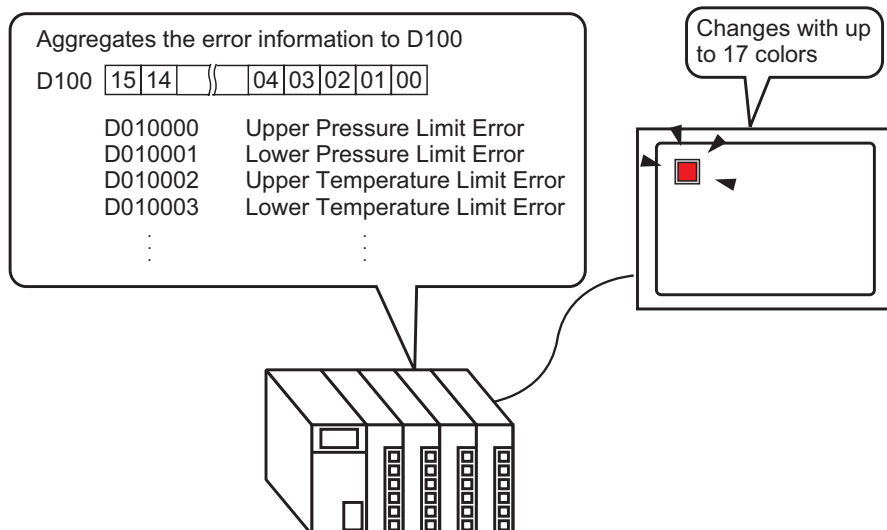

IMPORTANT

- If the state display is set for [Interlock Feature] or [Delay Feature] in the [Detail] setting for the [Switch Common] tab in the [Switch/Lamp] dialog box, [Interlocked Condition Display] has the highest priority, followed by [In-Delay Status Display]. Consequently, the lamp may not be displayed properly as expected.

13.5.2 Setup Procedure

NOTE

- Please refer to the settings guide for details.
 - ☞ “13.8 Lamp Settings Guide” (page 13-30)
- For details of the part placement method and the address, shape, color, and label setting method, refer to the “Part Editing Procedure”.
 - ☞ “9.6.1 Editing Parts” (page 9-37)

Using a device (PLC)’s one word device, one lamp displays the ON/OFF state for each of the 16 bits with different colors on the GP.

In the following example, the device error information connected to a device (PLC) is allocated to the word address D100’s each bit. When an error occurs, each error is displayed with a different color according to the allocated bit with one lamp on the GP.

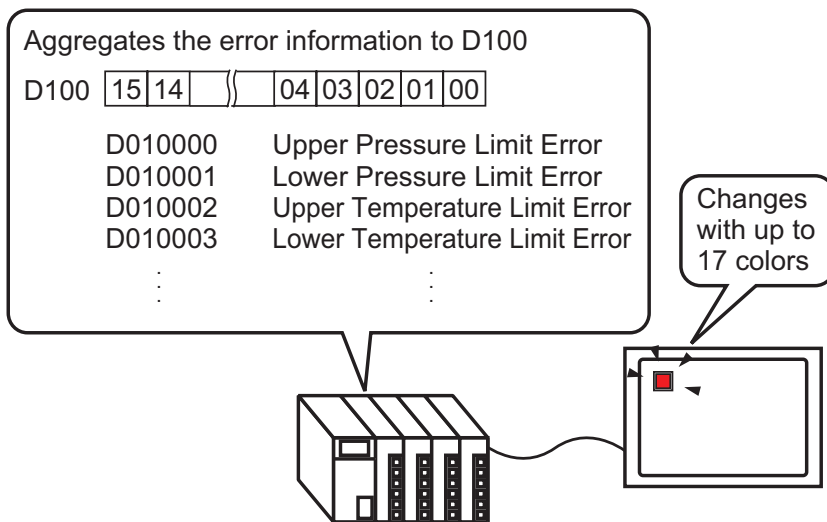

- 1 Select the [Part (P)] menu - [Switch Lamp (C)] option - [Lamp (L)] command or click  to place a lamp on the screen.

2 Double-click the placed lamp and the setting dialog box will be displayed. Click [Detail].

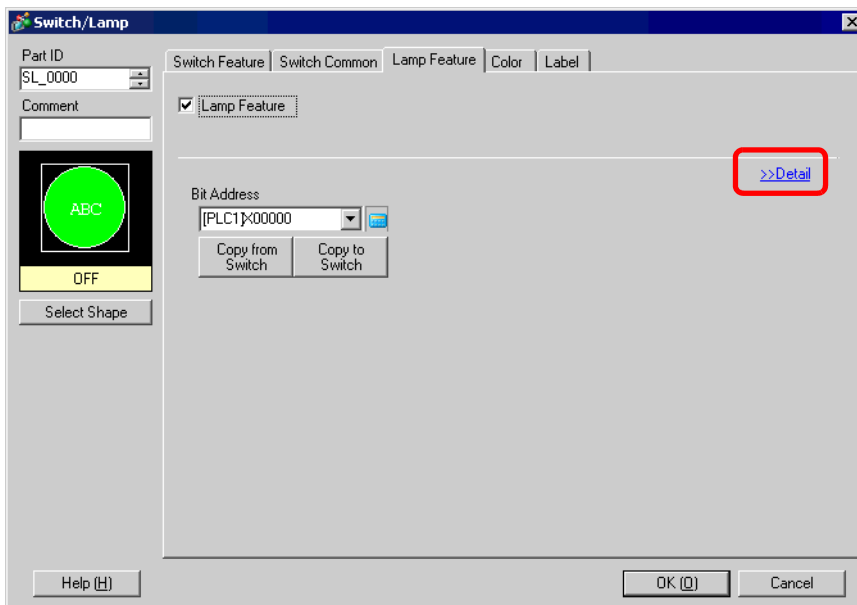

3 Select the [Word Address]. Set the [No. of States] and [State Switch Condition]. Setting the [No. of States] to 3 or more allows you to set [State Switch Condition]. (e.g.: [No. of States] 17, [State Switch Condition] Change Condition by Bit)

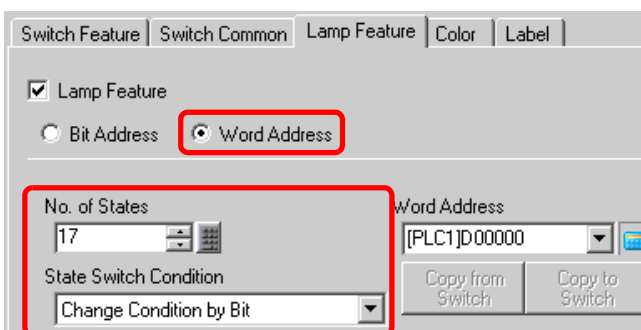

4 Specify the address to display the color coding of the lamp in [Word Address]. (e.g.: D100)

Click the icon to display an address input keypad.

Select device "D", input "100" as the address, and press the "Ent" key.

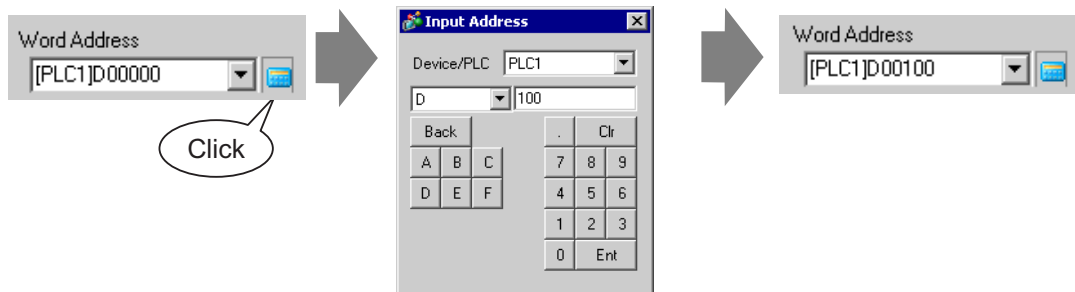

- 5 In [Select Shape], select the lamp shape for each [State].
- 6 Click the [Color] tab and set the Lamp display color for each of the seventeen states. Select [State 0] in [Select State] and set [Display Color] as follows. [State 0] is the state where the specified bit addresses are “All OFF”.

IMPORTANT

- Each [State] is defined as the ON (1)/OFF (0) of the corresponding bit address.

State	Description
[State 0]	All 0
[State 1]	Only Bit 00 is 1.
[State 2]	Only Bit 01 is 1.
[State 3]	Only Bit 02 is 1.
[State 4]	Only Bit 03 is 1.
[State 5]	Only Bit 04 is 1.
[State 6]	Only Bit 05 is 1.
[State 7]	Only Bit 06 is 1.
[State 8]	Only Bit 07 is 1.
[State 9]	Only Bit 08 is 1.
[State 10]	Only Bit 09 is 1.
[State 11]	Only Bit 10 is 1.
[State 12]	Only Bit 11 is 1.
[State 13]	Only Bit 12 is 1.
[State 14]	Only Bit 13 is 1.
[State 15]	Only Bit 14 is 1.
[State 16]	Only Bit 15 is 1.

- When multiple bits turn ON at the same time, a lamp display appears in the ascending order from [Bit 0] to [Bit 15], giving priority to the smallest number.

7 Select [State 1] in [Select State] and set the [Display Color]. [State 1] is the state where the specified word address D100's "0 Bit is ON".

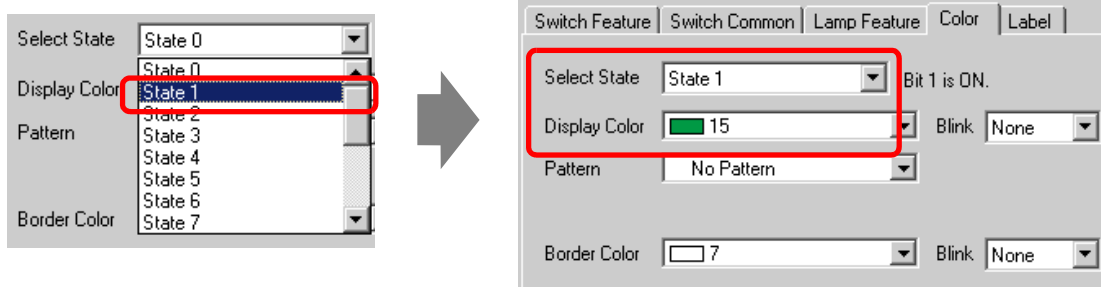

8 Also, set [Display Color] for states, from [State 2] to [State 16].

9 Click the [Label] tab and set the label displayed for each state. Specify its font and size, input display text, and click [OK].

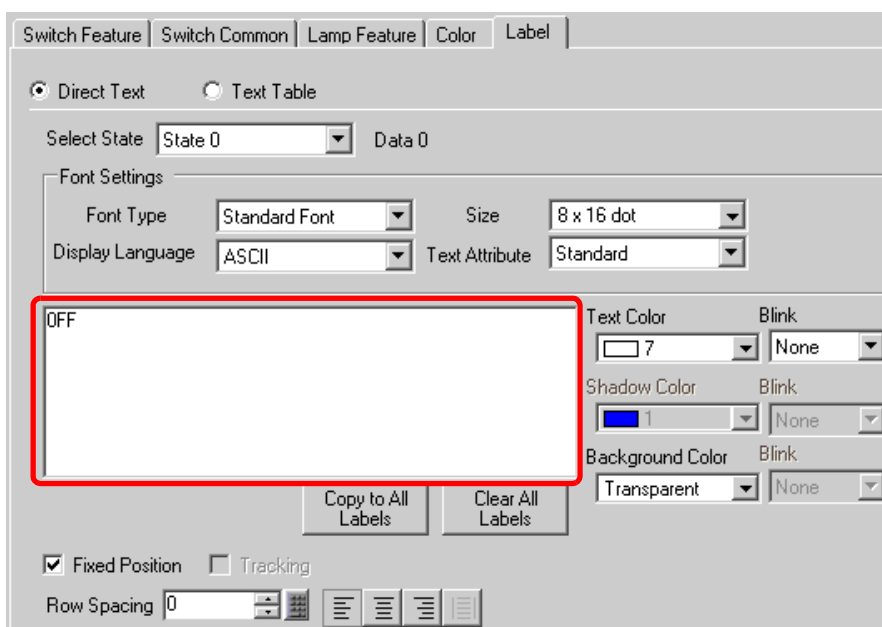

The process is complete.

13.6 Switching by the Word Address Data Change (Up to 16 States)

13.6.1 Details

Finding the data “0 to 15” stored in the word address, one lamp displays the state with different colors.

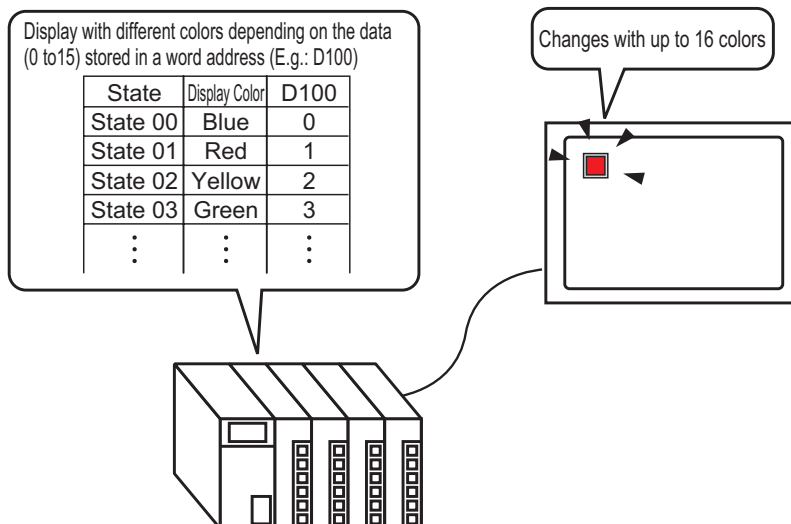

IMPORTANT

- If the state display is set for [Interlock Feature] or [Delay Feature] in the [Detail] setting for the [Switch Common] tab in the [Switch/Lamp] dialog box, [Interlocked Condition Display] has the highest priority, followed by [In-Delay Status Display]. Consequently, the lamp may not be displayed properly as expected.

13.6.2 Setup Procedure

NOTE

- Please refer to the settings guide for details.
 - ☞ “13.8 Lamp Settings Guide” (page 13-30)
- For details of the part placement method and the address, shape, color, and label setting method, refer to the “Part Editing Procedure”.
 - ☞ “9.6.1 Editing Parts” (page 9-37)

The Lamp’s state can be changed by storing a value from 0 to 15 in the specified word address. Using 00 Bit to 03 Bit of a device (PLC)’s word device, one lamp displays each bit address’ combinations of ON/OFF states with different colors on the GP.

In the following example, the combinations of ON/OFF states for each of the word address D100’s 00 Bit to 03 Bit (16 combinations) are displayed with one lamp with different colors on the GP.

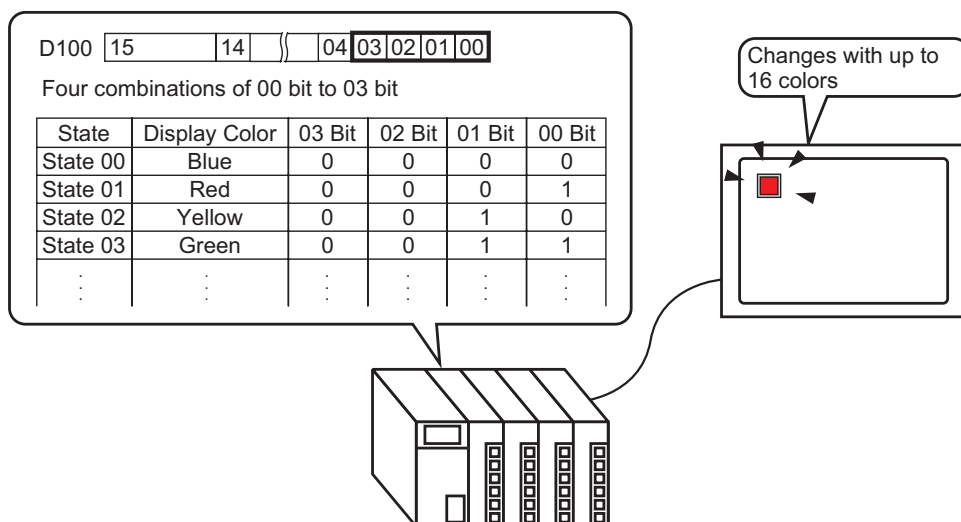

- 1 Select the [Part (P)] menu - [Switch Lamp (C)] option - [Lamp (L)] command or click  to place a lamp on the screen.

2 Double-click the placed lamp and the setting dialog box will be displayed. Click [Detail].

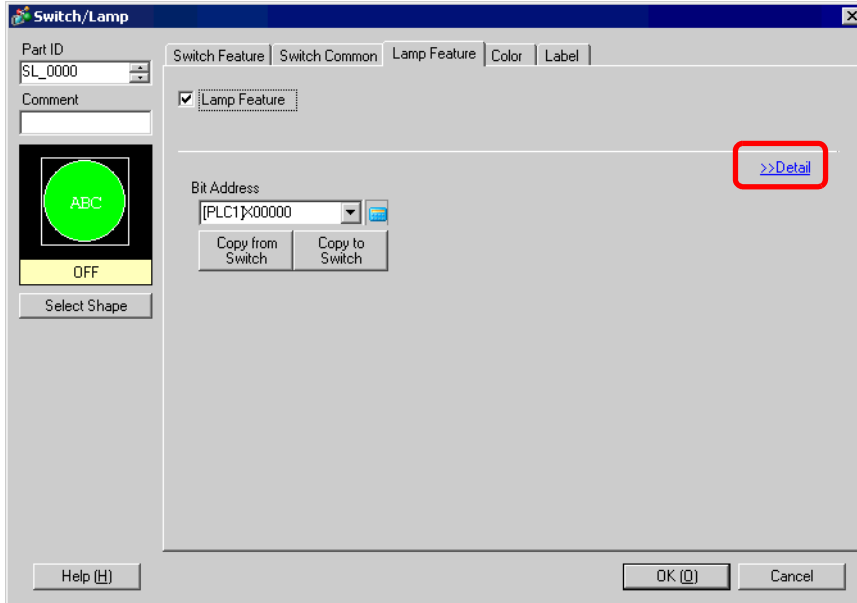

3 Select the [Word Address]. Set the [No. of States] and [State Switch Condition]. Setting the [No. of States] to 3 or more allows you to set [State Switch Condition]. (e.g.: [No. of States] 16, [State Switch Condition] Change Condition by Data)

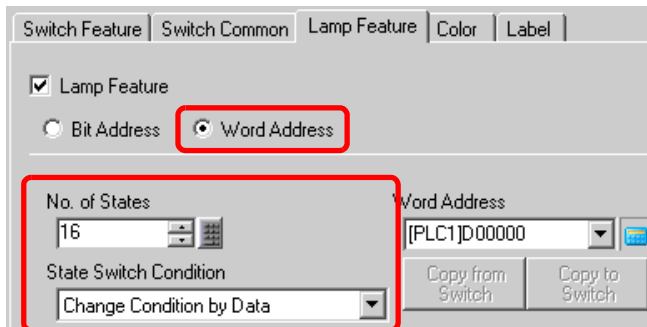

4 Specify the address to display the color coding of the lamp in [Word Address]. (e.g.: D100)

Click the icon to display an address input keypad.

Select device "D", input "100" as the address, and press the "Ent" key.

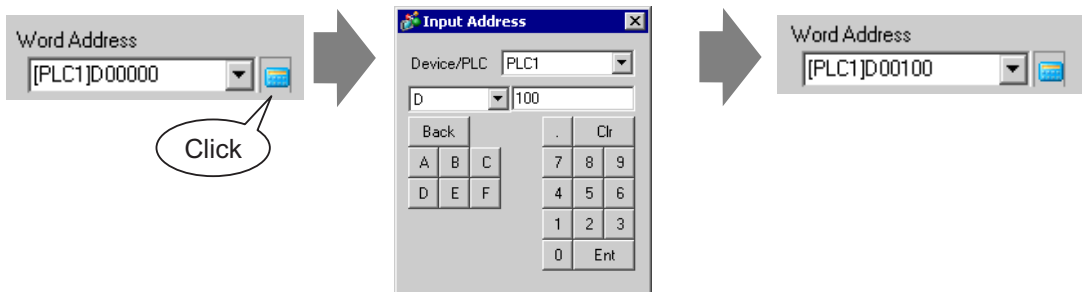

- 5 In [Select Shape], select the lamp shape for each [State].
- 6 Click the [Color] tab and specify the lamp display color for each of the 16 states. Select [State 0] in [Select State] and set [Display Color] as follows. [State 0] is the state where the specified bit addresses are “All OFF”.

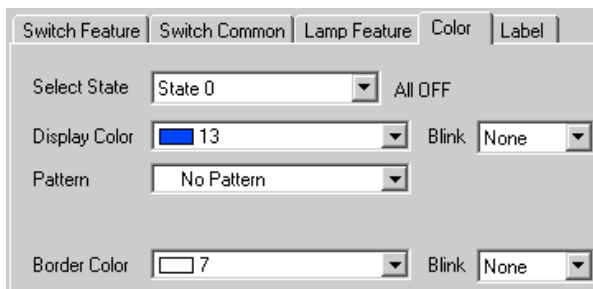

- IMPORTANT**
- Each [State] is defined as the ON (1)/OFF (0) of the corresponding bit address.

State	Description			
	Bit 03	Bit 02	Bit 01	Bit 00
[State 0]	0	0	0	0
[State 1]	0	0	0	1
[State 2]	0	0	1	0
[State 3]	0	0	1	1
[State 4]	0	1	0	0
[State 5]	0	1	0	1
[State 6]	0	1	1	0
[State 7]	0	1	1	1
[State 8]	1	0	0	0
[State 9]	1	0	0	1
[State 10]	1	0	1	0
[State 11]	1	0	1	1
[State 12]	1	1	0	0
[State 13]	1	1	0	1
[State 14]	1	1	1	0
[State 15]	1	1	1	1

- Bits 04 to 15 can be used for another application because they are not used for the [Change Condition by Data].

7 Select [State 1] in [Select State] and set the [Display Color]. [State 1] is the state where the specified word address D100 stores 1.

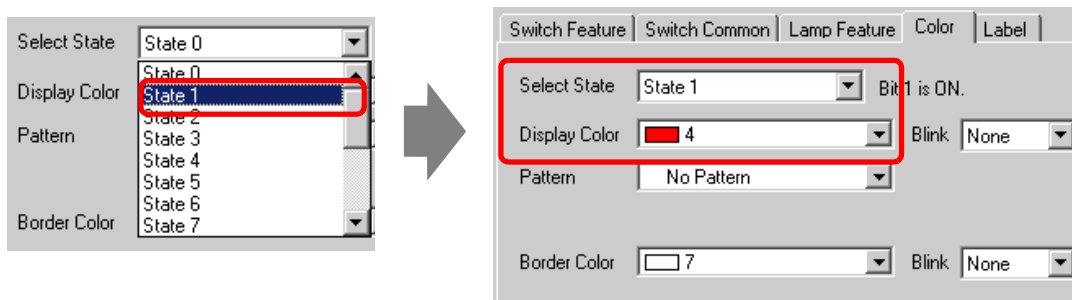

8 Also, set [Display Color] for states, from [State 2] to [State 15].

9 Click the [Label] tab and set the label displayed for each state. Specify its font and size, input display text, and click [OK].

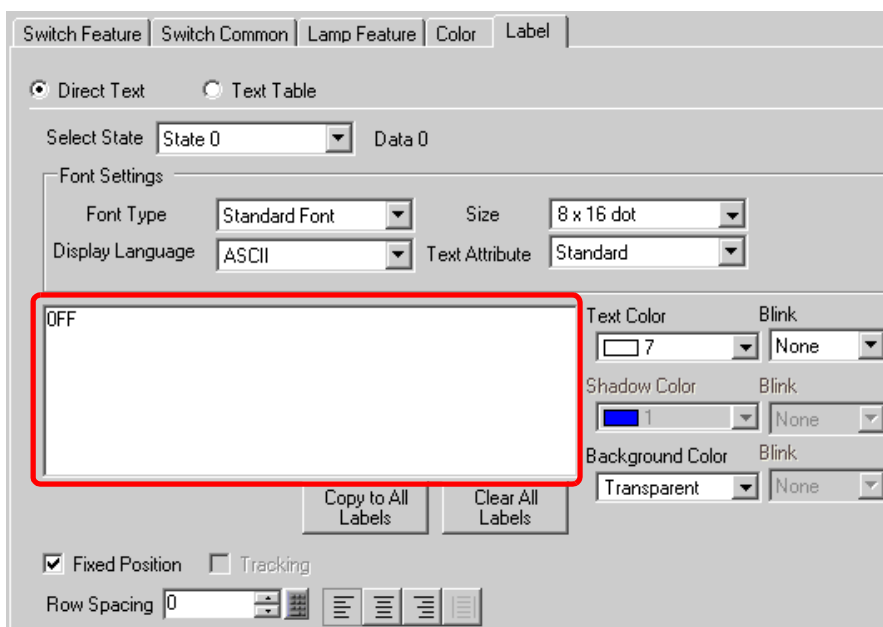

The process is complete.

13.7 Procedure for Creating a Lamp

Select the [Part (P)] menu - [Switch Lamp (C)] option - [Lamp (L)] command, or click  to place a lamp on the screen.

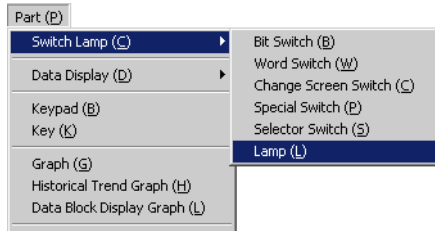

Double-click the placed lamp and the setting dialog box will be displayed.

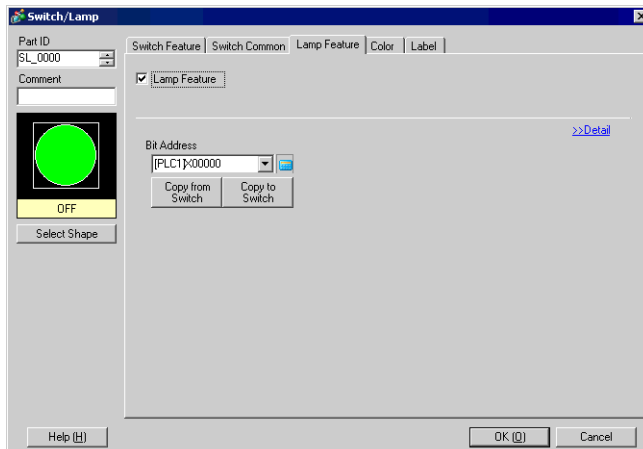

Select the lamp shape in [Select Shape]. (To use multiple bit addresses or word addresses, specify [No. of States] and then select the shape of each lamp in [Select Shape].)

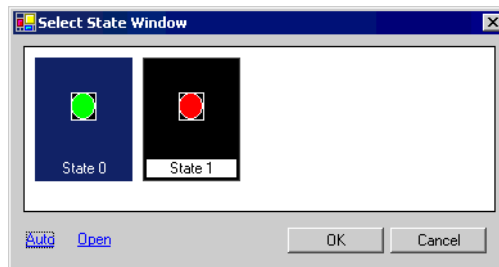

Procedure for Creating a Lamp

To display the ON/OFF state of a bit address with the lamp, specify the bit address in the [Basic] dialog box.

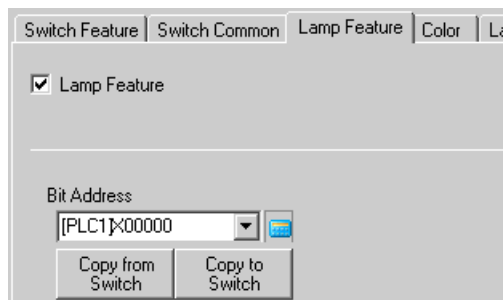

When using multiple bit addresses or word addresses, click [Detail]. Specify the operation condition and bit addresses for the lamp.

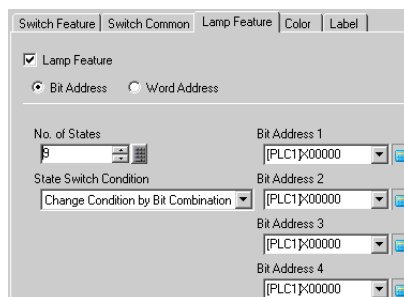

Click the [Color] tab and set the Lamp's display colors.

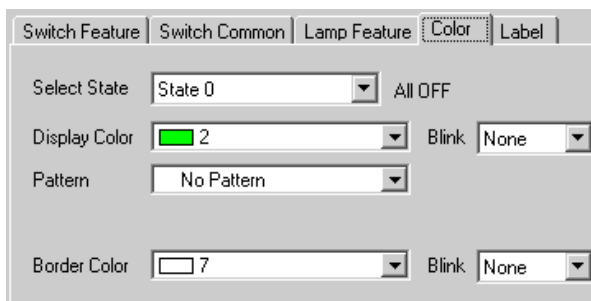

Click the [Label] tab and set the label displayed at the top of the lamp parts. If you select direct text, specify its font and size, input the text to display, and click [OK].

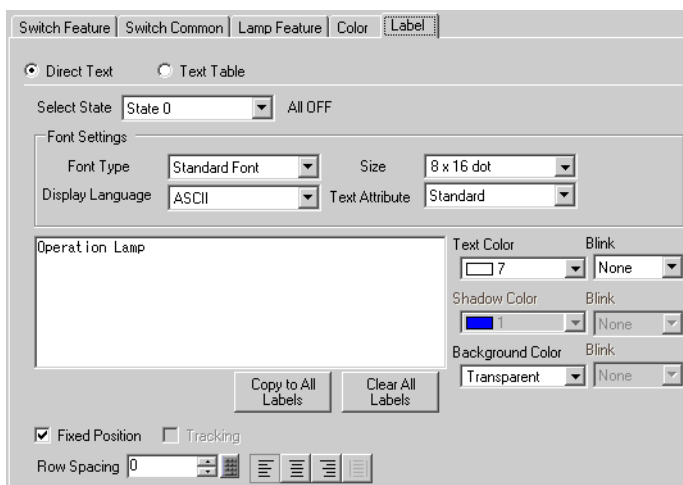

Click [OK] to complete the settings.

13.8 Lamp Settings Guide

13.8.1 Common to all Parts

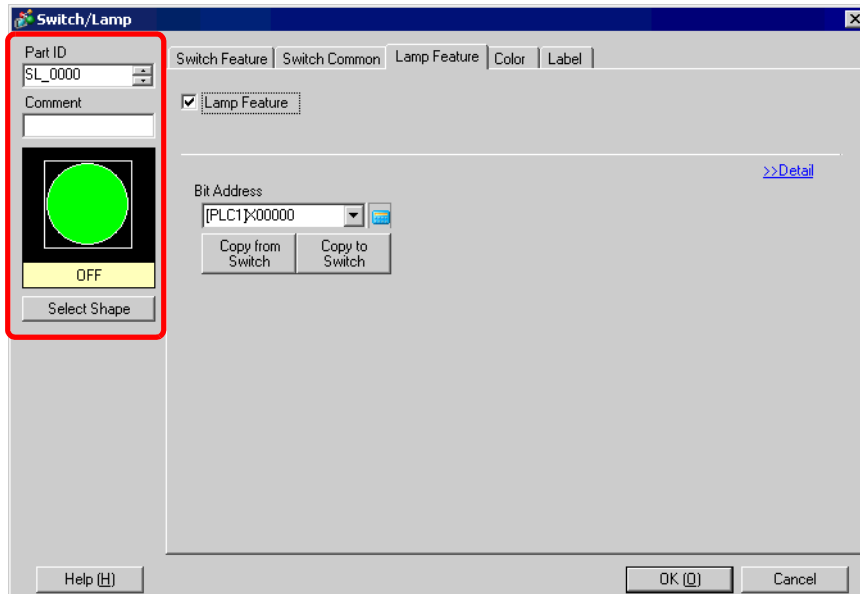

Setting	Description
Part ID	Placed parts are automatically assigned an ID number. Switch lamp part ID: SL_ (4 digits) The letter portion of the ID is fixed and depends on the part. The number portion can be changed. The setting range is from 0000 to 9999.
Comment	The comment for each Part can be up to 20 characters long.
Select Shape	The part shapes can be changed. Double-clicking a part in each state or clicking [Open] in the [Select State Window] displays the [Shape Browser] where you can change the shape of the part from the default shape.

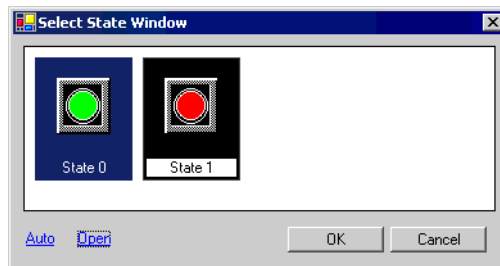

13.8.2 Lamp Feature

■ Basic

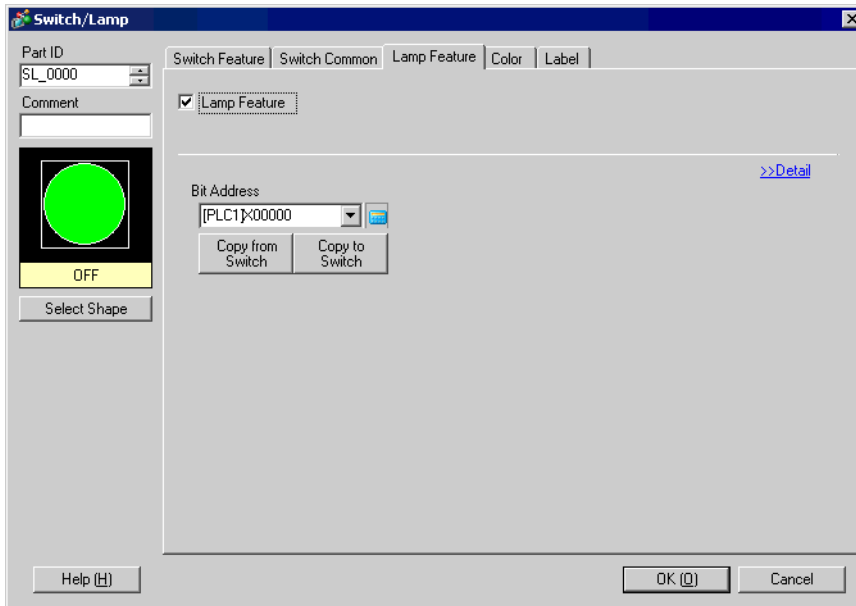

Setting	Description
Lamp Feature	Set whether or not to use the lamp feature.
Bit Address	Specify the bit address to turn ON/OFF the lamp. NOTE <ul style="list-style-type: none"> To set three or more colors for a lamp using multiple bit addresses or word addresses, set them in the [Detail] dialog box. To use multiple bit addresses: “ ■ Detail (Bit Address)” (page 13-32) To use word addresses: “ ■ Detail (Word Address)” (page 13-33)
Copy from Switch	Copies the value from the [Switch Feature] tab’s [Bit Address] setting to the [Lamp Feature] tab’s [Bit Address]. This is used when setting a Lamp Feature and Switch Feature to the same address.
Copy to Switch	Copies the value from the [Lamp Feature] tab’s [Bit Address] setting to the [Switch Feature] tab’s [Bit Address]. This is used when setting a Lamp Feature and Switch Feature to the same address.

■ Detail (Bit Address)

Select this when using multiple bit addresses.

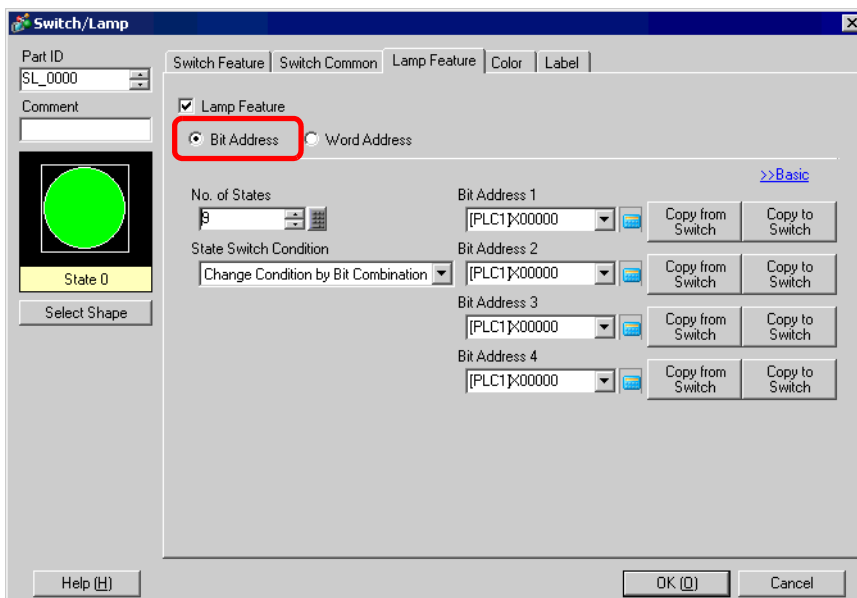

Setting	Description
No. of States	Set the number of the Lamp's color states from 2 to 16. To set four colors for one lamp, the number of states is 4.
State Switch Condition	<p>Using four bit devices, one lamp displays the combination of the bit addresses' ON (1)/OFF (0) states with different colors.</p> <ul style="list-style-type: none"> • Change Condition by Bit The color of the lamp is changed according to the ON/OFF state of the individual four bit addresses. ☞ "13.3 Switching by Turning Multiple Bits ON/OFF (Up to 5 States)" (page 13-8) • Change Condition by Bit Combination The color of the lamp is changed according to the combination of the ON/OFF states of the four bit addresses. ☞ "13.4 Switching by a Combination of Multiple Bits (Up to 16 States)" (page 13-13) <p>NOTE</p> <ul style="list-style-type: none"> • This setting is disabled when [No. of States] is 2 or less.
Bit Address	<p>Specify the bit address to turn ON/OFF the lamp.</p> <p>NOTE</p> <ul style="list-style-type: none"> • The number of addresses to set differs according to the specified [No. of States] or [State Switch Condition].
Copy from Switch	Copies the value from the [Switch Feature] tab's [Bit Address] setting to the [Lamp Feature] tab's [Bit Address]. This is used when setting a Lamp Feature and Switch Feature to the same address.
Copy to Switch	Copies the value from the [Lamp Feature] tab's [Bit Address] setting to the [Switch Feature] tab's [Bit Address]. This is used when setting a Lamp Feature and Switch Feature to the same address.

■ Detail (Word Address)

Select this when using a word address.

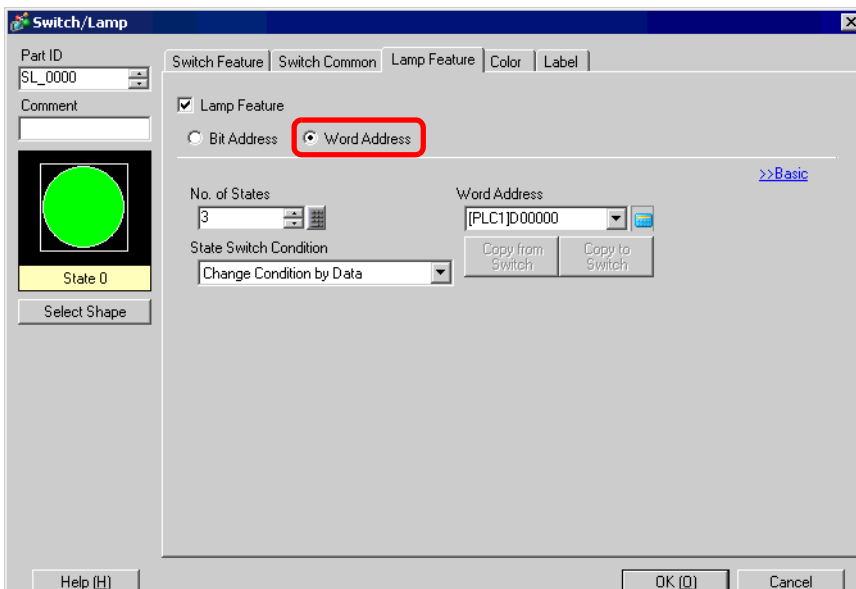

Setting	Description
No. of States	Set the number of the Lamp's color states from 2 to 17. To set 17 colors for one lamp, the number of states is 17.
State Switch Condition	<p>Using 16 bit addresses in a word address, one lamp displays the combination of the bit addresses' ON (1)/OFF (0) states with different colors.</p> <ul style="list-style-type: none"> • Change Condition by Bit The color of the lamp is changed according to the ON/OFF state of the individual 16 bit addresses. ☞ "13.5 Switching by the Word Address Bit Change (Bit Settings)" (page 13-18) • Change Condition by Data The Lamp's state can be changed by storing a value from 0 to 15. The color of the lamp is changed according to the ON/OFF status of the higher-order 4 bits in the specified word address. Up to 16 colors can be set for one lamp. ☞ "13.6 Switching by the Word Address Data Change (Up to 16 States)" (page 13-23) <p>NOTE</p> <ul style="list-style-type: none"> • This setting is disabled when [No. of States] is 2 or less.
Word Address	Specify the word address to turn ON/OFF the lamp.
Copy from Switch	Copies the value from the [Switch Feature] tab's [Bit Address] setting to the [Lamp Feature] tab's [Bit Address]. This is used when setting a Lamp Feature and Switch Feature to the same address.
Copy to Switch	Copies the value from the [Lamp Feature] tab's [Bit Address] setting to the [Switch Feature] tab's [Bit Address]. This is used when setting a Lamp Feature and Switch Feature to the same address.

13.8.3 Color

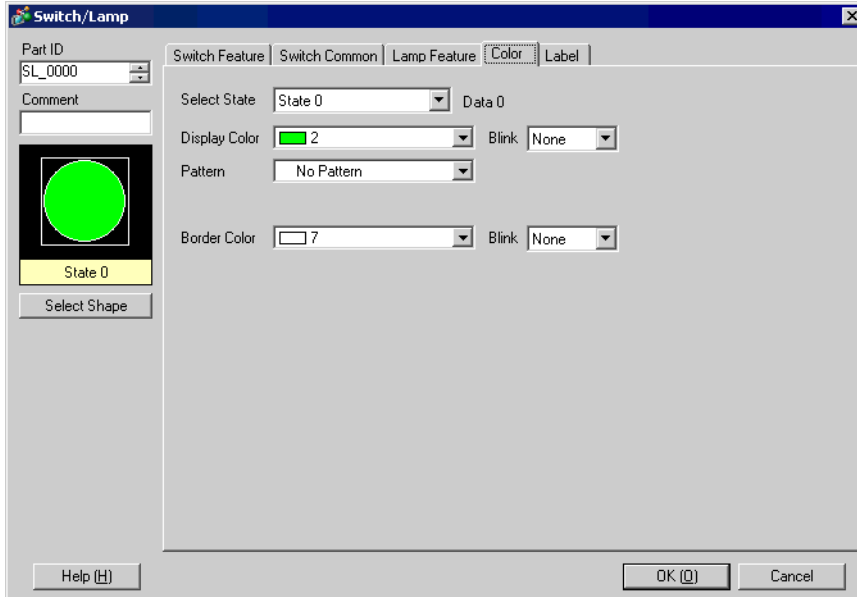

Setting	Description
Select State	Select the Lamp's state. Set the color for the Lamp's state. <ul style="list-style-type: none"> • OFF You can set the color of the Lamp when OFF. • ON You can set the color of the Lamp when ON. • State 0-State 16 Specify the [No. of States] in the [Lamp Feature]'s detail settings, and then set the color of each of the Lamp's states.
Display Color	Specify the Lamp's color.
Pattern	Specify a pattern.
Pattern Color	Select the pattern color for the Lamp.
Border Color	If the Lamp is set to have a border, select a color for it.
Blink	Select whether or not the part will blink, and the blink speed. You can choose different blink settings for the [Display Color], [Pattern Color], and [Border Color]. <div style="border: 1px solid black; padding: 2px; margin: 5px 0;">NOTE</div> <ul style="list-style-type: none"> • There are cases where you can and cannot set Blink depending on the Main Unit and System Settings' [Color Settings]. 🖱️ "9.5.2 Setting Blinks" (page 9-36)

13.8.4 Label

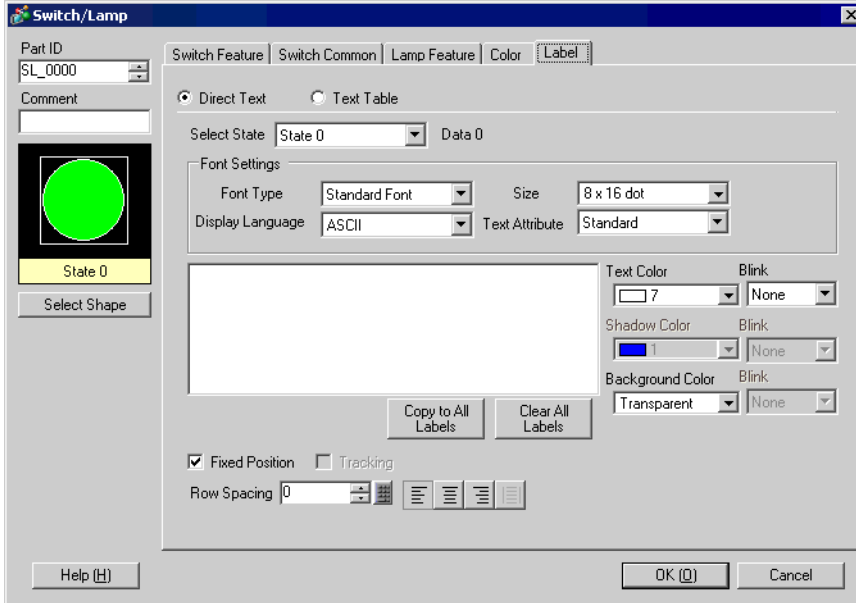

Setting	Description
Text Type	<p>Select the Label's text type.</p> <ul style="list-style-type: none"> • Direct Text Input the text into the text window, and it is placed directly as fixed text. • Text Table Use text from a previously saved Text Table. <p>☞ "15.4 Changing Languages (Multilanguage)" (page 15-15)</p>
Select State	<p>Specify the Lamp's state. Set the label for the Lamp's state.</p> <ul style="list-style-type: none"> • OFF You can set the label of the Lamp when OFF. • ON You can set the label of the Lamp when ON. • State 0-16 Specify the [No. of States] in the [Lamp Feature]'s detail settings, and then set the label of each of the Lamp's states.
Font Type	<p>When [Direct Text] is selected:</p> <ul style="list-style-type: none"> • Standard Font You can select the bit map font from [ASCII], [Japanese], [Chinese (Traditional)], [Chinese (Simplified)] or [Korean]. <p>IMPORTANT</p> <ul style="list-style-type: none"> • The standard font will become bit map font. The display speed is faster than with other fonts, but characters may have jagged outlines or get out of shape if enlarged/reduced too much. • The Japanese and ASCII standard fonts are transferred to the GP. To use the Chinese (Simplified), Korean, or Chinese (Traditional) standard font, you must add the font in [System Settings Window/Font Settings]. <p>☞ "6.2 Stroke Font, Standard Font" (page 6-3)</p>

Continued

Setting	Description
Font Type	<ul style="list-style-type: none"> • Stroke Font You can select the vector font from [ASCII], [Japanese], [Chinese (Traditional)], [Chinese (Simplified)], [Korean], [Cyrillic], or [Thai]. <p>IMPORTANT</p> <ul style="list-style-type: none"> • The standard font will become vector font. Characters are displayed with smooth outlines if enlarged, but the display speed is slower than with the standard font. • The ASCII stroke font will be transferred to the GP. To use the Japanese, Chinese (Simplified), Korean, Chinese (Traditional), Cyrillic or Thai stroke font, you must add the font in [System Settings Window/Font Settings]. ☞ “6.2 Stroke Font, Standard Font” (page 6-3) • Image Font Displays a Windows font as bit map data. ☞ “6.3 Image Font” (page 6-15) <p>When [Text Table] is selected: Select between Standard Font and Stroke Font.</p>
Size	<p>Select the character size. Each font type has a different size range.</p> <ul style="list-style-type: none"> • Character Size Standard Font: 8 × 8 dot standard unit, 1 to 8 times (8 × 8 to 64 × 64 dot) 8 × 16 dot standard unit, 1 to 8 times (8 × 16 to 64 × 128 dot) Stroke Font: 6 to 127 • Fixed Size You can select this option only when the [Standard Font] is selected. Select from [6 × 10 dots], [8 × 13 dots], or [13 × 23 dots]. When the [Fixed Size] is “6 × 10 dot”, you cannot select [Bold] for the [Text Attribute].
Display Language	Choose a text display language from [ASCII], [Japanese], [Chinese (Traditional)], [Chinese (Simplified)], [Korean], [Cyrillic], or [Thai].
Text Attribute	<p>Each font type has a different range of styles.</p> <p>Standard Font: Choose from [Standard], [Bold], [Shadow] Stroke Font: Choose from [Standard], [Bold], [Outline]</p>
Select Font	<p>If [Image Font] is selected from the [Font Type] menu, set [Font], [Font Style], [Text Size], and [Script].</p> <p>NOTE</p> <ul style="list-style-type: none"> • Because Image Font uses a standard Windows popup menu, the available font types, styles, and languages depend on your OS.
Text (Input Box)	If [Direct Text] is selected, input the text.
Text Color	Set the display color for the text. ☞ “9.5.1 Setting Colors” (page 9-34)
Background Color	Set the background color for the text. ☞ “9.5.1 Setting Colors” (page 9-34)

Continued

Setting	Description
Shadow Color	<p>If the [Font Type] menu - [Standard Font] command and the [Text Attribute] menu - [Shadow] command are selected, set the color for the text shadow.</p> <p>☞ “9.5.1 Setting Colors” (page 9-34)</p>
Blink	<p>Select whether or not the part will blink, and the blink speed. You can choose different blink settings for the [Text Color], [Shadow Color], and [Background Color].</p> <p>NOTE</p> <ul style="list-style-type: none"> • There are cases where you can and cannot set Blink depending on the Main Unit and System Settings’ [Color Settings]. <p>☞ “9.5.2 Setting Blinks” (page 9-36)</p>
Copy to All Labels	<p>Copies the current [Text] to all the Switch’s other states’ [Text]. All the other attributes in the [Label] tab will also be copied to the Switch’s other states.</p> <p>NOTE</p> <ul style="list-style-type: none"> • This can only be set if the Lamp Feature is used.
Clear All Labels	<p>Clears the [Text] box for all the Switch’s states. All of the [Label] tab’s other attributes, such as Font Type and Color, will remain the same.</p> <p>NOTE</p> <ul style="list-style-type: none"> • This can only be set if the Lamp Feature is used.
Fixed Position	<p>Set whether or not to fix the Label’s display position in the center of the Part.</p>
Tracking	<p>After the Part is placed, any changes made to the Label’s size or position will be copied to all the other states. To change the size or position of an individual state’s Label without affecting the other states, ensure that this option is not checked.</p> <p>NOTE</p> <ul style="list-style-type: none"> • When [Fixed Position] is set, the [Tracking] setting cannot be used. • When [Text Type] is set to [Text Table], the [Tracking] setting cannot be used.
Row Spacing	<p>Set a row spacing from 0 to 255. This is only applicable when multiple lines are inputted in the [Text].</p> <p>This option cannot be used when the [Font Type] is set to [Image Font].</p>
Align	<p>Aligns the inputted text. If the text is 2 lines or more, you can select [Align Left], [Align Right], or [Align Center]. When the [Font Type] is set to [Image Font], [Align on Both Sides] can also be selected.</p>

Memo