

# 24



# Data Sampling

This chapter explains about “Data Sampling” in GP-Pro EX and the basic functions used to change settings.

Please start by reading “24.1 An Introduction to the Sampling Feature” (page 24-2) and then turn to the corresponding page.

24.1	An Introduction to the Sampling Feature.....	24-2
24.2	Settings Menu .....	24-3
24.3	Sampling Data at Constant Intervals.....	24-5
24.4	Sampling Data at Specific Periods .....	24-10
24.5	Displaying Sampled Data .....	24-14
24.6	Saving Sampled Data to a CF-Card (Save in CSV).....	24-20
24.7	Display/Save Sampling Data in CSV with the Desired Format .....	24-30
24.8	Settings Guide.....	24-37
24.9	Sampling Structure.....	24-97
24.10	Restrictions .....	24-129

## 24.1 An Introduction to the Sampling Feature

### 24.1.1 What is the Sampling Feature?

This feature samples data from the desired address value of the device/PLC at the designated time and then stores it in the GP. This is useful for viewing data history.

At the designated time, data from the device/PLC is read in to the GP.

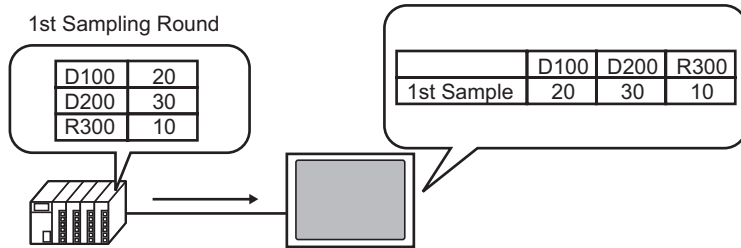

Even if data changes...

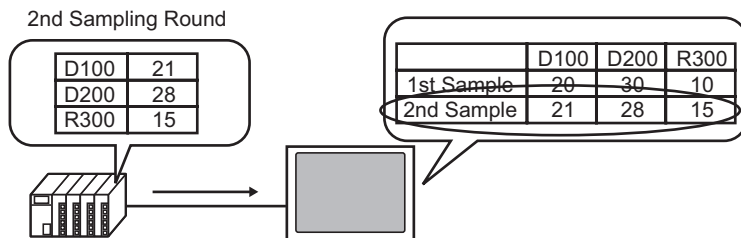

New data is added and saved.

Data collected by the Sampling feature is called “Sampling Data”.

Sampling data can be displayed on the GP’s screen as either a table or a line chart, and can be printed from a connected printer. Additionally, the collected data can be saved to the CF-card. The data is saved in CSV format and can be edited in spreadsheet software (such as Microsoft Excel).

## 24.2 Settings Menu

**Sampling Data at Constant Intervals**

Data is collected from 8 a.m. once every hour for 10 times

8:00 1st Sampling Round

D100	D101	D102
20	30	10

9:00 2nd Sampling Round

D100	D101	D102
20	30	10
21	28	15

⋮

17:00 10th Sampling Round

D100	D101	D102
20	30	10
21	28	15
32	41	24

[Setup Procedure \(page 24-6\)](#)  
[Details \(page 24-5\)](#)

**Sampling Data at Specific Periods**

Data is collected every time the designated bit turns ON.

Sampling Trigger Bit Address  
M100:ON

Data Sampling

D100	D101	D102
20	30	10

[Setup Procedure \(page 24-11\)](#)  
[Details \(page 24-10\)](#)

**Displaying Sampled Data**

Every time data is collected, it's displayed on a Sampling Data Display on the screen.

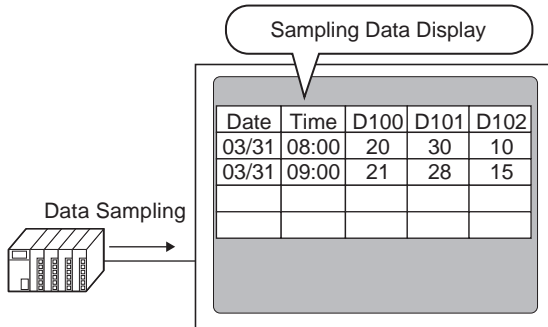

- ☞ Setup Procedure (page 24-15)
- ☞ Details (page 24-14)

**Saving Sampled Data to a CF-Card (Save in CSV)**

Write a command to the designated Control Address and the GP's sampling data is written in CSV format to the CF-card.

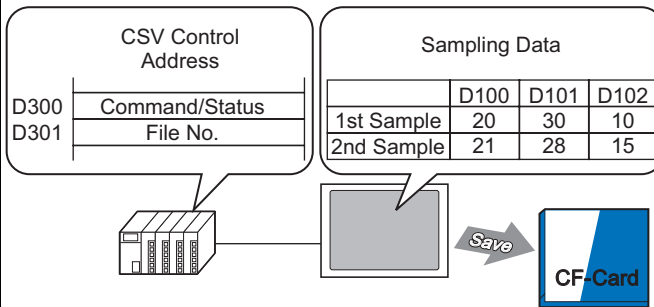

- ☞ Setup Procedure (page 24-21)
- ☞ Details (page 24-20)

**Display/Save Sampling Data in CSV with the Desired Format**

Create a customized format: display only selected data, change the Item Names, display a calculation row with averages or the maximum values, etc.

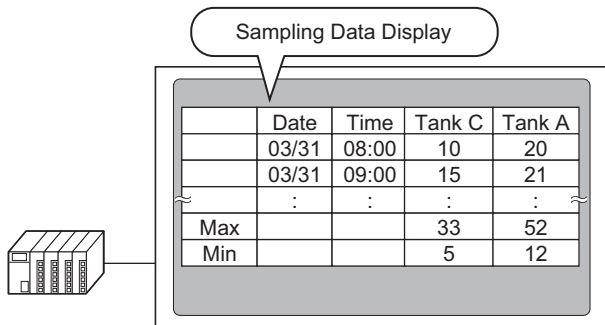

- ☞ Setup Procedure (page 24-31)
- ☞ Details (page 24-30)

## 24.3 Sampling Data at Constant Intervals

### 24.3.1 Details

Read the designated address value from the device/PLC at a fixed interval and save that data in the GP.

- When designating the Start Time and sampling data at fixed intervals after that time.  
e.g.) Start Time: 8 a.m., Cycle: 1 hour, No. of Times: 10

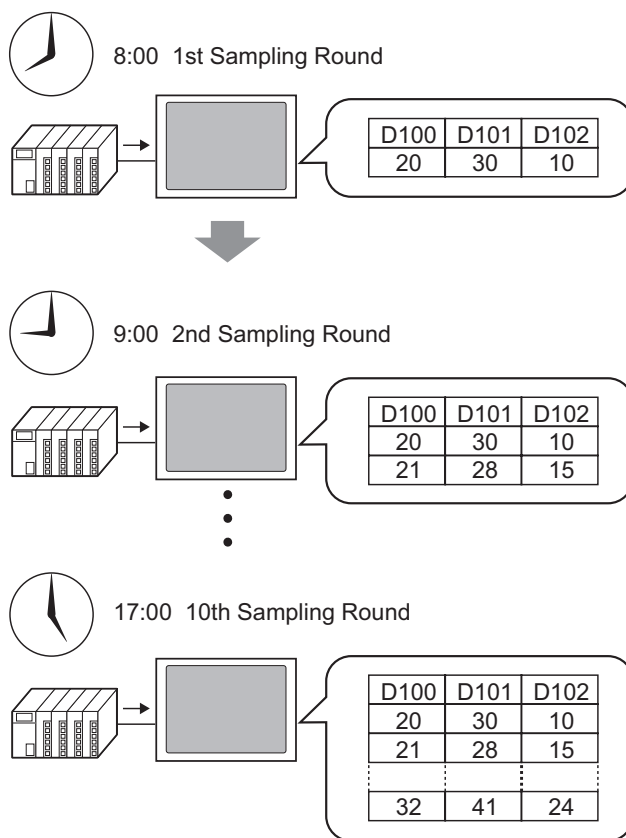



Sample data from the designated No. of Times, and set whether to automatically overwrite the oldest data and store the new data the next time the Start Time begins, or to stop sampling.

### 24.3.2 Setup Procedure

**NOTE** • Please refer to the settings guide for details.  
 ☞ “24.8.1 Sampling Settings Guide” (page 24-37)

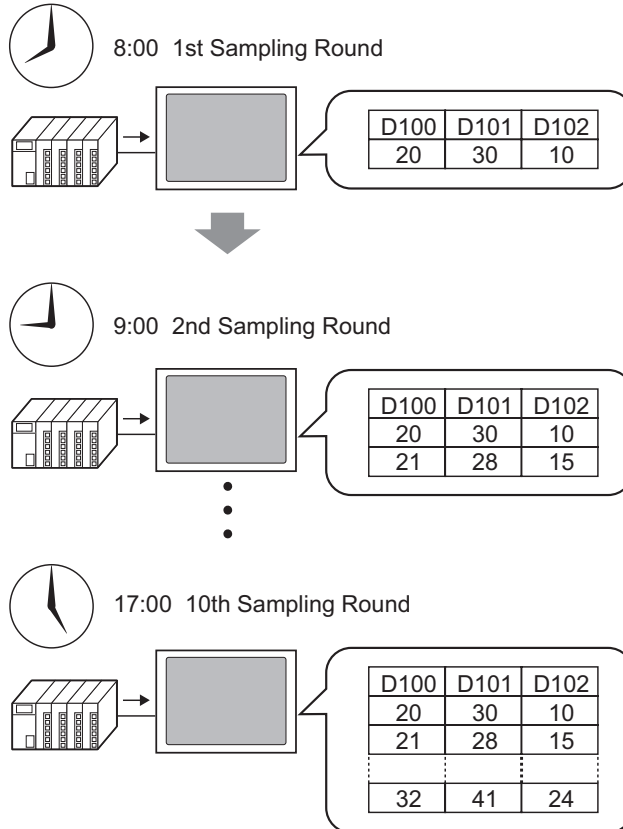
Configure settings to sample the data from D100, D101, and D102 once every hour starting at 8 a.m. for ten cycles.



1 Select the [Common Settings (R)] menu - [Sampling Settings (D)] command or click , and the following screen will be displayed.

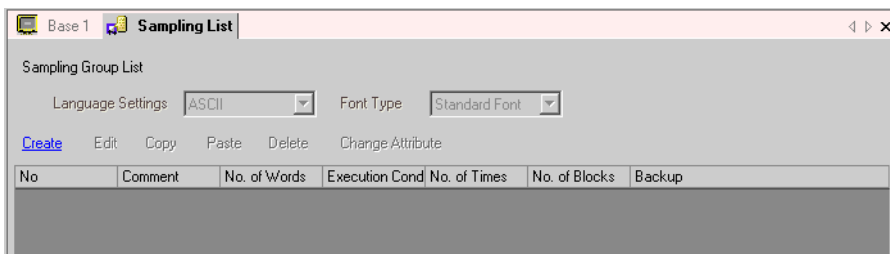

2 Click [Create] and the following dialog box will be displayed. Set the sampling group's number, click [OK], and the sampling group's settings screen appears

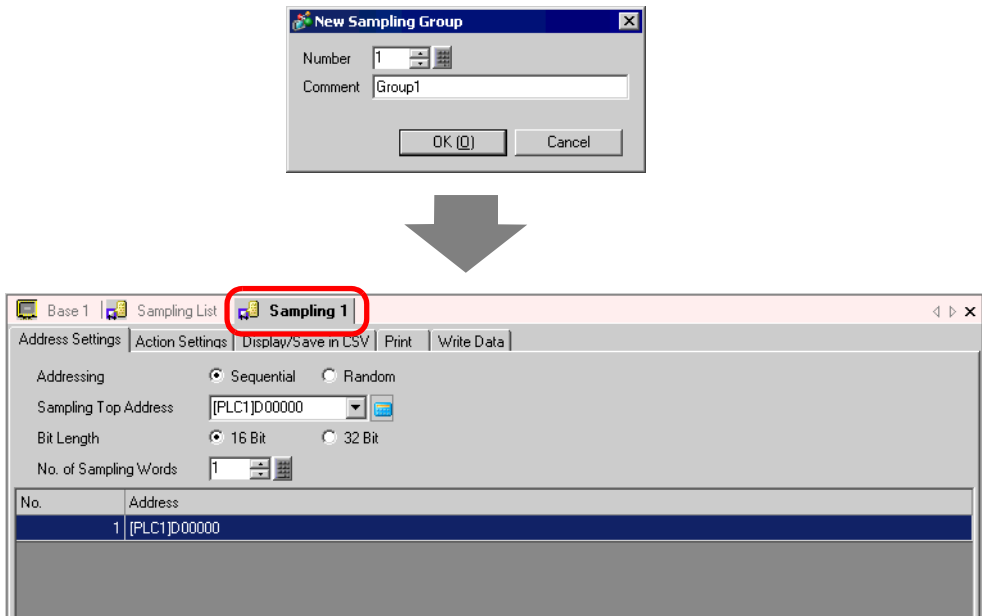

3 In [Sampling Address], set the start address (D100) for data you want to sample.

Click on the icon and an address input keypad is displayed.

Select device "D", input "100" as the address, and press the "Ent" key.

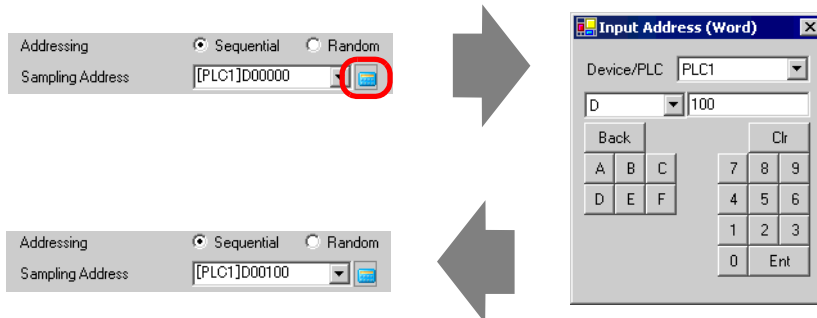

4 Designate the bit length to store for sampled data, and in [No. of Sampling Words], set the number of addresses (e.g.: 3). The sequential three words are displayed, starting from the designated address.

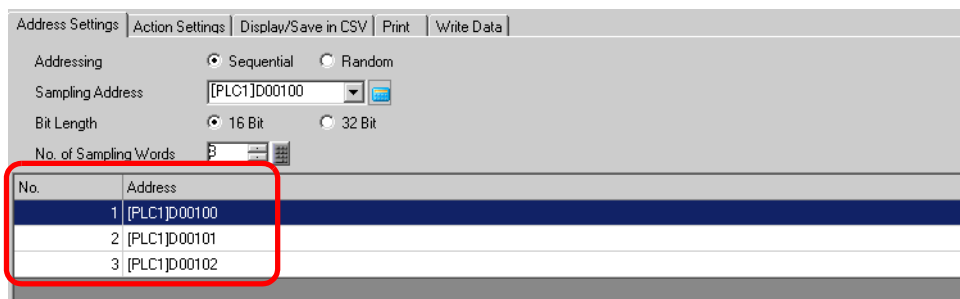

5 Open the [Action Settings] tab, and select [Execution Condition] as [Time Specification].

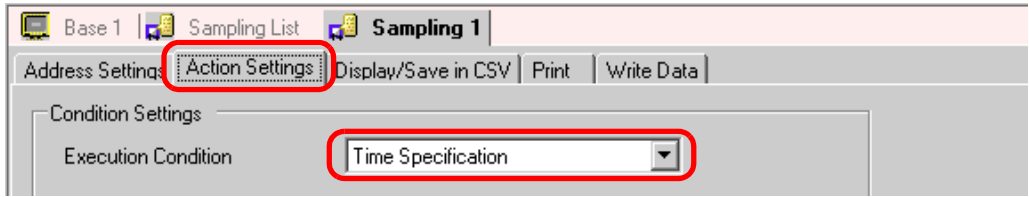

6 In [Sampling Permit Bit Address], set the bit address (e.g.: M100) to control the data sampling operation.

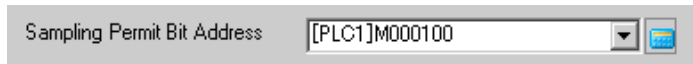

**NOTE**

- Please ensure that this bit is turned ON before the Start Time. Sampling will not begin if this bit is OFF at the Start Time. Time is monitored with the Clock Data in the GP.

7 Designate the Start Time (8 a.m.) for the data sampling, and set the cycle and No. of Times (each hour for 10 cycles).

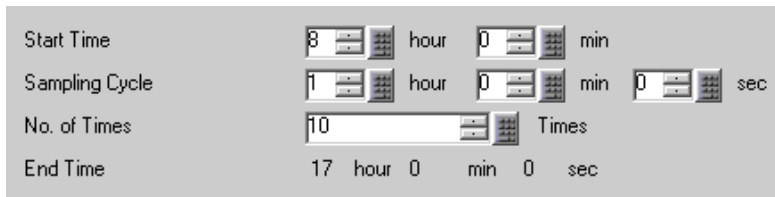

8 Set the address (e.g.: M50) to erase sampled data. When this bit turns ON, all the Sampling data of Group 1 stored in the GP's backup SRAM will be erased.

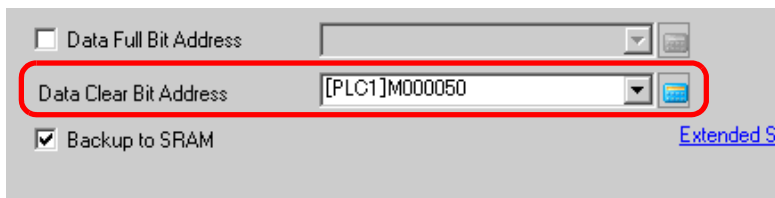

9 Click [Extended Settings] and the following dialog box will open. As needed, set the number of days' sampling data that will be maintained in the GP.

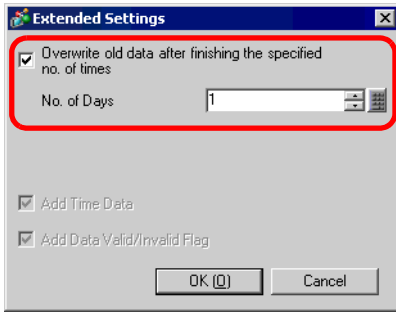

For the picture to the left, one day's data will be maintained in the GP. On the following day at the Start Time (8 a.m.), the previous day's sampling data will be overwritten in order and new data stored. If you do not want data to be overwritten, clear the [Overwrite old data after finishing the specified no. of times] check box. On the following day at the Start Time, sampling will not occur.

If you clear the [Overwrite old data after finishing the specified no. of times] check box, you can adjust the [No. of Blocks] setting. A "block" is the sampling data collected from the designated No. of Times. When displaying or printing data, you can use block units.

e.g.) When sampling for five hours from Monday to Friday and displaying/printing that data everyday.

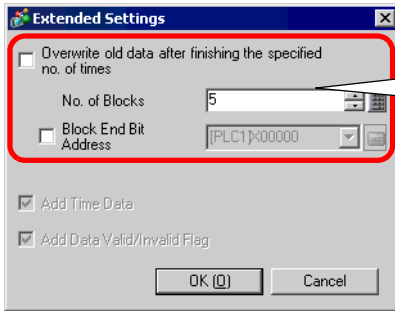

The sampled data for the designated No. of Times is 1 block. Specify how many blocks.

For the picture to the left, five days' sampling data will be maintained in the GP. On the 6th day and later, sampling will not occur. To resume sampling, clear the sampling data stored in the GP.

- NOTE**
- For information about the timing of the Sampling action, please refer to the following.
    - ☞ "24.9.2 The Sampling Action ◆ Time Specification" (page 24-102)
  - With [Backup to SRAM] unchecked, the sampling data stored in the GP will be erased when turning OFF or resetting the GP.

## 24.4 Sampling Data at Specific Periods

### 24.4.1 Details

Each time the designated bit address turns ON, the specified address value is read from the device/PLC and that data is saved in the GP.

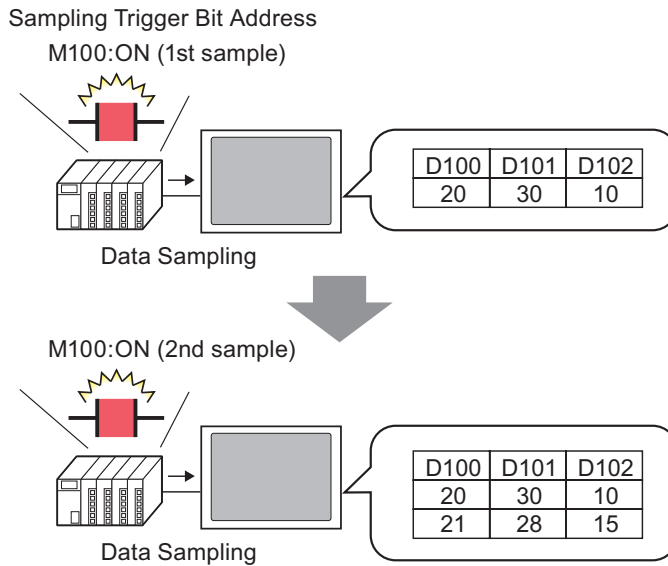

Sample data from the designated No. of Times, and set whether to automatically overwrite the oldest data and store the new data the next time the designated bit turns ON, or to stop sampling.

## 24.4.2 Setup Procedure

**NOTE** • Please refer to the settings guide for details.  
 ☞ “24.8.1 Sampling Settings Guide” (page 24-37)

Configure settings to sample data from D100, D101, and D102 every time the bit (M100) turns ON.

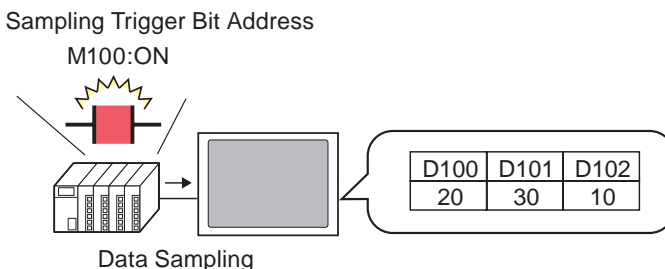

1 Select the [Common Settings (R)] menu - [Sampling Settings (D)] command or click , and the following screen will be displayed.

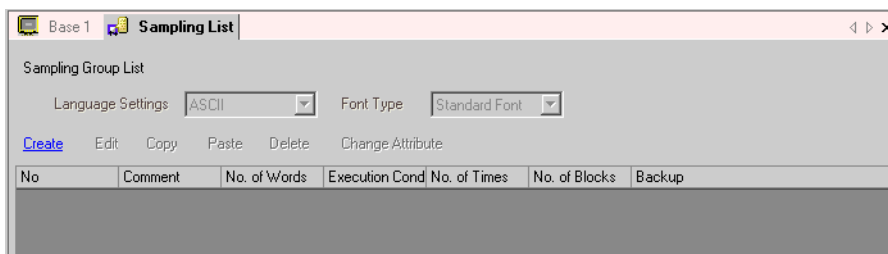

2 Click [Create] and the following dialog box will be displayed. Set the sampling group's number, click [OK], and the sampling group's settings screen appears.

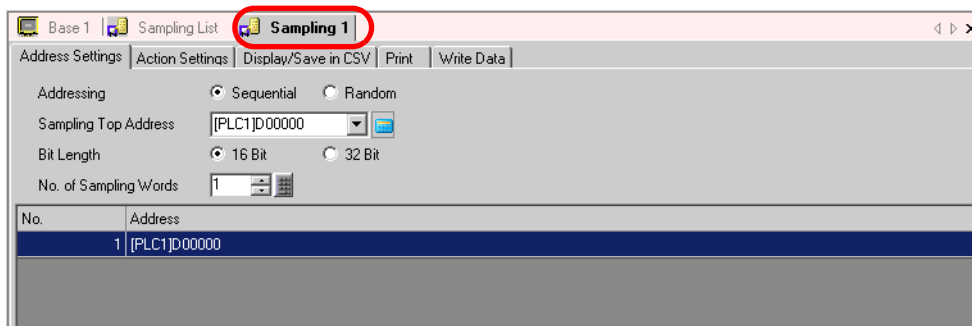
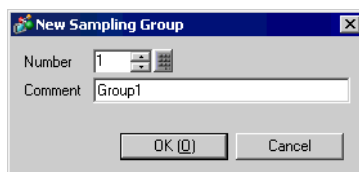

3 In [Sampling Address], set the start address (D100) for data you want to sample.

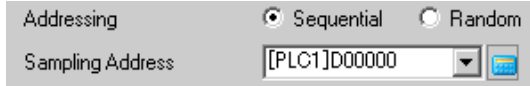

4 Designate the bit length to store for sampled data, and in [No. of Sampling Words], set the number of addresses (e.g.: 3). The sequential three words are displayed, starting from the designated address.

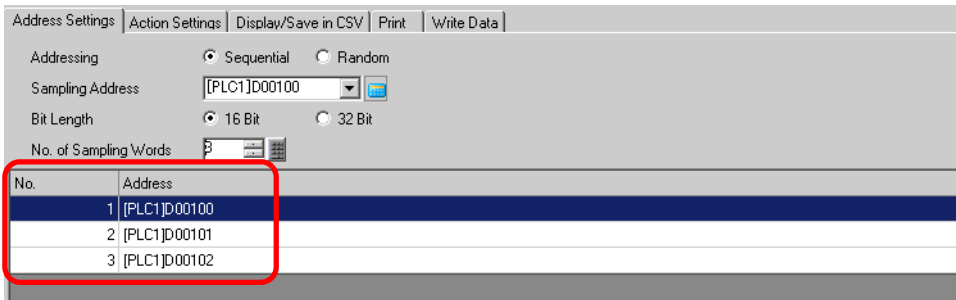

5 Open the [Action Settings] tab, and select [Execution Condition] as [Bit ON].

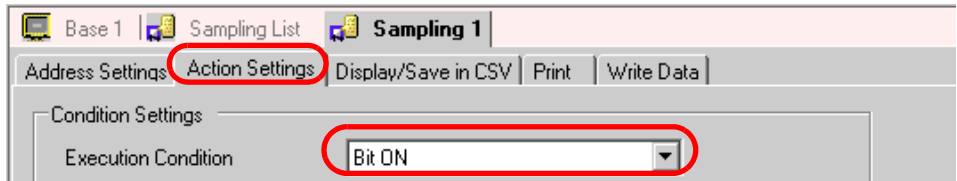

6 In [Sampling Trigger Bit Address], set the bit address (e.g.: M100) to control the data sampling operation. The data sampling will execute every time this bit turns ON.

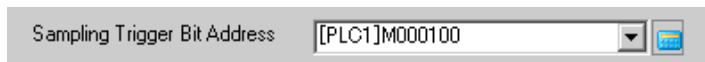

7 Designate the number of times to sample the data (e.g.: 4 times).

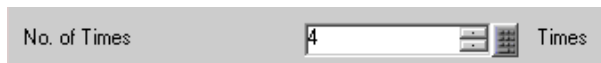

8 Set the address (e.g.: M50) to erase sampled data. When this bit turns ON, all the Sampling data of Group 1 stored in the GP will be erased.

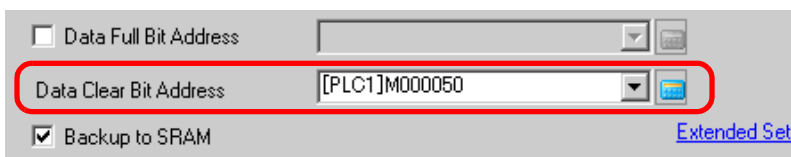

9 Click [Extended Settings] and the following dialog box will open.

Designate the [ACK Bit Address] (e.g.: M20) which will confirm when the data reading is finished. When the data reading is finished, this bit will automatically be turned ON. Accept this Bit ON and turn OFF the [Sampling Trigger Bit Address] (M100).  
(When M100 turns OFF, M20 will automatically turn OFF.)

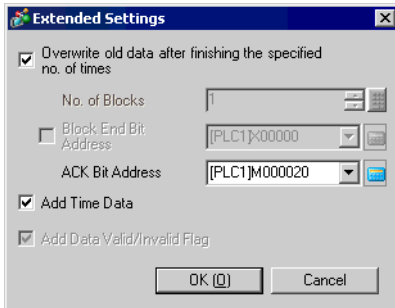

In the picture to the left, when data for the designated number of times (e.g.: 4) is stored to the GP and the trigger bit (M100) turns ON for the 5th time, data will be overwritten and stored starting from the 1st time's data. If you do not want data to be overwritten, clear the [Overwrite old data after finishing the specified no. of times] check box. When the designated bit turns ON for the 5th time, sampling will not occur.

If you clear the [Overwrite old data after finishing the specified no. of times] check box, you can adjust the [No. of Blocks] setting. A “block” is the sampling data collected from the designated No. of Times. When displaying or printing data, you can use block units.  
e.g.) When sampling for five hours from Monday to Friday and displaying/printing that data everyday.

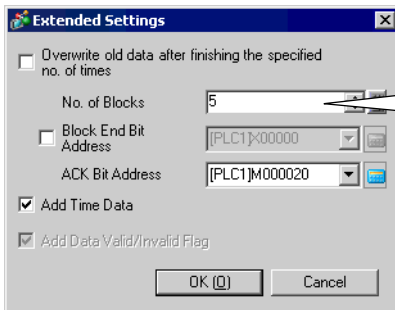

The sampled data for the designated No. of Times is 1 block. Specify how many blocks.

**NOTE**

- For information about the timing of the Sampling action, please refer to the following.  
 ☞ “24.9.2 The Sampling Action ◆ Bit ON” (page 24-105)
- With [Backup to SRAM] unchecked, the sampling data stored in the GP will be erased when turning OFF or resetting the GP.

## 24.5 Displaying Sampled Data

### 24.5.1 Details

Displays data collected with the Sampling feature (Sampling data) on the GP screen in a table format.

Data is displayed on the screen every time sampling occurs. This feature is useful for checking for changes of each address value.

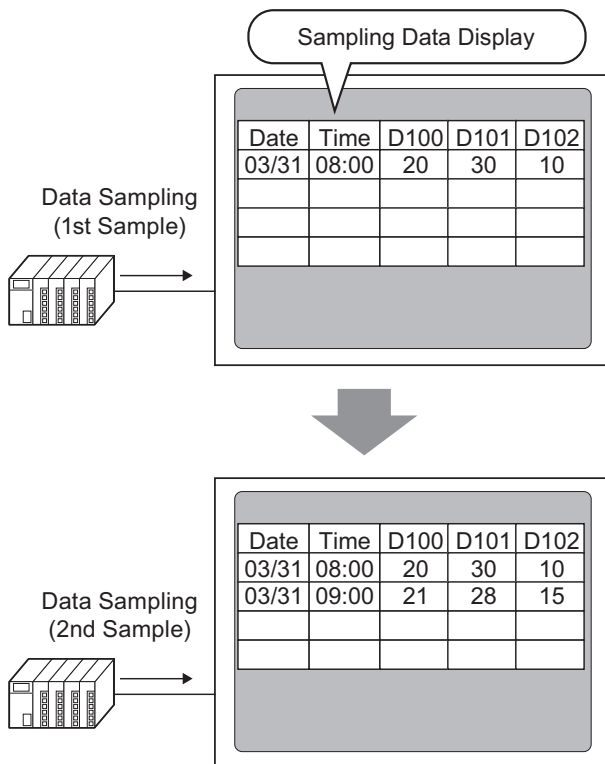

**NOTE**

- You can also edit sampling data on the screen by touching it.
- Sampling data can also be displayed in a Line Chart.  
 ☞ “17.4 Displaying with a Line Chart” (page 17-11)

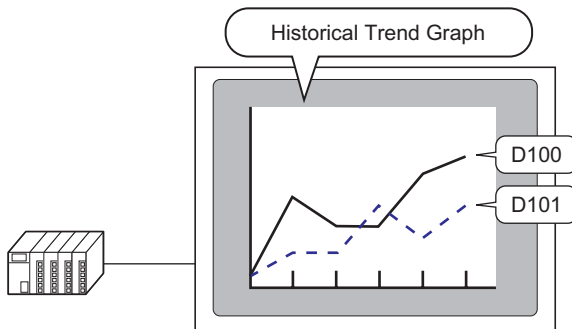



## 24.5.2 Setup Procedure

**NOTE**

- Please refer to the settings guide for details.
  - ☞ “24.8.1 Sampling Settings Guide ■ Display/Save in CSV” (page 24-51)
  - ☞ “24.8.2 Sampling Data Display Settings Guide” (page 24-91)
- For details about placing parts or setting addresses, shapes, colors, and labels, please refer to the “Part Editing Procedure”.
  - ☞ “9.6.1 Procedure for Editing a Part” (page 9-36)

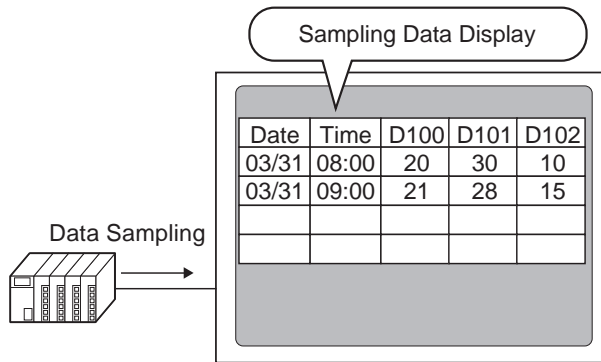
Configure settings to display Sampling Group No. “1” on the GP screen.



1 Select the [Common Settings (R)] menu - [Sampling Settings (D)] command or click , and a list of registered sampling groups will be displayed. Double-click the No.1’s row and Sampling Group 1’s setting screen opens.

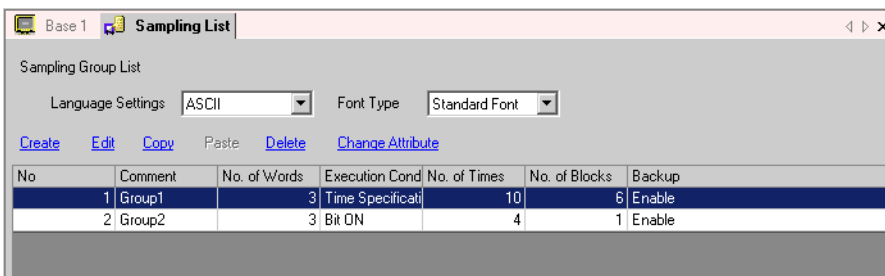

(For information about Address Settings/Action Settings, please refer to “24.3.2 Setup Procedure” (page 24-6) .)

2 Open the [Display/Save in CSV] tab. Put a check mark next to the [Display/Save in CSV] box.

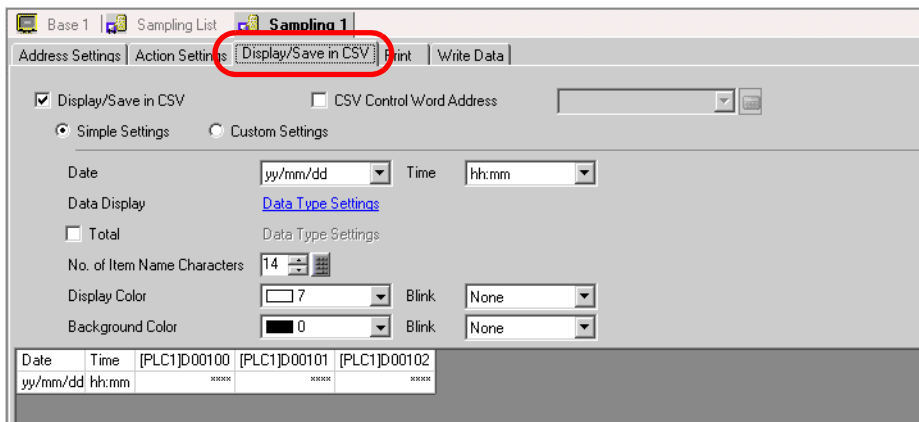

3 Select the display format for the date and time.

4 Click [Data Type Settings] to open the [Data Settings] dialog box. Set the data type, input range, number of display digits, etc. The settings are applied to all the data columns.

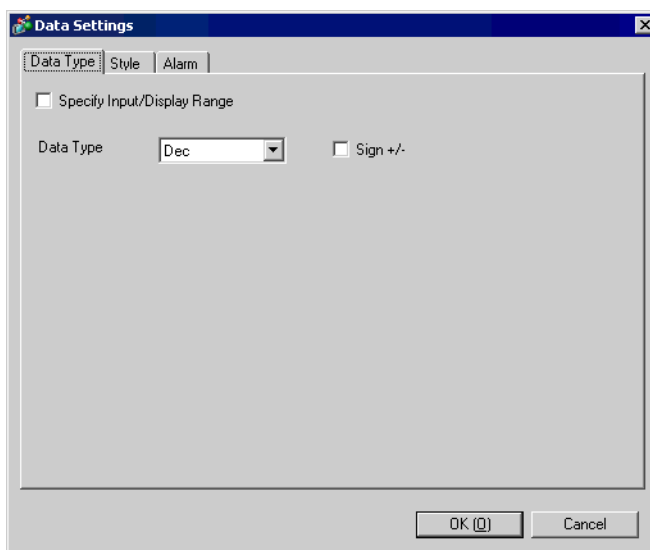
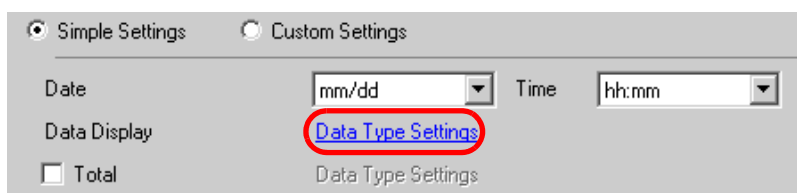

Click [OK] and the dialog box closes.

5 Select a color and background color for the displayed text.

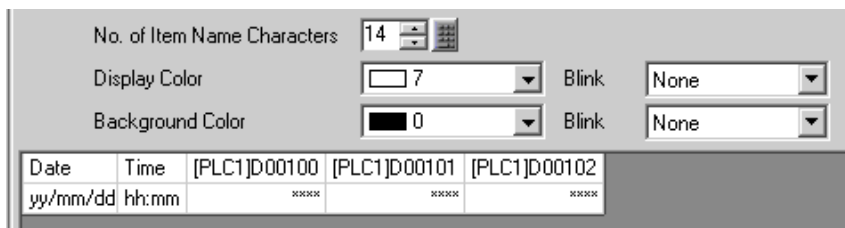

The display format settings are complete.

6 Open the editing screen, select the [Part (P)] menu - [Sampling Data Display (S)] command, or click , and place the Part on the screen.



7 Double-click the placed Sampling Data Display and the settings dialog box opens.

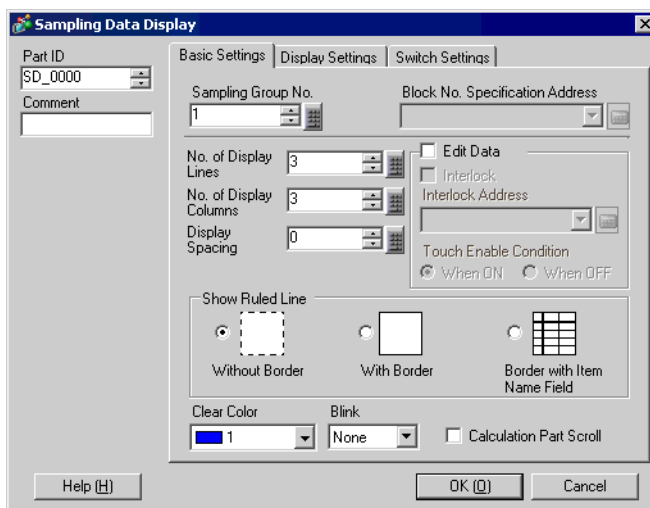

8 Designate the Sampling Group No. “1”, to display on the screen.



**NOTE** • When displaying a sampling group that does not have [Overwrite old data after finishing the specified no. of times] set in [Sampling Settings] - [Action Settings] tab - Extended Settings, you must set a [Block No. Specification Address].

9 Set the [No. of Display Lines] and [No. of Display Columns].

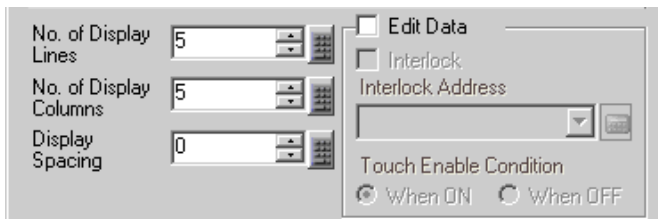

10 Select whether or not to show Ruled Line/Border and select the [Clear Color].

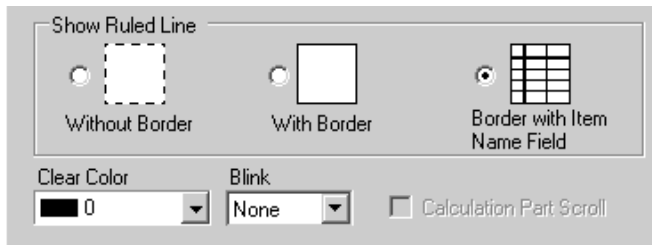

11 Select the [Display Settings] tab, and set the data’s font type and size.

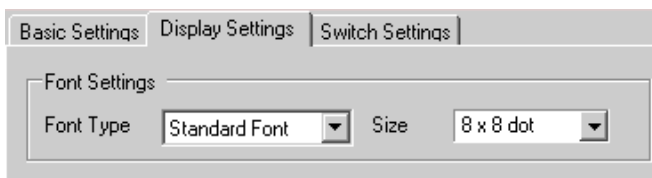

- 12 Select the [Switch Settings] tab, and select the necessary scroll switches. With [Select Shape], select the switches' shapes, set the label and text color as needed, and click [OK].

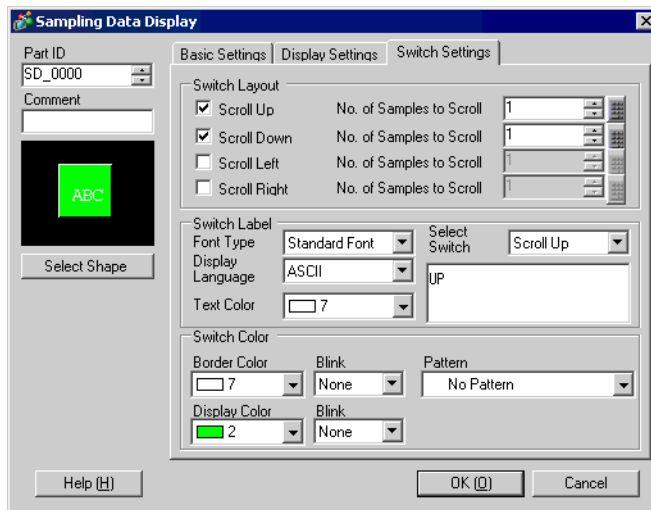

The Sampling Data Display is now set. You can move the switches independently to the desired location.

**NOTE**

- For the attached [Sampling Data Display] switches, you cannot set the shape or color independently. To set a different shape or color for each switch, use the Switch Lamp Part [Special Switch] - [Sampling Data Display Switch].

## 24.6 Saving Sampled Data to a CF-Card (Save in CSV)

### 24.6.1 Details

Data collected with the Sampling feature (Sampling data) can be saved to the CF-card in CSV format.

Sampling data saved in the CF-card (SA\*\*\*\*\*.csv) can be opened in spreadsheet software (Microsoft Excel) and used as a database.

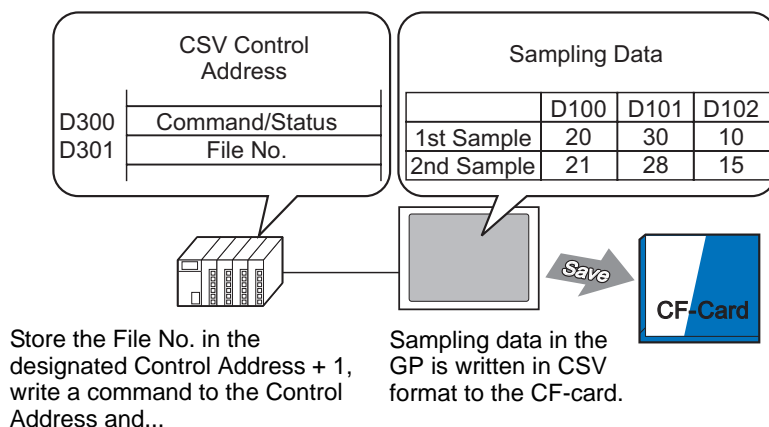

- NOTE**
- Sampling data (SA\*\*\*\*\*.csv) in the CF-card can be displayed on the GP using a Special Data Display [File Manager] and Special Data Display [Show CSV].  
 ☞ "25.6 Displaying/Editing CSV Data on the Screen" (page 25-30)

## 24.6.2 Setup Procedure

**NOTE**

- Please refer to the settings guide for details.  
 ➔ “24.8.1 Sampling Settings Guide ■ Display/Save in CSV” (page 24-51)

Configure settings to save data from Sampling Group No. “1” to the CF-card.

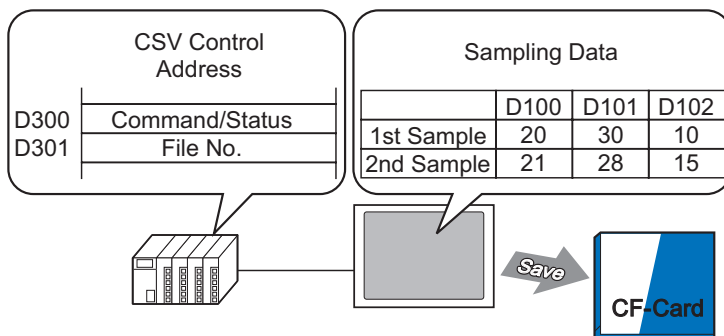

- 1 Select the [Common Settings (R)] menu - [Sampling Settings (D)] command or click , and a list of registered sampling groups will be displayed. Double-click the No.1's row and Sampling Group 1's setting screen opens.

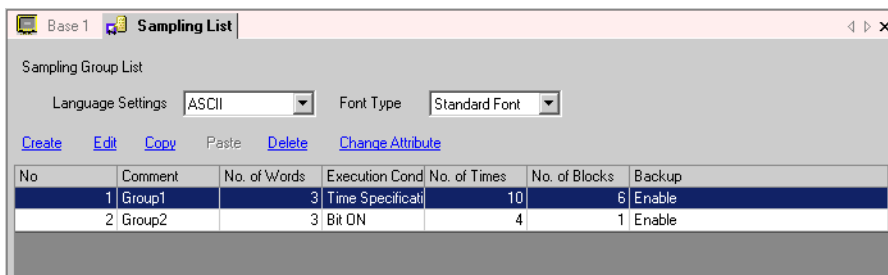

(For information about Address Settings/Action Settings, please refer to “24.3.2 Setup Procedure” (page 24-6) )

- 2 Open the [Display/Save in CSV] tab. Put a check mark next to the [Display/Save in CSV] box.

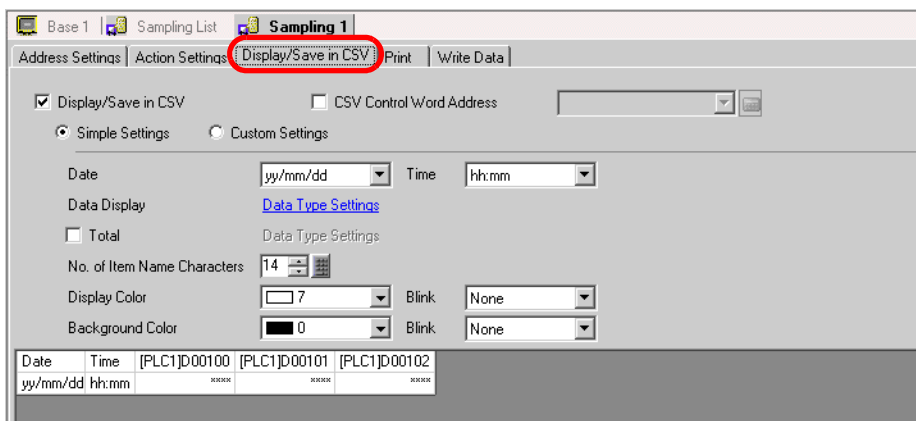

- 3 Put a check mark next to the [CSV Control Word Address] box, and set the word address (e.g.: D300) to control the CF-card data storage. Two consecutive words will automatically be used, starting from the designated address.



- 4 Click [Data Type Settings] to open the [Data Settings] dialog box. Set the data type, number of display digits, etc, as needed. The settings are applied to all the data columns.

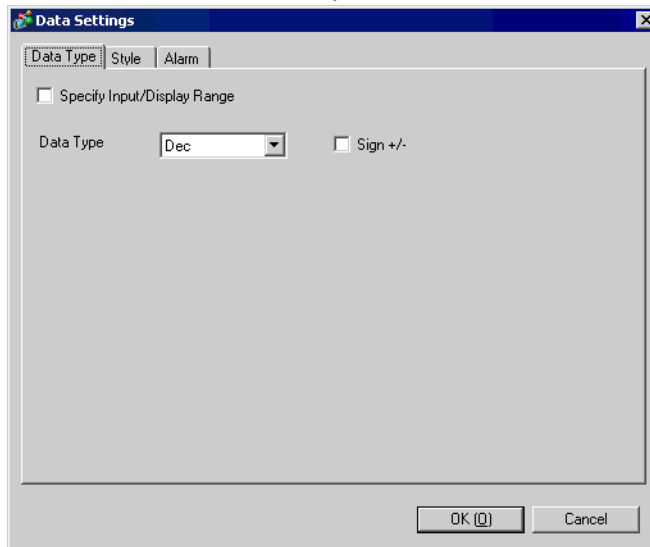
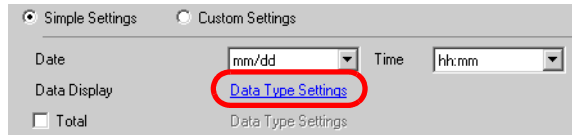

Click [OK] and the dialog box closes.

- 5 Set the [No. of Item Name Characters].

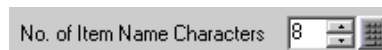

The CSV format is now complete.

- 
- NOTE**
- Regardless of the [Date] and [Time] display settings, the CSV file will be outputted with the [yy:mm:dd] and [hh:mm:ss] format ([hh:mm:ss.ms] when the sampling cycle unit is [ms]).
  - Regardless of whether a [Total] row is designated or not, calculation data will not be exported with the CSV file.
-

### 24.6.3 CF-Card Save Action

Data can be saved to the CF-card using the following two methods.

- Normal Save  
At the time that the command is read into the [CSV Control Word Address], data stored in the GP is outputted as a CSV file.  
☞ “◆ Process for Normal Save” (page 24-24)
- Auto Save  
After data for the sampling block is stored in the GP, data is automatically output as a CSV file. This can only be set for a sampling group with [Overwrite old data after finishing the specified no. of times] set on the [Action Settings] tab’s Extended Settings.  
☞ “◆ Process for Auto Save” (page 24-25)

#### ■ CSV Control Word Address

This address controls the writing of data to the CF-card. After designating a file number, write a command to the address.



- Command/Status  
Designate the file number, write the command, and data is written to the CF-card. The operation result (status) is reflected in the address.

Mode	Word Data	Description
Command	0001h	Normal Save
	0020h	Start Auto Save (Only when the data is stored by overwriting *1)
	0021h	End Auto Save (Only when the data is stored by overwriting *1)
Status	0000h	Completed Successfully
	0100h	Write Error
	0200h	Multi Unit not installed/CF-Card not inserted (CF-Card access switch OFF)
	0300h	No data to be loaded (when no data is specified)
	0400h	File No. Error
	2000h	The GP is in the normal Auto Save mode. While the [CSV Save Control Address] is this value, the Auto Save action is continued. When the value is changed, the auto-save mode finishes.

\*1 For information about data storage methods, please refer to “24.9.2 The Sampling Action ■ Data Storage Methods” (page 24-108)

**NOTE**

- When the status “2000h”’s value changes or when a file number changes during saving, the auto save operation ends and the data saved at the time is written to the CF-card. However, the value (command) written in this mode will not be processed.

- File No.

When saving to the CF-card, for the file name “SA\*\*\*\*\*.csv”, designate the \*\*\*\*\* portion. The file number can be from 0 to 65,535. Please set the file number before writing the command.

CSV files are saved into a folder automatically created in the CF-card. The created folder name is fixed for each sampling group.

Data to be saved	Folder	File Name
Sampling Group 1's data	\SAMP01	SA*****.CSV
⋮	⋮	
Sampling Group 64's data	\SAMP64	SA*****.CSV

### ◆ Process for Normal Save

Save data from Sampling Group No. “1” as file name “SA00001.csv” in the CF-card.

D300	Command/Status	←Store command "0001h"
D301	File No.	←Store "1"

- 1 In D301, store the File No. “1”.
- 2 Write the command “0001h” to D300. The CSV output will begin.
- 3 When the data is saved normally to the CF-card, the status “0000h” is written from the GP to D300. “SA00001.csv” is created in the CF-card’s “SAMP01” folder.

#### <File Save Image>

e.g.) [Overwrite old data after finishing the specified no. of times] is set, Sampling No. of Times = 4

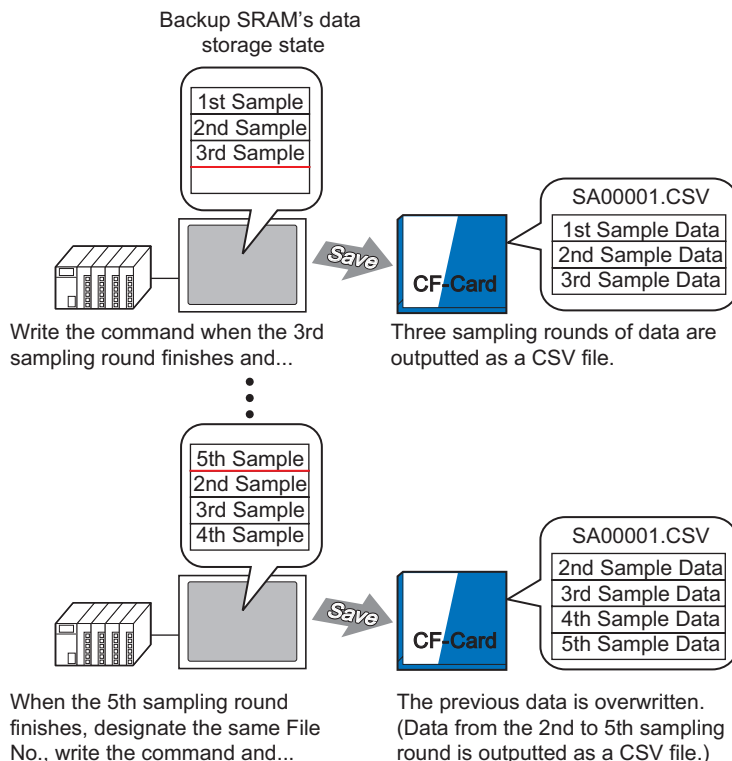

◆ **Process for Auto Save**

Save data from Sampling Group No. “1” as file name “SA00000.csv” in the CF-card.

D300	Command/Status	← Store command “0020h”
D301	File No.	← Store “0”

- 1 In D301, store the File No. “0”.
- 2 Write the command “0020h” to D300. If the GP enters the auto-save mode normally, the status “2000h” will be written from the GP to D300.
- 3 When data is sampled for the designated No. of Times, the CSV data is automatically exported to the CF-card.  
“SA00000.csv” is created in the CF-card’s “SAMP01” folder.
- 4 When data is sampled for the designated No. of Times again, that period’s CSV data is automatically exported and added (written) to the existing “SA00000.csv” file in the “SAMP01” folder.  
While D300 is “2000h”, the auto save mode will continue.
- 5 Write the command “0021h” to D300, and the auto save mode ends. When the GP ends auto save mode normally, 0000h is written to D300.

<File Save Image>

e.g.) Sampling No. of Times = 4

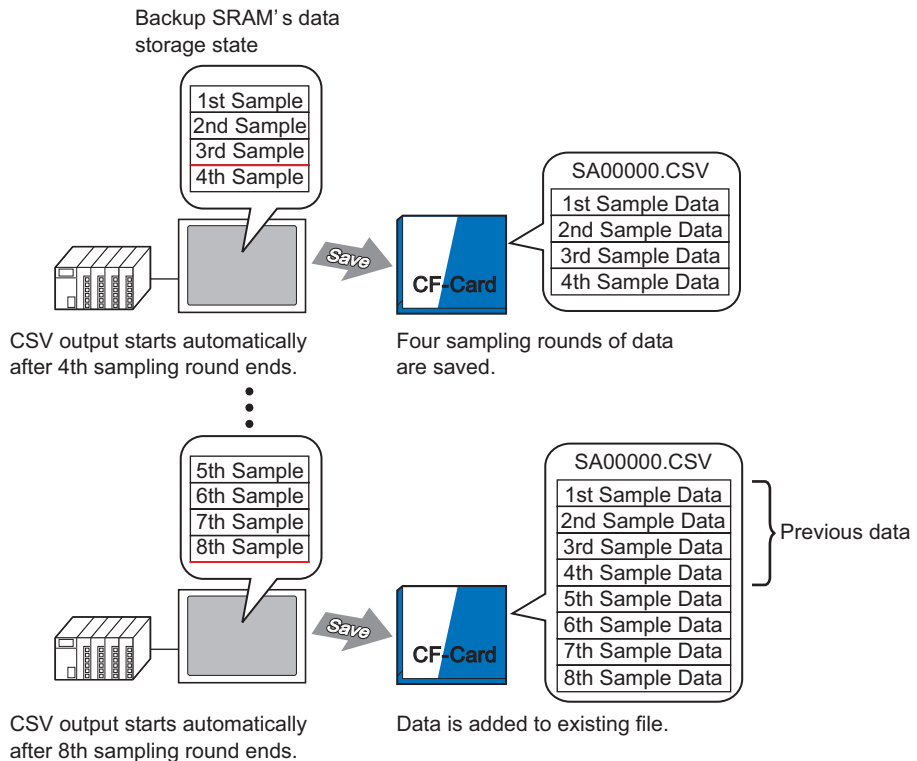

When auto save mode ends, even if there are contents still on the way to the GP (when the current sampling cycle has not completed), sampling data from up to that point will be written to the CF-card.

Also, when starting or resuming auto save (a Start Auto Save command is written), sampling data in the GP is written to the CF-Card from the start data (the oldest data), regardless of the previous data save status.

- NOTE**
- When resuming auto save while contents are on the way to the GP, that cycle will finish sampling before the data is collected and written to the CF-card. After the Auto Save start command is written, overwritten data will not be saved until it is written to the CF-card.

## <Auto Save Exiting and Resuming - File Save Image>

e.g.) Sampling No. of Times = 4

### Auto Save Exit

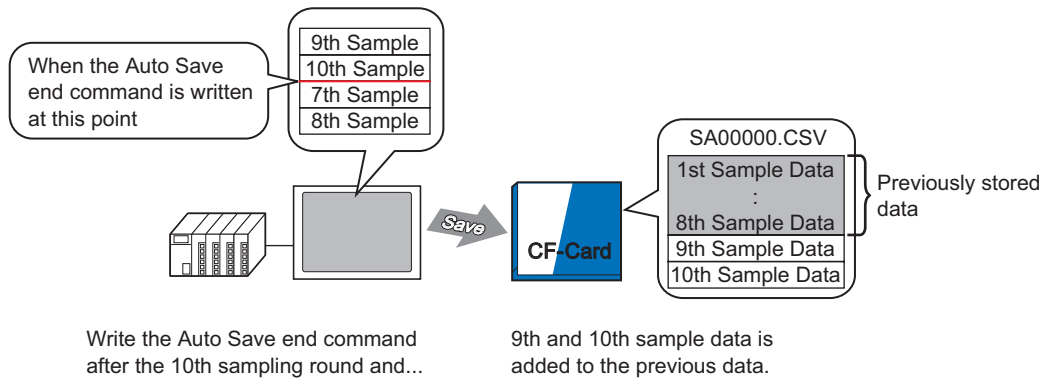

### Auto Save Resume

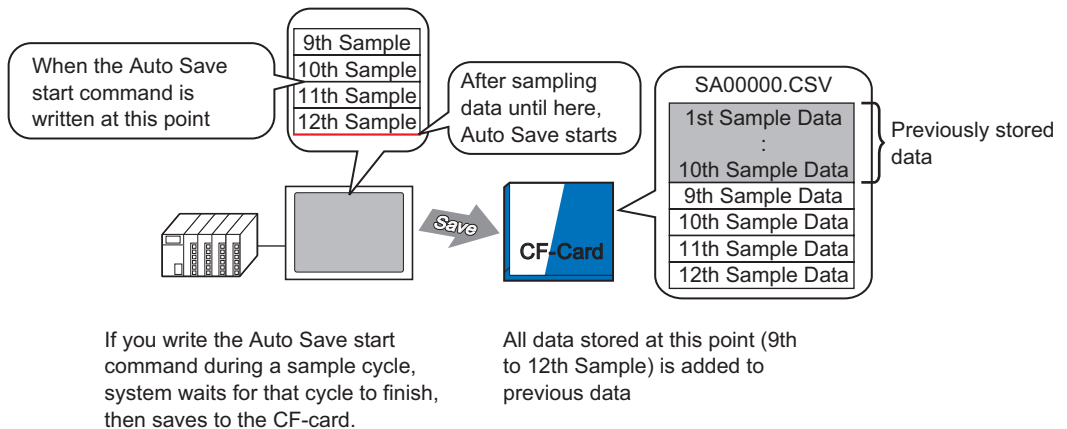

### ■ Notes on CF-Card Saving

- While data is being written to the CF-card, changes of parts and screens may slow down.
- It may take several seconds to write data, depending on the amount.
- After the Status data is read out from the GP, before the next command can be written be sure to allow time equal to at least one communication cycle\*<sup>1</sup> or one Display Scan Time\*<sup>2</sup> period, whichever is longer.
- Please do not call up screens that use the CF-card when it is not installed in the GP. Otherwise, they will not function properly.
- If a write error occurs, any file that has not finished loading may remain on the CF-Card.
- When overwriting a file by transferring data to the CF-card, the CF-card must have enough free room to allow the data. If the data is larger than the available space, a write error will occur.
- When saving to the CF-card, if the target folder (\SAMP01) does not exist, a folder will be automatically created, and the data will be saved there. However, if the CF-card does not reset or the folder can not be created, a read error will occur.
- There is a limit to the frequency that data can be written to the CF-card (500 KB of data can be rewritten around 100,000 times).

### ■ CF-Card Usage Warnings

- When removing the CF-card, please verify that the access lamp is switched off. There is a chance that CF-card data can be lost or damaged.
- While accessing the CF-card, do not turn the GP unit off, reset the GP, or remove the CF-card. Create a preset verification screen for information about CF-card access. Turn off power, reset, open the CF-card cover, or remove the CF-card only after verifying that screen.
- When inserting the CF-card in the GP unit, please make sure you have the correct side up and the correct location for the CF-card connector. If installed incorrectly, damage can occur to the data or to the CF-card/GP unit.
- Please use a CF-card made by Digital Electronics Corporation. If using another company's CF-card, damage may occur to the CF-card's data.
- Please make sure to back up all CF-card data.
- Please refrain from doing the following, as it can result in damage to data and equipment:
  - Bending the CF-card
  - Dropping the CF-card
  - Spilling water on the card
  - Touching the CF-card's connectors directly
  - Disassembling or modifying the CF-card

\*1 The communication cycle time is the time it takes to request and take in data from the GP unit to the PLC. It is stored in the internal device's LS2037 as binary data. The unit is 10ms.

\*2 Display Scan Time is the time it takes to display/calculate 1 screen. It is stored in the internal device's LS2036 as binary data. The unit is milliseconds (ms).

### ■ CSV File Displayed in Excel

The following example will introduce the contents of a sampling data file (\*.csv) saved to the CF-card and opened in Excel.

**NOTE**

- If the CSV file's size is too large, Excel or other software may not be able to open it.
- Sampling data (\*.csv) is outputted partly in a fixed format, regardless of the settings on the [Display/Save in CSV] tab. For more details, please refer to the following.
  - ☞ "24.9.4 Saving to the CF-Card" (page 24-116)

### ◆ Auto Save

e.g.) When No. of Times is "4" and data sampled for 2 cycles.

#### CSV file

```
"Date", "Time", "D00100", "D00200", "D00300", "D00301"
"05/03/31", "09:00:00", "3228", "30.3", "5.3", "6.1"
"05/03/31", "12:00:00", "3236", "26.4", "26.4", "6.4"
"05/03/31", "15:00:00", "3244", "28.6", "27.6", "6.2"
"05/03/31", "18:00:00", "3202", "30.7", "28.7", "6.5"
"05/04/01", "09:00:00", "3210", "26.9", "29.9", "6.3"
"05/04/01", "12:00:00", "3219", "29.2", "24.0", "6.0"
"05/04/01", "15:00:00", "3227", "31.1", "25.1", "6.3"
"05/04/01", "18:00:00", "3235", "27.3", "26.3", "6.1"
```

1st Cycle's Data  
2nd Cycle's Data



When opened in Excel:

Date	Time	D00100	D00200	D00300	D00301
2005/3/31	9:00:00	3228	30.3	25.3	6.1
2005/3/31	12:00:00	3236	26.4	26.4	6.4
2005/3/31	15:00:00	3244	28.6	27.6	6.2
2005/3/31	18:00:00	3202	30.7	28.7	6.5
2005/4/1	9:00:00	3210	26.9	29.9	6.3
2005/4/1	12:00:00	3219	29.2	24	6
2005/4/1	15:00:00	3227	31.1	25.1	6.3
2005/4/1	18:00:00	3235	27.3	26.3	6.1

◆ **Normal Save**

(When Action Settings' [Overwrite old data after finishing the specified no. of times] is not set)

CSV file

```
"", "Date", "Time", "D00001", "D00002", "D00003", "D00004"
"No.1", "05/03/31", "09:00:00", "123.4", "123", "12.345", "1234"
"No.2", "05/03/31", "12:00:00", "***.*", "***", "**.***", "****"
"No.3", "05/03/31", "15:00:00", "234.5", "234", "23.456", "2345"
"No.4", "05/03/31", "18:00:00", "-123.4", "-123", "-12.345", "-1234"
"", "", "", "", "", "", ""
"No.1", "05/04/01", "09:00:00", "345.6", "345", "3.456", "3456"
...
```



When opened in Excel:

	Date	Time	D00001	D00002	D00003	D00004
No.1	2005/3/31	9:00:00	123.4	123	12.345	1234
No.2	2005/3/31	12:00:00	***.*	***	**.***	****
No.3	2005/3/31	15:00:00	234.5	234	23.456	2345
No.4	2005/3/31	18:00:00	-123.4	-123	-12.345	-1234
No.1	2005/4/1	9:00:00	345.6	345	3.456	3456

## 24.7 Display/Save Sampling Data in CSV with the Desired Format

### 24.7.1 Details

You can use a customized format when displaying/saving in CSV.

You can set a customized format: sort data columns, set multiple calculation rows (Total, Average, Maximum, Minimum), input desired item names, etc.

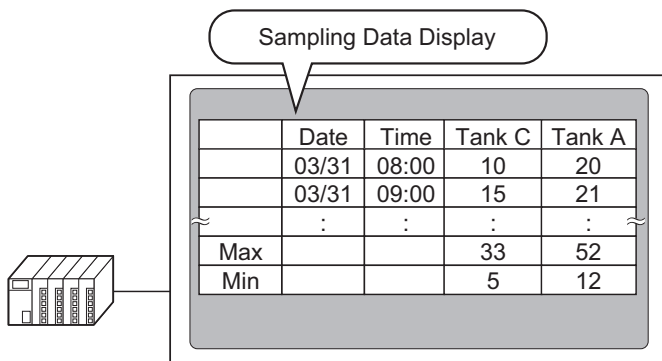

<The sampling data's display format>

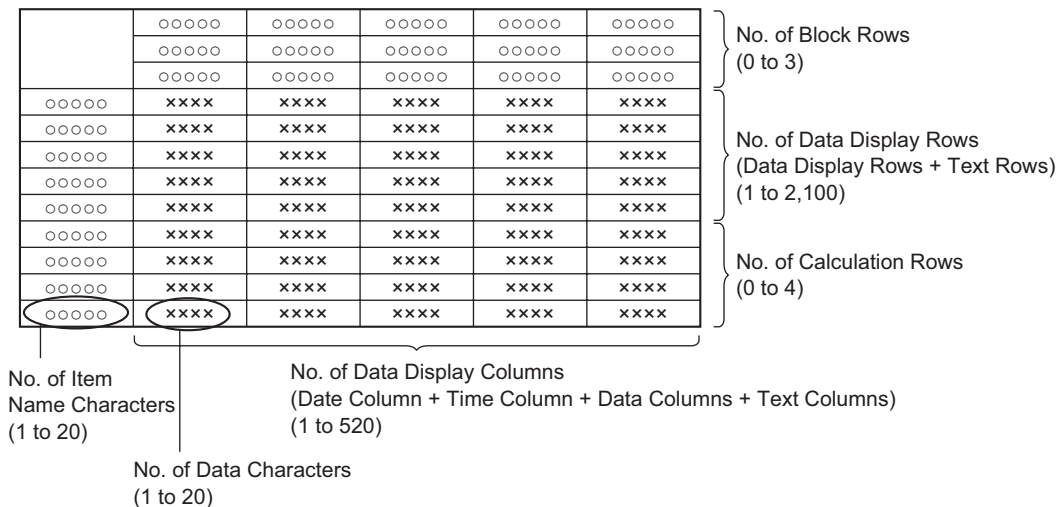

**NOTE**

- Text for the Item Name Rows and Item Name Columns can be set in the same manner as the Text Rows/Text Columns. Text can only be inputted in the language set in the [Sampling List]'s [Language Settings].
- The maximum number of columns/rows is 521/2,107.

## 24.7.2 Setup Procedure

- NOTE**
- Please refer to the settings guide for details.
    - ☞ “24.8.1 Sampling Settings Guide ■ Display/Save in CSV (Custom Settings)” (page 24-61)
    - ☞ “24.8.2 Sampling Data Display Settings Guide” (page 24-91)
  - For details about placing parts or setting addresses, shapes, colors, and labels, please refer to the “Part Editing Procedure”.
    - ☞ “9.6.1 Procedure for Editing a Part” (page 9-36)

Configure settings so that the display format for Sampling Group No. “1” is as follows.

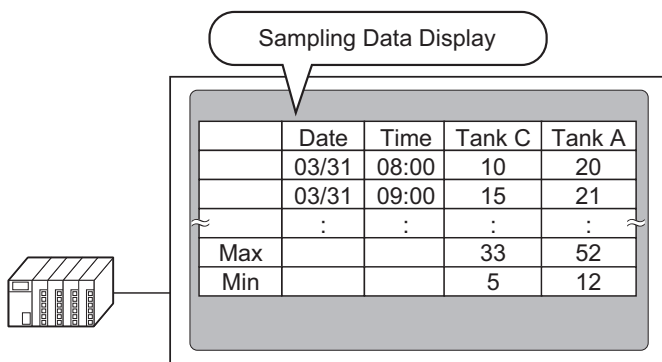

- 1 Select the [Common Settings (R)] menu - [Sampling Settings (D)] command or click , and a list of registered sampling groups will be displayed. Double-click the No.1's row and Sampling Group 1's setting screen opens.

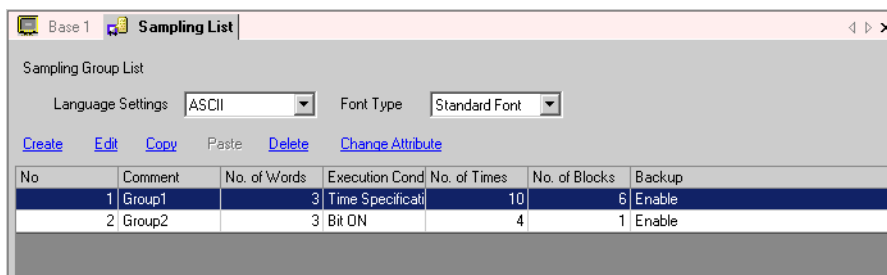

(For information about Address Settings/Action Settings, please refer to “24.3.2 Setup Procedure” (page 24-6) .)

2 Open the [Display/Save in CSV] tab.

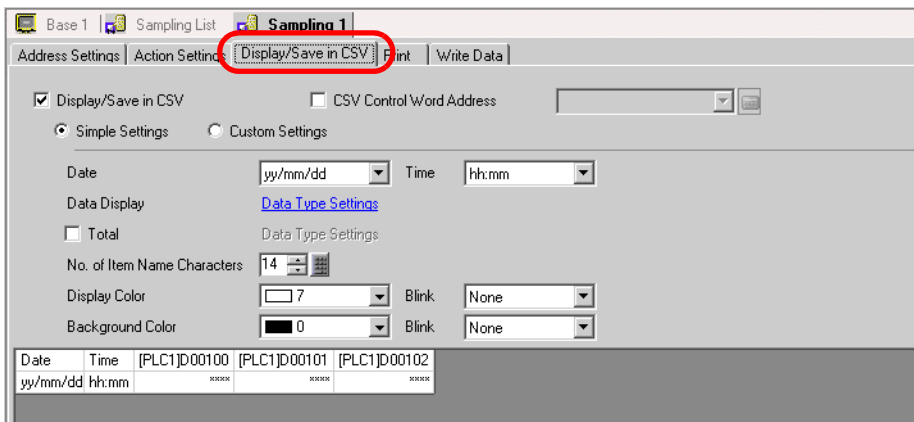

3 Put a check mark next to the [Display/Save in CSV] box, and select [Custom Settings].

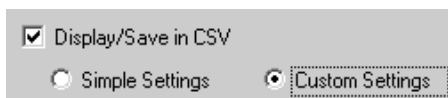

4 Set [No. of Item Name (Horizontal) Rows] to “1”, and [No. of Calculation Display Rows] to “2”.

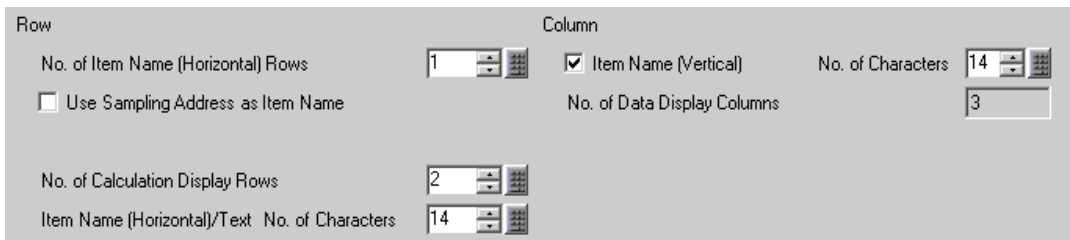

**IMPORTANT**

- When the Extended Settings [Overwrite old data after finishing the specified no. of times] is not set for the Action Settings, set the [No. of Data Display Rows]. Set the number of display rows according to the number of times.

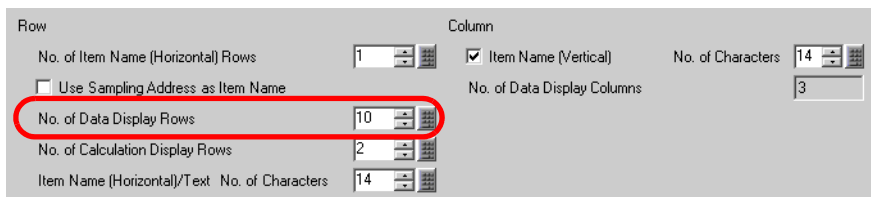

- 5 Select the Date column in the Preview area and click [Detail Settings]. The [Date Settings] dialog box will appear. Change the date form to [mm/dd].

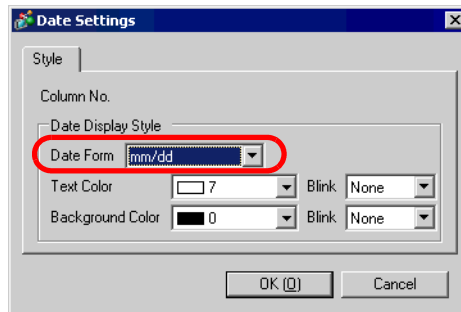
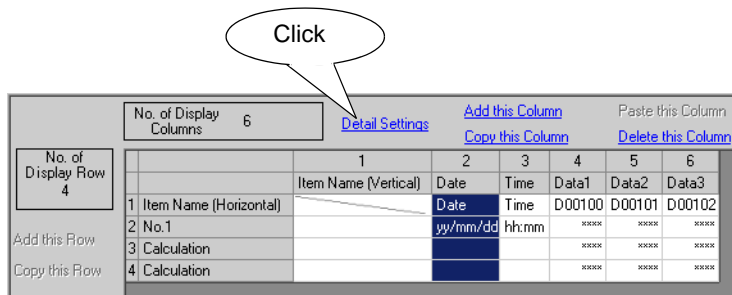

Click [OK] and the dialog box closes.

- 6 Delete the address D101's data column from the display format. Select the fifth column (Data 2) and click [Delete this Column].

- 7 Double-click each Item Name (Horizontal) cell and input the Item Name.

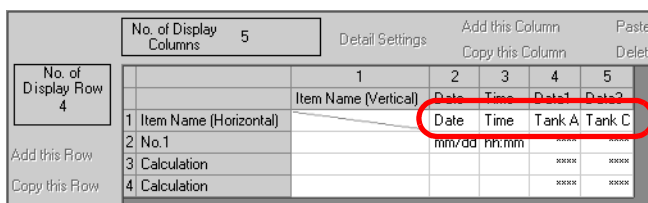

You can input text in the language designated in the Sampling List's [Language Settings].

- 8 Move the column. Right-click the fourth column (Data 1) in the selected state and select [Rightward].

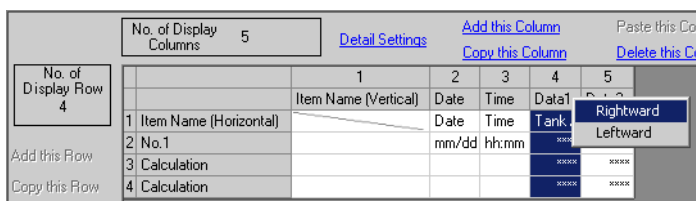

9 Select the third row and click [Detail Settings]. The [Calculation Settings] dialog box will appear. Change the [Calculation Data] to [Max].

No. of Display Row	1	2	3	4	5
1	Item Name (Vertical)	Date	Time	Data3	Data1
2	Show Data	mm/dd	hh:mm	xxxxx	xxxxx
3	Calculation			xxxxx	xxxxx
4	Calculation			xxxxx	xxxxx



**Calculation Settings**

Data Type | Style | Alarm

Row No. 3

Calculation Data: Max

Data Type: Dec  Sign +/-

As needed, set the calculation row's [Data Type], [No. of Display Digits], etc. and click [OK].

**NOTE** • If you select a data column's calculation cell and click [Detail Settings], you can set [Data Type], [No. of Display Digits], etc. independently.

10 Select the calculation data in the fourth row and set [Min] in the same way.

11 Double-click the calculation cells in the Item Name (Vertical) column and input the Item Name for each row.

No. of Display Row	1	2	3	4	5
1	Item Name (Vertical)	Date	Time	Data3	Data1
2	Show Data	mm/dd	hh:mm	xxxxx	xxxxx
3	Calculation	Max		xxxxx	xxxxx
4	Calculation	Min		xxxxx	xxxxx

The customized Display/Save in CSV format is now set.

**NOTE** • The format of CSV files saved in a CF-card is partly different from the state displayed on the setting screen. For more details, please refer to the following.  
 ☞ "24.9.4 Saving to the CF-Card ◆ Excel Display Example for Simple Settings" (page 24-117)

12 Open the editing screen, select the [Part (P)] menu - [Sampling Data Display (S)] command, or click , and place the Part on the screen.

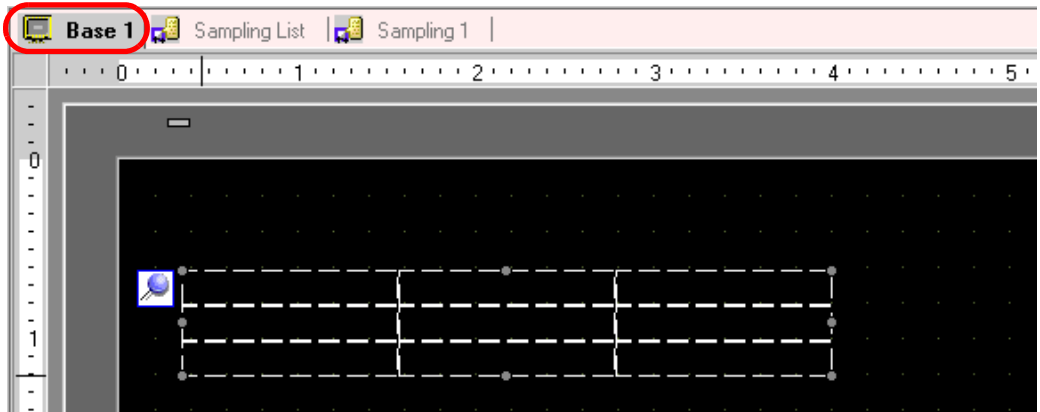

13 Double-click the placed Sampling Data Display and the settings dialog box opens.

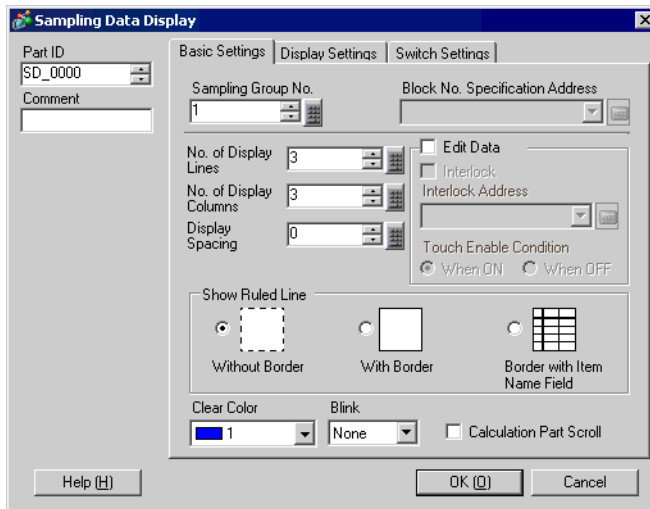

14 Designate the Sampling Group No. “1”, to display on the screen.

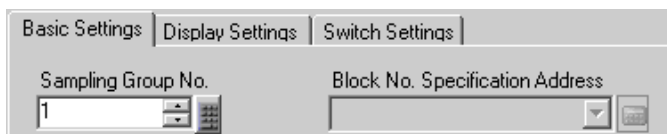

- NOTE**
- When displaying a sampling group that does not have [Overwrite old data after finishing the specified no. of times] set in [Sampling Settings] - [Action Settings] tab - Extended Settings, you must set a [Block No. Specification Address] in order to designate the blocks to display.

15 Set the [No. of Display Lines] and [No. of Display Columns].

The screenshot shows a settings dialog box with the following elements:

- Three numeric input fields on the left: "No. of Display Lines" (value: 13), "No. of Display Columns" (value: 5), and "Display Spacing" (value: 0). Each field has up/down arrow buttons and a numeric keypad icon.
- On the right, there are several options:
  - Edit Data
  - Interlock
  - Interlock Address: [text field] [button]
  - Touch Enable Condition:
    - When ON
    - When OFF

16 Select whether or not to show Ruled Line/Border and select the [Clear Color].

The screenshot shows a settings dialog box with the following elements:

- A section titled "Show Ruled Line" containing three radio button options:
  - Without Border (with a dashed border icon)
  - With Border (with a solid border icon)
  - Border with Item Name Field (with a grid icon)
- Below this, there are two dropdown menus:
  - "Clear Color" with a black square icon and the value "0".
  - "Blink" with the value "None".
- At the bottom right, there is a checkbox labeled "Calculation Part Scroll" which is currently unchecked.

17 As needed, set the font size and scroll switch layout on the [Display Settings] and [Switch Settings] tabs and click [OK].

## 24.8 Settings Guide

### 24.8.1 Sampling Settings Guide

#### ■ Sampling List

This screen is used to register new Sampling Groups. All registered Sampling Group settings are displayed in a list.

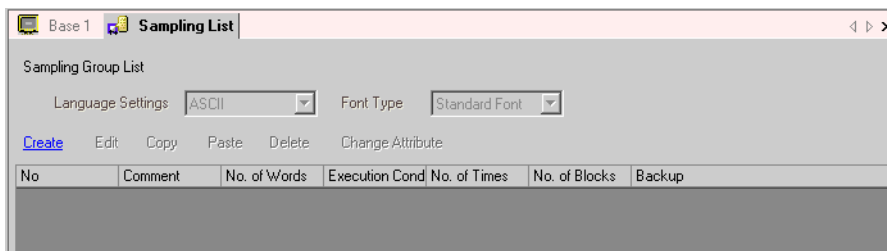

Setting	Description
Language Settings	Choose the language to use when displaying data, saving to the CF-card (CSV save), or printing from [ASCII], [Japanese], [Taiwanese], [Chinese], or [Korean]. All registered Sampling Groups will follow this setting.
Font Type	Choose a font type to use for saving to the CF-card and printing from [Standard Font] or [Stroke Font]. <ul style="list-style-type: none"> <li>• Standard Font This is a Bit Map font. Choose the magnification ratio of the characters' height and width. When you magnify/shrink characters, the outline may become rough or the letter may appear squished.</li> <li>• Stroke Font This is an outline font where the ratio of the characters' height/width is fixed. The letters will have a smooth outline even if you magnify/shrink them, however, this font has a large size so it can burden the GP.</li> </ul>
Create	Create a new Sampling Group. The following dialog box will open. <div style="text-align: center;"> </div> <p>Set the [Number] from 1 to 64 and input a [Comment] of up to 30 single-byte characters. Click [OK] and the Sampling Group's settings screen will appear.</p>
Edit	Displays the setting screen of the Sampling Group selected in [Sampling Group List].
Copy	Copy the Sampling Group selected in [Sampling Group List].
Paste	Add the copied Sampling Group into the list. This will be automatically allotted smallest unused Group No.

Continued

Setting	Description																												
Delete	Delete the Sampling Group selected in [Sampling Group List]. You can drag the mouse to select multiple sequential groups to delete.																												
Change Attribute	Change the number and comment for the group selected in [Sampling Group List].																												
Sampling Group List	<p>The registered Sampling Group settings are displayed in a list. Select and double-click a row and the Sampling Group's setting screen opens.</p> <table border="1"> <thead> <tr> <th>No</th> <th>Comment</th> <th>No. of Words</th> <th>Execution Cond</th> <th>No. of Times</th> <th>No. of Blocks</th> <th>Backup</th> </tr> </thead> <tbody> <tr> <td>1</td> <td>Group1</td> <td>3</td> <td>Time Specificati</td> <td>10</td> <td>1</td> <td>Enable</td> </tr> <tr> <td>2</td> <td>Group2</td> <td>3</td> <td>Bit ON</td> <td>4</td> <td>1</td> <td>Enable</td> </tr> <tr> <td>3</td> <td>Group3</td> <td>4</td> <td>Time Specificati</td> <td>1</td> <td>5</td> <td>Enable</td> </tr> </tbody> </table> <ul style="list-style-type: none"> <li>• <b>No.</b> Displays the Sampling Group No.</li> <li>• <b>Comment</b> Displays the Sampling Group's comment. Comments can be edited and can be up to 30 single-byte characters.</li> <li>• <b>No. of Data</b> Displays the [No. of Sampling Words] (number of data sampled at one time) set on the [Address Settings] tab.</li> <li>• <b>Execution Condition</b> Displays the [Execution Condition] set on the [Action Settings] tab.</li> <li>• <b>No. of Times</b> Displays the [No. of Times] data sampling will occur, set on the [Action Settings] tab.</li> <li>• <b>No. of Blocks</b> Displays the [No. of Blocks] set on the [Action Settings] tab's Extended Settings. If [Overwrite old data after finishing the specified no. of times] is designated, "1" will automatically be displayed. However, if [Time Specification] is selected in Action Settings, the [No. of Days] set in Extended Settings is displayed.</li> <li>• <b>Backup</b> Displays whether or not [Backup to SRAM] is set (Enable) or not set (Disable) on the [Action Settings] tab.</li> </ul>	No	Comment	No. of Words	Execution Cond	No. of Times	No. of Blocks	Backup	1	Group1	3	Time Specificati	10	1	Enable	2	Group2	3	Bit ON	4	1	Enable	3	Group3	4	Time Specificati	1	5	Enable
No	Comment	No. of Words	Execution Cond	No. of Times	No. of Blocks	Backup																							
1	Group1	3	Time Specificati	10	1	Enable																							
2	Group2	3	Bit ON	4	1	Enable																							
3	Group3	4	Time Specificati	1	5	Enable																							

## ■ Address Settings

Set the address to sample the data. Select the address' designation method from [Sequential] or [Random].

### NOTE

- When you change from [Random] to [Sequential], all set addresses and the [Display/Save in CSV] and [Print] settings are initialized.
- If [Random] is selected, communication with the device may take longer than when [Sequential] is selected.

## ◆ Sequential

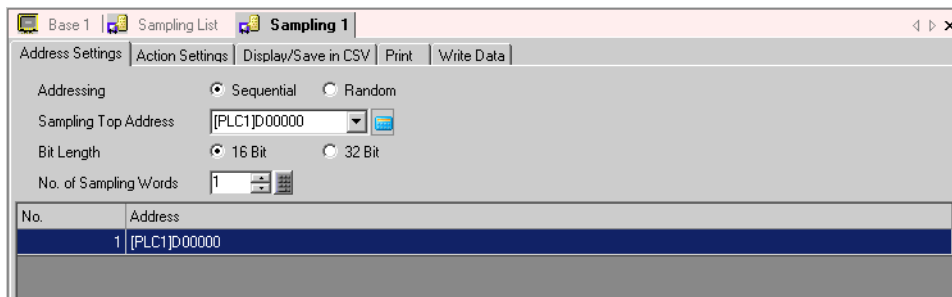

Setting	Description
Addressing	<p>Select the designation method for the addresses.</p> <ul style="list-style-type: none"> <li>• Sequential Set the sequential addresses starting from the designated [Sampling Address].</li> <li>• Random Set up to 512 addresses independently.</li> </ul>
Sampling Address	Designate the top address to sample data.
Bit Length	<p>Choose which bit length the designated address' data will be stored as, from either [16 Bit] or [32 Bit].</p> <p><b>NOTE</b></p> <ul style="list-style-type: none"> <li>• If you change this setting, contents on the [Display/Save in CSV] tab and [Print] will be reset.</li> <li>• When you change the [Bit Length] from [16 Bit] to [32 Bit], if the set [No. of Sampling Words] is above 256, all addresses above number 256 will be deleted.</li> </ul>
No. of Sampling Words	<p>Set the number of data items (number of addresses) to sample. Each [Bit Length] has a different size range.</p> <p>16 Bit: 1 to 512 32 Bit: 1 to 256</p>
Address List	The number of addresses in [No. of Sampling Words] are displayed in a list, starting from the designated [Sampling Address].

## ◆ Random

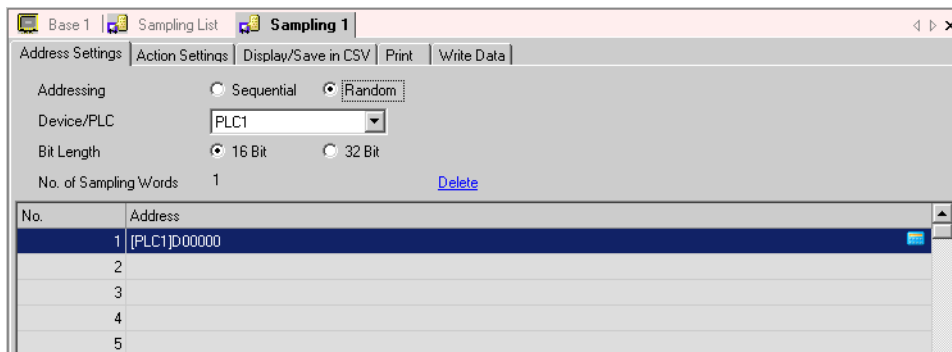

Setting	Description
Device/PLC	Designate the device/PLC where data will be sampled.
Bit Length	<p>Choose which bit length the designated address' data will be stored as, from either [16 Bit] or [32 Bit].</p> <p><b>NOTE</b></p> <ul style="list-style-type: none"> <li>• If you change this setting, contents on the [Display/Save in CSV] tab and [Print] will be reset.</li> <li>• When you change the [Bit Length] from [16 Bit] to [32 Bit], if the set [No. of Sampling Words] is above 256, all addresses above number 256 will be deleted.</li> </ul>
No. of Sampling Words	The set number of address will be displayed in [Address List].
Address List	<p>Directly set the address to sample in each row. Each [Bit Length] has a different number of display rows.</p> <p>16 Bit: 1 to 512 rows 32 Bit: 1 to 256 rows</p>
Delete	Delete the address selected in [Address List].

## ■ Action Settings

Configure settings for the timing and No. of Times of the data sampling. You can select the Sampling action's execution condition from [Time Specification], [Constant Cycle], [Constant Cycle when Bit is ON], [Bit ON], or [Bit Change].

## ◆ Time Specification

Sample data at constant cycles starting from the designated time.

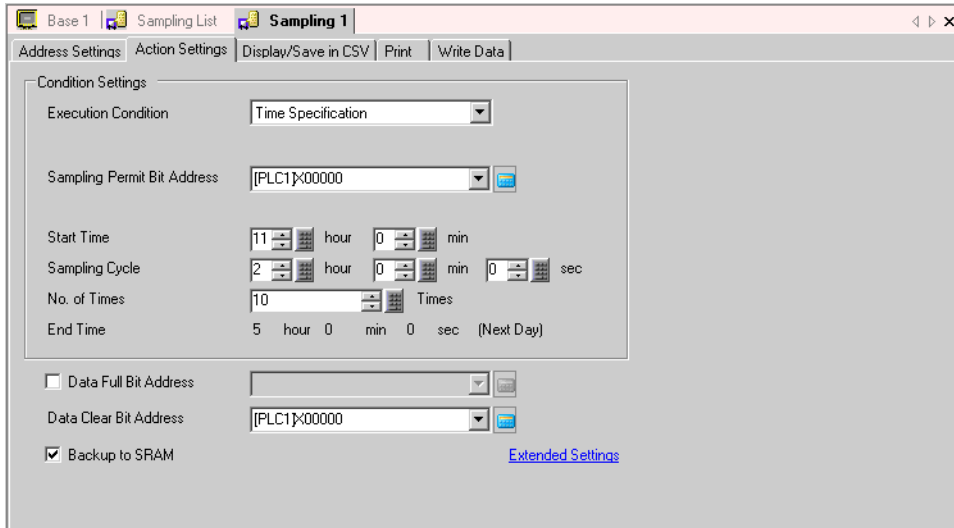

Setting	Description
Execution Condition	Select the sampling action's execution condition. Select [Time Specification].
Sampling Permit Bit Address	Select the address which will control whether or not sampling will execute. When this address is ON, sampling will begin at the designated [Start Time], and after that, read in data at each cycle of the set [Sampling Cycle]. When this address is OFF, sampling will not occur even when the [Start Time] is reached.
Start Time	Designate the sampling action's start time. Set the time from 0 to 23 (hour), and 0 to 59 (minute).
Sampling Cycle	Set the period that sampling will occur in 15-second increments from 0 sec. to 23 hours, 59 minutes, 45 sec.
No. of Times	Select the number of times sampling will occur. If [Overwrite old data after finishing the specified no. of times] is set in [Extended Settings], this can be from 1 to 65,535 times. If it is not set, the range is from 1 to 2,048 times. <b>IMPORTANT</b> <ul style="list-style-type: none"> <li>The settings range will automatically be limited to ensure that the period from [Start Time] to [End Time] is within 24 hours. As well, the number of sampling groups and number of addresses (no. of words) in the whole system will also be limited.</li> </ul>
End Time	Set the [Start Time], [Sampling Cycle], [No. of Times], and the sampling end time will be displayed.

Continued

Setting	Description
Data Full Bit Address	<p>After all the sampling is completed (after the designated [No. of Times] × [No. of Blocks], or [No. of Times] × [No. of Days]) this bit address will turn ON to confirm that the operation is finished. To confirm, set this address. When [Overwrite old data after finishing the specified no. of times] is set on [Extended Settings], this bit tells when a data sampling cycle has been done. The sampling action will continue running even when this bit is ON. If not designated, the sampling action will end when this bit turns ON. Please turn ON the [Data Clear Bit Address] to resume.</p> <p><b>NOTE</b></p> <ul style="list-style-type: none"> <li>This address will not be turned OFF automatically. If [Overwrite old data after finishing the specified no. of times] is set, please ensure that the bit is turned OFF in order to confirm the next sampling cycle.</li> </ul>
Data Clear Bit Address	Designate the bit address to control the clearing of the sampling data. When this address turns ON, all the Sampling Groups' data stored in the GP will be erased. After clearing the data, this bit will automatically turn OFF.
Backup to SRAM	<p>Select whether or not to save the sampling data to the backup SRAM. If the sampling data is not saved, the data will be deleted when the GP unit's power is turned off or reset.</p> <p>☞ "24.9.1 Summary ■ Backup SRAM" (page 24-98)</p>

<Extended Settings>

Click [Extended Settings] and the following dialog box will open. The contents will differ depending on whether or not [Overwrite old data after finishing the specified no. of times] is designated.

When [Overwrite old data after finishing the specified no. of times] is set

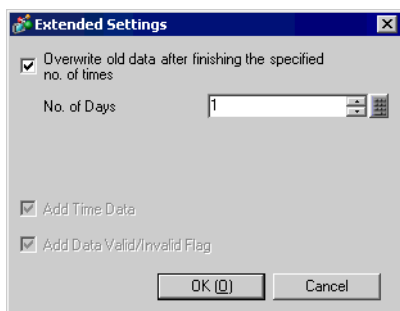

When [Overwrite old data after finishing the specified no. of times] is not set

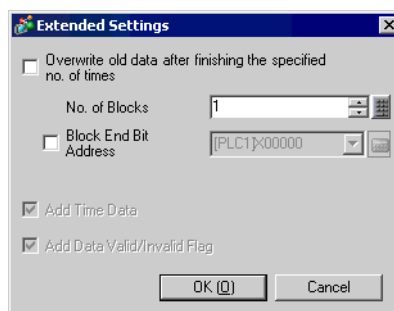

Setting	Description
<p>Overwrite old data after finishing the specified no. of times</p>	<p>Select whether or not the data will be overwritten and stored, starting with the oldest data, after data has been sampled from the designated number of times. If this is set, even when all the data sampling has completed ([No. of Times] × [No. of Days]), sampling will continue and data, starting with old data, will be overwritten. If this is not set, previous data will not be overwritten. The new rounds of data will be stored as separate blocks. After all data has been stored ([No. of Times] × [No. of Blocks]), sampling will not occur until all stored data has been deleted.</p> <div style="display: flex; justify-content: space-around;"> <div style="text-align: center;"> <input checked="" type="checkbox"/> Overwrite old data after finishing the specified no. of times  <p>(n: No. of Times, m: No. of Days)</p> </div> <div style="text-align: center;"> <input type="checkbox"/> Overwrite old data after finishing the specified no. of times  <p>(n: No. of Times, m: No. of Blocks)</p> </div> </div>
<p>No. of Days</p>	<p>Designate how many days' sampling data should be maintained inside backup SRAM (or DRAM). Data from the designated number of days is stored, and then overwritten in order, starting with the first day's data. The value can be from 1 to 2,048. The setting range will automatically be limited to ensure that the amount of [No. of Times] × [No. of Days] is 65,535 or less.</p>
<p>No. of Blocks</p>	<p>The complete set of data collected in the designated number of times is called a [block]. Designate the number of blocks to set inside one Sampling Group. The value can be from 1 to 2,048. The setting range will automatically be limited to ensure that the amount of [No. of Times] × [No. of Blocks] is 65,535 or less.</p>
<p>Block Termination Bit Address</p>	<p>After the sampling for one block of data (the designated number of times) is completed, this bit address will turn ON to confirm that the operation is finished. To confirm, set this address. This tells that one block's sampling has completed. The sampling action will still continue for the designated [No. of Blocks].</p> <p><b>NOTE</b></p> <ul style="list-style-type: none"> <li>This address will not be turned OFF automatically. In order to verify the completion of the next block, please ensure that this bit is returned to OFF.</li> </ul>
<p>Add Time Data</p>	<p>The sample time will be stored along with the sampled data. This setting is fixed.</p>
<p>Add Data Valid/Invalid Flag</p>	<p>Stores an observation flag along with the data which monitors if the data has been saved properly. This setting is fixed.</p>

## ◆ Constant Cycle

Sample data at constant cycles starting from when the GP is turned ON.

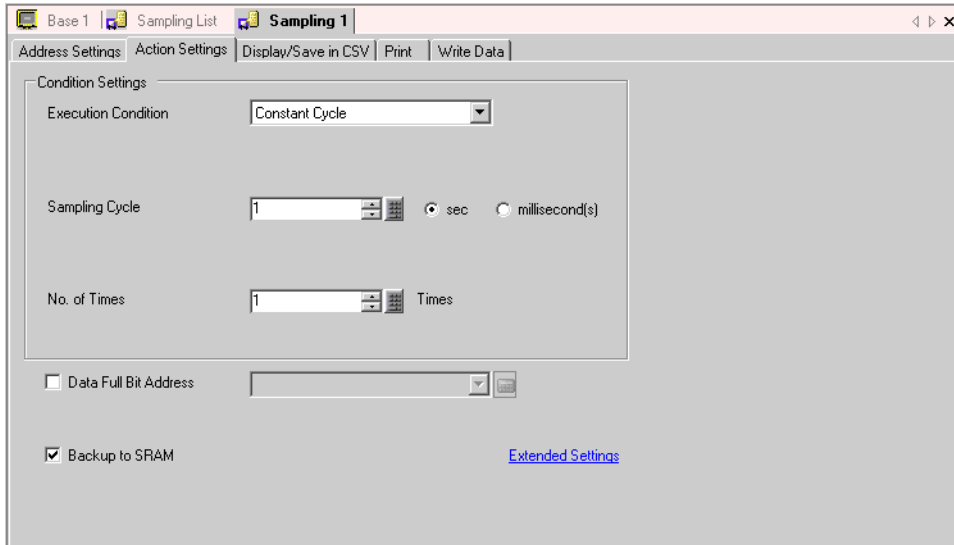

Setting	Description
Execution Condition	Select the sampling action's execution condition. Select [Constant Cycle].
Sampling Cycle	Select either seconds (s) or milliseconds (ms) as the unit for the sampling cycle. The value can be from 1 to 65,535 for seconds, or from 100 to 900 for milliseconds. <b>NOTE</b> <ul style="list-style-type: none"> <li>Even when milliseconds are selected, only the first sampling is started in the timing of seconds.</li> </ul>
No. of Times	Select the number of times sampling will occur. The value can be from 1 to 65,535. <b>IMPORTANT</b> <ul style="list-style-type: none"> <li>The setting range is limited by the number of sampling groups and addresses (words) registered in the entire system.</li> </ul>
Data Full Bit Address	After the designated number of data samples are completed, this address will be used to confirm that the operation is finished. Select whether or not to verify this bit address. This bit tells when a data sampling cycle has been done. The sampling operation will continue running even when this bit is ON. <b>NOTE</b> <ul style="list-style-type: none"> <li>This address will not be turned OFF automatically. In order to verify the next sampling cycle, please ensure that this bit is returned to the OFF state.</li> </ul>
Backup to SRAM	Select whether or not to save the sampling data to the backup SRAM. If the sampling data is not saved, the data will be deleted when the GP unit's power is turned off or reset. ☞ "24.9.1 Summary ■ Backup SRAM" (page 24-98)

<Extended Settings>

Click [Extended Settings] and the following dialog box will open.

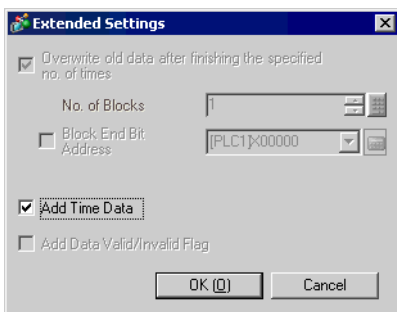

Setting	Description
Overwrite old data after finishing the specified no. of times	Data will be overwritten and stored, starting with the oldest data, after data has been sampled from the designated number of times. This setting is fixed.
Add Time Data	Select whether or not to store the sample time along with the sampled data. If this is not designated, when displaying/saving in CSV or printing, the date/time columns will be blank.

◆ Constant Cycle when Bit is ON

Sample data at constant cycles starting from when the GP is turned ON, but only when the designated bit is ON.

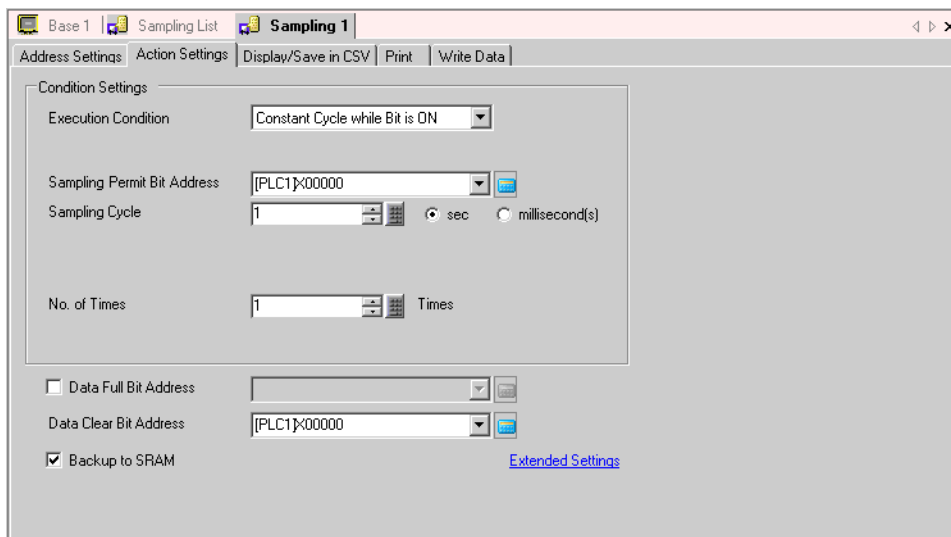

Setting	Description
Execution Condition	Select the sampling action's execution condition. Select [Constant Cycle when Bit is ON].
Sampling Permit Bit Address	Select the address which will control whether or not sampling will execute. While this address is ON, data will be read each cycle.

Continued

Setting	Description
Sampling Cycle	<p>Select either seconds (s) or milliseconds (ms) as the unit for the sampling cycle. The value can be from 1 to 65,535 for seconds, or from 100 to 900 for milliseconds.</p> <p><b>NOTE</b></p> <ul style="list-style-type: none"> <li>• Even when milliseconds are selected, only the first sampling is started in the timing of seconds.</li> </ul>
No. of Times	<p>Select the number of times sampling will occur. The value can be from 1 to 65,535.</p> <p><b>IMPORTANT</b></p> <ul style="list-style-type: none"> <li>• The setting range is limited by the number of sampling groups and addresses (words) registered in the entire system.</li> </ul>
Data Full Bit Address	<p>After the designated number of data samples are completed, this address will be used to confirm that the operation is finished. Select whether or not to verify this bit address. This bit tells when a data sampling cycle has been done. The sampling operation will continue running even when this bit is ON.</p> <p><b>NOTE</b></p> <ul style="list-style-type: none"> <li>• This address will not be turned OFF automatically. In order to verify the next sampling cycle, please ensure that this bit is returned to the OFF state.</li> </ul>
Data Clear Bit Address	<p>Designate the bit address to control the clearing of the sampling data. When this address turns ON, all the Sampling Groups' data stored in the GP will be erased. After clearing the data, this bit will automatically turn OFF.</p>
Backup to SRAM	<p>Select whether or not to save the sampling data to the backup SRAM. If the sampling data is not saved, the data will be deleted when the GP unit's power is turned off or reset.</p> <p>☞ "24.9.1 Summary ■ Backup SRAM" (page 24-98)</p>

<Extended Settings>

Click [Extended Settings] and the following dialog box will open.

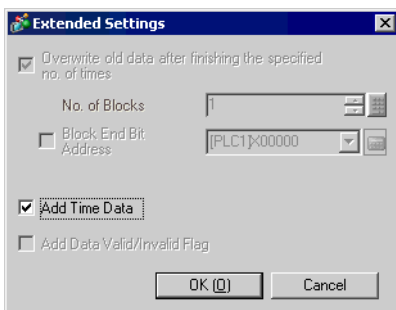

Setting	Description
Overwrite old data after finishing the specified no. of times	Data will be overwritten and stored, starting with the oldest data, after data has been sampled from the designated number of times. This setting is fixed.
Add Time Data	Select whether or not to store the sample time along with the sampled data. If this is not designated, when displaying/saving in CSV or printing, the date/time columns will be blank.

## ◆ Bit ON

Sample data every time the designated bit turns ON.

Setting	Description
Execution Condition	Select the sampling action's execution condition. Select [Bit ON].
Sampling Trigger Bit Address	Select the address which will control the sampling's timing. The sampling will execute every time this address turns ON.
No. of Times	Select the number of times sampling will occur. If [Overwrite old data after finishing the specified no. of times] is set in [Extended Settings], this can be from 1 to 65,535 times. If it is not set, the range is from 1 to 2,048 times. <b>IMPORTANT</b> <ul style="list-style-type: none"> <li>The setting range is limited by the number of sampling groups and addresses (words) registered in the entire system.</li> </ul>
Data Full Bit Address	After all the sampling is completed (the set [No. of Times] × [No. of Blocks]) this address will be used to confirm that the operation is finished. Select whether or not to verify this bit address. When [Overwrite old data after finishing the specified no. of times] is set on [Extended Settings], this bit tells when a data sampling cycle has been done. The sampling operation will continue running even when this bit is ON. If not designated, the sampling action will end when this bit turns ON. Please turn ON the [Data Clear Bit Address] to resume. <b>NOTE</b> <ul style="list-style-type: none"> <li>This address will not be turned OFF automatically. If [Overwrite old data after finishing the specified no. of times] is set, please ensure that the bit is turned OFF in order to confirm the next sampling cycle.</li> </ul>
Data Clear Bit Address	Designate the bit address to control the clearing of the sampling data. When this address turns ON, all the Sampling Groups' data stored in the GP will be erased. After clearing the data, this bit will automatically turn OFF.
Backup to SRAM	Select whether or not to save the sampling data to the backup SRAM. If the sampling data is not saved, the data will be deleted when the GP unit's power is turned off or reset. ☞ "24.9.1 Summary ■ Backup SRAM" (page 24-98)

## &lt;Extended Settings&gt;

Click [Extended Settings] and the following dialog box will open.

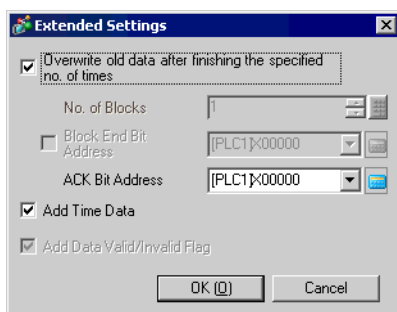

Setting	Description
Overwrite old data after finishing the specified no. of times	Select whether or not the data will be overwritten and stored, starting with the oldest data, after data has been sampled from the designated number of times. When this is selected, sampling will continue even after the number of times has completed. Old data will not remain. If this is not set, previous data will not be overwritten. The new rounds of data will be stored as separate blocks. After data from ([No. of Times] × [No. of Blocks]) has been stored, sampling will not occur until all stored data has been deleted.
No. of Blocks	All the data collected in the sampled in the designated number of times is called a [block]. Designate the number of blocks to set inside one sampling group, only if [Overwrite old data after finishing the specified no. of times] is not set. The value can be from 1 to 2,048. The settings range will automatically be limited to ensure that the amount of [No. of Times] × [No. of Blocks] is less than 65,535.
Block Termination Bit Address	After the sampling for one block of data (the designated number of times) is completed, this bit address will turn ON to confirm that the operation is finished. To confirm, set this address. This tells that one block's sampling has completed. The sampling action will still continue for the designated [No. of Blocks]. <b>NOTE</b> <ul style="list-style-type: none"> <li>This address will not be turned OFF automatically. In order to verify the completion of the next block, please ensure that this bit is returned to OFF.</li> </ul>
ACK Bit Address	Select the address which will confirm when the data reading is finished. When the data reading is finished, the GP will automatically turn this bit ON. When this address receives a [Bit ON] state, please turn OFF the device/PLC's [Sampling Trigger Bit Address]. When the [Sampling Trigger Bit Address] turns OFF, this bit will automatically turn OFF.
Add Time Data	Select whether or not to store the time when the data read finished, along with the sampled data. If this is not designated, when displaying/saving in CSV or printing, the date/time columns will be blank.
Add Data Valid/Invalid Flag	Stores an observation flag along with the data which monitors if the data has been saved properly. This setting is fixed.

◆ **Bit Change**

Sample data every time the designated bit's state changes (ON/OFF).

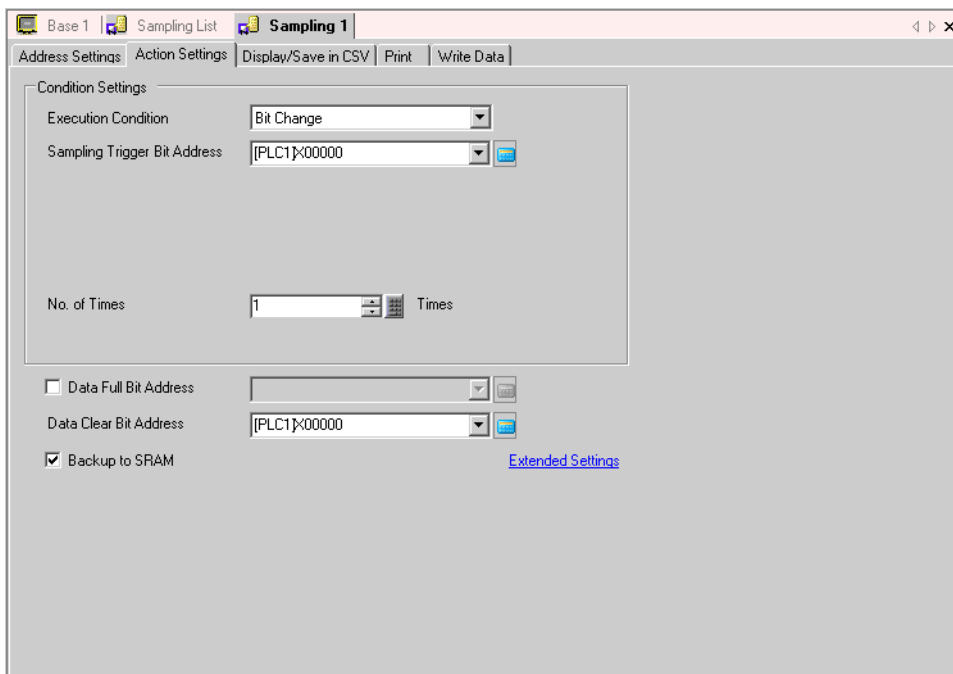

Setting	Description
Execution Condition	Select the sampling action's execution condition. Select [Bit Change].
Sampling Trigger Bit Address	Select the address which will control the sampling's timing. The sampling will execute every time this address changes (ON/OFF).
No. of Times	Select the number of times sampling will occur. The value can be from 1 to 65,535. <b>IMPORTANT</b> <ul style="list-style-type: none"> <li>The setting range is limited by the number of sampling groups and addresses (words) registered in the entire system.</li> </ul>
Data Full Bit Address	After the designated number of data samples are completed, this address will be used to confirm that the operation is finished. Select whether or not to verify this bit address. This bit tells when a data sampling cycle has been done. The sampling action will continue running even when this bit is ON. <b>NOTE</b> <ul style="list-style-type: none"> <li>This address will not be turned OFF automatically. In order to verify the next sampling cycle, please ensure that this bit is returned to the OFF state.</li> </ul>
Data Clear Bit Address	Designate the bit address to control the clearing of the sampling data. When this address turns ON, all the Sampling Groups' data stored in the GP will be erased. After clearing the data, this bit will automatically turn OFF.
Backup to SRAM	Select whether or not to save the sampling data to the backup SRAM. If the sampling data is not saved, the data will be deleted when the GP unit's power is turned off or reset. ☞ "24.9.1 Summary ■ Backup SRAM" (page 24-98)

<Extended Settings>

Click [Extended Settings] and the following dialog box will open.

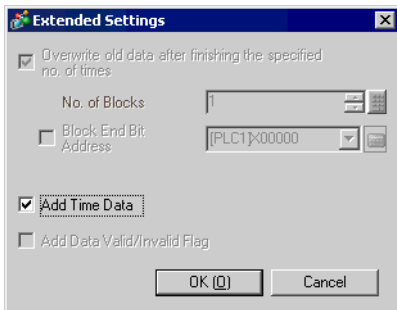

Setting	Description
Overwrite old data after finishing the specified no. of times	Data will be overwritten and stored, starting with the oldest data, after data has been sampled from the designated number of times. This setting is fixed.
Add Time Data	Select whether or not to store the sample time along with the sampled data. If this is not designated, when displaying/saving in CSV or printing, the date/time columns will be blank.

## ■ Display/Save in CSV

When displaying sampling data on the GP screen, or when saving to the CF-card in CSV format, set the format. The settings items are different depending on the format display mode: [Simple Settings] or [Custom Settings].

The following is a settings guide for [Simple Settings]. For [Custom Settings], please refer to “ ■ Display/Save in CSV (Custom Settings)” (page 24-61) .

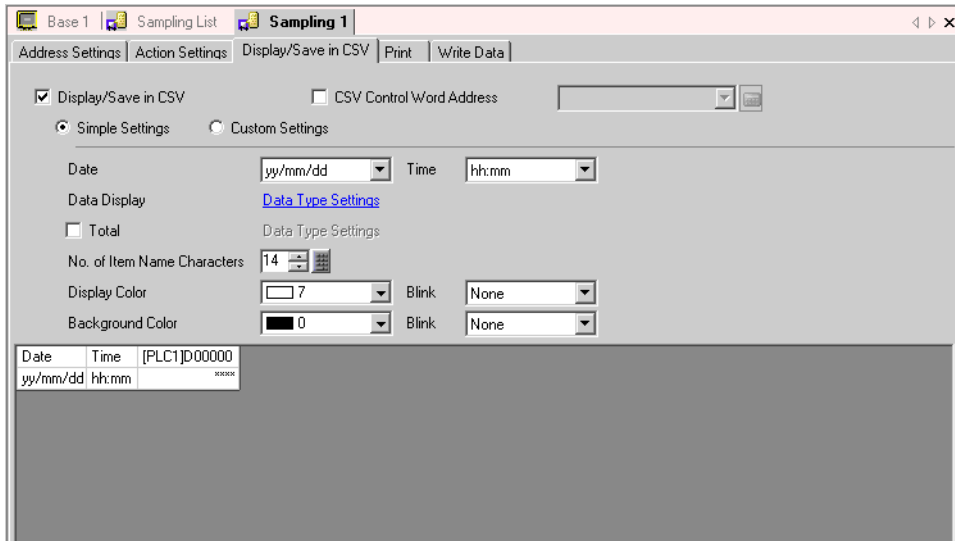

Setting	Description				
Display/Save in CSV	Designate whether or not display sampling data on the GP screen or save to the CF-card. When using a Sampling Data Display to display data on the screen or saving data to a CF-card, please ensure this box is selected and set the format.				
CSV Control Word Address	Designate whether or not to save to the CF-card in CSV format. When saving to a CF-card, set this address to control the writing data to the CF-card. Two sequential word addresses are automatically used as the area to write the command and its result (status), and file number (the ***** portion in “SA*****.csv”). The file number can be from 0 to 65,535.  <div style="text-align: center;"> <table border="1" style="margin-left: auto; margin-right: auto;"> <tr> <td>Control Word Address</td> <td>Command/Status</td> </tr> <tr> <td>+1</td> <td>File No.</td> </tr> </table> </div> <p>☞ “24.6.3 CF-Card Save Action ■ CSV Control Word Address” (page 24-23)</p>	Control Word Address	Command/Status	+1	File No.
Control Word Address	Command/Status				
+1	File No.				
Simple Settings/ Custom Settings	Select the format’s setting mode. <ul style="list-style-type: none"> <li>• Simple Settings Use a preset format to easily configure settings.</li> <li>• Custom Settings Set a customized format.</li> </ul>				

Continued

Setting	Description
Date	<p>Select the date display format from [yy/mm/dd], [mm/dd/yy], [dd/mm/yy], or [mm/dd]. [yy] represents the last 2 digits of the Western calendar year, and [mm] and [dd] represent the month and day, displayed as two digits.</p> <p><b>NOTE</b></p> <ul style="list-style-type: none"> <li>Regardless of the chosen display format, the [yy/mm/dd] format will be used when saving to the CF-card.</li> </ul>
Time	<p>Select the time display format from [hh:mm], [hh:mm:ss], or [hh:mm:ss.ms]. [hh] represents the hours, [mm] represents the minutes, [ss] represents the seconds. Each one is displayed as 2 digits. [ms] represents the milliseconds and is displayed as 3 digits.</p> <p><b>NOTE</b></p> <ul style="list-style-type: none"> <li>Regardless of the chosen display format, the [hh:mm:ss] format ([hh:mm:ss.000] when the sampling duration is set to [Milliseconds]) will be used when outputting CSV.</li> </ul>
Data Display	<p>Click [Data Type Settings] to open the [Data Settings] dialog box. The data type, input range, number of display digits, etc. can now be set.</p> <p>☞ “◆ [Data Settings] Dialog Box” (page 24-54)</p>
Total	<p>Select whether or not the totals row will be displayed. Values calculated from the data of the designated No. of Times stored in the GP are displayed.</p> <p>Click on [Data Type Settings] and open the [Calculation Settings] dialog box. The data type and style for the totals rows can now be set.</p> <p>☞ “◆ [Calculation Settings] Dialog Box” (page 24-59)</p> <p><b>NOTE</b></p> <ul style="list-style-type: none"> <li>Regardless of whether a totals row is designated or not, calculation data will not be exported with the CSV file.</li> </ul>
No. of Item Name Characters	<p>Set the number of item name characters from 1 to 20 (single-byte).</p> <p><b>NOTE</b></p> <ul style="list-style-type: none"> <li>You cannot set a value that is less than the Date Column/Time Column's display format or the data column's display format</li> </ul>
Display Color	<p>Select a color for the text and values to be displayed.</p>
Background Color	<p>Select a background color for the text.</p>
Blink	<p>Select whether or not the Part will blink, and the blink speed. You can choose different blink settings for the [Display Color], and [Background Color].</p> <p><b>NOTE</b></p> <ul style="list-style-type: none"> <li>There are cases where you can and can not set Blink depending on the Main Unit and System Settings' [Color Settings].</li> </ul> <p>☞ “9.5.1 Specify Color ■ Supported Color List” (page 9-33)</p>

Continued

Setting	Description																																																																	
Preview Area	<p>Displays the set contents with the selected format.</p> <p>If [Overwrite old data after finishing the specified no. of times] is designated on the [Action Settings] tab's Extended Settings, only one data row will be displayed. If it is not designated, the data rows will equal the designated [No. of Times].</p> <p>When [Overwrite old data after finishing the specified no. of times] is set</p> <table border="1" data-bbox="504 428 1138 521"> <thead> <tr> <th>Date</th> <th>Time</th> <th>[PLC1]D00100</th> <th>[PLC1]D00101</th> <th>[PLC1]D00102</th> </tr> </thead> <tbody> <tr> <td>yy/mm/dd</td> <td>hh:mm</td> <td>****</td> <td>****</td> <td>****</td> </tr> </tbody> </table>	Date	Time	[PLC1]D00100	[PLC1]D00101	[PLC1]D00102	yy/mm/dd	hh:mm	****	****	****																																																							
	Date	Time	[PLC1]D00100	[PLC1]D00101	[PLC1]D00102																																																													
	yy/mm/dd	hh:mm	****	****	****																																																													
<p>When [Overwrite old data after finishing the specified no. of times] is not set</p> <table border="1" data-bbox="466 595 1174 942"> <thead> <tr> <th></th> <th>Date</th> <th>Time</th> <th>[PLC1]D00100</th> <th>[PLC1]D00101</th> <th>[PLC1]D00102</th> </tr> </thead> <tbody> <tr><td>No.1</td><td>yy/mm/dd</td><td>hh:mm</td><td>****</td><td>****</td><td>****</td></tr> <tr><td>No.2</td><td>yy/mm/dd</td><td>hh:mm</td><td>****</td><td>****</td><td>****</td></tr> <tr><td>No.3</td><td>yy/mm/dd</td><td>hh:mm</td><td>****</td><td>****</td><td>****</td></tr> <tr><td>No.4</td><td>yy/mm/dd</td><td>hh:mm</td><td>****</td><td>****</td><td>****</td></tr> <tr><td>No.5</td><td>yy/mm/dd</td><td>hh:mm</td><td>****</td><td>****</td><td>****</td></tr> <tr><td>No.6</td><td>yy/mm/dd</td><td>hh:mm</td><td>****</td><td>****</td><td>****</td></tr> <tr><td>No.7</td><td>yy/mm/dd</td><td>hh:mm</td><td>****</td><td>****</td><td>****</td></tr> <tr><td>No.8</td><td>yy/mm/dd</td><td>hh:mm</td><td>****</td><td>****</td><td>****</td></tr> <tr><td>No.9</td><td>yy/mm/dd</td><td>hh:mm</td><td>****</td><td>****</td><td>****</td></tr> <tr><td>No.10</td><td>yy/mm/dd</td><td>hh:mm</td><td>****</td><td>****</td><td>****</td></tr> </tbody> </table>		Date	Time	[PLC1]D00100	[PLC1]D00101	[PLC1]D00102	No.1	yy/mm/dd	hh:mm	****	****	****	No.2	yy/mm/dd	hh:mm	****	****	****	No.3	yy/mm/dd	hh:mm	****	****	****	No.4	yy/mm/dd	hh:mm	****	****	****	No.5	yy/mm/dd	hh:mm	****	****	****	No.6	yy/mm/dd	hh:mm	****	****	****	No.7	yy/mm/dd	hh:mm	****	****	****	No.8	yy/mm/dd	hh:mm	****	****	****	No.9	yy/mm/dd	hh:mm	****	****	****	No.10	yy/mm/dd	hh:mm	****	****	****
	Date	Time	[PLC1]D00100	[PLC1]D00101	[PLC1]D00102																																																													
No.1	yy/mm/dd	hh:mm	****	****	****																																																													
No.2	yy/mm/dd	hh:mm	****	****	****																																																													
No.3	yy/mm/dd	hh:mm	****	****	****																																																													
No.4	yy/mm/dd	hh:mm	****	****	****																																																													
No.5	yy/mm/dd	hh:mm	****	****	****																																																													
No.6	yy/mm/dd	hh:mm	****	****	****																																																													
No.7	yy/mm/dd	hh:mm	****	****	****																																																													
No.8	yy/mm/dd	hh:mm	****	****	****																																																													
No.9	yy/mm/dd	hh:mm	****	****	****																																																													
No.10	yy/mm/dd	hh:mm	****	****	****																																																													

◆ [Data Settings] Dialog Box

[Data Type] Tab

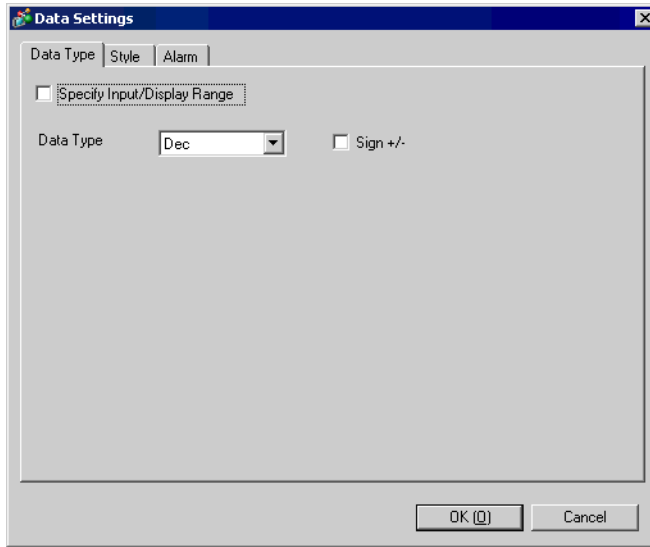

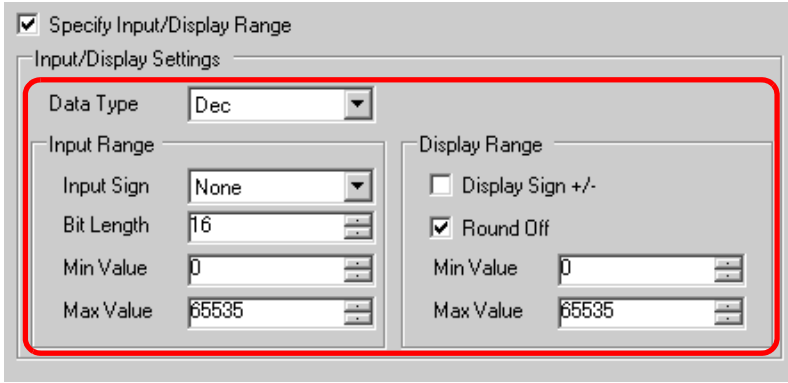
Setting	Description
Specify Input/Display Range	<p>Designate whether or not an input range and display range of the sampling data will be set. If designated, the following setting items will appear.</p> 
Data Type	<p>Choose the data type from [Dec], [BCD], [Hex], or [Float]. [Float] can only be selected when the set [Bit Length] is [32 Bit] on the [Address Settings] tab.</p> <p><b>NOTE</b></p> <ul style="list-style-type: none"> <li>When [BCD] is selected, sampling data containing the digits A-F (hexadecimal) other than BCD will be displayed/saved in CSV with "----" (No. of digits "-").</li> </ul>
Sign +/-	<p>Designate whether or not to attach a minus sign to data. This can only be set when the [Data Type] is [Dec].</p> <p><b>NOTE</b></p> <ul style="list-style-type: none"> <li>This is fixed when the [Data Type] is [Float].</li> </ul>

Continued

Setting		Description																																		
Input Range	Input Sign	<p>If [Specify Input/Display Range] is designated and [Data Type] is [Dec], select whether or not to handle negative numbers.</p> <ul style="list-style-type: none"> <li>• None Only positive numeric data.</li> <li>• 2's Complement Negative numbers are handled with 2's complement.</li> <li>• MSB Sign Negative numbers are handled with MSB sign (highest bit).</li> </ul>																																		
	Bit Length	If [Specify Input/Display Range] is designated and [Data Length] is [16 Bit] on the [Address Settings] tab, set the bit length for one word from 1 to 16.																																		
	Min Value/ Max Value	<p>If [Specify Input/Display Range] is designated, set the data's input range. Each [Data Type] and [Input Sign] has a different size range.</p> <table border="1"> <thead> <tr> <th>Bit Length</th> <th>Data Type</th> <th>Input Sign</th> <th>Input Range</th> </tr> </thead> <tbody> <tr> <td rowspan="4">16 Bit</td> <td rowspan="3">Dec</td> <td>None</td> <td>0 to 65,535</td> </tr> <tr> <td>2's Complement</td> <td>-32,768 to 32,767</td> </tr> <tr> <td>MSB Sign</td> <td>-32,767 to 32,767</td> </tr> <tr> <td>Hex</td> <td>—</td> <td>0 to FFFF(h)</td> </tr> <tr> <td>BCD</td> <td>—</td> <td>0 to 9,999</td> </tr> <tr> <td rowspan="5">32 Bit</td> <td rowspan="3">Dec</td> <td>None</td> <td>0 to 4,294,967,295</td> </tr> <tr> <td>2's Complement</td> <td>-2,147,483,648 to 2,147,483,647</td> </tr> <tr> <td>MSB Sign</td> <td>-2,147,483,647 to 2,147,483,647</td> </tr> <tr> <td>Hex</td> <td>—</td> <td>0 to FFFFFFFF(h)</td> </tr> <tr> <td>BCD</td> <td>—</td> <td>0 to 99,999,999</td> </tr> <tr> <td>Float</td> <td>—</td> <td>-9.9e<sup>16</sup> to 9.9e<sup>16</sup></td> </tr> </tbody> </table>	Bit Length	Data Type	Input Sign	Input Range	16 Bit	Dec	None	0 to 65,535	2's Complement	-32,768 to 32,767	MSB Sign	-32,767 to 32,767	Hex	—	0 to FFFF(h)	BCD	—	0 to 9,999	32 Bit	Dec	None	0 to 4,294,967,295	2's Complement	-2,147,483,648 to 2,147,483,647	MSB Sign	-2,147,483,647 to 2,147,483,647	Hex	—	0 to FFFFFFFF(h)	BCD	—	0 to 99,999,999	Float	—
Bit Length	Data Type	Input Sign	Input Range																																	
16 Bit	Dec	None	0 to 65,535																																	
		2's Complement	-32,768 to 32,767																																	
		MSB Sign	-32,767 to 32,767																																	
	Hex	—	0 to FFFF(h)																																	
BCD	—	0 to 9,999																																		
32 Bit	Dec	None	0 to 4,294,967,295																																	
		2's Complement	-2,147,483,648 to 2,147,483,647																																	
		MSB Sign	-2,147,483,647 to 2,147,483,647																																	
	Hex	—	0 to FFFFFFFF(h)																																	
	BCD	—	0 to 99,999,999																																	
Float	—	-9.9e <sup>16</sup> to 9.9e <sup>16</sup>																																		
Display Range	Display Sign +/-	If [Specify Input/Display Range] is designated and [Data Type] is [Dec], select whether or not to attach a sign to display data.																																		
	Round Off	Designate whether or not to round off fractions when converting input values to the display range. Fractions will be discarded if rounding off is not selected.																																		
	Min Value/ Max Value	<p>If [Specify an Input/Display Range] is designated, select a Min Value/Max Value for the display range. The settings range is different, depending on the [Data Type] and whether [Display Sign +/-] is set.</p> <table border="1"> <thead> <tr> <th>Bit Length</th> <th>Data Type</th> <th>Display Sign +/-</th> <th>Display Range</th> </tr> </thead> <tbody> <tr> <td rowspan="3">16 Bit</td> <td rowspan="2">Dec</td> <td>Checked</td> <td>-32,768 to 32,767</td> </tr> <tr> <td>Unchecked</td> <td>0 to 65,535</td> </tr> <tr> <td>Hex</td> <td>—</td> <td>0 to FFFF(h)</td> </tr> <tr> <td>BCD</td> <td>—</td> <td>0 to 9,999</td> </tr> <tr> <td rowspan="4">32 Bit</td> <td rowspan="2">Dec</td> <td>Checked</td> <td>-2,147,483,648 to 2,147,483,647</td> </tr> <tr> <td>Unchecked</td> <td>0 to 4,294,967,295</td> </tr> <tr> <td>Hex</td> <td>—</td> <td>0 to FFFFFFFF(h)</td> </tr> <tr> <td>BCD</td> <td>—</td> <td>0 to 99,999,999</td> </tr> <tr> <td>Float</td> <td>Checked (Fixed)</td> <td>-9.9e<sup>16</sup> to 9.9e<sup>16</sup></td> </tr> </tbody> </table>	Bit Length	Data Type	Display Sign +/-	Display Range	16 Bit	Dec	Checked	-32,768 to 32,767	Unchecked	0 to 65,535	Hex	—	0 to FFFF(h)	BCD	—	0 to 9,999	32 Bit	Dec	Checked	-2,147,483,648 to 2,147,483,647	Unchecked	0 to 4,294,967,295	Hex	—	0 to FFFFFFFF(h)	BCD	—	0 to 99,999,999	Float	Checked (Fixed)	-9.9e <sup>16</sup> to 9.9e <sup>16</sup>			
Bit Length	Data Type	Display Sign +/-	Display Range																																	
16 Bit	Dec	Checked	-32,768 to 32,767																																	
		Unchecked	0 to 65,535																																	
	Hex	—	0 to FFFF(h)																																	
BCD	—	0 to 9,999																																		
32 Bit	Dec	Checked	-2,147,483,648 to 2,147,483,647																																	
		Unchecked	0 to 4,294,967,295																																	
	Hex	—	0 to FFFFFFFF(h)																																	
	BCD	—	0 to 99,999,999																																	
Float	Checked (Fixed)	-9.9e <sup>16</sup> to 9.9e <sup>16</sup>																																		

[Style] Tab

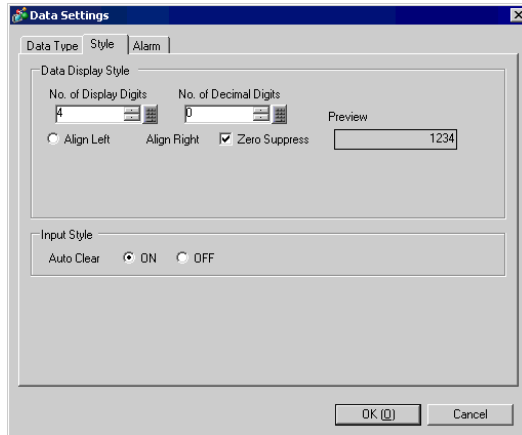

Setting	Description
No. of Display Digits	Select the number of display digits for the data from 1 to 17. This can be designated to within the number of characters set in [No. of Item Name Characters]. The numbers displayed after the decimal point are also included in the number of digits. e.g.) When the No. of Display Digits is “5”, and the No. of Decimal Digits is “2” <div style="text-align: center; margin-top: 10px;"> <span style="border: 1px solid black; padding: 2px 10px;">123.45</span> </div>
No. of Decimal Digits	Set the number of display digits after the decimal point, from 0 to [No. of Display Digits] – 1. This cannot be set when the [Data Type] is [Hex].
Align Right/Align Left	Select the data’s display position.
Zero Suppress	If this option is selected, leading zeros are not displayed. e.g.) When No. of Display Digits = 4 <div style="display: flex; justify-content: space-around; align-items: center; margin-top: 10px;"> <div style="text-align: center;"> <input checked="" type="checkbox"/> Zero Suppress  <span style="border: 1px solid black; padding: 2px 10px;">25</span>                          Leading zeroes are not displayed                     </div> <div style="text-align: center;"> <input type="checkbox"/> Zero Suppress  <span style="border: 1px solid black; padding: 2px 10px;">0025</span>                          Zeroes are added to correspond to the No. of Display Digits                     </div> </div>
Preview	Preview the selected style.

Continued

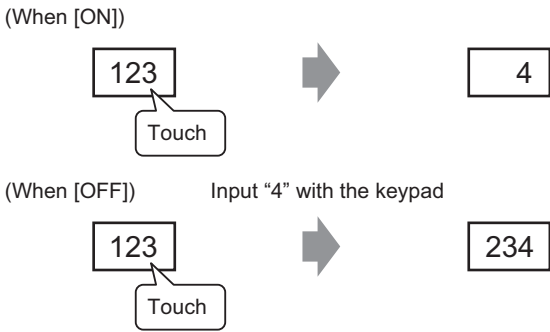
Setting	Description
Auto Clear	<p>Select whether or not to automatically clear previously inputted values when correcting data on the screen. If [ON] is set, previous values are deleted when a value is inputted, and only the new value is displayed. If [OFF] is set, previous data remains, and the new value is added to the end.</p> <p>e.g.) When No. of Display Digit = 3</p> <p>(When [ON])</p>  <p>(When [OFF])      Input "4" with the keypad</p>

[Alarm] Tab

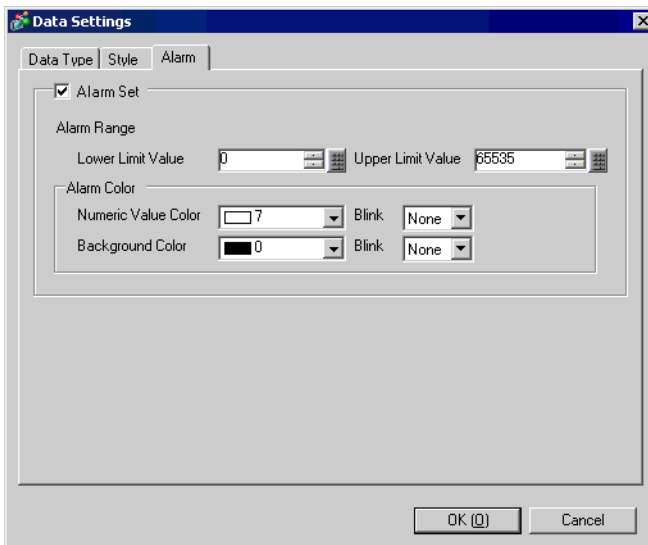

Setting	Description																																	
Alarm Set	Designate whether or not to display an alarm (change the data's color when the value goes outside of the alarm range).																																	
Upper Limit Value/ Lower Limit Value	<p>If [Specify Input/Display Range] is not designated on the [Data Type] tab, select the alarm range's upper limit value and lower limit value. Set values within the ranges of the following table.</p> <table border="1"> <thead> <tr> <th>Bit Length</th> <th>Data Type</th> <th>Display Sign +/-</th> <th>Display Range</th> </tr> </thead> <tbody> <tr> <td rowspan="3">16 Bit</td> <td rowspan="2">Dec</td> <td>Checked</td> <td>-32,768 to 32,767</td> </tr> <tr> <td>Unchecked</td> <td>0 to 65,535</td> </tr> <tr> <td>Hex</td> <td>—</td> <td>0 to FFFF(h)</td> </tr> <tr> <td></td> <td>BCD</td> <td>—</td> <td>0 to 9,999</td> </tr> <tr> <td rowspan="4">32 Bit</td> <td rowspan="2">Dec</td> <td>Checked</td> <td>-2,147,483,648 to 2,147,483,647</td> </tr> <tr> <td>Unchecked</td> <td>0 to 4,294,967,295</td> </tr> <tr> <td>Hex</td> <td>—</td> <td>0 to FFFFFFFF(h)</td> </tr> <tr> <td>BCD</td> <td>—</td> <td>0 to 99,999,999</td> </tr> <tr> <td></td> <td>Float</td> <td>Checked (Fixed)</td> <td>-9.9e<sup>16</sup> to 9.9e<sup>16</sup></td> </tr> </tbody> </table> <p>If [Specify Input/Display Range] is designated, Min. Value/Max. Value for the [Display Range] is displayed.</p>	Bit Length	Data Type	Display Sign +/-	Display Range	16 Bit	Dec	Checked	-32,768 to 32,767	Unchecked	0 to 65,535	Hex	—	0 to FFFF(h)		BCD	—	0 to 9,999	32 Bit	Dec	Checked	-2,147,483,648 to 2,147,483,647	Unchecked	0 to 4,294,967,295	Hex	—	0 to FFFFFFFF(h)	BCD	—	0 to 99,999,999		Float	Checked (Fixed)	-9.9e <sup>16</sup> to 9.9e <sup>16</sup>
Bit Length	Data Type	Display Sign +/-	Display Range																															
16 Bit	Dec	Checked	-32,768 to 32,767																															
		Unchecked	0 to 65,535																															
	Hex	—	0 to FFFF(h)																															
	BCD	—	0 to 9,999																															
32 Bit	Dec	Checked	-2,147,483,648 to 2,147,483,647																															
		Unchecked	0 to 4,294,967,295																															
	Hex	—	0 to FFFFFFFF(h)																															
	BCD	—	0 to 99,999,999																															
	Float	Checked (Fixed)	-9.9e <sup>16</sup> to 9.9e <sup>16</sup>																															
Numeric Value Color	Select the numeric value color for when the Alarm is displayed.																																	
Background Color	Select the background color for when the Alarm is displayed.																																	
Blink	<p>Select whether or not the Part will blink, and the blink speed. You can choose different blink settings for the Alarm's [Numeric Value Color] and [Background Color].</p> <p><b>NOTE</b></p> <ul style="list-style-type: none"> <li>There are cases where you can and can not set Blink depending on the Main Unit and System Settings' [Color Settings].</li> </ul> <p>☞ "9.5.1 Specify Color ■ Supported Color List" (page 9-33)</p>																																	

◆ [Calculation Settings] Dialog Box

[Data Type] Tab

The [Total] row's data type conforms to the data type set in the [Data Type Settings] dialog box. (There is no item to set on this tab.)

[Style] Tab

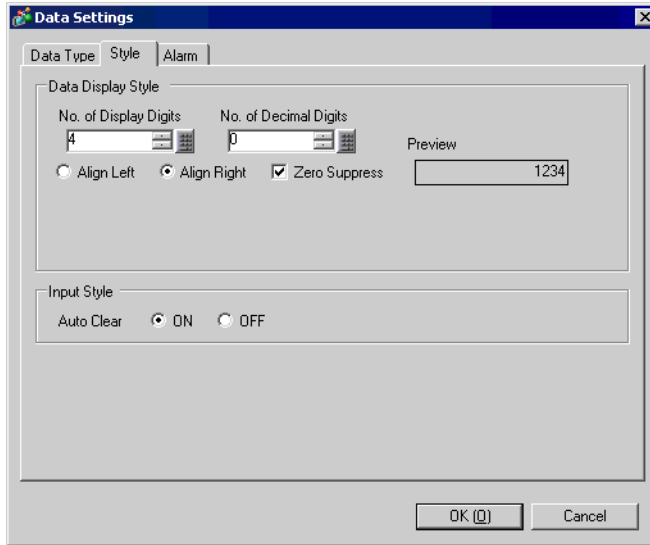

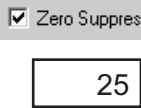
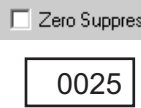
Setting	Description
No. of Display Digits	Select the number of display digits for the calculation data from 1 to 17. This can be designated to within the number of characters set in [No. of Item Name Characters]. The numbers displayed after the decimal point are also included in the number of digits. e.g.) When the No. of Display Digits is 5, and the No. of Decimal Digits is 2 
No. of Decimal Digits	Set the number of display digits after the decimal point for the calculation data, from 0 to [No. of Display Digits] – 1. This cannot be set when the [Data Type] is [Hex].
Align Right/Align Left	Select the calculation data's display position.
Zero Suppress	If this option is selected, leading zeros are not displayed. e.g.) When No. of Display Digits = 4  Leading zeroes are not displayed  Zeroes are added to correspond to the No. of Display Digits
Preview	Preview the selected style.

[Alarm] Tab

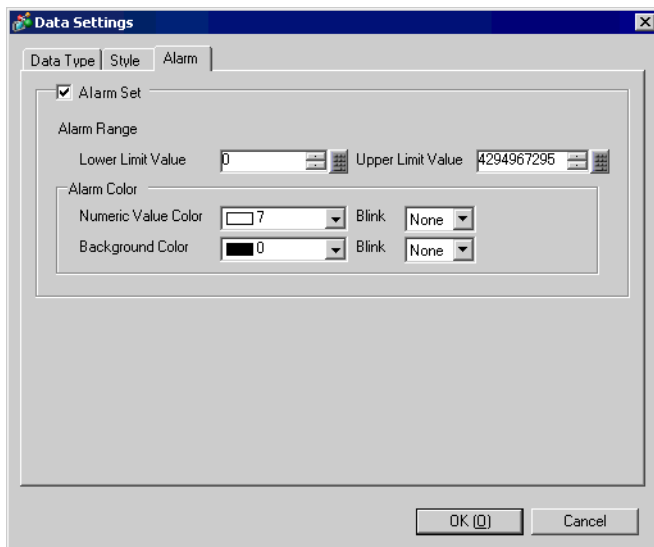

Setting	Description																	
Alarm Settings	Designate whether or not the use alarm display (change the calculation data's color when the value goes outside of the alarm range).																	
Upper Limit Value/ Lower Limit Value	Select the alarm range's upper limit value and lower limit value. <table border="1" style="margin-left: 40px;"> <thead> <tr> <th>Data Type</th> <th>Sign +/-</th> <th>Display Range</th> </tr> </thead> <tbody> <tr> <td rowspan="2">Dec</td> <td>Checked</td> <td>-2,147,483,648 to 2,147,483,647</td> </tr> <tr> <td>Unchecked</td> <td>0 to 4,294,967,295</td> </tr> <tr> <td>Hex</td> <td>—</td> <td>0 to FFFFFFFF(h)</td> </tr> <tr> <td>BCD</td> <td>—</td> <td>0 to 99,999,999</td> </tr> <tr> <td>Float</td> <td>Checked (Fixed)</td> <td>-9.9e<sup>16</sup> to 9.9e<sup>16</sup></td> </tr> </tbody> </table>	Data Type	Sign +/-	Display Range	Dec	Checked	-2,147,483,648 to 2,147,483,647	Unchecked	0 to 4,294,967,295	Hex	—	0 to FFFFFFFF(h)	BCD	—	0 to 99,999,999	Float	Checked (Fixed)	-9.9e <sup>16</sup> to 9.9e <sup>16</sup>
Data Type	Sign +/-	Display Range																
Dec	Checked	-2,147,483,648 to 2,147,483,647																
	Unchecked	0 to 4,294,967,295																
Hex	—	0 to FFFFFFFF(h)																
BCD	—	0 to 99,999,999																
Float	Checked (Fixed)	-9.9e <sup>16</sup> to 9.9e <sup>16</sup>																
Numeric Value Color	Select the numeric value color for when the Alarm is displayed.																	
Background Color	Select the background color for when the Alarm is displayed.																	
Blink	Select whether or not the Part will blink, and the blink speed. You can choose different blink settings for the Alarm's [Numeric Value Color] and [Background Color]. <p><b>NOTE</b></p> <ul style="list-style-type: none"> <li>There are cases where you can and can not set Blink depending on the Main Unit and System Settings' [Color Settings].</li> </ul> <p> "9.5.1 Specify Color ■ Supported Color List" (page 9-33)</p>																	

## ■ Display/Save in CSV (Custom Settings)

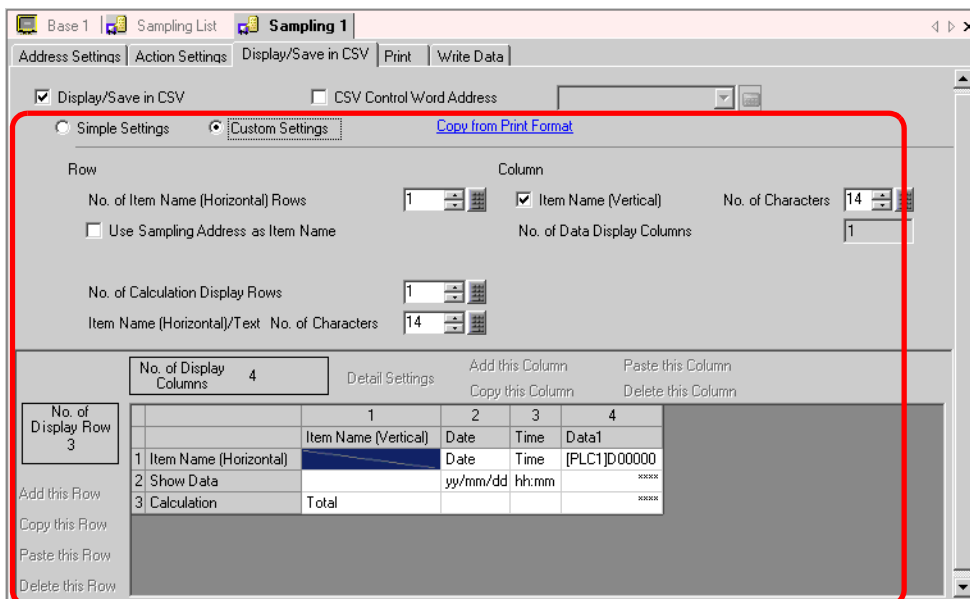

Setting		Description
Copy From Print Format		When the print format is set on the [Print] tab, copy the settings from the [Print] tab. Use this feature when you want to display/save in CSV using the print format. The border row and border column are not copied.
Row	No. of Item Name (Horizontal) Rows	The number of item name rows can be from 0 to 3. “Date” and “Time” will automatically be displayed in the first row of the Date and Time columns.
	Use Sampling Address as Item Name	If the [No. of Item Name (Horizontal) Rows] is not “0”, select whether or not to display the sampling address as the data column’s item name. If selected, cells that have an address displayed in the Preview area cannot be edited.
	No. of Data Display Rows	If [Overwrite old data after finishing the specified no. of times] is not designated on the [Action Settings] tab’s Extended Settings, set the number of data rows from 1 to the [No. of Times] set on the [Action Settings] tab. <b>IMPORTANT</b> • Adjust the number of data display rows to the [No. of Times].
	No. of Calculation Display Rows	The number of calculation rows can be from 0 to 4. In the Calculation rows, values calculated (Total, Average, Max Value, Min Value) from data from the designated [No. of Times] can be displayed. <b>NOTE</b> • When saving to the CF-card (CSV output), a calculation row will not be outputted.

Continued

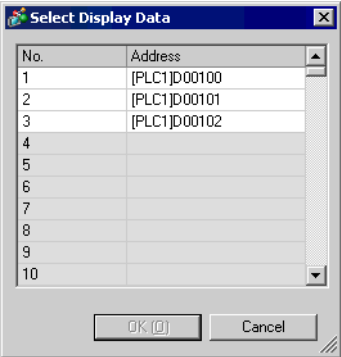
Setting		Description
Row	Item Name (Horizontal)/ Text No. of Characters	Set the number of display characters for the item names (horizontal) and text rows from 1 to 20 single-byte characters. When you double-click an item name row/text row cell in the Preview area, you can input text that is within the number of characters set here.
Column Settings	Item Name (Vertical) No. of Characters	Designate whether or not to display the item name column. If designated, set the number of item name column's characters from 1 to 20 single-byte characters. When you double-click an item name column cell in the Preview area, you can input text that is within the number of characters set here.
	No. of Data Display Columns	Displays the number of data columns.
Detail Settings		Select and click the column, calculation row, or heading row in the Preview area, and a dialog box to configure detail settings opens. <ul style="list-style-type: none"> <li>☞ “◆ Detail Settings - [Date Settings] Dialog Box” (page 24-64)</li> <li>☞ “◆ Detail Settings - [Time Settings] Dialog Box” (page 24-65)</li> <li>☞ “◆ Detail Settings - [Data Settings] Dialog Box” (page 24-66)</li> <li>☞ “◆ Detail Settings - [Text Settings] Dialog Box” (page 24-69)</li> <li>☞ “◆ Detail Settings - [Calculation Settings] Dialog Box” (page 24-70)</li> <li>☞ “◆ Detail Settings - [Item Name (Horizontal) Settings] Dialog Box” (page 24-72)</li> </ul>
Add this Column		<p>Insert a column in front of the column selected in the Preview area. Choose from a [Date], [Time], [Data], or [Text] column. You can directly input the desired text in the [Text] column. When inserting a [Data] column, the [Select Display Data] dialog box opens and you can select a data column (address) you want to add.</p> <div style="display: flex; align-items: center;"> <div style="flex: 1;">  </div> <div style="flex: 1; padding-left: 20px;"> <p>To add multiple addresses, drag the mouse to select consecutive columns. If you click columns to add while pressing the [Ctrl] key, you can select separate addresses.</p> </div> </div> <p><b>NOTE</b></p> <ul style="list-style-type: none"> <li>• When saving to the CF-card (CSV output), any [Text] columns will not be outputted. Also, one [Date] column and one [Time] column will be displayed in a fixed position even if you set multiple columns.</li> </ul>
Copy this Column		Copy the column selected in the Preview area.
Paste this Column		Insert the copied column in front of the column selected in the Preview area.
Delete this Column		Delete the column selected in the Preview area.

Continued

Setting	Description																																																																													
Add this Row	<p>Insert a [Text] row in front of the row selected in the Preview area. You can directly input the desired text in the [Text] row.</p> <p><b>NOTE</b></p> <ul style="list-style-type: none"> <li>When saving to the CF-card (CSV output), any [Text] rows will not be outputted.</li> <li>When multiple calculation rows are set, you cannot input a Text row between two calculation rows.</li> </ul>																																																																													
Copy this Row	Copy the Text row selected in the Preview area.																																																																													
Paste this Row	Insert the copied Text row in front of the row selected in the Preview area.																																																																													
Delete this Row	Delete the [Text] row selected in the Preview area.																																																																													
Preview Area	<p>Displays the set contents with the selected format.</p> <p>If [Overwrite old data after finishing the specified no. of times] is designated on the [Action Settings] tab's Extended Settings, only one data row will be displayed. If it is not designated, the data rows will equal the designated [No. of Times].</p> <p>When [Overwrite old data after finishing the specified no. of times] is set.</p> <table border="1" data-bbox="458 826 1185 915"> <thead> <tr> <th></th> <th>1</th> <th>2</th> <th>3</th> <th>4</th> <th>5</th> <th>6</th> </tr> </thead> <tbody> <tr> <td></td> <td>Item Name (Vertical)</td> <td>Date</td> <td>Time</td> <td>Data1</td> <td>Data2</td> <td>Data3</td> </tr> <tr> <td>1</td> <td>Item Name (Horizontal)</td> <td>Date</td> <td>Time</td> <td>[PLC1]D00100</td> <td>[PLC1]D00101</td> <td>[PLC1]D00102</td> </tr> <tr> <td>2</td> <td>Show Data</td> <td>No.1</td> <td>yy/mm/dd hh:mm</td> <td>xxxx</td> <td>xxxx</td> <td>xxxx</td> </tr> </tbody> </table> <p>When [Overwrite old data after finishing the specified no. of times] is not set</p> <table border="1" data-bbox="458 981 1185 1136"> <thead> <tr> <th></th> <th>1</th> <th>2</th> <th>3</th> <th>4</th> <th>5</th> <th>6</th> </tr> </thead> <tbody> <tr> <td></td> <td>Item Name (Vertical)</td> <td>Date</td> <td>Time</td> <td>Data1</td> <td>Data2</td> <td>Data3</td> </tr> <tr> <td>1</td> <td>Item Name (Horizontal)</td> <td>Date</td> <td>Time</td> <td>[PLC1]D00100</td> <td>[PLC1]D00101</td> <td>[PLC1]D00102</td> </tr> <tr> <td>2</td> <td>No.1</td> <td>No.1</td> <td>yy/mm/dd hh:mm</td> <td>xxxx</td> <td>xxxx</td> <td>xxxx</td> </tr> <tr> <td>3</td> <td>No.2</td> <td>No.2</td> <td>yy/mm/dd hh:mm</td> <td>xxxx</td> <td>xxxx</td> <td>xxxx</td> </tr> <tr> <td>4</td> <td>No.3</td> <td>No.3</td> <td>yy/mm/dd hh:mm</td> <td>xxxx</td> <td>xxxx</td> <td>xxxx</td> </tr> <tr> <td>5</td> <td>No.4</td> <td>No.4</td> <td>yy/mm/dd hh:mm</td> <td>xxxx</td> <td>xxxx</td> <td>xxxx</td> </tr> </tbody> </table>		1	2	3	4	5	6		Item Name (Vertical)	Date	Time	Data1	Data2	Data3	1	Item Name (Horizontal)	Date	Time	[PLC1]D00100	[PLC1]D00101	[PLC1]D00102	2	Show Data	No.1	yy/mm/dd hh:mm	xxxx	xxxx	xxxx		1	2	3	4	5	6		Item Name (Vertical)	Date	Time	Data1	Data2	Data3	1	Item Name (Horizontal)	Date	Time	[PLC1]D00100	[PLC1]D00101	[PLC1]D00102	2	No.1	No.1	yy/mm/dd hh:mm	xxxx	xxxx	xxxx	3	No.2	No.2	yy/mm/dd hh:mm	xxxx	xxxx	xxxx	4	No.3	No.3	yy/mm/dd hh:mm	xxxx	xxxx	xxxx	5	No.4	No.4	yy/mm/dd hh:mm	xxxx	xxxx	xxxx
	1	2	3	4	5	6																																																																								
	Item Name (Vertical)	Date	Time	Data1	Data2	Data3																																																																								
1	Item Name (Horizontal)	Date	Time	[PLC1]D00100	[PLC1]D00101	[PLC1]D00102																																																																								
2	Show Data	No.1	yy/mm/dd hh:mm	xxxx	xxxx	xxxx																																																																								
	1	2	3	4	5	6																																																																								
	Item Name (Vertical)	Date	Time	Data1	Data2	Data3																																																																								
1	Item Name (Horizontal)	Date	Time	[PLC1]D00100	[PLC1]D00101	[PLC1]D00102																																																																								
2	No.1	No.1	yy/mm/dd hh:mm	xxxx	xxxx	xxxx																																																																								
3	No.2	No.2	yy/mm/dd hh:mm	xxxx	xxxx	xxxx																																																																								
4	No.3	No.3	yy/mm/dd hh:mm	xxxx	xxxx	xxxx																																																																								
5	No.4	No.4	yy/mm/dd hh:mm	xxxx	xxxx	xxxx																																																																								

### ◆ Detail Settings - [Date Settings] Dialog Box

Select a Date column in the Preview area, click [Detail Settings], and the following dialog box will be displayed.

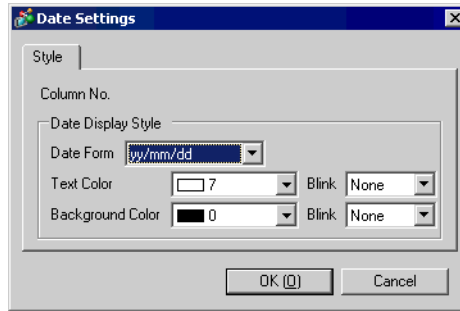

Setting	Description
Column No.	Displays the selected column's number.
Date Form	<p>Select the date display format from [yy/mm/dd], [mm/dd/yy], [dd/mm/yy], or [mm/dd]. [yy] represents the last 2 digits of the Western calendar year, and [mm] and [dd] represent the month and day, displayed as two digits.</p> <p><b>NOTE</b></p> <ul style="list-style-type: none"> <li>Regardless of the chosen display format, the [yy/mm/dd] format will be used when saving to the CF-card (CSV save).</li> </ul>
Text Color	Select the text's color.
Background Color	Select a background color for the text.
Blink	<p>Select whether or not the Part will blink, and the blink speed. You can choose different blink settings for the [Text Color], and [Background Color].</p> <p><b>NOTE</b></p> <ul style="list-style-type: none"> <li>There are cases where you can and can not set Blink depending on the Main Unit and System Settings' [Color Settings].</li> </ul> <p>☞ "9.5.1 Specify Color ■ Supported Color List" (page 9-33)</p>

### ◆ Detail Settings - [Time Settings] Dialog Box

Select a Time column in the Preview area, click [Detail Settings], and the following dialog box will be displayed.

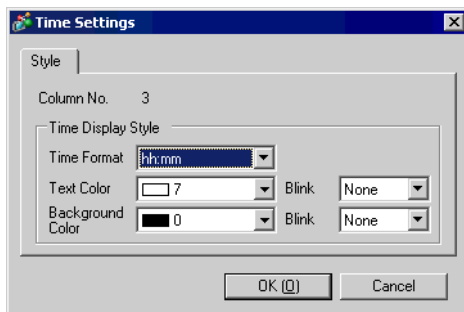

Setting	Description
Column No.	Displays the selected column's number.
Time Format	<p>Select the time display format from [hh:mm], [hh:mm:ss], or [hh:mm:ss.ms]. [hh] represents the hours, [mm] represents the minutes, [ss] represents the seconds. Each one is displayed as 2 digits. [ms] represents the milliseconds and is displayed as 3 digits.</p> <p><b>NOTE</b></p> <ul style="list-style-type: none"> <li>Regardless of the chosen display format, the [hh:mm:ss] format ([hh:mm:ss.000] when the sampling duration is set to [Milliseconds]) will be used when saving to the CF-card (CSV save).</li> </ul>
Text Color	Select the text's color.
Background Color	Select a background color for the text.
Blink	<p>Select whether or not the Part will blink, and the blink speed. You can choose different blink settings for the [Text Color], and [Background Color].</p> <p><b>NOTE</b></p> <ul style="list-style-type: none"> <li>There are cases where you can and can not set Blink depending on the Main Unit and System Settings' [Color Settings].</li> </ul> <p>☞ "9.5.1 Specify Color ■ Supported Color List" (page 9-33)</p>

◆ **Detail Settings - [Data Settings] Dialog Box**

Select a Data column in the Preview area, click [Detail Settings], and the following dialog box will be displayed.

[Data Type] Tab

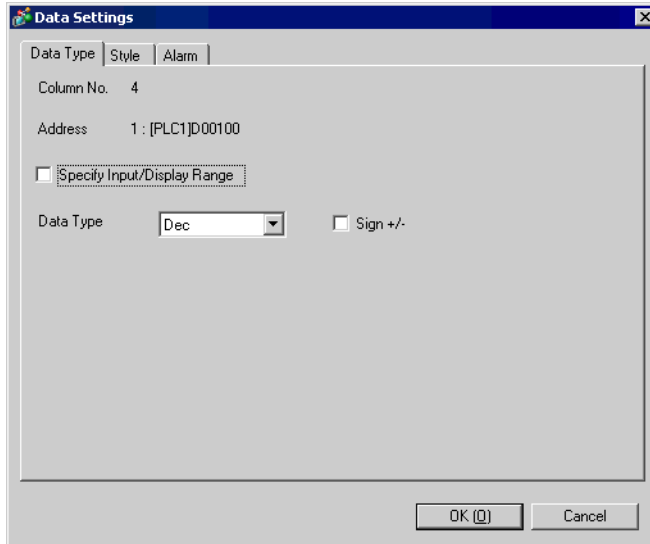

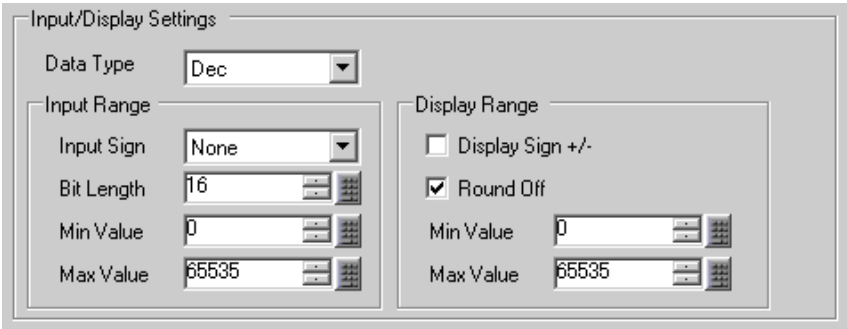
Setting	Description
Column No.	Displays the selected column's number.
Address	Displays the selected column's address.
Specify Input/Display Range	<p>Designate whether or not an input range and display range will be set. If designated, the following setting items will appear.</p>  <p><b>NOTE</b></p> <ul style="list-style-type: none"> <li>Each setting for the input range/display range is the same as [Simple Settings] mode, [Data Type Settings], in the displayed [Data Settings] dialog box.</li> </ul> <p>☞ “◆ [Data Settings] Dialog Box” (page 24-76)</p>

Continued

Setting	Description
Data Type	<p>Choose the data type from [Dec], [BCD], [Hex], or [Float]. [Float] can only be selected when the set [Bit Length] is [32 Bit] on the [Address Settings] tab.</p> <p><b>NOTE</b></p> <ul style="list-style-type: none"> <li>When [BCD] is selected, sampling data containing the digits A-F (hexadecimal) other than BCD will be displayed/saved in CSV with “----” (No. of digits “-”).</li> </ul>
Sign +/-	<p>Designate whether or not to attach a minus sign to data. This can only be set when the [Data Type] is [Dec].</p> <p><b>NOTE</b></p> <ul style="list-style-type: none"> <li>This is fixed when the [Data Type] is [Float].</li> </ul>

[Style] Tab

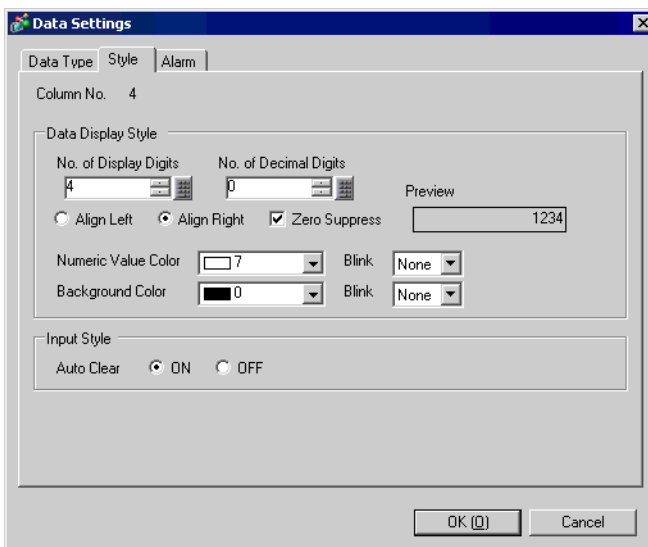

Setting	Description
No. of Display Digits	<p>Select the number of display digits for the data from 1 to 17. This can be designated to within the number of characters set in [Item Name (Vertical) No. of Characters]. The numbers displayed after the decimal point are also included in the number of digits. e.g.) When the No. of Display Digits is 5, and the No. of Decimal Digits is 2</p> <p style="text-align: center;"><input type="text" value="123.45"/></p>
No. of Decimal Digits	<p>Set the number of display digits after the decimal point, from 0 to [No. of Display Digits] - 1. This cannot be set when the [Data Type] is [Hex].</p>
Align Right/Align Left	<p>Select the data's display position.</p>

Continued

Setting	Description
Zero Suppress	<p>If this option is selected, leading zeros are not displayed. e.g.) When No. of Display Digits = 4</p> <div style="display: flex; justify-content: space-around; align-items: center;"> <div style="text-align: center;"> <input checked="" type="checkbox"/> Zero Suppress  <div style="border: 1px solid black; padding: 5px; width: 40px; margin: 5px auto;">25</div> <p>Leading zeroes are not displayed</p> </div> <div style="text-align: center;"> <input type="checkbox"/> Zero Suppress  <div style="border: 1px solid black; padding: 5px; width: 40px; margin: 5px auto;">0025</div> <p>Zeroes are added to correspond to the No. of Display Digits</p> </div> </div>
Preview	Preview the selected style.
Numeric Value Color	Set the numeric value color.
Background Color	Select a background color for the numeric values.
Blink	<p>Select whether or not the Part will blink, and the blink speed. You can choose different blink settings for the [Numeric Value Color] and [Background Color].</p> <p><b>NOTE</b></p> <ul style="list-style-type: none"> <li>• There are cases where you can and can not set Blink depending on the Main Unit and System Settings' [Color Settings].</li> </ul> <p> "9.5.1 Specify Color ■ Supported Color List" (page 9-33)</p>
Auto Clear	<p>Select whether or not to automatically clear previously inputted values when correcting data on the screen. If [ON] is set, previous values are deleted when a value is inputted, and only the new value is displayed. If [OFF] is set, previous data remains, and the new value is added to the end. e.g.) When No. of Display Digit = 3</p> <div style="display: flex; flex-direction: column; align-items: center;"> <div style="margin-bottom: 20px;"> <p>(When [ON])</p> <div style="display: flex; align-items: center; gap: 20px;"> <div style="text-align: center;"> <div style="border: 1px solid black; padding: 5px; width: 40px;">123</div> <div style="border: 1px solid black; border-radius: 50%; padding: 2px 5px; margin-top: 5px;">Touch</div> </div> <div style="font-size: 2em;">➔</div> <div style="text-align: center;"> <div style="border: 1px solid black; padding: 5px; width: 40px;">4</div> </div> </div> </div> <div> <p>(When [OFF])      Input "4" with the keypad</p> <div style="display: flex; align-items: center; gap: 20px;"> <div style="text-align: center;"> <div style="border: 1px solid black; padding: 5px; width: 40px;">123</div> <div style="border: 1px solid black; border-radius: 50%; padding: 2px 5px; margin-top: 5px;">Touch</div> </div> <div style="font-size: 2em;">➔</div> <div style="text-align: center;"> <div style="border: 1px solid black; padding: 5px; width: 40px;">234</div> </div> </div> </div> </div>

[Alarm] Tab

This is the same as the [Alarm] tab in the [Data Settings] dialog box, displayed by clicking [Data Type Settings] in [Simple Settings] mode.

"◆ [Data Settings] Dialog Box" (page 24-76)

◆ **Detail Settings - [Text Settings] Dialog Box**

Select a Text column in the Preview area, click [Detail Settings], and the following dialog box will be displayed.

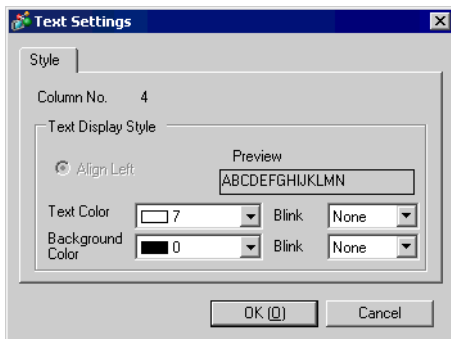

Setting	Description
Column No.	Displays the selected text's column number.
Align Left	Displays that text is fixed as Align Left.
Preview	Previews the selected text's style.
Text Color	Select the text's color.
Background Color	Select a background color for the text.
Blink	<p>Select whether or not the Part will blink, and the blink speed. You can choose different blink settings for the [Text Color], and [Background Color].</p> <p><b>NOTE</b></p> <ul style="list-style-type: none"> <li>There are cases where you can and can not set Blink depending on the Main Unit and System Settings' [Color Settings].</li> </ul> <p>☞ "9.5.1 Specify Color ■ Supported Color List" (page 9-33)</p>

### ◆ Detail Settings - [Calculation Settings] Dialog Box

Select a Calculation cell of a Calculation row or Data row in the Preview area, click [Detail Settings], and the following dialog box will be displayed.

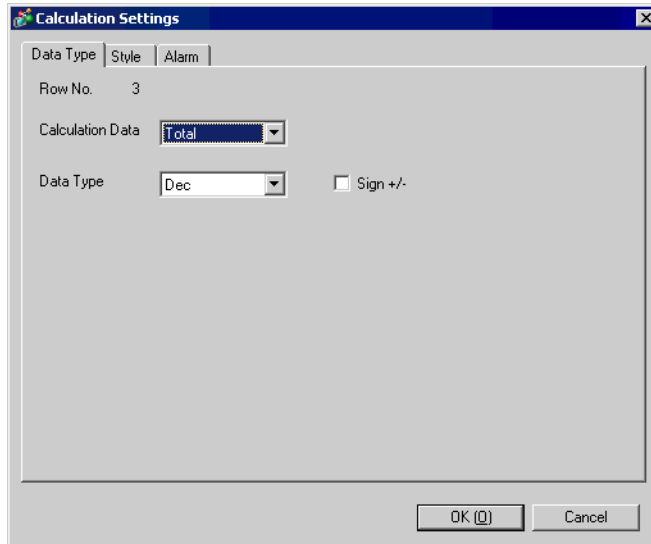

#### [Data Type] Tab

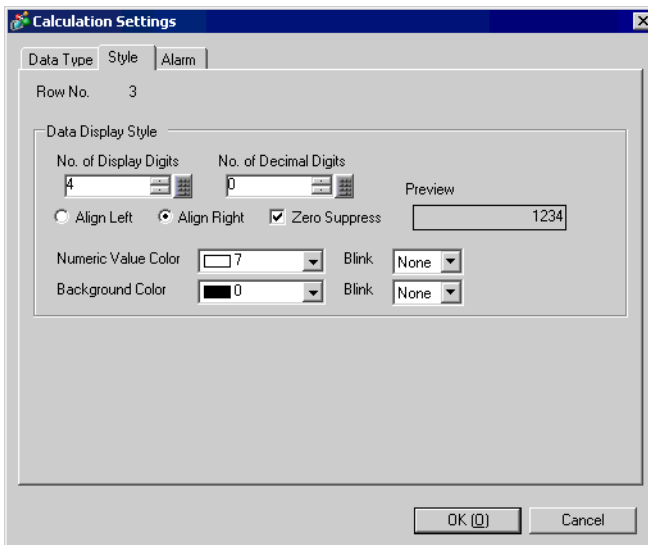

Setting	Description
Row No./Column No.	Displays the selected Calculation row or Calculation cell's row number/column number.
Calculation Data	Choose the data calculation type from [Total], [Average], [Max], or [Min]. Values calculated from the data of the designated No. of Times stored in the GP are displayed.
Data Type	Choose the data type from [Dec], [BCD], [Hex], or [Float]. [Float] can only be selected when the set [Bit Length] is [32 Bit] on the [Address Settings] tab. <b>NOTE</b> <ul style="list-style-type: none"> <li>When [BCD] is selected, sampling data containing the digits A-F (hexadecimal) other than BCD will be displayed/saved in CSV with "----" (No. of digits "-").</li> </ul>
Sign +/-	Designate whether or not to attach a minus sign to data. This can only be set when the [Data Type] is [Dec]. <b>NOTE</b> <ul style="list-style-type: none"> <li>This is fixed when the [Data Type] is [Float].</li> </ul>

[Style] Tab

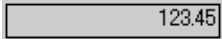
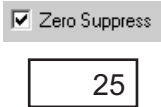
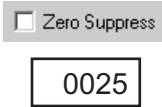

Setting	Description
No. of Display Digits	Select the number of display digits for the calculation data from 1 to 17. This can be designated to within the number of characters set in [Item Name (Horizontal)/Text No. of Characters]. The numbers displayed after the decimal point are also included in the number of digits. e.g.) When the No. of Display Digits is “5”, and the No. of Decimal Digits is “2” 
No. of Decimal Digits	Set the number of display digits after the decimal point, from 0 to [No. of Display Digits] - 1. This cannot be set when the [Data Type] is [Hex].
Align Right/Align Left	Select the calculation data’s display position.
Zero Suppress	If this option is selected, leading zeros are not displayed. e.g.) When No. of Display Digits = 4  Leading zeroes are not displayed  Zeroes are added to correspond to the No. of Display Digits
Preview	Preview the selected style.
Numeric Value Color	Set the calculation data’s color.
Background Color	Set the calculation data’s background color.
Blink	Select whether or not the Part will blink, and the blink speed. You can choose different blink settings for the [Numeric Value Color] and [Background Color]. <b>NOTE</b> • There are cases where you can and can not set Blink depending on the Main Unit and System Settings’ [Color Settings].  “9.5.1 Specify Color ■ Supported Color List” (page 9-33)

[Alarm] Tab

Same as the [Calculation Settings] dialog box which displays when you click [Total Type Settings] in the [Simple Settings] mode.

☞ “◆ [Calculation Settings] Dialog Box” (page 24-79)

◆ **Detail Settings - [Item Name (Horizontal) Settings] Dialog Box**

Select an Item Name row in the Preview area, click [Detail Settings], and the following dialog box will be displayed.

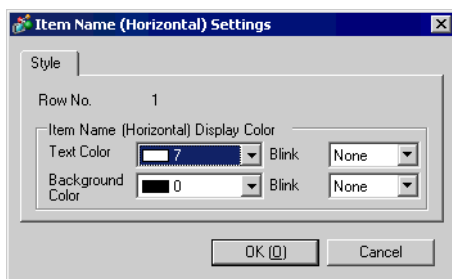

Setting	Description
Row No.	Displays the selected Item Name row's row number.
Text Color	Select the text's color.
Background Color	Select a background color for the text.
Blink	Select whether or not the Part will blink, and the blink speed. You can choose different blink settings for the [Font Color], and [Background Color]. <div style="border: 1px solid black; padding: 2px; display: inline-block; margin: 5px 0;"><b>NOTE</b></div> <ul style="list-style-type: none"> <li>• There are cases where you can and can not set Blink depending on the Main Unit and System Settings' [Color Settings].</li> </ul> <p>☞ “24.9.4 Saving to the CF-Card” (page 24-116)</p>

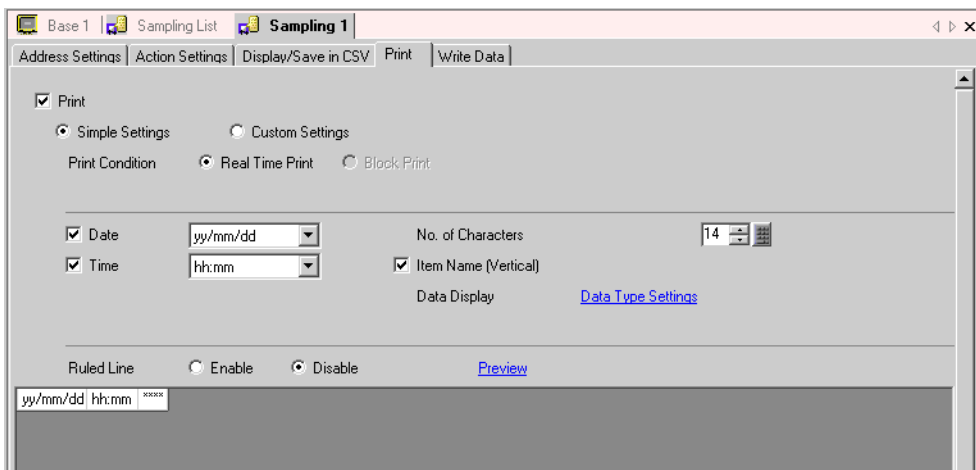

## ■ Print

Set the format for printing sampling data from a printer connected to the GP.  
 The following is a settings guide for [Simple Settings]. For [Custom Settings], please refer to “ ■ Print (Custom Settings)” (page 24-80) .



Setting	Description
Print	Select whether or not to print. When printing sampling data, ensure that this option is checked, and select the print format. ☞ “24.9.5 Printing” (page 24-119)
Simple Settings/ Custom Settings	Select the print format’s setting mode. <ul style="list-style-type: none"> <li>• Simple Settings Use a preset format to easily configure settings.</li> <li>• Custom Settings Set a customized format.</li> </ul>
Print Condition	Select the print timing. <ul style="list-style-type: none"> <li>• Block Print Data is printed in block units. This can only be set when [Overwrite old data after finishing the specified no. of times] is not designated on the [Action Settings] tab’s Extended Settings. Printing is started via the [Print Control Word Address].</li> </ul> <div style="border: 1px solid gray; padding: 5px; width: fit-content; margin: 10px auto;"> <input checked="" type="radio"/> Block Print    Print Control Word Address: [PLC1]D00000                           Print Completion Bit Address: [PLC1]X00000     </div>
Print Control Word Address	When the [Print Condition] is set to [Block Print], select an address to control the start of printing. When the designated address’ 0 bit turns ON the printing starts. Two sequential words are automatically used to store the word address: the control word and the block number. Select the block number and start the printing. <div style="text-align: center; margin-top: 10px;"> </div>

Continued

Setting	Description
Print Completion Bit Address	When the [Print Condition] is set to [Block Print], select an address to confirm the completion of the printing. Designates the Bit Address to be turned ON at the end of printing, when data is printed out for each block. After confirming that this Bit Address is turned ON, perform the next printing.
Date	Select whether or not the date will be printed, and if selected choose the display format from [yy/mm/dd], [mm/dd/yy], [dd/mm/yy], or [mm/dd]. [yy] represents the last 2 digits of the Western calendar year, and [mm] and [dd] represent the month and day, displayed as two digits.
Time	Select whether or not the time will be printed, and if selected choose the display format from [hh:mm], [hh:mm:ss], or [hh:mm:ss.ms]. [hh] represents the hours, [mm] represents the minutes, [ss] represents the seconds. Each one is displayed as 2 digits. [ms] represents the milliseconds and is displayed as 3 digits.
No. of Characters	If [Overwrite old data after finishing the specified no. of times] is designated on the [Action Settings] tab's Extended Settings, set the number of characters to display in a cell.
Item Name (Horizontal) No. of Characters	If [Overwrite old data after finishing the specified no. of times] is not designated on the [Action Settings] tab's Extended Settings, designate whether or not to print the Item Name row. If printing, the block name's number of characters can be from 1 to 20 (single-byte). For the Date and Time columns, the item names will be printed as [Date] and [Time]. For a Data column, the address will be printed.
Item Name (Vertical)	Select whether or not the Item Name column will be printed.
Data Display	Click [Data Type Settings] to open the [Data Settings] dialog box. The data type, input range, number of display digits, etc. can now be set.  " ◆ [Data Settings] Dialog Box" (page 24-76)
Total	If [Overwrite old data after finishing the specified no. of times] is not designated on the [Action Settings] tab's Extended Settings, designate whether or not to print the Total row. Click on [Data Type Settings] and open the [Calculation Settings] dialog box. The number of display digits for the Totals rows can now be set.  " ◆ [Calculation Settings] Dialog Box" (page 24-79)
Ruled Line	Select whether or not the ruled line will be printed.
Preview	Opens a preview screen to confirm the print image.

Continued

Setting	Description																																																																	
Preview Area	<p>Displays the set contents with the selected print format.                      If [Overwrite old data after finishing the specified no. of times] is designated on the [Action Settings] tab's Extended Settings, only one data row will be displayed. If it is not designated, the data rows will equal the designated [No. of Times].</p> <p>When [Overwrite old data after finishing the specified no. of times] is set</p>																																																																	
	<div style="border: 1px solid black; padding: 2px; width: fit-content; margin: 0 auto;">             yy/mm/dd hh:mm **** *           </div>																																																																	
	<p>When [Overwrite old data after finishing the specified no. of times] is not set</p>																																																																	
<table border="1" style="width: 100%; border-collapse: collapse; text-align: center;"> <thead> <tr> <th style="width: 5%;"></th> <th style="width: 15%;">Date</th> <th style="width: 15%;">Time</th> <th style="width: 20%;">[PLC1]D00100</th> <th style="width: 20%;">[PLC1]D00101</th> <th style="width: 20%;">[PLC1]D00102</th> </tr> </thead> <tbody> <tr><td>No.1</td><td>yy/mm/dd</td><td>hh:mm</td><td>****</td><td>****</td><td>****</td></tr> <tr><td>No.2</td><td>yy/mm/dd</td><td>hh:mm</td><td>****</td><td>****</td><td>****</td></tr> <tr><td>No.3</td><td>yy/mm/dd</td><td>hh:mm</td><td>****</td><td>****</td><td>****</td></tr> <tr><td>No.4</td><td>yy/mm/dd</td><td>hh:mm</td><td>****</td><td>****</td><td>****</td></tr> <tr><td>No.5</td><td>yy/mm/dd</td><td>hh:mm</td><td>****</td><td>****</td><td>****</td></tr> <tr><td>No.6</td><td>yy/mm/dd</td><td>hh:mm</td><td>****</td><td>****</td><td>****</td></tr> <tr><td>No.7</td><td>yy/mm/dd</td><td>hh:mm</td><td>****</td><td>****</td><td>****</td></tr> <tr><td>No.8</td><td>yy/mm/dd</td><td>hh:mm</td><td>****</td><td>****</td><td>****</td></tr> <tr><td>No.9</td><td>yy/mm/dd</td><td>hh:mm</td><td>****</td><td>****</td><td>****</td></tr> <tr><td>No.10</td><td>yy/mm/dd</td><td>hh:mm</td><td>****</td><td>****</td><td>****</td></tr> </tbody> </table>		Date	Time	[PLC1]D00100	[PLC1]D00101	[PLC1]D00102	No.1	yy/mm/dd	hh:mm	****	****	****	No.2	yy/mm/dd	hh:mm	****	****	****	No.3	yy/mm/dd	hh:mm	****	****	****	No.4	yy/mm/dd	hh:mm	****	****	****	No.5	yy/mm/dd	hh:mm	****	****	****	No.6	yy/mm/dd	hh:mm	****	****	****	No.7	yy/mm/dd	hh:mm	****	****	****	No.8	yy/mm/dd	hh:mm	****	****	****	No.9	yy/mm/dd	hh:mm	****	****	****	No.10	yy/mm/dd	hh:mm	****	****	****
	Date	Time	[PLC1]D00100	[PLC1]D00101	[PLC1]D00102																																																													
No.1	yy/mm/dd	hh:mm	****	****	****																																																													
No.2	yy/mm/dd	hh:mm	****	****	****																																																													
No.3	yy/mm/dd	hh:mm	****	****	****																																																													
No.4	yy/mm/dd	hh:mm	****	****	****																																																													
No.5	yy/mm/dd	hh:mm	****	****	****																																																													
No.6	yy/mm/dd	hh:mm	****	****	****																																																													
No.7	yy/mm/dd	hh:mm	****	****	****																																																													
No.8	yy/mm/dd	hh:mm	****	****	****																																																													
No.9	yy/mm/dd	hh:mm	****	****	****																																																													
No.10	yy/mm/dd	hh:mm	****	****	****																																																													

◆ [Data Settings] Dialog Box

[Data Type] Tab

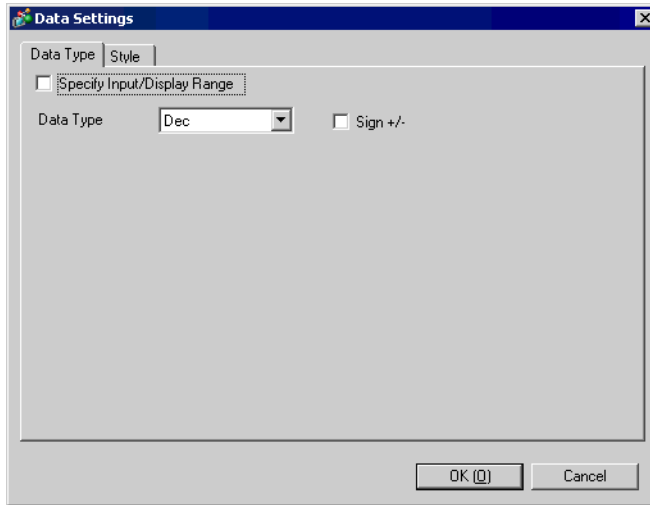

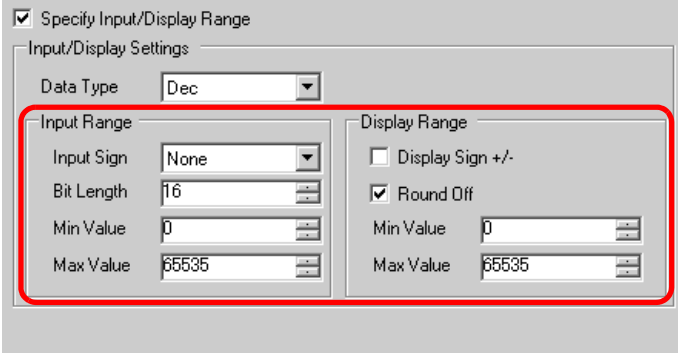
Setting	Description
Specify Input/Display Range	<p>Designate whether or not an input range and display range of the data will be set. If designated, the following setting items will appear.</p> 
Data Type	<p>Choose the data type from [Dec], [BCD], [Hex], or [Float]. [Float] can only be selected when the set [Bit Length] is [32 Bit] on the [Address Settings] tab.</p> <p><b>NOTE</b></p> <ul style="list-style-type: none"> <li>When [BCD] is selected, sampling data containing the digits A-F (hexadecimal) other than BCD will be displayed/saved in CSV with "----" (No. of digits "-").</li> </ul>
Sign +/-	<p>Designate whether or not to attach a minus sign to data. This can only be set when the [Data Type] is [Dec].</p> <p><b>NOTE</b></p> <ul style="list-style-type: none"> <li>This is fixed when the [Data Type] is [Float].</li> </ul>

Continued

Setting		Description																																		
Input Range	Input Sign	<p>If [Specify Input/Display Range] is designated and [Data Type] is [Dec], select whether or not to handle negative numbers.</p> <ul style="list-style-type: none"> <li>• None Only positive numeric data.</li> <li>• 2's Complement Negative numbers are handled with 2's complement.</li> <li>• MSB Sign Negative numbers are handled with MSB sign (highest bit).</li> </ul>																																		
	Bit Length	If [Specify Input/Display Range] is designated and [Bit Length] is [16 Bit] on the [Address Settings] tab, set the bit length for one word from 1 to 16.																																		
	Min Value/ Max Value	<p>If [Specify Input/Display Range] is designated, set the data's input range. Each [Data Type] and [Input Sign] has a different size range.</p> <table border="1"> <thead> <tr> <th>Bit Length</th> <th>Data Type</th> <th>Input Sign</th> <th>Input Range</th> </tr> </thead> <tbody> <tr> <td rowspan="4">16 Bit</td> <td rowspan="3">Dec</td> <td>None</td> <td>0 to 65,535</td> </tr> <tr> <td>2's Complement</td> <td>-32,768 to 32,767</td> </tr> <tr> <td>MSB Sign</td> <td>-32,767 to 32,767</td> </tr> <tr> <td>Hex</td> <td>—</td> <td>0 to FFFF(h)</td> </tr> <tr> <td>BCD</td> <td>—</td> <td>0 to 9,999</td> </tr> <tr> <td rowspan="5">32 Bit</td> <td rowspan="3">Dec</td> <td>None</td> <td>0 to 4,294,967,295</td> </tr> <tr> <td>2's Complement</td> <td>-2,147,483,648 to 2,147,483,647</td> </tr> <tr> <td>MSB Sign</td> <td>-2,147,483,647 to 2,147,483,647</td> </tr> <tr> <td>Hex</td> <td>—</td> <td>0 to FFFFFFFF(h)</td> </tr> <tr> <td>BCD</td> <td>—</td> <td>0 to 99,999,999</td> </tr> <tr> <td>Float</td> <td>—</td> <td>-9.9e<sup>16</sup> to 9.9e<sup>16</sup></td> </tr> </tbody> </table> <p>If [Specify Input/Display Range] is designated, Min. Value/Max. Value for the [Display Range] is displayed.</p>	Bit Length	Data Type	Input Sign	Input Range	16 Bit	Dec	None	0 to 65,535	2's Complement	-32,768 to 32,767	MSB Sign	-32,767 to 32,767	Hex	—	0 to FFFF(h)	BCD	—	0 to 9,999	32 Bit	Dec	None	0 to 4,294,967,295	2's Complement	-2,147,483,648 to 2,147,483,647	MSB Sign	-2,147,483,647 to 2,147,483,647	Hex	—	0 to FFFFFFFF(h)	BCD	—	0 to 99,999,999	Float	—
Bit Length	Data Type	Input Sign	Input Range																																	
16 Bit	Dec	None	0 to 65,535																																	
		2's Complement	-32,768 to 32,767																																	
		MSB Sign	-32,767 to 32,767																																	
	Hex	—	0 to FFFF(h)																																	
BCD	—	0 to 9,999																																		
32 Bit	Dec	None	0 to 4,294,967,295																																	
		2's Complement	-2,147,483,648 to 2,147,483,647																																	
		MSB Sign	-2,147,483,647 to 2,147,483,647																																	
	Hex	—	0 to FFFFFFFF(h)																																	
	BCD	—	0 to 99,999,999																																	
Float	—	-9.9e <sup>16</sup> to 9.9e <sup>16</sup>																																		
Display Range	Display Sign +/-	If [Specify Input/Display Range] is designated and [Data Type] is [Dec], select whether or not to attach a sign to display data. This is fixed when the [Data Type] is [Float].																																		
	Round Off	Designate whether or not to round off fractions when converting input values to the display range. Fractions will be discarded if rounding off is not selected																																		
	Min Value/ Max Value	<p>If [Specify an Input/Display Range] is designated, select a Min Value/Max Value for the display range. The settings range is different, depending on the [Data Type] and whether [Display Sign +/-] is set.</p> <table border="1"> <thead> <tr> <th>Bit Length</th> <th>Data Type</th> <th>Display Sign +/-</th> <th>Display Range</th> </tr> </thead> <tbody> <tr> <td rowspan="3">16 Bit</td> <td rowspan="2">Dec</td> <td>Checked</td> <td>-32,768 to 32,767</td> </tr> <tr> <td>Unchecked</td> <td>0 to 65,535</td> </tr> <tr> <td>Hex</td> <td>—</td> <td>0 to FFFF(h)</td> </tr> <tr> <td>BCD</td> <td>—</td> <td>0 to 9,999</td> </tr> <tr> <td rowspan="4">32 Bit</td> <td rowspan="2">Dec</td> <td>Checked</td> <td>-2,147,483,648 to 2,147,483,647</td> </tr> <tr> <td>Unchecked</td> <td>0 to 4,294,967,295</td> </tr> <tr> <td>Hex</td> <td>—</td> <td>0 to FFFFFFFF(h)</td> </tr> <tr> <td>BCD</td> <td>—</td> <td>0 to 99,999,999</td> </tr> <tr> <td>Float</td> <td>Checked (Fixed)</td> <td>-9.9e<sup>16</sup> to 9.9e<sup>16</sup></td> </tr> </tbody> </table>	Bit Length	Data Type	Display Sign +/-	Display Range	16 Bit	Dec	Checked	-32,768 to 32,767	Unchecked	0 to 65,535	Hex	—	0 to FFFF(h)	BCD	—	0 to 9,999	32 Bit	Dec	Checked	-2,147,483,648 to 2,147,483,647	Unchecked	0 to 4,294,967,295	Hex	—	0 to FFFFFFFF(h)	BCD	—	0 to 99,999,999	Float	Checked (Fixed)	-9.9e <sup>16</sup> to 9.9e <sup>16</sup>			
Bit Length	Data Type	Display Sign +/-	Display Range																																	
16 Bit	Dec	Checked	-32,768 to 32,767																																	
		Unchecked	0 to 65,535																																	
	Hex	—	0 to FFFF(h)																																	
BCD	—	0 to 9,999																																		
32 Bit	Dec	Checked	-2,147,483,648 to 2,147,483,647																																	
		Unchecked	0 to 4,294,967,295																																	
	Hex	—	0 to FFFFFFFF(h)																																	
	BCD	—	0 to 99,999,999																																	
Float	Checked (Fixed)	-9.9e <sup>16</sup> to 9.9e <sup>16</sup>																																		

[Style] Tab

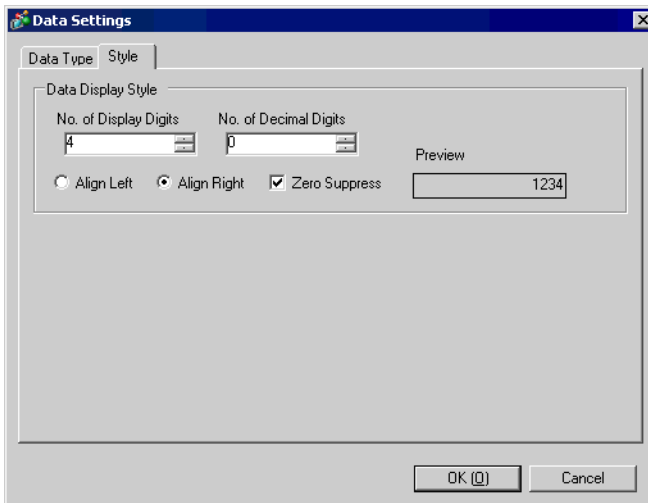

Setting	Description
No. of Display Digits	Select the number of display digits for the data from 1 to 17. This can be designated to within the number of characters set in [No. of Characters] or [Item Name (Horizontal) No. of Characters]. The numbers displayed after the decimal point are also included in the number of digits. e.g.) When the No. of Display Digits is 5, and the No. of Decimal Digits is 2 <div style="text-align: center; margin-top: 10px;"> <span style="border: 1px solid black; padding: 2px 10px;">123.45</span> </div>
No. of Decimal Digits	Set the number of display digits after the decimal point, from 0 to [No. of Display Digits] – 1. This cannot be set when the [Data Type] is [Hex].
Align Right/Align Left	Select the data's display position.
Zero Suppress	If this option is selected, leading zeroes are not displayed. e.g.) When No. of Display Digits = 4 <div style="display: flex; justify-content: space-around; align-items: center; margin-top: 10px;"> <div style="text-align: center;"> <input checked="" type="checkbox"/> Zero Suppress  <span style="border: 1px solid black; padding: 2px 10px;">25</span>                          Leading zeroes are not displayed                     </div> <div style="text-align: center;"> <input type="checkbox"/> Zero Suppress  <span style="border: 1px solid black; padding: 2px 10px;">0025</span>                          Zeroes are added to correspond to the No. of Display Digits                     </div> </div>
Preview	Preview the selected style.

◆ **[Calculation Settings] Dialog Box**

To display a Total row, click [Data Type Settings] and the [Calculation Settings] dialog box opens.

**[Data Type] Tab**

The [Total] row's data type conforms to the settings in the [Data Settings] dialog box. (There is no item to set on this tab.)

**[Style] Tab**

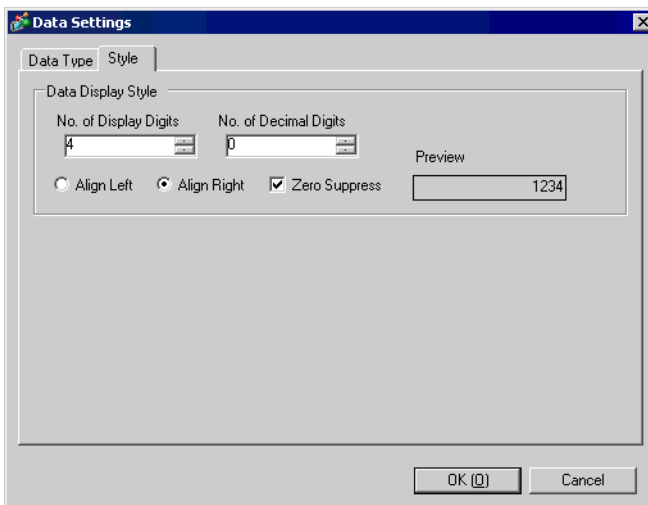

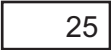
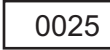
Setting	Description
No. of Display Digits	Select the number of display digits for the calculation data from 1 to 17. This can be designated to within the number of characters set in [Item Name (Horizontal) No. of Characters]. The numbers displayed after the decimal point are also included in the number of digits. e.g.) When the No. of Display Digits is 5, and the No. of Decimal Digits is 2 
No. of Decimal Digits	Set the number of display digits after the decimal point for the calculation data, from 0 to [No. of Display Digits] – 1. This cannot be set when the [Data Type] is [Hex].
Align Right/Align Left	Select the calculation data's display position.
Zero Suppress	If this option is selected, leading zeros are not displayed. e.g.) When No. of Display Digits = 4 <div style="display: flex; justify-content: space-around; align-items: center;"> <div style="text-align: center;"> <input checked="" type="checkbox"/> Zero Suppress                        Leading zeroes are not displayed                 </div> <div style="text-align: center;"> <input type="checkbox"/> Zero Suppress                        Zeroes are added to correspond to the No. of Display Digits                 </div> </div>
Preview	Preview the selected style.

## ■ Print (Custom Settings)

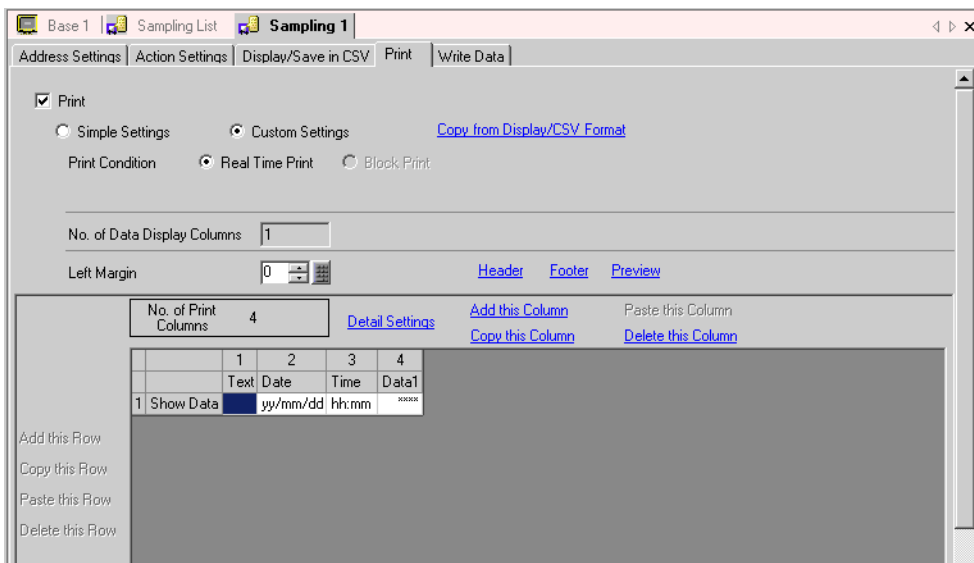

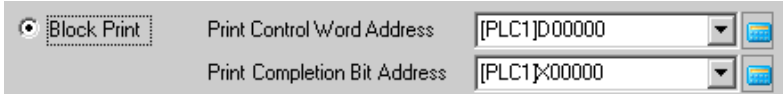
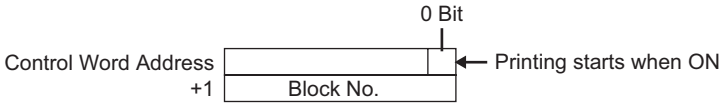
Setting	Description
Print Condition	<p>Select the print timing.</p> <ul style="list-style-type: none"> <li>• Real Time Print Printing is performed every time sampling occurs.</li> <li>• Block Print Data is printed in block units. This can only be set when [Overwrite old data after finishing the specified no. of times] is not designated on the [Action Settings] tab's Extended Settings. Printing is started via the [Print Control Word Address].</li> </ul> 
Print Control Word Address	<p>When the [Print Condition] is set to [Block Print], select an address to control the printing. When the designated address' 0 bit turns ON the printing starts. Two sequential words are automatically used to store the word address: the control word and the block number. Select the block number and start the printing.</p> 
Print Completion Bit Address	<p>When the [Print Condition] is set to [Block Print], select an address to confirm the completion of the printing. Designates the Bit Address to be turned ON at the end of printing, when data is printed out for each block. After confirming that this Bit Address is turned ON, perform the next printing.</p>

Continued

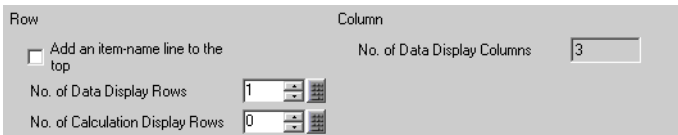
Setting	Description
Copy from Display/CSV Format	<p>When the format is set on the [Display/Save in CSV] tab, copy the settings from the [Display/Save in CSV] tab. Use this feature when you want to print data using the Display/Save in CSV format.</p> <p><b>NOTE</b></p> <ul style="list-style-type: none"> <li>The Display/Save in CSV format's Item Name (Horizontal)/Block Name (Vertical) are handled as a Text row/Text column in the print settings.</li> </ul>
No. of Data Display Columns	Displays the number of data columns.
Row/Column	<p>You can set the following items when [Overwrite old data after finishing the specified no. of times] is not designated on the [Action Settings] tab's Extended Settings.</p> 
Add an item-name line to the top	Designate whether or not to add text rows on top of the Data row. The sampling addresses are automatically displayed in the editing area as the Data columns' Item Names. Cells that have an address displayed cannot be edited.
No. of Data Display Rows	<p>Set the number of data rows to print from 1 to the [No. of Times] set on the [Action Settings] tab.</p> <p><b>IMPORTANT</b></p> <ul style="list-style-type: none"> <li>Adjust the number of data display rows to the [No. of Times].</li> </ul>
No. of Calculation Display Rows	The number of calculation rows can be from 0 to 4. In the Calculation rows, values calculated (Total, Average, Max Value, Min Value) from data from the designated [No. of Times] can be displayed.
No. of Data Display Columns	Displays the number of data columns.
Left Margin	The left margin when printing can be from 0 to 80 single-byte characters.
Detail Settings	<p>Opens up a dialog box to configure detail settings for the column or Calculation row selected in the Preview area.</p> <ul style="list-style-type: none"> <li>☞ “◆ Detail Settings - [Date Settings] Dialog Box” (page 24-83)</li> <li>☞ “◆ Detail Settings - [Time Settings] Dialog Box” (page 24-83)</li> <li>☞ “◆ Detail Settings - [Data Settings] Dialog Box” (page 24-84)</li> <li>☞ “◆ Detail Settings - [Text Settings] Dialog Box” (page 24-86)</li> <li>☞ “◆ Detail Settings - [Calculation Settings] Dialog Box” (page 24-87)</li> </ul>
Header/Footer	<p>Opens the [Edit Header]/[Edit Footer] dialog box. Input text you wish to print as a header/footer. The number of characters that can be entered is 160 char./line × 40 lines.</p> <p><b>IMPORTANT</b></p> <ul style="list-style-type: none"> <li>When [Overwrite old data when designated block count finishes] is set in the Action Settings, printing will not be performed even if the Header/Footer is set. Only the Data rows will be printed.</li> </ul>
Preview	Opens a preview screen to confirm the print image.

Continued

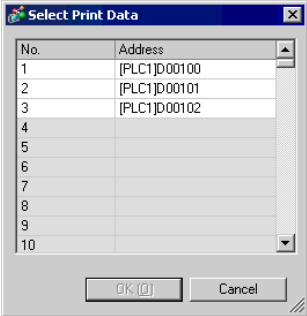
Setting	Description																																																																						
<p>Add this Column</p>	<p>Insert a column in front of the column selected in the Preview area. Choose from a [Date], [Time], [Data], [Text], or [Ruled Line] column. You can directly input the desired text in each cell of an inserted [Text] column.</p> <p>When adding a [Data] column, the [Select Print Data] dialog box opens and you can select a data column (address) you want to add.</p>  <p>To add multiple addresses, drag the mouse to select consecutive columns. If you click columns to add while pressing the [Ctrl] key, you can select separate addresses.</p>																																																																						
<p>Copy this Column</p>	<p>Copy the column selected in the Preview area.</p>																																																																						
<p>Paste this Column</p>	<p>Insert the copied column in front of the column selected in the Preview area.</p>																																																																						
<p>Delete this Column</p>	<p>Delete the column selected in the Preview area.</p>																																																																						
<p>Add this Row</p>	<p>Insert a [Text] or [Ruled Line] row in front of the row selected in the Preview area. You can directly input the desired text in each cell of an inserted [Text] row.</p> <p><b>NOTE</b></p> <ul style="list-style-type: none"> <li>When multiple calculation rows are set, you cannot input a [Text] row between two calculation rows.</li> </ul>																																																																						
<p>Copy this Row</p>	<p>Copy the [Text] or [Ruled Line] row selected in the Preview area.</p>																																																																						
<p>Paste this Row</p>	<p>Insert the copied row in front of the row selected in the Preview area.</p>																																																																						
<p>Delete this Row</p>	<p>Delete the [Text] or [Ruled Line] row selected in the Preview area.</p>																																																																						
<p>Preview Area</p>	<p>Displays the set contents with the selected format. If [Overwrite old data after finishing the specified no. of times] is designated on the [Action Settings] tab's Extended Settings, only one data row will be displayed. If it is not designated, the data rows will equal the designated [No. of Times].</p> <p>When [Overwrite old data after finishing the specified no. of times] is set</p> <table border="1" data-bbox="436 1414 1029 1510"> <thead> <tr> <th></th> <th>1</th> <th>2</th> <th>3</th> <th>4</th> <th>5</th> <th>6</th> </tr> <tr> <th></th> <th>Item Name</th> <th>Date</th> <th>Time</th> <th>Data1</th> <th>Data2</th> <th>Data3</th> </tr> </thead> <tbody> <tr> <td>1 Show Data</td> <td></td> <td>yy/mm/dd</td> <td>hh:mm</td> <td>xxxx</td> <td>xxxx</td> <td>xxxx</td> </tr> </tbody> </table> <p>When [Overwrite old data after finishing the specified no. of times] is not set</p> <table border="1" data-bbox="436 1607 1251 1785"> <thead> <tr> <th></th> <th>1</th> <th>2</th> <th>3</th> <th>4</th> <th>5</th> <th>6</th> </tr> <tr> <th></th> <th>Item Name (Vertical)</th> <th>Date</th> <th>Time</th> <th>Data1</th> <th>Data2</th> <th>Data3</th> </tr> </thead> <tbody> <tr> <td>1 Item Name (Horizontal)</td> <td></td> <td>Date</td> <td>Time</td> <td>[PLC1]D00100</td> <td>[PLC1]D00101</td> <td>[PLC1]D00102</td> </tr> <tr> <td>2 No.1</td> <td>No.1</td> <td>yy/mm/dd</td> <td>hh:mm</td> <td>xxxx</td> <td>xxxx</td> <td>xxxx</td> </tr> <tr> <td>3 No.2</td> <td>No.2</td> <td>yy/mm/dd</td> <td>hh:mm</td> <td>xxxx</td> <td>xxxx</td> <td>xxxx</td> </tr> <tr> <td>4 No.3</td> <td>No.3</td> <td>yy/mm/dd</td> <td>hh:mm</td> <td>xxxx</td> <td>xxxx</td> <td>xxxx</td> </tr> <tr> <td>5 No.4</td> <td>No.4</td> <td>yy/mm/dd</td> <td>hh:mm</td> <td>xxxx</td> <td>xxxx</td> <td>xxxx</td> </tr> </tbody> </table>		1	2	3	4	5	6		Item Name	Date	Time	Data1	Data2	Data3	1 Show Data		yy/mm/dd	hh:mm	xxxx	xxxx	xxxx		1	2	3	4	5	6		Item Name (Vertical)	Date	Time	Data1	Data2	Data3	1 Item Name (Horizontal)		Date	Time	[PLC1]D00100	[PLC1]D00101	[PLC1]D00102	2 No.1	No.1	yy/mm/dd	hh:mm	xxxx	xxxx	xxxx	3 No.2	No.2	yy/mm/dd	hh:mm	xxxx	xxxx	xxxx	4 No.3	No.3	yy/mm/dd	hh:mm	xxxx	xxxx	xxxx	5 No.4	No.4	yy/mm/dd	hh:mm	xxxx	xxxx	xxxx
	1	2	3	4	5	6																																																																	
	Item Name	Date	Time	Data1	Data2	Data3																																																																	
1 Show Data		yy/mm/dd	hh:mm	xxxx	xxxx	xxxx																																																																	
	1	2	3	4	5	6																																																																	
	Item Name (Vertical)	Date	Time	Data1	Data2	Data3																																																																	
1 Item Name (Horizontal)		Date	Time	[PLC1]D00100	[PLC1]D00101	[PLC1]D00102																																																																	
2 No.1	No.1	yy/mm/dd	hh:mm	xxxx	xxxx	xxxx																																																																	
3 No.2	No.2	yy/mm/dd	hh:mm	xxxx	xxxx	xxxx																																																																	
4 No.3	No.3	yy/mm/dd	hh:mm	xxxx	xxxx	xxxx																																																																	
5 No.4	No.4	yy/mm/dd	hh:mm	xxxx	xxxx	xxxx																																																																	

### ◆ Detail Settings - [Date Settings] Dialog Box

Select the Date column, click [Detail Settings] and the following dialog box will be displayed.

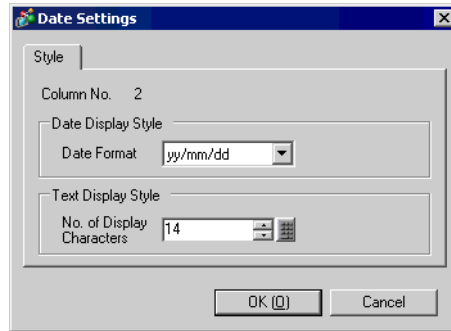

Setting	Description
Column No.	Displays the selected column's number.
Date Format	Select the date display format from [yy/mm/dd], [mm/dd/yy], [dd/mm/yy], or [mm/dd]. [yy] represents the last 2 digits of the Western calendar year, and [mm] and [dd] represent the month and day, displayed as two digits.
No. of Display Characters	Set the number of characters to be displayed in the Date column's cells from 1 to 20 single-byte characters.

### ◆ Detail Settings - [Time Settings] Dialog Box

Select the Time column, click [Detail Settings] and the following dialog box will be displayed.

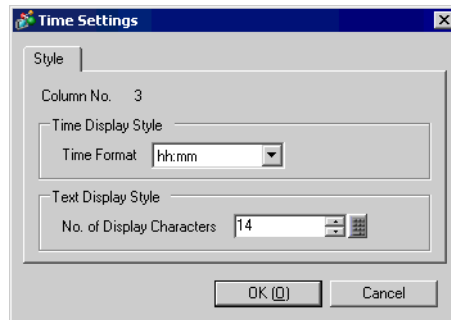

Setting	Description
Column No.	Displays the selected column's number.
Time Format	Select the time display format from [hh:mm], [hh:mm:ss], or [hh:mm:ss.ms]. [hh] represents the hours, [mm] represents the minutes, [ss] represents the seconds. Each one is displayed as 2 digits. [ms] represents the milliseconds and is displayed as 3 digits.
No. of Display Characters	Set the number of characters to be displayed in the Time column's cells from 1 to 20 single-byte characters.

◆ **Detail Settings - [Data Settings] Dialog Box**

Select a Data column in the Preview area, click [Detail Settings], and the following dialog box will be displayed.

[Data Type] Tab

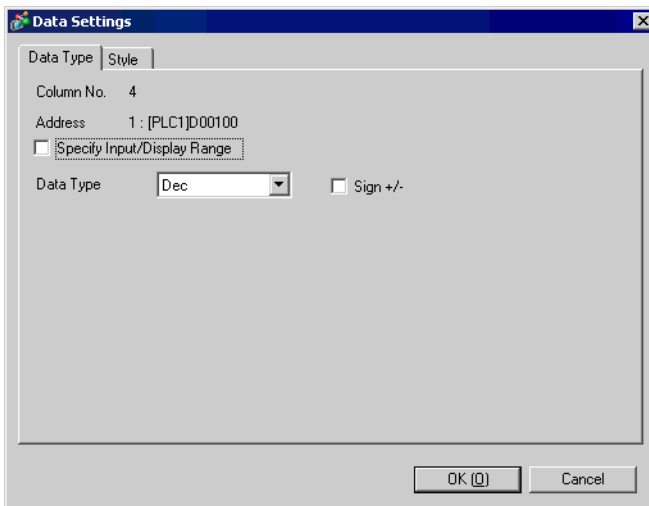

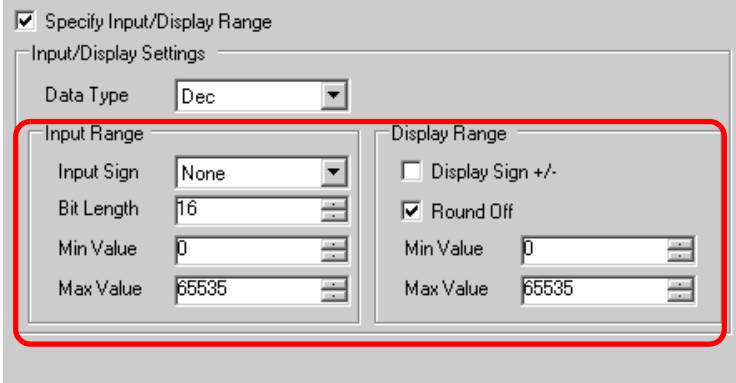
Setting	Description
Column No.	Displays the selected column's number.
Address	Displays the selected column's address.
Specify Input/Display Range	<p>Designate whether or not an input range and display range will be set. If designated, the following setting items will appear..</p>  <p><b>NOTE</b></p> <ul style="list-style-type: none"> <li>• Each setting for the input range/display range is the same as [Simple Settings] mode, [Data Type Settings], in the displayed [Data Settings] dialog box.</li> </ul> <p>☞ “◆ [Data Settings] Dialog Box” (page 24-76)</p>

Continued

Setting	Description
Data Type	<p>Choose the data type from [Dec], [BCD], [Hex], or [Float]. [Float] can only be selected when the set [Bit Length] is [32 Bit] on the [Address Settings] tab.</p> <p><b>NOTE</b></p> <ul style="list-style-type: none"> <li>When [BCD] is selected, sampling data containing the digits A-F (hexadecimal) other than BCD will be displayed/saved in CSV with “----” (No. of digits “-”).</li> </ul>
Sign +/-	<p>Designate whether or not to attach a minus sign to data. This can only be set when the [Data Type] is [Dec].</p> <p><b>NOTE</b></p> <ul style="list-style-type: none"> <li>This is fixed when the [Data Type] is [Float].</li> </ul>

[Style] Tab

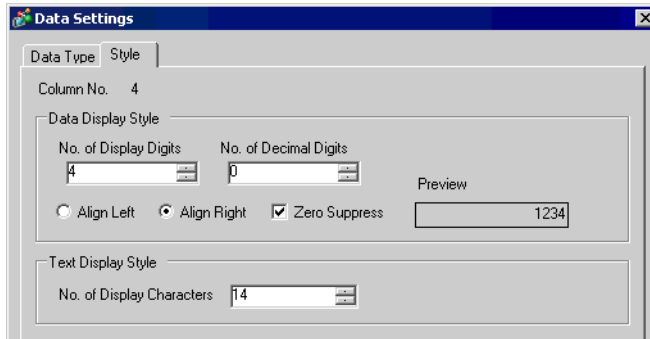

Setting	Description
No. of Display Digits	<p>Select the number of display digits for the data from 1 to 17. This can be designated to within the number of characters set in [No. of Display Characters]. The numbers displayed after the decimal point are also included in the number of digits. e.g.) When the No. of Display Digits is 5, and the No. of Decimal Digits is 2</p> <p style="text-align: center;">123.45</p>
No. of Decimal Digits	<p>Set the number of display digits after the decimal point, from 0 to [No. of Display Digits] – 1. This cannot be set when the [Data Type] is [Hex].</p>
Align Right/Align Left	<p>Select the data’s display position.</p>
Zero Suppress	<p>If this option is selected, leading zeros are not displayed. e.g.) When No. of Display Digits = 4</p> <div style="display: flex; justify-content: space-around; align-items: center;"> <div style="text-align: center;"> <input checked="" type="checkbox"/> Zero Suppress  <div style="border: 1px solid black; padding: 5px; width: 40px; margin: 5px auto;">25</div> <p>Leading zeroes are not displayed</p> </div> <div style="text-align: center;"> <input type="checkbox"/> Zero Suppress  <div style="border: 1px solid black; padding: 5px; width: 40px; margin: 5px auto;">0025</div> <p>Zeroes are added to correspond to the No. of Display Digits</p> </div> </div>

Continued

Setting	Description
Preview	Preview the selected style.
No. of Display Characters	Set the number of characters to be displayed in the Data column's cells from 1 to 20 single-byte characters.

#### ◆ Detail Settings - [Text Settings] Dialog Box

If you have added a [Text] column, select the column, click [Detail Settings] and the following dialog box will be displayed.

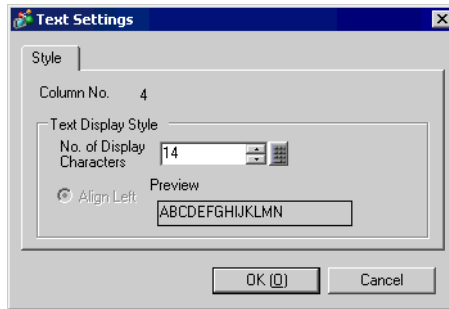

Setting	Description
Column No.	Displays the selected column's number.
No. of Display Characters	Set the number of characters to be displayed in the [Text] column's cells from 1 to 20 single-byte characters.
Align Left	The display of the text is fixed as left-aligned.
Preview	Previews the selected text column's style.

◆ **Detail Settings - [Calculation Settings] Dialog Box**

If the [No. of Calculation Display Rows] in [Block Print] is not “0”, select the Calculation row or Data column’s Calculation cell, click [Detail Settings] and the following dialog box will be displayed.

[Data Type] Tab

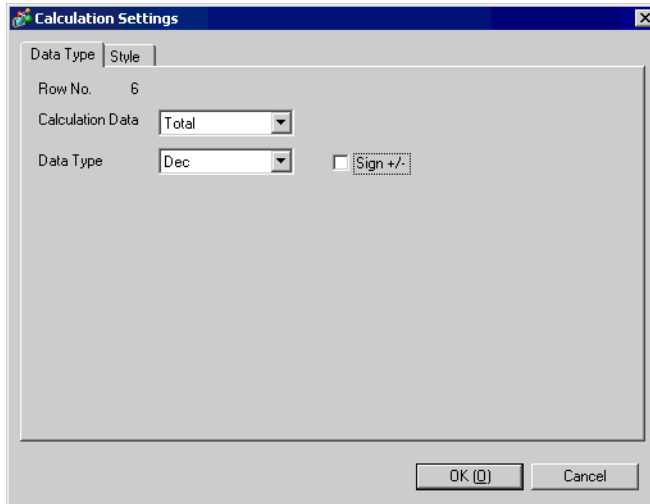

Setting	Description
Row No.	Displays the selected row’s number.
Calculation Data	Choose the data calculation type from [Total], [Average], [Max], or [Min].
Data Type	Choose the data type from [Dec], [BCD], [Hex], or [Float]. <b>NOTE</b> <ul style="list-style-type: none"> <li>When [BCD] is selected, sampling data containing the digits A-F (hexadecimal) other than BCD will be displayed/saved in CSV with “----” (No. of digits “-”).</li> </ul>
Sign +/-	Designate whether or not to attach a minus sign to data. This can only be set when the [Data Type] is [Dec]. <b>NOTE</b> <ul style="list-style-type: none"> <li>This is fixed when the [Data Type] is [Float].</li> </ul>

[Style] Tab

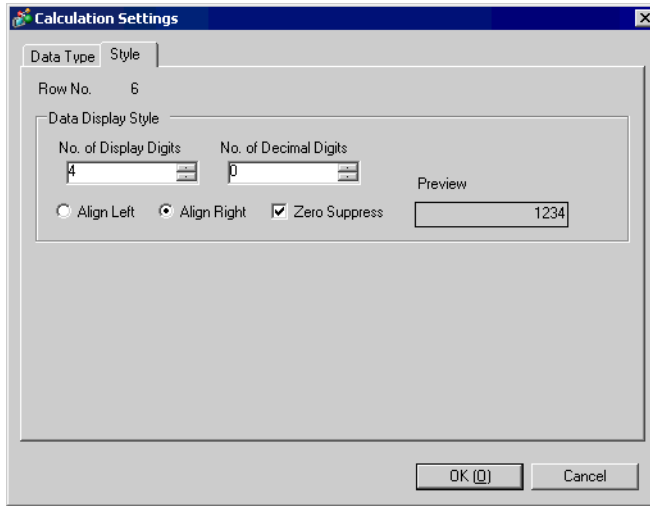

Setting	Description
No. of Display Digits	Select the number of display digits for the calculation data from 1 to 17. This can be designated to within the number of characters set in the [Style Type] tab's [No. of Display Characters]. The numbers displayed after the decimal point are also included in the number of digits. e.g.) When the No. of Display Digits is 5, and the No. of Decimal Digits is 2 <div style="text-align: center; border: 1px solid black; width: 100px; margin: 10px auto;">123.45</div>
No. of Decimal Digits	Set the number of display digits after the decimal point for the calculation data, from 0 to [No. of Display Digits] – 1. This cannot be set when the [Data Type] is [Hex].
Align Right/Align Left	Select the calculation data's display position.
Zero Suppress	If this option is selected, leading zeros are not displayed. e.g.) When No. of Display Digits = 4 <div style="display: flex; justify-content: space-around; align-items: center;"> <div style="text-align: center;"> <input checked="" type="checkbox"/> Zero Suppress  <div style="border: 1px solid black; width: 40px; height: 20px; margin: 5px auto; display: flex; align-items: center; justify-content: center;">25</div> <p>Leading zeroes are not displayed</p> </div> <div style="text-align: center;"> <input type="checkbox"/> Zero Suppress  <div style="border: 1px solid black; width: 40px; height: 20px; margin: 5px auto; display: flex; align-items: center; justify-content: center;">0025</div> <p>Zeroes are added to correspond to the No. of Display Digits</p> </div> </div>
Preview	Preview the selected style.

## ■ Write Data

Select the settings for writing sampling data to the GP's internal device. For more information about this function, please refer to the following.

☞ “24.9.6 Writing to the Internal Device” (page 24-125)

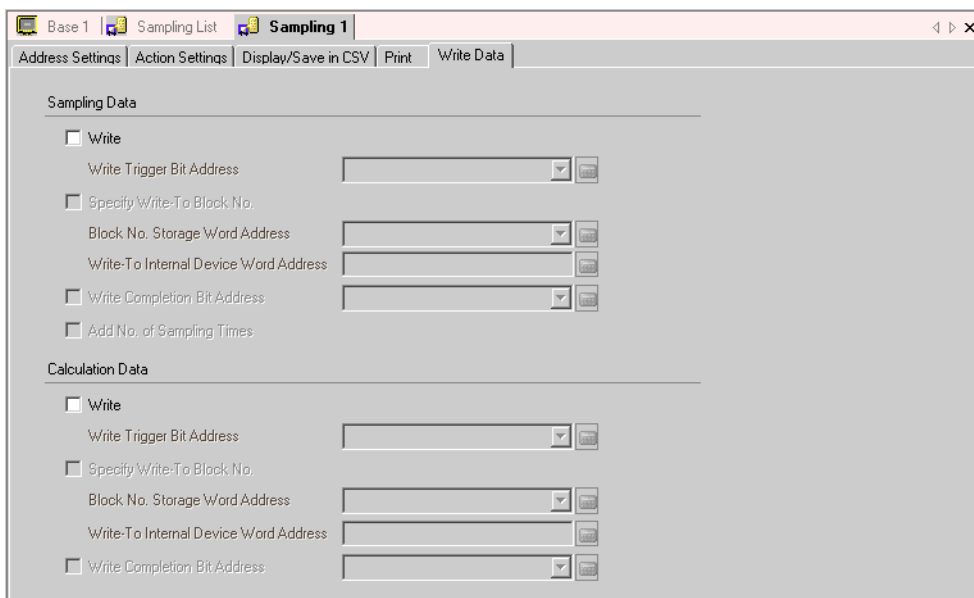

Setting		Description
Sampling Data	Write	Select whether or not to write the sampling data stored in backup SRAM (or DRAM) to the GP's internal device.
	Write Trigger Bit Address	Designate the address to control the data writing to the internal device. When this bit address turns ON, the sampling data will be outputted from backup SRAM (or DRAM) to the internal device.
	Specify Write-To Block No.	If [Overwrite old data after finishing the specified no. of times] is not designated on the [Action Settings] tab's Extended Settings, designate whether or not to set the block number to write to the internal device.
	Block No. Storage Word Address	When [Specify Write-To Block No.] is designated, set a word address in order to store the block number. The data stored in this address's block will be outputted to the internal device. If no block number is specified, data from Block No. "0" will be outputted.
	Save-In Internal Device Word Address	Select the internal device address where the data will be stored. The sampling data will be stored starting from this address. ☞ “◆ The Structure of Sampling Data stored in the Internal Device” (page 24-126)

Continued

Setting		Description
Sampling Data	Write Completion Bit Address	<p>Designate whether or not to confirm the completion of writing to the internal device. If you want to confirm it, set a bit address. When the data write is finished, this bit will turn ON.</p> <p><b>NOTE</b></p> <ul style="list-style-type: none"> <li>This bit will not be turned OFF automatically. After confirming that the writing completed, please turn OFF this bit.</li> </ul>
	Add No. of Sampling Times	Designate whether or not to output the number of data sampled to the internal device along with the data.
Calculation Data	Write	Select whether or not to read total values for each data column, set on the [Display/Save in CSV] tab, to the internal device.
	Write Trigger Bit Address	Set the address to control the writing of calculation data to the internal device. When this bit address turns ON, the calculation values for each Data column set on the [Display/Save in CSV] tab are written to the internal device.
	Specify Write-To Block No.	If [Overwrite old data after finishing the specified no. of times] is not designated on the [Action Settings] tab's Extended Settings, designate whether or not to set the block number to write to the internal device.
	Block No. Storage Word Address	When [Specify Write-To Block No.] is designated, set a word address in order to store the block number. The totals data stored in this address's block will be outputted to the internal device. If no block number is specified, totals data from block number [0] will be outputted.
	Save-In Internal Device Word Address	Select the internal device address where the totals data will be stored. The calculation data will be stored starting from this address.  "◆ The Structure of Sampling Data stored in the Internal Device" (page 24-126)
	Write Completion Bit Address	<p>Designate whether or not to confirm the completion of calculation data writing to the internal device. If you want to confirm it, set a bit address. When the data write is finished, this bit will turn ON.</p> <p><b>NOTE</b></p> <ul style="list-style-type: none"> <li>This bit will not be turned OFF automatically. After confirming that the writing completed, please turn OFF this bit.</li> </ul>

## 24.8.2 Sampling Data Display Settings Guide

Displays the sampling groups' data with the display format set in the Common Settings - [Sampling Settings] on the GP screen. One data item can be placed per screen.

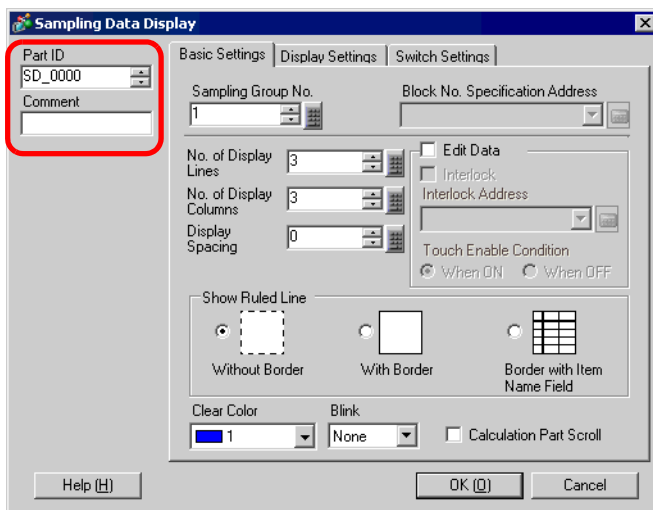

Setting	Description
Part ID	Placed parts are automatically assigned an ID number. Sampling Data Display's ID: SD_**** (4 digits) The letter portion is fixed. The number portion can be modified from 0000 to 9999.
Comment	The comment for each Part can be up to 20 characters long.

■ Basic Settings

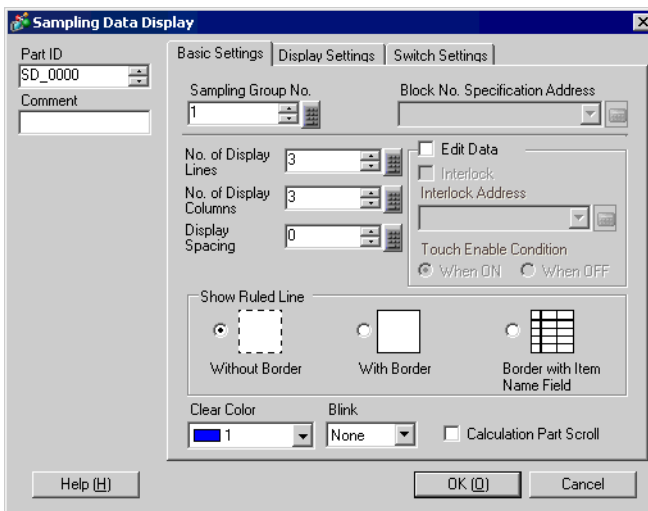

Setting	Description
Sampling Group No.	Set the sampling group number you want to display on the screen from among the sampling groups created in [Common Settings] - [Sampling Settings].
Block No. Specification Address	<p>When the designated sampling group has multiple blocks, this address will designate which block's data will be displayed. You can change the displayed data by changing the block number stored here. The block number is stored in binary format.</p> <p><b>NOTE</b></p> <ul style="list-style-type: none"> <li>• If a block number that does not exist is specified, data will not be displayed.</li> <li>• If [Overwrite old data after finishing the specified no. of times] is set for the group designated in [Sampling Group No.] on the Sampling Settings - [Action Settings] tab, this address is disabled.</li> </ul>
No. of Display Lines	Set the number of lines to be displayed on the screen from 1 to 50.
No. of Display Columns	Set the number of columns to be displayed on the screen from 1 to 25.
Display Spacing	Select the spacing between rows and columns displayed on the screen from 0 to 10 dots. This can only be set when the [Show Ruled Line] is set to [Without Border]. When drawing a ruled line freely, draw a line within the width of the spacing so that it may not overlap the cells.

Continued

Setting	Description						
Edit Data	<p>Specify whether or not displayed data can be edited. If this is designated, touching a displayed Date/Time or numeric value cell on the screen will allow you to change the value.</p> <p><b>NOTE</b></p> <ul style="list-style-type: none"> <li>• If you change the block number while editing data or move a cell being edited off the screen with a scroll switch, the value will not be changed and data edit mode will be canceled.</li> </ul>						
<table border="1" style="width: 100%; border-collapse: collapse;"> <tr> <td data-bbox="138 440 445 548">Interlock</td> <td data-bbox="445 440 1267 548">When [Edit Data] is designated, select whether or not to use the Interlock feature (the feature to allow data editing only when a condition is satisfied).</td> </tr> <tr> <td data-bbox="138 548 445 693">Interlock Address</td> <td data-bbox="445 548 1267 693">If the Interlock feature is enabled, designate the address which will control whether touch is enabled or disabled. Only when this bit address is in the same state as the [Touch Enable Condition] can data be edited by touching it.</td> </tr> <tr> <td data-bbox="138 693 445 1103">Touch Enable Condition</td> <td data-bbox="445 693 1267 1103"> <p>When using the Interlock feature, choose the condition which will enable touch.</p> <ul style="list-style-type: none"> <li>• When ON Touch is only enabled when the designated [Interlock Address] is ON.</li> <li>• When OFF Touch is only enabled when the designated [Interlock Address] is OFF.</li> </ul> <p><b>NOTE</b></p> <ul style="list-style-type: none"> <li>• When touch is disabled while editing data on the screen, the Edit Data mode is cancelled.</li> </ul> </td> </tr> </table>	Interlock	When [Edit Data] is designated, select whether or not to use the Interlock feature (the feature to allow data editing only when a condition is satisfied).	Interlock Address	If the Interlock feature is enabled, designate the address which will control whether touch is enabled or disabled. Only when this bit address is in the same state as the [Touch Enable Condition] can data be edited by touching it.	Touch Enable Condition	<p>When using the Interlock feature, choose the condition which will enable touch.</p> <ul style="list-style-type: none"> <li>• When ON Touch is only enabled when the designated [Interlock Address] is ON.</li> <li>• When OFF Touch is only enabled when the designated [Interlock Address] is OFF.</li> </ul> <p><b>NOTE</b></p> <ul style="list-style-type: none"> <li>• When touch is disabled while editing data on the screen, the Edit Data mode is cancelled.</li> </ul>	
Interlock	When [Edit Data] is designated, select whether or not to use the Interlock feature (the feature to allow data editing only when a condition is satisfied).						
Interlock Address	If the Interlock feature is enabled, designate the address which will control whether touch is enabled or disabled. Only when this bit address is in the same state as the [Touch Enable Condition] can data be edited by touching it.						
Touch Enable Condition	<p>When using the Interlock feature, choose the condition which will enable touch.</p> <ul style="list-style-type: none"> <li>• When ON Touch is only enabled when the designated [Interlock Address] is ON.</li> <li>• When OFF Touch is only enabled when the designated [Interlock Address] is OFF.</li> </ul> <p><b>NOTE</b></p> <ul style="list-style-type: none"> <li>• When touch is disabled while editing data on the screen, the Edit Data mode is cancelled.</li> </ul>						
Show Ruled Line	Select the type of data border from [Without Border], [With Border], or [Border with Item Name Field].						
Clear Color	Select a color for the portion with no text displayed.						
Blink	<p>Select whether or not the [Clear Color] will blink, and the blink speed.</p> <p><b>NOTE</b></p> <ul style="list-style-type: none"> <li>• There are cases where you can and can not set Blink depending on the Main Unit and System Settings' [Color Settings].</li> </ul> <p>☞ "9.5.1 Specify Color ■ Supported Color List" (page 9-33)</p>						
Calculation Part Scroll	<p>Designate whether or not scroll the calculation data portion together with the data portion. If this is not designated, the data calculation portion will be displayed on the screen.</p> <p>This cannot be set when [Overwrite old data when designated block count finishes] is set to the sampling data. The calculation data is not scrolled.</p>						

## ■ Display Settings

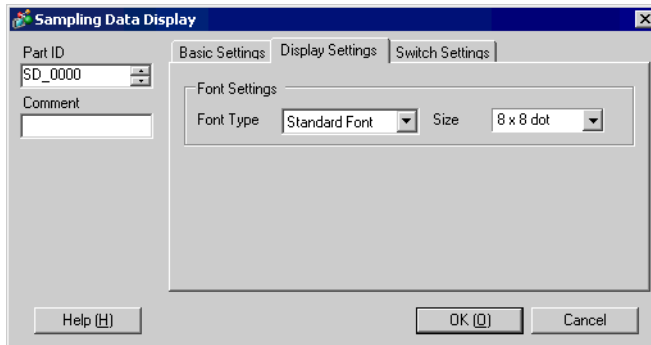

Setting	Description
Font Type	<p>Choose a font type for the characters and numeric values from [Standard Font] or [Stroke Font].</p> <ul style="list-style-type: none"> <li>• Standard Font This is a Bit Map font. Choose the magnification ratio of the characters' height and width. When you magnify/shrink characters, the outline may become rough or the letter may appear squished.</li> <li>• Stroke Font This is an outline font where the ratio of the characters' height/width is fixed. The letters will have a smooth outline even if you magnify/shrink them, however, this font has a large size so it can burden the GP.</li> </ul>
Size	<p>Select a font size for the characters and numeric values to be displayed.</p> <p>Standard Font: From [8 × 8 dot] to [64 × 128 dot], in a ratio of 8 dot units  Fixed Size: select from [6 × 10 dot], [8 × 13 dot],  or [13 × 23 dot]</p> <p>Stroke Font: 6 to 127 dots</p>

## ■ Switch Settings

Set the Switches to scroll the display of the Sampling Data Display.

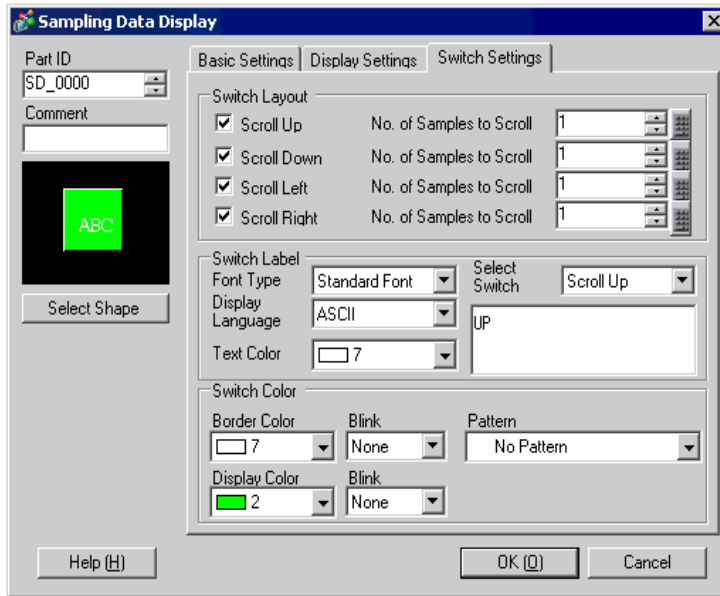

Setting		Description
Part Shape		Displays the shape that you chose for the switch with [Select Shape].
Select Shape		Open the [Select Shape] dialog box to choose the switch's shape.
Switch Layout	Scroll Up/ Scroll Down/ Scroll Left/ Scroll Right	Select whether or not to place switches to scroll the display data in each direction.
	No. of Samples to Scroll	When selecting a switch to place, set how many rows or columns it will scroll when pressed.
Switch Label	Font Type	Choose the label font for the switches from [Standard Font] or [Stroke Font].
	Display Language	Choose the label's display language from [ASCII], [Japanese], [Taiwanese], [Chinese], or [Korean].
	Text Color	Select the font color that will be displayed on the switches' labels.
	Select Switch	Select a switch whose label you will set from among the placed switches.
	Label	Enter the text that you want to display on the switch selected in [Select Switch].

Continued

Setting		Description
Switch Color	Border Color	Select a color and border color for the Switch. <b>NOTE</b>
	Display Color	<ul style="list-style-type: none"> <li>Some settings cannot be set depending on the part that you chose with [Select Shape].</li> </ul>
	Pattern	Select the switches' pattern from among 9 types.
	Pattern Color	Select the switches' pattern color.
	Blink	<p>Select whether or not the Part will blink, and the blink speed. You can choose different blink settings for the [Display Color], [Pattern Color], [Border Color], and [Text Color].</p> <p><b>NOTE</b></p> <ul style="list-style-type: none"> <li>There are cases where you can and can not set Blink depending on the Main Unit and System Settings' [Color Settings].</li> </ul> <p> "9.5.1 Specify Color ■ Supported Color List" (page 9-33)</p>

## 24.9 Sampling Structure

### 24.9.1 Summary

Select which address's data and which timing will be used for sampling, after that the sampled data is handled as a group based on those settings (called a "Sampling Group").

A maximum of 64 sampling groups can be set in each project. The number of groups that can be set in a system depends on the No. of Times and the No. of Addresses.

When there is only 1 sampling group, the maximum number of data (no. of addresses) that can be sampled at one time is 512 for 16 bit length, and 256 for 32 bit length.

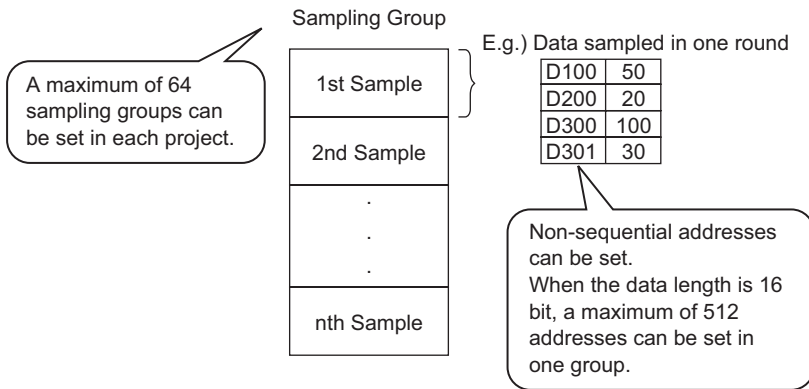

The sampled data can be displayed on the GP screen in group units, and saved to the CF-card.

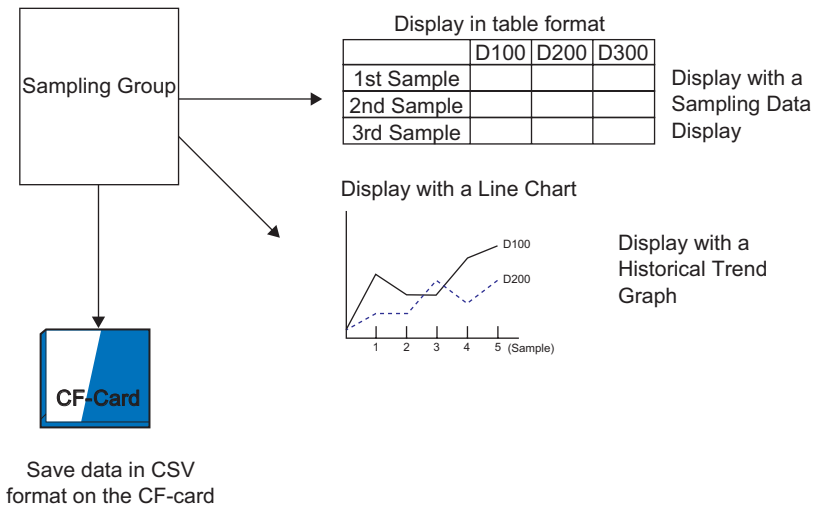

■ Data Sampling Flow

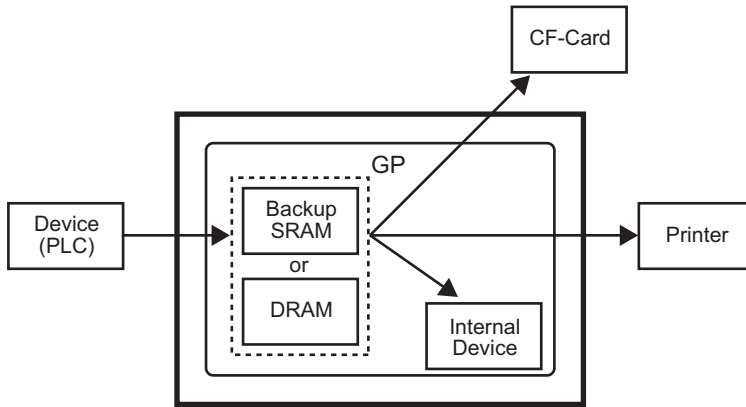

■ Backup SRAM

This memory will save data even when the GP unit’s power is OFF.

The backup SRAM user area is used to back up Sampling data, Alarm History data, filing data, and the internal device (User Area).

The capacity of backup SRAM that can be used by sampling data depends on the model of GP and how much capacity is being used by other data.

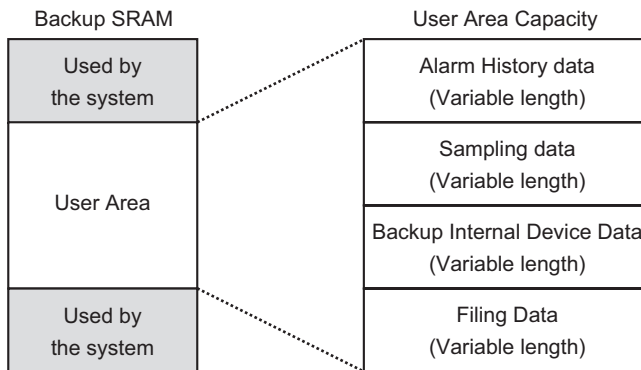

Backup SRAM has the following usage priorities:

- (1) Alarm History data
- (2) Sampling data
- (3) Internal device backup
- (4) Filing data

**NOTE** • The priority order within the Sampling feature goes in order of the smallest Sampling Group No.

**IMPORTANT** • Sampling data stored in backup SRAM is erased when:

- Screen transfer occurs
- Memory is reset (Offline)
- Backup SRAM is initialized (Offline)
- The designated [Data Clear Bit Address] turns ON

◆ **DRAM**

This memory is used for temporary storage and all data stored here will be erased when the GP is turned OFF or reset.

When the [Action Settings] tab's [Backup to SRAM] check box is cleared, sampling data will be stored in this DRAM.

**IMPORTANT**

- Sampling data stored in DRAM is erased when:
  - GP is turned OFF
  - GP is reset
  - Screen transfer occurs
  - The designated [Data Clear Bit Address] turns ON

■ **Sampling Data Capacity**

Sampling data's backup SRAM (or DRAM) usage capacity differs depending on the No. of Sampling Groups, Data Length, No. of Data (No. of Addresses) and the contents of the action settings.

Without the sampling settings, the usage capacity is 0 bytes.

<Calculation>

- Usage capacity per group (in bytes)

$$20 + \text{No. of Blocks} \times \text{No. of Times}^{*2} \times \left\{ \frac{\text{No. of Data} + 31}{32} \times 4^{*3} + 2^{*5} \times \text{No. of Data}^{*1} + 12^{*4} \right\}$$

- \*1 When the No. of Data is an odd number, this value becomes [No. of Data] (the portion in bold) + 1.
- \*2 When [Overwrite old data after finishing the specified no. of times] is designated in the action settings, this value becomes [No. of Times] + 1.
- \*3 When [Add Data Valid/Invalid Flag] is designated in the action settings, this portion's size (the underlined portion) is added.
- \*4 When [Add Time Data] is designated in the action settings, 12 bytes will be added to each sample as time data.
- \*5 2 bytes when the data length is 16 bit, 4 bytes when the data length is 32 bit.

- Usage capacity for whole system (in bytes)

$$(4 + 4 \times \text{No. of Groups}) + \text{Total of each Sampling Group's usage capacity}$$

<Calculation Example>

Setting	Description
No. of Groups	1
Data Type	16 Bit
No. of Blocks	1
No. of Times	100
No. of Data (No. of Addresses)	7

e.g. 1) [Overwrite old data after finishing the specified no. of times] is not set, [Add Time Data] is not set, [Add Data Valid/Invalid Flag] is set

[Calculation]  $(4 + 4 \times \text{No. of Groups}) + [20 + \text{No. of Blocks} \times \text{No. of Times} \times \{(\text{No. of Data} + 31)/32 \times 4 + 2 \times (\text{No. of Data} + 1)\}]$

[Calculation Result]  $(4 + 4 \times 1) + [20 + 1 \times 100 \times \{(7 + 31)/32 \times 4 + 2 \times (7 + 1)\}]$   
 = 2,103 bytes (Around 2.1 KB)

e.g. 2) [Overwrite old data after finishing the specified no. of times] is set, [Add Time Data] is set, [Add Data Valid/Invalid Flag] is set

[Calculation]  $(4 + 4 \times \text{No. of Groups}) + [20 + \text{No. of Blocks} \times (\text{No. of Times} + 1) \times \{(\text{No. of Data} + 31)/32 \times 4 + 2 \times (\text{No. of Data} + 1) + 12\}]$

[Calculation Result]  $(4 + 4 \times 1) + [20 + 1 \times (100 + 1) \times \{(7 + 31)/32 \times 4 + 2 \times (7 + 1) + 12\}]$   
 = 3,335 bytes (Around 3.3 KB)

■ Sampling Settings Flow

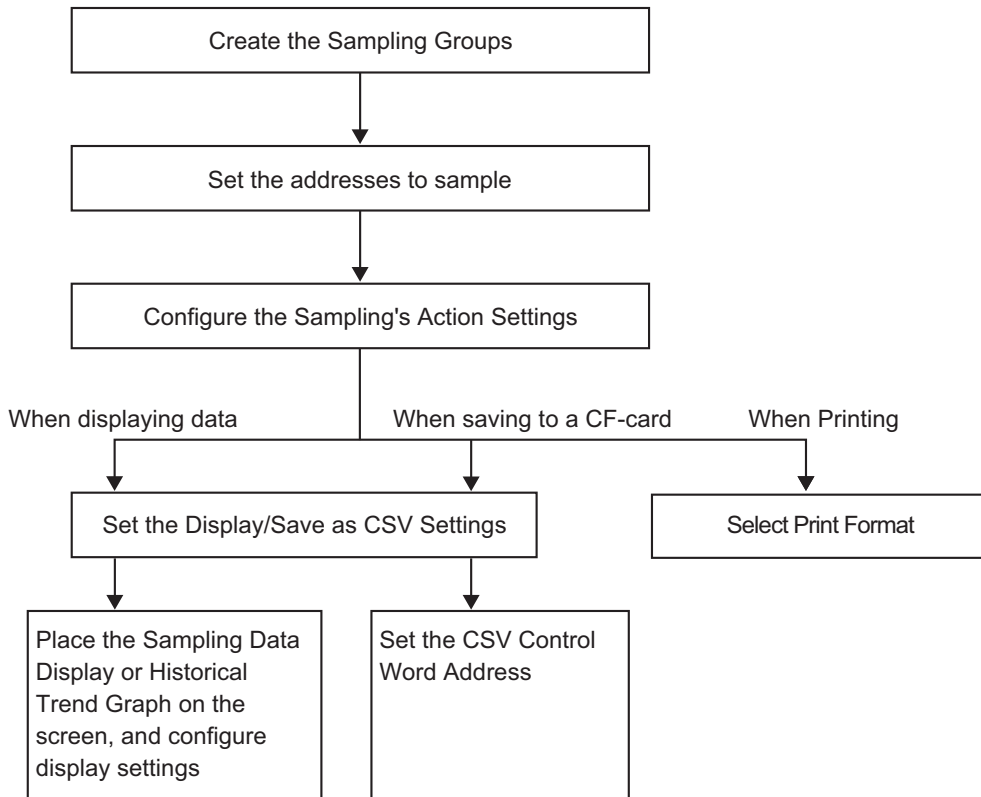

## 24.9.2 The Sampling Action

### ■ Data Sampling Timing

There are two methods for the sampling action, sample by time period, or sample depending on a bit's state.

The following shows the execution conditions for the Sampling, and each action's characteristics.

Timing	Sampling Execution Condition	Attribute
Time Period	Time Specification Sampling begins at the designated time and continues for the designated period.	<ul style="list-style-type: none"> <li>You can set the start time.</li> <li>Sampling cycles are set in 15 second increments.</li> <li>After sampling data for the designated No. of Times, you can select whether to overwrite data starting with the oldest data, or whether to not overwrite and store in a separate block *2.</li> </ul>
	Constant Cycle*1 Sample data at constant cycles starting from when the GP is turned ON.	<ul style="list-style-type: none"> <li>You can set the sampling cycle 100 ms (millisecond) or 1 s (second) units.</li> <li>Data will be overwritten and stored, starting with the oldest data, after data has been sampled the designated number of times.</li> </ul>
	Constant Cycle when Bit is ON*1 Sample data at constant cycles starting from when the GP is turned ON, but only when the designated bit is ON.	<ul style="list-style-type: none"> <li>You can set the sampling cycle 100 ms (millisecond) or 1 s (second) units.</li> <li>While the designated bit is OFF, data will not be sampled even when a cycle starts.</li> <li>Data will be overwritten and stored, starting with the oldest data, after data has been sampled the designated number of times.</li> </ul>
Bit	Bit ON Data is collected every time the designated bit turns ON.	<ul style="list-style-type: none"> <li>After sampling data for the designated No. of Times, you can select whether to overwrite data starting with the oldest data, or whether to not overwrite and store in a separate block *2.</li> </ul>
	Bit Change*1 Data is collected every time the designated bit changes state (ON/OFF).	<ul style="list-style-type: none"> <li>Data will be overwritten and stored, starting with the oldest data, after data has been sampled the designated number of times.</li> </ul>

\*1 For [Constant Cycle], [Constant Cycle when Bit is ON], and [Bit Change], all the set address data is read, and stored in backup SRAM (or DRAM) at the time the execution condition becomes satisfied.

\*2 All the sampling data collected in the designated No. of Times is called a "block".  
 " ■ Data Storage Methods" (page 24-108)

- NOTE**
- After the GP is powered ON and the internal programs are prepared, one second maximum of delay time may occur before the sampling starts.
  - For [Constant Cycle], [Constant Cycle when Bit is ON], and [Bit Change], because all the set address data is being read, the communication may put a burden on the system if the number of addresses to sample is large.
  - If data sampling cannot occur, for example due to a communication error occurring during sampling, that round's data will be stored as a "read error".
  - The data's display state when a communication error occurs during sampling depends on the execution condition.
- ☞ "24.9.3 Displaying Sampling Data ■ What happens when data cannot be sampled?" (page 24-115)

◆ **Time Specification**

When a device/PLC's [Sampling Permit Bit Address] is ON and the designated [Start Time] begins, the data from the designated addresses is read. After that, the data read occurs at the designated cycle.

The sampling cycle's time monitor is operated by the GP's internal clock.

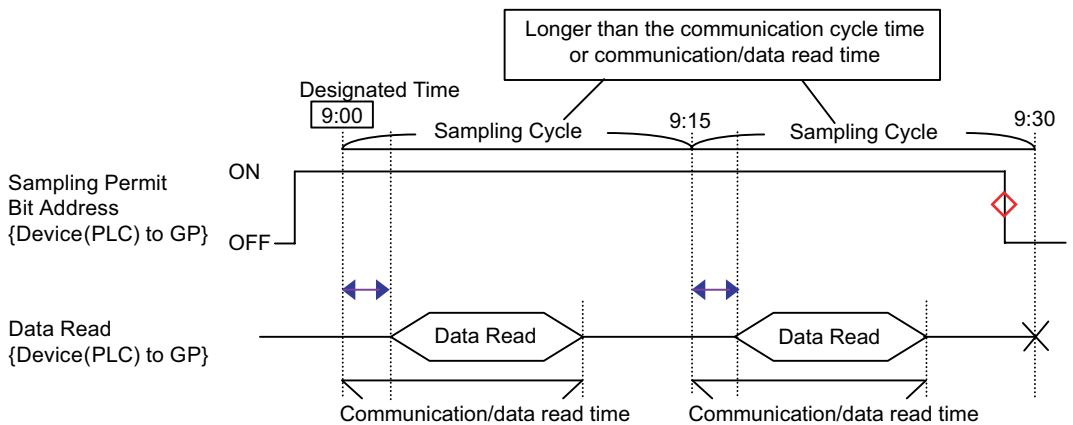

↔ =Communication time lag

◇ =Return the bit to the OFF state when action finishes (e.g. "Stop action after 9:15 sampling").

**NOTE**

- The above image shows the timing of the GP reading data from the designated address. The displayed time intervals are not accurate.
- Please set the [Sampling Cycle] to either the communication cycle time or the time taken to read the communication data, whichever is longer. Communication cycle time is stored in the GP internal device's (Special Relay Area) LS2037.
- Sampled data will also have the sample time added to it. The start time of the data read at the designated [Start Time] and each [Sampling Cycle] will become the "time data".

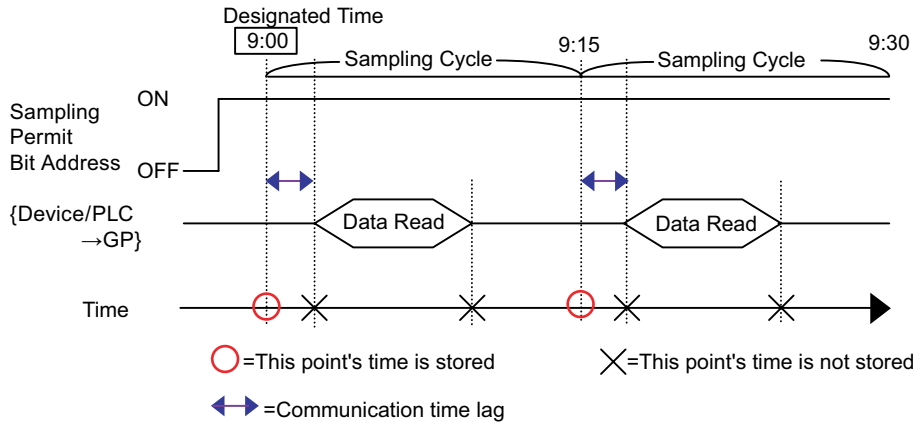

◆ **Constant Cycle**

Read data at the designated fixed cycle starting from when the GP unit is turned ON. The sampling cycle's time monitor is operated by the GP's internal clock.

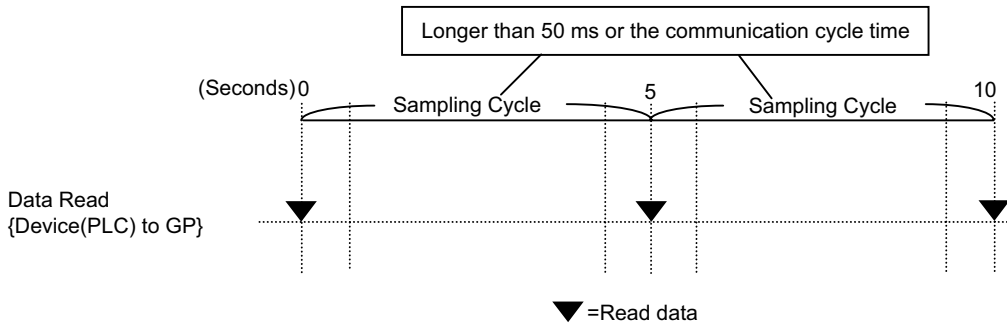

**NOTE**

- The above image shows the timing of the GP reading data from the designated address. The displayed time intervals are not accurate.
- When using the Direct Access method to communicate with the device/PLC, set the [Sampling Cycle] to the communication cycle time or 50 ms, whichever is longer. For the Memory Link method, set the [Sampling Cycle] to 50 ms or more. Communication cycle time is stored in the GP internal device's (Special Relay Area) LS2037.

◆ **Constant Cycle when Bit is ON**

When the device/PLC's [Sampling Trigger Bit Address] is ON, data is read at the designated fixed cycle. The sampling cycle's time monitor is operated by the GP's internal clock.

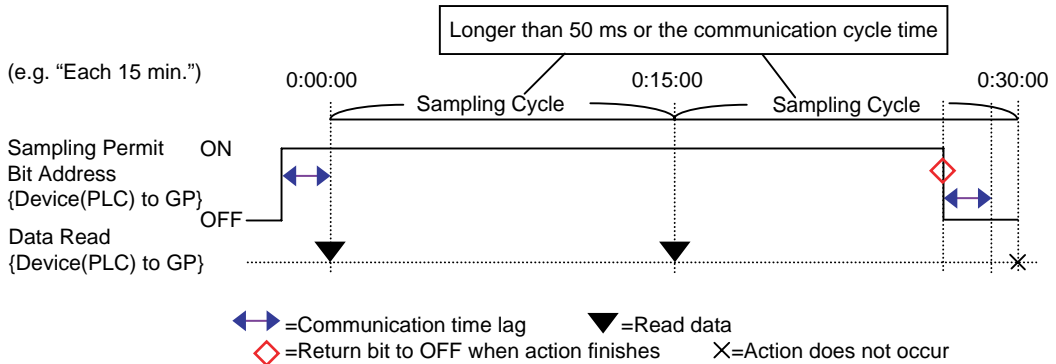

**NOTE**

- The above image shows the timing of the GP reading data from the designated address. The displayed time intervals are not accurate.
- The time period from when the [Sampling Permit Bit Address] turns ON to the time the sampling actually begins can be up to 1 second.
- When using the Direct Access method to communicate with the device/PLC, set the [Sampling Cycle] to the communication cycle time or 50 ms, whichever is longer. For the Memory Link method, set the [Sampling Cycle] to 50 ms or more. Communication cycle time is stored in the GP internal device's (Special Relay Area) LS2037.
- Please plan the action settings to take into consideration cases where the GP's power is turned OFF while an action is running. Please ensure that each bit address such as the [Sampling Permit Bit Address] and [Data Full Bit Address] is in the OFF state when power is turned ON.

◆ **Bit ON**

When the device/PLC's [Sampling Trigger Bit Address] turns ON, the designated address' data is read to the GP. When the GP finishes reading data, the [ACK Bit Address] is turned ON.

When you detect that the device/PLC's [ACK Bit Address] has turned ON, please turn OFF the [Sampling Trigger Bit Address].

When you turn OFF the [Sampling Trigger Bit Address], the [ACK Bit Address] will automatically be turned OFF.

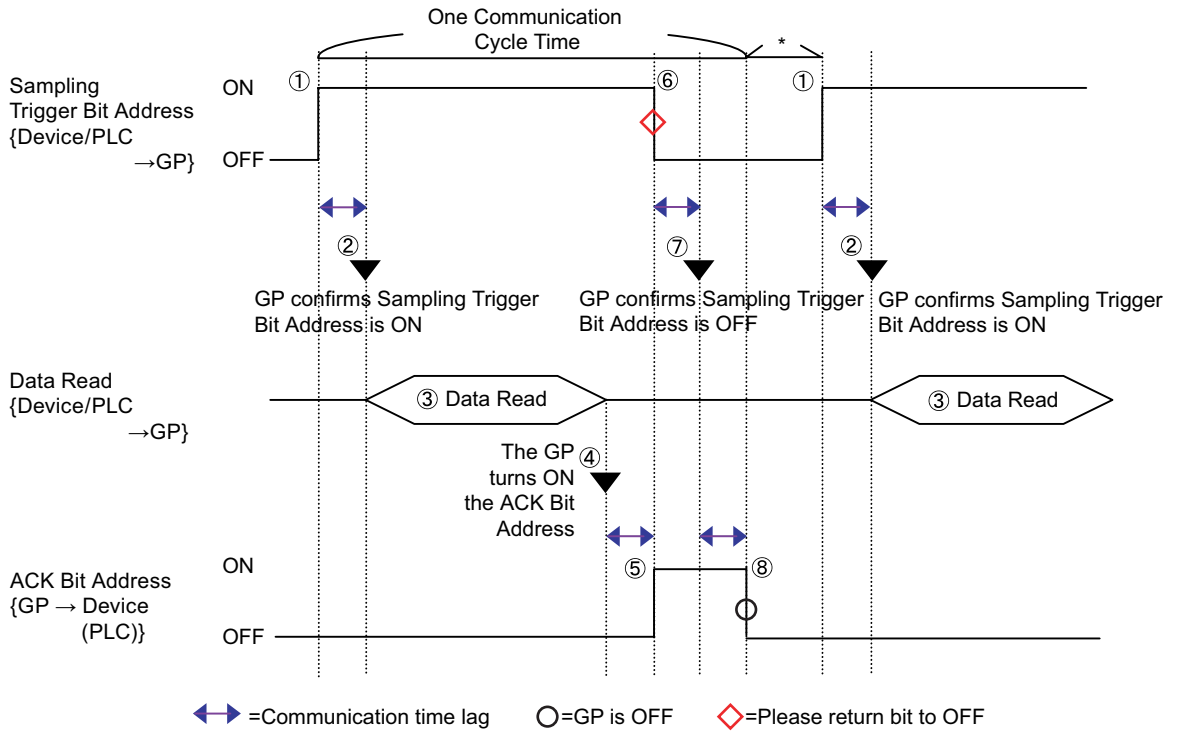

**NOTE**

- The above image shows the timing of the GP reading data from the designated address. The displayed time intervals are not accurate.
- Please confirm that the [ACK Bit Address] is turned OFF before sampling.
- Please plan the action settings to take into consideration cases where the GP's power is turned OFF while an action is running. Please ensure that each bit address such as the [Sampling Trigger Bit Address] and [ACK Bit Address] is in the OFF state when power is turned ON.
- When the sample time (time data) is added to sampling data, the time data shows the time when the data read completed, not the time when the [Sampling Trigger Bit Address] turned ON.

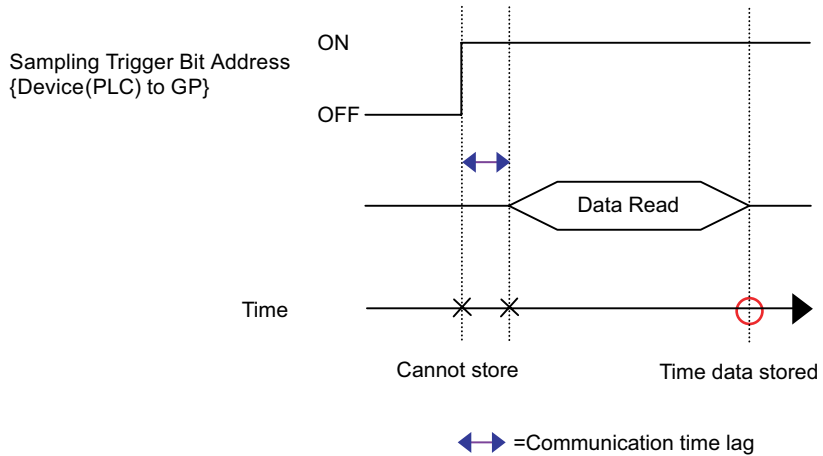

◆ **Bit Change**

When the device/PLC's [Sampling Trigger Bit Address] turns ON or turns OFF, the designated address' data is read to the GP.

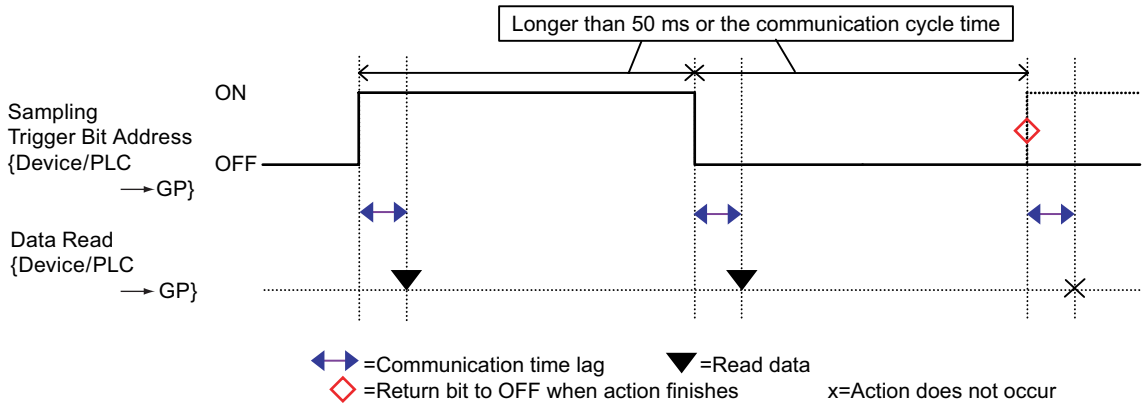

**NOTE**

- The above image shows the timing of the GP reading data from the designated address. The displayed time intervals are not accurate.
- Please plan the action settings to take into consideration cases where the GP's power is turned OFF while an action is running. Please ensure that each bit address such as the [Sampling Trigger Bit Address] and [Data Full Bit Address] is in the OFF state when power is turned ON.
- The [Sampling Trigger Bit Address] will not function correctly if turned OFF immediately after being turned ON. Please wait until the GP can recognize the bit's state (ON or OFF). (When using the Direct Access method, the wait time should be the communication cycle time or 50 ms, whichever is longer. For the Memory Link method, 50 ms or more.)



**NOTE**

- When one block finishes, the [Block Termination Bit Address] is turned ON. After you confirm that the block has finished, please turn OFF the [Block Termination Bit Address] so that it can detect when the next block finishes. Also, please confirm that the [Block Termination Bit Address] is turned OFF before sampling.
  - When all data sampling finishes (No. of Times × No. of Blocks), the [Data Full Bit Address] turns ON and further sampling will not occur. To start the sampling action again, turn ON the designated [Data Clear Bit Address] and erase the stored data.  
 “ ■ Deleting Data” (page 24-110)
-

## ■ Deleting Data

If [Overwrite old data after finishing the specified no. of times] is not designated on the [Action Settings] tab's Extended Settings, sampling will not occur after data has been stored for the designated No. of Times × No. of Blocks. To start sampling again, you must delete sampling data stored in the GP.

When data has been sampled from the No. of Times × No. of Blocks, the designated [Data Full Bit Address] is automatically turned ON. Please confirm that this bit is ON and turn ON the [Data Clear Bit Address].

e.g.) Execution Condition: Time Specification

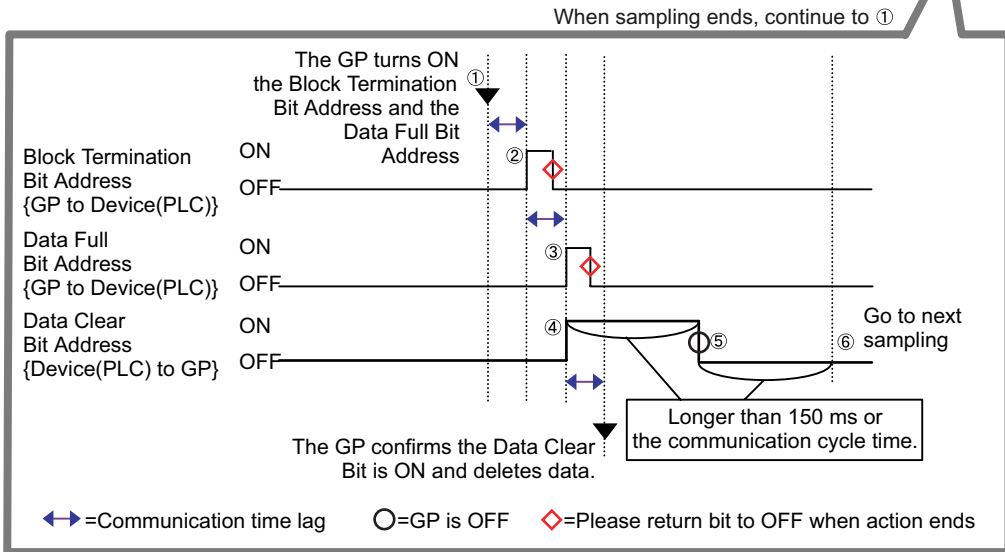
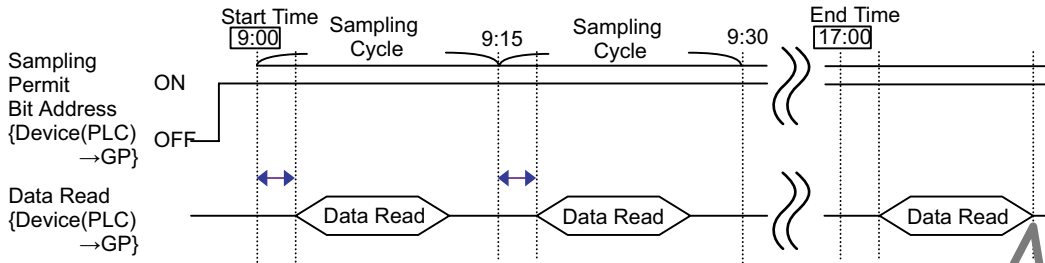

- (1) When data has been sampled from the No. of Times × No. of Blocks, the GP turns ON the [Block Termination Bit Address] and [Data Full Bit Address].
- (2) The [Block Termination Bit Address] turns ON.
- (3) The [Data Full Bit Address] turns ON.
- (4) Please confirm that the [Data Full Bit Address] bit is ON and turn ON the [Data Clear Bit Address]. When the GP detects this, it begins the deletion of sampling data.
- (5) When the data deletion completes, the GP automatically turns OFF the [Data Clear Bit Address].
- (6) You can now start the sampling action again. Data will be stored starting from the top (the first sample cycle in “block 0”).

**NOTE** • The [Data Clear Bit Address] will not function correctly if turned OFF immediately after being turned ON (or if turned ON immediately after being turned OFF). When using the Direct Access method to communicate with the device/PLC, maintain the bit's state for the communication cycle time or 150 ms, whichever is longer. For the Memory Link method, 150 ms or more.

### 24.9.3 Displaying Sampling Data

Data is displayed on a Sampling Data Display on the GP screen every time sampling occurs. When the data surpasses the designated [No. of Display Rows], the old data will shift up and the new data will be added.

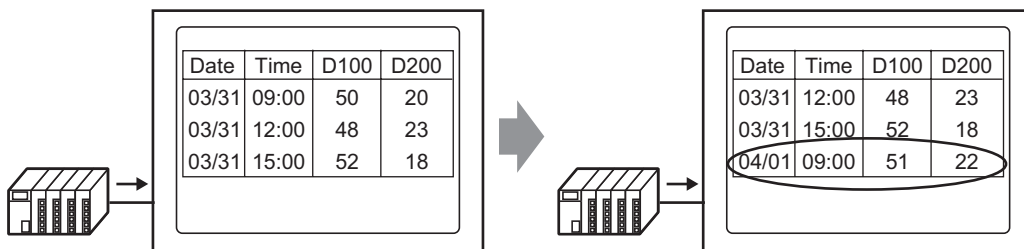

Each time data is sampled, old data is shifted up and the new data is added and displayed.

If [Overwrite old data when designated block count finishes] is not set in the Action Settings, only the sampling data from the block number stored in the [Block No. Storage Address] will be displayed. When the last data from the block is displayed, the display will not be updated again.

To display another block's data, change the value in the [Block No. Specification Address] and the display will change.

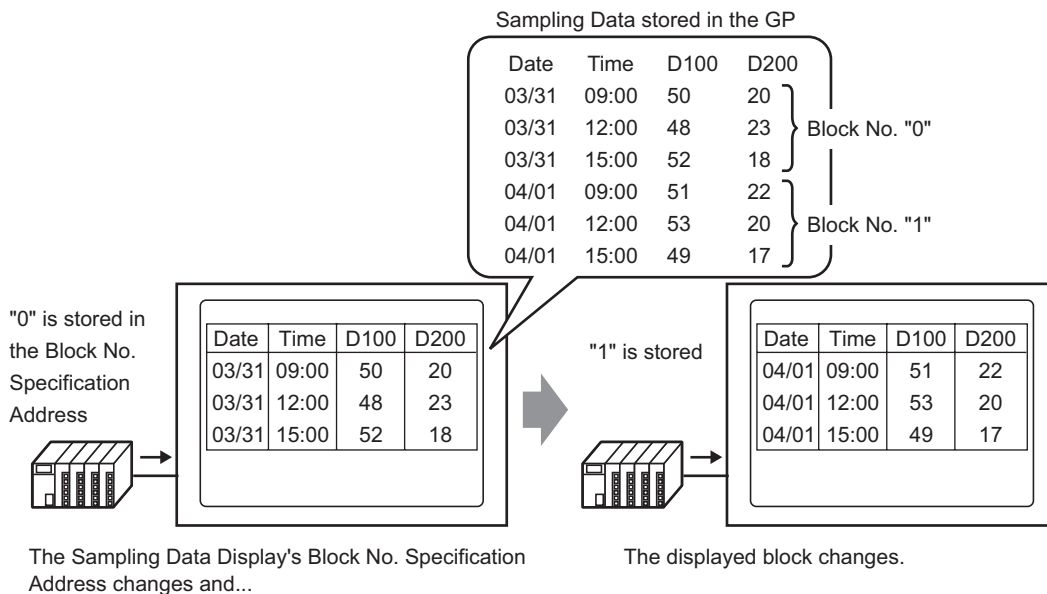

The Sampling Data Display's Block No. Specification Address changes and...

The displayed block changes.

**NOTE**

- If a block number that does not exist is specified, data will not be displayed.

### ■ Display Example for Simple Settings

In the Simple Settings mode, a fixed preset format (such as the following) can be used to create a simple format.

- Data columns and Time columns are displayed sequentially line by line, then data columns for all of the No. of Addresses set after the Date/Time are displayed.
- The 1st row displays the Item Name row. The Data columns' item names all display an address.
- When the Total row is displayed, it appears in the row after the data display rows. The item name is displayed as "Total".
- If [Overwrite old data after finishing the specified no. of times] is designated on the [Action Settings] tab's Extended Settings, only one data row will be displayed. If it is not designated, the data rows will equal the designated No. of Times.

**NOTE**

- The data, except Item Name in a Data column, Time column, and Data column, are displayed in the center of each cell on the Sampling Data Display.  
e.g.) Display Format Settings: No. of Item Name Characters = 8, No. of Display Digits = 4, Align Right

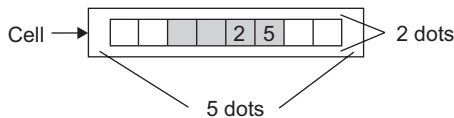

### ◆ When [Overwrite old data when designated block count finishes] is set

<Display Format Settings>

e.g.) Total row = checked, No. of Item Name Characters = 8

Date	Time	D00100	D00200	D00300	D00301
yy/mm/dd	hh:mm	***.*	***.*	***.*	***.*
Total		****.*	****.*	****.*	****.*



<Sampling Data Display>

e.g.) No. of Display Rows = 6, No. of Display Columns = 7

Date	Time	D00100	D00200	D00300	D00301
05/03/31	12:00	323.6	26.4	26.4	6.4
05/03/31	15:00	324.4	28.6	27.6	6.2
05/03/31	18:00	320.2	30.7	28.7	6.5
05/04/01	09:00	321.0	26.9	29.9	6.3
Total		1289.2	112.6	112.6	25.4

↑ To shift the old data up, every time sampling occurs, the data display rows are shifted up and the new data is displayed.

The calculation data are values calculated from data when it is stored in the GP. Overwritten data is not included in the calculations.

◆ When [Overwrite old data after finishing the specified no. of times] is not set

<Display Format Settings>

e.g.) Total row = checked, No. of Item Name Characters = 8

	Date	Time	D00100	D00200	D00300	D00301
No.1	yy/mm/dd	hh:mm	****	****	****	****
No.2	yy/mm/dd	hh:mm	****	****	****	****
No.3	yy/mm/dd	hh:mm	****	****	****	****
No.4	yy/mm/dd	hh:mm	****	****	****	****
Total			****	****	****	****



<Sampling Data Display>

e.g.) No. of Display Rows = 6, No. of Display Columns = 7

	Date	Time	D00100	D00200	D00300	D00301
No.1	05/03/31	09:00	322.8	30.3	25.3	6.1
No.2	05/03/31	12:00	323.6	26.4	26.4	6.4
No.3	05/03/31	15:00	324.4	28.6	27.6	6.2
No.4	05/03/31	18:00	320.2	30.7	28.7	6.5
Total			1291.0	116.0	108.0	25.2

Only the designated block's data is displayed.

The calculation data are values calculated from data from the designated No. of Times.

■ Display Example for Custom Settings

You can create a customized format with Custom Settings.

- You can set each data column's Display Range, No. of Display Digits, etc.
- You can add Date columns, Time columns, Data columns, Text columns, and Text rows.
- You can directly input text in Text columns, Text rows, and Item Name rows.
- When [Overwrite old data after finishing the specified no. of times] is not set in the Action Settings, you can set the calculation rows (Total, Average, Max, Min).

**NOTE** • The data, except Item Name and Text in a Data column, Time column, and Data column, are displayed in the center of each cell on the Sampling Data Display.  
e.g.) Display Format Settings: No. of Item Name Characters = 8, No. of Display Digits = 4, Align Right

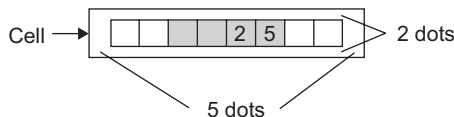

◆ When [Overwrite old data after finishing the specified no. of times] is set

<Display Format Settings>

		1	2	3	4	5	6
	Item Name (Vertical)	Data1	Time	Data2	Data3	Data4	
1	Item Name (Horizontal)	Voltage	Time	Temp. 1	Temp. 2	Pressure	
2	Show Data	Data	xxxx	hh:mm	xx.x	xx.x	xx.x
3	Calculation	Sum	xxxx		xx.x	xx.x	xx.x
4	Calculation	Average	xxxx		xx.x	xx.x	xx.x



<Sampling Data Display>

	Voltage	Time	Temp. 1	Temp. 2	Pressure
Data	3236	12:00	26.4	26.4	6.4
Data	3244	15:00	28.6	27.6	6.2
Data	3202	18:00	30.7	28.7	6.5
Data	3210	09:00	26.9	29.9	6.3
Sum	12892		112.6	112.6	25.4
Average	3223		28.2	28.2	6.4

↑ To shift the old data up, every time sampling occurs, the data display rows are shifted up and the new data is displayed.

The calculation data are values calculated from data when it is stored in the GP. Overwritten data is not included in the calculations.

**NOTE**

- Text rows are not displayed even if you set them.

◆ When [Overwrite old data after finishing the specified no. of times] is not set

<Display Format Settings>

		1	2	3	4	5	6
	Item Name (Vertical)	Data1	Time	Data2	Data3	Data4	
1	Item Name (Horizontal)	Voltage	Time	Temp. 1	Temp. 2	Pressure	
2	No.1	1	xxxx	hh:mm	xx.x	xx.x	xx.x
3	No.2	2	xxxx	hh:mm	xx.x	xx.x	xx.x
4	No.3	3	xxxx	hh:mm	xx.x	xx.x	xx.x
5	No.4	4	xxxx	hh:mm	xx.x	xx.x	xx.x
6	Calculation	Sum	xxxx		xx.x	xx.x	xx.x
7	Calculation	Average	xxxx		xx.x	xx.x	xx.x



<Sampling Data Display>

	Voltage	Time	Temp. 1	Temp. 2	Pressure
1	3228	09:00	30.3	25.3	6.1
2	3236	12:00	26.4	26.4	6.4
3	3244	15:00	28.6	27.6	6.2
4	3202	18:00	30.7	28.7	6.5
Sum	12910		116.0	108.0	25.2
Average	3227		29.0	27.0	6.3

The designated block's data is displayed.

The calculation data are values calculated from data from the designated No. of Times.

■ **What happens when data cannot be sampled?**

If data sampling cannot occur, for example due to a communication error occurring during sampling, that round's data will be displayed/saved in CSV as follows according to the execution condition.

◆ **When the Execution Condition is [Time Specification] or [Bit ON]**

As a read error, [\*\*\*\*] is displayed.

e.g.) Execution Condition = Time Designation, Start Time = 17:00,  
Sampling Cycle = 30 min., No. of Times = 5

When a communication error occurs at 18:00		When the GP is turned ON after 17:30	
17:00	100	17:00	***
17:30	200	17:30	***
18:00	***	18:00	300
18:30	400	18:30	400
19:00	500	19:00	500

◆ **When the Execution Condition is [Constant Cycle], [Constant Cycle when Bit is ON], or [Bit Change]**

The read data will appear immediately before a communication error occurs.

e.g.) A communication error occurred right after the 2nd sampling round, and the error state continued until right before the 3rd sampling round

1st Sample	100	
2nd Sample	200	
3rd Sample	200	← Data that existed before the error is displayed
4th Sample	400	
5th Sample	500	

**NOTE**

- When the [Sampling Cycle] is shorter than the communication cycle time, if the communication cycle time becomes longer due to a screen change or a scroll display occurring and exceeds the [Sampling Cycle], because sampling is performed before the device/PLC's data is read, the previous data will remain displayed.
- When the [Sampling Cycle] is short (1 to 2 sec., or 100 ms), and a large process occurs such as a screen change, sampling will be disabled (sampling will be omitted) for a set period of time. As shown above, the previous data will also be treated as that round's data.

### 24.9.4 Saving to the CF-Card

Sampling data saved in a CF-card (SA\*\*\*\*\*.csv) is not identical with the setting contents on the [Display/Save in CSV] tab. The format is partly fixed as follows.

- Regardless of the settings, the calculation row will not be exported to a CSV file. The Item Name row and data display rows will be outputted.
- One Date column and one Time column will be displayed in a fixed position. When outputting as CSV, the Display Format is fixed as “yy/mm/dd” and “hh:mm:ss” (when the [Sampling Cycle] is set milliseconds in the Action Settings: “hh:mm:ss.000”).
- The Date/Time columns’ item names are fixed as “Date” and “Time”. In Custom Settings, even the Item Name row is not set, it will be displayed in the 1st row. In that case, the data column’s item name will be blank.
- Even if you set a Text row or Text column in the Custom Settings, they will not be outputted in the CSV file.

#### ■ Displaying CF-Card Data in Excel

CSV files saved in the CF-card (SA\*\*\*\*\*.csv) can be opened and edited in spreadsheet software (Microsoft Excel).

<When a sampling data CSV file is opened in Excel>

	Date	Time	D00100	D00200	D00300	D00301
No.1	2005/3/31	9:00:00	123.4	123	12.345	1234
No.2	2005/3/31	12:00:00	234.5	234	23.456	2345
No.3	2005/3/31	15:00:00	-321	-321	-32.1	-3210

- NOTE**
- If [Add Time Data] is not designated in the Action Settings, the Date column and Time column will be blank and only the item name will be displayed.
  - In Custom Settings, if the Item Name column is not set, the far left is the Date column, the 2nd is the Time column, and the 3rd and other columns are the Data columns. The order of the data columns will follow the order set in the Custom Settings.

◆ Excel Display Example for Simple Settings

The following will introduce an example for when data is saved to the CF-card with Simple Settings (CSV save) and the CSV file is then opened in Excel.

<Action Settings>

Action: Time Specification, [Overwrite old data after finishing the specified no. of times] is not set

Start Time: 09:00

Sampling Cycle: 3 hours

No. of Times: 4

No. of Blocks: 2

<Display/Save in CSV Settings>

	Date	Time	[PLC1]D00100	[PLC1]D00200	[PLC1]D00300	[PLC1]D00301
No.1	mm/dd	hh:mm	*****	*****	*****	*****
No.2	mm/dd	hh:mm	*****	*****	*****	*****
No.3	mm/dd	hh:mm	*****	*****	*****	*****
No.4	mm/dd	hh:mm	*****	*****	*****	*****
Total			*****	*****	*****	*****



<Excel Display>

	Date	Time	D00100	D00200	D00300	D00301
No.1	2005/3/31	9:00:00	322.8	30.3	25.3	6.1
No.2	2005/3/31	12:00:00	*****	*****	*****	*****
No.3	2005/3/31	15:00:00	324.4	28.6	27.6	6.2
No.4	2005/3/31	18:00:00	320.2	30.7	28.7	6.5
No.1	2005/4/1	9:00:00	321	26.9	29.9	6.3
No.2	2005/4/1	12:00:00	323.6	26.4	26.4	6.4

When a read error occurs, [\*\*\*\*\*] is displayed.

A blank row is inserted between blocks.

The Date data is "2005/04/01" when outputted in CSV format. In Excel, it is displayed as "2005/4/1".

The data is outputted in CSV format as "321.0". However, in Excel the final "0" after the decimal point is dropped, and "321" is displayed.

◆ **Excel Display Example for Simple Settings**

The following will introduce an example for when data is saved to the CF-card with custom settings (CSV save) and the CSV file is then opened in Excel.

- When [Overwrite old data after finishing the specified no. of times] is set <Display/Save in CSV Settings>

		1	2	3	4	5	6
	Item Name (Vertical)	Data1	Time	Data2	Data3	Data4	
1	Item Name (Horizontal)	Voltage	Time	Temp. 1	Temp. 2	Pressure	
2	Show Data	Data	hh:mm	xx.x	xx.x	xx.x	xx.x
3	Calculation	Sum		xx.x	xx.x	xx.x	xx.x
4	Calculation	Average		xx.x	xx.x	xx.x	xx.x



<Excel Display>

	Date	Time	Voltage	Temp. 1	Temp. 2	Pressure
Data	2005/3/31	9:00:00	3228	30.3	25.3	6.1
Data	2005/3/31	12:00:00	3236	26.4	26.4	6.4
Data	2005/3/31	15:00:00	3244	28.6	27.6	6.2
Data	2005/3/31	18:00:00	3202	30.7	28.7	6.5
Data	2005/1/4	9:00:00	3210	26.9	29.9	6.3

- When [Overwrite old data after finishing the specified no. of times] is not set <Display/Save in CSV Settings>

		1	2	3	4	5	6
	Item Name (Vertical)	Data1	Time	Data2	Data3	Data4	
1	Item Name (Horizontal)	Voltage	Time	Temp. 1	Temp. 2	Pressure	
2	No.1	1	xxxx	hh:mm	xx.x	xx.x	xx.x
3	No.2	2	xxxx	hh:mm	xx.x	xx.x	xx.x
4	No.3	3	xxxx	hh:mm	xx.x	xx.x	xx.x
5	No.4	4	xxxx	hh:mm	xx.x	xx.x	xx.x
6	Calculation	Sum	xxxxxx		xx.x	xx.x	xx.x
7	Calculation	Average	xxxx		xx.x	xx.x	xx.x



<Excel Display>

	Date	Time	Voltage	Temp. 1	Temp. 2	Pressure
1	2005/3/31	9:00:00	3228	30.3	25.3	6.1
2	2005/3/31	12:00:00	3236	26.4	26.4	6.4
3	2005/3/31	15:00:00	3244	28.6	27.6	6.2
4	2005/3/31	18:00:00	3202	30.7	28.7	6.5
1	2005/1/4	9:00:00	3210	26.9	29.9	6.3

## 24.9.5 Printing

There are two methods for printing sampling data: the method of printing data every time sampling occurs (Real Time Printing), and the method of printing data in collected groups (Block Unit Printing).

### <Real Time Print>

Data is printed each time sampling occurs.

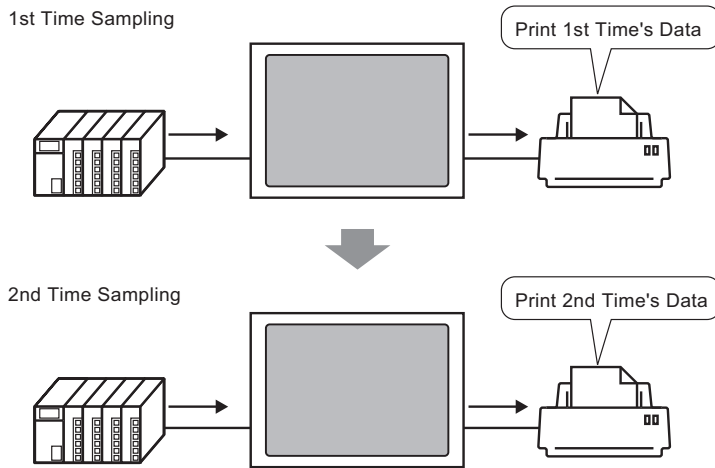

### <Block Print>

Designate the block number, turn ON bit 0 of the [Print Control Word Address], and all the data from the designated block will be outputted.

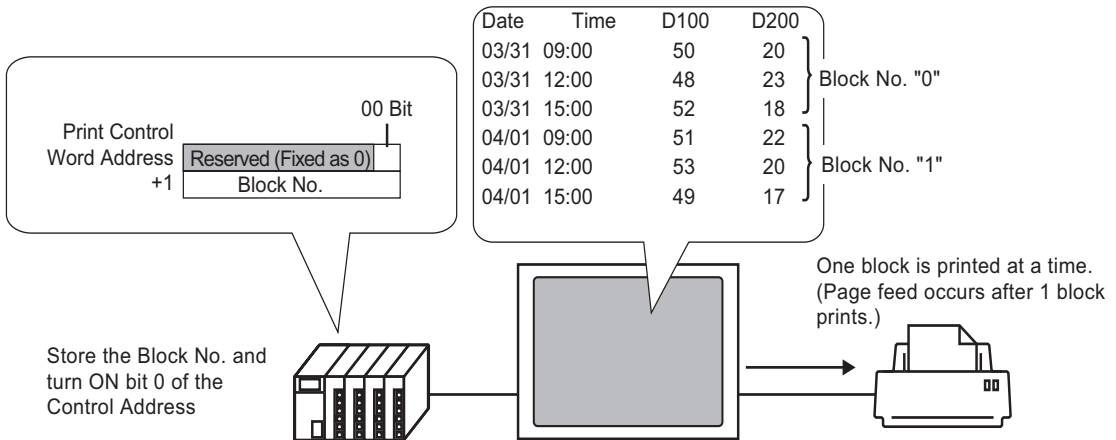

A daily report can be printed.

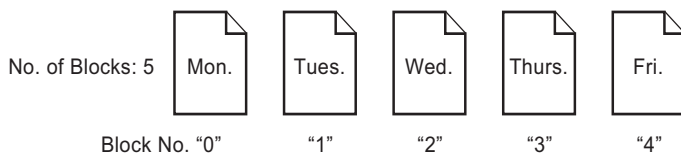

**NOTE**

- When [Overwrite old data after finishing the specified no. of times] is set in the Action Settings, only Real Time Print can be set.
- Before printing data, you must connect a printer to the GP and configure the printer settings.  
 ☞ “28.3.2 Printer Setup Procedure” (page 28-11)
- If [Add Time Data] is not set in the Action Settings, the Date column and Time column will be blank.
- You cannot configure the Position Settings (Align Right/Align Left) for Date columns and Time columns. Item Names are always aligned left and data is printed in the center.

e.g.)  
No. of Display Characters = 12

Date	Time
05/03/31	09:00
05/03/31	12:00

┌───┐┌───┐┌───┐┌───┐
2 8 2 4 5 3

**■ Print Example for Simple Settings**

In the Simple Settings, because of the fixed preset formats, a simple printing format can be created with only a few settings.

The format differs depending on whether or not [Overwrite old data after finishing the specified no. of times] is set in the Action Settings.

**◆ When [Overwrite old data after finishing the specified no. of times] is set (Real Time Print)**

<Print Format Settings>

Print Condition: Real Time Print

Item Name (Vertical): checked

Ruled Line: Enable

	yy/mm/dd	hh:mm	***.*	***.*	***.*	***.*
--	----------	-------	-------	-------	-------	-------



<Print Image>

	05/03/31 09:00	322.8	30.3	25.3	6.1
	05/03/31 12:00	323.6	26.4	26.4	6.4
	05/03/31 15:00	324.4	28.6	27.6	6.2
	05/03/31 18:00	320.2	30.7	28.7	6.5
	05/04/01 09:00	321.0	26.9	29.9	6.3
	05/04/01 12:00	321.9	29.2	24.0	6.0
	05/04/01 15:00	322.7	31.1	25.1	6.3
	05/04/01 18:00	323.5	27.3	26.3	6.1

- All of the selected addresses' data is printed.

◆ When [Overwrite old data after finishing the specified no. of times] is not set

<Print Format Settings>

Print Condition: Real Time Print/Block Print

Item Name (Horizontal): checked

Item Name (Vertical): checked

Toal row: checked

	Date	Time	D00100	D00200	D00300	D00301
No.1	yy/mm/dd	hh:mm	****	****	****	****
No.2	yy/mm/dd	hh:mm	****	****	****	****
No.3	yy/mm/dd	hh:mm	****	****	****	****
No.4	yy/mm/dd	hh:mm	****	****	****	****
Total			*****	*****	*****	*****



<Print Image>

	Date	Time	D00100	D00200	D00300	D00301
No. 1	05/03/31	09:00	322.8	30.3	25.3	6.1
No. 2	05/03/31	12:00	323.6	26.4	26.4	6.4
No. 3	05/03/31	15:00	324.4	28.6	27.6	6.2
No. 4	05/03/31	18:00	320.2	30.7	28.7	6.5
Total			1291.0	116.0	108.0	25.2

These values are calculated from data sampled from the designated No. of Times (1 block)

- The Item Name row is printed in the 1st row. The Date column and Time column appear as [Date] and [Time]. Each data column has an address printed as its item name.
- All of the selected addresses' data is printed.
- In the Item Name column, a number will be printed which indicates the sampling round. (e.g.: 3rd round = "No. 3")
- The Total row is printed after the data display rows.
- Regardless of whether Real Time Print or Block Print is used, a form feed occurs after printing.

### ■ Print Example for Custom Settings

You can create the following type of customized format with Custom Settings.

- You can set each data column's Display Range, No. of Display Digits, etc.
- You can add Date columns, Time columns, Data columns, Text columns, and Ruled Line.
- You can directly input text in Text columns, Text rows, and Item Name rows.
- When [Overwrite old data after finishing the specified no. of times] is not set in the Action Settings, you can print the header/footer's and calculation rows (Total, Average, Max, Min).

**NOTE**

- The maximum number of columns is 521, and the maximum number of rows 4,204.
- Text in the Text row or Text column can only be inputted in the language set in the [Sampling List] tab's [Language Settings].

### ◆ When [Overwrite old data after finishing the specified no. of times] is set

<Print Format Settings>

Print Condition: Real Time Print

	1	2	3	4	5	6	7	8	9	10	11	12
		Time		Text	Data1		Text	Data2		Text	Data4	
1	Text	Time			D100			D200			D301	
2		+ .....	+ .....	.....	+ .....	.....	+ .....	.....	+ .....	.....	+ .....	
3	Show Data	hh:mm		Voltage	****		Temp. 1	**.*		Pressure	**.*	



<Print Image>

	09:00		Voltage	3228		Temp. 1	30.3		Pressure	6.1	
	12:00		Voltage	3236		Temp. 1	26.4		Pressure	6.4	
	15:00		Voltage	3244		Temp. 1	28.6		Pressure	6.2	
	18:00		Voltage	3202		Temp. 1	30.7		Pressure	6.5	
	09:00		Voltage	3210		Temp. 1	26.9		Pressure	6.3	
	12:00		Voltage	3219		Temp. 1	29.2		Pressure	6.0	
	15:00		Voltage	3227		Temp. 1	31.1		Pressure	6.3	
	18:00		Voltage	3235		Temp. 1	27.3		Pressure	6.1	

**NOTE**

- Only the data display rows will be printed. Ruled Line rows and Text rows are not printed. When the Header/Footer is set, printing will not be performed.

◆ When [Overwrite old data after finishing the specified no. of times] is not set

<Print Format Settings>

Print Condition: Real Time Print/Block Print

Header is set.

	1	2	3	4	5	6	7	8	9	10	11
		Date	Time	Data1	Data2	Data3	Data4		Text		
1	+	-----	+ -----	-----	-----	-----	-----	-----	+ -----	+	
2	Text	Date	Time	Volt.	Temp. 1	Temp. 2	Pressure				
3		+ -----	+ -----	-----	-----	-----	-----	-----	+ -----	+	
4	No.1	yy/mm/dd	hh:mm	xxxx	xx x	xx x	xx x		Monday		
5	No.2	yy/mm/dd	hh:mm	xxxx	xx x	xx x	xx x		Monday		
6	No.3	yy/mm/dd	hh:mm	xxxx	xx x	xx x	xx x		Monday		
7	No.4	yy/mm/dd	hh:mm	xxxx	xx x	xx x	xx x		Monday		
8		+ -----	+ -----	-----	-----	-----	-----	-----	+ -----	+	
9	Calculation			xxxxx	xxx x	xxx x	xxx x		Total		
10	Calculation			xxxxx	xxx x	xxx x	xxx x		Average		
11	Calculation			xxxxx	xxx x	xxx x	xxx x		Max		
12	Calculation			xxxxx	xxx x	xxx x	xxx x		Min		
13		+ -----	+ -----	-----	-----	-----	-----	-----	+ -----	+	



<Print Image>

Ack.   Examine   Create						
Date	Time	Volt.	Temp. 1	Temp. 2	Pr.	
05/03/31	09:00	3228	30.3	25.3	6.1	Monday
05/03/31	12:00	3236	26.4	26.4	6.4	Monday
05/03/31	15:00	3244	28.6	27.6	6.2	Monday
05/03/31	18:00	3202	30.7	28.7	6.5	Monday
		12910	116.0	108.0	25.2	Total
		3227	29.0	27.0	6.3	Average
		3244	30.7	28.7	6.5	Max
		3202	26.4	25.3	6.1	Min

Calculation Rows

The calculation data are values calculated from data sampled from the designated No. of Times (1 block).

**NOTE**

- The printing format consists of the three areas: the header, the main area, and the footer.

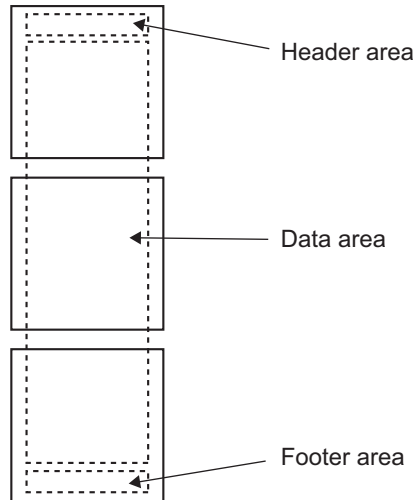

- For Real Time Print, the header area is printed when the block's initial data is printed. The calculation row(s) and the footer are printed when the block's final data is printed.
  - Regardless of whether Real Time Print or Block Print is used, a form feed occurs after printing.
  - If you changed the [No. of Times] in the Action Settings after setting the Print Format, change the [No. of Data Display Rows] according to the number of times.
-

### 24.9.6 Writing to the Internal Device

By writing sampling data to the GP's internal device (LS Area, USR Area), you can display one data item from among the sampled data using a Data Display or Graph Part, and use that data independently.

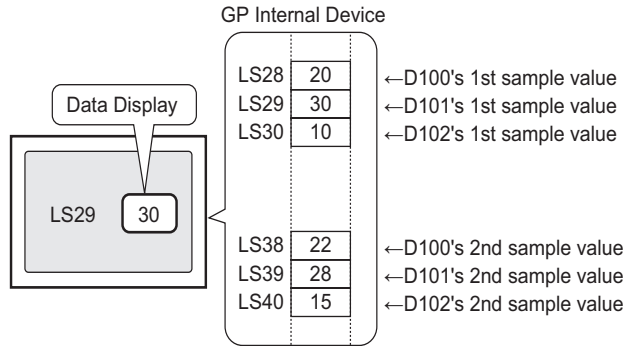

#### ■ Action for Writing to the Internal Device

Turn ON the designated [Write Trigger Bit Address], and sampling data stored in backup SRAM (or DRAM) is written to the internal device.

If [Overwrite old data after finishing the specified no. of times] is not set on the [Action Settings] tab's Extended Settings, you can write each block.

#### <Writing Sampling Data>

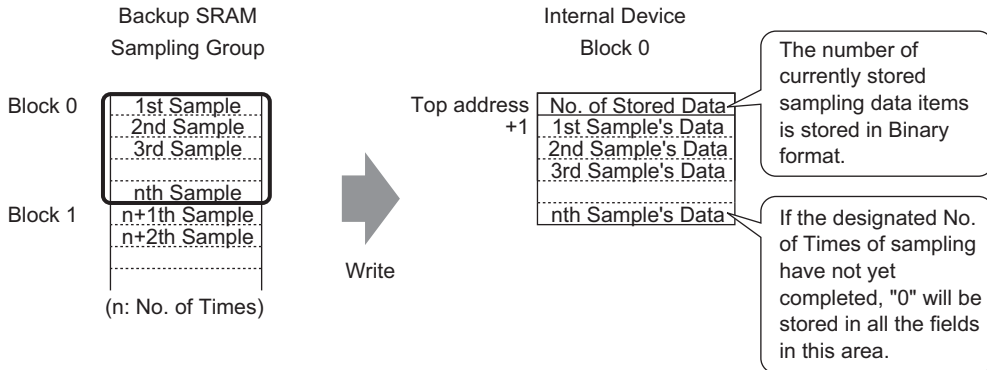

When storing sampling data to the internal device, the sampling round that is currently proceeding (which data has been stored) is saved in the top address in Binary format.

For example, if the No. of Times is 5, and the current sampling round is 2, then [No. of Stored Data] will be "2". At that time, "0" will be stored in sampling data storage area for sample 3 and later.

- NOTE** • If [Overwrite old data after finishing the specified no. of times] is designated in the Action Settings, sampling data will be transferred in order starting with old data.

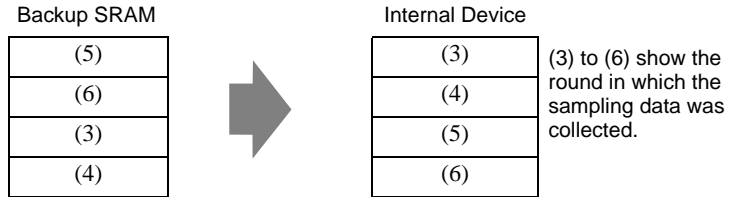

- If no block number is stored, data from block number “0” will be written.
- If you set a calculation row with the [Display/Save in CSV] tab, you can also write calculation data to the internal device. Sampling data and calculation data are written separately.
- If the size of blocks or calculation data to be written is larger than the internal device’s storage area, they can not be written.

◆ **The Structure of Sampling Data stored in the Internal Device**

<When the internal device is 16 bit>

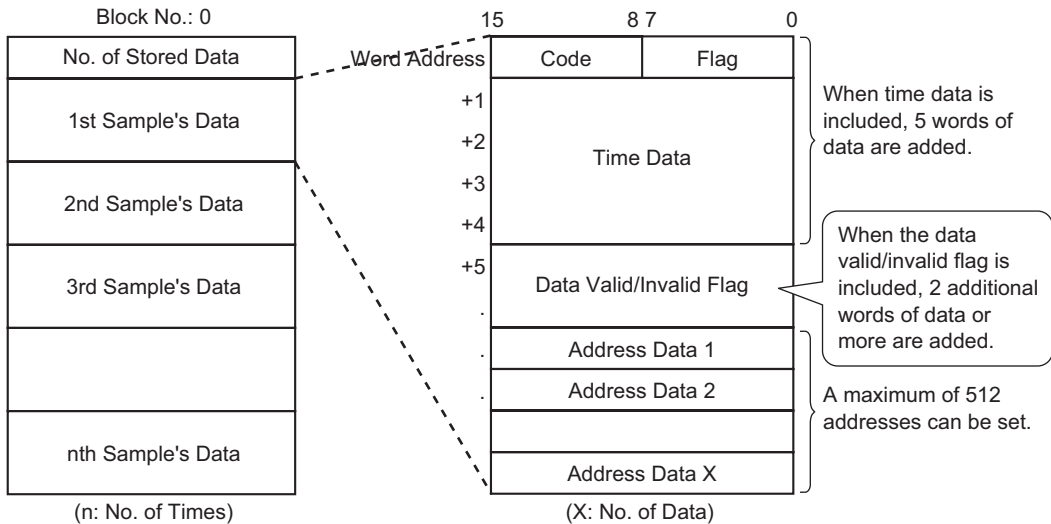

- **Code/Flag**  
If [Add Time Data] is set in the Extended Settings of the [Action Settings] tab, you can monitor whether sampling is completed and whether the sampling read normally or a read error occurred.

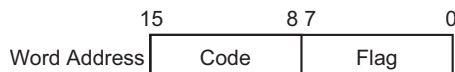

**Flag**

The flag’s value is “1” when sampling is complete, and “0” when sampling is not occurring.

**Code**

The code’s value is “0” when data is being read correctly, and “1” when there is a read error.

- Time Data

If [Add Time Data] is set in the Extended Settings of the [Action Settings] tab, the sample's time data is stored as in the following picture. The data is 2 digits long and saved in BCD format.

When the sampling cycle is set in seconds:

	15	8	7	0
+1		Year		
+2	Month	Day		
+3	Hour	Minute		
+4		Second		

When the sampling cycle is set in milliseconds:

	15	8	7	0
+1		Year		
+2	Month	Day		
+3	Hour	Minute		
+4	Second	Millisecond		

**NOTE**

- When the Execution Condition is set to [Bit ON], the Time data will represent the time when the data read completes.
- When the sampling cycle is set in milliseconds, the data will be stored in 10 ms units.

e.g.) March, 31, 2005 17h30m25s600ms

	15	8	7	0
+1		05		
+2	03	31		
+3	17	30		
+4	25	60		

60 x 10ms

- Data Valid/Invalid Flag

If the Execution Condition is set to [Time Specification] or [Bit ON], the [Data Valid/Invalid Flag] to monitor whether each designated address's data is valid or invalid is added to the sampling data. Valid data is marked with "1", invalid data with "0". For example, when a read error occurs during sampling, "1" is stored in [Code], and each address's data valid/invalid bit is "0". When the value of erroneous sampling data (data displayed with "\*\*\*\*") is corrected, that data changes from invalid to valid, and the corrected address's data valid/invalid bit changes from "0" to "1". The storage area for the data valid/disabled flags fluctuates from 2 to 32 addresses.

Each address' data valid/invalid bit

	15																	0
+1	16	15	14	13	12	11	10	9	8	7	6	5	4	3	2	1		
+2	32	31	30	29	28	27	26	25	24	23	22	21	20	19	18	17		
	⋮																	
+32	512	511	510	509	508	507	506	505	504	503	502	501	500	499	498	497		

◆ **The Structure of Calculation Data stored in the Internal Device**

The structure of calculation data (Total, Average, Max, Min) is set according to settings in the [Display/Save in CSV] tab and is shown in the following diagram. Bit length is 32 bit and data is stored in the internal device.

Calculated values are stored in order from the top down, starting with the leftmost data column designated in the [Display/Save in CSV] format.

<When Total and Average are set>

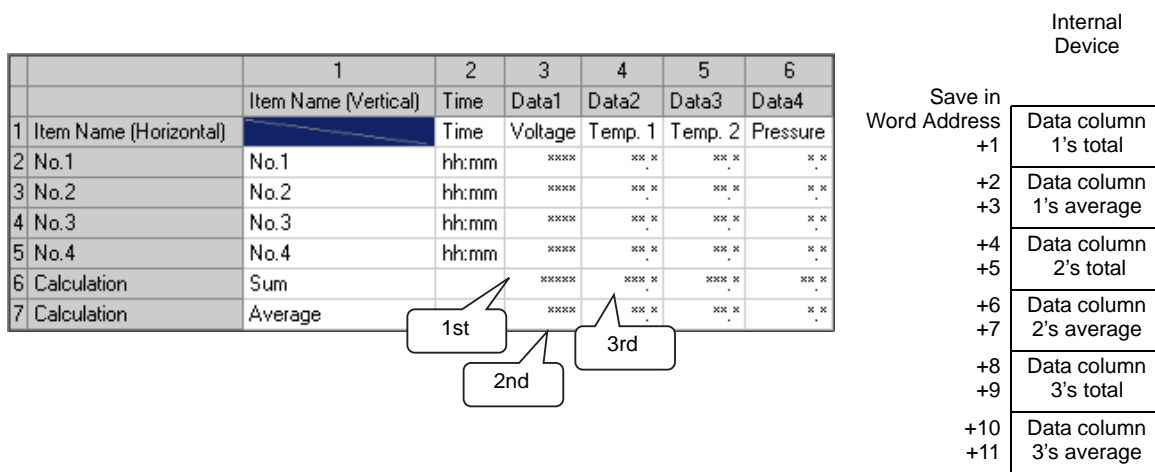

## 24.10 Restrictions

### 24.10.1 Data Sampling Restrictions

- Up to 64 Sampling Groups can be set in the system.
- The maximum number of data item (number of addresses) that can be sampled at one time is 512 for 16 bit length, and 256 for 32 bit length.
- The maximum No. of Times (or No. of Times × No. of Blocks) that can be set for a single Sampling Group differs depending on the No. of Data (No. of Addresses) to be sampled at one time, the data length, and the Action Settings.

When the No. of Data (No. of Addresses) to sample at once is one, the maximum No. of Times (or No. of Times × No. of Blocks) will be as follows for the entire system.

Condition	Data Length: 16 Bit	Data Length: 32 Bit
Only Sampling Data	Up to 162,666 times	Up to 81,332 times
Sampling Data + Time Data	Up to 23,238 times	Up to 20,332 times
Sampling Data + Data Valid/Invalid Flag	Up to 54,222 times	Up to 40,666 times
Sampling Data + Time Data + Data Valid/Invalid Flag	Up to 18,074 times	Up to 16,266 times

- After the GP is powered ON and the internal programs are prepared, one second maximum of delay time may occur before the sampling starts.
- For the Execution Condition - [Constant Cycle], [Constant Cycle when Bit is ON], and [Bit Change], because all the set address data is being read, the communication may put a burden on the system if the number of addresses to sample is large.
- If the Execution Condition is [Constant Cycle], or [Constant Cycle when Bit is ON], even if the set [Sampling Cycle] is longer than the communication cycle time, there may be cases where the communication cycle time<sup>\*1</sup> exceeds the [Sampling Cycle], due to a screen change, scroll display, etc. In that case, because sampling occurs before reading data from the device/PLC, the previous data is treated as that round's sampling data.
- When the [Sampling Cycle] is short (1 to 2 sec., or 100 ms), and a large process occurs such as a screen change, sampling will be disabled (sampling will be omitted) for a set period of time. As shown above, the previous data will also remain displayed.
- If [Random] is selected, communication with the device may take longer than when [Sequential] is selected.

\*1 The communication cycle time is the time it takes to request and take in data from the GP unit to the PLC. It is stored in the internal device's LS2037 as binary data. The unit is 10ms.

## 24.10.2 Display Restrictions

- One Sampling Data Display can be placed per screen. If multiple Displays are displayed on one screen, only the Display set first is active.
- A Sampling Data Display cannot be set to the screen at the same time as a Special Data Display [Show CSV] or a Data Display which uses a pop-up keypad.
- The calculation operations are carried out in 32 bit length. If the calculation data has more digits (exceeds 32 bits), the calculation will become irregular and will not display correctly.
- When [Overwrite old data after finishing the specified no. of times] is designated in the Action Settings, the calculation rows (Total, Average, Max, Min) will show the calculated value of the data housed in the GP. Overwritten data is not included in the calculations.
- In the sampling group's Address Settings, if the [Bit Length] or [Addressing] change, the [Display/Save in CSV] format will be reset.
- When changing the [Display/Save in CSV] settings from [Custom Settings] to [Simple Settings], all customized settings will be reset.

## 24.10.3 Restrictions on saving to a CF-Card

- Please ensure that multiple sampling groups or the System Settings' Control Word Address for CF-Card Data Storage do not have the same [CSV Control Word Address]. If they are the same, the trigger and status cannot be used correctly.

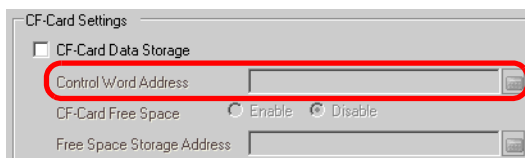

- Multiple sampling groups cannot be saved to the CF-card at the same time. Please ensure that one group's save is completed before setting the next group's [CSV Control Word Address]. If multiple groups are saved at the same time, it is unclear which group will be saved.
- You cannot save sampling data together with other data (Alarm History data, Recipe data, etc.) to the CF-card.
- For Auto Save, if the time taken for one sampling round is short (the Sampling Cycle is short, the No. of Times is small, etc.), it is possible that data sampling will be performed while data is still being written to the CF-card. In this case, data sampling will be suspended until the writing of sampling data is completed for that cycle.
- For Auto Save, if the Sampling Cycle is short or the No. of Times is small, the data write to the CF-Card will be performed frequently. This, however, can shorten the CF-card's data write life.
- In the sampling group's Address Settings, if the [Bit Length] or [Addressing] change, the [Display/Save in CSV] format will be reset.
- When changing the [Display/Save in CSV] settings from [Custom Settings] to [Simple Settings], all customized settings will be reset.

---

## 24.10.4 Restrictions on Printing

---

- Up to 160 single-byte characters can be printed in a single line.
- You cannot designate the size of the characters to print.
- When printing sampling data, any portion wider than A4 will not be printed. The number of characters that can be printed on one line depends on the printer.
- Regardless of the printer's color settings (monochrome/color), all data is printed in black and white.
- When the sampling group's font type is set to [Stroke Font] and the language is set to [Taiwanese], [Chinese] or [Korean], image data is printed out, and may take some time to print.
- DO NOT enter other printing commands during real-time printing. If an Alarm History printing command occurs during real-time printing, the alarm history and other data will be mixed together during printing.
- If sampling data is deleted during printing, printing will not continue. Also, printing can not be resumed if the GP is turned OFF during printing.
- The calculation operations are carried out in 32 bit length. If the calculation data has more digits (exceeds 32 bits), the calculation will become irregular and the correct value will not be printed.
- When [Overwrite old data after finishing the specified no. of times] is designated in the Action Settings, if the No. of Times is small or a short Sampling Cycle is being used, there are cases where the printing speed is slower than the speed at which data is overwritten and stored, and sampling data changes. When sampling data is overwritten before printing, the data prior to the overwrite cannot be printed.
- In the sampling group's Address Settings, if the [Bit Length] or [Addressing] change, the print format will be reset.
- When changing the print mode from [Custom Settings] to [Basic Settings], all customized settings will be reset.
- When using Custom Settings, the maximum number of columns that can be set with the print format is 521 columns. The maximum number of rows is 4,204.  
The maximum number of columns is the total of the Date, Time, Data, Text, and Ruled Line columns. The maximum number of rows is the total of the Data, Calculation, and Ruled Line rows. Calculation rows and the header/footer areas are not included.

---

# *Memo*