



FB Series SIO Driver

1	System Configuration.....	3
2	Selection of External Device	9
3	Example of Communication Setting.....	10
4	Setup Items.....	33
5	Cable Diagram	38
6	Supported Devices.....	87
7	Device Code and Address Code.....	89
8	Error Messages.....	90

Introduction

This manual describes how to connect the Display and the External Device.

In this manual, the connection procedure will be described by following the sections below:

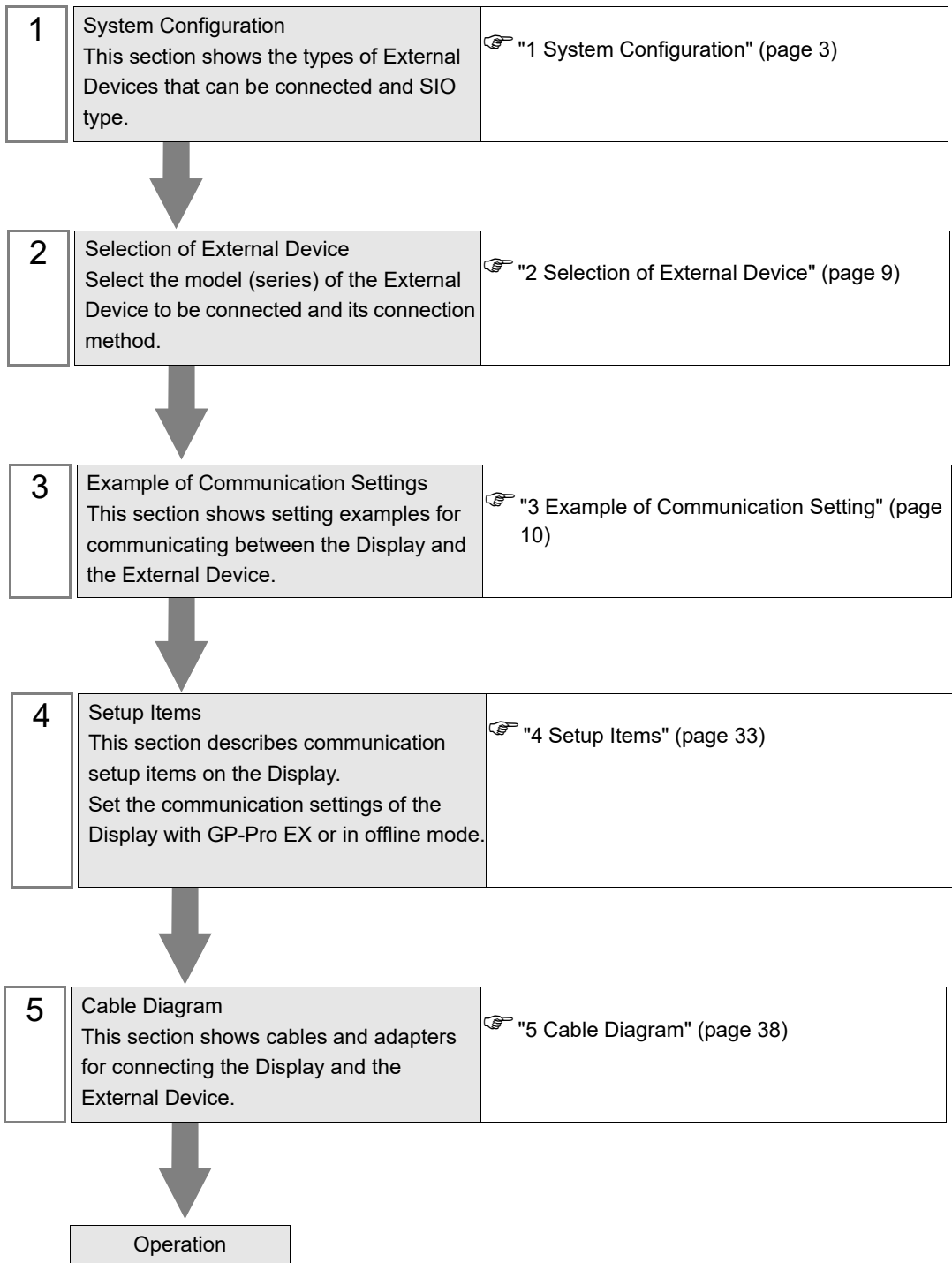

1 System Configuration

The following shows the system configuration where the External Device of Fatek Automation Corporation and the Display are connected.

Series	CPU	Link I/F		SIO Type	Setting Example	Cable Diagram
FBs*1	FBs-10MA/MC FBs-14MA/MC FBs-20MA/MC FBs-24MA/MC FBs-32MA/MC FBs-40MA/MC FBs-60MA/MC FBs-20MN FBs-32MN FBs-44MN	CPU unit*2	Port 0	RS232C	Setting Example 1 (page 10)	Cable Diagram 1 (page 38)
		FBs-CB2	Port 2	RS232C	Setting Example 2 (page 11)	Cable Diagram 2 (page 39)
		FBs-CB22	Port 1	RS232C	Setting Example 3 (page 13)	Cable Diagram 2 (page 39)
			Port 2	RS232C	Setting Example 2 (page 11)	
		FBs-CB25	Port 1	RS232C	Setting Example 3 (page 13)	Cable Diagram 2 (page 39)
			Port 2	RS422/485 (2wire)	Setting Example 4 (page 15)	Cable Diagram 4 (page 42)
		FBs-CB5	Port 2	RS422/485 (2wire)	Setting Example 4 (page 15)	Cable Diagram 4 (page 42)
		FBs-CB55	Port 1	RS422/485 (2wire)	Setting Example 5 (page 17)	Cable Diagram 4 (page 42)
			Port 2	RS422/485 (2wire)	Setting Example 4 (page 15)	
		FBs-CM22	Port 3	RS232C	Setting Example 6 (page 19)	Cable Diagram 3 (page 40)
			Port 4	RS232C	Setting Example 7 (page 21)	
		FBs-CM25	Port 3	RS232C	Setting Example 6 (page 19)	Cable Diagram 3 (page 40)
			Port 4	RS422/485 (2wire)	Setting Example 9 (page 25)	Cable Diagram 4 (page 42)

Series	CPU	Link I/F		SIO Type	Setting Example	Cable Diagram		
FBs *1	FBs-10MA/MC FBs-14MA/MC FBs-20MA/MC FBs-24MA/MC FBs-32MA/MC FBs-40MA/MC FBs-60MA/MC FBs-20MN FBs-32MN FBs-44MN	FBs-CM25E	Port 3	RS232C	Setting Example 6 (page 19)	Cable Diagram 3 (page 40)		
			Port 4	RS422/485 (2wire)	Setting Example 9 (page 25)	Cable Diagram 4 (page 42)		
		FBs-CM55	Port 3	RS422/485 (2wire)	Setting Example 8 (page 23)	Cable Diagram 4 (page 42)		
			Port 4	RS422/485 (2wire)	Setting Example 9 (page 25)			
		FBs-CM55E	Port 3	RS422/485 (2wire)	Setting Example 8 (page 23)	Cable Diagram 4 (page 42)		
			Port 4	RS422/485 (2wire)	Setting Example 9 (page 25)			
		FBe/FBn *1	FBe-20MA FBe-28MA FBe-40MA	CPU unit	Port 0	RS232C	Setting Example 11 (page 28)	Cable Diagram 5 (page 55)
						RS422/485 (2wire)	Setting Example 10 (page 27)	Cable Diagram 6 (page 58)
FBe-20MC FBe-28MC FBe-40MC FBn-19MCT FBn-26MCT FBn-36MCT	CPU unit		Port 0	RS232C	Setting Example 11 (page 28)	Cable Diagram 5 (page 55)		
				RS422/485 (2wire)	Setting Example 10 (page 27)	Cable Diagram 6 (page 58)		
			Port 1	RS232C	Setting Example 12 (page 29)	Cable Diagram 7 (page 71)		
			Port 2	RS422/485 (2wire)	Setting Example 13 (page 31)	Cable Diagram 8 (page 73)		
	FB-DTBR		Port 0	RS232C	Setting Example 11 (page 28)	Cable Diagram 3 (page 40)		
			Port 1	RS232C	Setting Example 12 (page 29)	Cable Diagram 9 (page 85)		
Port 2			RS422/485 (2wire)	Setting Example 13 (page 31)	Cable Diagram 6 (page 58)			

Series	CPU	Link I/F		SIO Type	Setting Example	Cable Diagram
FBe/FBn *1	FBe-20MC FBe-28MC FBe-40MC FBn-19MCT FBn-26MCT FBn-36MCT	FB-DTBR-E	Port 0	RS232C	Setting Example 11 (page 28)	Cable Diagram 3 (page 40)
			Port 2	RS422/485 (2wire)	Setting Example 13 (page 31)	Cable Diagram 6 (page 58)

*1 Set the software's interface to "Standard Interface". Refer to your External Device manual for the correct settings.

*2 Available only with a CPU incorporating an RS232 port.

■ Connection Configuration

- 1:1 Connection



- 1:n Connection

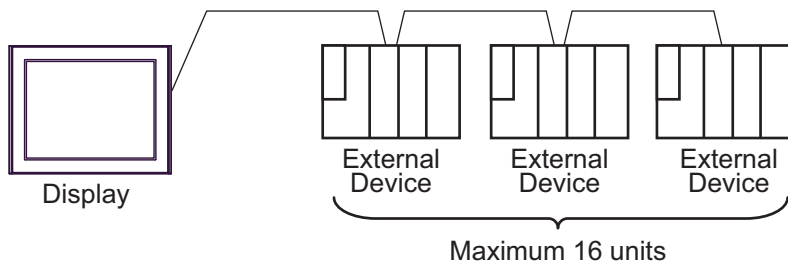

■ IPC COM Port

When connecting IPC with an External Device, the COM port used depends on the series and SIO type. Please refer to the IPC manual for details.

Usable port

Series	Usable Port		
	RS-232C	RS-422/485(4 wire)	RS-422/485(2 wire)
PS-2000B	COM1 ^{*1} , COM2, COM3 ^{*1} , COM4	-	-
PS-3450A, PS-3451A, PS3000-BA, PS3001-BD	COM1, COM2 ^{*1*2}	COM2 ^{*1*2}	COM2 ^{*1*2}
PS-3650A (T41 model), PS-3651A (T41 model)	COM1 ^{*1}	-	-
PS-3650A (T42 model), PS-3651A (T42 model)	COM1 ^{*1*2} , COM2	COM1 ^{*1*2}	COM1 ^{*1*2}
PS-3700A (Pentium®4-M) PS-3710A	COM1 ^{*1} , COM2 ^{*1} , COM3 ^{*2} , COM4	COM3 ^{*2}	COM3 ^{*2}
PS-3711A	COM1 ^{*1} , COM2 ^{*2}	COM2 ^{*2}	COM2 ^{*2}
PS4000 ^{*3}	COM1, COM2	-	-
PL3000	COM1 ^{*1*2} , COM2 ^{*1} , COM3, COM4	COM1 ^{*1*2}	COM1 ^{*1*2}
PE-4000B Atom N270	COM1, COM2	-	-
PE-4000B Atom N2600	COM1, COM2	COM3 ^{*4} , COM4 ^{*4} , COM5 ^{*4} , COM6 ^{*4}	COM3 ^{*4} , COM4 ^{*4} , COM5 ^{*4} , COM6 ^{*4}
PS5000 (Slim Panel Type Core i3 Model) ^{*5*6}	COM1, COM2 ^{*4}	COM2 ^{*4}	COM2 ^{*4}
PS5000 (Slim Panel Type Atom Model) ^{*5*6}	COM1, COM2 ^{*7}	COM2 ^{*7}	COM2 ^{*7}
PS5000 (Enclosed Panel Type) ^{*8}	COM1	-	-
PS5000 (Modular Type PFXPU/PFXPP) ^{*5*6} PS5000 (Modular Type PFXPL2B5-6)	COM1 ^{*7}	COM1 ^{*7}	COM1 ^{*7}
PS5000 (Modular Type PFXPL2B1-4)	COM1, COM2 ^{*7}	COM2 ^{*7}	COM2 ^{*7}
PS6000 (Advanced Box) PS6000 (Standard Box)	COM1 ^{*9}	*10	*10
PS6000 (Basic Box)	COM1 ^{*9}	COM1 ^{*9}	COM1 ^{*9}

*1 The RI/5V can be switched. Use the IPC's switch to change if necessary.

*2 Set up the SIO type with the DIP Switch. Please set up as follows according to SIO type to be used.

- *3 When making communication between an External Device and COM port on the Expansion slot, only RS-232C is supported. However, ER (DTR/CTS) control cannot be executed because of the specification of COM port.
For connection with External Device, use user-created cables and disable Pin Nos. 1, 4, 6 and 9. Please refer to the IPC manual for details of pin layout.
- *4 Set up the SIO type with the BIOS. Please refer to the IPC manual for details of BIOS.
- *5 When setting up communication between an External Device and the RS-232C/422/485 interface module, use the IPC (RS-232C) or PS5000 (RS-422/485) cable diagrams. However, when using PFXZPBMPR42P2 in a RS-422/485 (4-wire) configuration with no flow control, connect 7.RTS+ and 8.CTS+, and connect 6.RTS- and 9.CTS-.
When using RS-422/485 communication with External Devices, you may need to reduce the transmission speed and increase the TX Wait time.
- *6 To use RS-422/485 communication on the RS-232C/422/485 interface module, the DIP Switch setting is required. Please refer to "Knowledge Base" (FAQs) on the support site. (<http://www.pro-face.com/trans/en/manual/1001.html>)

Settings	FAQ ID
PFXZPBMPR42P2, RS422/485 change method	FA263858
PFXZPBMPR42P2 termination resistor setting	FA263974
PFXZPBMPR44P2, RS422/485 change method	FA264087
PFXZPBMPR44P2 termination resistor setting	FA264088

- *7 Set up the SIO type with the DIP Switch. Please refer to the IPC manual for details of DIP Switch. The BOX Atom has not a switch to set the RS-232C, RS-422/485 mode. Use the BIOS for the setting.
- *8 For the connection with the External Device, on the user-created cable read as if the connector on the Display-side is a M12 A-coding 8 pin socket. The pin assignment is the same as described in the cable diagram. For the M12 A-coding connector, use PFXZPSCNM122.
- *9 In addition to COM1, you can also use the COM port on the optional interface.
- *10 Install the optional interface in the expansion slot.

DIP Switch settings (PL3000 / PS3000 Series)

RS-232C

DIP Switch	Setting	Description
1	OFF*1	Reserved (always OFF)
2	OFF	SIO type: RS-232C
3	OFF	
4	OFF	Output mode of SD (TXD) data: Always output
5	OFF	Terminal resistance (220Ω) insertion to SD (TXD): None
6	OFF	Terminal resistance (220Ω) insertion to RD (RXD): None
7	OFF	Short-circuit of SDA (TXA) and RDA (RXA): Not available
8	OFF	Short-circuit of SDB (TXB) and RDB (RXB): Not available
9	OFF	RS (RTS) Auto control mode: Disabled
10	OFF	

*1 When using PS-3450A, PS-3451A, PS3000-BA and PS3001-BD, turn ON the set value.

RS-422/485 (4 wire)

DIP Switch	Setting	Description
1	OFF	Reserved (always OFF)
2	ON	SIO type: RS-422/485
3	ON	
4	OFF	Output mode of SD (TXD) data: Always output
5	OFF	Terminal resistance (220Ω) insertion to SD (TXD): None
6	OFF	Terminal resistance (220Ω) insertion to RD (RXD): None
7	OFF	Short-circuit of SDA (TXA) and RDA (RXA): Not available
8	OFF	Short-circuit of SDB (TXB) and RDB (RXB): Not available
9	OFF	RS (RTS) Auto control mode: Disabled
10	OFF	

RS-422/485 (2 wire)

DIP Switch	Setting	Description
1	OFF	Reserved (always OFF)
2	ON	SIO type: RS-422/485
3	ON	
4	OFF	Output mode of SD (TXD) data: Always output
5	OFF	Terminal resistance (220Ω) insertion to SD (TXD): None
6	OFF	Terminal resistance (220Ω) insertion to RD (RXD): None
7	ON	Short-circuit of SDA (TXA) and RDA (RXA): Available
8	ON	Short-circuit of SDB (TXB) and RDB (RXB): Available
9	ON	RS (RTS) Auto control mode: Enabled
10	ON	

2 Selection of External Device

Select the External Device to be connected to the Display.

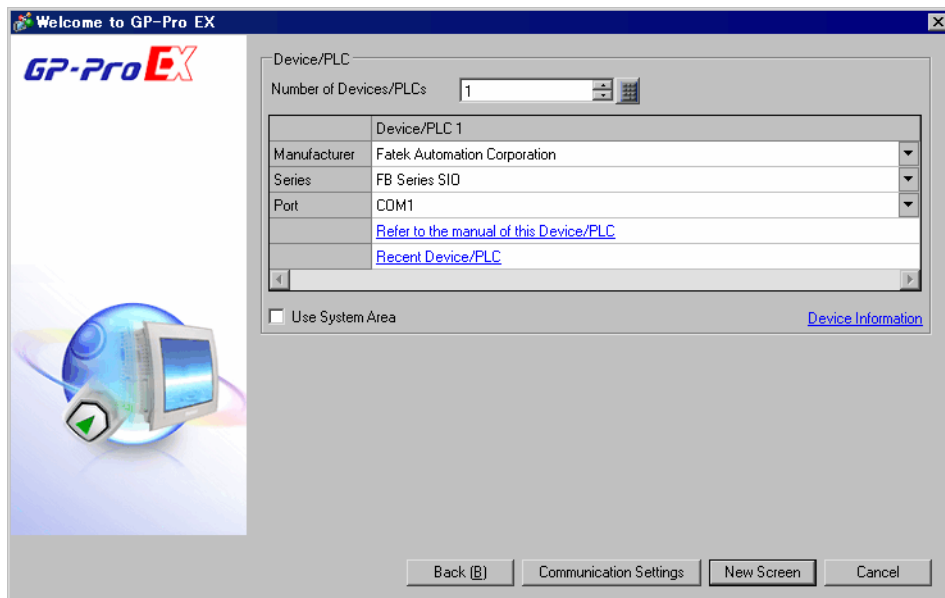

Setup Items	Setup Description
Number of Devices/ PLCs	Enter an integer from 1 to 4 to define the number of Devices/PLCs to connect to the display.
Manufacturer	Select the manufacturer of the External Device to connect. Select "Fatek Automation Corporation".
Series	Select the model (series) of the External Device to be connected and its connection method. Select "FB Series SIO". In System configuration, make sure the External Device you are connecting is supported by "FB Series SIO". ☞ "1 System Configuration" (page 3)
Port	Select the port of the Display to be connected to the External Device.
Use System Area	Check this option to synchronize the system data area of the Display and the device (memory) of the External Device. When synchronized, you can use the External Device's ladder program to switch the display or display the window on the Display. Cf. GP-Pro EX Reference Manual "LS Area (Direct Access Method Area)" This feature can also be set in GP-Pro EX or in the Display's offline mode. Cf. GP-Pro EX Reference Manual "System Settings [Display Unit] - [System Area] Settings Guide" Cf. Maintenance/Troubleshooting Guide "Main Unit - System Area Settings"

3 Example of Communication Setting

The following shows examples of communication settings for the Display and the External Device, which are recommended by Pro-face.

3.1 Setting Example 1

■ Settings of GP-Pro EX

◆ Communication Settings

To display the setup screen, from the [Project] menu, point to [System Settings] and select [Device/PLC].

◆ Device Setting

To display the [Individual Device Settings] dialog box, from [Device-Specific Settings] in the [Device/PLC] window, select the external device and click [Settings] .

To connect multiple External Devices, from [Device-Specific Settings] in the [Device/PLC] window, click [Add Device] to add another External Device.

■ Settings of External Device

The communication setting is fixed.

3.2 Setting Example 2

■ Settings of GP-Pro EX

◆ Communication Settings

To display the setup screen, from the [Project] menu, point to [System Settings] and select [Device/PLC].

The screenshot shows the 'Device/PLC 1' configuration window. The 'Summary' section includes 'Manufacturer' (Fatek Automation Corporation), 'Series' (FB Series SIO), and 'Port' (COM1). The 'Text Data Mode' is set to '1'. The 'Communication Settings' section includes:

- SIO Type: RS232C, RS422/485(2wire), RS422/485(4wire)
- Speed: 9600
- Data Length: 7, 8
- Parity: NONE, EVEN, ODD
- Stop Bit: 1, 2
- Flow Control: NONE, ER(DTR/CTS), XON/XOFF
- Timeout: 3 (sec)
- Retry: 2
- Wait To Send: 0 (ms)

 A sub-section for 'RI / VCC' has RI selected. A note below it states: 'In the case of RS232C, you can select the 9th pin to RI (Input) or VCC (5V Power Supply). If you use the Digital's RS232C Isolation Unit, please select it to VCC.' A 'Default' button is present. The 'Device-Specific Settings' section shows 'Allowable Number of Devices/PLCs' as 16 and an 'Add Device' button. A table below lists device settings:

No.	Device Name	Settings
1	PLC1	Station No.=1

 An 'Add Indirect Device' button is also visible.

◆ Device Setting

To display the [Individual Device Settings] dialog box, from [Device-Specific Settings] in the [Device/PLC] window, select the external device and click [Settings] .

To connect multiple External Devices, from [Device-Specific Settings] in the [Device/PLC] window, click [Add Device] to add another External Device.

The 'Individual Device Settings' dialog box is shown for 'PLC1'. It features a 'Station No.' field with the value '1' and a 'Default' button. At the bottom, there are 'OK (O)' and 'Cancel' buttons.

■ Settings of External Device

Use the ladder software (WinProladder) for communication settings. After completing the settings, reboot the External Device to enable them. Refer to your External Device manual for details.

- 1 Start up the ladder software (WinProladder).
- 2 Select [Setting] - [Port 2 Parameter] from the [PLC] menu.
- 3 In the [Comm. Parameter Setting] dialog box, set the following parameters.

Item	Settings
Baud Rate	9,600
Parity	Even parity
Data Bit	7 bits
Stop Bit	1 bit

- 4 Click [OK] to complete the port settings.

3.3 Setting Example 3

■ Settings of GP-Pro EX

◆ Communication Settings

To display the setup screen, from the [Project] menu, point to [System Settings] and select [Device/PLC].

Device/PLC 1

Summary [Change Device/PLC](#)

Manufacturer: Series: Port:

Text Data Mode: [Change](#)

Communication Settings

SID Type: RS232C RS422/485(2wire) RS422/485(4wire)

Speed:

Data Length: 7 8

Parity: NONE EVEN ODD

Stop Bit: 1 2

Flow Control: NONE ER(DTR/CTS) XON/XOFF

Timeout: (sec)

Retry:

Wait To Send: (ms)

RI / VCC: RI VCC

In the case of RS232C, you can select the 9th pin to RI (Input) or VCC (5V Power Supply). If you use the Digital's RS232C Isolation Unit, please select it to VCC.

Device-Specific Settings

Allowable Number of Devices/PLCs: 16 [Add Device](#)

No.	Device Name	Settings
<input type="button" value="v"/> 1	<input type="text" value="PLC1"/>	<input type="text" value="Station No.=1"/> <input type="button" value="Settings"/>

◆ Device Setting

To display the [Individual Device Settings] dialog box, from [Device-Specific Settings] in the [Device/PLC] window, select the external device and click [Settings] .

To connect multiple External Devices, from [Device-Specific Settings] in the [Device/PLC] window, click [Add Device] to add another External Device.

Individual Device Settings

PLC1

Station No.

■ Settings of External Device

Use the ladder software (WinProladder) for communication settings. After completing the settings, reboot the External Device to enable them. Refer to your External Device manual for details.

- 1 Start up the ladder software (WinProladder).
- 2 Select [Setting] - [Port 1 Parameter] from the [PLC] menu.
- 3 In the [Comm. Parameter Setting] dialog box, set the following parameters.

Item	Settings
Baud Rate	9,600
Parity	Even parity
Data Bit	7 bits
Stop Bit	1 bit

- 4 Click [OK] to complete the port settings.

3.4 Setting Example 4

■ Settings of GP-Pro EX

◆ Communication Settings

To display the setup screen, from the [Project] menu, point to [System Settings] and select [Device/PLC].

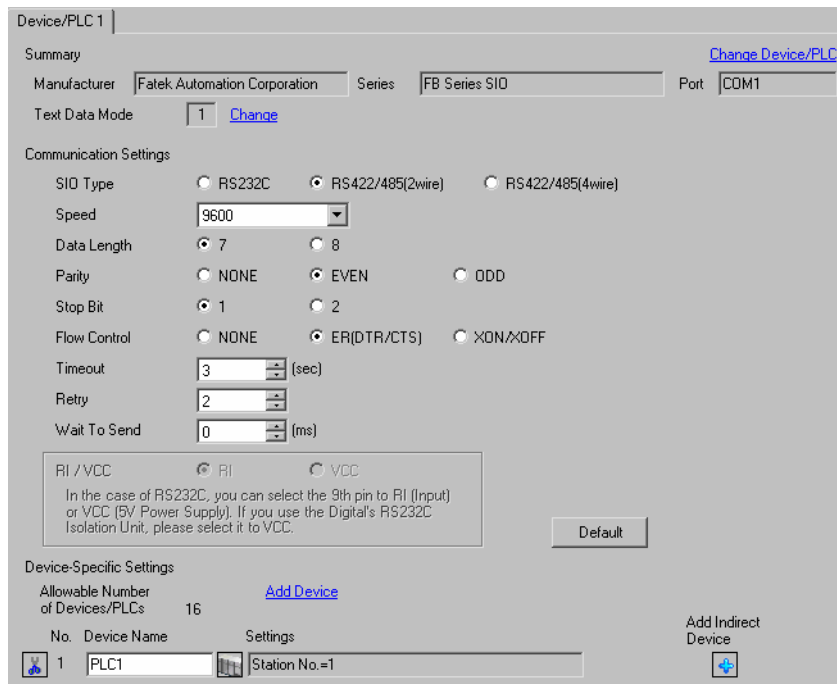

◆ Device Setting

To display the [Individual Device Settings] dialog box, from [Device-Specific Settings] in the [Device/PLC] window, select the external device and click [Settings] .

To connect multiple External Devices, from [Device-Specific Settings] in the [Device/PLC] window, click [Add Device] to add another External Device.

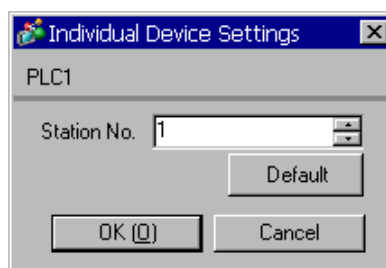

■ Settings of External Device

Use the ladder software (WinProladder) for communication settings. After completing the settings, reboot the External Device to enable them. Refer to your External Device manual for details.

- 1 Start up the ladder software (WinProladder).
- 2 Select [Setting] - [Port 2 Parameter] from the [PLC] menu.
- 3 In the [Comm. Parameter Setting] dialog box, set the following parameters.

Item	Settings
Baud Rate	9,600
Parity	Even parity
Data Bit	7 bits
Stop Bit	1 bit

- 4 Click [OK] to complete the port settings.

3.5 Setting Example 5

■ Settings of GP-Pro EX

◆ Communication Settings

To display the setup screen, from the [Project] menu, point to [System Settings] and select [Device/PLC].

Device/PLC 1

Summary [Change Device/PLC](#)

Manufacturer Series Port

Text Data Mode [Change](#)

Communication Settings

SIO Type RS232C RS422/485(2wire) RS422/485(4wire)

Speed

Data Length 7 8

Parity NONE EVEN ODD

Stop Bit 1 2

Flow Control NONE ER(DTR/CTS) XON/XOFF

Timeout (sec)

Retry

Wait To Send (ms)

RI / VCC RI VCC

In the case of RS232C, you can select the 9th pin to RI (Input) or VCC (5V Power Supply). If you use the Digital's RS232C Isolation Unit, please select it to VCC.

Device-Specific Settings

Allowable Number of Devices/PLCs [Add Device](#)

No.	Device Name	Settings
<input type="button" value="1"/>	<input type="text" value="PLC1"/>	<input type="text" value="Station No.=1"/>

◆ Device Setting

To display the [Individual Device Settings] dialog box, from [Device-Specific Settings] in the [Device/PLC] window, select the external device and click [Settings] .

To connect multiple External Devices, from [Device-Specific Settings] in the [Device/PLC] window, click [Add Device] to add another External Device.

Individual Device Settings

PLC1

Station No.

■ Settings of External Device

Use the ladder software (WinProladder) for communication settings. After completing the settings, reboot the External Device to enable them. Refer to your External Device manual for details.

- 1 Start up the ladder software (WinProladder).
- 2 Select [Setting] - [Port 1 Parameter] from the [PLC] menu.
- 3 In the [Comm. Parameter Setting] dialog box, set the following parameters.

Item	Settings
Baud Rate	9,600
Parity	Even parity
Data Bit	7 bits
Stop Bit	1 bit

- 4 Click [OK] to complete the port settings.

3.6 Setting Example 6

■ Settings of GP-Pro EX

◆ Communication Settings

To display the setup screen, from the [Project] menu, point to [System Settings] and select [Device/PLC].

◆ Device Setting

To display the [Individual Device Settings] dialog box, from [Device-Specific Settings] in the [Device/PLC] window, select the external device and click [Settings] .

To connect multiple External Devices, from [Device-Specific Settings] in the [Device/PLC] window, click [Add Device] to add another External Device.

■ Settings of External Device

Use the ladder software (WinProLadder) for communication settings. After completing the settings, reboot the External Device to enable them. Refer to your External Device manual for details.

- 1 Start up the ladder software (WinProLadder).
- 2 Select [Setting] - [Port 3 Parameter] from the [PLC] menu.
- 3 In the [Comm. Parameter Setting] dialog box, set the following parameters.

Item	Settings
Baud Rate	9,600
Parity	Even parity
Data Bit	7 bits
Stop Bit	1 bit

- 4 Click [OK] to complete the port settings.

3.7 Setting Example 7

■ Settings of GP-Pro EX

◆ Communication Settings

To display the setup screen, from the [Project] menu, point to [System Settings] and select [Device/PLC].

The screenshot shows the 'Device/PLC 1' configuration window. The 'Summary' section includes 'Manufacturer' (Fatek Automation Corporation), 'Series' (FB Series SIO), and 'Port' (COM1). The 'Text Data Mode' is set to '1'. The 'Communication Settings' section includes:

- SIO Type: RS232C, RS422/485(2wire), RS422/485(4wire)
- Speed: 9600
- Data Length: 7, 8
- Parity: NONE, EVEN, ODD
- Stop Bit: 1, 2
- Flow Control: NONE, ER(DTR/CTS), XON/XOFF
- Timeout: 3 (sec)
- Retry: 2
- Wait To Send: 0 (ms)

 A sub-section for 'RI / VCC' has RI selected. A note below states: 'In the case of RS232C, you can select the 9th pin to RI (Input) or VCC (5V Power Supply). If you use the Digital's RS232C Isolation Unit, please select it to VCC.' A 'Default' button is present. The 'Device-Specific Settings' section shows 'Allowable Number of Devices/PLCs' as 16 and an 'Add Device' button. A table below lists:

No.	Device Name	Settings
1	PLC1	Station No.=1

 An 'Add Indirect Device' button is also visible.

◆ Device Setting

To display the [Individual Device Settings] dialog box, from [Device-Specific Settings] in the [Device/PLC] window, select the external device and click [Settings] .

To connect multiple External Devices, from [Device-Specific Settings] in the [Device/PLC] window, click [Add Device] to add another External Device.

The screenshot shows the 'Individual Device Settings' dialog box for 'PLC1'. It features a 'Station No.' field with a dropdown menu set to '1'. Below the field are 'Default', 'OK (O)', and 'Cancel' buttons.

■ Settings of External Device

Use the ladder software (WinProladder) for communication settings. After completing the settings, reboot the External Device to enable them. Refer to your External Device manual for details.

- 1 Start up the ladder software (WinProladder).
- 2 Select [Setting] - [Port 4 Parameter] from the [PLC] menu.
- 3 In the [Comm. Parameter Setting] dialog box, set the following parameters.

Item	Settings
Baud Rate	9,600
Parity	Even parity
Data Bit	7 bits
Stop Bit	1 bit

- 4 Click [OK] to complete the port settings.

3.8 Setting Example 8

■ Settings of GP-Pro EX

◆ Communication Settings

To display the setup screen, from the [Project] menu, point to [System Settings] and select [Device/PLC].

The screenshot shows the 'Device/PLC 1' configuration window. It is divided into several sections:

- Summary:** Manufacturer: Fatek Automation Corporation, Series: FB Series SIO, Port: CDM1. A 'Change Device/PLC' link is visible.
- Text Data Mode:** Set to 1, with a 'Change' link.
- Communication Settings:**
 - SIO Type: RS232C, RS422/485(2wire), RS422/485(4wire)
 - Speed: 9600
 - Data Length: 7, 8
 - Parity: NONE, EVEN, ODD
 - Stop Bit: 1, 2
 - Flow Control: NONE, ER(DTR/CTS), XON/XOFF
 - Timeout: 3 (sec)
 - Retry: 2
 - Wait To Send: 0 (ms)
- RI / VCC:** RI, VCC. A note states: 'In the case of RS232C, you can select the 9th pin to RI (Input) or VCC (5V Power Supply). If you use the Digital's RS232C Isolation Unit, please select it to VCC.' A 'Default' button is present.
- Device-Specific Settings:** Allowable Number of Devices/PLCs: 16. An 'Add Device' link is available.
- Device List:** A table with columns 'No.', 'Device Name', and 'Settings'. It contains one entry: No. 1, Device Name 'PLC1', Settings 'Station No.=1'. An 'Add Indirect Device' button is to the right.

◆ Device Setting

To display the [Individual Device Settings] dialog box, from [Device-Specific Settings] in the [Device/PLC] window, select the external device and click [Settings] .

To connect multiple External Devices, from [Device-Specific Settings] in the [Device/PLC] window, click [Add Device] to add another External Device.

The 'Individual Device Settings' dialog box is shown for 'PLC1'. It features a 'Station No.' field with a dropdown menu set to '1'. Below the field are 'Default', 'OK (O)', and 'Cancel' buttons.

■ Settings of External Device

Use the ladder software (WinProladder) for communication settings. After completing the settings, reboot the External Device to enable them. Refer to your External Device manual for details.

- 1 Start up the ladder software (WinProladder).
- 2 Select [Setting] - [Port 3 Parameter] from the [PLC] menu.
- 3 In the [Comm. Parameter Setting] dialog box, set the following parameters.

Item	Settings
Baud Rate	9,600
Parity	Even parity
Data Bit	7 bits
Stop Bit	1 bit

- 4 Click [OK] to complete the port settings.

3.9 Setting Example 9

■ Settings of GP-Pro EX

◆ Communication Settings

To display the setup screen, from the [Project] menu, point to [System Settings] and select [Device/PLC].

The screenshot shows the 'Device/PLC 1' configuration window. The 'Summary' section includes 'Manufacturer' (Fatek Automation Corporation), 'Series' (FB Series SIO), and 'Port' (COM1). The 'Text Data Mode' is set to 1. The 'Communication Settings' section includes:

- SIO Type: RS422/485(2wire)
- Speed: 9600
- Data Length: 7
- Parity: EVEN
- Stop Bit: 1
- Flow Control: ER(DTR/CTS)
- Timeout: 3 (sec)
- Retry: 2
- Wait To Send: 0 (ms)

 A sub-section for 'RI / VCC' allows selecting between RI and VCC, with a 'Default' button. The 'Device-Specific Settings' section shows 'Allowable Number of Devices/PLCs' as 16 and a table with one device:

No.	Device Name	Settings
1	PLC1	Station No.=1

◆ Device Setting

To display the [Individual Device Settings] dialog box, from [Device-Specific Settings] in the [Device/PLC] window, select the external device and click [Settings] .

To connect multiple External Devices, from [Device-Specific Settings] in the [Device/PLC] window, click [Add Device] to add another External Device.

The 'Individual Device Settings' dialog box for 'PLC1' shows a 'Station No.' field with the value 1. It includes 'Default', 'OK (O)', and 'Cancel' buttons.

■ Settings of External Device

Use the ladder software (WinProladder) for communication settings. After completing the settings, reboot the External Device to enable them. Refer to your External Device manual for details.

- 1 Start up the ladder software (WinProladder).
- 2 Select [Setting] - [Port 4 Parameter] from the [PLC] menu.
- 3 In the [Comm. Parameter Setting] dialog box, set the following parameters.

Item	Settings
Baud Rate	9,600
Parity	Even parity
Data Bit	7 bits
Stop Bit	1 bit

- 4 Click [OK] to complete the port settings.

3.10 Setting Example 10

■ Settings of GP-Pro EX

◆ Communication Settings

To display the setup screen, from the [Project] menu, point to [System Settings] and select [Device/PLC].

NOTE

- For 1:n connection, set [Wait To Send] to a value of the PLC scan time plus 5ms or more.

◆ Device Setting

To display the [Individual Device Settings] dialog box, from [Device-Specific Settings] in the [Device/PLC] window, select the external device and click [Settings] .

To connect multiple External Devices, from [Device-Specific Settings] in the [Device/PLC] window, click [Add Device] to add another External Device.

■ Settings of External Device

The communication setting is fixed.

3.11 Setting Example 11

■ Settings of GP-Pro EX

◆ Communication Settings

To display the setup screen, from the [Project] menu, point to [System Settings] and select [Device/PLC].

Device/PLC 1

Summary [Change Device/PLC](#)

Manufacturer Series Port

Text Data Mode [Change](#)

Communication Settings

SIO Type RS232C RS422/485(2wire) RS422/485(4wire)

Speed

Data Length 7 8

Parity NONE EVEN ODD

Stop Bit 1 2

Flow Control NONE ER(DTR/CTS) XON/XOFF

Timeout (sec)

Retry

Wait To Send (ms)

RI / VCC RI VCC

In the case of RS232C, you can select the 9th pin to RI (Input) or VCC (5V Power Supply). If you use the Digital's RS232C Isolation Unit, please select it to VCC.

Device-Specific Settings

Allowable Number of Devices/PLCs [Add Device](#)

No.	Device Name	Settings
<input type="button" value="1"/>	<input type="text" value="PLC1"/>	<input type="text" value="Station No.=1"/>

NOTE

- For 1:n connection, set [Wait To Send] to a value of the PLC scan time plus 5ms or more.

◆ Device Setting

To display the [Individual Device Settings] dialog box, from [Device-Specific Settings] in the [Device/PLC] window, select the external device and click [Settings] .

To connect multiple External Devices, from [Device-Specific Settings] in the [Device/PLC] window, click [Add Device] to add another External Device.

Individual Device Settings

PLC1

Station No.

■ Settings of External Device

The communication setting is fixed.

3.12 Setting Example 12

◆ Communication Settings

To display the setup screen, from the [Project] menu, point to [System Settings] and select [Device/PLC].

The screenshot shows the 'Device/PLC 1' configuration window. It is divided into several sections:

- Summary:** Manufacturer: Fatek Automation Corporation, Series: FB Series SIO, Port: COM1. Text Data Mode: 1.
- Communication Settings:**
 - SIO Type: RS232C, RS422/485(2wire), RS422/485(4wire)
 - Speed: 9600
 - Data Length: 7, 8
 - Parity: NONE, EVEN, ODD
 - Stop Bit: 1, 2
 - Flow Control: NONE, ER(DTR/CTS), XON/XOFF
 - Timeout: 3 (sec)
 - Retry: 2
 - Wait To Send: 0 (ms)
 - RI / VCC: RI, VCC. Note: In the case of RS232C, you can select the 9th pin to RI (Input) or VCC (5V Power Supply). If you use the Digital's RS232C Isolation Unit, please select it to VCC.
- Device-Specific Settings:** Allowable Number of Devices/PLCs: 16. A table below shows:

No.	Device Name	Settings
1	PLC1	Station No.=1

NOTE

- For 1:n connection, set [Wait To Send] to a value of the PLC scan time plus 5ms or more.

◆ Device Setting

To display the [Individual Device Settings] dialog box, from [Device-Specific Settings] in the [Device/PLC] window, select the external device and click [Settings] .

To connect multiple External Devices, from [Device-Specific Settings] in the [Device/PLC] window, click [Add Device] to add another External Device.

The 'Individual Device Settings' dialog box is shown for device 'PLC1'. It contains a 'Station No.' field with the value '1' and a 'Default' button. At the bottom are 'OK (O)' and 'Cancel' buttons.

■ Settings of External Device

Use the ladder software (WinProladder) for communication settings. After completing the settings, reboot the External Device to enable them. Refer to your External Device manual for details.

- 1 Start up the ladder software (WinProladder).
- 2 Select [Setting] - [Port 1 Parameter] from the [PLC] menu.
- 3 In the [Comm. Parameter Setting] dialog box, set the following parameters.

Item	Settings
Baud Rate	9,600
Parity	Even parity
Data Bit	7 bits
Stop Bit	1 bit

- 4 Click [OK] to complete the port settings.

3.13 Setting Example 13

■ Settings of GP-Pro EX

◆ Communication Settings

To display the setup screen, from the [Project] menu, point to [System Settings] and select [Device/PLC].

Device/PLC 1

Summary [Change Device/PLC](#)

Manufacturer Series Port

Text Data Mode [Change](#)

Communication Settings

SIO Type RS232C RS422/485(2wire) RS422/485(4wire)

Speed

Data Length 7 8

Parity NONE EVEN ODD

Stop Bit 1 2

Flow Control NONE ER(DTR/CTS) XON/XOFF

Timeout (sec)

Retry

Wait To Send (ms)

RI / VCC RI VCC

In the case of RS232C, you can select the 9th pin to RI (Input) or VCC (5V Power Supply). If you use the Digital's RS232C Isolation Unit, please select it to VCC.

Device-Specific Settings

Allowable Number of Devices/PLCs 16 [Add Device](#)

No.	Device Name	Settings
<input type="button" value="1"/>	<input type="text" value="PLC1"/>	<input type="text" value="Station No.=1"/>

NOTE

- For 1:n connection, set [Wait To Send] to a value of the PLC scan time plus 5ms or more.

◆ Device Setting

To display the [Individual Device Settings] dialog box, from [Device-Specific Settings] in the [Device/PLC] window, select the external device and click [Settings] .

To connect multiple External Devices, from [Device-Specific Settings] in the [Device/PLC] window, click [Add Device] to add another External Device.

Individual Device Settings

PLC1

Station No.

■ Settings of External Device

Use the ladder software (WinProladder) for communication settings. After completing the settings, reboot the External Device to enable them. Refer to your External Device manual for details.

- 1 Start up the ladder software (WinProladder).
- 2 Select [Setting] - [Port 2 Parameter] from the [PLC] menu.
- 3 In the [Comm. Parameter Setting] dialog box, set the following parameters.

Item	Settings
Baud Rate	9,600
Parity	Even parity
Data Bit	7 bits
Stop Bit	1 bit

- 4 Click [OK] to complete the port settings.

4 Setup Items

Set the communication settings of the Display with GP-Pro Ex or in offline mode of the Display.
The setting of each parameter must match that of the External Device.

 "3 Example of Communication Setting" (page 10)

4.1 Setup Items in GP-Pro EX

■ Communication Settings

To display the setup screen, from the [Project] menu, point to [System Settings] and select [Device/PLC].

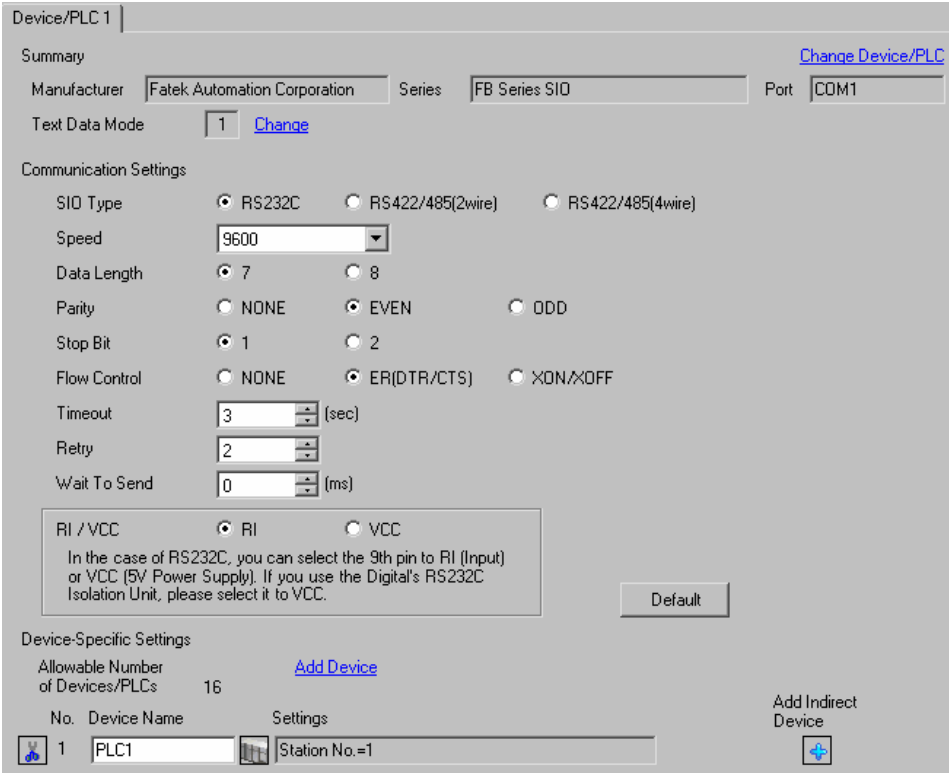

Setup Items	Setup Description
SIO Type	Select the SIO type for communicating with the External Device.
Speed	Select the communication speed between the External Device and the Display.
Data Length	Select a data length.
Parity	Select how to check parity.
Stop Bit	Select a stop bit length.
Flow Control	Select the communication control method to prevent overflow of transmission and reception data.
Timeout	Enter the time (s) for which the Display waits for a response from the External Device, from "1 to 127".

Continued to next page.

Setup Items	Setup Description
Retry	In case of no response from the External Device, enter how many times the Display retransmits the command, from "0 to 255".
Wait To Send	Enter the standby time (ms) from when the Display receives packets until it transmits the next command, from "0 to 255".
RI/VCC	You can switch between RI/VCC of the 9th pin when you select RS232C for the SIO type. To connect to the IPC, you need to use the IPC selector switch to switch RI/5V. Refer to your IPC manual for details.

NOTE

- Refer to the GP-Pro EX Reference Manual for Indirect Device.
- Cf. GP-Pro EX Reference Manual "Changing the Device/PLC at Runtime (Indirect Device)"

■ Device Setting

To display the [Individual Device Settings] dialog box, from [Device-Specific Settings] in the [Device/PLC] window, select the external device and click [Settings] .

To connect multiple External Devices, from [Device-Specific Settings] in the [Device/PLC] window, click [Add Device] to add another External Device.

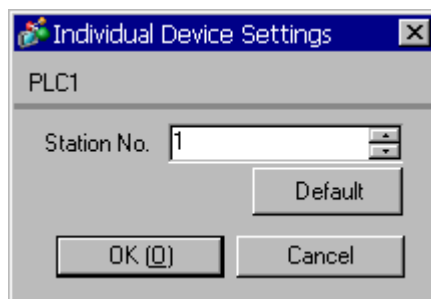

Setup Items	Setup Description
Station No.	Enter the station No. of the External Device, from "1 to 254".

4.2 Settings in Offline Mode

NOTE

- Refer to the Maintenance/Troubleshooting guide for information on how to enter offline mode or about the operation.

Cf. Maintenance/Troubleshooting Guide "Offline Mode"

- The number of the setup items to be displayed for 1 page in the offline mode depends on the Display in use. Please refer to the Reference manual for details.

■ Communication Settings

To display the setting screen, touch [Device/PLC Settings] from [Peripheral Settings] in offline mode. Touch the External Device you want to set from the list that appears.

Comm.	Device	Option		
FB Series SIO			[COM1]	Page 1/1
SIO Type			RS232C	
Speed			9600	
Data Length			<input checked="" type="radio"/> 7 <input type="radio"/> 8	
Parity			<input type="radio"/> NONE <input checked="" type="radio"/> EVEN <input type="radio"/> ODD	
Stop Bit			<input checked="" type="radio"/> 1 <input type="radio"/> 2	
Flow Control			ER(DTR/CTS)	
Timeout(s)			3	▼ ▲
Retry			2	▼ ▲
Wait To Send(ms)			0	▼ ▲
	Exit		Back	2007/10/15 21:52:28

Setup Items	Setup Description
SIO Type	Select the SIO type for communicating with the External Device. IMPORTANT In the communication settings, set [SIO Type] correctly according to the serial interface specifications of the Display. If you select an SIO type that the serial interface does not support, proper operation cannot be guaranteed. Refer to your Display manual for details on the serial interface specifications.
Speed	Select the communication speed between the External Device and the Display.
Data Length	Select a data length.
Parity	Select how to check parity.

Continued to next page.

Setup Items	Setup Description
Stop Bit	Select a stop bit length.
Flow Control	Select the communication control method to prevent overflow of transmission and reception data.
Timeout	Enter the time (s) for which the Display waits for a response from the External Device, from "1 to 127".
Retry	In case of no response from the External Device, enter how many times the Display retransmits the command, from "0 to 255".
Wait To Send	Enter the standby time (ms) from when the Display receives packets until it transmits the next command, from "0 to 255".

■ Device Setting

To display the setting screen, touch [Device/PLC Settings] from [Peripheral Equipment Settings]. Touch the External Device you want to set from the list that appears, and touch [Device Settings].

Comm.	Device	Option		
FB Series SIO		[COM1]	Page 1/1	
Device/PLC Name		PLC1		
Station No.		1		
	Exit		Back	2007/10/15 21:52:33

Setup Items	Setup Description
Device/PLC Name	Select the External Device to set. Device name is the title of the External Device set with GP-Pro EX. (Initial value [PLC1])
Station No.	Enter the station No. of the External Device, from "1 to 254".

■ Option

To display the setting screen, touch [Device/PLC Settings] from [Peripheral Equipment Settings]. Touch the External Device you want to set from the list that appears, and touch [Option].

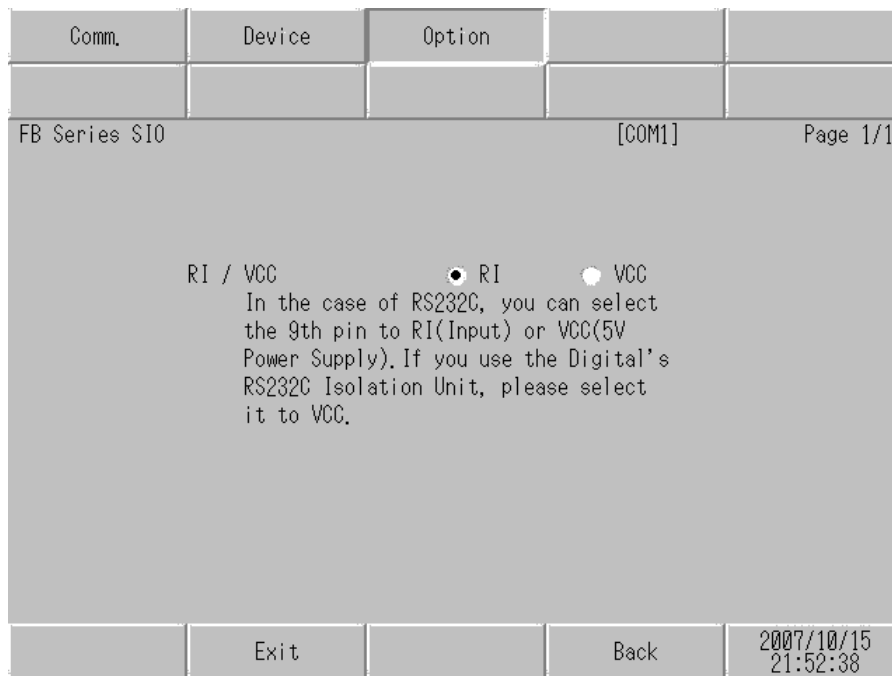

Setup Items	Setup Description
RI/VCC	You can switch between RI/VCC of the 9th pin when you select RS232C for the SIO type. To connect to the IPC, you need to use the IPC selector switch to switch between RI/5V. Refer to your IPC manual for details.

NOTE

- GP-4100 series, GP-4*01TM, GP-Rear Module, LT-4*01TM and LT-Rear Module do not have the [Option] setting in the offline mode.

5 Cable Diagram

The cable diagram shown below may differ from that recommended by the Fatek Automation Corporation. Please be assured, however, that there is no operational problem in applying the cable diagram shown in this manual.

- The FG pin on the External Device must be D-class grounded. Refer to your External Device manual for details.
- The SG and FG are connected inside the Display. If you connect the External Device to the SG, do not form any short-circuit loop in the system design.
- If the communication is not stable because of noise or other factors, connect an isolation unit.

Cable Diagram 1

Display (Connection Port)	Cable		Remarks
GP3000 (COM1) GP4000*1 (COM1) SP5000*2 (COM1/2) SP-5B00 (COM1) ST3000 (COM1) ST6000 (COM1) STM6000 (COM1) STC6000 (COM1) ET6000 (COM1) LT3000 (COM1) IPC*3 PC/AT	1A	FBs-232P0-9F-150 by Fatek Automation Corporation	-
GP-4105 (COM1) GP-4115T (COM1) GP-4115T3 (COM1)	1B	User-created Cable + FBs-232P0-9F-150 by Fatek Automation Corporation	Cable length: 15m or less

*1 All GP4000 models except GP-4100 Series and GP-4203T

*2 Except SP-5B00

*3 Available only with a COM port that supports RS232C.

 ■ IPC COM Port (page 6)

1A)

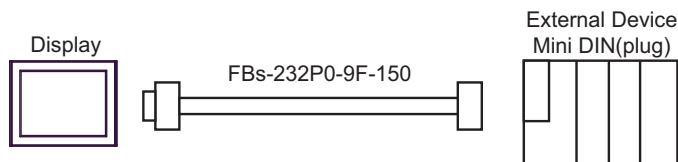

1B)

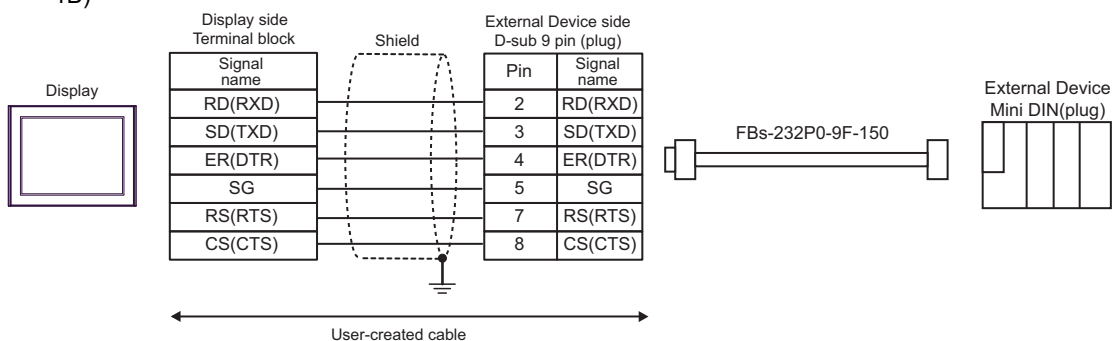

Cable Diagram 2

Display (Connection Port)	Cable		Remarks
GP3000 (COM1) GP4000* ¹ (COM1) SP5000* ² (COM1/2) SP-5B00 (COM1) ST3000 (COM1) ST6000 (COM1) STM6000 (COM1) STC6000 (COM1) ET6000 (COM1) LT3000 (COM1) IPC* ³ PC/AT	2A	User-created Cable	Cable length: 15m or less
GP-4105 (COM1) GP-4115T (COM1) GP-4115T3 (COM1)	2B	User-created Cable	Cable length: 15m or less

*1 All GP4000 models except GP-4100 Series and GP-4203T

*2 Except SP-5B00

*3 Available only with a COM port that supports RS232C.
 ■ IPC COM Port (page 6)

2A)

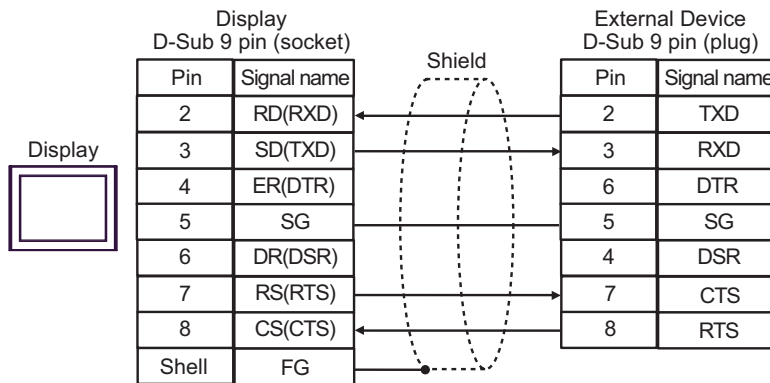

2B)

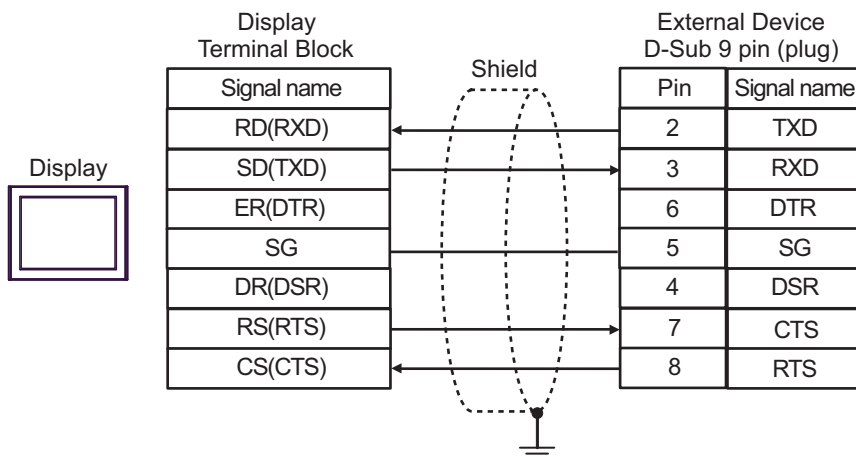

Cable Diagram 3

Display (Connection Port)	Cable		Remarks
GP3000 (COM1) GP4000* ¹ (COM1) SP5000* ² (COM1/2) SP-5B00 (COM1) ST3000 (COM1) ST6000 (COM1) STM6000 (COM1) STC6000 (COM1) ET6000 (COM1) LT3000 (COM1) IPC* ³ PC/AT	3A	User-created Cable	Cable length: 15m or less
GP-4105 (COM1) GP-4115T (COM1) GP-4115T3 (COM1)	3B	User-created Cable	Cable length: 15m or less
LT-4*01TM (COM1) LT-Rear Module (COM1)	3C	RJ45 RS-232C Cable (5m) by Pro-face PFXZLMCBJR21	Cable length: 5m or less

*1 All GP4000 models except GP-4100 Series and GP-4203T

*2 Except SP-5B00

*3 Available only with a COM port that supports RS232C.

☞ ■ IPC COM Port (page 6)

3A)

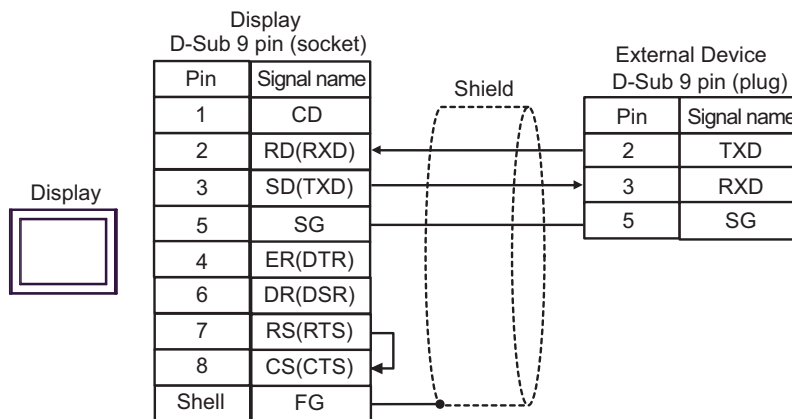

3B)

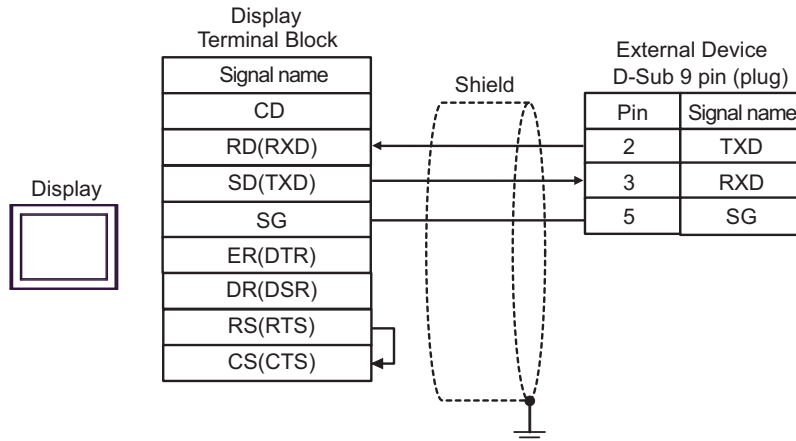

3C)

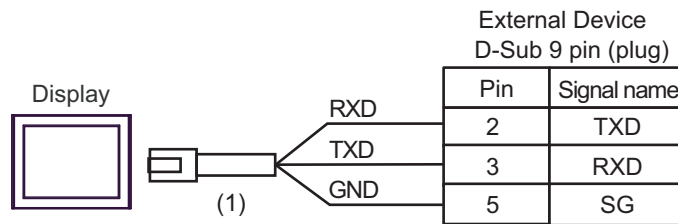

Number	Name	Notes
(1)	RJ45 RS-232C Cable (5m) by Pro-face PFXZLMCBJR21	

Cable Diagram 4

Display (Connection Port)	Cable		Remarks
GP3000*1 (COM1) AGP-3302B (COM2) GP-4*01TM (COM1) GP-Rear Module (COM1) ST3000*2 (COM2) LT3000 (COM1)	4A	COM port conversion adapter by Pro-face CA3-ADPCOM-01 + Connector terminal block conversion adapter by Pro-face CA3-ADPTRM-01 + User-created Cable	Cable length: 1,000m or less
	4B	Your own cable	
GP3000*3 (COM2)	4C	Online adapter by Pro-face CA4-ADPONL-01 + Connector terminal block conversion adapter by Pro-face CA3-ADPTRM-01 + User-created Cable	Cable length: 1,000m or less
	4D	Online adapter by Pro-face CA4-ADPONL-01 + User-created Cable	
IPC*4	4E	COM port conversion adapter by Pro-face CA3-ADPCOM-01 + Connector terminal block conversion adapter by Pro-face CA3-ADPTRM-01 + User-created Cable	Cable length: 1,000m or less
	4F	User-created Cable	
GP-4106 (COM1) GP-4116T (COM1)	4G	User-created Cable	Cable length: 1,000m or less
GP-4107 (COM1) GP-4*03T*5 (COM2) GP-4203T (COM1)	4H	User-created Cable	Cable length: 1,000m or less
GP4000*6 (COM2) GP-4201T (COM1) SP5000*7 (COM1/2) SP-5B00 (COM2) ST6000*8 (COM2) ST-6200 (COM1) STM6000 (COM1) STC6000 (COM1) ET6000*9 (COM2) PS6000 (Basic Box) (COM1/2)	4I	RS-422 Terminal Block Conversion Adapter by Pro-face PFXZCBADTM1*10 + User-created cable	Cable length: 1,000m or less
	4B	User-created cable	
LT-4*01TM (COM1) LT-Rear Module (COM1)	4J	RJ45 RS-485 Cable (5m) by Pro-face PFXZLMCBJR81	Cable length: 200m or less

Display (Connection Port)	Cable		Remarks
PE-4000B* ¹¹ PS5000* ¹¹ PS6000 (Optional Interface)* ¹¹	4K	User-created Cable	Cable length: 1,000m or less

*1 All GP models except AGP-3302B

*2 Except AST-3211A and AST-3302B

*3 All GP models except the GP-3200 Series and AGP-3302B

*4 Available only with a COM port that supports RS422/485 (2wire). (Except PE-4000B, PS5000, and PS6000)
 ■ IPC COM Port (page 6)

*5 Except GP-4203T

*6 All GP4000 models except GP-4100 Series, GP-4*01TM, GP-Rear Module, GP-4201T and GP-4*03T

*7 Except SP-5B00

*8 Except ST-6200

*9 Due to the COM port specifications, flow control is not possible. Omit wiring the control pins on the Display side of the cable diagram.

*10 When using a Terminal Block Conversion Adapter (CA3-ADPTRM-01) instead of the RS-422 Terminal Block Conversion Adapter, refer to Cable Diagram 4A.

*11 Available only with a COM port that supports RS422/485 (2wire).
 ■ IPC COM Port (page 6)

4A)

- 1:1 Connection

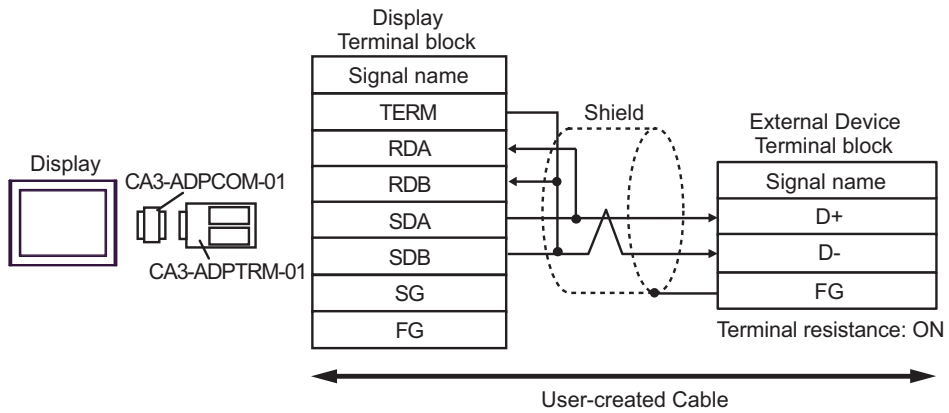

- 1:n Connection

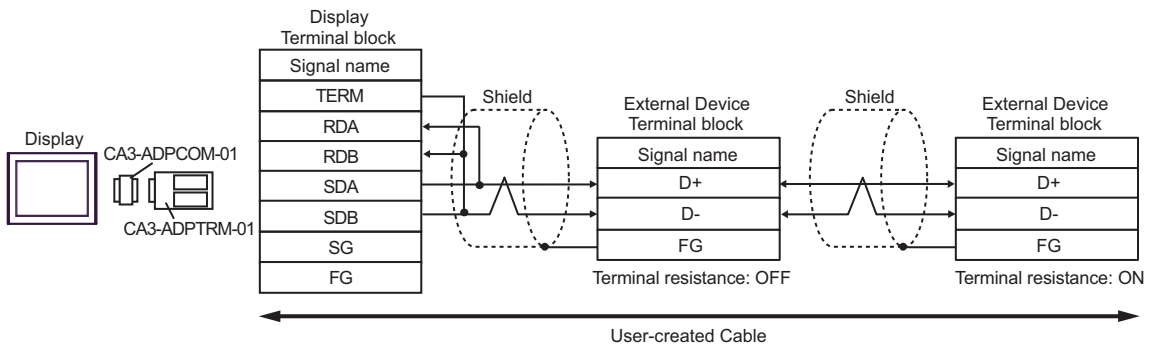

4B)

- 1:1 Connection

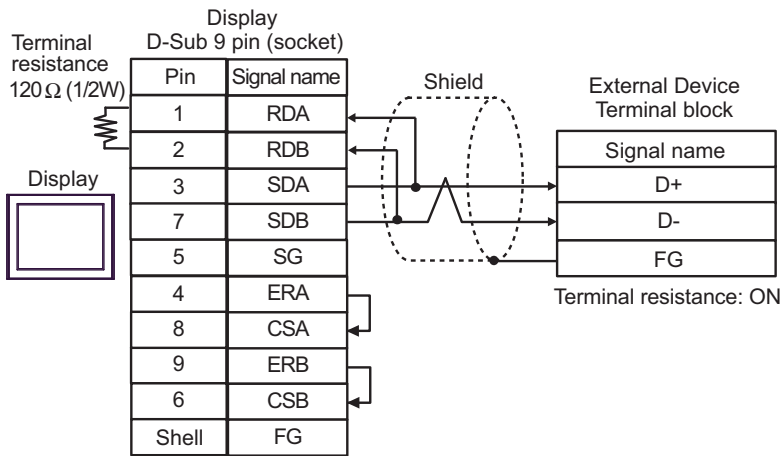

- 1:n Connection

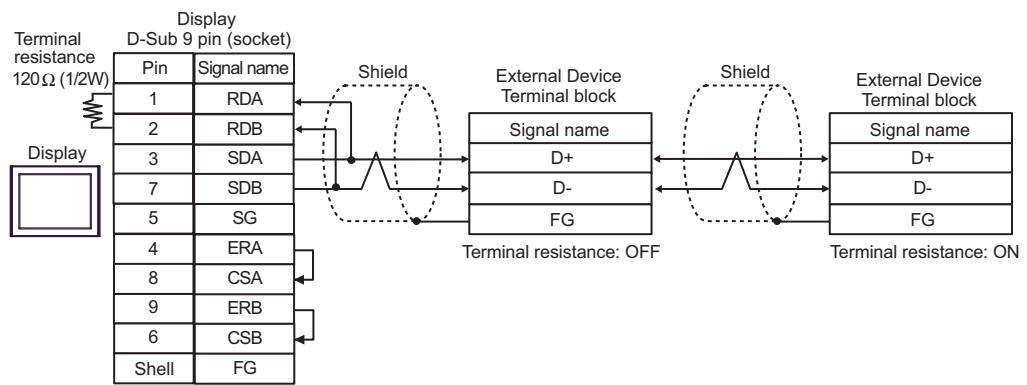

4C)

- 1:1 Connection

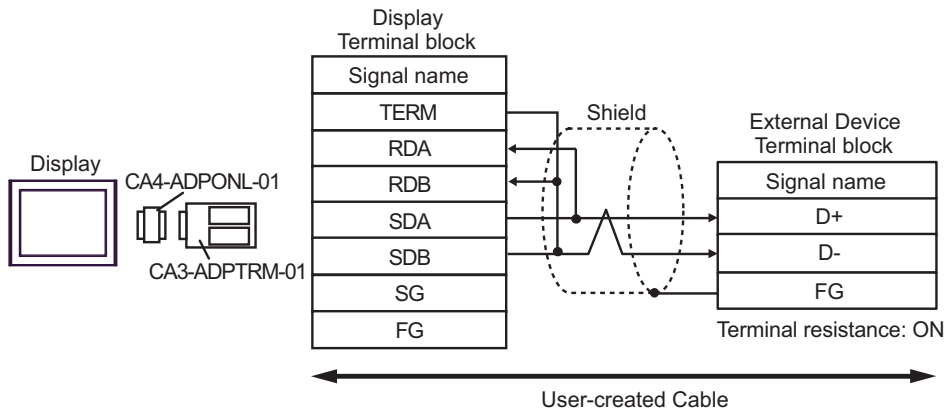

- 1:n Connection

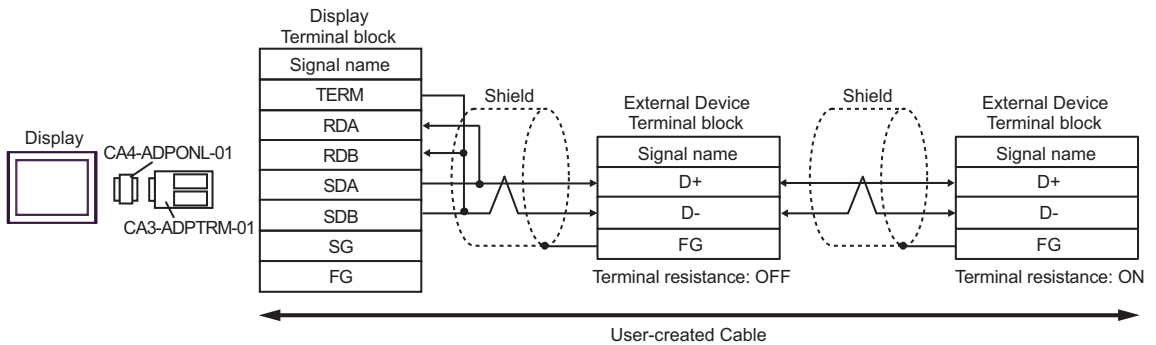

4D)

- 1:1 Connection

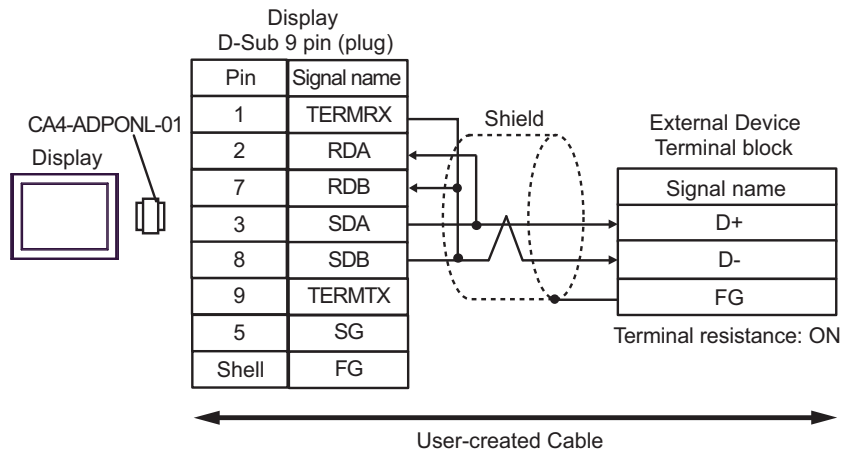

- 1:n Connection

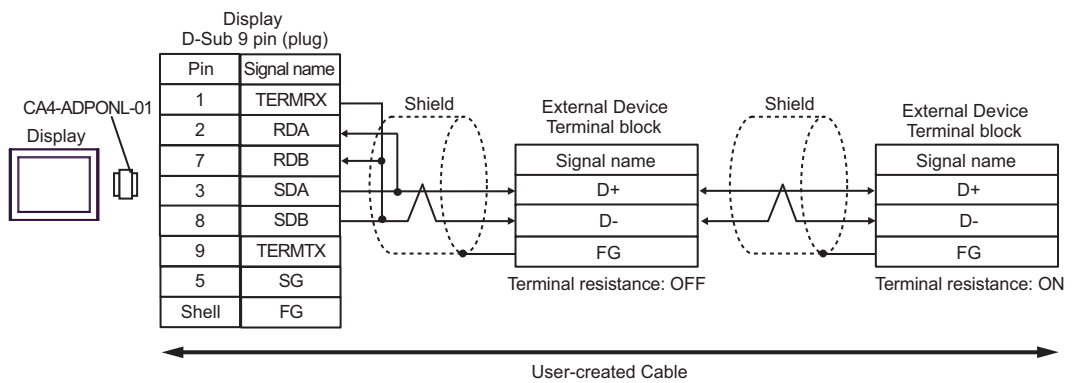

4E)

• 1:1 Connection

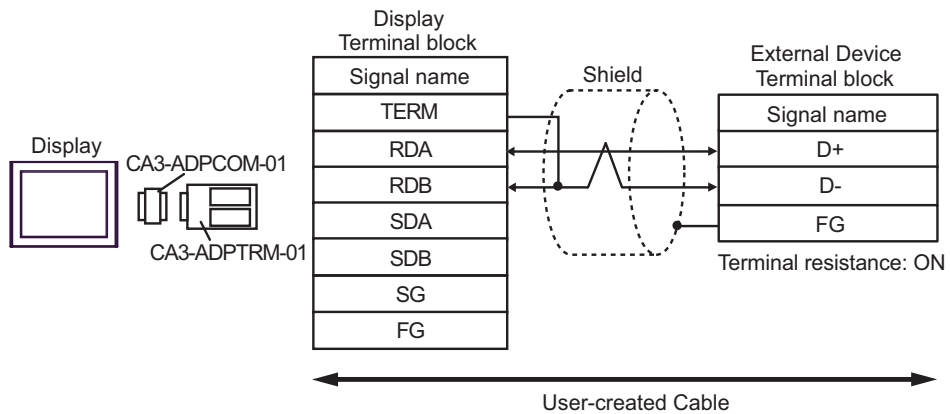

• 1:n Connection

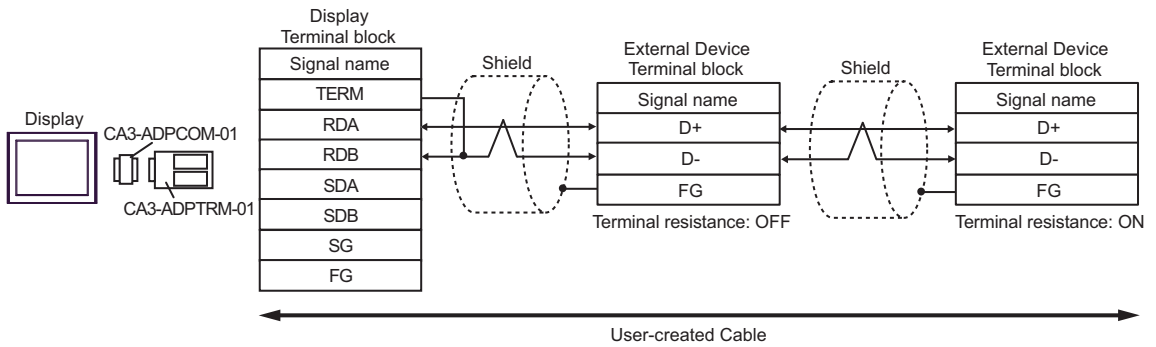

4F)

- 1:1 Connection

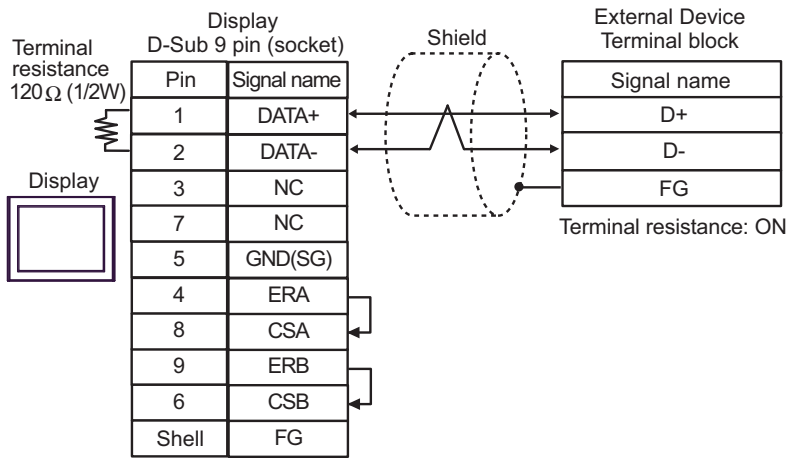

- 1:n Connection

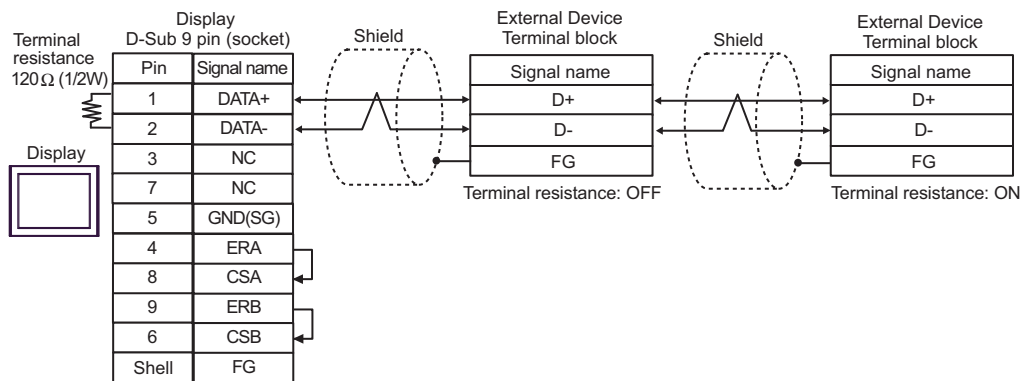

4G)

• 1:1 Connection

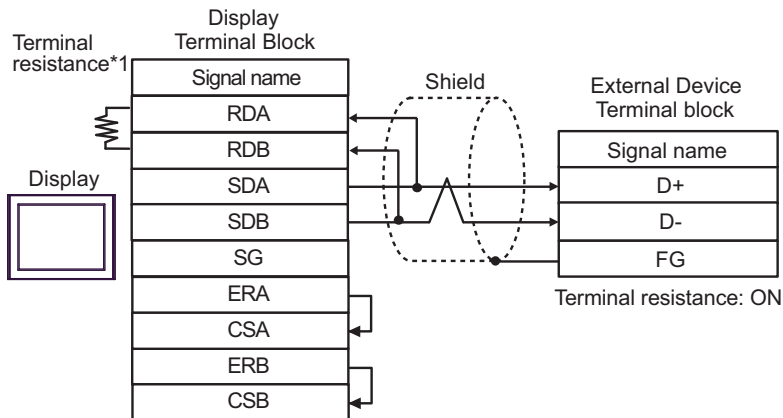

• 1:n Connection

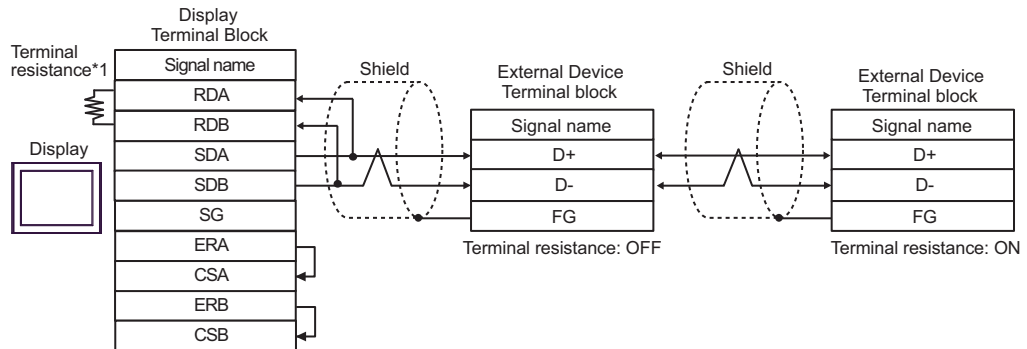

*1 The resistance in the Display is used as the termination resistance. Set the value of the DIP Switch on the rear of the Display as shown in the table below.

DIP Switch No.	Set Value
1	OFF
2	OFF
3	ON
4	ON

4H)

• 1:1 Connection

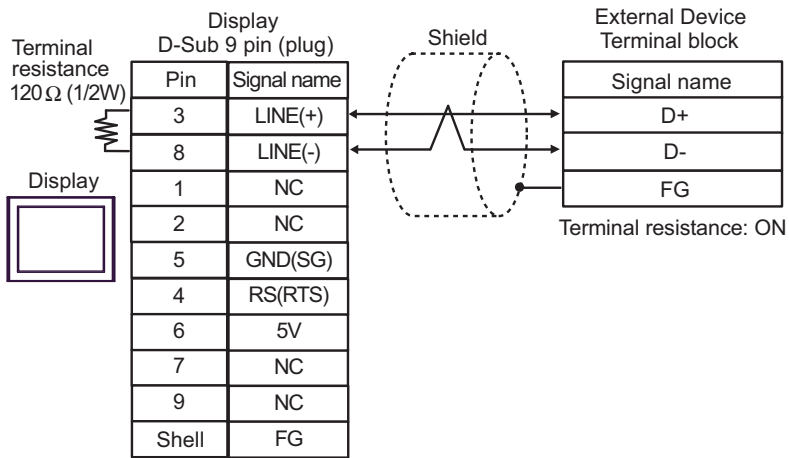

• 1:n Connection

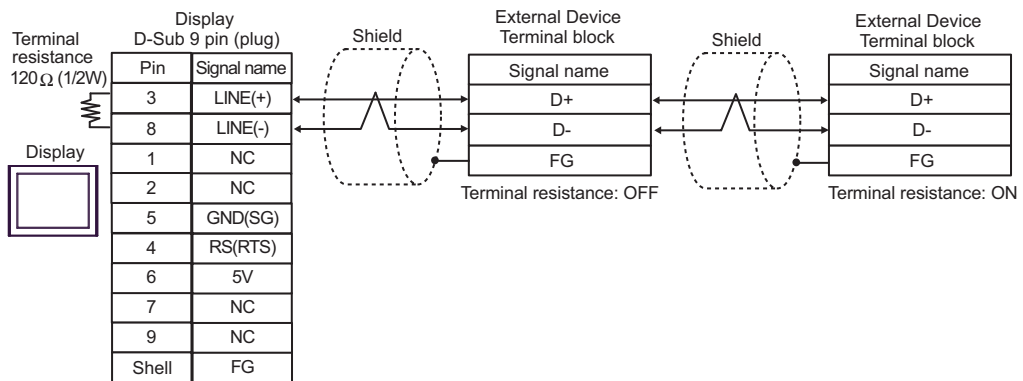

IMPORTANT • The 5V output (Pin #6) on the Display is the power for the Siemens AG's PROFIBUS connector. Do not use it for other devices.

NOTE • In COM on the GP-4107, the SG and FG terminals are isolated.

4l)

• 1:1 Connection

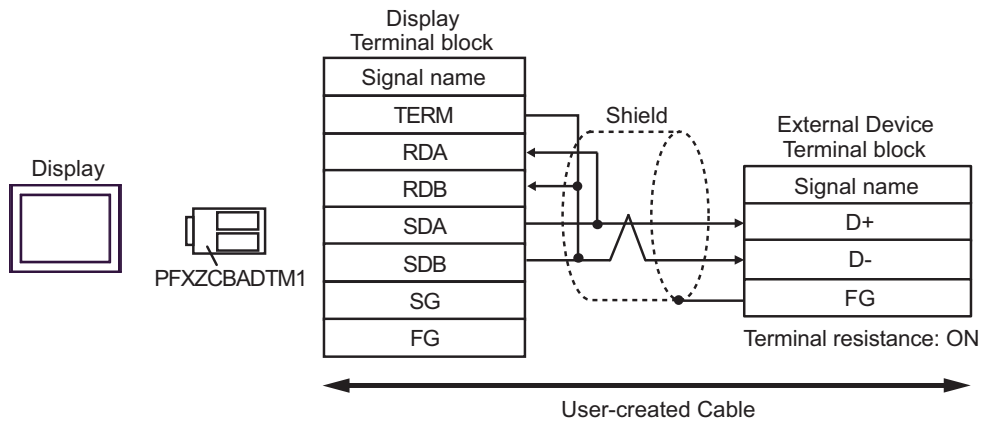

• 1:n Connection

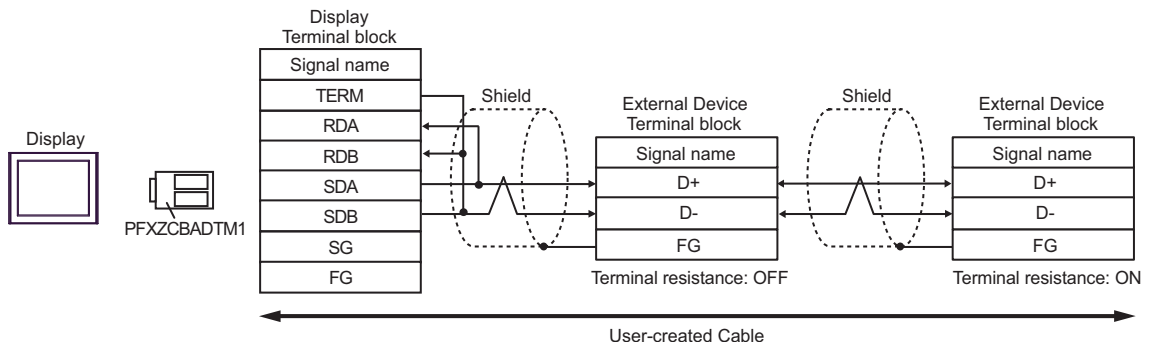

4J)

- 1:1 Connection

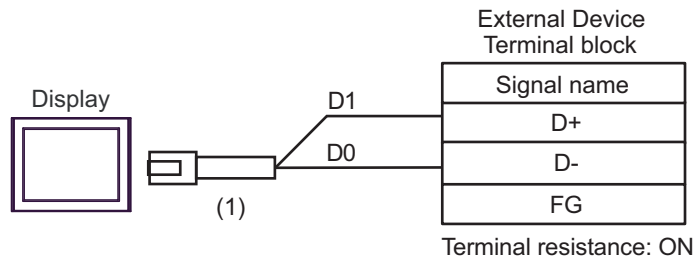

- 1:n Connection

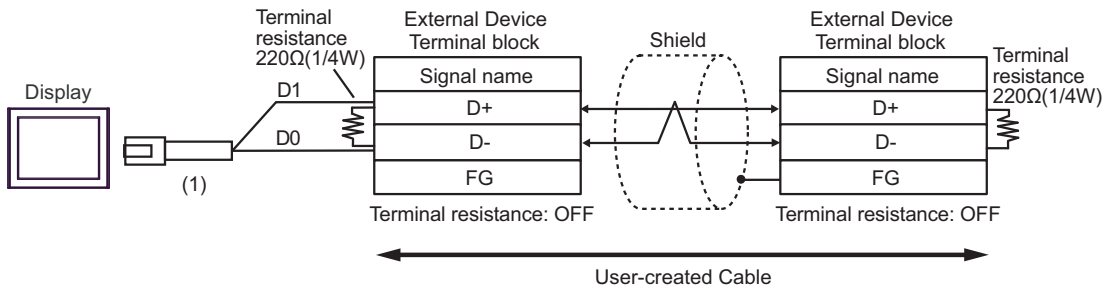

Number	Name	Notes
(1)	RJ45 RS-485 Cable (5m) by Pro-face PFXZLMCBJR81	

4K)

- 1:1 Connection

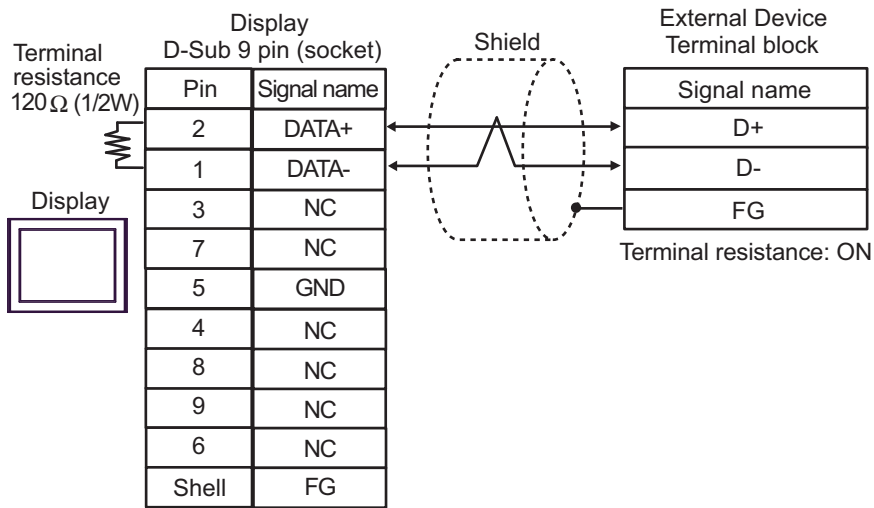

- 1:n Connection

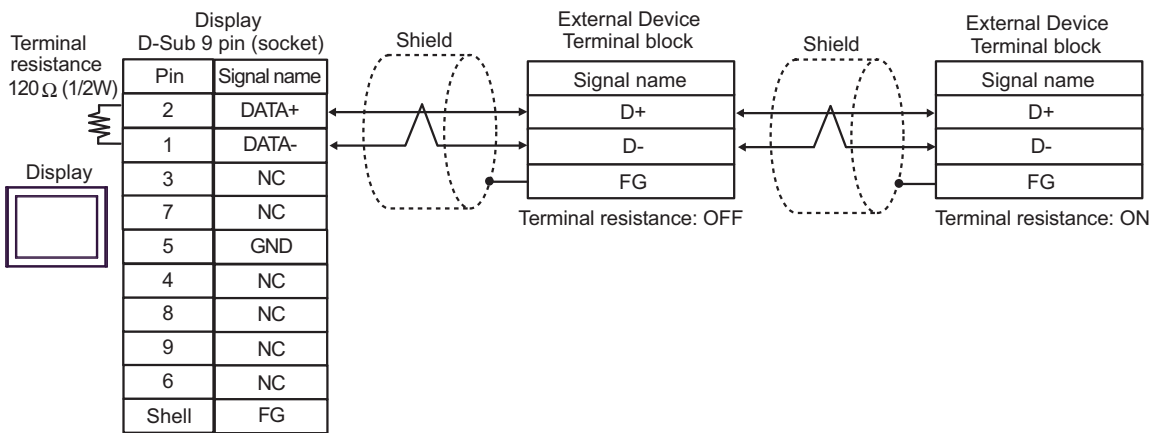

Cable Diagram 5

Display (Connection Port)	Cable		Remarks
GP3000 (COM1) GP4000* ¹ (COM1) SP5000* ² (COM1/2) SP-5B00 (COM1) ST3000 (COM1) ST6000 (COM1) STM6000 (COM1) STC6000 (COM1) ET6000 (COM1) LT3000 (COM1) IPC* ³ PC/AT	5A	User-created Cable + Cable FB-232P0-9F-150 by Fatek Automation Corporation	Cable length: 15m or less
	5B	User-created Cable + Cable FB-232P0-9M-150 by Fatek Automation Corporation	
GP-4105 (COM1) GP-4115T (COM1) GP-4115T3 (COM1)	5C	User-created Cable + Cable FB-232P0-9F-150 by Fatek Automation Corporation	Cable length: 15m or less
	5D	User-created Cable + Cable FB-232P0-9M-150 by Fatek Automation Corporation	
LT-4*01TM (COM1) LT-Rear Module (COM1)	5E	RJ45 RS-232C Cable (5m) by Pro-face PFXZLMCBJR21 + Cable FB-232P0-9F-150 by Fatek Automation Corporation	Cable length: 6.5m or less
	5F	RJ45 RS-232C Cable (5m) by Pro-face PFXZLMCBJR21 + Cable FB-232P0-9M-150 by Fatek Automation Corporation	

*1 All GP4000 models except GP-4100 Series and GP-4203T

*2 Except SP-5B00

*3 Available only with a COM port that supports RS232C.

 ■ IPC COM Port (page 6)

5A)

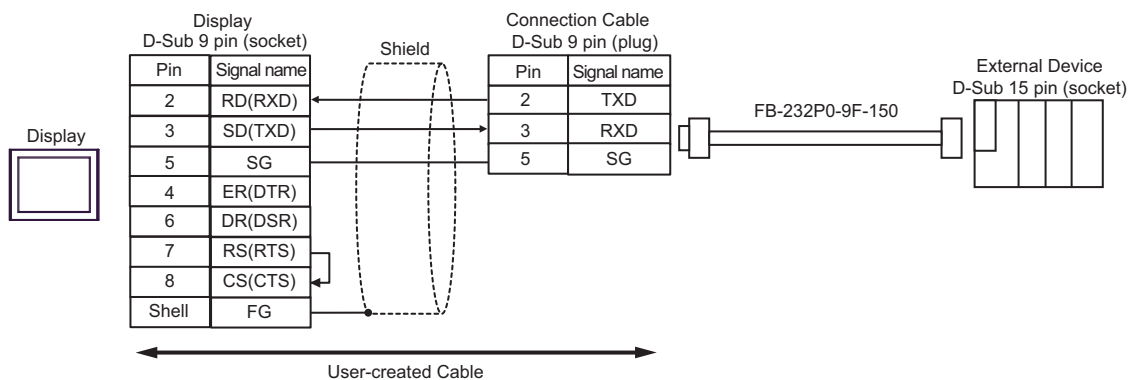

5B)

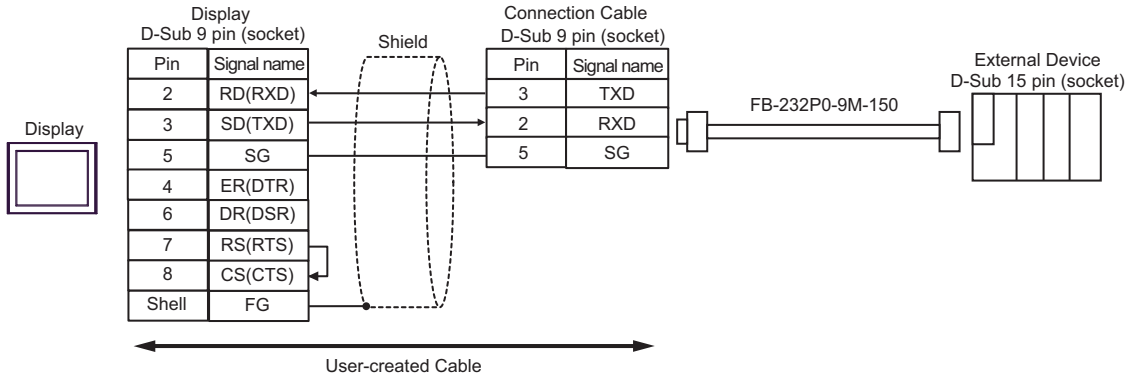

5C)

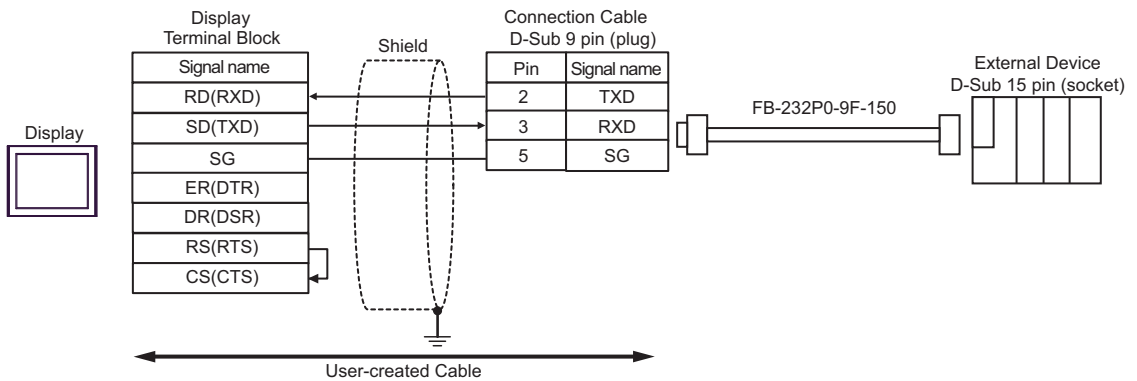

5D)

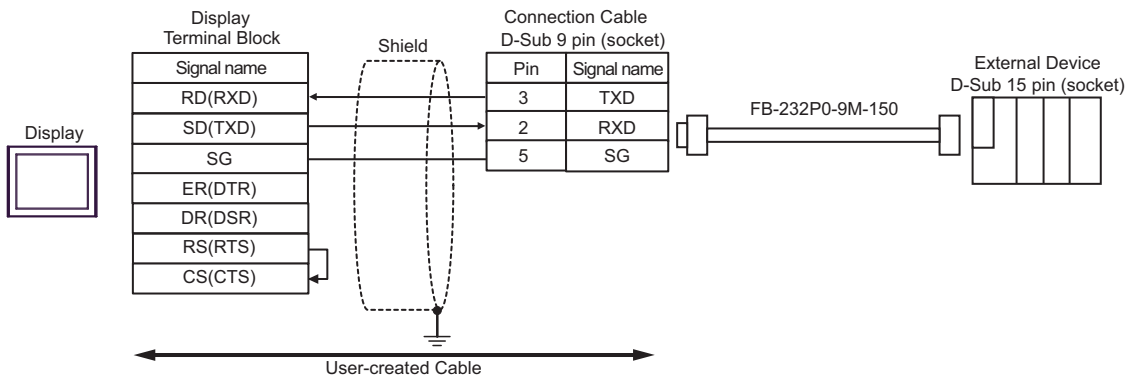

5E)

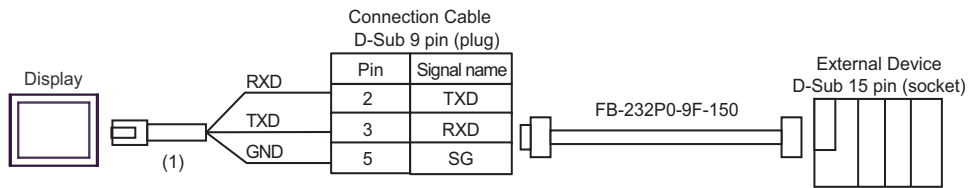

Number	Name	Notes
(1)	RJ45 RS-232C Cable (5m) by Pro-face PFXZLMCBRJ21	

5F)

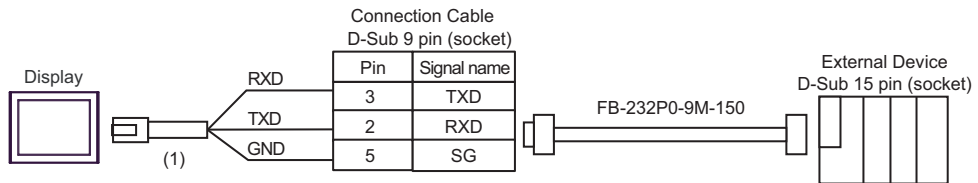

Number	Name	Notes
(1)	RJ45 RS-232C Cable (5m) by Pro-face PFXZLMCBRJ21	

Cable Diagram 6

Display (Connection Port)	Cable		Remarks
GP3000* ¹ (COM1) AGP-3302B (COM2) GP-4*01TM (COM1) GP-Rear Module (COM1) ST3000* ² (COM2) LT3000 (COM1)	6A	COM port conversion adapter by Pro-face CA3-ADPCOM-01 + Connector terminal block conversion adapter by Pro-face CA3-ADPTRM-01 + User-created Cable	Cable length: 1,000m or less
	6B	User-created Cable	
GP3000* ³ (COM2)	6C	Online adapter by Pro-face CA4-ADPONL-01 + Connector terminal block conversion adapter by Pro-face CA3-ADPTRM-01 + User-created Cable	Cable length: 1,000m or less
	6D	Online adapter by Pro-face CA4-ADPONL-01 + User-created Cable	
IPC* ⁴	6E	COM port conversion adapter by Pro-face CA3-ADPCOM-01 + Connector terminal block conversion adapter by Pro-face CA3-ADPTRM-01 + User-created Cable	Cable length: 1,000m or less
	6F	User-created Cable	
GP-4106 (COM1) GP-4116T (COM1)	6G	User-created Cable	Cable length: 1,000m or less
GP-4107 (COM1) GP-4*03T* ⁵ (COM2) GP-4203T (COM1)	6H	User-created Cable	Cable length: 1,000m or less
GP4000* ⁶ (COM2) GP-4201T (COM1) SP5000* ⁷ (COM1/2) SP-5B00 (COM2) ST6000* ⁸ (COM2) ST-6200 (COM1) STM6000 (COM1) STC6000 (COM1) ET6000* ⁹ (COM2) PS6000 (Basic Box) (COM1/2)	6I	RS-422 Terminal Block Conversion Adapter by Pro-face PFXZCBADTM1* ¹⁰ + User-created cable	Cable length: 1,000m or less
	6B	User-created cable	
LT-4*01TM (COM1) LT-Rear Module (COM1)	6J	RJ45 RS-485 Cable (5m) by Pro-face PFXZLMCBRJR81	Cable length: 200m or less

Display (Connection Port)	Cable		Remarks
PE-4000B*11 PS5000*11 PS6000 (Optional Interface)*11	6K	User-created Cable	Cable length: 1,000m or less

*1 All GP models except AGP-3302B

*2 Except AST-3211A and AST-3302B

*3 All GP models except the GP-3200 Series and AGP-3302B

*4 Available only with a COM port that supports RS422/485 (2wire). (Except PE-4000B, PS5000, and PS6000)
 ■ IPC COM Port (page 6)

*5 Except GP-4203T

*6 All GP4000 models except GP-4100 Series, GP-4*01TM, GP-Rear Module, GP-4201T and GP-4*03T

*7 Except SP-5B00

*8 Except ST-6200

*9 Due to the COM port specifications, flow control is not possible. Omit wiring the control pins on the Display side of the cable diagram.

*10 When using a Terminal Block Conversion Adapter (CA3-ADPTRM-01) instead of the RS-422 Terminal Block Conversion Adapter, refer to Cable Diagram 6A.

*11 Available only with a COM port that supports RS422/485 (2wire).
 ■ IPC COM Port (page 6)

6A)

- 1:1 Connection

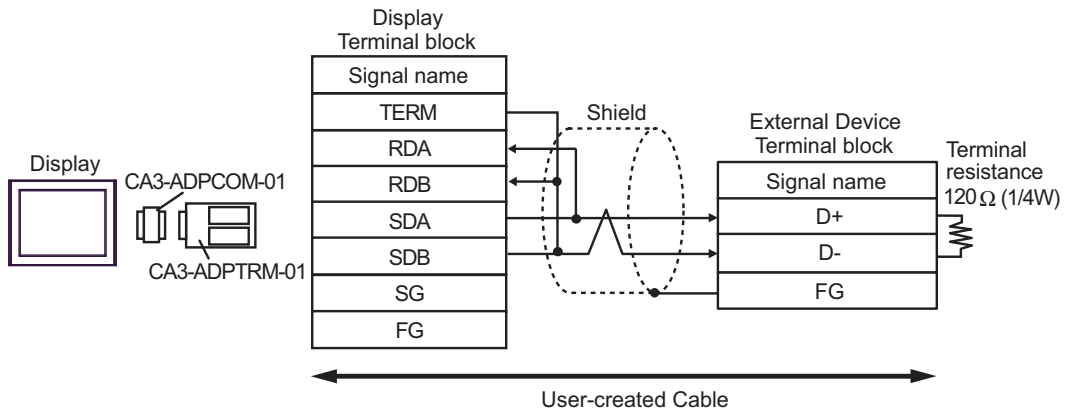

- 1:n Connection

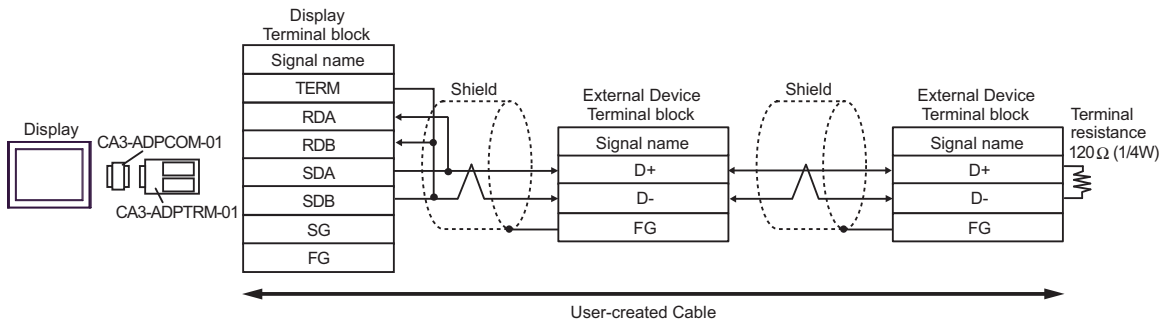

6B)

- 1:1 Connection

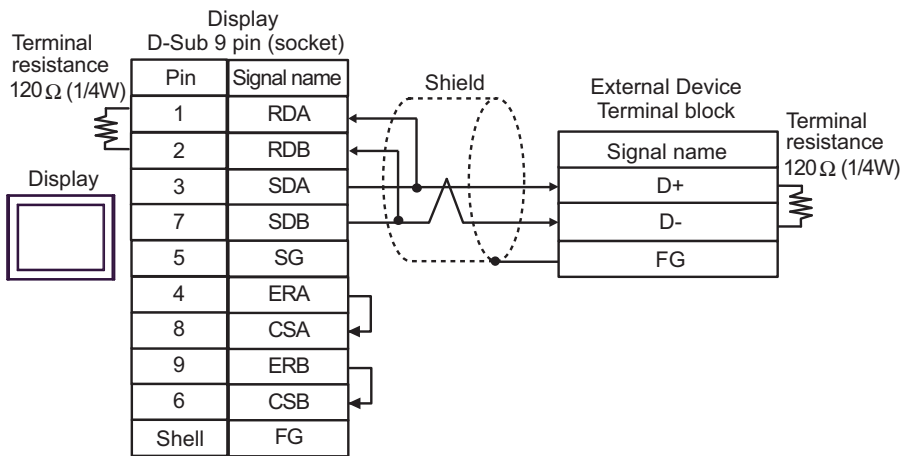

- 1:n Connection

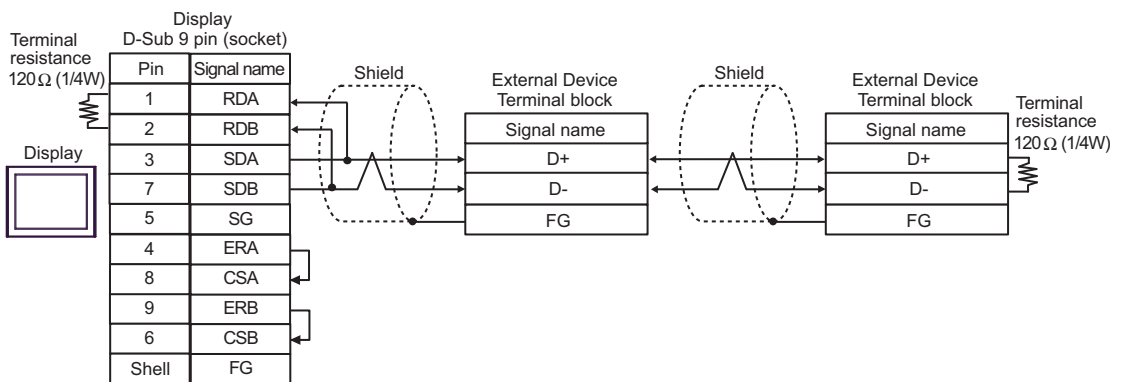

6C)

- 1:1 Connection

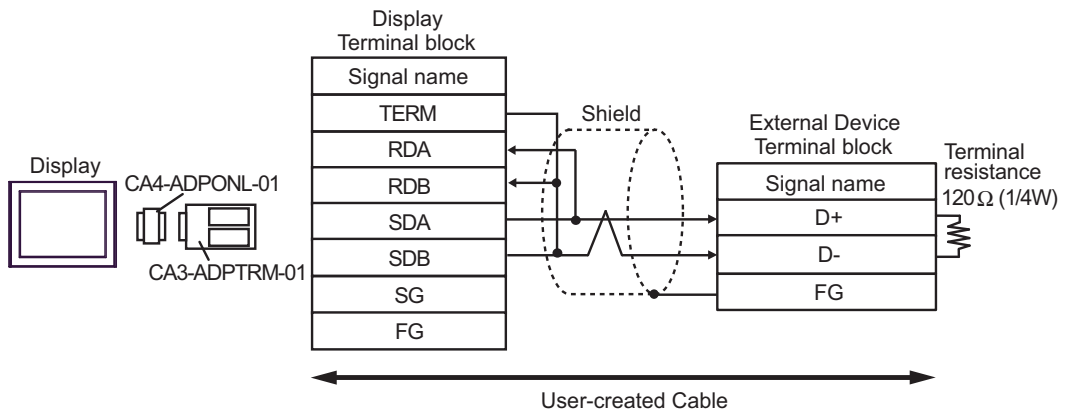

- 1:n Connection

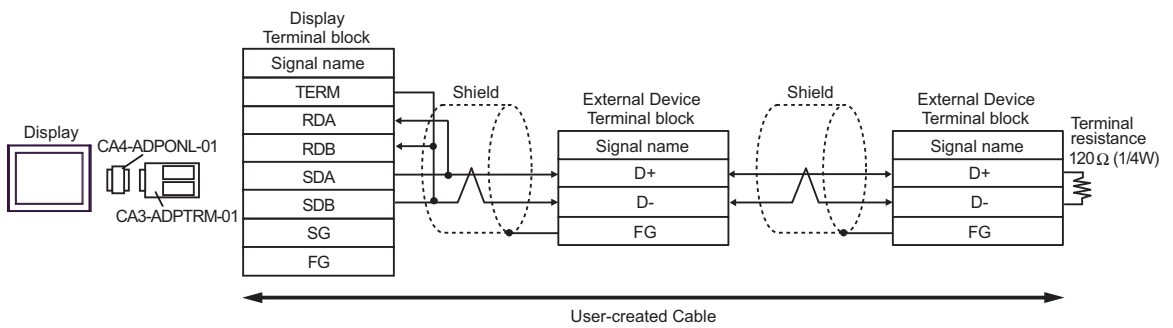

6D)

- 1:1 Connection

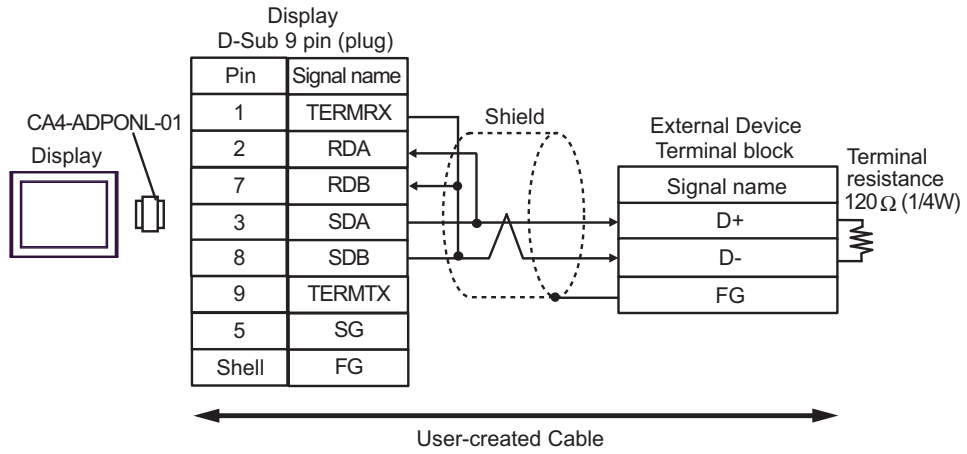

- 1:n Connection

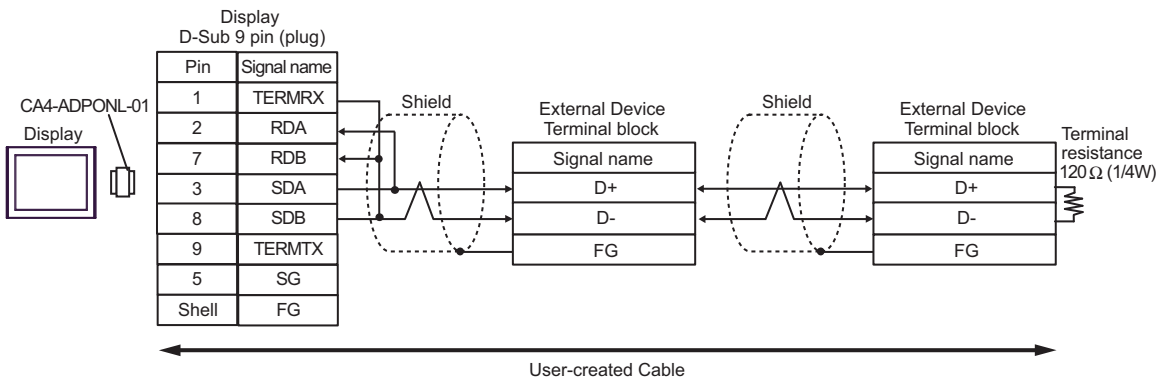

6E)

- 1:1 Connection

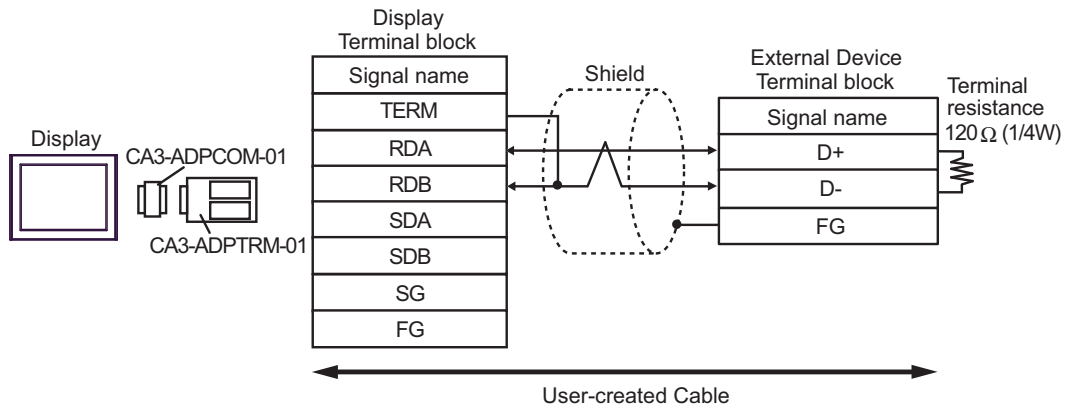

- 1:n Connection

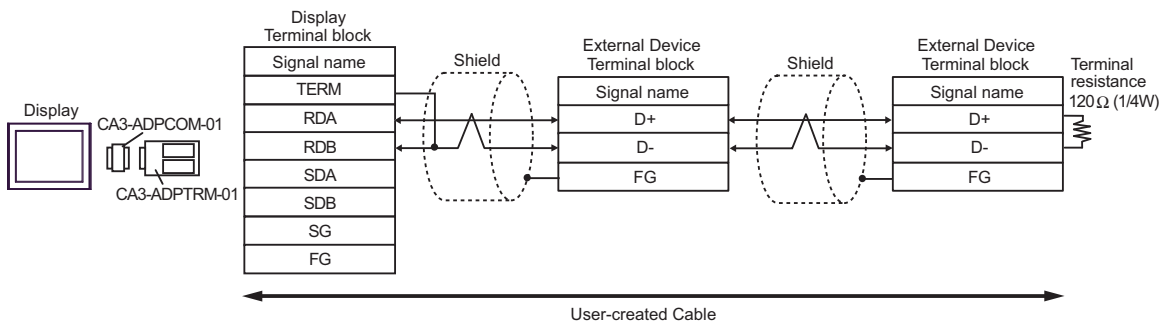

6F)

- 1:1 Connection

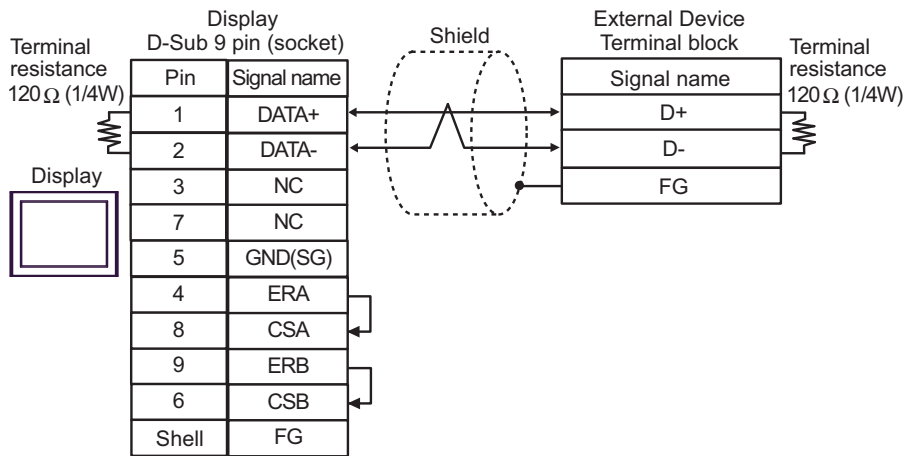

- 1:n Connection

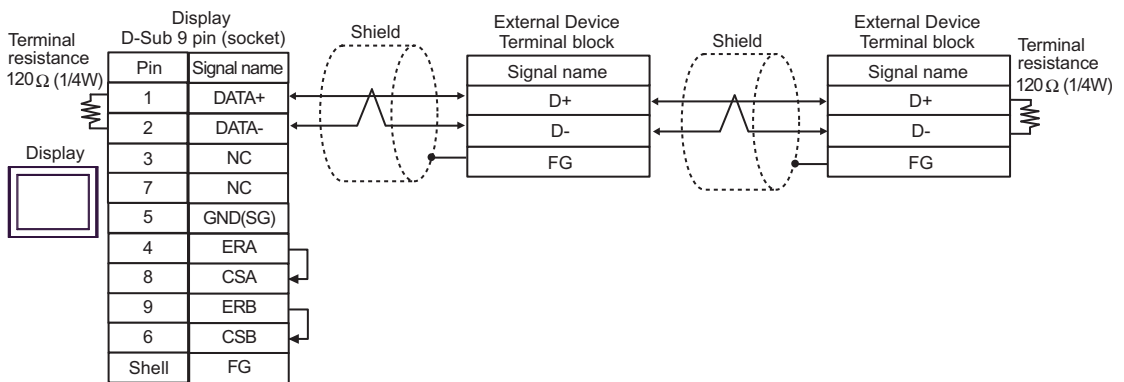

6G)

• 1:1 Connection

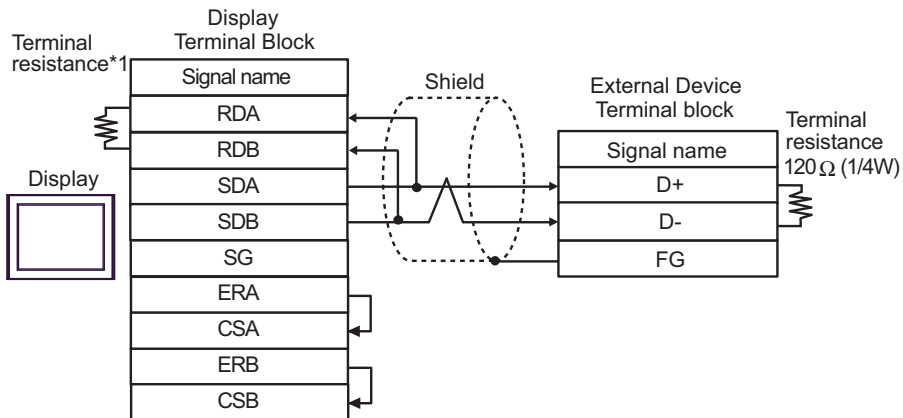

• 1:n Connection

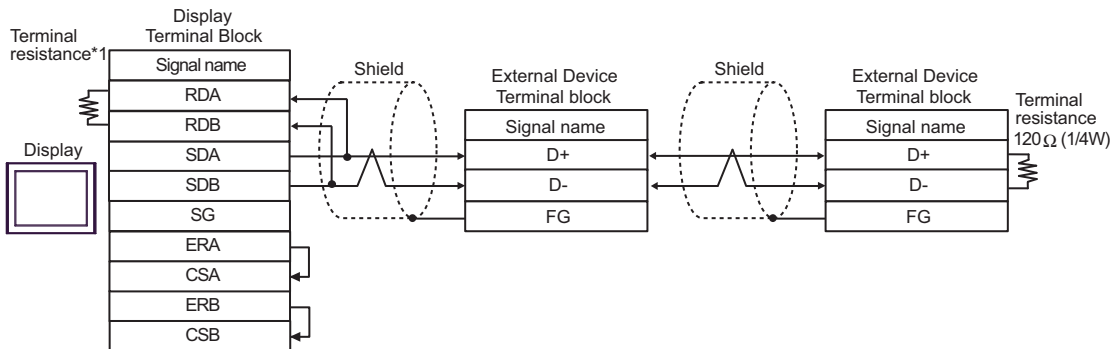

*1 The resistance in the Display is used as the termination resistance. Set the value of the DIP Switch on the rear of the Display as shown in the table below.

DIP Switch No.	Set Value
1	OFF
2	OFF
3	ON
4	ON

6H)

- 1:1 Connection

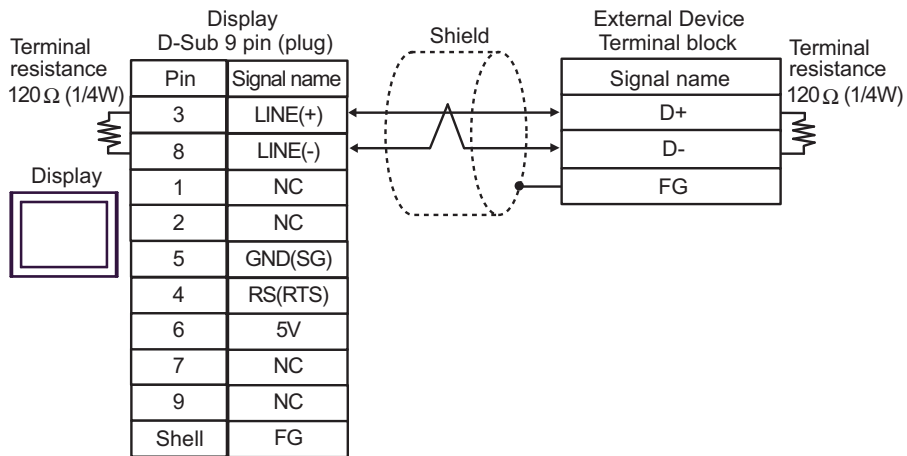

- 1:n Connection

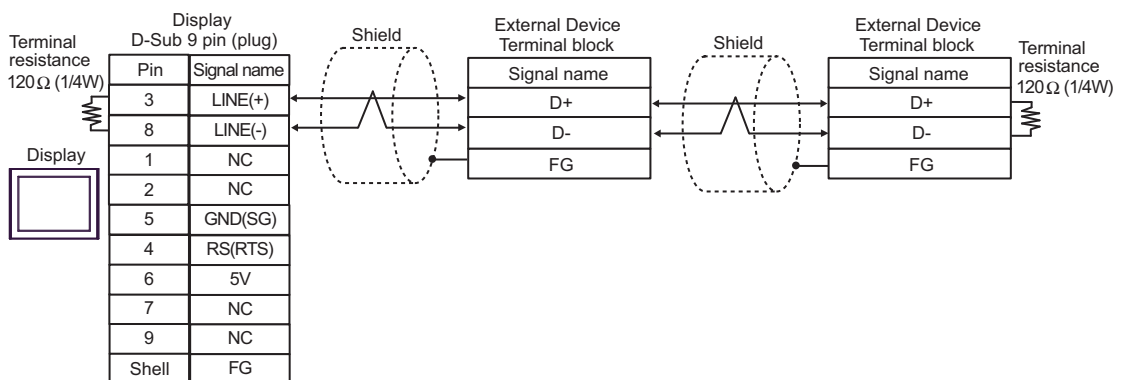

IMPORTANT • The 5V output (Pin #6) on the Display is the power for the Siemens AG's PROFIBUS connector. Do not use it for other devices.

NOTE • In COM on the GP-4107, the SG and FG terminals are isolated.

6l)

• 1:1 Connection

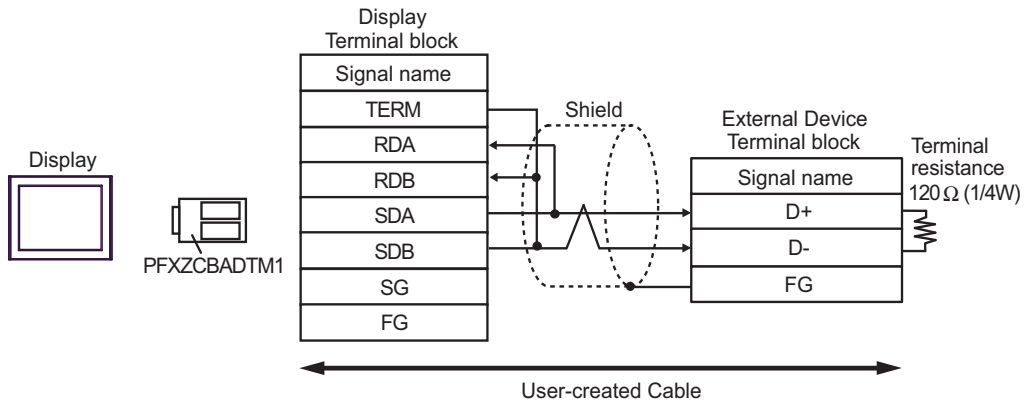

• 1:n Connection

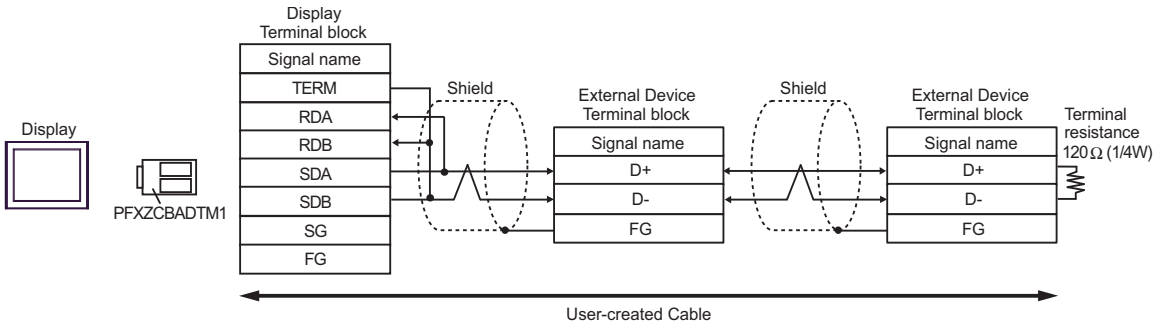

6J)

- 1:1 Connection

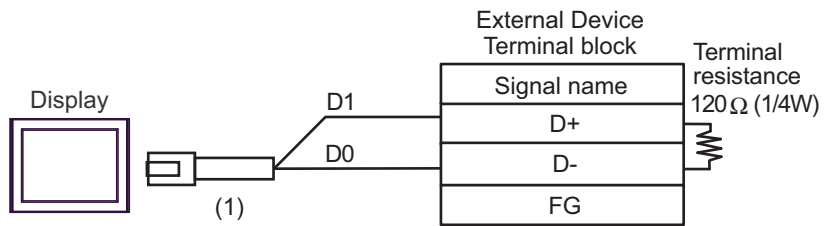

- 1:n Connection

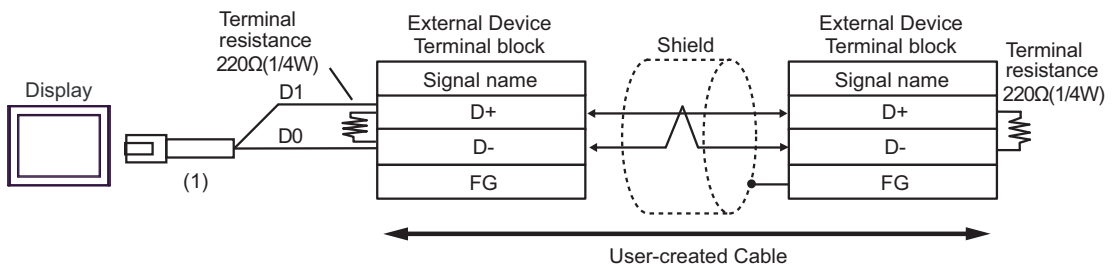

Number	Name	Notes
(1)	RJ45 RS-485 Cable (5m) by Pro-face PFXZLMCBJR81	

6K)

- 1:1 Connection

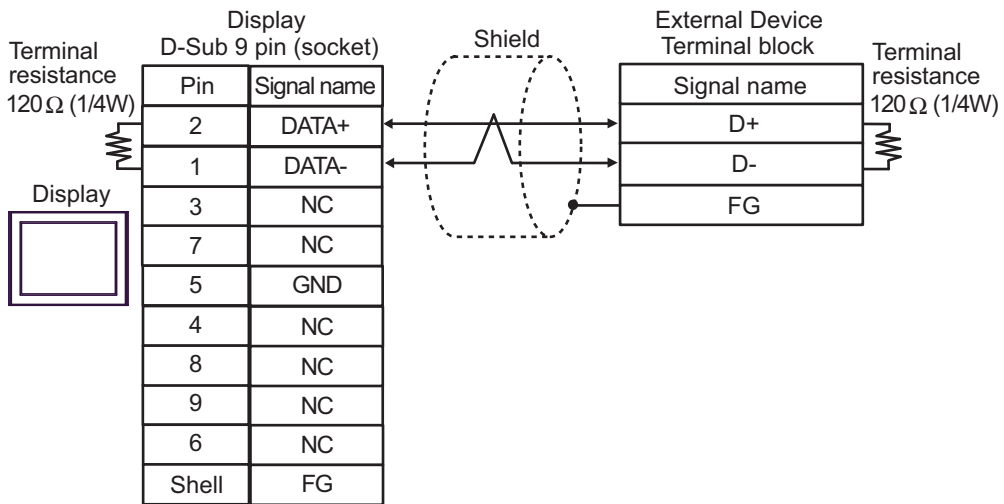

- 1:n Connection

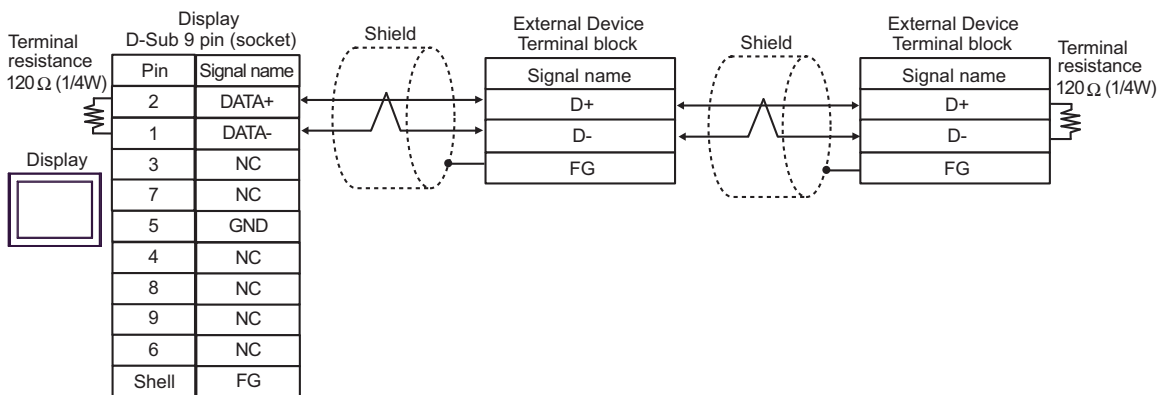

Cable Diagram 7

Display (Connection Port)	Cable		Remarks
GP3000 (COM1) GP4000* ¹ (COM1) SP5000* ² (COM1/2) SP-5B00 (COM1) ST3000 (COM1) ST6000 (COM1) STM6000 (COM1) STC6000 (COM1) ET6000 (COM1) LT3000 (COM1) IPC* ³ PC/AT	7A	User-created Cable	Cable length: 15m or less
GP-4105 (COM1) GP-4115T (COM1) GP-4115T3 (COM1)	7B	User-created Cable	Cable length: 15m or less
LT-4*01TM (COM1) LT-Rear Module (COM1)	7C	RJ45 RS-232C Cable (5m) by Pro-face PFXZLMCBJR21	Cable length: 5m or less

*1 All GP4000 models except GP-4100 Series and GP-4203T

*2 Except SP-5B00

*3 Available only with a COM port that supports RS232C.

 ■ IPC COM Port (page 6)

7A)

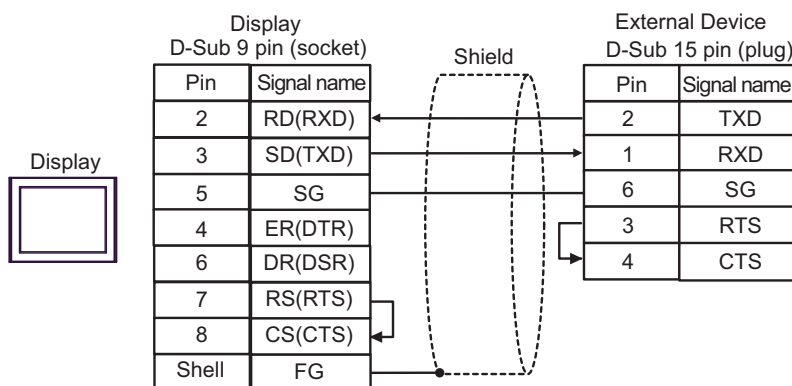

7B)

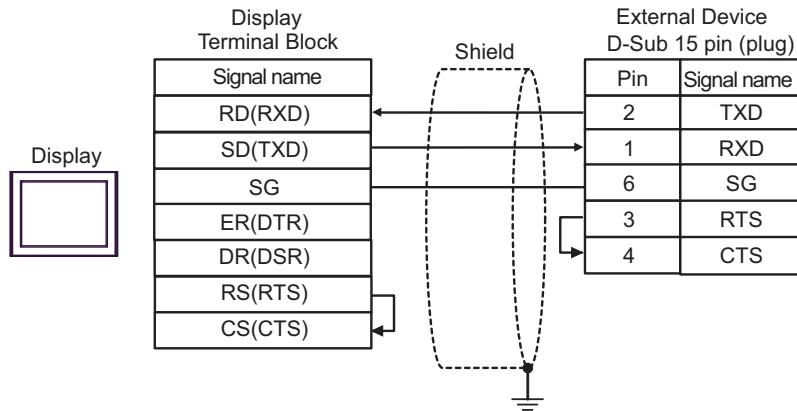

7C)

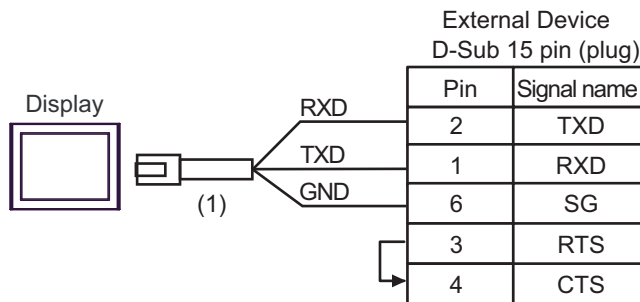

Number	Name	Notes
(1)	RJ45 RS-232C Cable (5m) by Pro-face PFXZLMCBJR21	

Cable Diagram 8

Display (Connection Port)	Cable		Remarks
GP3000* ¹ (COM1) AGP-3302B (COM2) GP-4*01TM (COM1) GP-Rear Module (COM1) ST3000* ² (COM2) LT3000 (COM1)	8A	COM port conversion adapter by Pro-face CA3-ADPCOM-01 + Connector terminal block conversion adapter by Pro-face CA3-ADPTRM-01 + User-created Cable	Cable length: 1,000m or less
	8B	User-created Cable	
GP3000* ³ (COM2)	8C	Online adapter by Pro-face CA4-ADPONL-01 + Connector terminal block conversion adapter by Pro-face CA3-ADPTRM-01 + User-created Cable	Cable length: 1,000m or less
	8D	Online adapter by Pro-face CA4-ADPONL-01 + User-created Cable	
IPC* ⁴	8E	COM port conversion adapter by Pro-face. CA3-ADPCOM-01 + Connector terminal block conversion adapter by Pro-face CA3-ADPTRM-01 + User-created Cable	Cable length: 1,000m or less
	8F	User-created Cable	
GP-4106 (COM1) GP-4116T (COM1)	8G	User-created Cable	Cable length: 1,000m or less
GP-4107 (COM1) GP-4*03T* ⁵ (COM2) GP-4203T (COM1)	8H	User-created Cable	Cable length: 1,000m or less
GP4000* ⁶ (COM2) GP-4201T (COM1) SP5000* ⁷ (COM1/2) SP-5B00 (COM2) ST6000* ⁸ (COM2) ST-6200 (COM1) STM6000 (COM1) STC6000 (COM1) ET6000* ⁹ (COM2) PS6000 (Basic Box) (COM1/2)	8I	RS-422 Terminal Block Conversion Adapter by Pro-face PFXZCBADTM1* ¹⁰ + User-created cable	Cable length: 1,000m or less
	8B	User-created cable	
LT-4*01TM (COM1) LT-Rear Module (COM1)	8J	RJ45 RS-485 Cable (5m) by Pro-face PFXZLMCBRJ81	Cable length: 200m or less

Display (Connection Port)	Cable		Remarks
PE-4000B*11 PS5000*11 PS6000 (Optional Interface)*11	8K	User-created Cable	Cable length: 1,000m or less

- *1 All GP models except AGP-3302B
- *2 Except AST-3211A and AST-3302B
- *3 All GP models except the GP-3200 Series and AGP-3302B
- *4 Available only with a COM port that supports RS422/485 (2wire). (Except PE-4000B, PS5000, and PS6000)
☞ ■ IPC COM Port (page 6)
- *5 Except GP-4203T
- *6 All GP4000 models except GP-4100 Series, GP-4*01TM, GP-Rear Module, GP-4201T and GP-4*03T
- *7 Except SP-5B00
- *8 Except ST-6200
- *9 Due to the COM port specifications, flow control is not possible. Omit wiring the control pins on the Display side of the cable diagram.
- *10 When using a Terminal Block Conversion Adapter (CA3-ADPTRM-01) instead of the RS-422 Terminal Block Conversion Adapter, refer to Cable Diagram 8A.
- *11 Available only with a COM port that supports RS422/485 (2wire).
☞ ■ IPC COM Port (page 6)

8A)

- 1:1 Connection

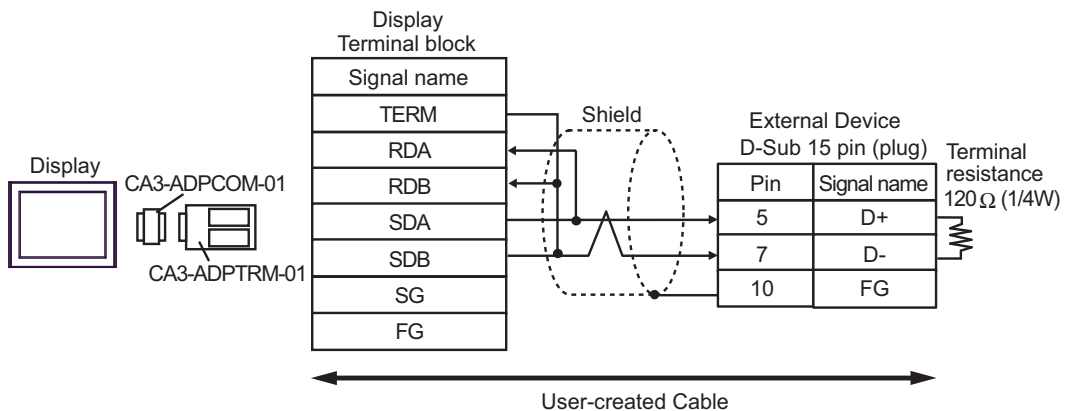

- 1:n Connection

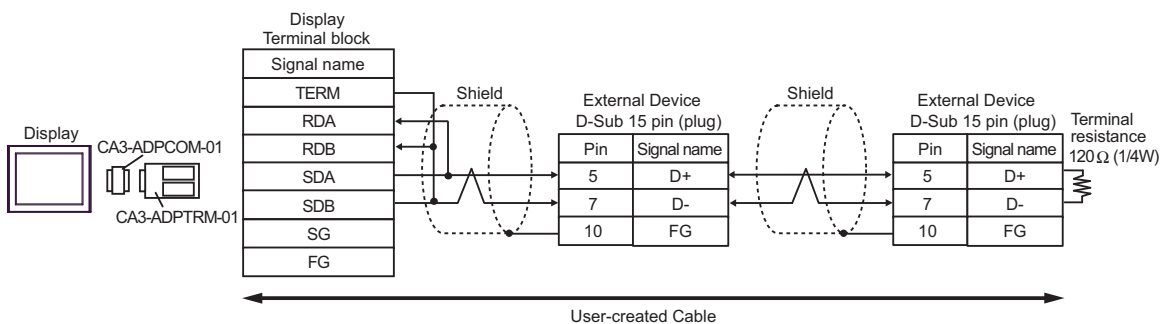

8B)

• 1:1 Connection

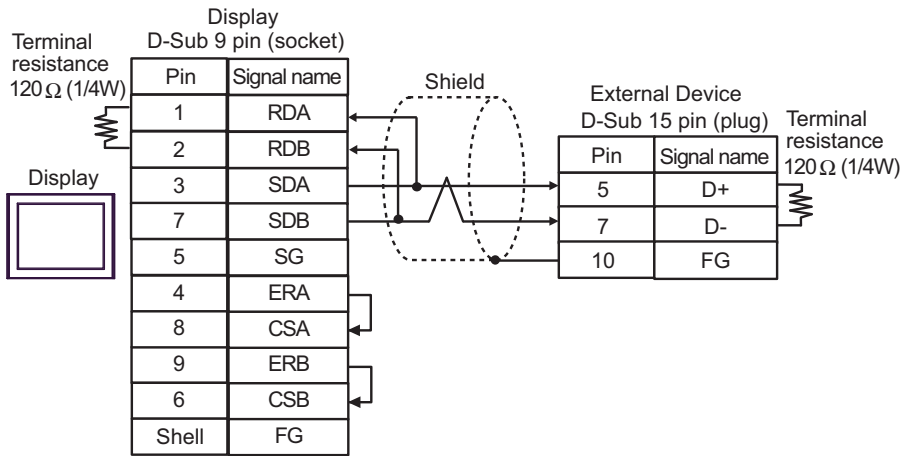

• 1:n Connection

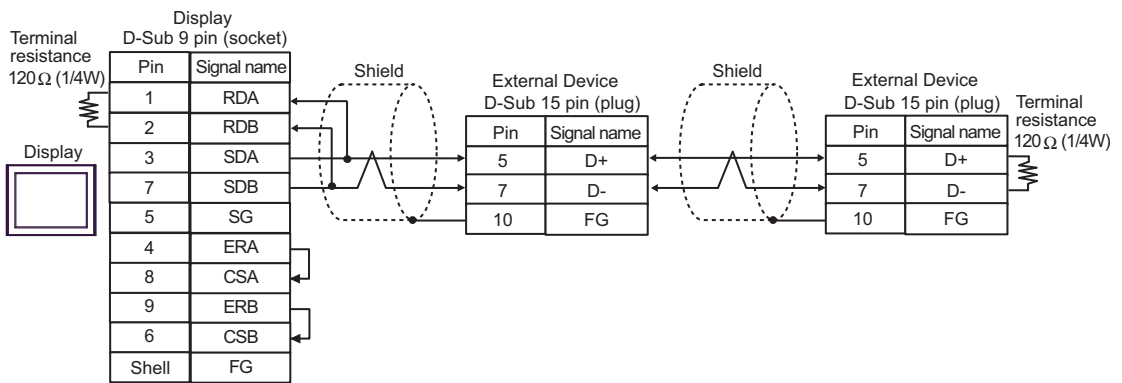

8C)

- 1:1 Connection

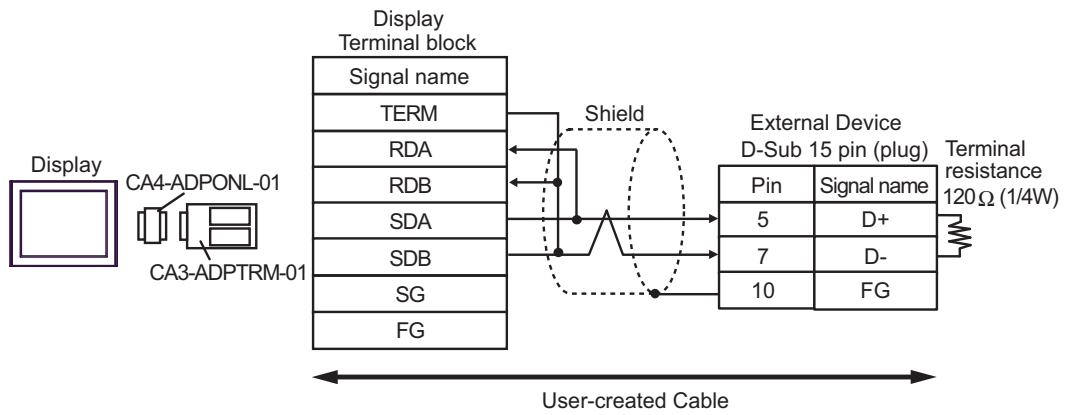

- 1:n Connection

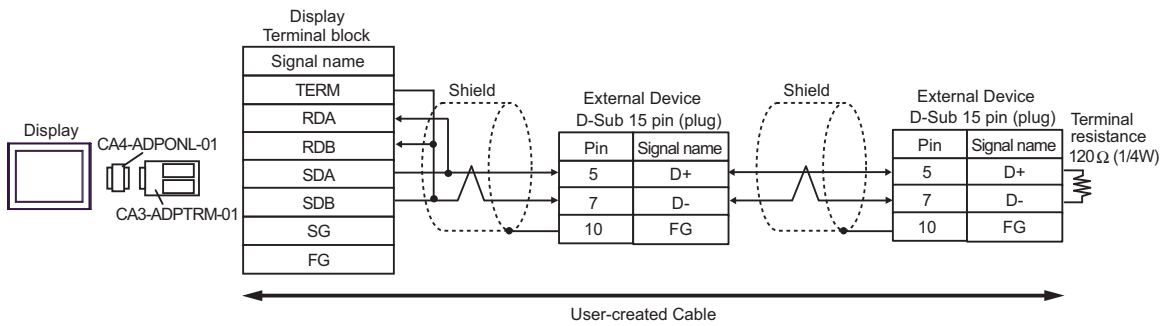

8D)

• 1:1 Connection

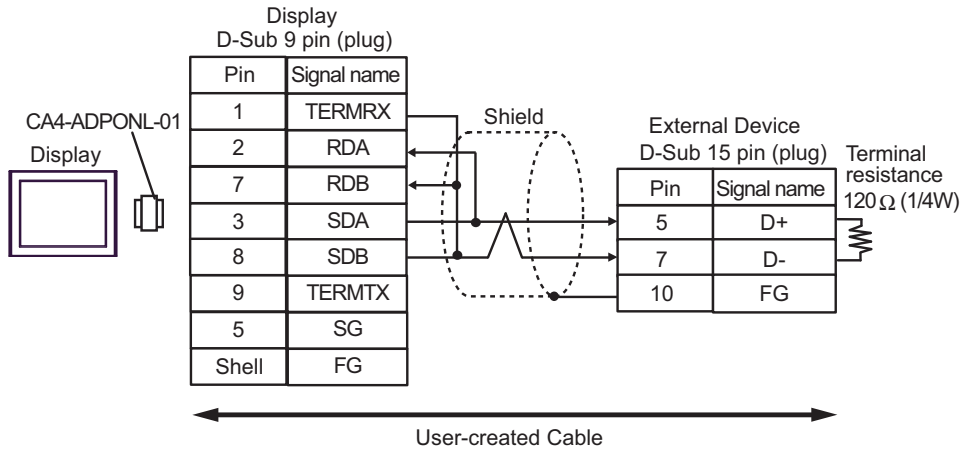

• 1:n Connection

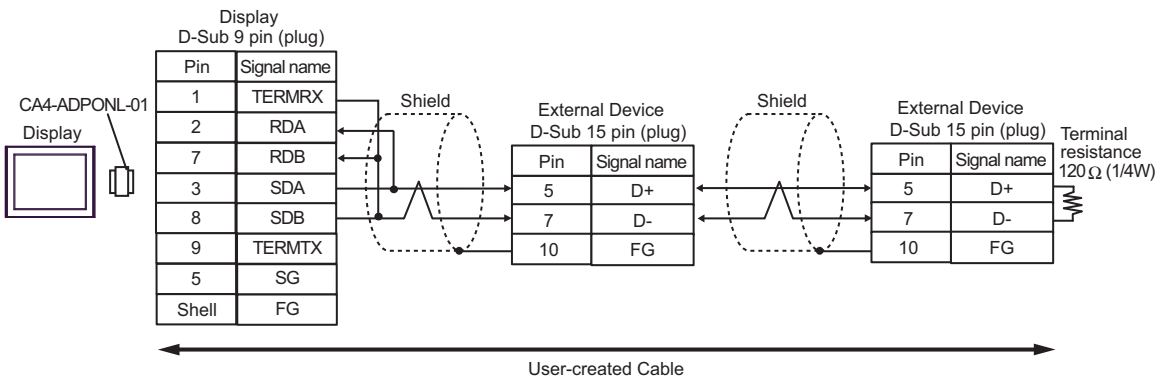

8E)

- 1:1 Connection

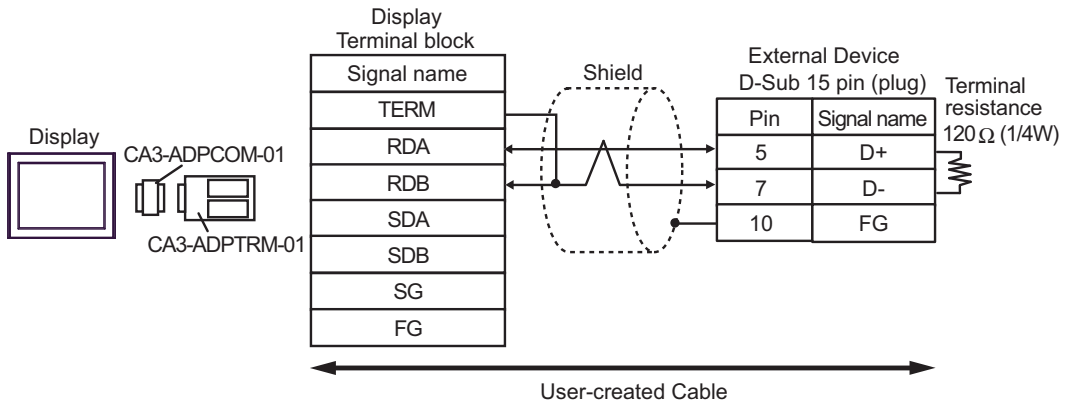

- 1:n Connection

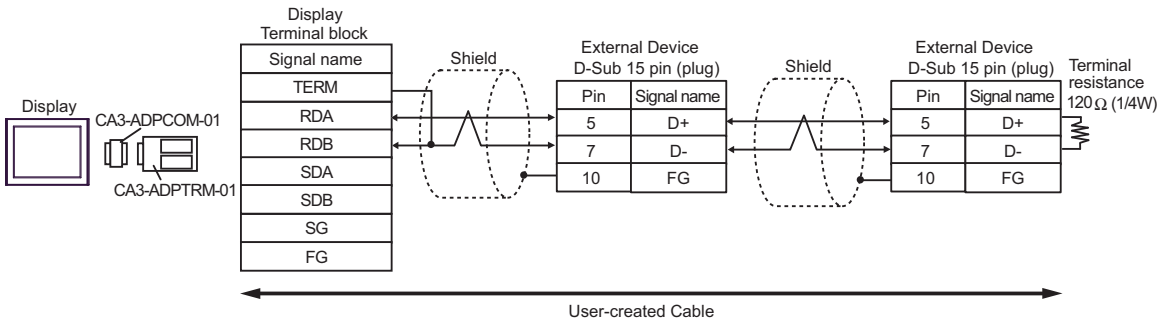

8F)

- 1:1 Connection

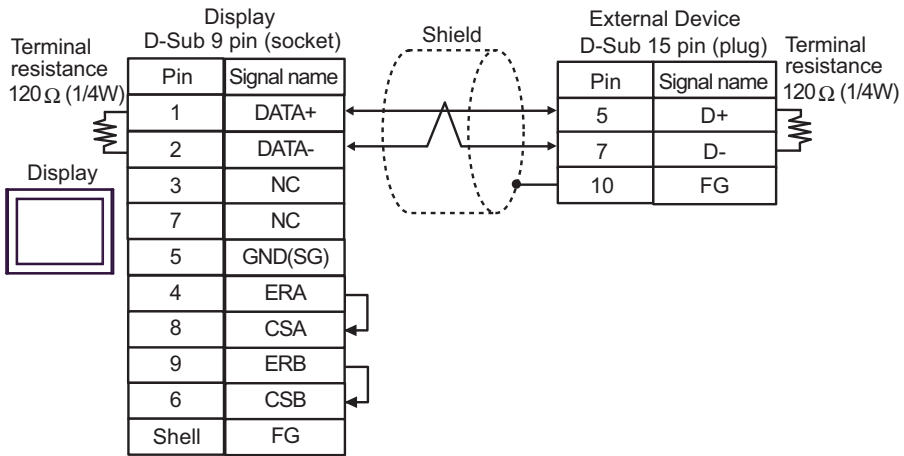

- 1:n Connection

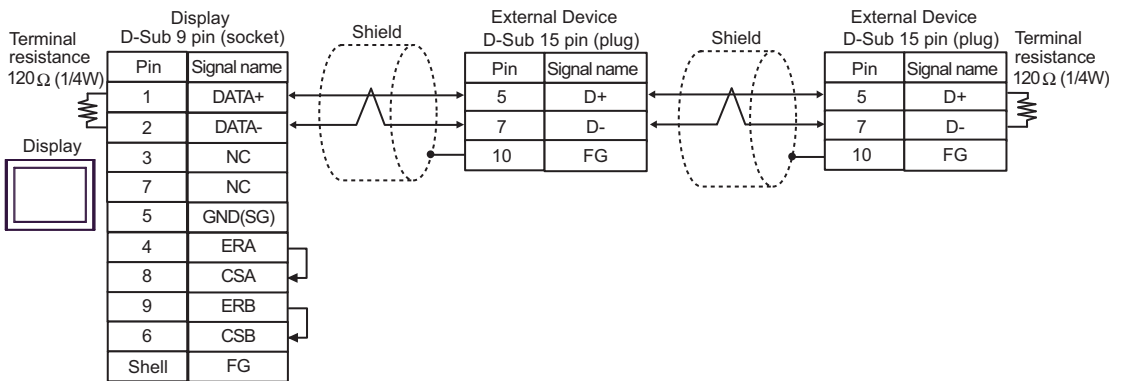

8G)

• 1:1 Connection

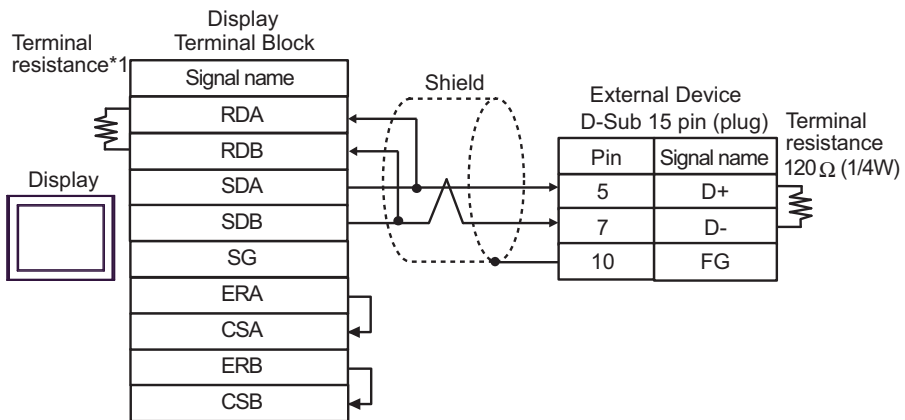

• 1:n Connection

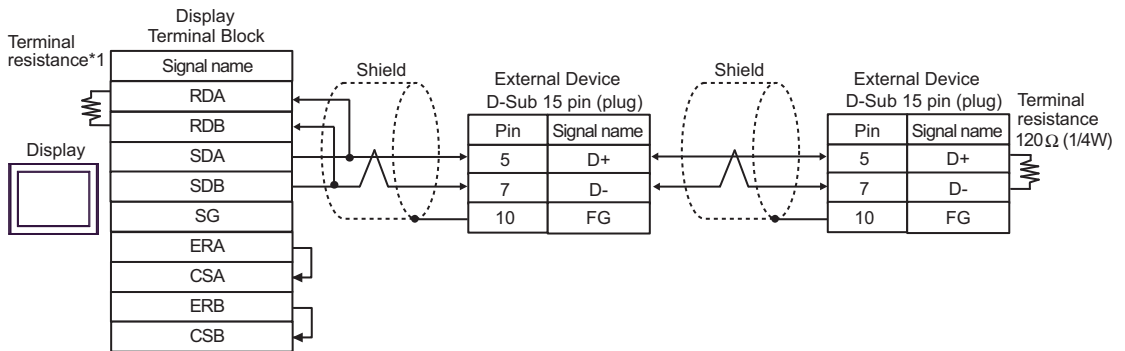

*1 The resistance in the Display is used as the termination resistance. Set the value of the DIP Switch on the rear of the Display as shown in the table below.

DIP Switch No.	Set Value
1	OFF
2	OFF
3	ON
4	ON

8H)

- 1:1 Connection

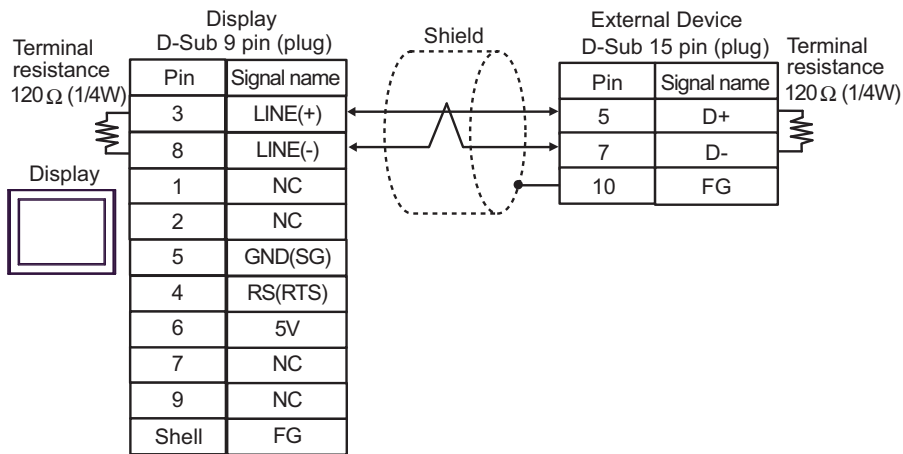

- 1:n Connection

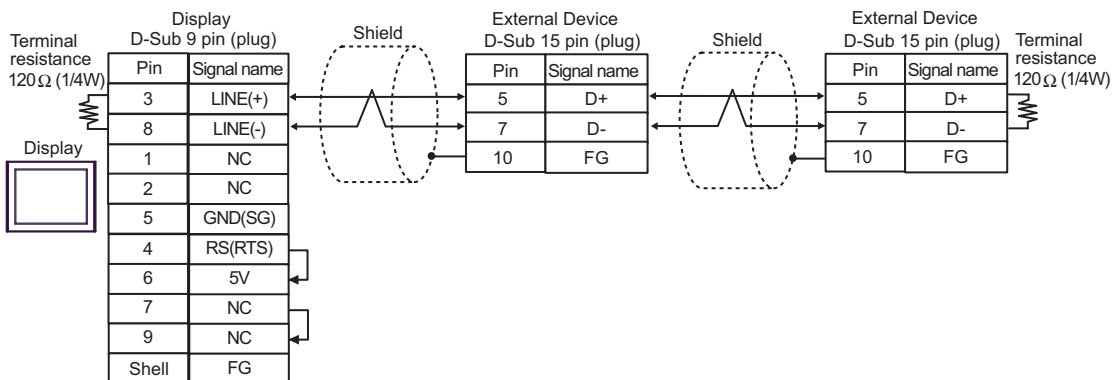

IMPORTANT • The 5V output (Pin #6) on the Display is the power for the Siemens AG's PROFIBUS connector. Do not use it for other devices.

NOTE • In COM on the GP-4107, the SG and FG terminals are isolated.

8l)

• 1:1 Connection

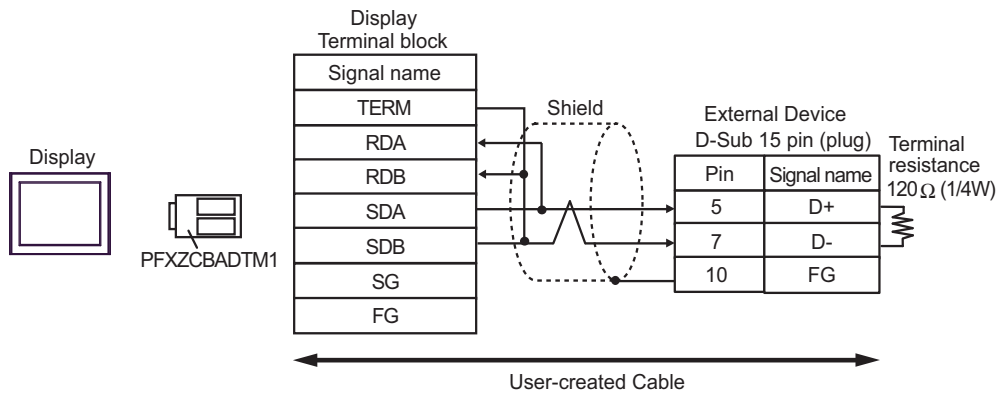

• 1:n Connection

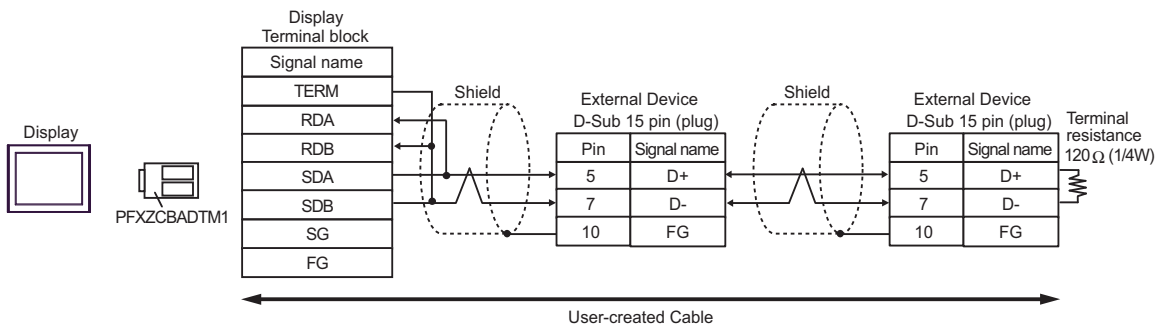

8J)

- 1:1 Connection

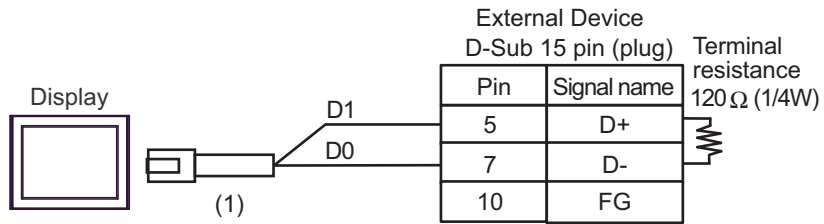

- 1:n Connection

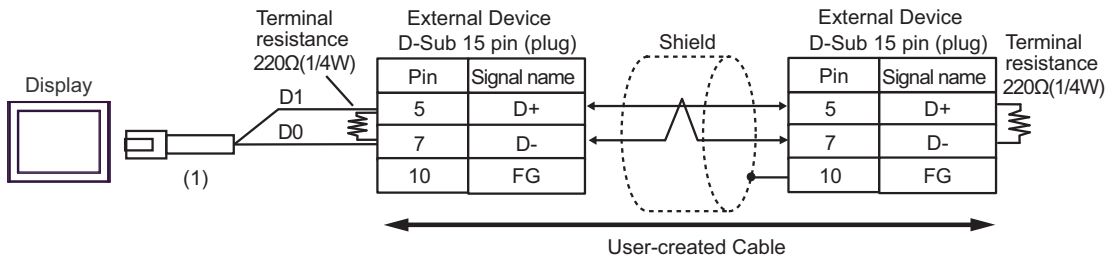

Number	Name	Notes
(1)	RJ45 RS-485 Cable (5m) by Pro-face PFXZLMCBRJ81	

8K)

- 1:1 Connection

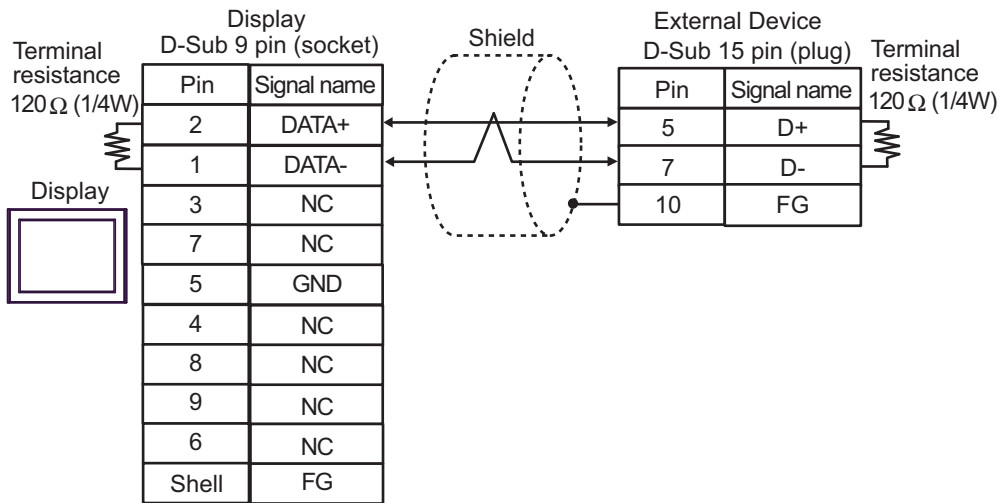

- 1:n Connection

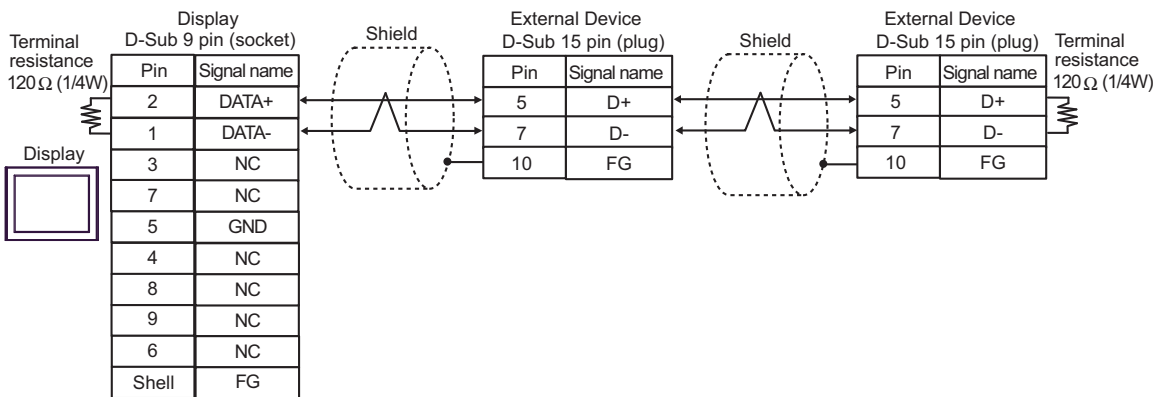

Cable Diagram 9

Display (Connection Port)	Cable		Remarks
GP3000 (COM1) GP4000* ¹ (COM1) SP5000* ² (COM1/2) SP-5B00 (COM1) ST3000 (COM1) ST6000 (COM1) STM6000 (COM1) STC6000 (COM1) ET6000 (COM1) LT3000 (COM1) IPC* ³ PC/AT	9A	User-created Cable	Cable length: 15m or less
GP-4105 (COM1) GP-4115T (COM1) GP-4115T3 (COM1)	9B	User-created Cable	Cable length: 15m or less
LT-4*01TM (COM1) LT-Rear Module (COM1)	9C	RJ45 RS-232C Cable (5m) by Pro-face PFXZLMCBJR21	Cable length: 5m or less

*1 All GP4000 models except GP-4100 Series and GP-4203T

*2 Except SP-5B00

*3 Available only with a COM port that supports RS232C.

 ■ IPC COM Port (page 6)

9A)

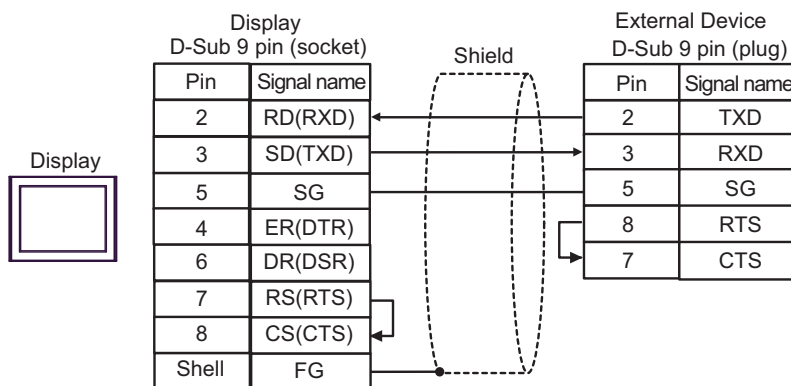

9B)

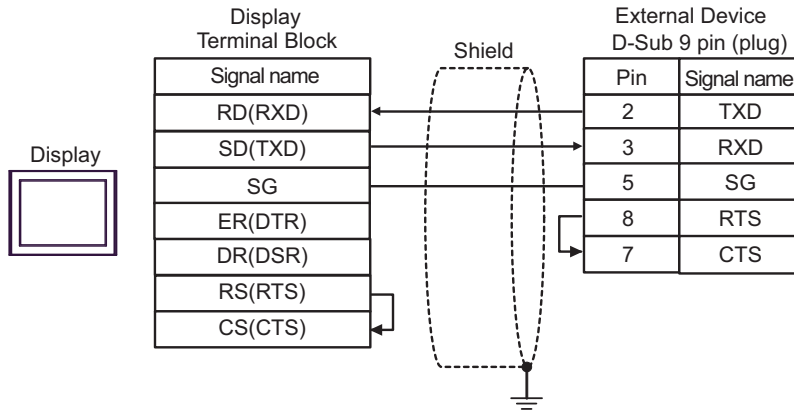

9C)

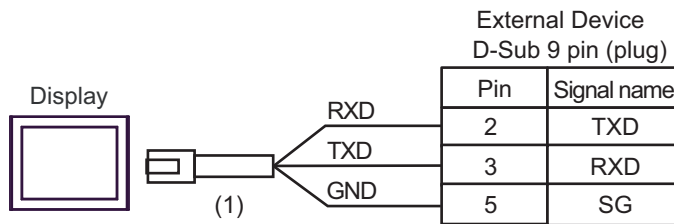















Number	Name	Notes
(1)	RJ45 RS-232C Cable (5m) by Pro-face PFXZLMCBJR21	

6 Supported Devices

The following table shows the range of supported device addresses. Available type and range of device may vary depending on the CPU. Consult the appropriate CPU manual before use.

 : This address can be specified as system data area.

Device	Bit Address	Word Address	32 bit	Remarks
Input Relay	X0000 - X0255	WX0000 - WX0240	L/H	
Output Relay	Y0000 - Y0255	WY0000 - WY0240		
Step Relay	S0000 - S0999	WS0000 - WS0976		
Internal Relay	M0000 - M1911	WM0000 - WM1888		
Special Relay	SM1912 - SM2001	WSM1912 - WSM1976		
Timer (Contact)	T0000 - T0255	-		
Counter (Contact)	C0000 - C0255	-		
Timer (Current Value)	-	TMR0000 - TMR0255	L/H	
Counter (Current Value)	-	CTR0000 - CTR0199		
High-speed Counter	-	HC0200 - HC0255		*1
Data Register *2	-	HR0000 - HR8071		 *3
Data Register *2	R00000.00 - R08071.15	R00000 - R08071		*3
Data Register	D00000.00 - D04095.15 (FBs) D00000.00 - D03071.15 (FBe/FBn)	D00000 - D04095 (FBs) D00000 - D03071 (FBe/FBn)		
Input Register	-	IR3840 - IR3903		
Output Register	-	OR3904 - OR3967		
Special Register	-	SR3968 - SR4167		
HSC Register	-	HSC4096 - HSC4127		
Calendar Register	-	RTC4128 - RTC4135		
HST Register	-	HST4152 - HST4154		
Read-only Register	-	ROR5000 - ROR8071		 *4
File Register *5	-	F00000 - F08191		

*1 32-bit device

*2 The External Device handles data registers HR and R as the same device. However, their bit-write operations differ as shown below. Select either register according to your system specifications.

- Device R allows data to be written to each specified bit.
- Device HR sets the 15 bits other than a specified bit to OFF(0).

- *3 No data can be written to word addresses HR5000 to HR8071 and R05000 to R08071.
- *4 Write disable
- *5 The file register is supported only by the FBs Series.

NOTE

- Refer to the GP-Pro EX Reference Manual for system data area.

Cf. GP-Pro EX Reference Manual "LS Area (Direct Access Method Area)"

- Refer to the precautions on manual notation for icons in the table.

 "Manual Symbols and Terminology"

7 Device Code and Address Code

Use device code and address code when you select "Device Type & Address" for the address type of the data display or other devices.

Device	Device Name	Device Code (HEX)	Address Code
Input Relay	X/WX	0082	Value of word address divided by 16
Output Relay	Y/WY	0083	Value of word address divided by 16
Step Relay	WS	0084	Value of word address divided by 16
Internal Relay	WM	0085	Value of word address divided by 16
Special Relay	WSM	0086	Value of (word address - 1912) divided by 16
Timer (Current Value)	TMR	0060	Word Address
Counter (Current Value)	CTR	0061	Word Address
High-speed Counter	HC	0062	Word Address
Data Register	HR	0000	Word Address
Data Register	R	0080	Word Address
Data Register	D	0081	Word Address
Input Register	IR	0001	Value of (word address - 3840)
Output Register	OR	0002	Value of (word address - 3904)
Special Register	SR	0003	Value of (word address - 3968)
HSC Register	HSC	0004	Value of (word address - 4096)
Calendar Register	RTC	0005	Value of (word address - 4128)
HST Register	HST	0008	Value of (word address - 4152)
Read-only Register	ROR	0006	Value of (word address - 5000)
File Register	F	0007	Word Address

8 Error Messages

Error messages are displayed on the Display screen as follows: "No.: Device Name: Error Message (Error Occurrence Area)". Each description is shown below.

Item	Description
No.	Error No.
Device Name	Name of the External Device where an error has occurred. Device name is the title of the External Device set with GP-Pro EX. (Initial value [PLC1])
Error Message	Displays messages related to an error that has occurred.
Error Occurrence Area	<p>Displays the IP address or device address of the External Device where an error has occurred, or error codes received from the External Device.</p> <p>NOTE</p> <ul style="list-style-type: none"> • IP address is displayed as "IP address (Decimal): MAC address (Hex)". • Device address is displayed as "Address: Device address". • Received error codes are displayed as "Decimal [Hex]".

Display Examples of Error Messages

"RHAA035: PLC1: Error has been responded for device write command (Error Code:1[01H])"

NOTE

- Refer to your External Device manual for details on received error codes.
- Refer to "Display-related errors" in "Maintenance/Troubleshooting guide" for details on the error messages common to the driver.