



CTC Binary Protocol Driver

1	System Configuration.....	3
2	External Device Selection	7
3	Communication Settings	8
4	Setup Items	12
5	Cable Diagrams	16
6	Supported Devices.....	18
7	Device Code and Address Code.....	19
8	Error Messages.....	20

Introduction

This manual describes how to connect the Display and the External Device (target PLC).

In this manual, the connection procedure is described in the sections identified below:

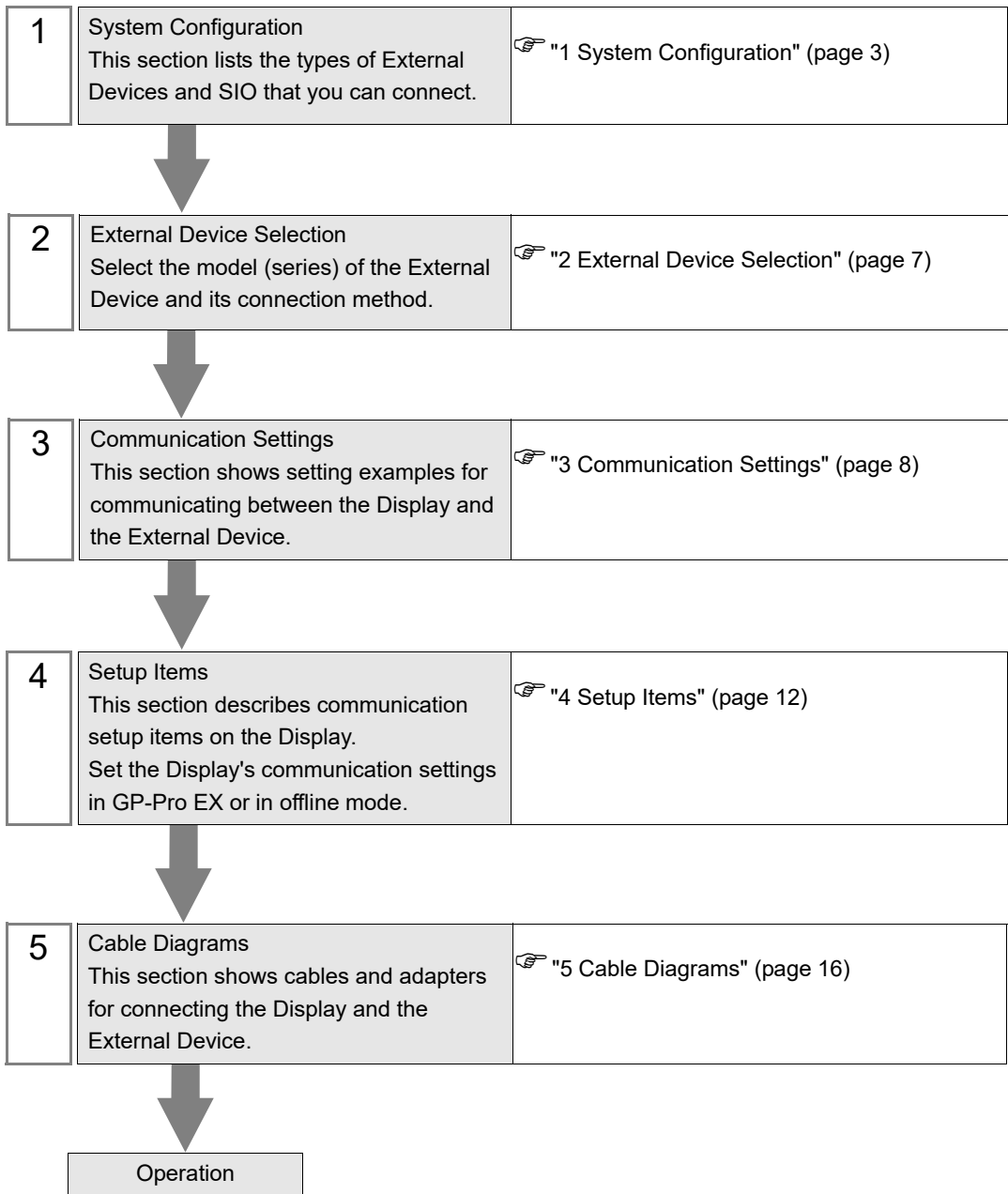

1 System Configuration

The following table lists system configurations for connecting Control Technology Corporation External Devices and the Display.

Series	Controller	Link I/F	SIO Type	Setting Example	Cable Diagrams
2700 Series	2701E	RS-232C port on the CPU unit	RS-232C	Setting Example 1 (page 8)	Cable Diagram 1 (page 16)
		RS-232C port on the Model2217	RS-232C	Setting Example 2 (page 10)	Cable Diagram 1 (page 16)
		RS-232C port on the Model2716	RS-232C	Setting Example 2 (page 10)	Cable Diagram 1 (page 16)
		RS-232C port on the Model2717	RS-232C	Setting Example 2 (page 10)	Cable Diagram 1 (page 16)
	2703AP	RS-232C port on the CPU unit	RS-232C	Setting Example 1 (page 8)	Cable Diagram 1 (page 16)
		COMM port on the Model2886 Adapter	RS-232C	Setting Example 1 (page 8)	Cable Diagram 1 (page 16)
		RS-232C port on the Model2217	RS-232C	Setting Example 2 (page 10)	Cable Diagram 1 (page 16)
		RS-232C port on the Model2716	RS-232C	Setting Example 2 (page 10)	Cable Diagram 1 (page 16)
		RS-232C port on the Model2717	RS-232C	Setting Example 2 (page 10)	Cable Diagram 1 (page 16)

■ Connection Configuration

- 1:1 Connection



■ IPC COM Port

When connecting IPC with an External Device, the COM port used depends on the series and SIO type. Please refer to the IPC manual for details.

Usable port

Series	Usable Port		
	RS-232C	RS-422/485(4 wire)	RS-422/485(2 wire)
PS-2000B	COM1 ^{*1} , COM2, COM3 ^{*1} , COM4	-	-
PS-3450A, PS-3451A, PS3000-BA, PS3001-BD	COM1, COM2 ^{*1*2}	COM2 ^{*1*2}	COM2 ^{*1*2}
PS-3650A (T41 model), PS-3651A (T41 model)	COM1 ^{*1}	-	-
PS-3650A (T42 model), PS-3651A (T42 model)	COM1 ^{*1*2} , COM2	COM1 ^{*1*2}	COM1 ^{*1*2}
PS-3700A (Pentium®4-M) PS-3710A	COM1 ^{*1} , COM2 ^{*1} , COM3 ^{*2} , COM4	COM3 ^{*2}	COM3 ^{*2}
PS-3711A	COM1 ^{*1} , COM2 ^{*2}	COM2 ^{*2}	COM2 ^{*2}
PS4000 ^{*3}	COM1, COM2	-	-
PL3000	COM1 ^{*1*2} , COM2 ^{*1} , COM3, COM4	COM1 ^{*1*2}	COM1 ^{*1*2}
PE-4000B Atom N270	COM1, COM2	-	-
PE-4000B Atom N2600	COM1, COM2	COM3 ^{*4} , COM4 ^{*4} , COM5 ^{*4} , COM6 ^{*4}	COM3 ^{*4} , COM4 ^{*4} , COM5 ^{*4} , COM6 ^{*4}
PS5000 (Slim Panel Type Core i3 Model) ^{*5*6}	COM1, COM2 ^{*4}	COM2 ^{*4}	COM2 ^{*4}
PS5000 (Slim Panel Type Atom Model) ^{*5*6}	COM1, COM2 ^{*7}	COM2 ^{*7}	COM2 ^{*7}
PS5000 (Enclosed Panel Type) ^{*8}	COM1	-	-
PS5000 (Modular Type PFXPU/PFXPP) ^{*5*6} PS5000 (Modular Type PFXPL2B5-6)	COM1 ^{*7}	COM1 ^{*7}	COM1 ^{*7}
PS5000 (Modular Type PFXPL2B1-4)	COM1, COM2 ^{*7}	COM2 ^{*7}	COM2 ^{*7}
PS6000 (Advanced Box) PS6000 (Standard Box)	COM1 ^{*9}	*10	*10
PS6000 (Basic Box)	COM1 ^{*9}	COM1 ^{*9}	COM1 ^{*9}

*1 The RI/5V can be switched. Use the IPC's switch to change if necessary.

*2 Set up the SIO type with the DIP Switch. Please set up as follows according to SIO type to be used.

- *3 When making communication between an External Device and COM port on the Expansion slot, only RS-232C is supported. However, ER (DTR/CTS) control cannot be executed because of the specification of COM port.
For connection with External Device, use user-created cables and disable Pin Nos. 1, 4, 6 and 9. Please refer to the IPC manual for details of pin layout.
- *4 Set up the SIO type with the BIOS. Please refer to the IPC manual for details of BIOS.
- *5 When setting up communication between an External Device and the RS-232C/422/485 interface module, use the IPC (RS-232C) or PS5000 (RS-422/485) cable diagrams. However, when using PFXZPBMPR42P2 in a RS-422/485 (4-wire) configuration with no flow control, connect 7.RTS+ and 8.CTS+, and connect 6.RTS- and 9.CTS-.
When using RS-422/485 communication with External Devices, you may need to reduce the transmission speed and increase the TX Wait time.
- *6 To use RS-422/485 communication on the RS-232C/422/485 interface module, the DIP Switch setting is required. Please refer to "Knowledge Base" (FAQs) on the support site. (<http://www.pro-face.com/trans/en/manual/1001.html>)

Settings	FAQ ID
PFXZPBMPR42P2, RS422/485 change method	FA263858
PFXZPBMPR42P2 termination resistor setting	FA263974
PFXZPBMPR44P2, RS422/485 change method	FA264087
PFXZPBMPR44P2 termination resistor setting	FA264088

- *7 Set up the SIO type with the DIP Switch. Please refer to the IPC manual for details of DIP Switch. The BOX Atom has not a switch to set the RS-232C, RS-422/485 mode. Use the BIOS for the setting.
- *8 For the connection with the External Device, on the user-created cable read as if the connector on the Display-side is a M12 A-coding 8 pin socket. The pin assignment is the same as described in the cable diagram. For the M12 A-coding connector, use PFXZPSCNM122.
- *9 In addition to COM1, you can also use the COM port on the optional interface.
- *10 Install the optional interface in the expansion slot.

DIP Switch settings (PL3000 / PS3000 Series)

RS-232C

DIP Switch	Setting	Description
1	OFF*1	Reserved (always OFF)
2	OFF	SIO type: RS-232C
3	OFF	
4	OFF	Output mode of SD (TXD) data: Always output
5	OFF	Terminal resistance (220Ω) insertion to SD (TXD): None
6	OFF	Terminal resistance (220Ω) insertion to RD (RXD): None
7	OFF	Short-circuit of SDA (TXA) and RDA (RXA): Not available
8	OFF	Short-circuit of SDB (TXB) and RDB (RXB): Not available
9	OFF	RS (RTS) Auto control mode: Disabled
10	OFF	

*1 When using PS-3450A, PS-3451A, PS3000-BA and PS3001-BD, turn ON the set value.

RS-422/485 (4 wire)

DIP Switch	Setting	Description
1	OFF	Reserved (always OFF)
2	ON	SIO type: RS-422/485
3	ON	
4	OFF	Output mode of SD (TXD) data: Always output
5	OFF	Terminal resistance (220Ω) insertion to SD (TXD): None
6	OFF	Terminal resistance (220Ω) insertion to RD (RXD): None
7	OFF	Short-circuit of SDA (TXA) and RDA (RXA): Not available
8	OFF	Short-circuit of SDB (TXB) and RDB (RXB): Not available
9	OFF	RS (RTS) Auto control mode: Disabled
10	OFF	

RS-422/485 (2 wire)

DIP Switch	Setting	Description
1	OFF	Reserved (always OFF)
2	ON	SIO type: RS-422/485
3	ON	
4	OFF	Output mode of SD (TXD) data: Always output
5	OFF	Terminal resistance (220Ω) insertion to SD (TXD): None
6	OFF	Terminal resistance (220Ω) insertion to RD (RXD): None
7	ON	Short-circuit of SDA (TXA) and RDA (RXA): Available
8	ON	Short-circuit of SDB (TXB) and RDB (RXB): Available
9	ON	RS (RTS) Auto control mode: Enabled
10	ON	

2 External Device Selection

Select the External Device to be connected to the Display.

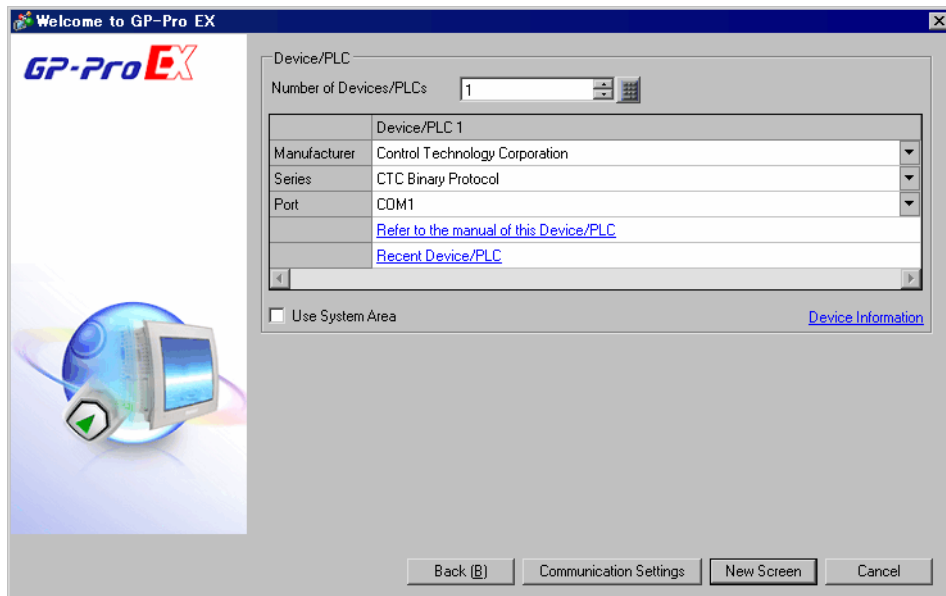

Setup Items	Setup Description
Number of Devices/PLCs	Enter an integer from 1 to 4 to define the number of Devices/PLCs to connect to the display.
Manufacturer	Select the manufacturer of the External Device to connect. Select "Control Technology Corporation".
Series	Select the External Device model (series) and the connection method. Select "CTC Binary Protocol". In System configuration, make sure the External Device you are connecting is supported by "CTC Binary Protocol". ☞ "1 System Configuration" (page 3)
Port	Select the Display port to be connected to the External Device.
Use System Area	Check this option to synchronize the system data area of the Display and the device (memory) of the External Device. When synchronized, you can use the External Device's ladder program to switch the display or display the window on the Display. Cf. GP-Pro EX Reference Manual "LS Area (Direct Access Method Area)" This feature can also be set in GP-Pro EX or in the Display's offline mode. Cf. GP-Pro EX Reference Manual "System Settings [Display Unit] - [System Area] Settings Guide" Cf. Maintenance/Troubleshooting Guide "Main Unit - System Area Settings"

3 Communication Settings

This section provides examples of communication settings recommended by Pro-face for the Display and the External Device.

3.1 Setting Example 1

■ GP-Pro EX Settings

◆ Communication Settings

To display the setup screen, from the [Project] menu, point to [System Settings] and select [Device/PLC].

Device/PLC 1

Summary [Change Device/PLC](#)

Manufacturer Series Port

Text Data Mode [Change](#)

Communication Settings

RS232C
 RS422/485(2wire)
 RS422/485(4wire)

Speed

Data Length 7 8

Parity NONE EVEN ODD

Stop Bit 1 2

Flow Control NONE ER(DTR/CTS) XON/XOFF

Timeout (sec)

Retry

Wait To Send (ms)

RI / VCC
 VCC

In the case of RS232C, you can select the 9th pin to RI (Input) or VCC (5V Power Supply). If you use the Digital's RS232C Isolation Unit, please select it to VCC.

Device-Specific Settings

Allowable Number of Devices/PLCs [Add Device](#)

No.	Device Name	Settings
<input type="button" value="↓"/> 1	<input type="text" value="PLC1"/>	<input type="text"/>

[Add Indirect Device](#)

◆ Device Setting

The External Device does not require communication settings.

■ External Device Settings

Use the ladder software (CTC Monitor) for communication settings. Refer to your External Device manual for details.

- 1 Turn ON the power of the External Device.
- 2 Start up the ladder tool.
- 3 Click [Registers] to display the [Registers] dialog box.
- 4 Set the desired Register Number as follows:

Register Number	Setting	Setup Description
R12301	05	Baud rate selection
R12310	00	Data Configuration for On-board COMM Port

- 5 Click [Connected to COMM1 Baud].

NOTE

- When turning on the power again, the communication settings will be initialized. Configure the communication settings again.
-

3.2 Setting Example 2

■ GP-Pro EX Settings

◆ Communication Settings

To display the setup screen, from the [Project] menu, point to [System Settings] and select [Device/PLC].

Device/PLC 1

Summary [Change Device/PLC](#)

Manufacturer Series Port

Text Data Mode [Change](#)

Communication Settings

SID Type RS232C RS422/485(2wire) RS422/485(4wire)

Speed

Data Length 7 8

Parity NONE EVEN ODD

Stop Bit 1 2

Flow Control NONE ER(DTR/CTS) XON/XOFF

Timeout (sec)

Retry

Wait To Send (ms)

RI / VCC RI VCC

In the case of RS232C, you can select the 9th pin to RI (Input) or VCC (5V Power Supply). If you use the Digital's RS232C Isolation Unit, please select it to VCC.

Device-Specific Settings

Allowable Number of Devices/PLCs [Add Device](#)

No.	Device Name	Settings
<input type="button" value="1"/>	<input type="text" value="PLC1"/>	<input type="text"/>

[Add Indirect Device](#)

◆ Device Setting

The External Device does not require communication settings.

■ External Device Settings

Use the ladder software (CTC Monitor) for communication settings. Refer to your External Device manual for details.

- 1 Turn ON the power of the External Device.
- 2 Start up the ladder tool.
- 3 Click [Registers] to display the [Registers] dialog box.
- 4 Set the desired Register Number as follows:

Register Number	Setting	Setup Description
R20010	05	Baud rate selection
R20011	08	Data length setting
R20012	20048	Parity selection

- 5 Click [Connected to COMM1 Baud].

NOTE

- When turning on the power again, the communication settings will be initialized. Configure the communication settings again.
-

4 Setup Items

Set up the Display's communication settings in GP-Pro EX or in the Display's offline mode.

The setting of each parameter must match that of the External Device.

 "3 Communication Settings" (page 8)

4.1 Setup Items in GP-Pro EX

■ Communication Settings

To display the setup screen, from the [Project] menu, point to [System Settings] and select [Device/PLC].

Setup Items	Setup Description
SIO Type	Select the SIO type to communicate with the External Device. IMPORTANT <ul style="list-style-type: none"> In the communication settings, set [SIO Type] correctly according to the serial interface specifications of the Display. If you select an SIO type that the serial interface does not support, proper operation cannot be guaranteed. Refer to your Display manual for details on the serial interface specifications.
Speed	Select communication speed between the External Device and the Display.
Data Length	Select data length.
Parity	Select how to check parity.
Stop Bit	Select the stop bit length.
Flow Control	Select the communication control method to prevent overflow of transmission and reception data.

Setup Items	Setup Description
Timeout	Use an integer from 1 to 127 to enter the time (s) for which the Display waits for the response from the External Device.
Retry	In case of no response from the External Device, use an integer from 0 to 255 to enter how many times the Display retransmits the command.
Wait To Send	Use an integer from 0 to 255 to enter standby time (ms) for the Display from receiving packets to transmitting next commands.
RI/VCC	You can switch RI / VCC of the 9th pin when you select RS-232C for SIO type. It is necessary to change RI / 5V by changeover switch of IPC when connect with IPC. Please refer to the manual of the IPC for more details.

NOTE

- Refer to the GP-Pro EX Reference Manual for Indirect Device.

Cf. GP-Pro EX Reference Manual "Changing the Device/PLC at Runtime (Indirect Device)"

4.2 Setup Items in Offline Mode

NOTE

- Refer to the Maintenance/Troubleshooting guide for information on how to enter offline mode and how to operate offline mode.
Cf. Maintenance/Troubleshooting Guide "Offline Mode"
- The number of the setup items to be displayed for 1 page in the offline mode depends on the Display in use. Please refer to the Reference manual for details.

■ Communication Settings

To display the setting screen, touch [Device/PLC Settings] from [Peripheral Equipment Settings] in offline mode. Touch the External Device you want to set from the displayed list.

Comm.	Option			
CTC Binary Protocol		[COM1]	Page 1/1	
SIO Type	RS232C			
Speed	9600			
Data Length	8			
Parity	<input checked="" type="radio"/> NONE <input type="radio"/> EVEN <input type="radio"/> ODD			
Stop Bit	<input checked="" type="radio"/> 1 <input type="radio"/> 2			
Flow Control	NONE			
Timeout(s)	3			
Retry	2			
Wait To Send(ms)	0			
Exit		Back		2008/11/08 18:26:59

Setup Items	Setup Description
SIO Type	Select the SIO type to communicate with the External Device. IMPORTANT <ul style="list-style-type: none"> In the communication settings, set [SIO Type] correctly according to the serial interface specifications of the Display. If you select an SIO type that the serial interface does not support, proper operation cannot be guaranteed. Refer to your Display manual for details on the serial interface specifications.
Speed	Select the communication speed between the External Device and the Display.
Data Length	Displays data length.
Parity	Select how to check parity.
Stop Bit	Select stop bit length.
Flow Control	Select the communication control method to prevent overflow of transmission and reception data.
Timeout	Use an integer from 1 to 127 to enter the time (s) for which the Display waits for the response from the External Device.

Setup Items	Setup Description
Retry	In case of no response from the External Device, use an integer from 0 to 255 to enter how many times the Display retransmits the command.
Wait To Send	Use an integer from 0 to 255 to enter standby time (ms) for the Display from receiving packets to transmitting next commands.

■ Option Settings

To display the setting screen, touch [Device/PLC Settings] from [Peripheral Equipment Settings]. Touch the External Device you want to set from the displayed list, and touch [Option].

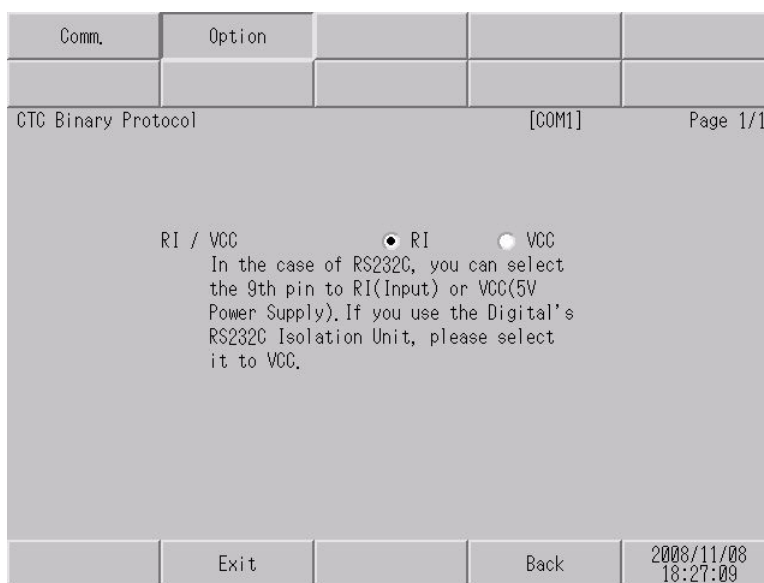

Setup Items	Setup Description
RI/VCC	You can switch RI / VCC of the 9th pin when you select RS-232C for SIO type. It is necessary to change RI / 5V by changeover switch of IPC when connect with IPC. Please refer to the manual of the IPC for more details.

NOTE

- GP-4100 series, GP-4*01TM and GP-Rear Module do not have the [Option] setting in the offline mode.

5 Cable Diagrams

The following cable diagrams may be different from cable diagrams recommended by Control Technology Corporation. Please be assured there is no operational problem in applying the cable diagrams shown in this manual.

- The FG pin of the External Device body must be D-class grounded. Refer to your External Device manual for details.
- The SG and FG are connected inside the Display. When connecting the External Device to the SG, design your system to avoid short-circuit loops.
- Connect an isolation unit if the communication is not stable due to noise or other factors.

Cable Diagram 1

Display (Connection Port)	Cable		Remarks
GP3000 (COM1) GP4000* ¹ (COM1) SP5000* ² (COM1/2) SP-5B00 (COM1) ST3000 (COM1) ST6000 (COM1) STM6000 (COM1) STC6000 (COM1) ET6000 (COM1) LT3000 (COM1) IPC* ³ PC/AT	1A	D-Connector to Modular Jack Adapter Model:2880B + Communications Cables Model:2881/2882/2883	Cable length: 8m or less
	1B	User-created cable	
GP-4105 (COM1) GP-4115T (COM1) GP-4115T3 (COM1)	1C	User-created cable	Cable length: 8m or less

*1 All GP4000 models except GP-4100 Series and GP-4203T

*2 Except SP-5B00

*3 Only the COM port which can communicate by RS-232C can be used.

☞ ■ IPC COM Port (page 4)

1A)

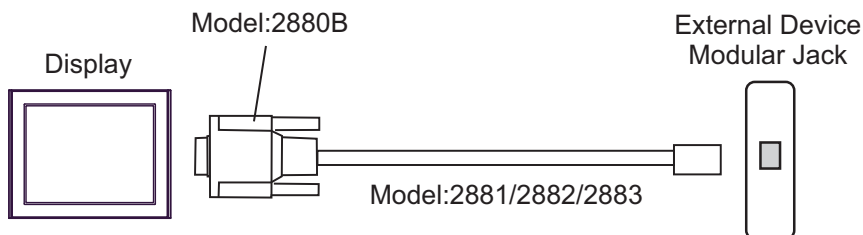

1B)

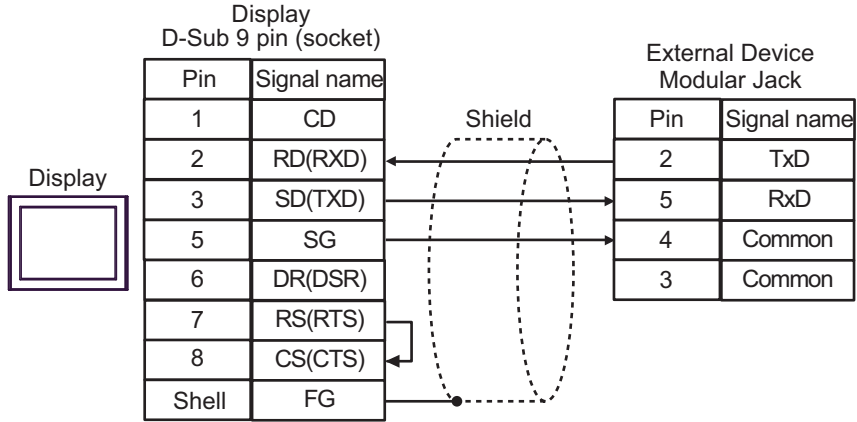



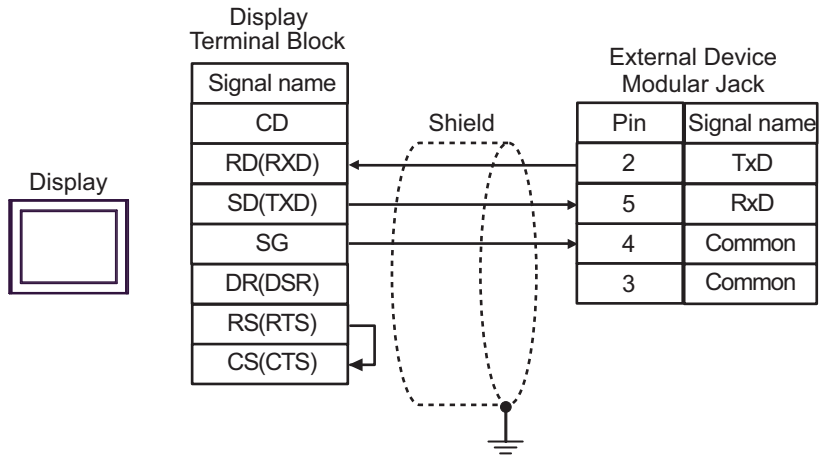



1C)

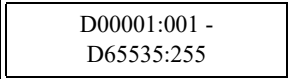

6 Supported Devices

The following table shows the range of supported device addresses. Please note that the actual supported range of the devices varies depending on the External Device to be used. Please check the actual range in the manual of your External Device.

 : This address can be specified as system data area.

Device	Bit Address	Word address	32 bits	Remarks
Numeric Register	----	R00001 - R65535		 *1
Flag	F01 - F32	----		
Input	IN0001 - IN1024	----		*2
Output	OUT0001 - OUT1024	----		*3
Analog Input	----	AIN001 - AIN256		*2
Analog Output	----	AOUT001 - AOUT256		
Data Table	----	 D00001:001 - D65535:255		 *4
Char Display	----	CD00001:001 - CD65535:253		 *5

*1 32-bit device

*2 Write disabled.

*3 Only addresses from OUT001 to OUT128 are enabled to write.

*4 Device address specification:

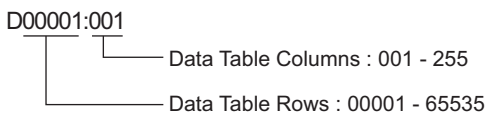

*5 Only odd addresses can be used.

Device address specification:

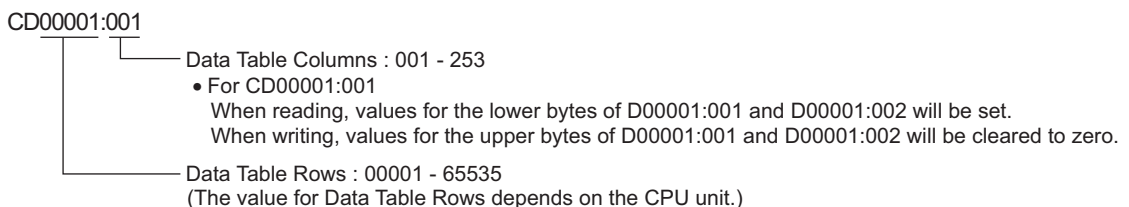

NOTE

- Please refer to the GP-Pro EX Reference Manual for system data area.

Cf. GP-Pro EX Reference Manual "LS Area (Direct Access Method Area)"

- Refer to the precautions on manual notation for icons in the table.

 "Manual Symbols and Terminology"

7 Device Code and Address Code

Use device code and address code when you set "Device Type & Address" for the address type of the data display or other devices.

Device	Device Name	Device Code (HEX)	Address Code
Numeric Register	R	0000	Value of (word address - 1)
Data Table	D	0001	Value of (word address - 1) ^{*1}
Char Display	CD	0002	Value of (word address - 1) divided by 2
Analog Input	AIN	0060	Value of (word address - 1)
Analog Output	AOUT	0061	Value of (word address - 1)

*1 Device address specification:

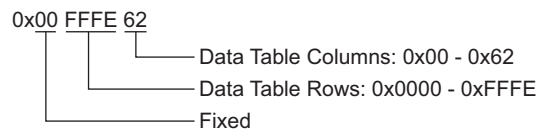

8 Error Messages

Error messages are displayed on the Display screen as follows: "No.:Device Name:Error Message(Error Occurrence Area)". Each description is shown below.

Item	Description
No.	Error No.
Device Name	Name of the External Device where an error has occurred. Device/PLC name is the title of the External Device set with GP-Pro EX.(Initial value[PLC1])
Error Message	Displays messages related to an error that has occurred.
Error Occurrence Area	Displays the IP address or device address of the External Device where error has occurred, or error codes received from the External Device. <div style="border: 1px solid black; padding: 2px; margin-top: 5px;"> NOTE <ul style="list-style-type: none"> IP address is displayed as "IP address (Decimal): MAC address (Hex)". Device address is displayed as "Address: Device address". Received error codes are displayed as "Decimal [Hex]". </div>

Examples of Error Messages

"RHAA035: PLC1: Error has been responded for device write command (Error Code: 2[02H])"

NOTE

- Refer to "Display-related errors" in "Maintenance/Troubleshooting Guide" for details on the error messages common to the driver.

■ Error Messages Unique to the External Device

Error No.	Error Message	Description
RHxx128	(Node Name):The Output Device can't be modified (Address:(Device Address))	When you try to change the addresses OUT129 to OUT1024 of the Output device, an error will be displayed.
RHxx129	(Node Name): The Input data is out of range (Address: (Device Address))	When you try to enter the value which exceeds the available setting range in the Analog Output device (0 - 10000), an error will be displayed.
RHxx130	(Node Name): The Input device can not be accessed (Address: (Device Address))	When you try to access a nonexistent Analog Input or Analog Output device, an error will be displayed.