



## WARNING

- When connecting the power cord terminals to the GP, be sure the cord has first been unplugged from the power outlet to prevent the possibility of an electric shock.
- With the exception of changing the GP's backlight, do NOT open the GP's case, since high voltage runs through the GP and touching an internal part can lead to an electric shock.
- Do not use power beyond the GP's specified voltage range. Doing so may cause a fire or an electric shock.
- Do not modify the GP's design, since it may lead to a fire or an electric shock.
- Do not use the GP in an environment where flammable gases are present, since operating the GP may cause an explosion.
- The GP uses a lithium battery for backing up its internal clock data. If the battery is incorrectly replaced (i.e. its + and — sides are reversed), the battery may explode. When changing the battery, please contact your local GP distributor.
- Do not use GP touch panel switches in life-related or important disaster prevention situations. For safety related switches, such as an emergency switch, be sure to use a separate mechanical switch.
- To prevent operator injury or machine damage, be sure to design your machine operation system so that the machine will not malfunction due to a communication fault between the GP and its host controller.



## Caution

- *Do not strike the GP's touch panel with a hard or heavy object, or press on the touch panel too strongly since it may damage the display.*
- *Do not install the GP where the temperature will exceed its specified range.*
- *Be sure that water, liquids or metal particles do not enter the GP, since it may cause a malfunction or a short circuit.*
- *Avoid installing the GP where sudden, large changes in temperature may occur. These changes may cause condensation to form inside the unit, possibly causing a malfunction.*
- *To prevent excessive heat from building up inside the GP, do not install it where its ventilation holes may be blocked.*
- *Do not install or store the GP :*
  - *Where direct sunlight or high levels of dust exist.*
  - *Where either strong shocks or excessive vibration may occur.*
  - *In an area containing chemicals or chemical fumes.*
  - *Near high temperature equipment.*
- *Do not use paint thinner or organic solvents to clean the GP's case or screen.*
- *Due to the danger of unforeseeable accidents, be sure to back up all data regularly.*
- *After turning the GP OFF, be sure to wait a few seconds before turning it ON again. If the GP is re-started too quickly, it may not start up correctly.*

# Package Contents

The following items are included in the GP's package. Before using the GP, please confirm that all items shown here are present.

## ■ GP Unit (1)

(GP377-SC11-24V,  
GP377-LG11-24V)

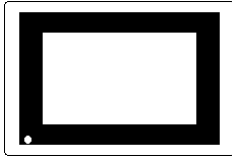

## ■ Installation guide(1)

**<This Guide>**

(GP377-SC11-24V,  
GP377-LG11-24V)

Installation  
Guide

## ■ Installation fasteners (4)

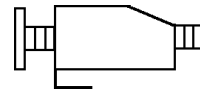

This unit has been carefully packed, with special attention to quality. However, should you find anything damaged or missing, please contact your local GP distributor immediately.

# GP Options (Made by Digital)

## ■ GP-377 Series

**User's Manual \*1**

(Sold Separately)

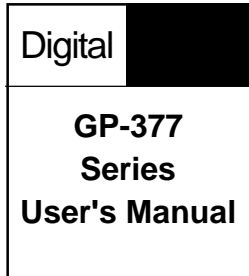

GP377-SC11-24V  
GP377-LG11-24V  
(English/Japanese)

## ■ Cables

## ■ Adapters

## ■ Screen editor software, etc.

For more information on these items,  
please refer to Digital's GP catalogues.

\*1 Please refer to this manual for detailed GP information.

# 1 GP-377 Parts Names and Functions

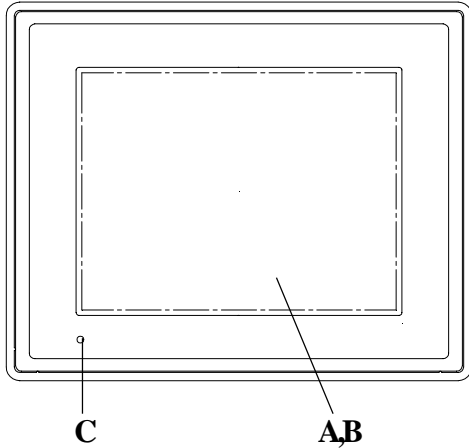

## A: Display

Displays User-created screens and host (PLC) data.

GP377-SC11-24V : Color LCD

GP377-LG11-24V : Monochrome LCD

## B: Touch Panel

Performs screen change operations and sends data to the host (PLC).

## C: Status LED

LED	GP Status
Not Lit	Power cord is not connected.
Green	Normal operation
Orange	Backlight is not functioning (Refer to Section 9. Changing the Backlight)

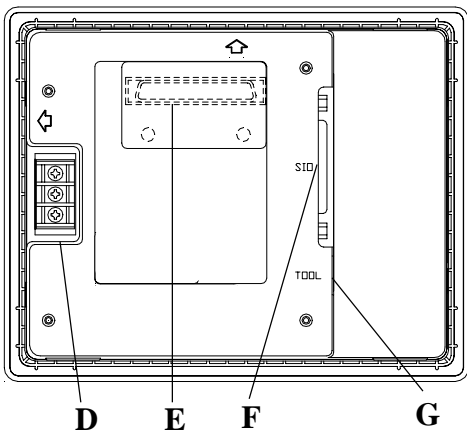

## D: Power Input Terminal Block

Connects the GP power cable's input and ground wires to the GP.

## E: Expansion Unit Interface

Connects an optional GP Expansion Unit to the GP.  
(Inside cover)

## F: Serial Interface

Connects an RS-232C or RS-422 (Serial) cable (from the host/PLC) to the GP.

## G: Tool Connector

Connects the Data Transfer Cable, Bar Code Reader, Memory Loader or other equipment to the GP.

# 2 GP-377 External Dimensions

Unit:mm

Top View

155.5

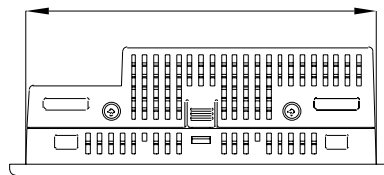

Rear View

Front View

Side View

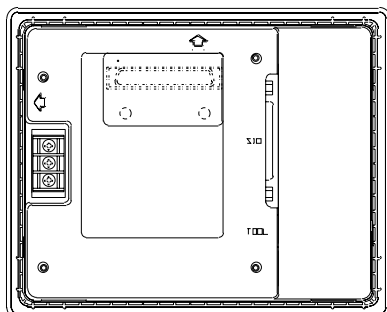

171

138

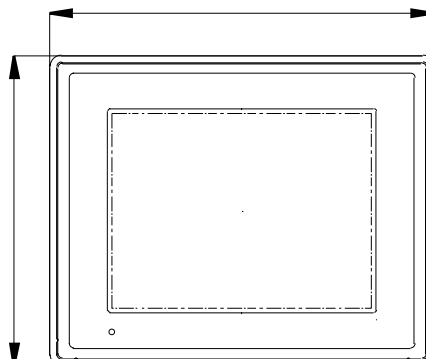

57

5

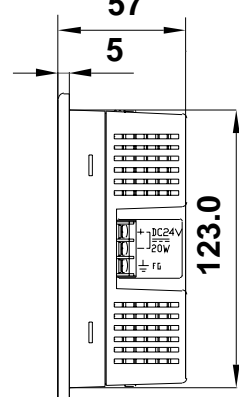

### 3 Serial Interface

This interface is for connecting the GP to the host (PLC), via either an RS-232C or RS-422 cable.

	Pin #	Signal Name	Meaning
	1	FG	Frame Ground
	2	SD	Send Data (RS-232C)
	3	RD	Receive Data (RS-232C)
	4	RS	Request to Send (RS-232C)
	5	CS	Clear to Send (RS-232C)
	6	NC	No Connection
	7	SG	Signal Ground
	8	CD	Carrier Detect (RS-232C)
	9	TRMX	Termination (RS-422)
	10	RDA	Receive Data A (RS-422)
	11	SDA	Send Data A (RS-422)
	12 <sup>*1</sup>	RESERVED	RESERVED
	13 <sup>*1</sup>	RESERVED	RESERVED
	14	VCC	5V Output 0.25A
	15	SDB	Send Data B (RS-422)
	16	RDB	Receive Data B (RS-422)
	17	NC	No Connection
	18	CSB	Clear to Send B (RS-422)
	19	ERB	Enable Receive B (RS-422)
	20	ER	Enable Receive (RS-232C)
	21	CSA	Clear to Send A (RS-422)
	22	ERA	Enable Receive A (RS-422)
	23	BUZZ GND	External Buzzer Ground
	24	NC	No Connection
	25	BUZZ OUT	External Buzzer Output

\*1 Pins Number 12 and 13 are reserved and should not be connected to anything.

Recommended Connector: Dsub 25 pin (male) XM2A-2501 <made by OMRON Corp.>

Recommended Cover: Dsub 25 pin XM2S-2511 <made by OMRON Corp.>

Jack Screws XM2Z-0071 <made by OMRON Corp.>



**Use rough metric type M2.6 x 0.45p threads to hold the cable's set (fastening) screws in place.**

Recommended Cable: CO-MA-VV-SB5P x 28AWG <made by HITACHI Cable>



- **Since pin #14 (VCC) is not protected, be sure to use it only within its rated range.**
- **Be sure to connect pin #7 (SG) to the other unit's Signal Ground terminal.**



**When making a cable, please be aware of the following:**

**<For RS-232C Connectors>**

- **Do not connect #9 (TRMX), #10 (RDA), #11 (SDA), #15 (SDB), #16 (RDB), #18(CSB), #19 (ERB), #21 (CSA), and #22 (ERA).**

**<For RS-422 Connectors>**

- **The following pairs of pin numbers' must be connected (shorted):**  
#18 (CSB) <-> #19 (ERB)  
#21 (CSA) <-> #22 (ERA)
- **Connecting the #9 (TRMX) and #10 (RDA) wires adds a termination resistance of 100W between RDA and RDB.**
- **Use a 4-wire cable when the PLC type is Memory Link and the cable is RS-422.**

**<External Buzzer Output>**

**Use pins 23(BUZZ GND) and 25(BUZZ OUT) when producing external output for an alarm.**

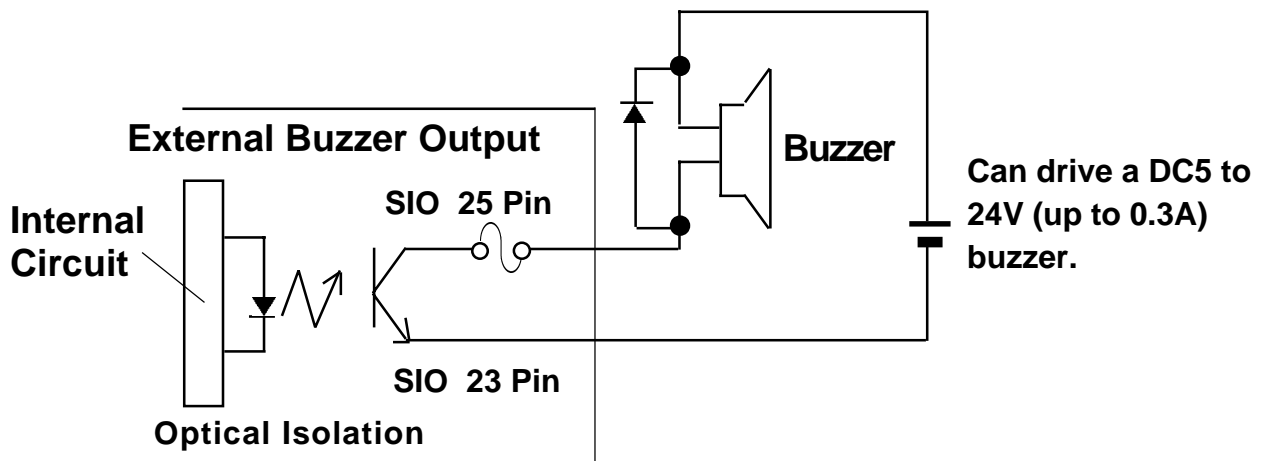

**GP-377 Unit**

## 4 Installation

### ■ Confirm the Installation Gasket's Seating

It is strongly recommended that you use the gasket.

Place the GP on a level surface with the display panel facing downward. Check that the GP's installation gasket is seated securely into the gasket's groove, which runs around the perimeter of the panel's frame.



**Before installing the GP into a cabinet or panel, check that the Installation gasket is securely attached to the unit.**

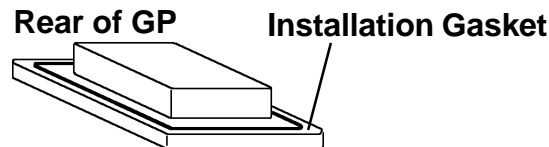

### ■ Cut a hole in the metal panel according to the dimensions given below.

Insert the GP into the panel from the front of the panel.

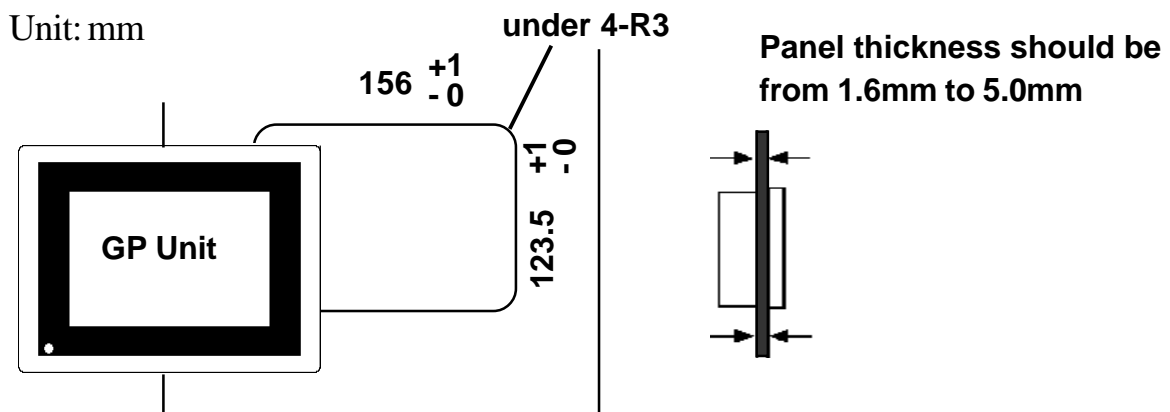

### ■ Attach the GP's Installation Fasteners from inside the panel.

Tighten the installation fasteners with a standard screwdriver.

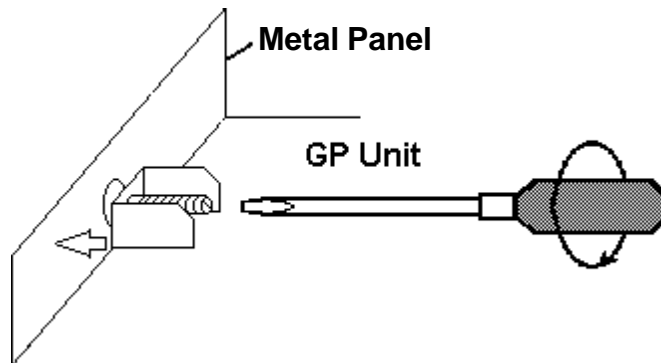

**Tightening the fastener screws with too much force can damage the GP's case. The torque necessary to ensure a waterproof seal is 0.5 to 0.6N•m.**

## 5 Wiring

### WARNING

- To prevent an electric shock, be sure the GP's Power Cord is unplugged from the power outlet prior to connecting the cord's terminals to the GP.
- The GP377Series are designed to use only DC24V input. Any other power level can damage both the GP and the power supply.
- Be sure to reattach the GP Power Terminal's clear plastic cover after connecting the Power Cord's power terminals.



- *When connecting a wire to the GP's FG terminal, be sure the wire is grounded. Not grounding the wire will result in excessive noise.*
- *To avoid a short caused by loose ring terminals, be sure to use ring terminals with an insulating sleeve.*



- Wherever possible, use thick wires (max. 2 mm<sup>2</sup>) for power terminals, and twist the wire ends before attaching the ring terminals.
- Be sure to use the following size ring terminals.\*<sup>1</sup>

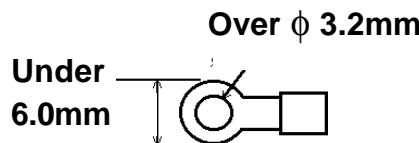

- Since the GP has no power switch, install a breaker-type switch.

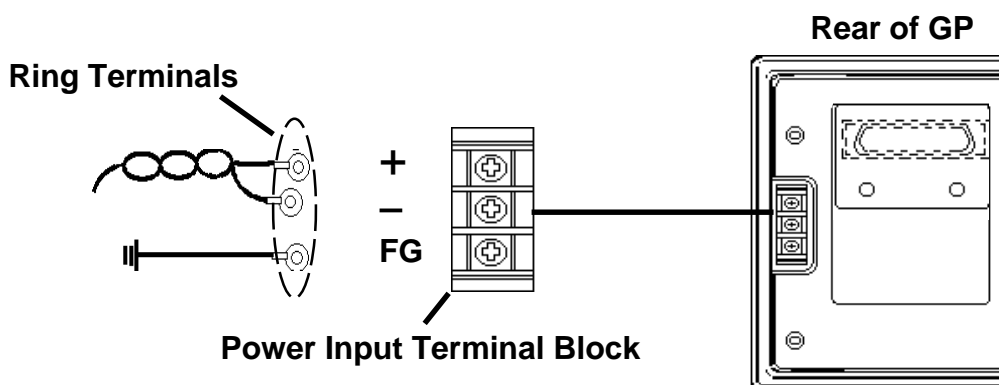

### ■ Connecting the GP's Power Cord

When connecting the power cord, be sure to follow the procedures given below.

1. Confirm that the GP's Power Cord is unplugged from the power supply.
2. Use a screwdriver to remove the Power Input Terminal Block's clear plastic cover.
3. Connect the power terminals and check that the wires are connected correctly.
4. Replace the Power Input Terminal Block's clear plastic cover.



*The torque required for fastening the screws is 0.5 to 0.6N•m.*

\*<sup>1</sup> Suggested Ring Terminal: V2-MS3 (made by JST Co.)

---

## 6 Power Supply Precautions

Be aware of the following items when attaching the power cord terminals to the GP's power terminal block.

- When operating the GP where large power fluctuations will occur, install a constant voltage transformer.
- To reduce wire-to-wire or wire-to-earth noise as much possible, use a low-noise power supply. If noise is excessive, use a Noise Reducing Transformer.
- Be sure to separate all GP power, I/O unit and Operation unit lines.
- To increase the noise resistance of the power cord's wires, twist each end before attaching the Ring Terminal.
- Do not bundle or position the GP's power cord near main circuit lines (high voltage, strong current), or I/O signal lines.
- To prevent damage from lightning, be sure to install a lightning surge absorber
- To minimize line noise, make the GP's power cord as short as possible.

---

## 7 Grounding Precautions

- When attaching a wire to the GP's rear face FG terminal, (on the Power Input Terminal Block), be sure to create an exclusive ground.\*<sup>1</sup>

---

## 8 I/O (Input/Output) Signal Line Precautions

- All GP Input and Output signal lines must be separated from all operating circuit (power) cables.
- If this is not possible, use a shielded cable and ground the shield.

---

\*<sup>1</sup> Use a grounding resistance of 100Ω, a wire of 2mm<sup>2</sup> or thicker, or your country's applicable standard.



## 9 Changing the Backlight



### WARNING

- Be sure the GP's power Cord is unplugged from the power outlet prior to changing the Backlight.
- Do not touch any of the GP's internal parts while the unit is still ON, since high voltage runs through the Backlight area.
- When the power has just been turned OFF, the unit and Backlight are still very hot. Be sure to use gloves to prevent burns.

When the unit's backlight burns out, the unit's status LED will turn orange. If the "USE TOUCHPANEL AFTER BACKLIGHT BURNSOUT" feature is set to "NO", the GP's touch panel will be disabled. \*1



**Note:** Check you have the proper backlight for the GP-377 Series.

GP	Backlight Model
GP377-SC11-24V	GP377L/S-BL00-MS
GP377-LG11-24V	

Change the Backlight following the steps below. Be sure to use gloves.

(A)

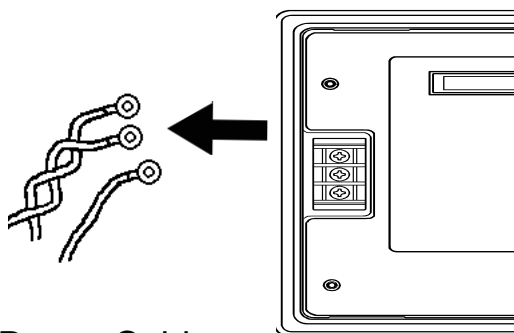

Power Cable

- 1) Disconnect the GP's Power Cord from the power supply.
- 2) Remove the power cord terminals from the GP. (See figure A)

(B)

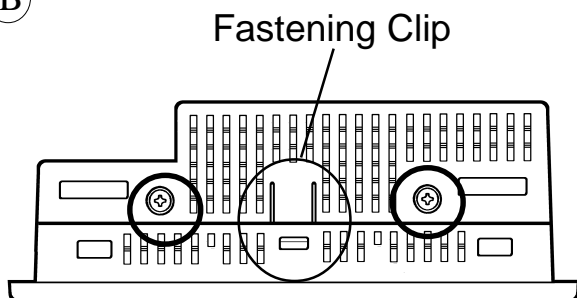

- 3) Use a screwdriver to unscrew the two screws attached on the unit's top face. Keep pushing the Fastening Clip and open the top face. Be sure the clip-tab does not get caught. (See figure B)

\*1 If "NO" has been selected for the OFFLINE menu's "FORCE RESET" feature, Touch-Panel operation is disabled.

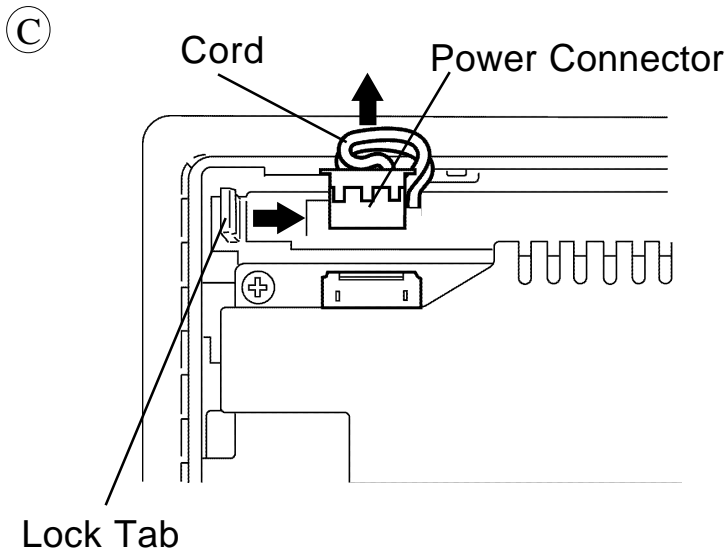

- 4) Disconnect backlight power connector on the upper side of the GP's front panel. Do not pull the cord. (See figure C)
- 5) Push the Lock Tab to the right and pull it upward, and then remove the backlight. (See figure C)
- 6) Insert the new Backlight into the slot from the opposite side of the Lock Tab, then Lock Tab side.
- 7) Reattach the Power Connector to the GP.

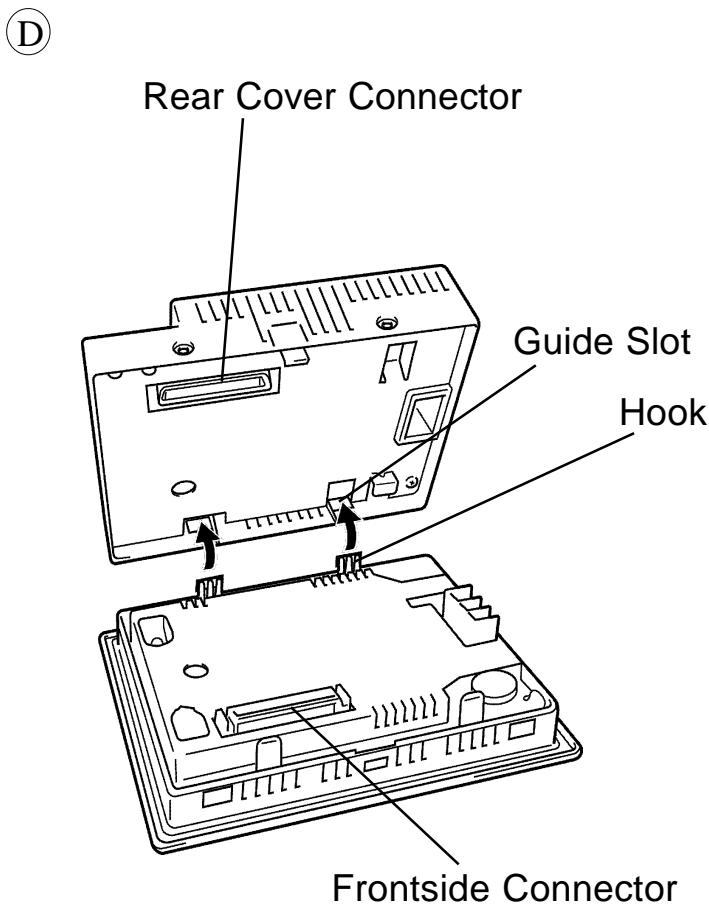

- 8) To replace the rear cover, insert the cover's guide tabs into the case's guide slots and close the cover. Be sure that the Rear Cover Connector and the Front Cover Connector are connected properly. (See figure D)