

# Preface

Thank you for purchasing Digital's Pro-face GP-370 Series of Graphic Control Panels (hereafter referred to as the *GP unit*).

This GP unit, with its higher user functions and better overall performance, has been upgraded from the GP-250 Series.

Please read this manual carefully as it explains, step by step, how to use the GP functions correctly.

In its examples, this manual uses the Mitsubishi MELSEC-AnA Series of PLC's wherever possible, connected in a one-to-one relationship with the GP.

GP-370 Series refers to the following GP model numbers:

GP-370 Series.....GP370-LG11-24V, GP370-SC11-24V(Standard item)

GP370-LG41-24VP, GP370-SC41-24VP(CE marked item/c-UL maked item)

## <Note>

- 1) It is forbidden to copy the contents of this manual, in whole or in part, except for the user's personal use, without expressed permission from Digital Electronics Corporation of Japan
- 2) The information provided in this manual is subject to change without notice.
- 3) This manual has been written with care and attention to detail; however, should you find any errors or omissions, please contact Digital Electronics and inform them of your findings.
- 4) Please be aware that we are not responsible for any damages resulting from the use of our products, regardless of article 3 above.
- 5) Specifications set out in this manual are for overseas products only, and, as a result, some differences exist between the specs given here and Japanese ones.

The "P" models are products jointly developed with Pro-face HMI B.V. in Europe. The front sheet designs for these models differ from the standard or c-UL recognized models.

Company/Manufacturer names used in this manual are the registered trademarks of their respective companies.

© Copyright March 1996, Digital Electronics Corporation

# Table of Contents

## Preface

|                            |      |
|----------------------------|------|
| Caution .....              | v    |
| UL/c-UL(CSA)Approval ..... | vii  |
| Package Contents .....     | viii |
| Symbols .....              | ix   |

## Chapter 1—Introduction

|                               |     |
|-------------------------------|-----|
| 1.1 Before Operating GP ..... | 1-1 |
| 1.2 System Structure .....    | 1-2 |
| 1.3 Optional Equipment .....  | 1-5 |

## Chapter 2—Specifications

|   |     |
|---|-----|
| 2.1 General Specifications .....          | 2-1 |
| 1. Electrical Specifications .....        | 2-1 |
| 2. Environmental Specifications .....     | 2-2 |
| 3. Structural Specifications .....        | 2-2 |
| 2.2 Function and Performance .....        | 2-3 |
| 1. Display Functions .....                | 2-3 |
| 2. Screen Memory .....                    | 2-4 |
| 3. Touch Panel / Clock Accuracy .....     | 2-4 |
| 4. External Interface .....               | 2-4 |
| 2.3 Interface Specifications .....        | 2-5 |
| 1. Serial Interface .....                 | 2-5 |
| 2.4 Names and Functions of GP Parts ..... | 2-6 |
| 2.5 Graphic Panel Dimensions .....        | 2-7 |
| 1. GP-370 External Dimensions .....       | 2-7 |
| 2. Installation Fasteners .....           | 2-8 |
| 3. GP Installation Dimensions .....       | 2-9 |

## Chapter 3—Installation and Wiring

|  |     |
|--|-----|
| 3.1 Installation .....                         | 3-1 |
| 1. Installation .....                          | 3-1 |
| 3.2 Wiring .....                               | 3-5 |
| 1. Power Cable Connection .....                | 3-5 |
| 2. Precaution: Grounding .....                 | 3-6 |
| 3. Precaution: Input/Output Signal Lines ..... | 3-6 |
| 3.3 Tool Connector .....                       | 3-7 |

## Chapter 4—Off-line Mode

|  |     |
|--|-----|
| 4.1 Entering Off-line Mode .....             | 4-1 |
| 1. When Turning the Unit On .....            | 4-1 |
| 2. Enter From Force Reset .....              | 4-2 |
| 4.2 Main Menu .....                          | 4-3 |
| 4.3 INITIALIZE—Standard Operations .....     | 4-4 |
| 4.4 SELF-DIAGNOSIS—Standard Operations ..... | 4-5 |
| 4.5 Transfer Screen Data .....               | 4-7 |

## Chapter 5—Initialize

|   |      |
|---|------|
| 5.1 Initialize Screen .....                 | 5-1  |
| 5.2 Initialize Items .....                  | 5-2  |
| 5.3 SYSTEM ENVIRONMENT SETUP .....          | 5-3  |
| 1. SYSTEMSETUP .....                        | 5-3  |
| 2. SYSTEMAREA SETUP .....                   | 5-4  |
| 3. GLOBAL WINDOW SETUP .....                | 5-5  |
| 4. CHARACTER STRING DATA SETUP .....        | 5-6  |
| 5.4 SET UP I/O .....                        | 5-9  |
| 1. SET UP SIO .....                         | 5-9  |
| 2. SET UP I/O .....                         | 5-10 |
| 3. COMMUNICATION SETUP .....                | 5-12 |
| 5.5 PLC SETUP .....                         | 5-13 |
| 1. SETUP OPERATION SURROUNDINGS (1:1) ..... | 5-13 |
| 2. SETUP OPERATION SURROUNDINGS (n:1) ..... | 5-14 |
| 3. STATION SETUP (n:1) .....                | 5-15 |
| 4. CUSTOMIZE SETUP .....                    | 5-17 |
| 5.6 INITIALIZE MEMORY .....                 | 5-19 |
| 5.7 SET UP TIME .....                       | 5-19 |
| 5.8 SET UP SCREEN .....                     | 5-20 |
| 5.9 FONT SETTING .....                      | 5-21 |

## Chapter 6—RUN and Errors

|  |     |
|--|-----|
| 6.1 RUN .....                          | 6-1 |
| 1. Powering Up .....                   | 6-1 |
| 2. Off-line Mode .....                 | 6-1 |
| 6.2 Troubleshooting .....              | 6-2 |
| 1. Troubles .....                      | 6-2 |
| 2. No Display .....                    | 6-4 |
| 3. Would Not Communicate .....         | 6-7 |
| 4. The Touch Panel Does Not Work ..... | 6-9 |

|  |      |
|--|------|
| 6.3 SELF-DIAGNOSIS .....                     | 6-10 |
| 1. SELF-DIAGNOSIS Item List .....            | 6-10 |
| 2. SELF-DIAGNOSIS—Details Of Each Item ..... | 6-11 |
| 6.4 Error Message .....                      | 6-14 |
| 1. Error Message List .....                  | 6-14 |
| 2. Error Messages—Details .....              | 6-15 |

## Chapter 7—Maintenance

|                                  |     |
|----------------------------------|-----|
| 7.1 Regular Cleaning .....       | 7-1 |
| 7.2 Periodic Check-Up .....      | 7-2 |
| 7.3 Changing the Backlight ..... | 7-3 |

## Index



## Caution

For safe and correct use of this unit, follow these guidelines.

- Because of the ever present danger of electric shocks, make sure the Power Cable is not plugged in when connecting it up to the GP.
- Whenever changing the Backlight, to prevent electric shocks or burns, be sure to turn off the GP power and use protective gloves.
- Because the GP is loaded with high voltage parts, electric shocks can occur when disassembling the unit. *Do not disassemble the GP.*
- Do not use power beyond the specified voltage range. If you do, it may cause a fire or an electric shock.
- Do not reconstruct the GP unit. It may cause a fire or an electric shock.
- Do not use the GP in an environment with flammable gas in the surrounding atmosphere. It may cause explosion.
- GP uses a lithium battery for backing up its internal clock data. If the battery is incorrectly replaced, the battery may explode. To avoid the danger, please do not replace the battery yourself. When the battery needs a replacement, please consult with your local GP distributor.
- Do not use touch panel *keys* in life-related or important disaster prevention situations. Use separate hardware switches for such keys.
- Please design your system so that the machine will not malfunction by a communication fault between the GP and its host controller. If not, there could be a danger of injuring a person or damaging materials.

### To Prevent From Damage:

- Do not hit the touch panel with hard or heavy objects, or press the touch panel with too much force, for it may cause irreparable damage.
- If you place the GP in an environment outside the specified temperature range, the GP will break down.
- Do not allow water, liquids, or metals—which can cause a GP breakdown or electric shocks—inside the GP unit.
- Avoid reducing the GP ventilation, or storing and using the GP in an environment that increases the GP temperature.
- Avoid using and storing the GP in direct sunlight and in dusty or dirty environments.

- Because the GP is a precision instrument, do not store or use the GP where powerful impacts and vibrations will disrupt the unit.
- Do not store or use the GP where chemicals and acids evaporate, or where chemicals and acids are dispersed into the air. The GP may become infected.
- Do not use paint thinner or organic solvents to clean the main unit or display.
- Because unforeseen circumstances may befall your GP unit, be sure to back up your screen data.
- About GP's Display Panel
  - The Display Panel contents and the Contrast Adjustment affect the intensity of *Contouring*. (Contour—when some parts of the screen are brighter than others, creating a wavelike pattern.)
  - There are minute grid-points on the Display Panel surface.
  - Shadows may appear at the top of the LCD extension.
  - Sometimes the display field may look as if the display colors have changed. This phenomenon is a common attribute of LCD's, and not a defect in the system.
  - Displaying a single image for long periods can cause an afterimage to remain when changing to another screen.
  - set the unit to "Stand-by Mode", which turns the screen Off automatically when there is no input (a single screen display with no operations) for a specified period of time.

To prevent this effect:

  - set the unit to "Stand-by Mode", which turns the screen Off automatically when there is no input (a single screen display with no operations) for a specified period of time;
  - do not display any single screen for a long period of time. Change the screen display periodically.

## UL/c-UL(CSA) Approval

The GP370-LG41-24VP and GP370-SC41-24VP are UL/c-UL recognized products. (UL file No. E182139)

GP conforms as a component for the following standards:

- UL508  
Industrial Control Equipment
- UL1604  
Electrical Equipment for Use in Class and , Division 2, and Class  
Hazardous (Classified) Locations
- CAN/CSA-C22.2.Nos.142.and 213-M1987  
Standard for Safety of Information Technology Equipment, including Electrical Business  
Equipment

GP370-LG31-24V (UL Registration Model: 2780051-1)

GP370-SC31-24V (UL Registration Model: 2780051-2)

- The GP should be installed in the front face of a metal panel.
- If the GP is installed so as to cool itself naturally, please mount it onto a vertical panel. Also, ensure that GP unit is mounted at least 100mm away from adjacent structures and other parts. If these conditions are not met, the heat generated by internal components may cause a failure to meet the UL standard requirements.

Installation and operation instructions are provided with each GP. These installation instructions contain the following statements.

1. Power, input and output (I/O) wiring must be in accordance with Class , Division 2 wiring methods, Articles 501-4(b) of the National Electrical Code, NFPA 70 or as specified in Section 18-152 of the Canadian Electrical Code for installations within Canada and in accordance with the authority having jurisdiction.
2. Suitable for use in Class , Division 2, Groups A, B, C and D hazardous location, or non-hazardous locations only.
3. WARNING: Explosion hazard - substitution of components may impair suitability for Class , Division 2,
4. WARNING: Explosion hazard - do not disconnect equipment unless power has been switched off or the area is known to be non-hazardous.
5. WARNING: Explosion hazard - when in hazardous locations, turn off power before replacing or wiring modules.

## What is IP65f ?

This unit's protection rating of IP65f is actually a composite code, consisting of the internationally recognized British "Ingress Protection" standard (BS EN 60529:1992) - "IP65", and the standard developed by the Japanese Electronics Manufacturer's Association (JEM) - "f". This code is used in this manual to identify a given product's degree of structural resistance to a variety of environmental elements and thus, prevent problems or accidents related to the inappropriate use of a product.

The individual meaning of each character of this code is explained below. This code indicates the degree of ingress protection provided from the front face of the PL, and assumes that the PL is securely mounted into a metal panel.

**IP 6 5 f**

(1) (2) (3) (4)

(1) Designates the type of protection provided.

(2) Indicates the degree of protection provided to the human body by the unit, and the degree of protection provided by the unit's front face from particles/dust intrusion into the interior of the unit.

Here, "6" indicates that the unit is completely protected from dust intrusion.

(3) Indicates the degree of protection provided by the unit's front face from water intrusion into the interior of the unit.

Here, "5" indicates that the unit is protected from water intrusion from a direct water jet.

(4) Indicates the degree of protection provided by the unit's front face from oil particle intrusion into the interior of the unit.

Here, "f" indicates that the unit is completely protected from oil intrusion via either oil particles or oil splashes from any direction (to the front panel).



## Package Contents

The GP box contains the items listed below. Ensure everything illustrated has been included.

- **GP Unit**  
(GP370-LG11-24V, GP370-SC11-24V,  
GP370-LG41-24VP, GP370-SC41-24VP)
- **Handling Guide**

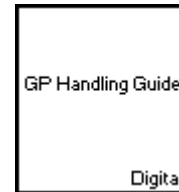
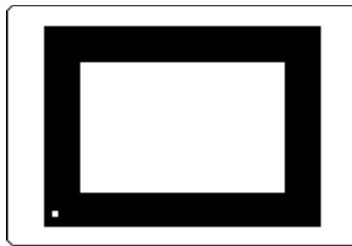

- **Installation Fasteners (4/set)**

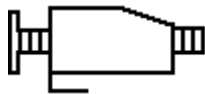

This unit has been carefully packed, with special attention to quality. However, should you find anything damaged or missing, please contact your local GP distributor immediately for prompt service.

\* This manual (GP-370 Series User's Manual) is sold separately.

## Symbols

The list below describes symbols and abbreviations used in this manual.



Warns a situation that could seriously injure a person or lead to death if the GP is used in a wrong way or the warning is ignored.



Explains a situation that could injure a person or damage materials if the GP is used in a wrong way, or the warning is ignored.



Explains a situation that requires a moderate amount of caution.

**GP Screen Editing software** Represents the “GP-PRO/PB III” or “GP-PRO/PB III for Windows 95” software.

**PLC** Programmable Logic Controller

**\*1** A reference point. Describes the word or phrase marked by the asterisk (\*) and the corresponding number.



Indicates a word or phrase that may require additional explanation.



Reference pages on related topics.

**n:1** n:1 (multi-link) connection setup.

# Chapter 1

## Introduction

1. Before Operating GP
2. System Structure
3. Optional Equipment

### 1.1 Before Operating GP

Follow these steps before operating the GP unit.

- 1 Preparation**

Before using the GP, arrange the hardware and check the specifications, wiring, and installation.

**REFERENCE →** Chapter 2, "Specifications", and Chapter 3, "Installation and Wiring".
- 2 Screen Design**

Draw a Screen and design a Tag layout, using the Screen layout sheet and Tag list provided in your manual.
- 3 Select GP type and PLC**

Using your screen design software, select GP type and the PLC host that is connected to the GP unit.

**REFERENCE →** *Software Operation Manual*.
- 4 Create Screen/ Run Screen Setup**

Setup the screen, parts and tags in your screen editing software, while referring to your screen design.

**REFERENCE →** *Software Operation Manual* and *Software Tag Reference Manual*.
- 5 Screen Data Transfer**

Transfer the data from the Screen design software on your PC to the GP unit using the Downloading Cable (included w/ the screen design software).

**REFERENCE →** *GP-PRO/PB3 Software Operation Manual*.

### 6 Initialize

Following the specifications of the PLC host in use, initialize the setup of the GP unit.

**REFERENCE →** Chapter 4, "Initialize", and *Software PLC Connection Manual*.

### 7 Run

Link the GP with the PLC host using the Connection Cable (different cables may be necessary for different hosts), then run the System.

**REFERENCE →** *Software PLC Connection Manual*.



---

---

## 1.2 System Structure

The diagram on the following page illustrates the peripheral equipment of the GP unit.

### Legend

| GP Interface   | PLC Interface  | PC Interface        |
|--|----------------|---------------------|
| ① Tool Connector   | ③ RS-232C Port | ⑥ Printer Interface |
| ② Serial Interface   | ④ RS-422 Port  |                     |
|  | ⑤ Program Port |                     |
|  Screen Editing Environment |                |                     |
|  GP Operating Environment   |                |                     |

### Optional Parts

Optional items sold separately.

### Maintenance Parts

These items are originally included with or in the package of GP unit. They can also be purchased separately for replacement.

# Introduction

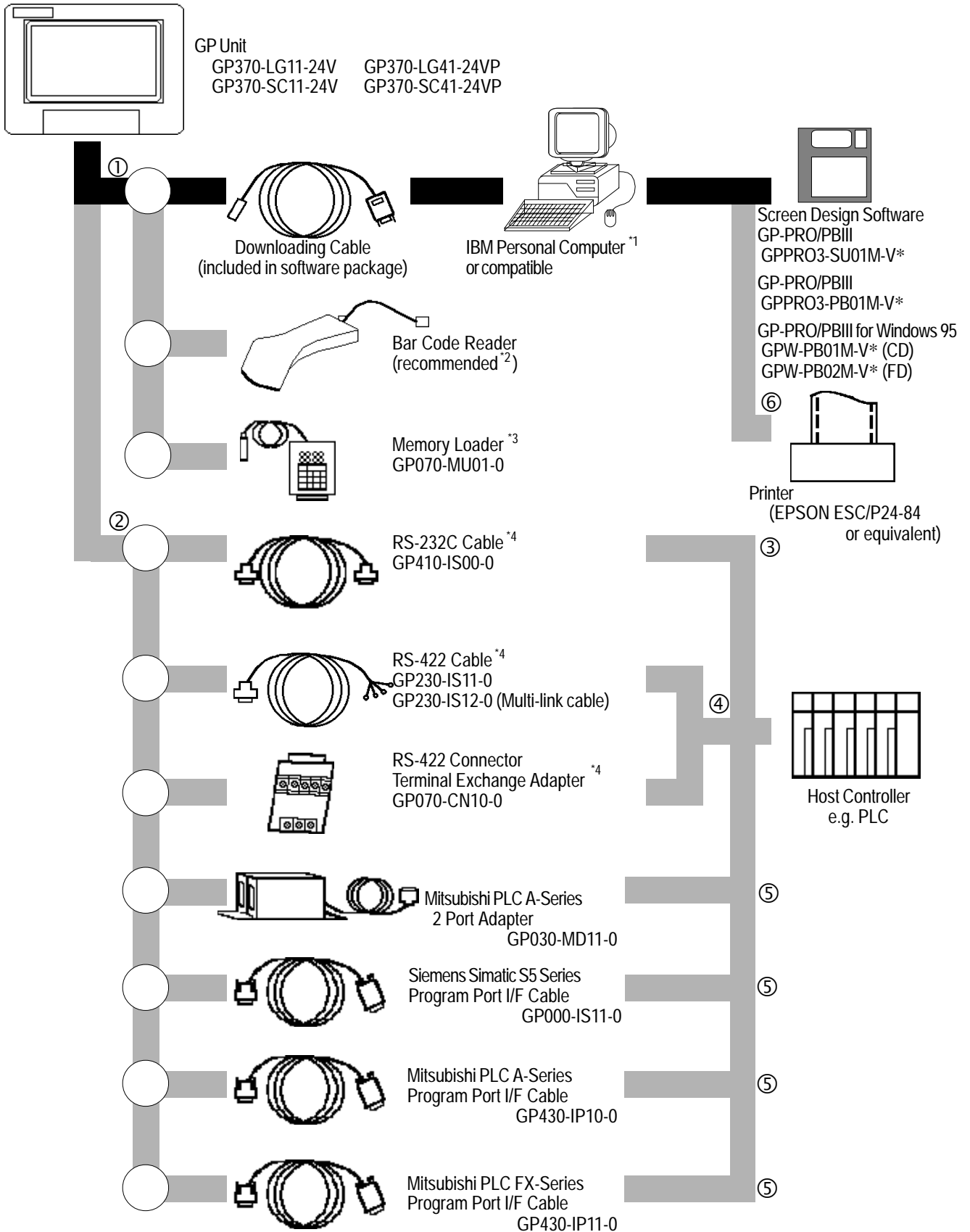

## Optional Part



Cover Sheet  
GP370-COVER-20P

## Maintenance Parts



GP-370 Backlight Bulbs  
GP370-BL00-MS



GP-70 Series Installation Fasteners  
GP070-AT00-MS



Rubber Gasket  
GP370-WP00-MS

\*1 There are cases where only a limited PCs can be used.

\*2 AIMEX manufacturer

- BR-331 PC2 (Pen-type)

OPT Electronics manufacturer

- OPT-1125-WL 98 (Touch Scanner) • OPT-1125-WD 98 (Keyboard)
- OPT-5125-WL 98 (Touch Scanner) • OPT-5125-WD 98 (Keyboard)
- LT-2125-WL 98 (Touch Scanner) • OPT-2125-WD 98 (Keyboard)

\*3 Cannot be used with system versions 1.20 or higher.

**REFERENCE →** *6-1-1 Powering Up*

\*4 Certain types of PLC's cannot be connected.

**REFERENCE →** *Software PLC Connection Manual.*

## Introduction

### 1.3 Optional Equipment

All optional equipment listed below are products of Digital Electronics Corp.

|                     | ITEM   | DESCRIPTION   |
|---------------------|--|---|
| Screen Editing Tool | GP-PRO/PB III (GPPRO3-SU01M-V*)<br>GP-PRO/PB III (GPPRO3-PB01M-V*)<br>GP-PRO/PB III for Windows 95 (GPW-PB01M-V* :CD-ROM)<br>(GPW-PB02M-V*: FD)<br><available from Feb. '97> | GP-PRO/PB III<br>PC based Screen design Software for use with the Digital GP-*70 Series of display panels.<br>Includes download cable to connect the PC and GP.           |
| Serial Interface    | RS-232C Cable *1 (GP410-IS00-O)  | I/F Cable to connect the GP unit with the PLC.  |
|                     | RS-422 Cable *1 (GP230-IS11-O)   |   |
|                     | Multi-link Cable*1 (GP230-IS12-O)  | Runs multi-link (n:1) SIO between each PLC type and GP series. RS-422 interface cable.  |
|                     | RS-422 Terminal *1 Connector Adapter (GP070-CN10-O)  | Adapter for changing the terminal output from a serial interface to RS-422 I/F.   |
|                     | Siemens Simatic Series Programming Port I/F Connection Cable (GP000-IS11-O)  | TTY converter cable for Siemens Simatic S5 Series PLCs. You would not be able to use a program console at the same time.  |
|                     | Mitsubishi A Series Programming Port I/F cable (GP430-IP10-O)  | Connects directly to Mitsubishi's FX Series I/F Programming Console, making the conversion link unit unnecessary. However, cannot use a program console at the same time. |
|                     | Mitsubishi PLC FX Series Programming Port I/F Cable (GP430-IP11-O)   |   |
|                     | Mitsubishi PLC A Series 2 Port Adapter (GP030-MD11-O)  | An interface unit that enables use of the GP Series and Mitsubishi A series equipment in the same location.   |

\*1 Certain types of PLC's cannot be connected.  *Software PLC Connection Manual.*

## Introduction

|                   | <b>ITEM</b>  | <b>DESCRIPTION</b>  |
|-------------------|--|---|
| Option Part       | Cover Sheet<br>GP-370<br>(GP370-COVER-20P)             | Disposable GP screen protection from dust and other elements. The GP can be used with the Cover Sheet still attached to the GP screen. (20/set) |
| Maintenance Parts | GP-370 Backlight Bulbs<br>(GP370-BL00-MS)              | Replacement Backlight bulbs.  |
|                   | GP-70 Series Installation Fasteners<br>(GP070-AT00-MS) | Metal installation brackets for GP-470/570/370/270 Series.  |
|                   | Rubber Gasket<br>GP-370 Series<br>(GP370-WP00-MS)      | Rubber gasket for installing the GP.  |
| Tool Connector    | Memory Loader<br>(GP070-MU01-O)                        | Runs a high speed data copy from one GP to another (System program and Screen data).<br>Cannot be used with system versions 1.20 or higher.     |



# Chapter 2

## Specifications

1. General Specifications
2. Function and Performance
3. Interface Specifications
4. Names and Functions of GP Parts
5. Graphic Panel Dimensions

### 2.1 General Specifications

#### 1. Electrical Specifications

|                             | GP370-LG**  | GP370-SC** |
|-----------------------------|---|------------|
| <b>Input Voltage</b>        | DC20.4V~27.6V   |            |
| <b>Power Consumption</b>    | under 20W (TYP 10W)   |            |
| <b>Voltage Endurance</b>    | AC1000V 10mA 1minute<br>(between the live wire and grounding terminals) |            |
| <b>Isolation Resistance</b> | Above 20MΩ at DC500V<br>(between the live wire and grounding terminals) |            |

## 2. Environmental Specifications

|                                | GP370-LG**   | GP370-SC** |
|--------------------------------|--|------------|
| <b>Operating Temperature</b>   | 0 ~ 50 degrees Celcius                             |            |
| <b>Storage Temperature</b>     | -20 ~ 60 degrees Celcius                           |            |
| <b>Ambient Humidity</b>        | 20 ~ 85%RH (non-condensing)                        |            |
| <b>Vibration Endurance</b>     | 10 ~ 25 Hz (X,Y,Z directions 30 minutes 2G)        |            |
| <b>Noise Endurance</b>         | Noise voltage: 1000 Vp-p                           |            |
|                                | Pulse length: 1 microsecond                        |            |
|                                | Arise time (rise/fall): 1 nanosecond               |            |
| <b>Atmosphere</b>              | Not immune to corrosive gas                        |            |
| <b>Ground Connection</b>       | Ground resistance under 100 Ohms                   |            |
| <b>Protective Structure</b> *1 | Equivalent to JEM1030 IP65f and NEMA#250 TYPE4X/12 |            |

\*1 The front face of the GP unit, installed in a solid panel, has been tested using conditions equivalent to the standards shown in the specification . Even though the GP unit's level of resistance is equivalent to these standards, oils that should have no effect on the GP can possibly harm the unit. This can occur in areas where either vaporized oils are present, or where low viscosity cutting oils are allowed to adhere to the unit for long periods of time. If the GP's front face protection sheet becomes peeled off, these conditions can lead to the ingress of oil into the GP and separate protection measures are suggested. Also, if non-approved oils are present, it may cause deformation or corrosion of the front panel's plastic cover. Therefore, prior to installing the GP be sure to confirm the type of conditions that will be present in the GP's operating environment. If the installation gasket is used for a long period of time, or if the unit and its gasket are removed from the panel, the original level of the protection cannot be guaranteed. To maintain the original protection level, you need to replace the installation gasket regularly.

## 3. Structural Specifications

|                                   | GP370-LG**                             | GP370-SC** |
|-----------------------------------|--|------------|
| <b>External Measurements (mm)</b> | 170W × 138H × 57D mm<br>(GP unit only) |            |
| <b>Weight</b>                     | Under 900g (GP unit only)              |            |
| <b>Cooling System</b>             | Natural air circulation                |            |

# Specifications

## 2.2 Function and Performance

### 1. Display Functions

|                            | <b>GP370-LG**</b>  | <b>GP370-SC**</b>   |
|----------------------------|--|---|
| <b>Display Media</b>       | Monochrome LCD   | STN Color LCD   |
| <b>Display Color</b>       | White, Black   | 8 colors (white, red, blue, green, yellow, magenta, cyan, black) Tiling patterns make blends of colors possible |
| <b>Back light</b>          | CFL (under normal temperatures and humidity, lifespan = 20,000 hours)  |   |
| <b>Resolution</b>          | 320 × 240 pixels   |   |
| <b>Display Area</b>        | 115W × 86H (mm)  |   |
| <b>Attributes</b>          | Blink/ Reverse Video   |   |
| <b>Contrast Adjustment</b> | The Touch Panel has 8 levels of contrast adjustments available   |   |
| <b>Characters</b>          | Korean: (KSC5601-1992 codes) Hangul fonts (including Kanji)  |   |
|                            | Chinese: (GB2321-80 codes) simplified Chinese fonts  |   |
|                            | Taiwanese: (Big 5 codes) traditional Chinese fonts   |   |
|                            | ASCII: (Code Page850) Alphanumeric (including European fonts)  |   |
|                            | Japan: ANK 158 type, Kanji:6349 (includes non-Kanji:453, and Standard JIS Type 1 and Type 2)                                     |   |
| <b>Char. Disp. #</b>       | 8x8 dot font: 40 Char. per row, 30 rows<br>8x16 dot font: 40 Char. per row, 15 rows<br>16x16 dot font: 20 Char. per row, 15 rows |   |
| <b>Character Size</b>      | Height and width can be expanded by 2, 4, or 8.  |   |

## 2. Screen Memory

---

|                        | GP370-LG**   | GP370-SC** |
|------------------------|--|------------|
| <b>Internal Memory</b> | FLASH EPROM 1 Mbyte<br>(Up to 320 screens w/ a standard screen size of 3.2 Kbytes) |            |

## 3. Touch Panel / Clock Accuracy

---

|                       | GP370-LG**                                  | GP370-SC** |
|-----------------------|---|------------|
| <b>Touch Panel</b>    | 16 × 12 keys/ screen (1 or 2 point touch)   |            |
| <b>Clock Accuracy</b> | +/- 40 seconds/ month (at room temperature) |            |

## 4. External Interface

---

|                         | GP370-LG**   | GP370-SC** |
|-------------------------|--|------------|
| <b>Serial Interface</b> | Asynchronous Transmission Method: RS-232C/RS-422<br>Data Length: 7 or 8 bits<br>Stop Bit: 1 or 2 bits<br>Parity: None, Odd or Even<br>Data Transmission Rate: 2400~38400bps                    |            |
| <b>Tool Connector</b>   | RS-232C Asynchronous Transmission TTL level non-procedure command interface<br>(During Development) use the I/F to download Screen design<br>(During RUN mode) use with the BarCode Reader I/F |            |

# Specifications

## 2.3 Interface Specifications

### 1. Serial Interface

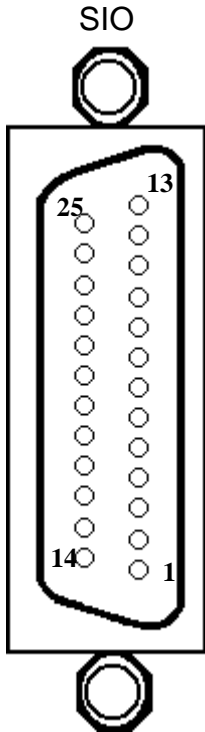

| Pin # | Signal Name | Condition                | Pin # | Signal Name | Condition                 |
|-------|-------------|--------------------------|-------|-------------|---------------------------|
| 1     | FG          | Frame ground             | 14    | VCC         | 5V ±5% output 0.25A       |
| 2     | SD          | Send data (RS-232C)      | 15    | SDB         | Send data B (RS-422)      |
| 3     | RD          | Receive data (RS-232C)   | 16    | RDB         | Receive data B (RS-422)   |
| 4     | RS          | Request send (RS-232C)   | 17    | NC          | No connection             |
| 5     | CS          | Clear send (RS-232C)     | 18    | CSB         | Clear send B (RS-422)     |
| 6     | NC          | No connection            | 19    | ERB         | Enable receive B (RS-422) |
| 7     | GND         | System ground            | 20    | ER          | Enable receive (RS-232C)  |
| 8     | CD          | Carrier detect (RS-232C) | 21    | CSA         | Clear send A (RS-422)     |
| 9     | TRMX        | Termination (RS-422)     | 22    | ERA         | Enable receive A (RS-422) |
| 10    | RDA         | Receive data A (RS-422)  | 23    | BUZZ GND    | External Buzzer ground    |
| 11    | SDA         | Send data A (RS-422)     | 24    | NC          | No connection             |
| 12    | NC          | No connection            | 25    | BUZZ OUT    | External Buzzer output    |
| 13    | NC          | No connection            |       |             |                           |

Recommended Connector: Dsub25pin plug XM2A-2501 <made by OMRON Corp.>

Recommended Cover : Dsub25pin Cover XM2S-2511 <made by OMRON Corp.>  
Dsub25pin plug XM2A-2501 <made by OMRON Corp.>



Use rough metric type M2.6×0.45p threads used to hold the cable's set (fastening) screws in place.

Recommended Cable : CO-MA-VV-SB5P×28AWG <made by HITACHI Cable Ltd.>



**REFERENCE →** *Software PLC Connection Manual* to determine your PLC's connection points.



When creating your own cable, follow the instructions listed below concerning each connection type.

#### RS-422

The following pairs of pin #'s must be connected to each other.

..... #18 (CSB) <—> #19 (ERB)

..... #21 (CSA) <—> #22 (ERA)

- When connecting the RS-422 cable and the #9 (TRMX) and #10 (RDA) points, a termination resistance of 100Ω is added between RDA and RDB.
- When making a cable for the Memory Link format, be sure to select a 4-line System.

#### RS-232C

- Do not use the following pins:

9 (TRMX), 10 (RDA), 11 (SDA), 15 (SDB), 16 (RDB), 18 (CSB), 19 (ERB), 21 (CSA), 22 (ERA).

## GP-370 Serial Interface Connections

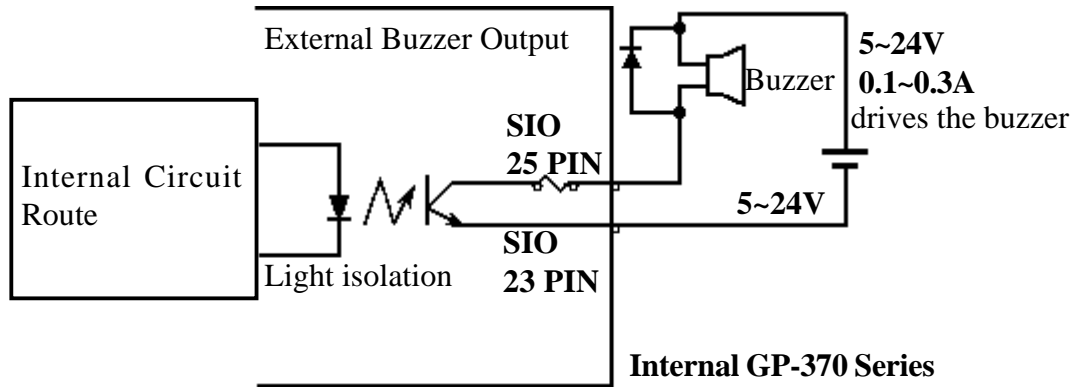

## 2.4 Names and Functions of GP Parts

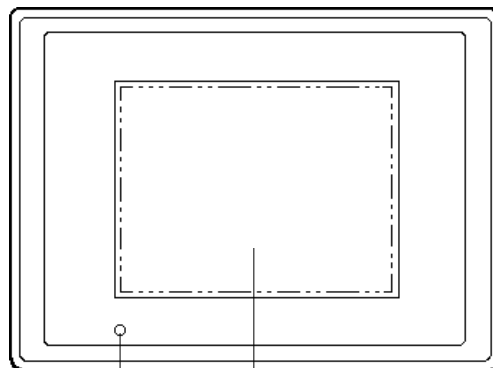

A: Display Type.

The GP monitor screen displays the screen setup and corresponding PLC host data.

GP370-LG\*\* Monochrome LCD

GP370-SC\*\* STN type Color LCD

B: Touch Panel

Runs any screen change operations and sends data to the PLC.

C

A,B

C: Power Lamp

Lights up when the power is turned On. (Green LED)

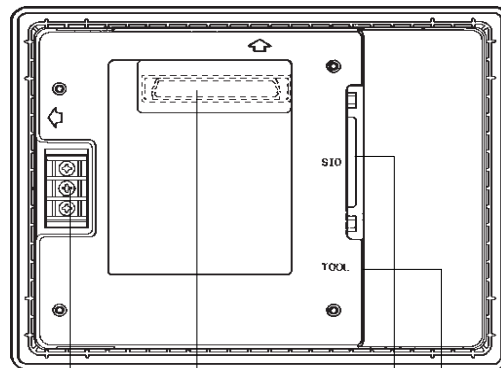

D: Power Input Terminal Block

Power cable connection.

E: Extension Interface

This I/F will be used in future versions.

F: Serial Interface

Connect the RS-232C and RS-422 (Serial) interface to the PLC host.

D

E

F

G

G: Tool Connector

The Transfer cable, Bar Code reader, and Memory Loader connect here.

# Specifications

## 2.5 Graphic Panel Dimensions

### 1. GP-370 Series External Dimensions

Unit: mm

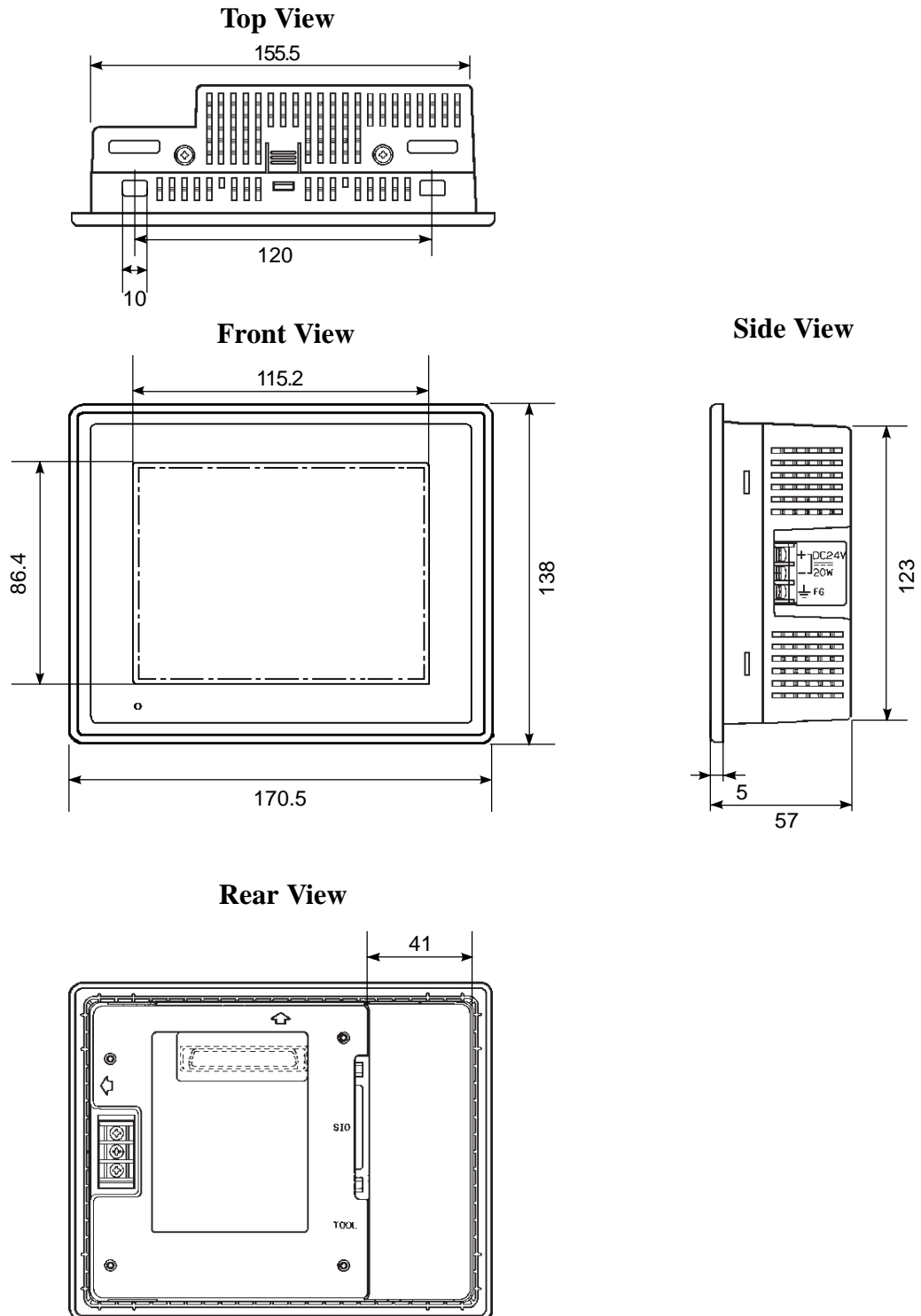

## 2. Installation Fasteners

Units: mm

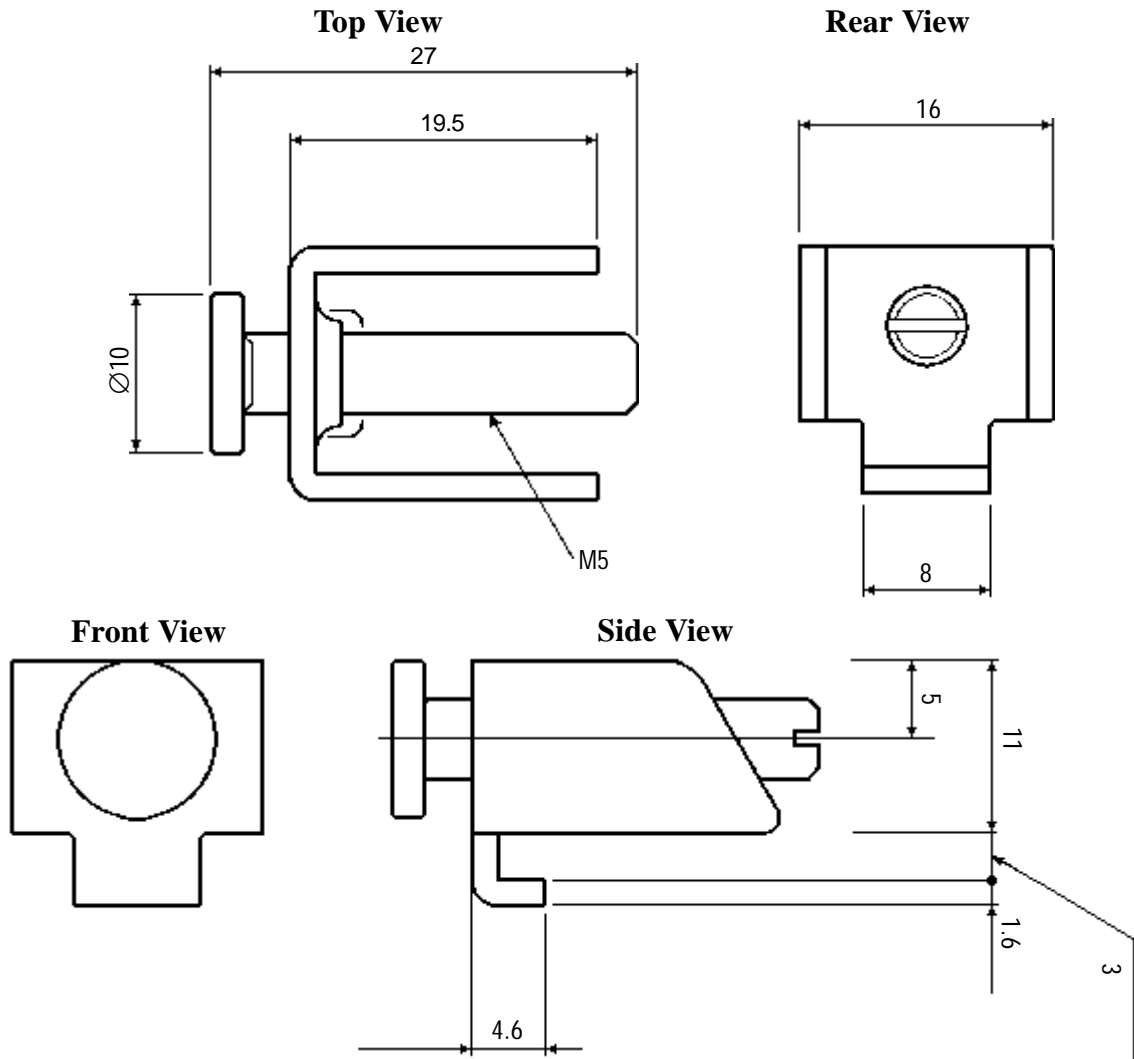

## 3. GP Installation Dimensions

Unit: mm

Mounting Hole for Installation

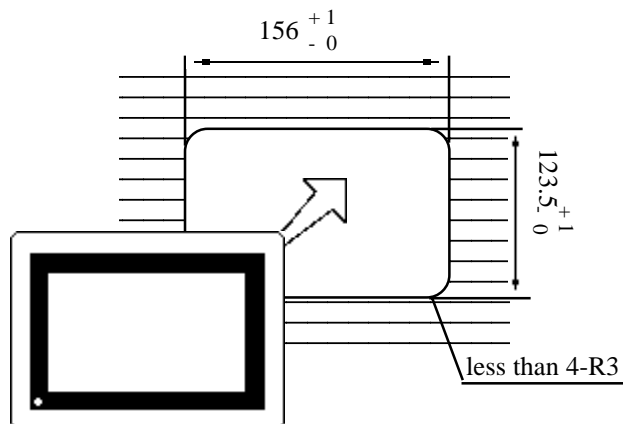



## Chapter 3

# Installation and Wiring

1. Installation
2. Wiring
3. Tool Connection

## Installation

When installing the GP unit, use the tips listed below



Before mounting the unit, please make sure the gasket is attached to the unit.

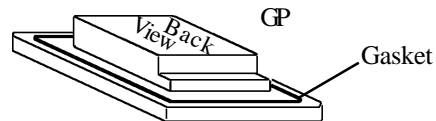

### 1. Installation

Install the GP unit following these steps.

#### Create an Opening

Following the GP Installation dimensions, create the opening required for GP installation. The rubber gasket, installation brackets, and screws are necessary when installing the GP. **REFERENCE** → Chapter 2.5, "Graphic Panel Dimensions".

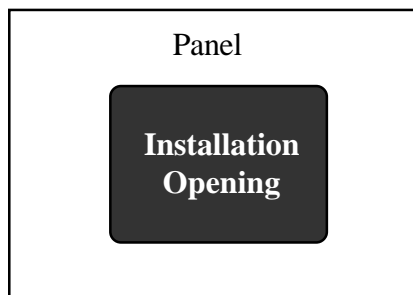

- It is important that the plate surface is flat, in good condition, and without any jagged edges.
- Panel thickness should be between 1.6mm and 5.0mm.

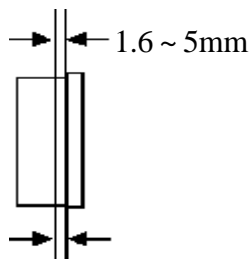

# Installation and Wiring



- For easier maintenance and operation, plus better ventilation, ensure the GP unit is mounted at least 100 mm away from adjacent structures and other parts.

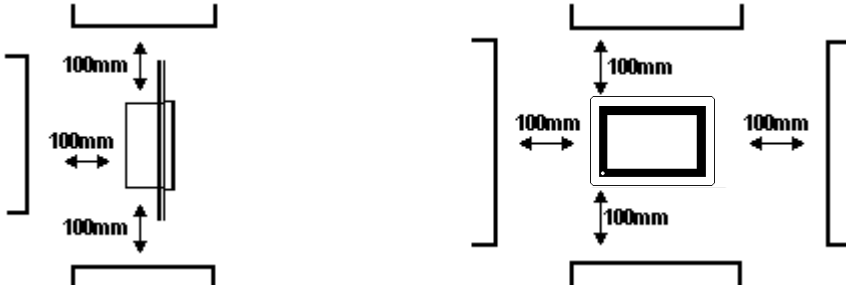

- The GP uses ventilation in its outer shell to naturally cool itself. When installing the unit horizontally or sideways, use a forced air cooling system (i.e. a fan) or lower the surrounding temperature to avoid overheating.

### Vertical Installation

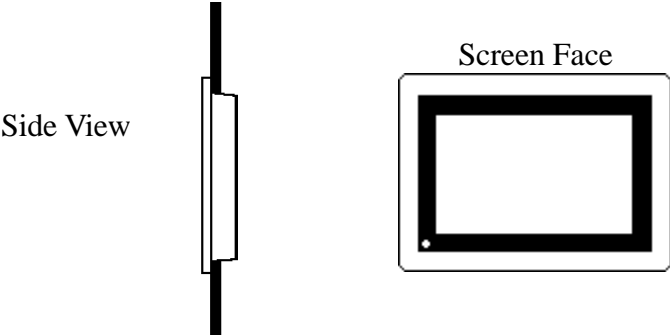

### Horizontal Installation

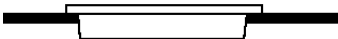

### Sideways Installation

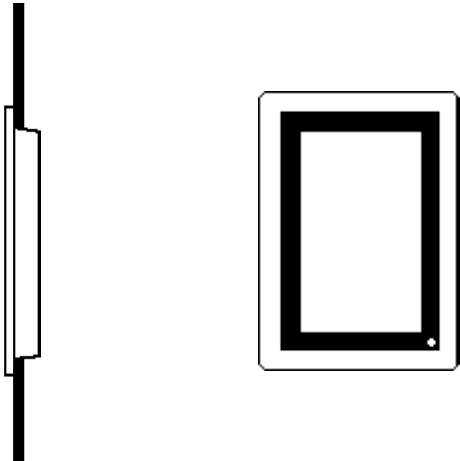

## Installation and Wiring

- When installing sideways, place the GP so that the Power Terminal Block points upwards.
- Ensure heat from other equipment does not cause extra heating pressure on the GP.
- Do not use GP-370 Series in an environment that exceeds 50°C.
- Ensure that this unit is located as far away as possible from electromagnetic circuits, non-fuse type breakers, and other equipment that can cause arcing.
- When installing the GP unit, with natural air circularion cooling system, onto a slanted panel, the panel slope should not incline more than 30°.

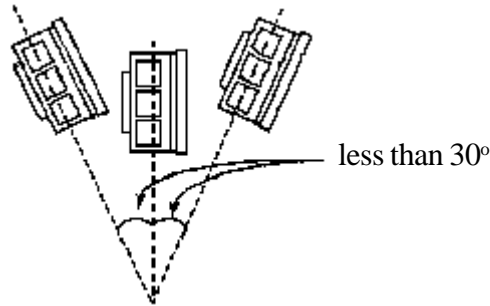

Install the unit from the front of the panel opening.

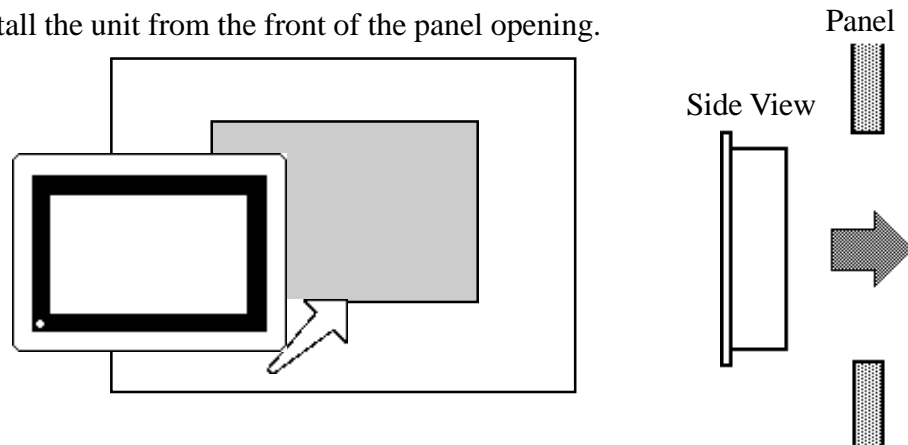

Secure the Installation brackets from the backside of the panel.

There are 4 insertion slots on the top and bottom of the GP, where the metal installation brackets hook on.

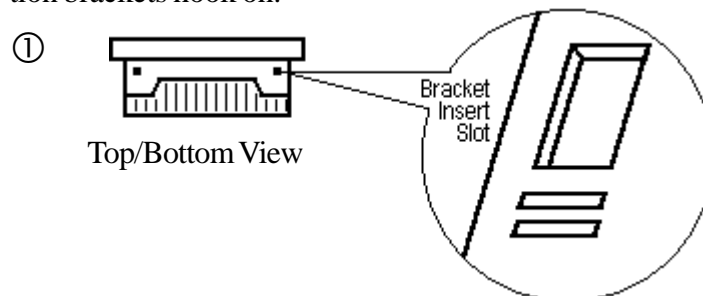

## Installation and Wiring

### ② Installation Bracket

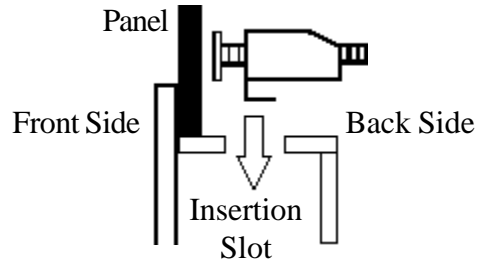

### ③ After inserting the brackets into the appropriate slots, carefully force the bracket to the back of the GP.



Use a screw driver and tighten the screw from the back to hold the GP unit in place. A torque of 0.5~0.6N•m is required to tighten the screw.

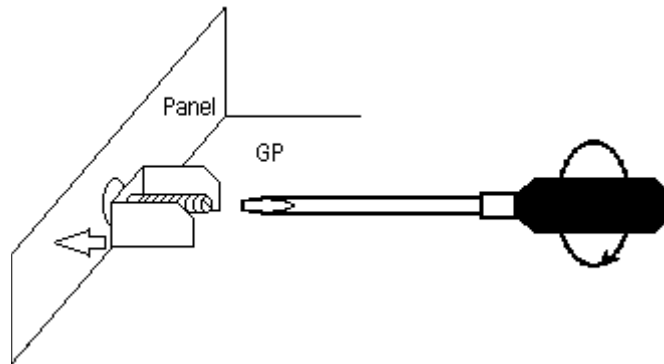

Using too much force may damage the GP unit.

# Installation and Wiring

## 3.2 Wiring

### 1. Power Cable Connection



- To avoid electric shocks, be sure the Power Cable is unplugged from the power outlet when connecting the cable to the GP unit.
- GP-370 Series can only take DC24V input. If you supply power other than DC24V, you will damage its power supply and the GP unit.
- There is no power switch on the GP unit, so please use a breaker switch.



When the FG terminal is connected, be sure the wire is grounded. Not grounding the GP unit will result in excess noise.



- Wherever you can, use thick wires (max 2mm<sup>2</sup>) for power terminals, and provide an extra twist to the wire during connection.
- Please use Ring Terminals with the size described below.

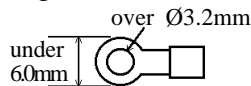

- To avoid a short among the ring terminals when the screws get loosen, please use ring terminals with a sleeve.

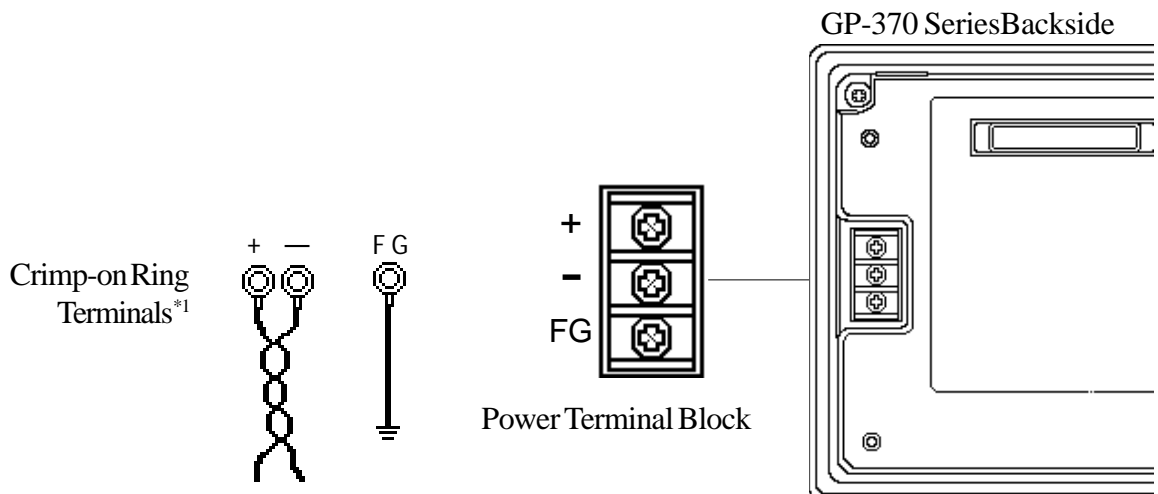

Connect the GP power cables following the steps below.

- ① Check to make sure the Power is Off.
- ② Remove the Terminal cover.

\*1 Ring Terminals: V2-MS3 suitable (made by JST)

- ③ Disconnect the screws from the 3 terminals, align the power wire rings and re-insert the screws. (Check each wire to make sure the connections are correct.)



The torque required to tighten the screws is 0.5~0.6N•m.

## 2. Precaution: Grounding

---

- (a) exclusive grounding (BEST)

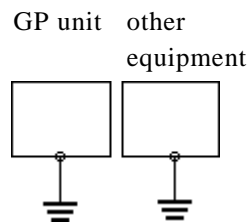

- Connect the FG terminal found at the back of the unit to an exclusive ground. [diagram (a). There is a grounding resistance of under 100Ω.]
- If exclusive grounding is not possible, use a common connection point. [diagram (b)]

- (b) common grounding (OK)

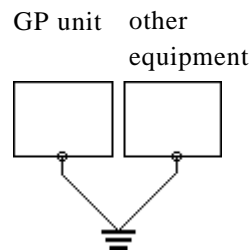

- The grounding wire should have a cross sectional area greater than 2mm<sup>2</sup>. Set the connection point as close to the GP unit, and make the wire as short, as possible. When using a long grounding wire, replace the thin wire with a thicker wire placed in a duct.

- (c) common grounding (BAD)

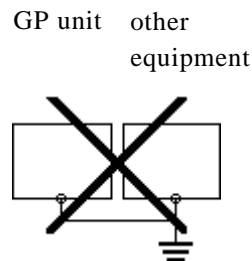

- If this equipment does not function properly when grounded, disconnect the ground wire from the FG terminal.

## 3. Precaution: Input/Output Signal Lines

---

- Input and output signal lines must be separated from the power control cables for operating circuits.
- If this is not possible, use a shielded cable and connect the shield to the frame of the GP unit.

## Installation and Wiring

### 3.3 Tool Connector

The Downloading Cable or a Bar Code Reader fits into the Tool Connector socket.

Side View

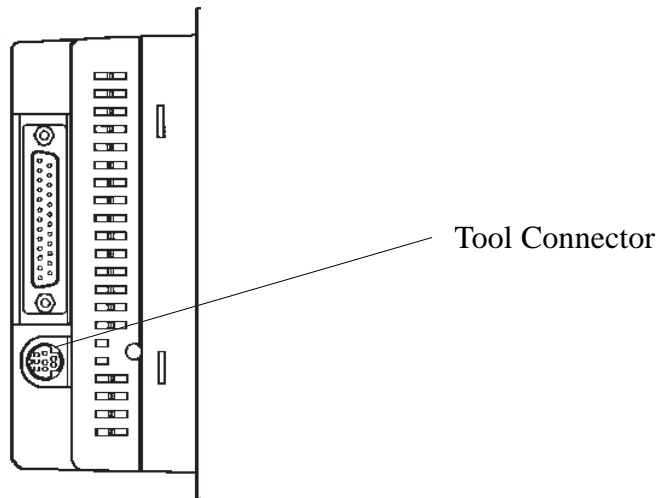

- When inserting or removing items from the Tool Connector socket, be sure the GP unit has been turned Off.
- When the Bar Code Reader uses a different power supply:
  - Turn the Bar Code Reader on before turning the GP unit on.
  - Turn the GP unit off before turning the Bar Code Reader off.





# Chapter 4

## Off-line Mode

- 1. Entering Off-line Mode
- 2. Main Menu
- 3. INITIALIZE—Standard Operations
- 4. SELF-DIAGNOSIS—Standard Operations
- 5. Transfer Screen Data

### 4.1 Entering Off-line Mode

The Off-line Mode refers to Initialize, Self-Diagnosis, and other setups contained in the GP. Prepare the GP unit in the Off-line mode before running any operations.



The Off-line mode is unavailable in a brand new GP until Screen Data has been transferred from the corresponding screen editing software.

Note: Be sure that the GP is turned ON when transferring the system file.

To INITIALIZE the setup or run SELF-DIAGNOSIS in the GP unit, transferring to the Off-line mode becomes necessary. There are 2 ways to enter the Off-line mode: number one, when turning the unit on, and number two, using Force Reset.

#### 1. When Turning the Unit On

Press the top left corner of the GP screen within 10 seconds of switching the power On.

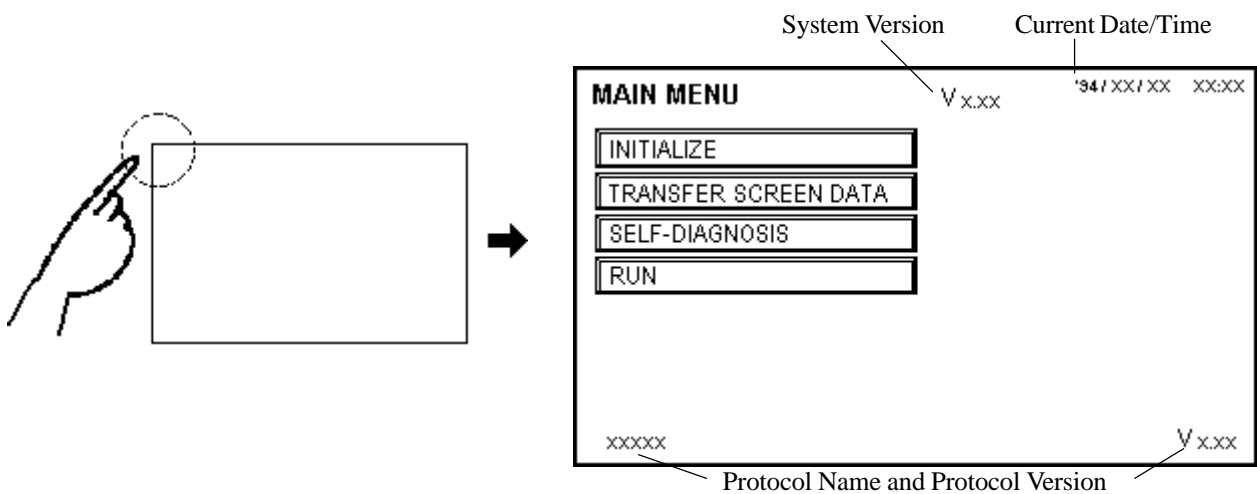

## 2. Enter From Force Reset

From the Force Reset screen, press the OFFLINE button.

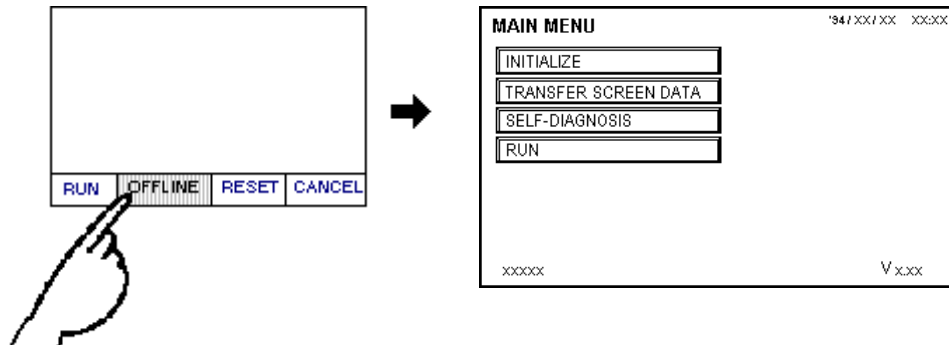

For more information about Force Reset **REFERENCE →** Chapter 5.4.2, "SET UP I/O".



- When the GP unit has the Device Monitor function, the following display will appear. **REFERENCE →** GP-PRO/PBIII for Windows 95 Software PLC Connection Manual, Appendix 3 "Device Monitor".

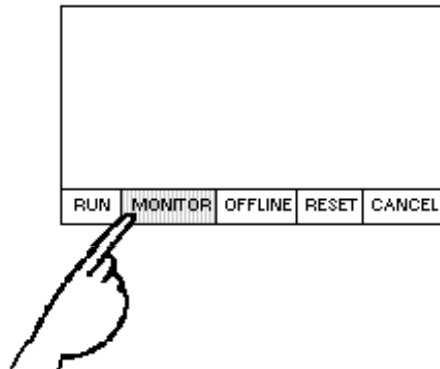

If a Password has been set in INITIALIZE/ SET UP SYSTEM, before entering the Off-line mode, the following screen displays.

Enter the password, then press *Set* to enter Off-line mode.

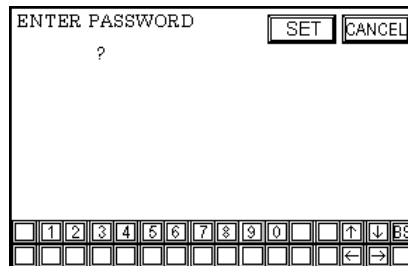

Only the GP-PRO/PBIII for Windows 95 can utilize this Device Monitor function.

For more about the *Password*, **REFERENCE →** Chapter 5.3.1, "SYSTEM Environment SETUP".

For more information on the password input **REFERENCE →** Chapter 4.3, "INPUTTING NUMBERS".

## Off-line Mode

### 4.2 Main Menu

The Main Menu includes the setup items listed below: INITIALIZE, SCREEN DATA TRANSFER, SELF-DIAGNOSIS, and RUN. Each menu item has different setups that must be set to match the corresponding PLC in order for the GP to communicate properly.

Entering the Off-line mode displays the screen illustrated below.

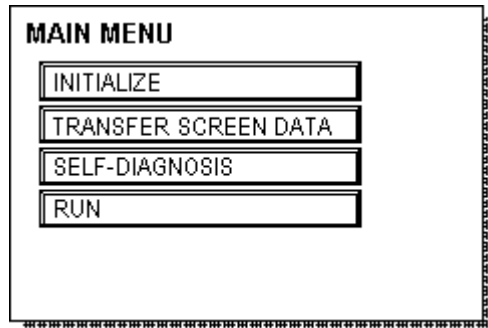

Select the menu item by pressing the title on the screen.

A short description of each Main Menu item follows.

#### INITIALIZE

The setup items listed in this menu are necessary to run the GP unit.

#### TRANSFER SCREEN DATA

Select to transfer screen data to and from the screen editing software.

#### SELF-DIAGNOSIS

Checks to see if there are any problems with the GP System or Interface (I/F).

#### RUN

Begins operations in the GP unit.

**REFERENCE** → For more information about INITIALIZE, refer to Chapter 5, "Initialize"; for more information about TRANSFER SCREEN DATA, refer to the *Software Operation Manual*; for more information about SELF-DIAGNOSIS and RUN, refer to Chapter 6, "Run and Errors".

### 4.3 INITIALIZE—Standard Operations

#### Selecting A Menu

- Press the menu title to setup.

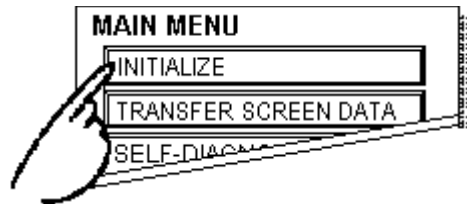

- Press the menu item you wish to setup.

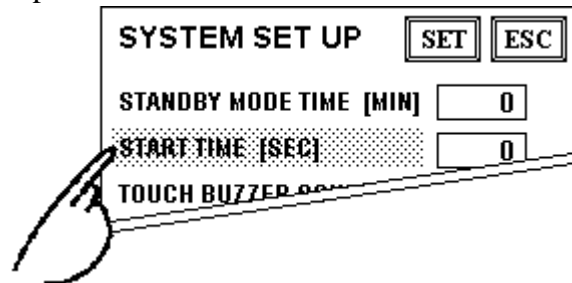

#### Inputting Numbers

- After selecting an input field by touching it, use the numeric touch keys that appear next to enter numeric values.

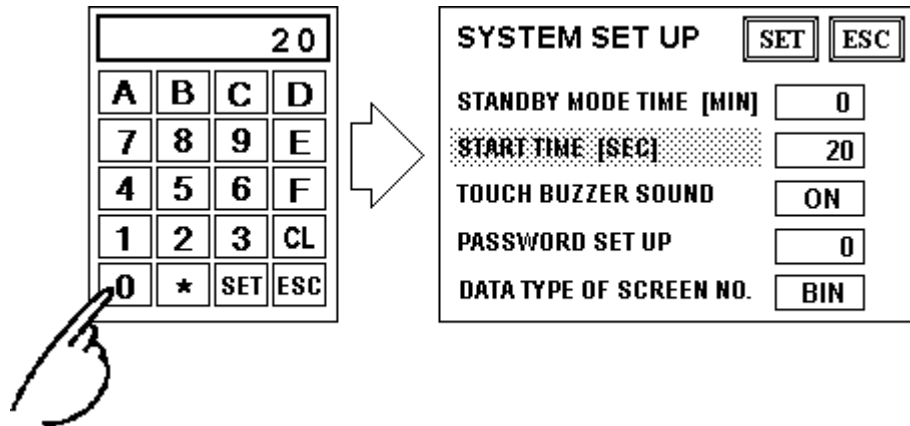

#### Selecting Setup Conditions

- After selecting the menu item, press the option you would like to setup. In this example, pressing the TOUCH BUZZER SOUND turns that option Off.

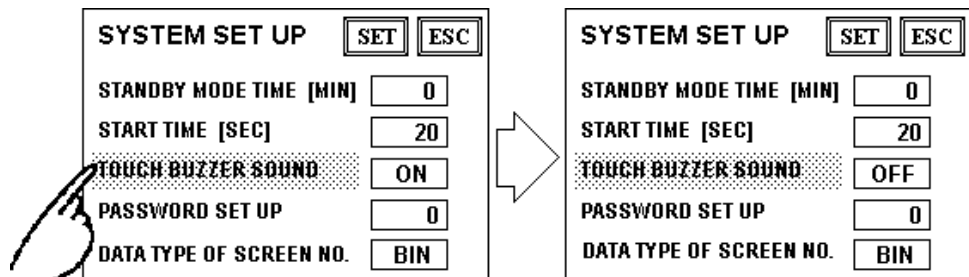

## Off-line Mode

### Ending Setup

To end setup, you would usually press the top-left button, SET.

If you wish to exit the screen without saving the changes, press the ESC button.

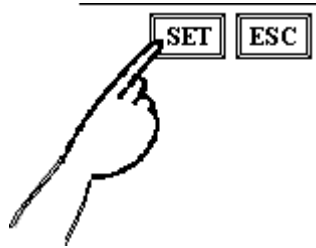

- Press the SET key to write the Setup conditions onto the Internal FEPRM, which may take some time, causing a delay in returning to the previous screen. Therefore, do not touch the screen until the previous menu display returns.
- Press the CANCEL key to *not write* the Setup conditions onto the Internal FEPRM and return to the previous menu.

### Return To Previous Screen

Press the title of the screen you would like to return to.

E.g. To return to the MAIN MENU from the SYSTEM ENVIRONMENT SETUP screen, simply press the MAIN MENU title.

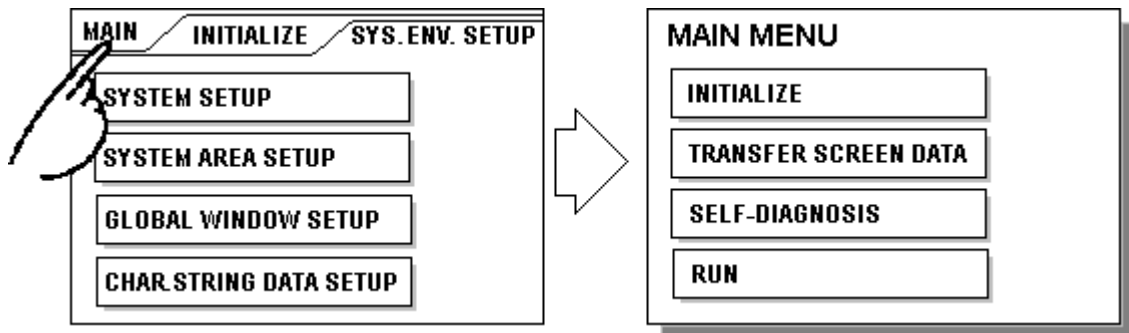

## 4.4 SELF-DIAGNOSIS—Standard Operations

### Selecting A Menu

Press the title of the menu item to diagnose.

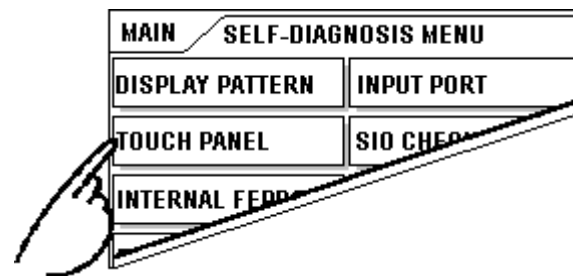

**SET, ESC Keys**

After selecting the SELF-DIAGNOSIS item, the **SET** and **ESC** keys appear at different times at the top of the screen.

E.g.

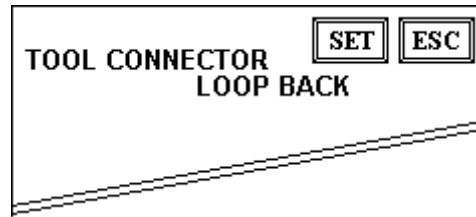

- SET Key

When this key is pressed, the Self-Diagnosis begins.

- ESC Key

When this key is pressed, the Self-Diagnosis command is cancelled, and you return to the Self-Diagnosis menu.

**After Check—To Return To SELF-DIAGNOSIS MENU**

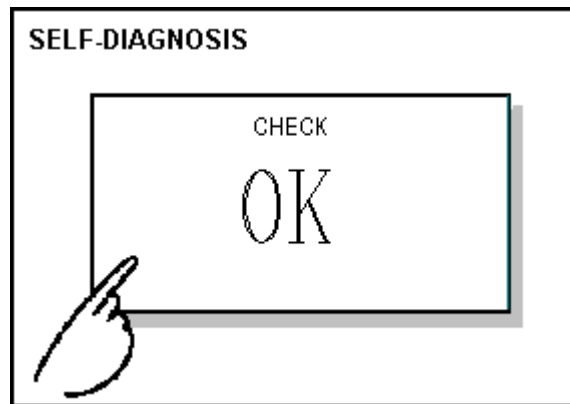

When OK displays, pressing once anywhere on the display screen returns you to the SELF-DIAGNOSIS MENU.

When an Error Message displays

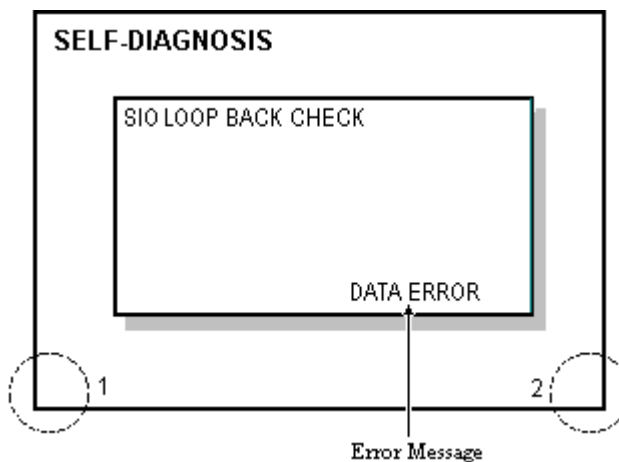

When an error message appears on the display screen, press the bottom two corners of the panel (1, 2) to return to the SELF-DIAGNOSIS MENU.

## Off-line Mode

### Return To Main Menu

Press the MAIN tab in the SELF-DIAGNOSIS menu to return to the MAIN MENU.

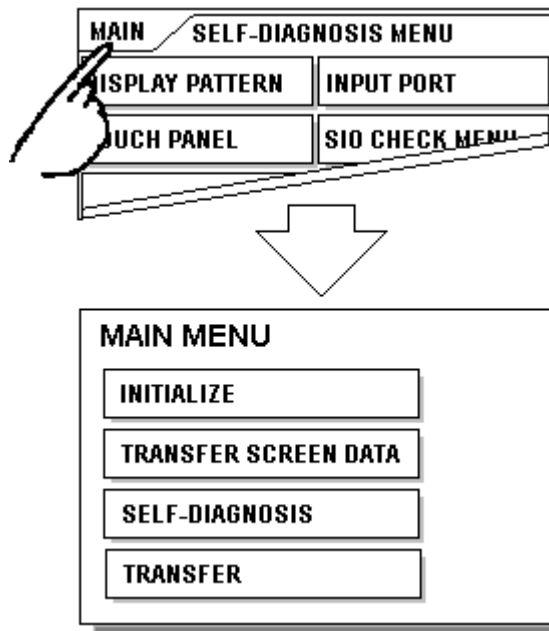

## 4.5 Transfer Screen Data

The process required to transfer screen data to the GP, or to receive data from the GP, is described here.

Link up the GP's tool connector, located at the back of the GP, with your PC's RS-232C connector using the Downloading cable.

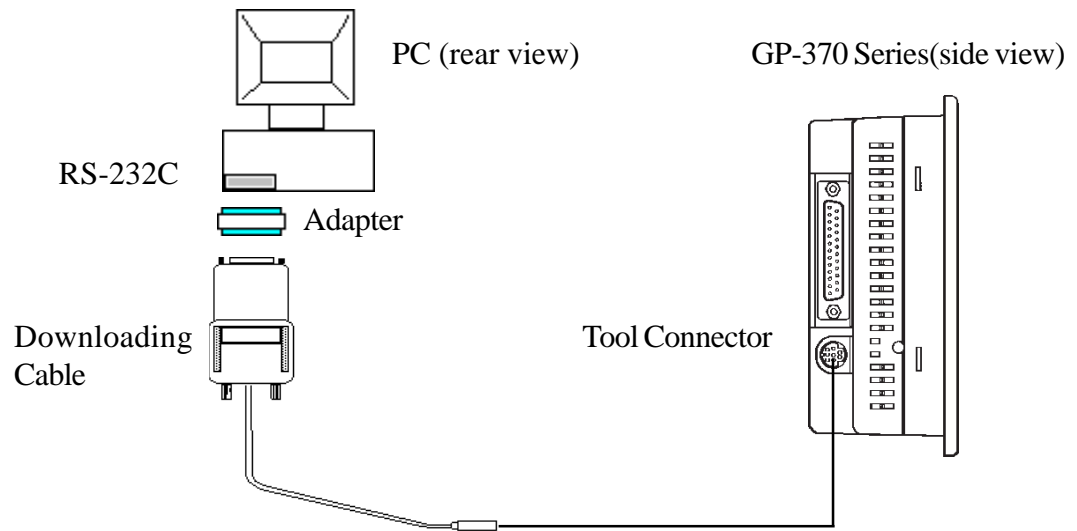



- Use an adapter to match the cable with your PC's Serial Port format.
- When using a serial mouse, use a serial port other than that of the mouse.

Prior to transmitting data, be sure to set the GP to either TRANSFER SCREEN DATA or RUN mode. Note: With a newly purchased GP, be sure it is turned ON before transmitting data.

Be sure that the GP screen editing software is set for either sending screen data to the GP, or for receiving data from the GP.

**REFERENCE →** *Software Operation Manual, 4-2 "Send to GP/Receive from GP"*

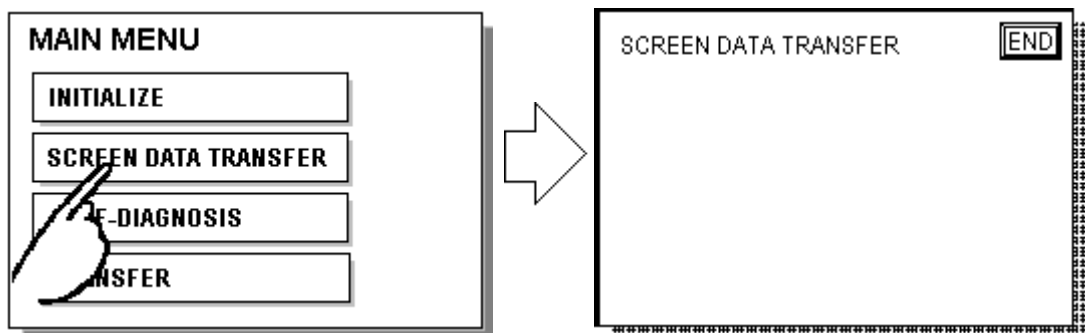

After setting up the GP, return to your screen GP, "Transferring, Please Wait". Once the message ends, transfer is complete.

Press the ESC key to return the GP to RUN mode. If a Screen File Number has been setup in GP's INITIALIZE setting, then that screen will display. If no screen number has been setup, then the GP will return to the MAIN MENU.

\*1 Setup means to download GP's system program and a PLC protocol driver, from a screen editor software, in order to run the GP in a desired environment.



# Chapter 5

## Initialize

1. Initialize Screen
2. Initialize Items
3. SYSTEM ENVIRONMENT SETUP
4. SET UP I/O
5. PLC SETUP
6. INITIALIZE MEMORY
7. SET UP TIME
8. SET UP SCREEN

### 5.1 Initialize Screen

Before running the GP unit, various GP setups must be verified. These are listed under the INITIALIZE option in the MAIN MENU.

This chapter explains each of the Off-line mode's INITIALIZE items. However, there are 2 types of INITIALIZE setups, the **1:1** connection and the **n:1** (multi-link) connection<sup>\*1</sup>, and the setup information can differ for each.

The **n:1** mark appears on menu items concerned only with the n:1 multi-link connection. If there is no mark, the menu item is common to both 1:1 and n:1 connections.

**1:1** Process concerning 1 GP connected with 1 PLC.

**n:1** Process concerning multiple GP's connected with 1 PLC. The GP's successively pass a *token* (exclusive PLC interaction key) among themselves to communicate with the PLC.



If you transfer your screen editing software's System file<sup>\*2</sup>, the GP operates using the data contained therein. If the GP System file has been correctly setup and transferred, the INITIALIZE setups become unnecessary.

For more information about System file (S0)  *Software Operation Manual*, 1.1.2 "Screen Types"

<sup>\*1</sup> PLC's that support the n:1 (multi-link) connection are limited.

 *Software PLC Connection Manual*.

<sup>\*2</sup> While "S0" is used in the case of GP-PROIII and GP-PRO/PBIII, GP-PRO/PBIII for Windows 95 uses "Settings."

## 5.2 Initialize Items

The contents of the Initialize setup items listed below are explained in this chapter. To learn about screen operations and numeric input [REFERENCE](#) Chapter 4, "Off-line Mode".

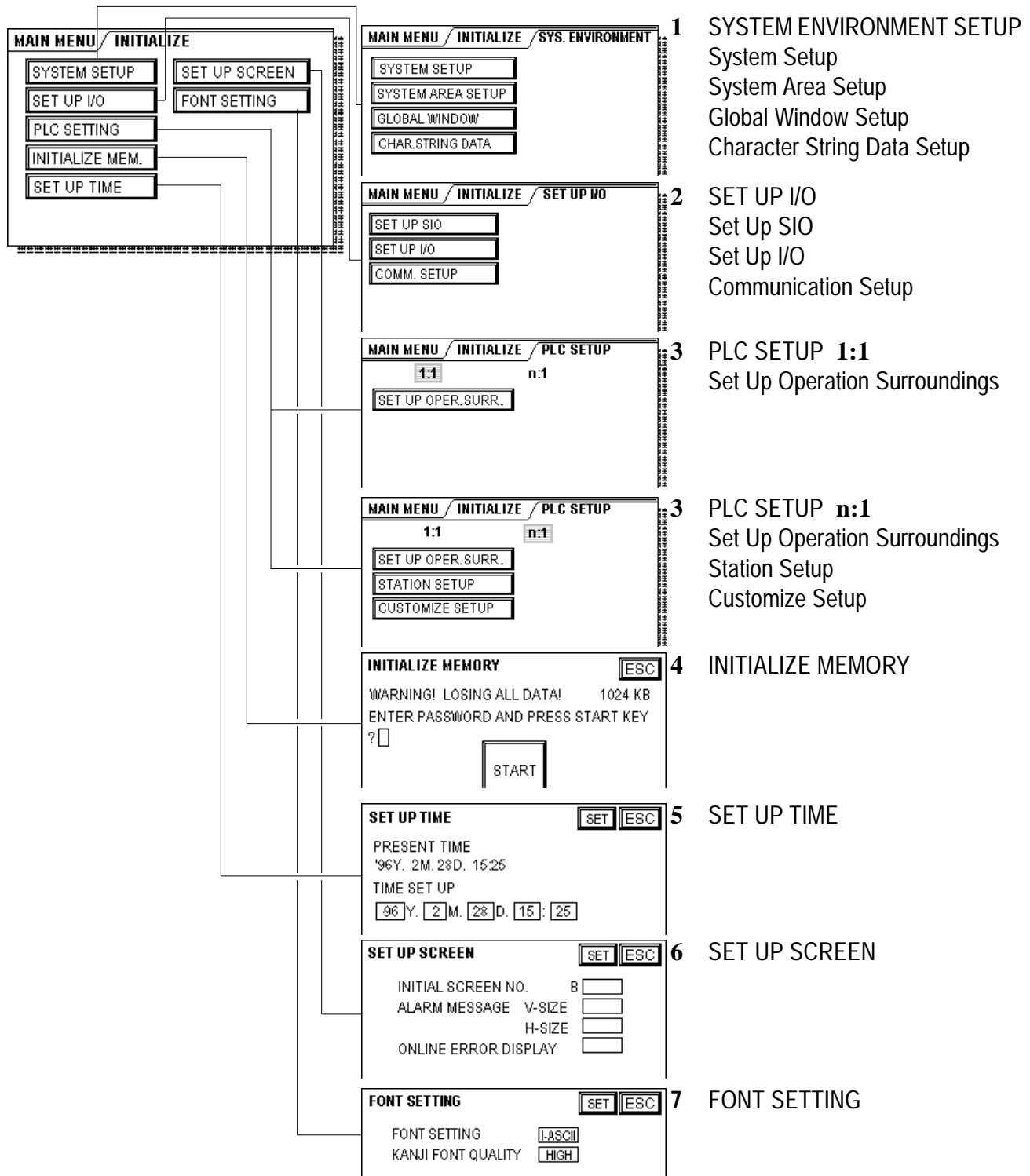

## 5.3 SYSTEM ENVIRONMENT SETUP

GP environment adjustments are made here. The SYSTEM ENVIRONMENT SETUP includes the SYSTEM SETUP, SYSTEM DATA AREA, GLOBAL WINDOW SETUP, and CHARACTER STRING DATA SETUP.

### 1. SYSTEM SETUP

| SYSTEM SET UP           |  | SET | ESC |
|-------------------------|--|-----|-----|
| STANDBY MODE TIME [MIN] |  | 0   |     |
| START TIME [SEC]        |  | 20  |     |
| TOUCH BUZZER SOUND      |  | ON  |     |
| PASSWORD SET UP         |  | 0   |     |
| DATA TYPE OF SCREEN NO. |  | BIN |     |

#### STAND-BY MODE TIME (0-255)

To protect the GP display screen, GP has been setup with a screen saver function that automatically erases the screen when no GP operations have occurred for the time entered here. A **0** entered in this field causes a normal display.

When SYSTEM DATA AREA's ( [REFERENCE →](#) *Software PLC Connection Manual*) SCREEN DISPLAY OFF\*<sup>1</sup> data is **0000h**, and the following operations are *not* performed on the screen for the number of minutes setup, the GP display erases.

- Change Screen
- Touch Screen
- Alarm Display

#### START TIME (0-255)

This setup determines the start-up time of the GP. Use this setup to adjust the power up sequence so that the GP starts up after the PLC.

#### TOUCH BUZZER SOUND

Setup whether or not the GP beeps when pressed.

#### BUZZER TERMINAL OUTPUT

Setup whether or not the *BUZZ* signal is output from GP's AUX I/F. This option is for an external buzzer.

#### PASSWORD SETUP (0-9999)

The password setting is used when changing to the Initialize Memory or Initialize (off-line mode) screens.

\*1 When using the Direct Access format or the Memory Link format, the object address becomes +9 or +12 respectively.

The password (*number*) ensures protection of the GP setups as Off-line mode will not be entered inadvertently. Enter the optional number of your choice. If you do not wish to use this setup, enter the default **0**.

## Data Type of Screen No.

This setup controls whether BIN or BCD format numbers are used when making screen changes. Screen numbers 1~8999 are available when set up in binary format; screen numbers 1~1999 are available when set up in BCD format.

## 2. SYSTEM AREA SETUP

SYSTEM AREA SETUP is necessary for the PLC to administer the GP, and prepare the PLC internal Data Memory (DM) and Data Register (D)<sup>\*1</sup>. Use this setup to prepare the desired SYSTEM DATA AREA items. When using the Memory Link format, this setting is unnecessary.

**REFERENCE →** *Software PLC Connection Manual.*

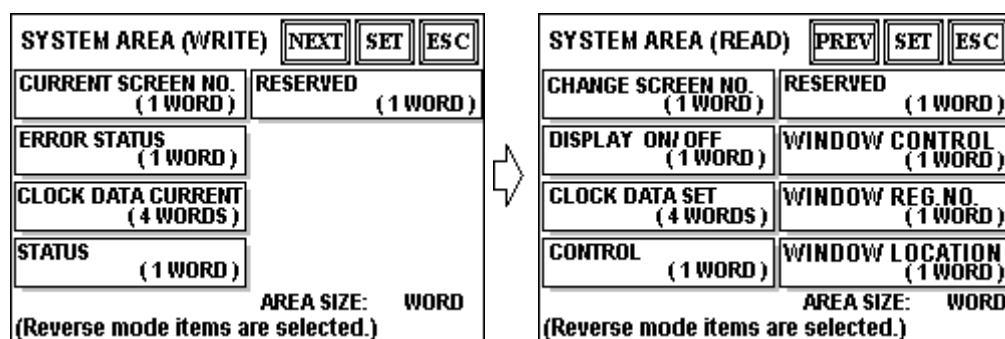

Press the **NEXT** and **PREV** buttons to toggle between the SYSTEM AREA WRITE and READ screens.

Press the item—when the item is highlighted, it is selected.

### System AREA SIZE

This field displays the size, in words, of the items selected in the SYSTEM AREA (all the WRITE and READ items).

When you press the SET key, the SYSTEM AREA CONTENTS screen appears and ratifies the selected items



- The setup shown is efficient only when using the Direct Access format.
- The selected System Area items, as displayed on the screen, become the System Data Area.

When these five items, "Current Screen Number", "Error Status", "Clock Data (Current)", "Change Screen Number", and "Display On/Off", have been selected, word addresses are assigned to each item, in order, as shown on the next page.

<sup>\*1</sup> Data Memory (DM) refers to OMRON Co.'s PLC; Data Register (D) refer to Mitsubishi Electric Co.'s PLC.

## Initialize

| SYSTEM AREA CONTENTS |                 | SET | ESC |
|----------------------|-----------------|-----|-----|
| WORD                 | WORD            |     |     |
| +0                   | CURRENT SCR.NO. | +10 |     |
| +1                   | ERROR STATUS    | +11 |     |
| +2                   | CLOCK (CURRENT) | +12 |     |
| +3                   | CLOCK (CURRENT) | +13 |     |
| +4                   | CLOCK (CURRENT) | +14 |     |
| +5                   | CLOCK (CURRENT) | +15 |     |
| +6                   | CHANGE SCR.NO.  | +16 |     |
| +7                   | DISPLAY ON/OFF  | +17 |     |
| +8                   |                 | +18 |     |
| +9                   |                 | +19 |     |



Addresses LS16 to LS19 are fixed as they control the Global Window. Other items cannot be set to these addresses.

The System Data Area selection process follows this formula [System Data Start Address + n]. For example, if the System Area Start Address was D00200, and the *Change Screen Number* option had been selected—if you refer to the System Area Contents screen displayed above—because *Change Screen Number's* address is pegged at +6, its word address would be D00200+6=D00206.

For more information on the LS area 16~19 [REFERENCE →](#) *Software PLC Connection Manual*, 1.1.2 "LS Area Structure"

### 3. GLOBAL WINDOW SETUP

The GP unit can display one *Global Window* and two *Local Windows* at any one time. The Global Window is common to all the display screens. The Local Window displays exclusively on the corresponding base screen. The GLOBAL WINDOW SETUP is described here.

| GLOBAL WINDOW SETUP |     | NEXT | SET | ESC |
|---------------------|-----|------|-----|-----|
| GLOBAL WINDOW       | USE | NEXT |     |     |

| GLOBAL WINDOW SETUP      |        | PREV | SET | ESC |
|--------------------------|--------|------|-----|-----|
| GLOBAL WINDOW ACCESS     | DIRECT |      |     |     |
| DATA FORMAT              | BIN    |      |     |     |
| REGISTRATION NO. (1-256) | 1      |      |     |     |
| LOCATION X (0-319)       | 160    |      |     |     |
| Y (0-239)                | 120    |      |     |     |

#### GLOBAL WINDOW

When first entering the Global Window, select whether to **Use**, or **Do Not Use** the Global Window. If you select **Do Not Use**, ignore the items described below. Selecting **Use** makes these options available by simply pressing the NEXT button.

#### GLOBAL WINDOW ACCESS

Setup the Global REGISTRATION NO. and the Window LOCATION as *Direct* or *Indirect* values. When set as Direct, the REGISTRATION NO. and Window LOCATION selection are fixed to the values setup here. When set to Indirect, the WINDOW REG. NO. word address as prepared in the System Area is variable—which means it can have the REGISTRATION NO. *written* to it, and as a result, multiple window screens can be used as the Global window. Adjust the Global

window position using this same method, by writing the X,Y coordinates to the SYSTEM AREA's WINDOW LOCATION word addresses.

## DATA FORMAT

Setup whether the REGISTRATION NO. and the Window LOCATION values are inputted as BIN or BCD numbers. Only Direct values can be setup in these fields.

## REGISTRATION NO. (1-256)

Setup the Window Screen Number used by the Global Window. This field is applicable only when the GLOBAL WINDOW ACCESS is set to Indirect.

## LOCATION

Setup for the Global Window LOCATION. This field is applicable only when the GLOBAL WINDOW ACCESS is set to Indirect.

## 4. CHARACTER STRING DATA SETUP

---

*Character String Data* ordering varies from manufacturer to manufacturer. Setup the *Character String Data* order here to match the corresponding PLC.



Setup the CHARACTER STRING DATA MODE to match the PLC type. Device type and Tag settings are unavailable.

Find the data storage order for your PLC in the table, next page, and setup the CHARACTER STRING DATA MODE.

- (I) Data Device Storage Order
- (II) Internal Word Byte LH/HL Storage Order
- (III) Internal Double-word Word LH/HL Storage Order

# Initialize

## CHARACTER STRING DATA MODE List

| I) Data Device Storage Order | II) Internal Word, Byte LH/HL Storage Order | III) Double-word Internal Word LH/HL Storage Order | Character String Data Mode |
|------------------------------|---|--|----------------------------|
| Storage from Start data      | LH order                                    | LH order   | <b>4</b>                   |
|                              |   | HL order   | <b>2</b>                   |
|                              | HL order                                    | LH order   | <b>5</b>                   |
|                              |   | HL order   | <b>1</b>                   |
| Storage from End Data        | LH order                                    | LH order   | <b>6</b>                   |
|                              |   | HL order   | <b>7</b>                   |
|                              | HL order                                    | LH order   | <b>8</b>                   |
|                              |   | HL order   | <b>3</b>                   |

### I) Data Device Storage Order

E.g. Characters A B C D E F G H  
                   ① ② ③ ④

#### • Storage from Start Data

|   |      |
|---|------|
| ① | D100 |
| ② | D101 |
| ③ | D102 |
| ④ | D103 |

#### • Storage from End Data

|   |      |
|---|------|
| ④ | D100 |
| ③ | D101 |
| ② | D102 |
| ① | D103 |

### II) Word Byte LH/HL Order

E.g. Characters A B C D  
                   ① ② ③ ④

#### • 16 bit Device LH Order

|   |   |      |
|---|---|------|
| ② | ① | D100 |
| ④ | ③ | D101 |

#### • 16 bit Device HL Order

|   |   |      |
|---|---|------|
| ① | ② | D100 |
| ③ | ④ | D101 |

#### • 32 bit Device LH Order

|   |   |   |   |      |
|---|---|---|---|------|
| ② | ① | ④ | ③ | D100 |
|---|---|---|---|------|

#### • 32 bit Device HL Order

|   |   |   |   |      |
|---|---|---|---|------|
| ① | ② | ③ | ④ | D100 |
|---|---|---|---|------|

**III) Double-word Word LH/HL Order**

E.g. Characters "A B C D E F G H I J"  
 ① ② ③ ④ ⑤

• 16 bit Device LH Order

|   |      |
|---|------|
| ② | D100 |
| ① | D101 |
| ④ | D102 |
| ③ | D103 |
| ⑤ | D104 |

• 16 bit Device HL Order

|   |      |
|---|------|
| ① | D100 |
| ② | D101 |
| ③ | D102 |
| ④ | D103 |
| ⑤ | D104 |

E.g. Characters "A B C D E F G H I J K L M N O P Q R S T"  
 ① ② ③ ④ ⑤ ⑥ ⑦ ⑧ ⑨ ⑩

• 32 bit Device LH Order

|   |   |      |
|---|---|------|
| ② | ① | D100 |
| ④ | ③ | D101 |
| ⑥ | ⑤ | D102 |
| ⑧ | ⑦ | D103 |
| ⑩ | ⑨ | D104 |

• 32 bit Device HL Order

|   |   |      |
|---|---|------|
| ① | ② | D100 |
| ③ | ④ | D101 |
| ⑤ | ⑥ | D102 |
| ⑦ | ⑧ | D103 |
| ⑨ | ⑩ | D104 |

**Relationship between K-tag Write Character Value and PLC Device**

• 16 bit Device

GP stores the character string from the start, as groups of 2, into 1 PLC Device.

When there are nine characters, they are arranged as shown below.

1 2 3 4 5 6 7 8 9 NULL  
 └─┘ └─┘ └─┘ └─┘ └─┘



When the characters do not divide into 2 evenly, NULL is added.

• 32 bit Device

GP stores the character string from the start, as groups of 4, into 1 PLC Device.

When there are nine characters, they are arranged as shown below.

1 2 3 4 5 6 7 8 9 NULL  
 └─┘ └─┘ └─┘



When the characters do not divide into 4 evenly, NULL is added.



## 5.4 SET UP I/O

This section describes the communication setup with the host PLC and the setup for any peripheral equipment. The SET UP I/O menu includes the SET UP SIO, SET UP I/O, and COMMUNICATION SETUP menus.

### 1. SET UP SIO

This menu runs the setups related to PLC communication. Match the settings listed below with the SIO setup on the PLC host side.

|                         |          |     |
|-------------------------|----------|-----|
| SET UP SIO              | SET      | ESC |
| COMMUNICATION RATE      | 9600     |     |
| DATA LENGTH             | 8 / 1    |     |
| PARITY                  | OFF      |     |
| CONTROL                 | ER-CNTRL |     |
| COMMUNICATION INTERFACE | 4 LINE   |     |

#### COMMUNICATION RATE

The COMMUNICATION RATE (baud rate) is the data communication speed, measured in bits per second (bps), between the GP and PLC. Match the COMMUNICATION RATE values in both the PLC and GP.

#### DATA LENGTH

For data communications, the DATA LENGTH (the first numeral) must be set up as 7-bit or 8-bit data. The second value is the STOP BIT, which must be set up as either 1-bit or 2-bit.

#### PARITY

Set up whether no parity check, or an odd or even number parity check will take place during communication.

#### CONTROL

Data flow CONTROL prevents the overflow of data sent back and forth. Select either X-CNTRL or ER-CNTRL.

#### COMMUNICATION FORMAT

Select one of the following options for the communication format: RS-232C, RS-422 4 line, or RS-422 2 line.



When communicating with the Memory Link format using RS-422, select the 4-line option.

## 2. SET UP I/O

Touch operation and Force Reset setup, and Display Device adjustments are made here.

| SET UP I/O           |          | SET | ESC |
|----------------------|----------|-----|-----|
| TOUCH OPERATION MODE | 2 Points |     |     |
| SYSTEM RESET MODE    | ON       |     |     |
| CONTRAST SETTING     | ON       |     |     |
| BRIGHTNESS SETTING   | ON       |     |     |
| LCD SETTING          | NORMAL   |     |     |

### TOUCH OPERATION MODE

Set up either One Point or Two Point input.

### FORCE RESET

Set up whether or not a FORCE RESET operation is in effect.

#### Steps to run FORCE RESET

While holding down the bottom right corner (1) of the screen, press the upper right corner (2). At the same time, press the bottom left corner (3) to enter the FORCE RESET Operation. To activate Reset, press the **RESET** button; to transfer to Off-line Mode, press **OFFLINE**.

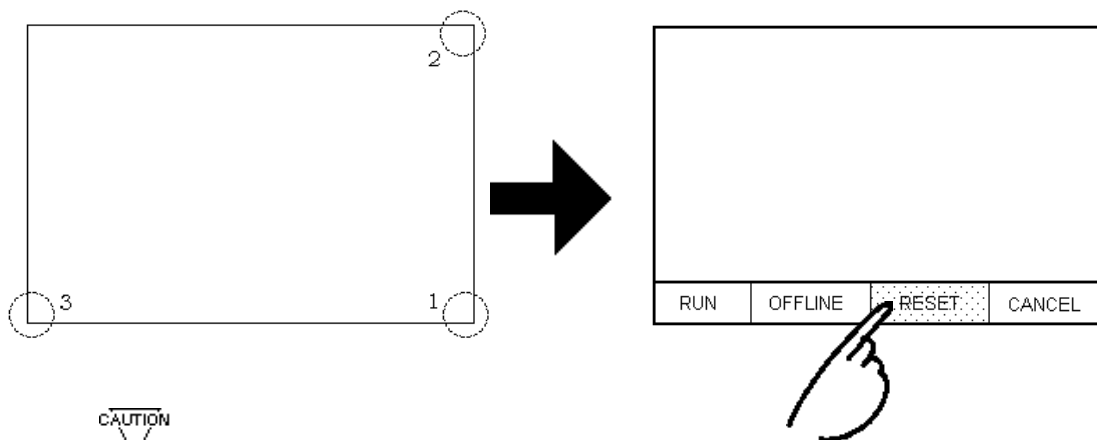

- FORCE RESET occurs even during RUN mode and Off-line mode.
- The FORCE RESET mode cannot be entered while waiting for the GP to start.
- Entering FORCE RESET is possible even when RUN operations (PLC <—>GP communication) do not occur.

## Initialize

### CONTRAST ADJUSTMENT

When this option is set On, CONTRAST ADJUSTMENTS can be made through touch input.

While pressing the upper right hand corner (1) of the screen, press the upper left corner (2) to enter CONTRAST ADJUSTMENT mode. Press the desired setting and the screen's contrast will change accordingly.

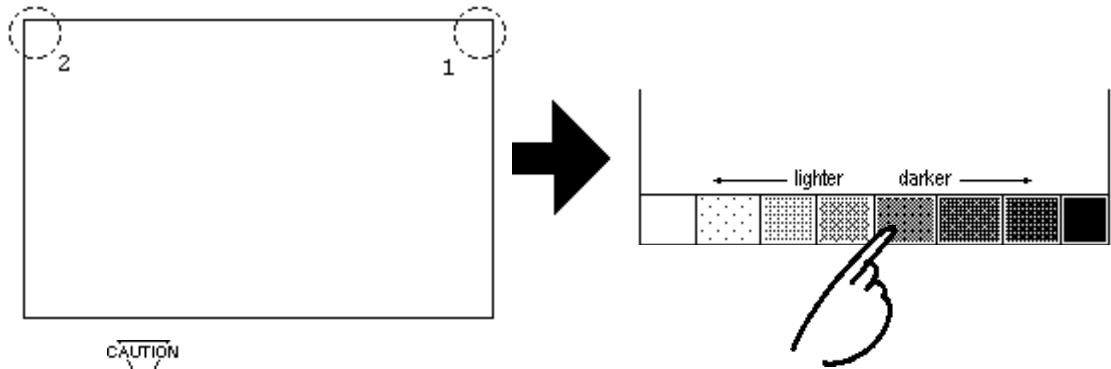

- For the GP370-LG\*\* models, the lighter and darker settings are on the opposite side.



- To exit CONTRAST ADJUSTMENT mode, press anywhere outside the contrast option bar.
- CONTRAST ADJUSTMENT mode cannot be entered while waiting for GP to start.
- CONTRAST ADJUSTMENTS can be made even in the middle of RUN mode (PLC<—>GP communication).

### BRIGHTNESS SETTING

When this is set to ON, brightness can be changed by simply touching the screen.

For example, press the lower right (1) and lower left corners (2) of the screen simultaneously to enable the Brightness Setting mode. In this mode, touching the bottom left of the screen increases the brightness, and touching the bottom right side decreases the brightness. (See the figure below)

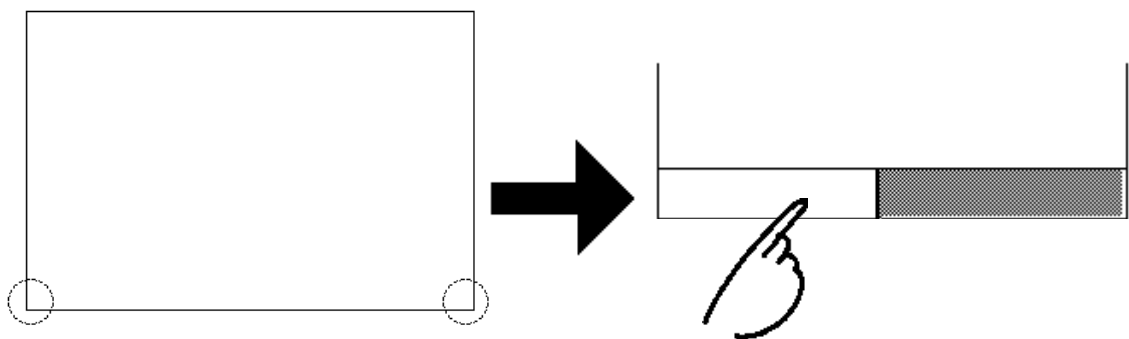



- This mode cannot be enabled or used while the GP is starting up.
- This mode can be used even while the GP is running (i.e. while data is being transmitted to and from the PLC).

## LCD SETTING (Only for GP-370LG\*\*)

There are two options: REVERSE and NORMAL. When set to REVERSE, the screen lighting becomes inverted.

Press the LCD SETTING item to change it from NORMAL to REVERSE, then press the SET button. The screen display reverses and returns to the previous screen.

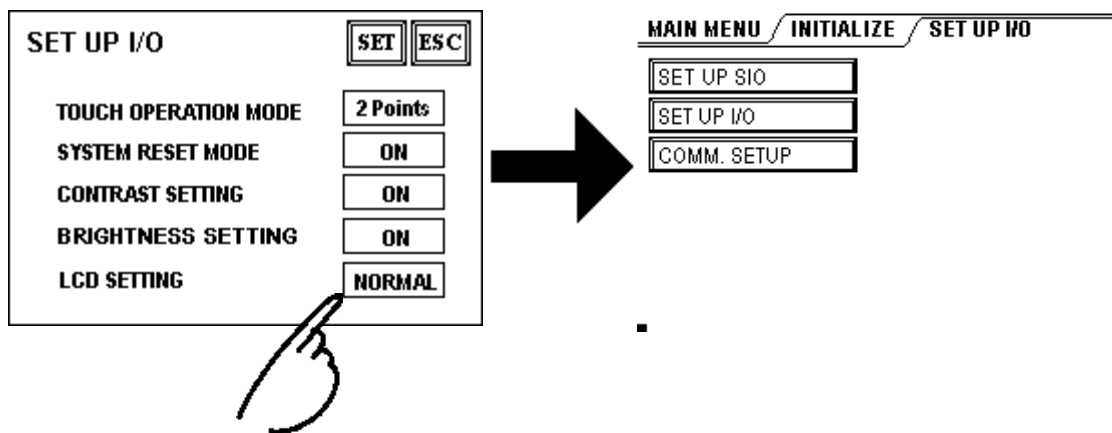

## 3. COMMUNICATION SETUP

These fields set *when* an error message is reported, after a GP $\longleftrightarrow$ PLC communication error is detected. This ensures an error has actually taken place and not just slight breaks in communication or slowness in processing data on one side or the other.

| COMMUNICATION SETUP       |    | SET | ESC |
|---------------------------|----|-----|-----|
| RECEIVE TIMEOUT ( 1~127 ) | 10 | sec |     |
| RETRY COUNT ( 0~255 )     | 2  |     |     |

### RECEIVE TIMEOUT

Set up how long the GP unit will wait when there is nothing being sent to it. (This is the *Timeout Time*.) However, if there is no cable connected up, then regardless of the time set up here, the Timeout value would be 1 second. The default value is 10 seconds.

## Initialize



When a value of over 30 seconds is set here, and a screen is transferred from the PC while a PLC Communication Time error has occurred, an error may also appear on the PC side.

### RETRY COUNT

Set up the number of times the GP will try to send data when a Communication error occurs. The default value is 2 times.

## 5.5 PLC SETUP

Setup the System Area and the Unit number on this screen. Because 1:1 and n:1 GP connections change the setup contents, check it before running any setups.



With the GP-PRO/PBIII for Windows95 "Simulation" feature, the GP's "Setup Operation Surroundings" area cannot be used.

### 1. SET UP OPERATION SURROUNDINGS (1:1)

Setup the PLC System Data Area and the Unit Number here.



This setup is only necessary when using the Direct Access format.

| SET UP OPERATION SURROUNDINGS |   | SET | ESC |
|-------------------------------|---|-----|-----|
| SYSTEM AREA START DEV         | D |     |     |
| START ADR                     | 0 |     |     |
| UNIT NO.                      | 0 |     |     |
| SYSTEM AREA READ SIZE         | 0 |     |     |

#### SYSTEM AREA STARTING DEVICE / STARTING ADDRESS

Setup the PLC's Data Register (D), Data Memory (DM), etc. allotted by the SYSTEM AREA STARTING ADDRESS. (The START DEV display changes with different PLC's.)

#### UNIT NO.

Set up the PLC UNIT number here. Make sure it matches the one set up in the PLC.

#### SYSTEM AREA READ SIZE

When using a Block Display Trend Graph, setup the Reading Area Size (in word units) to match the Trend Graph's data size. Set this up when you wish to allocate the Reading Area in the PLC Data Register (D), or Data Memory (DM).



- If you are not using the Reading Area, leave the **0** default values intact. High Speed Communications can be secured as a result.
- When using Hitachi's HIDIC-S10  $\alpha$  Series, an extra item titled "Extended Memory Address (HIDIC) [000000]" is added to the above screen display. Values accepted by the extended memory start address are **0** (memory not extended), and **100000~1FF000**.



- When using Matsushita Electric's NEWNET-FP, an extra item titled "Monitor Register" is added to the screen display. If using 2 or more CCU's (communication unit) as in the following diagram, and a GP is connected to each CCU, select the 1:1 connection and setup the Monitor Register as "None".

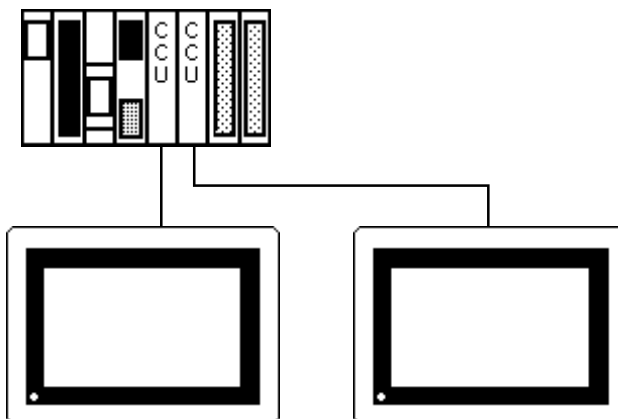

- When connecting only one GP (to a PLC), be sure to set the Monitor Register to ON.

## 2. SET UP OPERATION SURROUNDINGS (n:1)

This is the setup for the PLC System Data Area and the Unit Number for an n:1 (multi-link) PLC connection. For more about the SYSTEM DATA AREA with the n:1 (multi-link) connection, [REFERENCE → Software PLC Connection Manual](#).



This setup is only necessary when using the Direct Access format.

| SET UP OPERATION SURROUNDINGS |  | SET | ESC |
|-------------------------------|--|-----|-----|
| SYSTEM AREA START DEV         |  | D   |     |
| START ADR                     |  | 0   |     |
| UNIT NO.                      |  | 0   |     |
| SYSTEM AREA READ SIZE         |  | 0   |     |

# Initialize

## SYSTEM AREA STARTING DEVICE / STARTING ADDRESS

Setup the PLC's Data Register (D), Data Memory (DM), etc. allotted by the SYSTEM AREA STARTING ADDRESS.

## UNIT NO.

Set up the PLC UNIT number here. Make sure it matches the one set up in the PLC.

## SYSTEM AREA READ SIZE

When using a Block Display Trend Graph, setup the Reading Area Size (in word units) to match the Trend Graph's data size. Set this up when you wish to allocate the Reading Area in the PLC Data Register (D), or Data Memory (DM).



- If you are *not* using the Reading Area, leave the **0** default values intact. High Speed Communications can be secured as a result.

## 3. STATION SETUP (n:1)

---

The STATION SETUP, necessary for the n:1 (multi-link) setup, checks whether correct communications run with the connected GP System configuration.

| STATION SETUP           |   | SET | ESC |
|-------------------------|---|-----|-----|
| NETWORK INFORMATION DEV | D |     |     |
| INFORMATION ADR         | 1 |     |     |
| STATION NO. (0-15)      | 0 |     |     |

## NETWORK INFORMATION DEVICE / INFORMATION ADDRESS

In the n:1 (multi-link) connection, the Network Information uses 2 words in its correspondences. These 2 words are the *Connection* part and the *Validation* part (described later in this section). Allocate these respective areas into the PLC's Data Register (D) or Data Memory (DM).

PLC Data Register

|    |                 |          |
|----|-----------------|----------|
| +0 | CONNECTION PART | PLC-->GP |
| +1 | VALIDATION PART | GP-->PLC |



In the NETWORK INFORMATION ADDRESS, setup all the GP's connected to the same link unit with the same address. Furthermore, when there are 2 ports in the connected link unit, do not make these use the same address.

## • Connection Part

The word address for the Connection Part sets up the number of GP's connected to the PLC, registered beforehand on the PLC side. When these GP's are connected to the PLC, the corresponding PLC bit numbers for the particular GP Stations (see bottom) turn on.



When the GP is connected to the PLC, and the option of GP only correspondence ends and Offline mode is entered, the GP Station Number turns the corresponding PLC bit off.

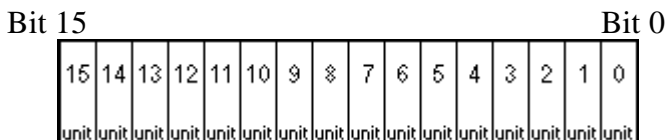

For example, when these 4 GP units—bit 0, bit 2, bit 3, bit 5—are connected, 002D (h) is written here.

Connection Part 

|   |   |   |   |   |   |   |   |   |   |   |   |   |   |   |   |   |   |   |   |   |   |
|---|---|---|---|---|---|---|---|---|---|---|---|---|---|---|---|---|---|---|---|---|---|
| 0 | 0 | 0 | 0 | 0 | 0 | 0 | 0 | 0 | 0 | 0 | 0 | 0 | 0 | 0 | 0 | 1 | 0 | 1 | 1 | 0 | 1 |
|---|---|---|---|---|---|---|---|---|---|---|---|---|---|---|---|---|---|---|---|---|---|

 002D (h)



- Be certain to setup before running.
- Turn bits *not* connected to the GP off.

## • Verification Part

This area responds to the correspondence from each connected GP. When the same bit numbers as the Connection Part turn On, the correspondence is accepted by the Verification Part. In turn, the Station Numbers of the communicating GPs turn their corresponding PLC bit number on.



If the correspondence between the GP and PLC is correct, the same value as in the Connection Part writes to the Verification Part.

For example, the value 002D (h) in the Connection Part, setup as the 0 bit, 2 bit, 3 bit, and 5 bit, writes to the Verification Part as shown below.

Connection Part 

|   |   |   |   |   |   |   |   |   |   |   |   |   |   |   |   |   |   |   |   |   |   |
|---|---|---|---|---|---|---|---|---|---|---|---|---|---|---|---|---|---|---|---|---|---|
| 0 | 0 | 0 | 0 | 0 | 0 | 0 | 0 | 0 | 0 | 0 | 0 | 0 | 0 | 0 | 0 | 1 | 0 | 1 | 1 | 0 | 1 |
|---|---|---|---|---|---|---|---|---|---|---|---|---|---|---|---|---|---|---|---|---|---|

 002D (h)

Verification Part 

|   |   |   |   |   |   |   |   |   |   |   |   |   |   |   |   |   |   |   |   |   |   |
|---|---|---|---|---|---|---|---|---|---|---|---|---|---|---|---|---|---|---|---|---|---|
| 0 | 0 | 0 | 0 | 0 | 0 | 0 | 0 | 0 | 0 | 0 | 0 | 0 | 0 | 0 | 0 | 1 | 0 | 1 | 1 | 0 | 1 |
|---|---|---|---|---|---|---|---|---|---|---|---|---|---|---|---|---|---|---|---|---|---|

 002D (h)



- When the Connection Part and Verification Part do not match, a COMMUNICATION ERROR occurs. Check the setup again.
- When changing the connection, first turn all the bits Off.
- Even if the GP is connected, if the Connection Part List is turned off, data transfer cannot occur, and an error will not display.



## Initialize

### STATION NO.

This is the setup for the number of GP Stations in use, as mentioned in the above section. The setup range is from 0 to 15, and the only other restriction is each GP STATION NO. must be unique in the system. If STATION NO.'s are repeated, a COMMUNICATION ERROR occurs.



- The STATION NO. is the number allocated to the particular GP unit. This number is not related to the Link Unit Machine number.

## 4. CUSTOMIZE SETUP

The Customize function alters the n:1 (multi-link) connection's communication to make it more effective. To run communication efficiently, determine whether to use Operation or Display priority with your GP. As a result, the communication response speed can be upgraded, although the speed changes with the screen information.

| CUSTOMIZE SETUP     |  | SET  | ESC     |
|---------------------|--|------|---------|
| PLC PRIORITY        |  | OPE. |         |
| GP TOUCH MONOPOLIZE |  | OFF  |         |
| MONOPOLIZE TIME     |  | 0    | *10 sec |

### PLC PRIORITY

According to how the GP is used, select either Operation priority (OPE.) or Display priority.

- Display

Setup the GP to this option when using the GP mainly as a monitor screen. The GP will command a higher display speed as a result; however, the response time for the touch panel's operations will slow.

- Operation

Setup the GP to this option when using the GP mainly as an operation panel. As a result, the GP will command better touch panel numeric input and switch response times.

Leaving the GP in this mode does not influence the touch panel operation response time of the rest of the GP's very much; however, the screen display renewal cycle will slow down



- In a basic setup, run the same setup for all connected GP's.
- To increase the display speed, restrict addresses used to consecutive addresses wherever possible. And make bit addresses consecutive to the word unit.

## • Display Priority and Operation Priority Speed Difference

When using the Mitsubishi Electric Corp. A3A PLC, with a scan time of 20ms with consecutive addresses (80 words not included in the System Area), the difference in speed when reading is as shown in the following graphs.

Display Priority and Operation Priority Speed Difference

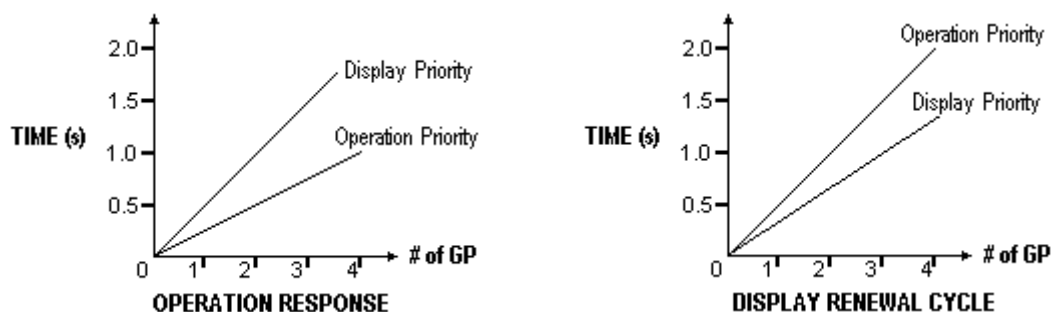

## GP TOUCH MONOPOLIZE

The monopolizing of touch panel use can be set On or Off. When you want to use the PLC exclusively with a Momentary operation setup on the touch panel ([REFERENCE → Software PLC Connection Manual](#)), 4.5 "About PLC Monopolize", turn GP TOUCH MONOPOLIZE on.

When this setup is on, the touch panel uses the PLC exclusively whenever the momentary operation setup on the panel is pressed. In this way, you can use the inching operation with a momentary switch. When you stop pressing the panel, exclusive use ends.

## MONOPOLIZE TIME (0~2550s)

This field controls the length of time for the monopolize procedure when no other touch panel operations are performed. The Monopolize process begins when the System Data Area's 7th bit of word address LS14 turns on, and ends either when the bit turns off, or when the time set here passes.



- Pressing the touch panel in the middle of the monopolize process interrupts the MONOPOLIZE TIME function, ending exclusive use.
- When MONOPOLIZE TIME is set to **0**, the monopolize function does not end automatically.

For more about the contents of System Data Area LS6 (status) and LS14 (control) ([REFERENCE → Software PLC Connection Manual](#)), "Contents and Range of System Area (Direct Access Communication)" and "Contents and Range of System Data Area (Memory Link Communication)".

# Initialize

## 5.6 INITIALIZE MEMORY

This command erases all the GP screen data.





- You cannot cancel the Initialization procedure after pressing the Start key.
- Initialization does not erase the SYSTEM SET UP, the SIO protocol, nor the internal clock setups.

INITIALIZE INTERNAL MEMORY 

WARNING: PREVIOUS DATA WILL BE  
OVERWRITTEN!

ENTER PASSWORD AND PRESS  
START KEY ?





To initialize the GP internal memory, enter the common password **1101**, or the password entered in the SYSTEM SET UP screen. For more information about How to Input Number  Chapter 4, "Input Number"



Initialization takes 10 to 20 seconds.

## 5.7 SET UP TIME

SET UP TIME  

PRESENT TIME  
'95 Y 1 M 15 D 22:16

TIME SET UP  
'  95 Y  1 M  15 D  22 :  16

Set up the internal timepiece of the GP. Make date and time corrections in the TIME SET UP fields.



The time—displayed on the screen using the Time Display function—is not completely accurate. At room temperature, the GP internal clock has an accuracy of +/- 40 seconds/month. The surrounding temperature and age of the unit can decrease the accuracy to +65 ~ -350 seconds/month. However, the screen Time displays only up to the minute.

**5.8 SET UP SCREEN**

The initial screen display upon powering up, the alarm character size, and other related items are setup here.

|                             |               |                                 |            |
|-----------------------------|---------------|---------------------------------|------------|
| <b>SET UP SCREEN</b>        |               | <b>SET</b>                      | <b>ESC</b> |
| <b>INITIAL SCREEN NO.</b>   | <b>B</b>      | <input type="text" value="1"/>  |            |
| <b>ALARM MESSAGE V SIZE</b> |               | <input type="text" value="1"/>  |            |
|                             | <b>H SIZE</b> | <input type="text" value="1"/>  |            |
| <b>ONLINE ERROR DISPLAY</b> |               | <input type="text" value="ON"/> |            |

**INITIAL SCREEN NO.**

Set up the screen file number that will first display upon powering up. If the BIN option for DATA TYPE OF SCREEN NO in SYSTEM SET UP had been selected, enter a number between 1~8999. Or, if BCD was the option set up, then input a number between 1~1999.

**ALARM MESSAGE**

Set up the size of the letters of the ALARM MESSAGE.

1

Height=1; Width=1  
16×8 pixels

2

Height=2; Width=2  
32×16 pixels

4

Height=4; Width=4  
64×32 pixels

**ON-LINE ERROR DISPLAY**

Set up whether or not error messages display during RUN mode.

## 5.9 FONT SETTING

|                    |  |         |     |
|--------------------|--|---------|-----|
| FONT SETTING       |  | SET     | ESC |
| FONT SETTING       |  | I-ASCII |     |
| KANJI FONT QUALITY |  | HIGH    |     |

### FONT SETTING

Select the character font used by the GP during RUN mode. ASCII, Korea, Taiwan, China, and Japan are the font character options available.

### KANJI FONT QUALITY

When the kanji character quality is set to HIGH, larger than full sized 2×2 multiplied characters display as 32 dot characters. When STANDARD is selected, the display becomes a multiplied 16 dot font .



- This setting is only applicable when the FONT SETTING is JAPAN.
- When set to the HIGH quality setting, the Level 1 JIS Kanji Code standard is the object. Level 2 standard characters, no matter what the setting, display as 16 dots.



## Chapter 6

# RUN and Errors

1. RUN
2. Troubleshooting
3. SELF-DIAGNOSIS

This chapter describes the GP RUN and problem solving processes.

### 6.1 RUN

There are two ways of entering RUN mode, from powering up and from Off-line mode.

#### 1. Powering Up

Activate the GP unit. After the unit has powered up, the START TIME value—set up in INITIALIZE/ SYSTEM SET UP—determines how long the display, illustrated below, appears, until it gives way to the screen number setup in the INITIALIZE/ SET UP SCREEN menu. However, if a screen has not been set up, then the display below will remain.

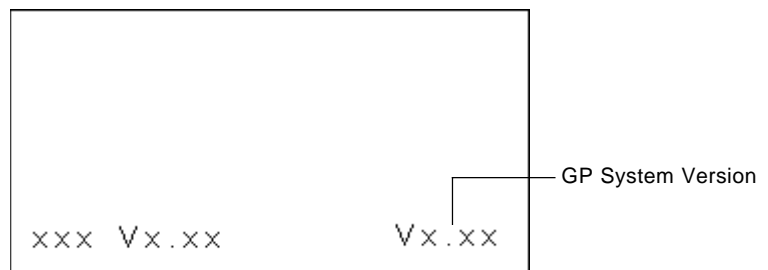

Memory Upload is not possible for GP System Versions 1.20 and higher.

#### 2. Off-line Mode

Press Off-line mode's MAIN MENU item number 4, RUN. The INITIALIZE/ SET UP SCREEN option determines the first screen that appears in RUN mode, thereby beginning communication with the PLC. However, if a screen has not been set up, then the display above remains.

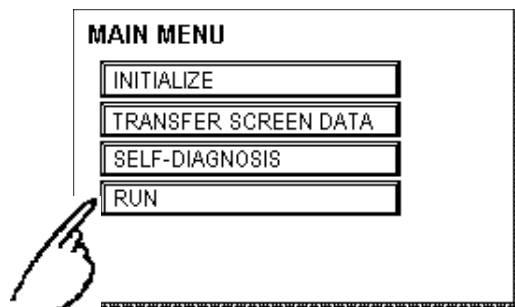



Press the top left corner within 10 seconds of starting RUN to enter Off-line Mode.

E.g. After powering up, the initial Screen is equipped with a Switch in the top left corner. If this Switch is pressed within 10 seconds, it changes the GP status from RUN mode to Off-line mode.

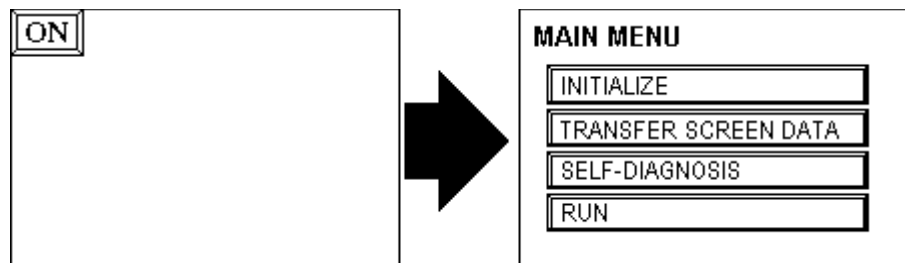

## 6.2 Troubleshooting

This section describes how to find and resolve problems that may occur on the GP. If there is a problem on the PLC side, refer to the corresponding PLC manual.

### 1. Troubles

Shown below are some problems that may occur while using this unit.

(1) No Display

The screen will not display even when the unit is powered On. Also, during RUN mode, the screen disappears.

(2) No Communication

The GP unit cannot extract data from the host. An error message may appear on the screen as a result. For more about error messages, refer to the section in this chapter titled, "Error Messages".

(3) Touch Panels Do Not Function

The touch panel does not react when pressed, or the reaction time is very slow.

(4) Off-line displays During RUN Mode.

For the first three problems, see the *flowcharts* listed on the following pages.

For the last problem, a SYSTEM ERROR may have developed while displaying the Off-line mode screen. Refer to Chapter 6.4, "Error Messages—Details".



## Run & Errors

However, this is not a problem when having entered Off-line mode by pressing the top left corner within ten seconds of powering up.



### Before Operating

- Because of the danger of electric shocks, make sure the power is *not* supplied before wiring the unit.
- When changing the backlight, there is the danger of electric shocks and burns, so be sure to use gloves when working on the unit.



This section assumes that the cause of any problems comes from the GP, and not from the host. When the host PLC is the problem, refer to the corresponding PLC manual.

**2. No Display**

Follow the flowchart below when the screen does not display when powering up, or the screen turns Off by itself during RUN mode, to find an appropriate solution.

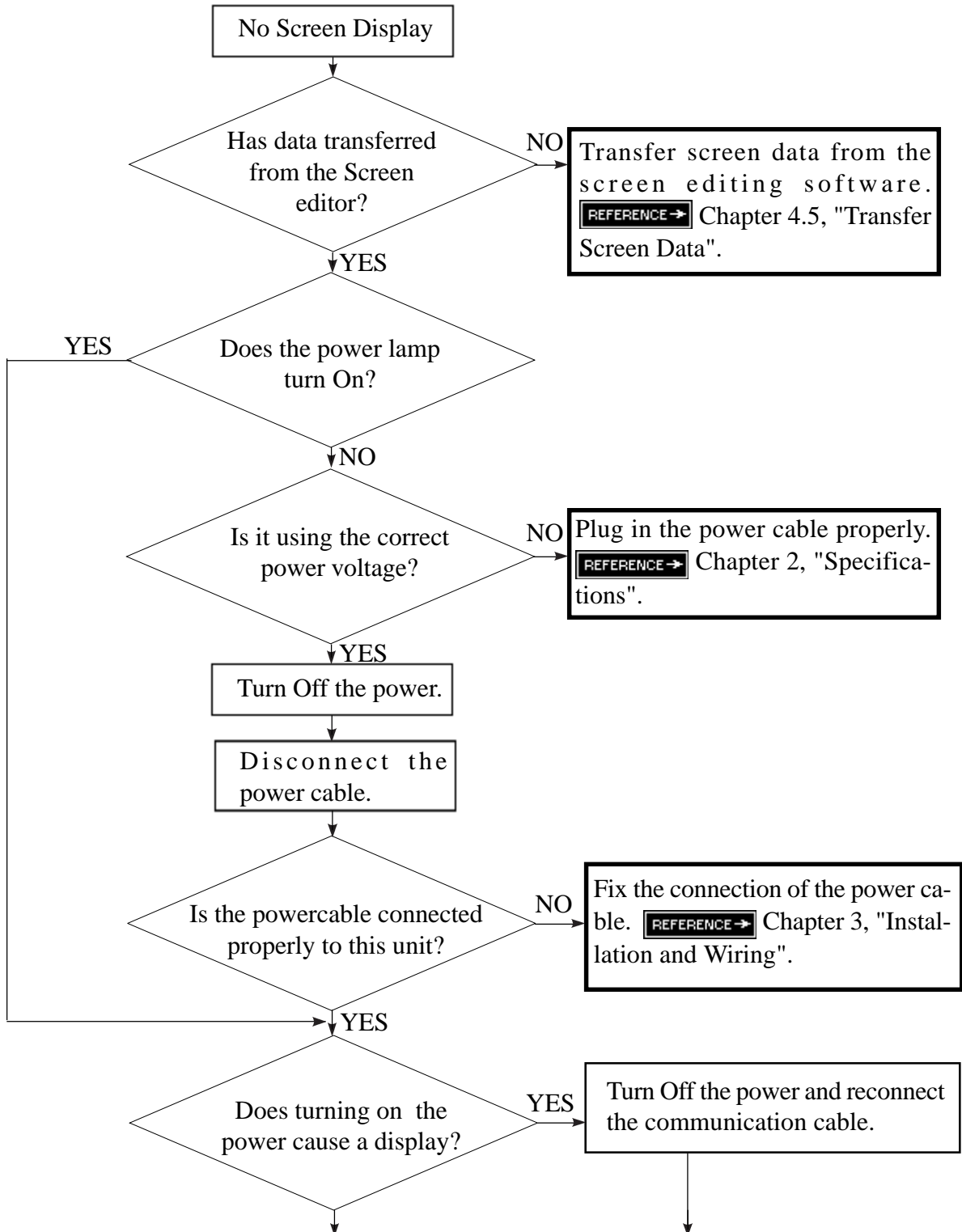

## Run & Errors

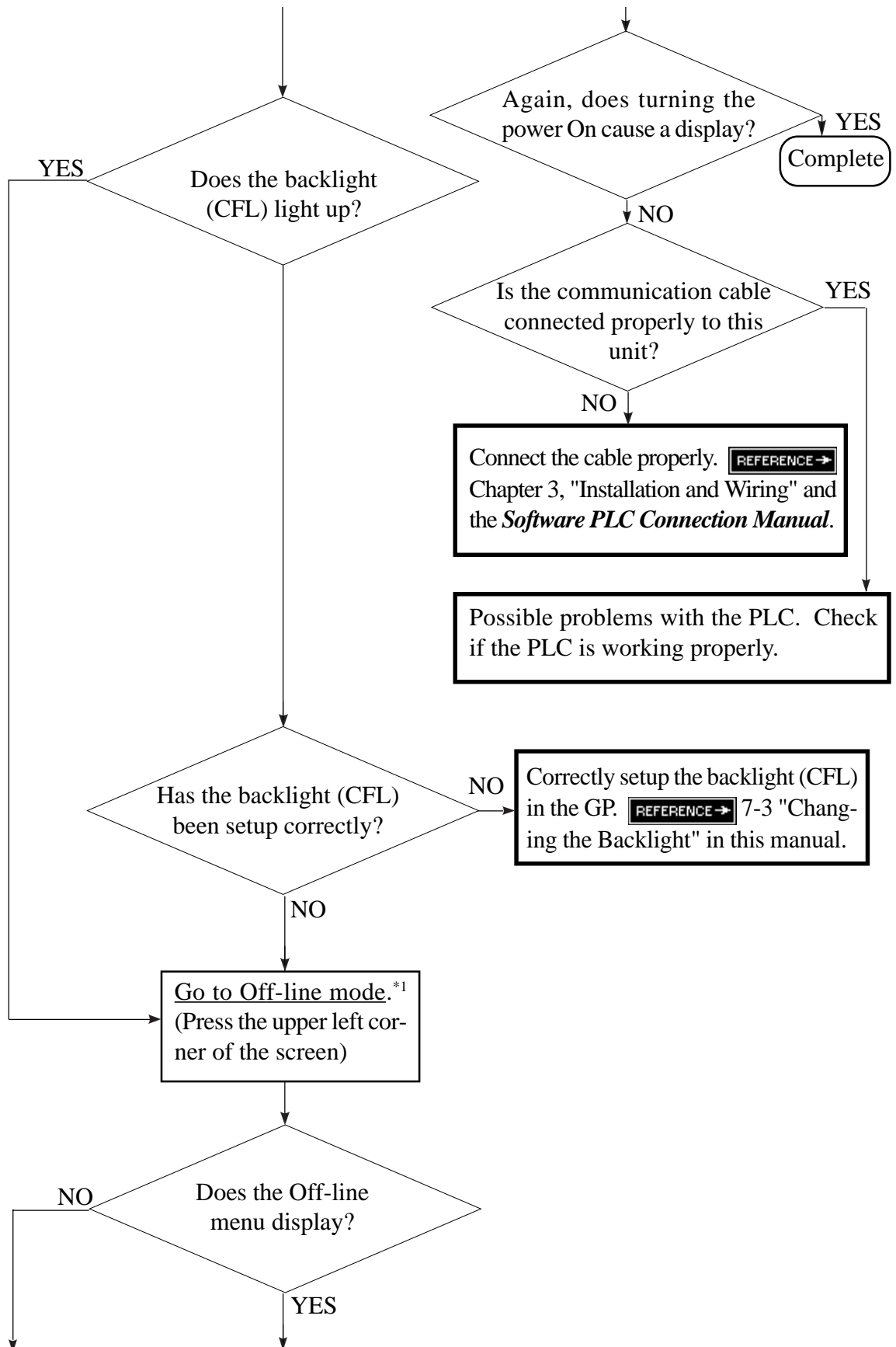

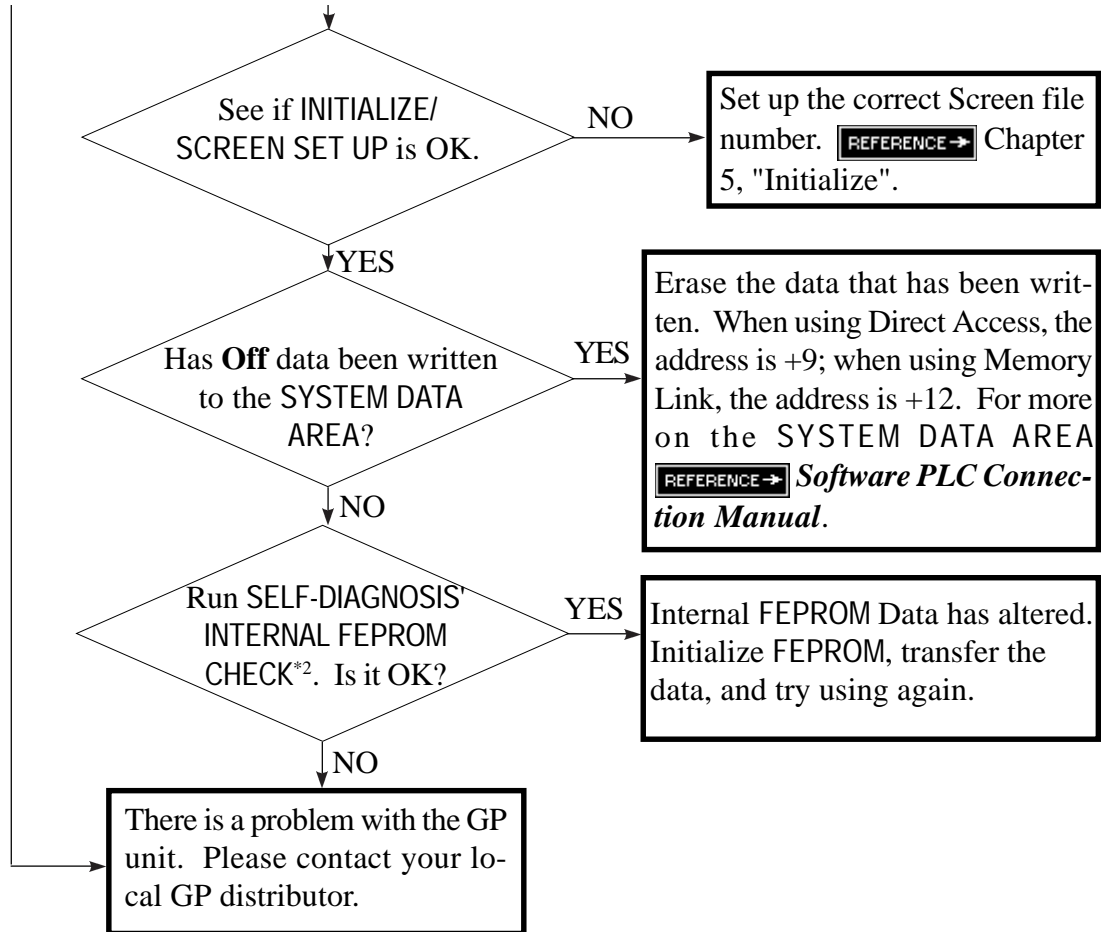

\*1 To make the Off-line screen appear, turn the power Off, then back On, and press the upper left corner of the screen within 10 seconds.

\*2 When you run the FEPROM CHECK in SELF-DIAGNOSIS, *all* the screen data gets erased. Be sure to make a backup of all the screens.

## 3. Would Not Communicate

When the GP will not communicate with the host PLC, follow the flowchart below to discover the origin of the problem and find a suitable response.

Or, if an error message displays on the screen, check the error code—[REFERENCE →](#) *Error Message* section in this chapter—to find the appropriate solution.

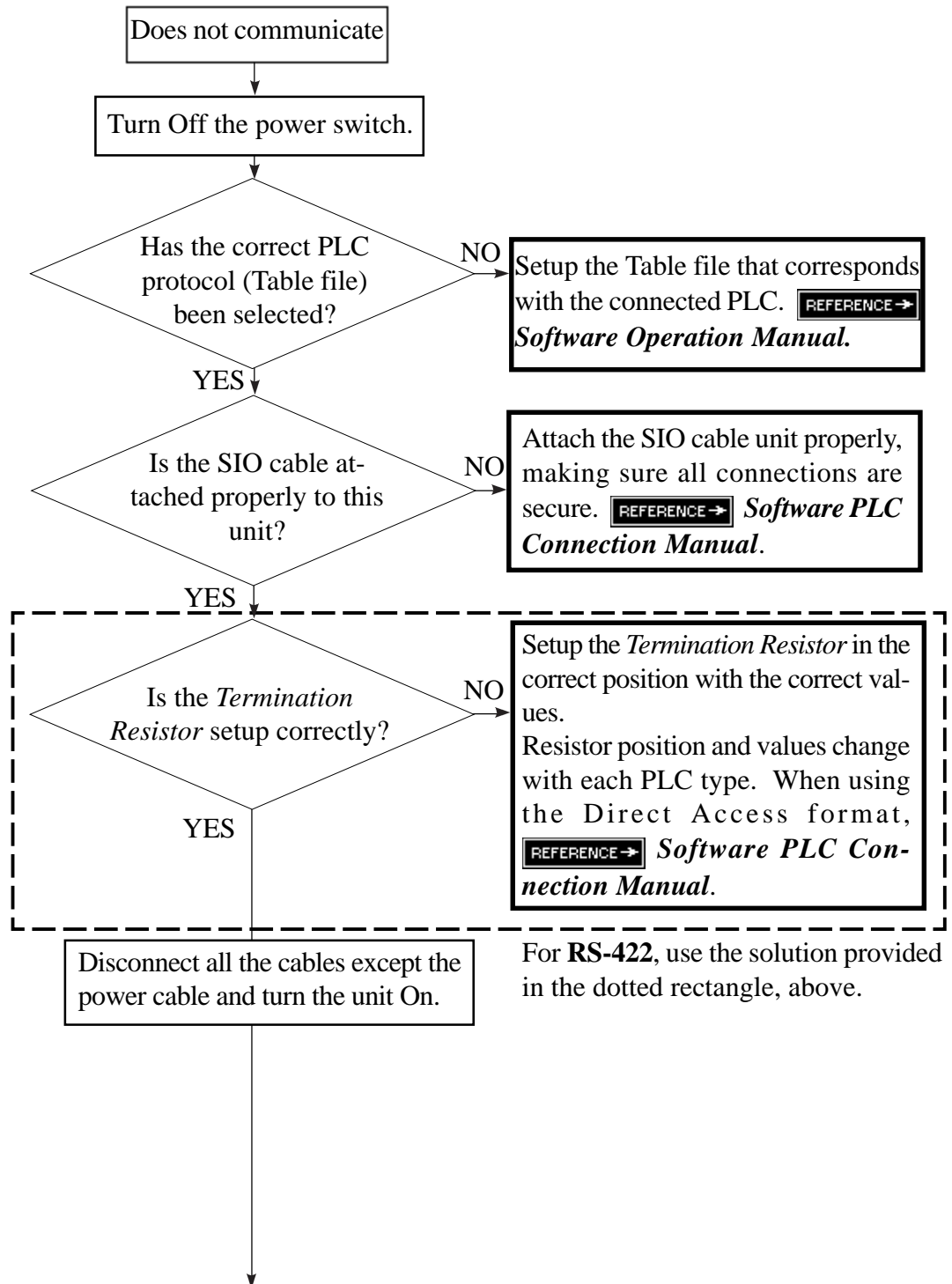

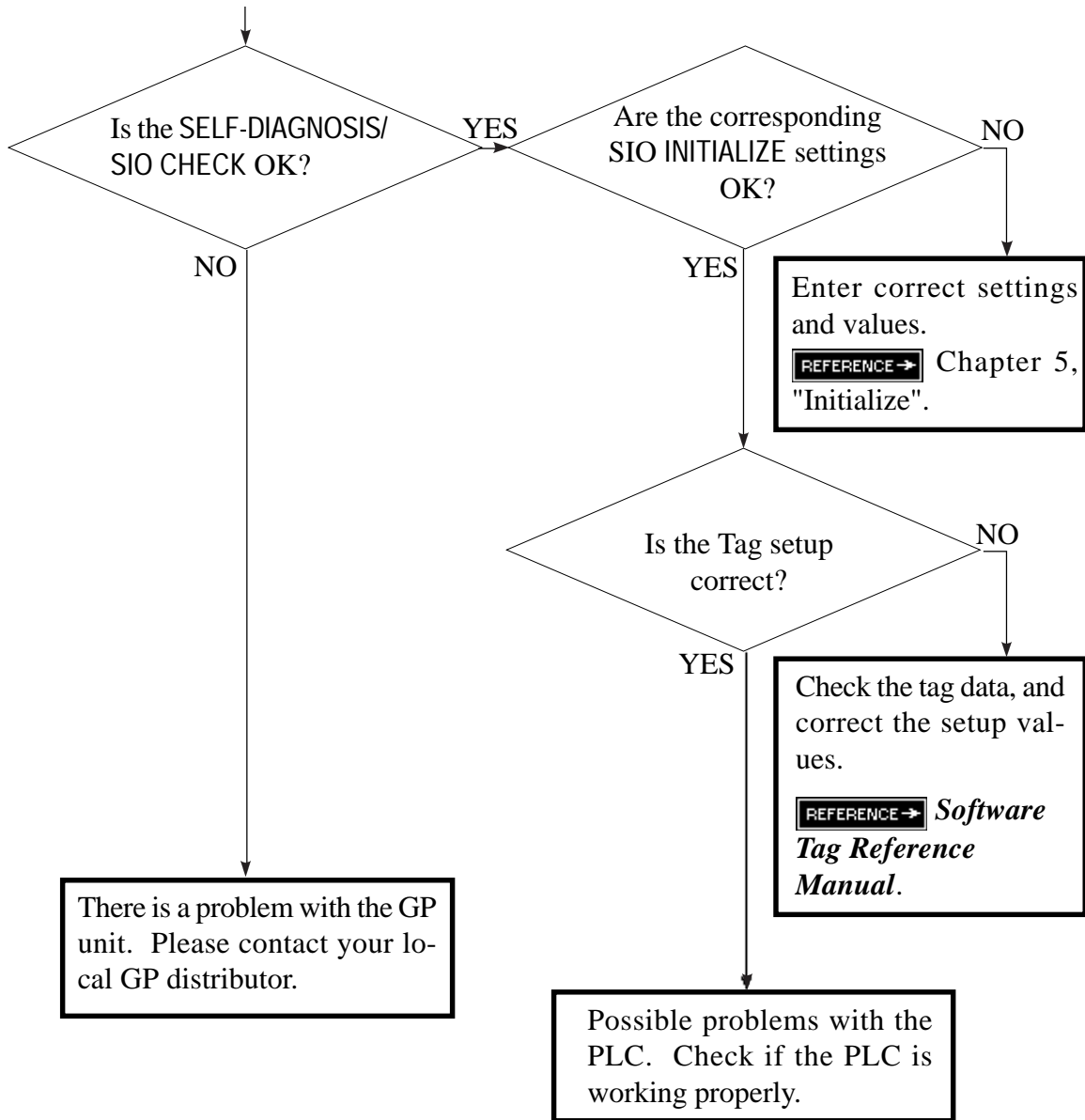

- To run SELF-DIAGNOSIS's SIO CHECK options, special tools become necessary. For details about SELF-DIAGNOSIS, refer to the SELF-DIAGNOSIS section in this chapter.

## Run & Errors

### 4. The Touch Panel Does Not Work

When the touch panel does not react, or its reaction time is very slow after it is pressed, please follow the flowchart below to find the origin of the problem, and the appropriate solution.

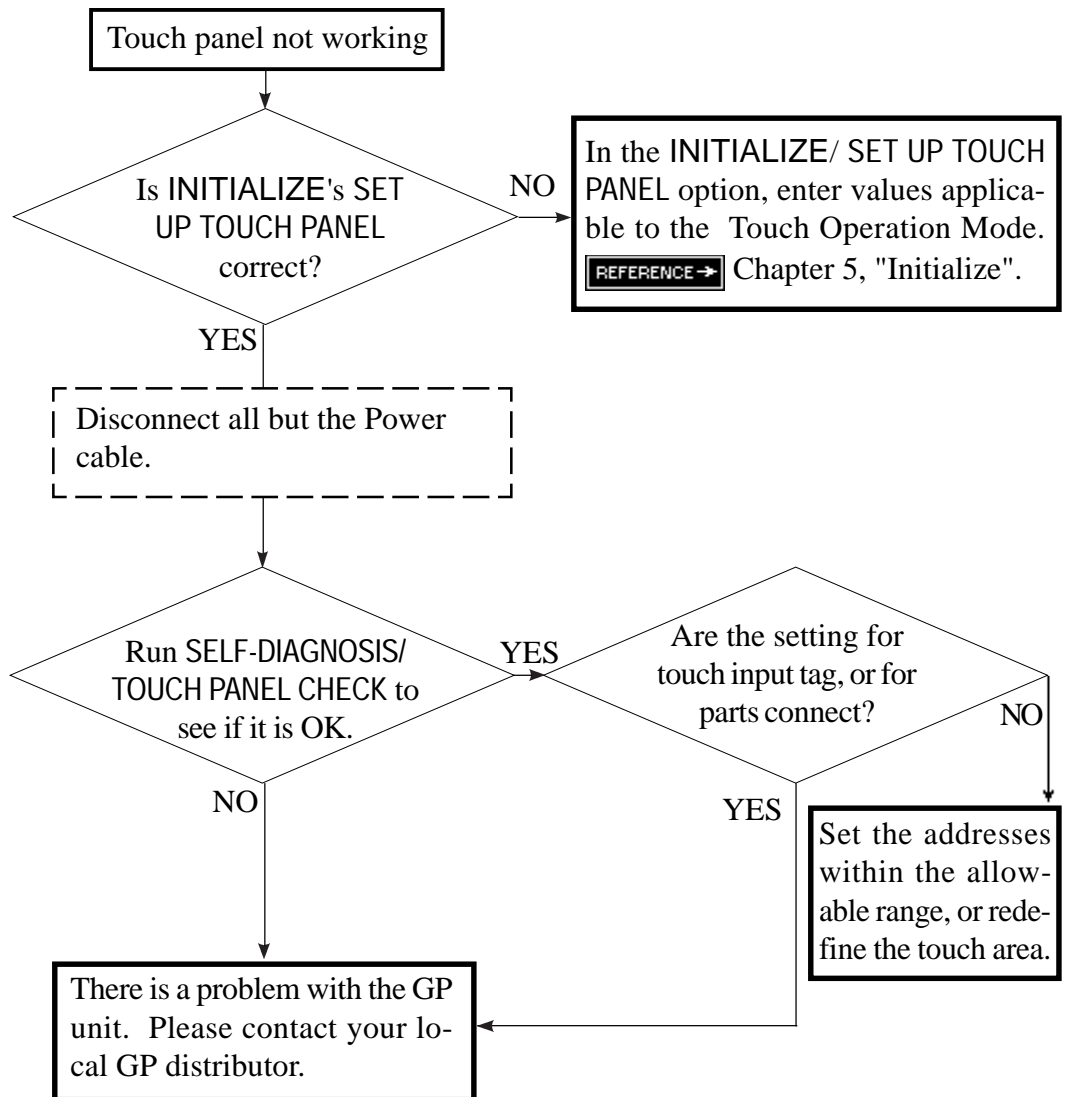

## 6.3 SELF-DIAGNOSIS

The GP unit is equipped to check its own System and Interface for any problems. Use it to help diagnose any problems.

### 1. SELF-DIAGNOSIS Item List

| MAIN SELF-DIAGNOSIS MENU |            |
|--------------------------|------------|
| DISPLAY PATTERN          | INPUT PORT |
| TOUCH PANEL              | SIO CHECK  |
| FEPROM CHECKSUM          |            |
| FRAME BUFFER             |            |
| TOOL CONNECTOR           |            |

- **DISPLAY PATTERN**  
Displays all the figures and tiling patterns to check if they are correct.
- **TOUCH PANEL**  
Checks the touch panel squares.
- **FEPROM CHECKSUM**  
Runs the GP internal memory's (FEPROM) system and protocol checksum.
- **FRAME BUFFER**  
Checks the GP internal display memory (FRAME BUFFER).
- **\*TOOL CONNECTOR**  
Checks the control lines and input/output lines for the tool connector.
- **INPUT PORT** (for Digital's maintenance use only)  
Runs a check on the Input Port.
- **\*SIO CHECK**  
Checks the input/output lines for the RS-232C and RS-422 terminals.



The SELF-DIAGNOSIS items marked with an asterisk (\*) require special tools. Please prepare the required tool for each test.



### 2. SELF-DIAGNOSIS—Details Of Each Item

---

This section explains the contents of SELF-DIAGNOSIS. For information about how to operate the Screen, [REFERENCE →](#) Chapter 4, "Off-line Mode"; for information about how to set up the *Special Tools*, [REFERENCE →](#) Chapter 3, "Installation and Wiring".

#### DISPLAY PATTERN

Acts as a check of the screen drawing function(s). It is used, for example, when the GP unit's buzzer does not sound, or if the device's contents do not display correctly. Performing this check displays various screen patterns, and a "Display ON/OFF Check" is performed. During the "Display ON/OFF check", the screen, together with the buzzer, turns ON and OFF.

After the check is completed, if the unit performs normally, "OK" is displayed. If a problem is discovered, "NG" is displayed.

#### TOUCH PANEL

Touch Panel check. Checks if each touch cell highlights when pressed.

#### INTERNAL FEPRM CHECKSUM (System & Protocol)

The Internal FEPRM System and Protocol check searches for any problems that may arise during operations.

When the FEPRM is normal, **OK** displays; if there is a problem, an error message appears. This check does not erase the System or Protocol.

#### FRAME BUFFER

The Frame Buffer (display memory) Check looks for any display problems that may develop. When everything is normal, **OK** displays; when there is a problem, an error message displays.

#### TOOL CONNECTOR LOOP BACK

Use the Tool Connector Control line and Send/Receive line check when the GP cannot send and receive data from the PC. To run the check, connecting a *Tool Connector Check Loop Back Cable* (Dsub25 pin female connection) mounted to the *Downloading Cable* (provided in your software package) is necessary. *See diagram next page.*

## Run & Errors

### TOOL CONNECTOR LOOP BACK CABLE

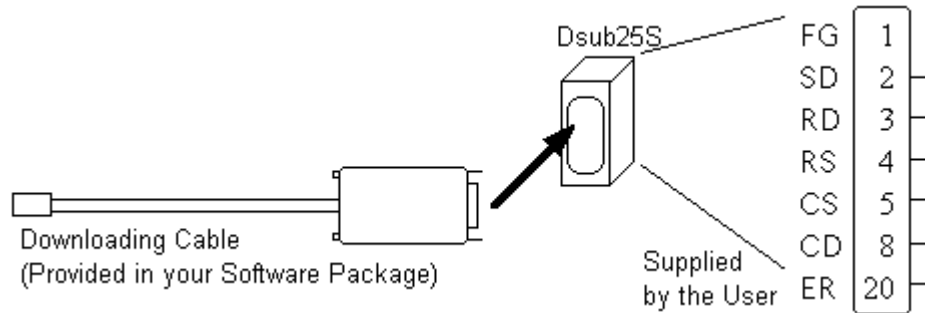

When everything is normal, **OK** displays; when there is a problem, an error message displays.

### INPUT PORT

Used by Digital for maintenance purpose.

### SIO CHECK

Checks the RS-232C and RS-422 I/O lines for areas where correspondence problems develop. In the menu, select which check to run. To run the check, a serial interface cable connection becomes necessary. If all is normal, **OK** displays; if there is a problem, an error message appears.

The Serial Interface cable wiring for each check is as shown below.

#### • DTR CHECK

Connect the DTR Loop Back cable to the GP's serial interface. If all is normal, **OK** displays; if there is a problem, an error message appears.

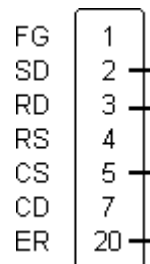

#### • RTS CHECK

Connect the RTS Loop Back cable to the GP's serial interface. If all is normal, **OK** displays; if there is a problem, an error message appears.

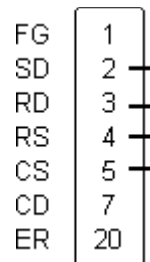

## Run & Errors

- **RS-422 CHECK**

Connect the RS-422 Loop Back cable to the GP's serial interace. If all is normal, **OK** displays; if there is a problem, an error message appears.

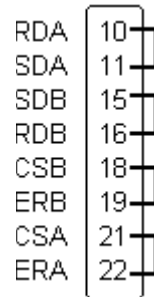

### 6.4 Error Message

This section explains the messages that appear when an error has occurred in the GP unit during RUN mode. The origin of the problem behind each error message is explained with appropriate ways of disposing of the error.

After a problem has been solved, turn the power Off, then On, and restart the GP.

#### 1. Error Message List

The error messages listed below appear on the GP unit. Instructions on how to find and solve error messages are explained on the following pages.

- SYSTEM ERROR
- ILLEGAL ADDRESS IN SCREEN DATA
- UNSUPPORTED TAG IN SCREEN DATA
- PLC NOT CONNECTED (02:FF) and (02:F7)
- PLC NOT RESPONDING (02:FE)
- RECEIVE DATA ERROR (02:FD)
- PLC COM. ERROR
- SCREEN MEMORY DATA IS CORRUPT
- CLOCK SETUP ERROR
- SCREEN TRANSFER ERROR
- SCREEN TAG LIMIT EXCEEDED
- OBJ. PLC HAS NOT BEEN SETUP
  
- GP STATION NO. DUPLICATION ERROR (02:F9) **n:1**
- NETWORK ADDRESS ERROR (02:F8) **n:1**



If there is more than one error, the GP displays the error message for the last error detected.

# Run & Errors

## 2. Error Messages—Details

---

### SYSTEM ERROR

Indicates a fault in the basic operations of the GP.

Following the error message, an error code, as shown, will appear. Report the error number, and details on how the error developed, to your local GP distributor.

- **SYSTEM ERROR ( 03 : x x )**

Displays when a PC transferred file cannot be rebuilt.

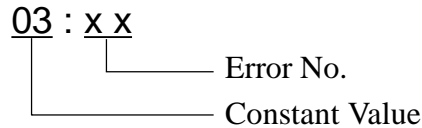

- **SYSTEM ERROR ( x x x : x x x : x x x )**

Displays in RUN mode when a file cannot be rebuilt.

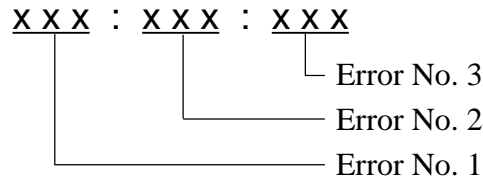

- **Offline mode displays while in RUN mode**

When the GP changes to Off-line mode without pressing the screen, there is a possibility that the screen data has been damaged. When the screen data is damaged, after the SYSTEM ERROR displays, the screen automatically reverts to Off-line mode after about 10 seconds. Run the INITIALIZE MEMORY command and transfer the GP screen data again from your PC.

### ILLEGAL ADDRESS IN SCREEN DATA

This error message is caused by an overlap of addresses.

Following the error message, error codes, as listed below, appear. If the error cannot be fixed, please report the error code and details on how the error developed to your local GP distributor.

### ILLEGAL ADDRESS IN SCREEN DATA ( 0 0 B : x x x : x x x )

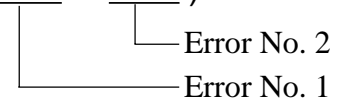

*See the Table next page*

## Overlapping Addresses

| Error 1 | Error 2 | Contents  |
|---------|---------|---|
| 0C1     | 191     | All or part of the T-File <sup>*1</sup> or S-tag address range overlap the addresses of System Data Area.                         |
|         | 192     |   |
|         | 193     |   |
| 0C2     | 194     | All or part of the System Data Area address, A-File, <sup>*1</sup> or S-tag address range overlap the addresses setup in a T-File |
|         | 195     |   |
|         | 196     |   |
| 0C3     | 197     | All or part of the T-File, <sup>*1</sup> or the S-tag or K-tag address range overlap the address range set in an A-File.          |
|         | 198     |   |
|         | 199     |   |
| 0C9     | 19B     | All or part of the T-File, <sup>*1</sup> or the S-tag or K-tag address range overlap the address range set in an A-File.          |



Overlapping addresses, other than the ones mentioned above, can also cause the Illegal Address message.

E.g. When the starting address of the System Data Area is set to 100, and the tag below is setup:

| Tag Name/<br>Part ID No. | Word<br>Address | Tag Format |
|--------------------------|-----------------|------------|
| N1                       | 99              | BCD32      |

The N-tag is set to 32 bits, meaning it uses two word addresses. Since the first address is 99, the second address must be 100. Address 100 is ineligible for use since it has already been used for the System Data Area.

### UNSUPPORTED TAG IN SCREEN DATA

A list of tag(s) in use that are unsupported by the current GP version appear with this error message. Setup the tags to correspond with the GP.

For details about tags,  *Software Tag Reference Manual*.

### PLC NOT CONNECTED (02:FF) (02:F7)

Displays when communication with the PLC has stopped for over 60 seconds, when there is a transmission timeout error, or when there is excess *noise*.

Check the correspondence cable wiring and connect correctly.

\*1 For details about the T-File (trend graph) and A-File (alarm messages), refer to the *Software Tag Reference Manual*.

## Run & Errors

### PLC NOT RESPONDING (02:FE)

Displays when there is a Reply Timeout Error, or when there is excess noise.

The origin of the problem and the matching solutions are listed in the table below.

| ORIGIN  | SOLUTION  |
|---|---|
| <ol style="list-style-type: none"><li>1. The power for the PLC host is not activated.</li><li>2. GP unit INITIALIZE setup (Setup I/O, PLC Setting) is incorrect.</li><li>3. The host and GP powering up process was incorrect.</li><li>4. The Communication Cable was not connected properly.</li></ol> | <ol style="list-style-type: none"><li>1. Turn On the host's power switch.</li><li>2. Setup the unit correctly and match up with the current host and Communication Cable.</li><li>3. Turn the host's power On first, wait 2-3 seconds, then power up the GP unit.</li><li>4. Check the Communication Cable wiring and connect it up properly.</li></ol> |

### RECEIVE DATA ERROR (02:FD)

This problem arises as a result of one of these three:

- There is a problem in trying to receive the data
- The connected PLC and the PLC setup for the data is different
- Noise

These errors, except for noise, appear when the Communication Cable is pulled out when the GP unit is On, or when normal communication operations are being run, but the GP has been powered Off, then back On. To solve the problem, simply begin running transmissions again.

When the error is a result of noise, correct any improper connections.

### GP STATION NO. DUPLICATION ERROR (02:F9) n:1

This error appears for one of two reasons:

- The GP number is same as the station number for another GP. Check all the GP station numbers.
- In the middle of correspondences, the PLC power has been turned On/Off. Reset the power on the PLC and GP.

### NETWORK ADDRESS ERROR (02:F8) n:1

The SIO address setup for the GP is different from other GP's. Check the address setup for all the GP's.

## PLC COM. ERROR

Appears when the address setup for tags exceeds the address range on the host side. Check the Error Number that appears and use the following table to eradicate the problem.

PLC COM. ERROR ( 02 : x x )

└── Error code (see the table below)  
└── Constant Value

| Error # | Origin   | Solution   |
|---------|--|--|
| FC      | (MtoM type) There is a data format problem with the message received.  | Check the data being transferred on the host side.   |
| FB      | The address set on a tag, the address used for storing data for Trend Graph, or the address registered with an alarm message is out of a set range. (address range error)<br>* Memory to Memory type.<br>* Siemen's PLC Series | * When using Memory to Memory Type: Set the addresses within the set range of the System Area (0~2047), then send the corrected information.<br><br>* When using Siemens' Series PLC Type: Set up the data block in the PLC where the System Data area is. |
| FA      | Address range error  | Set the addresses within the allowable device range.   |
| 53      | When using a Matsushita Electronics PLC, and too many tags are used on the screen, the PLC cannot receive any data.  | Decrease the number of screen tags.  |
| 51      | The tag address, Trend graph data storage address, Alarm message Registry address, and the like, do not exist in the PLC's internal memory. (In the case of Fuji Electric PLC)   | Setup the addresses in a device range that exists.   |
| Others  | When the Error Number displays, different for each PLC, look up the error number in the indicated PLC manual or, report the error number to the PLC maker.   |  |



- Disregard the above table if Error Number **51** appears and you are using a PLC other than Fuji Electric. Look up the error contents in your PLC manual and follow the instructions therein.
- Disregard the above table if Error Number **53** appears and you are using a PLC other than Matsushita Electronics. Look up the error contents in your PLC manual and follow the instructions therein.
- In Hitachi's HIDIC H (HIZAC H) Series, the error code is divided into 2 bytes, whereas the GP Error Number is composed of 1 byte codes. (see next page)



## Run & Errors

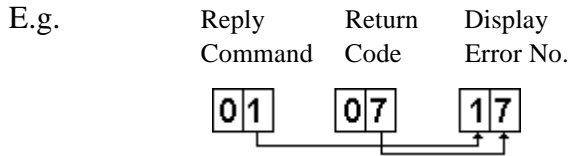

When the displayed error number is 8\*, or 5\*, use only the left column as the error number.

- In Toshiba's PROSEC T Series, the Error Code is 4 places long; on the GP, Error Numbers are displayed and changed into Hexadecimal.

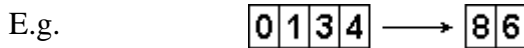

- With the Allen-Bradley PLC-5 and SLC-500 Series, the EXT/STS error codes have been re-mapped to start at D0 HEX, so they will not conflict with other error codes. When looking up the error number in the PLC manual, subtract D0 h from the GP error code to get its error value.

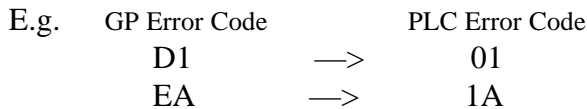

### SCREEN MEMORY DATA IS CORRUPT

Displays when the *checksum* of the screen memory data does not match because of a corruption in the screen files.

Error codes, as shown below, follow the error message. By referring to the error code, check the screens that have errors. When a screen file has been corrupted, delete that file, and make a new one (or recall a backup copy if available).

### SCREEN MEMORY DATA IS CORRUPT ( x x x x : x x x x )

The Screen Number that has an error.  
(Displays only one per Screen Number.)

The number of screens that have errors (Decimal)

### CLOCK SET UP ERROR

This message displays when the backup battery for the internal clock is dead. If the battery is incorrectly replaced, the battery may explode. To avoid the danger, please do not replace the battery yourself. When the battery needs a replacement, please consult with your local GP distributor.

After changing the backup battery, set up the internal clock.  Chapter 5, "Initialize".



The life span of the backup battery depends on the ambient temperature and the amount of current being charged and used. The table below gives a general indication of how long the battery will last.

|                            |              |                   |                   |
|----------------------------|--------------|-------------------|-------------------|
| <b>Battery Temperature</b> | under 40° C  | Between 40~ 50° C | Between 50~ 60° C |
| <b>Expected Life Span</b>  | over 10 yrs. | over 4.1 yrs.     | over 1.5 yrs      |

### SCREEN TRANSFER ERROR

Displays when an error occurs in the data transmission from the screen editor to the GP panel. Try re-transmitting the screen data.

### SCREEN TAG LIMIT EXCEEDED <MAX256>

When tags are setup beyond the tag limit, these tags are made invalid. Tags are invalidated from the end tag, in the opposite order in which they were registered. Plus, when tags involve registered Windows and loaded screens, they are invalidated in this order: Window Registry, Load Screen. Further details for when multiple displays are set to one screen:

1. Invalidate registered windows from the end screen.
2. Invalidate loaded screens from the end screen.

Check invalidated tags and reduce the tag number.

### OBJ. PLC HAS NOT BEEN SETUP (02:F9)

The host PLC setup in Software's Screen does not match the PLC in use. Use the Error Code that follows the error message to select the proper PLC type in the GP and correct the INITIALIZE setup.

OBJ. PLC HAS NOT BEEN SETUP ( xx )

|  
The PLC number (*Hexadecimal*)  
written onto the System File

*See the Table, next page.*

## Run & Errors

PLC Number indicated by error code

| PLC# | PLC TYPE               | PLC# | PLC TYPE                    |
|------|------------------------|------|-----------------------------|
| 0    | SYSMAC C               | 20   | SIEMENS S5 135-115          |
| 1    | MELSEC-AnN (Link)      | 21   | SIEMENS S5 3964(R) protocol |
| 2    | NEW SATELLITE JW       | 22   | Allen-Bradly PLC-5          |
| 3    | FACTORY ACE            | 28   | Allen-Bradly SLC500         |
| 4    | MICREX-F               | 63   | FACTORY ACE 1:n             |
| 6    | TOYOPUC-PC2            | 66   | GE FANUC 90SNP              |
| 7    | MEWNET-FP              | 67   | HIZAC EC                    |
| 8    | HIDIC-S10 $\alpha$     | 68   | IDIC 1                      |
| 9    | Memocon-SC             | 69   | IDIC 2                      |
| B    | MELSEC AnA (Link)      | 6A   | IDIC 3                      |
| D    | SYSMAC CV              | 6B   | FANUC Power Mate            |
| E    | PROSEC EX2000          | 6C   | MICRO3                      |
| 10   | HIZAC H                | 81   | MELSEC-AnN (CPU)            |
| 11   | MELSEC-FX              | 8B   | MELSEC-AnA (CPU)            |
| 12   | MELSEC-F2              | 0C   | KOSTAC SR21/22              |
| 14   | KOSTAC SG8             | 6D   | KEYENCE                     |
| 15   | PROSEC T               | 1C   | MELSEC QnA (Link)           |
| 4D   | MEMORY LINK (SIO Type) | 6F   | FLEX-PC (CPU)               |
| 18   | FLEX-PC                | 1D   | MELSEC-QnA (CPU)            |
| 1B   | TC200                  | 6E   | SELMART                     |
| 1F   | SIEMENS S5 90-115      |      |                             |



# Chapter 7

## Maintenance

1. Regular Cleaning
2. Periodic Checkup
3. Changing the Backlight

### 7.1 Regular Cleaning

#### Cleaning the Display

When the surface or the frame of the display gets dirty, soak a soft cloth in water with a neutral detergent, wring the cloth tightly, and wipe the display.

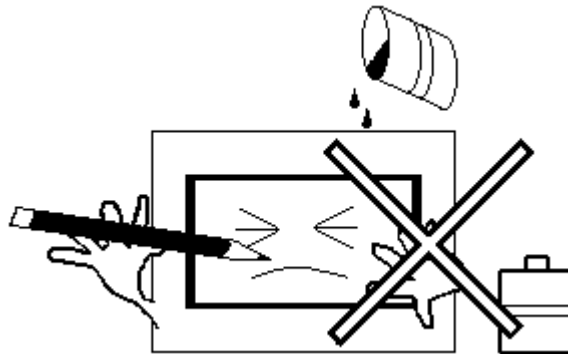

- Do not use paint thinner, organic solvents, or a strong acid compound to clean the unit.
- Do not press the touch-screen panel with hard or pointed objects, such as a mechanical pencil, for it may damage the surface.

#### Rubber Gasket Replacement

The rubber gasket protects the GP and improves its water resistance. For instructions on installing the gasket, [REFERENCE →](#) Chapter 3.1 "Installation".



A rubber gasket, which has been used for a long period of time, may have scratches or dirt on it, and could have lost much of its water resistance. Change the gasket periodically (or when scratches or dirt become visible).

[REFERENCE →](#) Chapter 1.3 "Optional Equipment"

### 7.2 Periodic Check-Up

To maintain your unit in its best condition, please check your unit periodically.

#### Inspection Items:

##### Surrounding Environment

- Is the temperature within the allowable range? (0~50° Celsius)
- Is the humidity within the specified range? (20~85%RH)
- Is the atmosphere free of corrosive gas?

##### GP Temperature

- When the GP unit is mounted into a panel, the surrounding temperature refers to the temperature inside the cabinet.

##### Electrical Specifications

- Is the input voltage appropriate? (DC20.4~27.6V)

##### Attachments

- Is the cable connected properly? Not loose?
- Are the mounting brackets holding the unit securely?
- Are there many scratches or traces of dirt on the rubber gasket?

## 7.3 Changing the Backlight



- Whenever changing the Backlight, be sure the power has been turned Off.
- When the unit is still On, high voltage runs through the *Backlight* area—*do not touch*.
- When the unit is Hot, be sure to use gloves to prevent injury.
- When the power has just been turned Off, the unit and Backlight are still very hot.



Please make sure you have the proper Backlight for the GP-370 model.

| Model                    | Backlight Model |
|--------------------------|-----------------|
| GP370-LG**<br>GP370-SC** | GP370-BL00-MS   |

Change the Backlight following the steps below. Be sure to use gloves.

- ① Turn off the power supplied to GP.
- ② Remove the power cable. (A)
- ③ Use a screwdriver to unscrew the two screws on the unit's top face. (See figure B) Then, while holding the face of the GP with one hand, press down with the thumb of your other hand on the center of the top face to unlock the top face's clip. This should allow the GP's case to pivot open.
- ④ Disconnect the connector. (See figure C) At this time, do not remove the inner face's protective metal plate.
- ⑤ Move the hook towards the right, and pull out the backlight. (D)
- ⑥ Insert a new Backlight, and put the connector back on.
- ⑦ At the bottom part of GP, insert the clips to the holes, put the rear cover back in place and fasten the screws. In this step, be careful not to get any of the Connector wiring caught between the front and the rear covers. (E)

# Maintenance

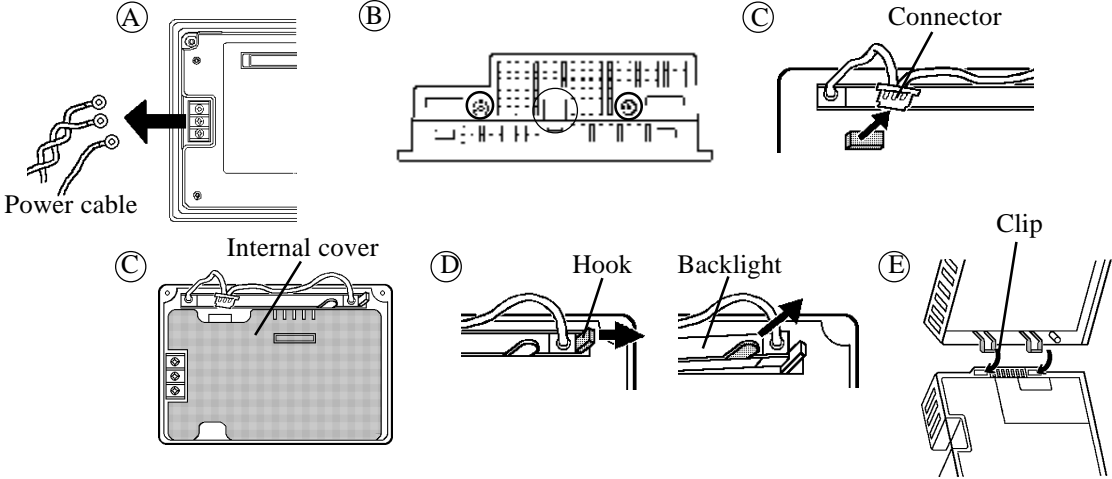



# Index

## Symbols

1:1 ..... 5-1, 5-13

## A

Alarm Display ..... 5-3

## B

Backlight ..... 7-3

Backlight Bulb ..... 1-4

Bar Code Reader ..... 1-3

## C

### Cable

Connection ..... 1-2

Downloading Cable ..... 1-3, 4-7

Mitsubishi PLC Procon I/F ..... 1-3

Mitsubishi Programming Port I/F ..... 1-5

Multi-link ..... 1-5

RS-232C ..... 1-3, 1-5

RS-422 ..... 1-3, 1-5

Siemen's Programming Port I/F Connection Cable  
1-5

CCU ..... 5-14

Change Screen ..... 5-3

### COMMUNICATION SETUP

RECEIVE TIMEOUT ..... 5-12

RETRY COUNT ..... 5-12

Connection Part ..... 5-15

Cover Sheet ..... 1-4

### CUSTOMIZE SETUP

GP TOUCH MONOPOLIZE ..... 5-18

MONOPOLIZE TIME ..... 5-18

PLC PRIORITY ..... 5-17

## D

Data Device Storage Order ..... 5-7

DISPLAY PATTERN ..... 6-10

Downloading Cable ..... 4-7

## E

Environmental Shield ..... 7-1

Equipment. *See* Optional Equipment; System Structure

## Error Messages

CLOCK SET UP ERROR ..... 6-19

GP STATION NO. REPEATED ..... 6-17

ILLEGAL ADDRESS IN SCREEN DATA .... 6-15

INCORRECT STORAGE INFORMATION AD-  
DRESS ..... 6-17

OBJ. PLC HAS NOT BEEN SETUP ..... 6-20

PLC COM. ERROR ..... 6-18

PLC NOT CONNECTED ..... 6-16

PLC NOT RESPONDING ..... 6-17

RECEIVE DATA ERROR ..... 6-17

SCREEN MEMORY DATA IS CORRUPT ... 6-19

SCREEN TRANSFER ERROR ..... 6-20

SYSTEM ERROR ..... 6-15

UNSUPPORTED TAG IN SCREEN DATA .. 6-16

ESC Key ..... 4-6

## F

FORCE RESET ..... 5-10-5-11

Force Reset ..... 4-2

FRAME BUFFER ..... 6-10

## G

Global Window ..... 5-5

### GLOBAL WINDOW SETUP

DATA FORMAT ..... 5-6

GLOBAL WINDOW ..... 5-5

GLOBAL WINDOW ACCESS ..... 5-5

REGISTRATION NO. (1-256) ..... 5-6

### Graphic Panel

Auxiliary Input/Output ..... 2-6

Caution ..... v

Cleaning ..... 7-1-7-2

Clock ..... 2-4

Display ..... 2-6

Display Functions ..... 2-3

Electrical Specifications ..... 7-2

Environment ..... 7-2

GP-470 External Dimensions ..... 2-7

Installation Brackets ..... 2-8

Installation Dimensions ..... 2-9

Interface ..... 2-4

Maintenance ..... 7-1

Names and Functions of parts ..... 2-6

Package Contents ..... ix

Periodic Check-Up ..... 7-2

- Power Input Terminal Block ..... 2-6  
 Screen Memory ..... 2-4  
 Serial Interface ..... 2-6  
 Temperature ..... 7-2  
 Tool Connector ..... 2-6  
 Touch Panel ..... 2-6  
 Ventilation ..... 3-2
- H**
- Hitachi  
 HIDIC-S10 alpha Series ..... 5-13
- I**
- INITIALIZE ..... 4-3, 5-1  
 Standard Operations ..... 4-4-4-5  
 INITIALIZE MEMORY ..... 5-19  
 INPUT PORT ..... 6-10  
 Installation ..... 3-1  
 Installation Brackets ..... 1-4
- K**
- K-tag ..... 5-8
- L**
- Local Window ..... 5-5
- M**
- Main Menu ..... 4-3  
 Matsushita Electric  
 NEWNET-FP ..... 5-14  
 Memory Loader ..... 1-3  
 Mitsubishi PLC A-Series  
 2 Port Adapter ..... 1-3  
 Procon I/F Cable ..... 1-3  
 Mitsubishi PLC FX-Series  
 Procon I/F Cable ..... 1-3
- N**
- n:1 ..... 5-1, 5-14, 5-15-5-16  
 NETWORK INFORMATION ADDRESS ..... 5-15  
 Notes on UL Application ..... vii
- O**
- Off-line Mode ..... 4-1, 6-1  
 Optional Equipment ..... 1-5
- P**
- PLC PRIORITY  
 Display Priority and Operation Priority Speed Diff  
 5-17  
 PLC SETUP ..... 5-13  
 CUSTOMIZE SETUP ..... 5-17  
 SET UP OPERATION SURROUNDINGS (n:1) ..  
 ..... 5-14  
 SET UP OPERATION SURROUNDINGS (1:1) ...  
 ..... 5-13  
 STATION SETUP ..... 5-15  
 Power Terminal Block ..... 3-5  
 Power-up Sequence ..... 5-3  
 Printer ..... 1-3  
 Program Port ..... 1-2
- R**
- RS-232C ..... 2-5, 4-7  
 RS-232C Port ..... 1-2  
 RS-422 ..... 2-5  
 RS-422 Connector ..... 1-3  
 RS-422 Port ..... 1-2  
 Rubber Gasket ..... 1-4, 7-1  
 RUN ..... 4-3
- S**
- SCREEN DATA TRANSFER ..... 4-3  
 Screen Saver Function ..... 5-3  
 SELF-DIAGNOSIS ..... 4-3, 6-10  
 DISPLAY PATTERN ..... 6-11  
 FRAME BUFFER ..... 6-11  
 INPUT PORT ..... 6-12  
 INTERNAL FEPROM CHECKSUM ..... 6-11  
 KEYBOARD LOOP BACK ..... 6-11  
 SIO CHECK ..... 6-12  
 DTR CHECK ..... 6-12  
 RS-422 CHECK ..... 6-13  
 RTS CHECK ..... 6-12  
 Standard Operations ..... 4-5-4-7  
 TOUCH PANEL ..... 6-11  
 Serial Interface ..... 1-2, 1-5, 2-5  
 SET Key ..... 4-6  
 SET UP I/O ..... 5-9  
 COMMUNICATION SETUP ..... 5-12  
 SET UP SIO ..... 5-9  
 SET UP TOUCH PANEL ..... 5-10  
 SET UP OPERATION SURROUNDINGS

# Index

|   |            |
|---|------------|
| STARTING ADDRESS OF SYSTEM DATA AREA .....          | 5-13, 5-14 |
| SYSTEM AREA--READING AREA SIZE .....                | 5-13, 5-15 |
| UNIT NO. ....                                       | 5-13, 5-14 |
| SET UP SCREEN .....                                 | 5-20       |
| ALARM MESSAGE .....                                 | 5-20       |
| FONT SETTING .....                                  | 5-21       |
| INITIAL SCREEN NO. ....                             | 5-20       |
| KANJI FONT QUALITY .....                            | 5-21       |
| ON-LINE ERROR DISPLAY .....                         | 5-20       |
| SET UP SIO .....                                    | 5-9        |
| COMMUNICATION FORMAT .....                          | 5-9        |
| CONTROL .....                                       | 5-9        |
| DATA LENGTH .....                                   | 5-9        |
| PARITY .....  | 5-9        |
| SET UP TIME .....                                   | 5-19       |
| SET UP TOUCH PANEL                                  |            |
| BRIGHTNESS ADJUSTMENT .....                         | 5-11       |
| CONTRAST ADJUSTMENT .....                           | 5-11       |
| FORCE RESET .....                                   | 5-10       |
| TOUCH OPERATION MODE .....                          | 5-10       |
| SIO CHECK MENU .....                                | 6-10       |
| Specifications                                      |            |
| Electrical .....                                    | 2-1        |
| Environmental .....                                 | 2-2        |
| Interface .....                                     | 2-5        |
| Structural .....                                    | 2-3        |
| STATION SETUP                                       |            |
| NETWORK INFORMATION ADDRESS .....                   | 5-15       |
| STATION NO. ....                                    | 5-16       |
| Storage Order. <i>See</i> Data Device Storage Order |            |
| Symbols .....                                       | x          |
| SYSTEM AREA SETUP                                   |            |
| System Area Size .....                              | 5-4        |
| SYSTEM ENVIRONMENT SETUP .....                      | 5-3        |
| CHARACTER STRING DATA SETUP .....                   | 5-6        |
| GLOBAL WINDOW SETUP .....                           | 5-5        |
| SYSTEM AREA SETUP .....                             | 5-4        |
| SYSTEM SETUP .....                                  | 5-3        |
| SYSTEM SETUP  |            |
| BUZZER TERMINAL OUTPUT .....                        | 5-3        |
| DATA TYPE OF SCREEN NO. ....                        | 5-4        |
| PASSWORD (0-9999) .....                             | 5-3        |
| STAND-BY MODE TIME (0-255) .....                    | 5-3        |
| START TIME (0-255) .....                            | 5-3        |
| TOUCH BUZZER SOUND .....                            | 5-3        |
| System Structure .....                              | 1-2        |

## T

|                                     |          |
|-------------------------------------|----------|
| Termination Resistor .....          | 6-7      |
| TOOL CONNECTOR .....                | 6-10     |
| Tool Connector .....                | 1-2, 3-7 |
| TOUCH PANEL .....                   | 6-10     |
| Touch Screen .....                  | 5-3      |
| Touch Screen Cover .....            | 7-1      |
| Transfer Screen Data .....          | 4-7-4-8  |
| Troubleshooting .....               | 6-2-6-3. |
| <i>See also</i> Error Messages      |          |
| No Display .....                    | 6-4      |
| The Touch Panel Does Not Work ..... | 6-9      |
| Would Not Communicate .....         | 6-7      |

## V

|                         |      |
|-------------------------|------|
| Verification Part ..... | 5-16 |
|-------------------------|------|

## W

|                                 |     |
|---------------------------------|-----|
| Wiring .....                    | 3-5 |
| Grounding .....                 | 3-6 |
| Input/Output Signal Lines ..... | 3-6 |
| Power Cable .....               | 3-5 |
| Word Byte LH/HL Order .....     | 5-7 |

