

Easy! Smooth!

LT Type A → LT-3300T

Replacement Guidebook

Preface

This manual introduces the procedures to replace a unit of LT Type A with a unit in LT3000 series.

Model in use	Replacement model
LT Type A (Color) (GLC150-SC41-XY32S*-24V)	LT3300-T1-D24-*
LT Type A (Monochrome) (GLC150-BG41-XY32S*-24V)	

* K: Sink Type C: Source Type

Safety Information

HAZARD OF OPERATOR INJURY, OR UNINTENDED EQUIPMENT DAMAGE

Before operating any of these products, be sure to read all related manuals thoroughly.

Failure to follow these instructions can result in death, serious injury or unintended equipment damage.

Contents



Chapter 1 Specification Comparison	5
1.1 Specifications of LT Type A and LT-3300T	5
Functional specifications/General specifications	5
DIO Interface (Input) Specifications	6
DIO Interface (Output) Specifications	7
Chapter 2 Compatibility of Hardware	8
2.1 Locations of connectors	8
2.2 Touch Panel Specifications	9
2.3 Panel Cutout Dimensions	9
2.4 Transfer cable	9
2.5 Interface	9
2.5.1 Alarm Output Interface	9
2.5.2 DIO Interface	9
2.6 Peripheral units and options	10
2.6.1 Barcode reader connection	10
2.6.2 Printer Connection	10
2.7 Power Connector	10
2.8 Power Consumption	10
2.9 Materials/Colors of the body	10
2.10 Display Colors	11
Chapter 3 Replacement Procedure	12

3.1 Work Flow	12
3.2 Preparation	13
3.3 Receive screen data from LT Type A	13
3.4 Convert screen data with the Project Converter	17
3.5 Transfer the project file to LT-3300T.	22
3.6 Differences of software	27
3.6.1 Differences after conversion	27

Chapter 1 Specification Comparison

1.1 Specifications of LT Type A and LT-3300T

Functional specifications/General specifications

		LT Type A	LT-3300T
			
Display Type	Color	TFT Color LCD	UP! TFT Color LCD →See 2.10
	Monochrome	Blue-mode monochrome LCD	
Display Colors	Color	64 Colors	UP! 65,536 Colors (No blink)/16,384 Colors (Blink) →See 2.10
	Monochrome	Blue mode 8 levels (3-speed blink)	
Display Resolution		QVGA (320X240 pixels)	
Backlight		CCFL	White LED
Panel Cutout Dimensions (mm)		W191.5×H141.5	W156×H123.5 →See 2.3
External Dimensions (mm)		207W×157H×75.8D	W167.5×H135×D78
Touch Panel Type		Matrix	NEW! Resistive film Analog →See 2.2
Memory	Application	1MB	UP! 6MB
	SRAM	96KB	UP! 128KB
Control Memory	Program	128KB	UP! 132KB
	SRAM	32KB	UP! 64KB
Serial Interface (COM1)		-	NEW! RS-232C/422/485
Ethernet Interface	Color	-	10BASE-T/100BASE-TX
	Monochrome	-	-
DIO Interface	Sink Type	DIO 32 points (Sink/Source Input: 16 points/Sink Output: 16 points)	
	Source Type	DIO 32 points (Sink/Source Input: 16 points/ Source Output: 16 points)	
USB Host Interface		-	NEW! ✓ (Type A) →See 2.4
Printer Interface		Tool Connector	NEW! USB →See 2.6.2
Alarm Output		✓	- →See 2.5.1

DIO Interface (Input) Specifications

	LT Type A	LT-3300T
Rated Voltage	DC24V	
Max. Allowable Voltage	DC26.4V	DC28.8V
Input Type	Sink/Source Input	
Rated Current	5mA(24V)	6.5mA(DC24V)(IN0, IN2, IN4, IN6) 4.1mA (DC24V)(other inputs)
Input Resistance	4.7k Ω	Approx. 3.7k Ω (IN0, IN2, IN4, IN6) Approx. 5.9k Ω (other inputs)
Standard Operating Range	ON voltage: DC21V or more OFF voltage: DC7V or less	ON voltage: DC19V or more OFF voltage: DC5V or less
Input Delay	10ms or less	0 to 20ms*1
Common	1	
Common Structure	16 points /1 common line	
External Connection	40-pin connector (also used for output)	38-pin connector (also used for output)
Input Points	16	
Input Signal Indication	LED lights for each point ON (logical side)	No LED display
Isolation Method	Photo coupler isolation	
External Power Supply	For Signal: DC24V	

*1: Digital filter can be set at intervals of 0.5ms.

DIO Interface (Output) Specifications

	LT Type A	LT-3300T
Rated Voltage	DC24V	
Rated Voltage Range	DC24V±10%	DC20.4V to DC28.8V
Output Type	Sink Type	Sink Output
	Source Type	Source Output
Max. Load Current	0.2A/point, 1.6A/common	
Output Voltage Drop	DC2.5V or less	DC0.5V or less
Output Delay	2ms or less	5µs or less (OUT0 to 13) 0.5ms or less (OUT14 to 15)
Leakage Current when OFF	0.4mA or less	0.1mA or less
Output Classification	Transistor Output	
Common	1	2
Common Structure	16 points / 1 common line	8 points/1 common line x 2
External Connection	40-pin connector (also used for input)	38-pin connector (also used for input)
Output Protection Classification	Output is unprotected	
Internal Fuse	3.5A, 125V Chip Fuse (non-replaceable)	3.5A, 125V Chip Fuse x 2 (non-replaceable)
Surge Suppression Circuit	Diode	Zener Diode
Output Points	16 points	
Output Signal Indication	LED lights when each point turns ON (logical side)	No LED display
Isolation Method	Photo coupler isolation	
External Power Supply	For Signal: DC24V	

Chapter 2 Compatibility of Hardware

2.1 Locations of connectors

Connector locations on LT Type A and LT-3300T are as follows;

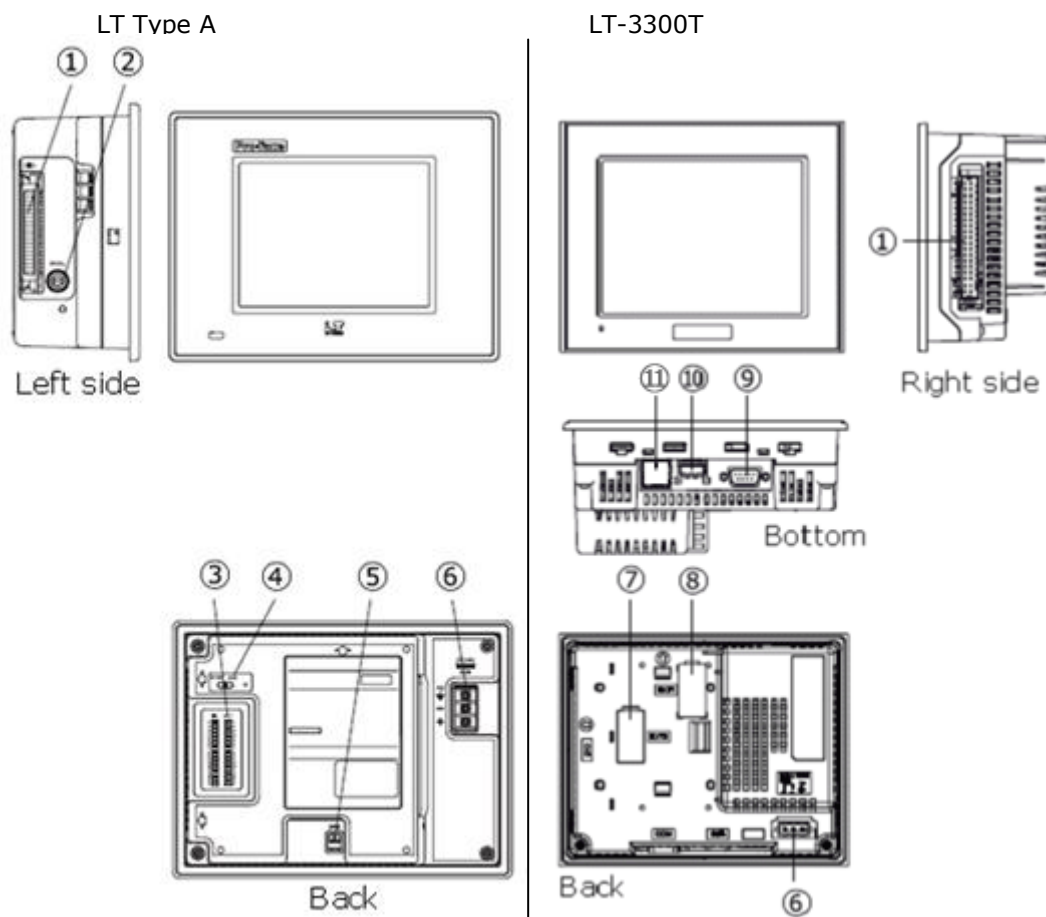

	LT Type A	LT-3300T
1		DIO I/F
2	Tool Connector	-
3	DIO Input/Output LED	-
4	RUN/STOP Switch (LED lights when RUN)	-
5	Alarm Output	-
6	Power Input Terminal Block	Power Connector
7	-	AUX/Expansion Unit I/F (EXT2)*1
8	-	EX Module I/F(EXT1)*1
9	-	Serial I/F (COM1)
10	-	USBI/F (Type A)
11	-	Ethernet I/F*2

*1: EX Module and CANopen Master Unit cannot be used at the same time.

*2: LT-3300T only.

2.2 Touch Panel Specifications

The touch panel type for LT3000 series is 'Resistive Film (Analog)'.

The resistive film analog type recognizes only the first-touched point and doesn't recognize the second-touched point when two different points are touched at the same time.

If you have applied the two-point touch input on LT Type A, we recommend you to change to the one-point touch input using the switch delay function of GP-Pro EX.

2.3 Panel Cutout Dimensions

The size of LT-3300T is smaller. The panel cutout dimensions of LT-3300T are different from those of LT Type A. Attachment (model: CA4-ATM5-01) for installing LT-3300T is available and you can use it when replacing LT Type A with LT-3300T.

2.4 Transfer cable

To transfer screen data to LT-3300T, use a USB cable or Ethernet.

Use a transfer cable for LT-3300T (model number: CA3-USBCB-01). Commercial USB cables cannot be used. Please note that the cables (model number: GPW-CB02, GPW-CB03, GP430-CU02-M) for LT Type A cannot be used for LT-3300T.

2.5 Interface

2.5.1 Alarm Output Interface

Alarm Output Function is not supported by LT-3300T. Please note that the Alarm Output that is used for LT Type A cannot be used.

2.5.2 DIO Interface

When the I/O interface that was connected to LT Type A is connected to LT-3300T, an external dummy resistance is required for faster response with light load use. (*For OUT 0 to 3 only)

Output Circuit
Sink Type

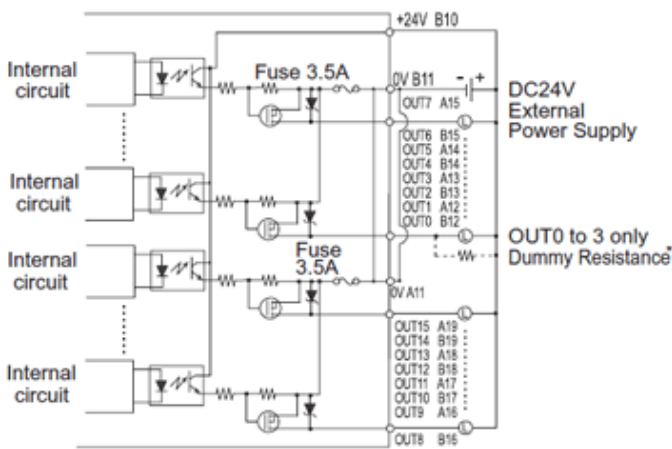

Source Type

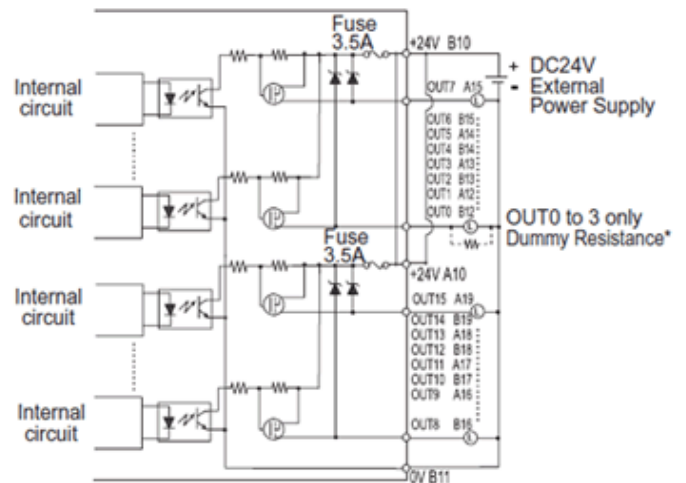

2.6 Peripheral units and options

2.6.1 Barcode reader connection

LT-3300T is not equipped with a tool port. The barcode reader that was connected to the tool port on LT Type A before replacement cannot be used. But LT-3300T allows you to connect a barcode reader on its USB interface (Type A).

For models LT-3300T supports, see [Otasuke Pro!] (<http://www.pro-face.com/otasuke/>).

2.6.2 Printer Connection

LT-3300T is not equipped with a tool port. The printer that was connected to the tool port on LT Type A before replacement cannot be used. But LT-3300T allows you to connect a printer on its USB interface (Type A).

For models LT-3300T supports, see [Otasuke Pro!] (<http://www.pro-face.com/otasuke/>).

2.7 Power Connector

The power connector on LT-3300T is a screw lock type. If you replace LT Type A with LT-3300T note that the power supply terminals are different.

2.8 Power Consumption

The power consumption of LT Type A is different from that of LT-3300T.

LT Type A	20W or less
LT-3300T	27W or less

For the detailed electric specifications, see the hardware manual.

2.9 Materials/Colors of the body

The body material of LT-3300T is a resin type like LT Type A. The material texture is almost the same, but the color is different.

2.10 Display Colors

The display color of GLC150-BG41-AD*K-24V/ GLC150-BG41-AD*C-24V is monochrome, but LT-3300T has a TFT color LCD. After replacement, the display color changes from monochrome to color.

When the setting of the display unit type is changed from a monochrome model to a color one on GP-Pro EX, the data may be displayed in colors depending on the GP-Pro EX version or settings of the drawing/the parts on the screens.

After changing the display unit type, please confirm the display colors of the drawing or the parts on the screens just in case.

If the display is in colors after changing the display unit type...

GP-Pro EX Ver. 3.01.200 (Service Pack1) or later supports the function which changes drawing in colors to monochrome. To change the color to monochrome, follow the steps below.

- (1) Click [Project]->[System Settings]->[Display Unit].
- (2) Open the [Display Settings] tab.
- (3) Change [Color] setting to "16 Levels Monochrome, 3-Speed Blink".

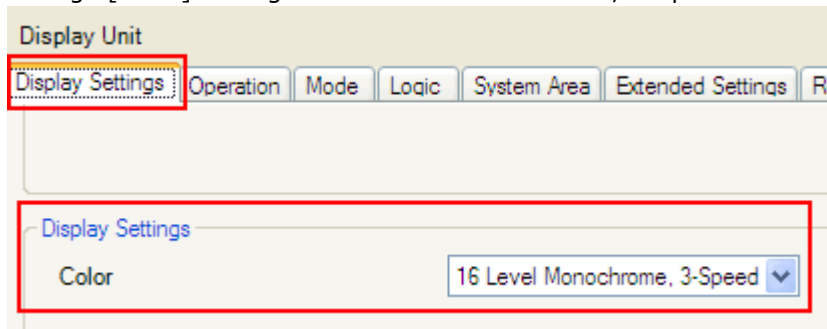

* [Reverse Display] setting is for displaying the screen with black/white reversed. Check on this setting if needed.



* Please confirm the display colors of the drawing or the parts on the screens after changing the [Color] setting.

Chapter 3 Replacement Procedure

3.1 Work Flow

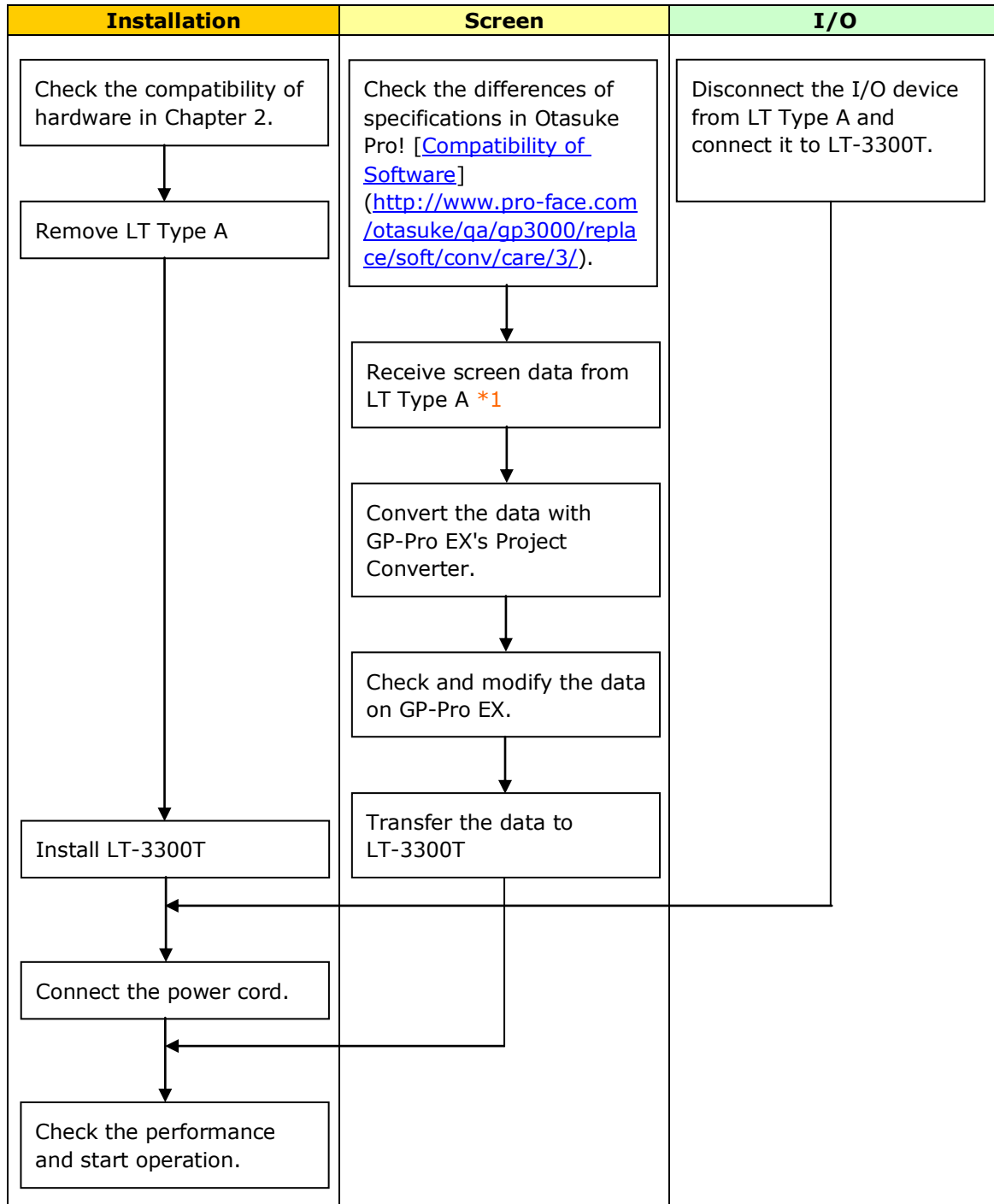

*1: This step is required if screen data is saved only in the GP unit, not in any other unit.

3.2 Preparation

Requirements for receiving screen data from LT Type A *1	PC in which GP-PRO/PBIII for Windows C-Package03 V7.0 or later is installed *2 Transfer cables (the following three types of cables are available.) - GPW-CB02 (D-sub 9-pin to the PC) - GPW-CB03 (USB to the PC) *3 - GP430-CU02-M or GPW-SET (D-sub 25-pin to the PC)
Requirements for converting screen data of LT Type A and transferring the converted data to LT-3300T	LT-3300T: GP-Pro EX Ver. 3.01.200 or later USB transfer cable (model: CA3-USBCB-01) *Also possible to send/receive screen data via a USB storage unit or Ethernet (for LT-3300T only).

*1: This step is required if screen data is saved only in the GP unit, not in any other unit.

*2: Please use the same version or later as or than that of the software used during creating screens on LT Type A LT Type B+. If you don't know the version, we recommend you to use the newest version. The newest version is GP-PRO/PBIII for Windows C-Package03 (SP2) V7.29. Those who have GP-PRO/PBIII for Windows C-Package03 V7.0 or later can download it from our web site called [Otasuke Pro!] (<http://www.pro-face.com/otasuke/>).

*3: GPW-CB03 is supported by GP-PRO/PBIII for Windows C-Package02 (SP2) V6.23 or later. You need to install a driver from [Download] on our Web site called [Otasuke Pro!] (<http://www.pro-face.com/otasuke/>)

3.3 Receive screen data from LT Type A

This section explains, as an example, how to receive screen data from LT Type A LT Type B+ using a transfer cable, GPW-CB02 or GPW-CB03. If you have backed up screen data, this step is unnecessary; skip to the next section [[3.4 Convert screen data with the Project Converter](#)].

1. Connect a transfer cable to LT Type A

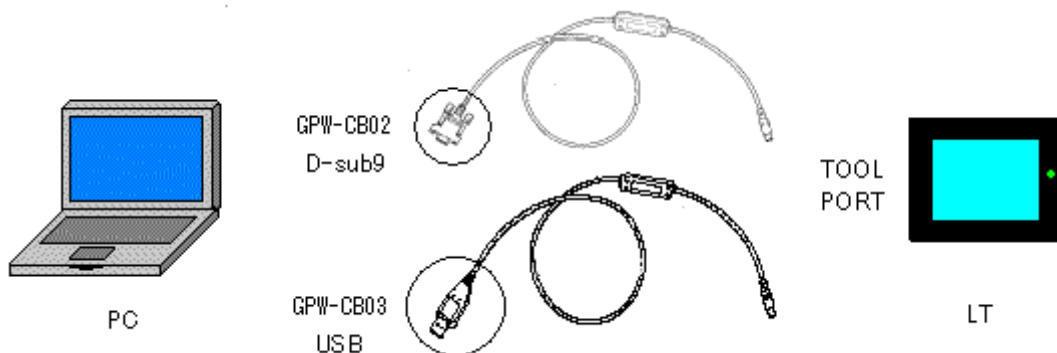

2. Start up GP-PRO/PBIII for Windows and click the [Transfer] icon on the Project Manager (Specify a desired project file.)



3. On the [Transfer] window, select the [Setup] menu and click [Transfer Settings...].

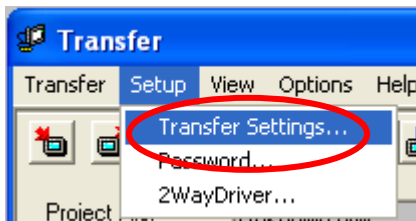

4. In the Communication Port field, select [COM], specify the COM port to which the cable is connected, and click [OK].

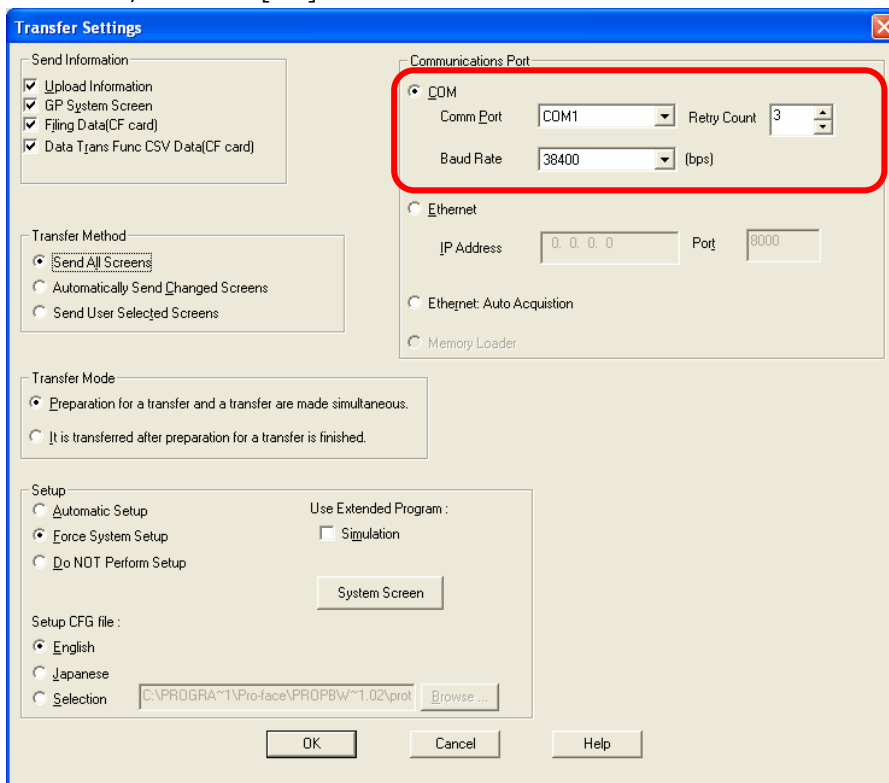

If you use a USB transfer cable (GPW-CB03)

You can check the COM port for the USB transfer cable (GPW-CB03), which is assigned to the PC, with the unit Manager of Windows.

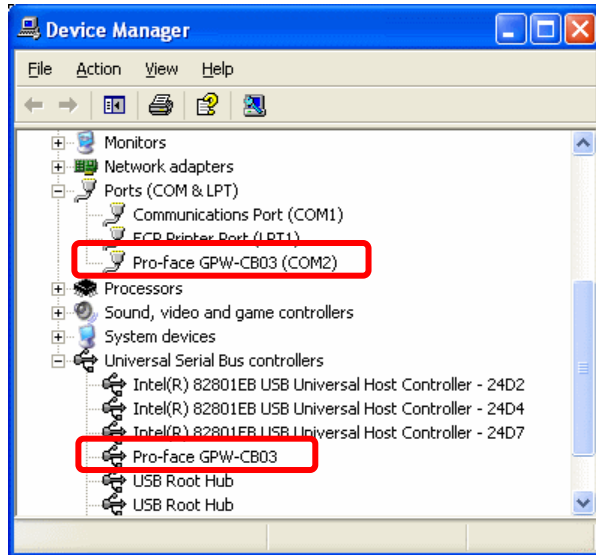

5. Select the [Transfer] menu and click [Receive..].

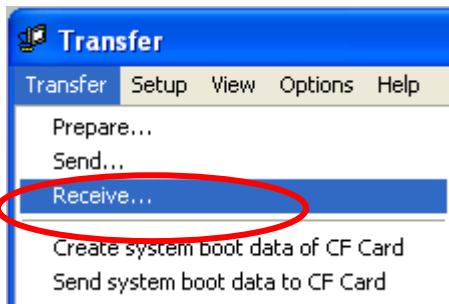

- Specify the location to save the received screen data at and the project file name and save them.

In case there is no Upload Information

"Upload Information" is necessary to receive screen data from LT Type A. It needs to be included in screen data when transferring screen data to the display unit beforehand. The Upload Information is sent to the display unit by default, however, you may check off the box of Upload Information to prevent screen reception by a third party.

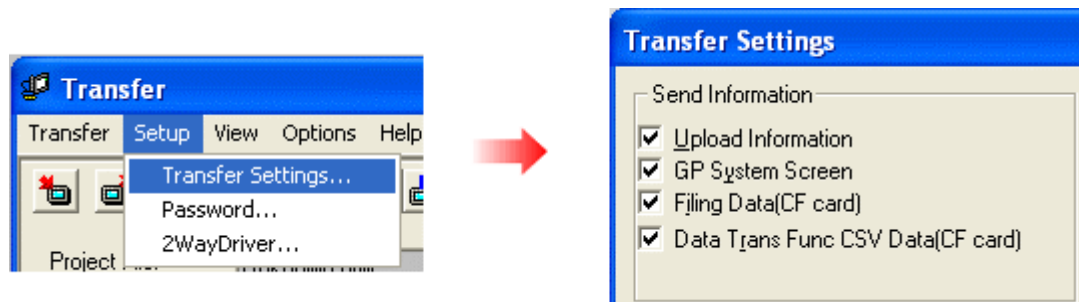

You can check in the following way if the Upload Information has been sent or not.

- Enter into the offline mode on LT Type A.
- If there are 2 asterisk (*) marks in the Main menu as shown below, the Upload Information has been sent.

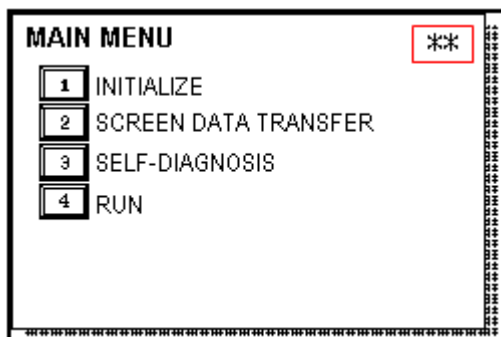

If not, there is no Upload Information sent. In this case, a message, which indicates there is no Upload Information," appears and you cannot receive the data.

3.4 Convert screen data with the Project Converter

Convert the project file (*.prw) for LT Type A with the GP-Pro EX's Project Converter.

1. Click the [Start] button, select [All Programs] ([Programs]->[Pro-face]->[GP-Pro EX *.**]->[Project Converter]) (For this part, [*.**], the version of the software you use is displayed.)

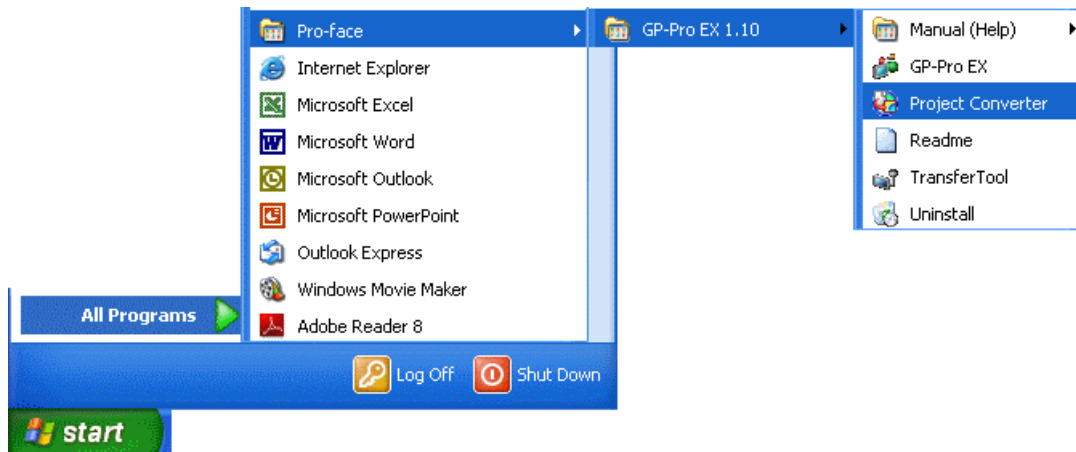

2. The Project Converter starts up and the [Project Converter] dialog box opens. Select [Project File (*.PRW)] in the [Data Type].

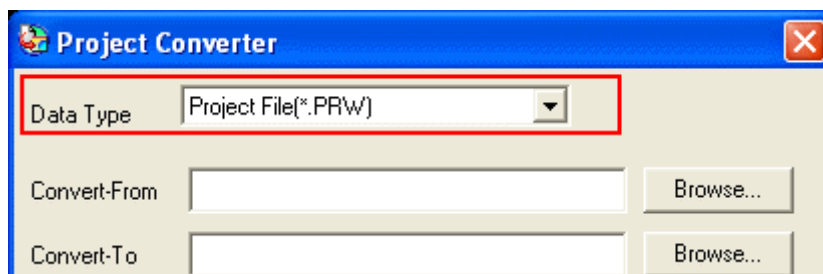

3. Click the [Browse...] button and select a project file (e.g.: "Project system A.prw"). Click [Open], and the file will be set in [Convert-From].

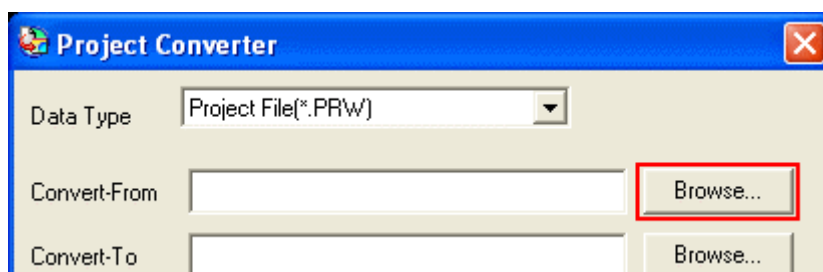

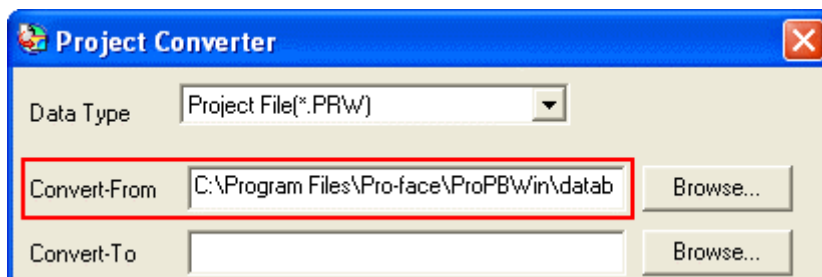
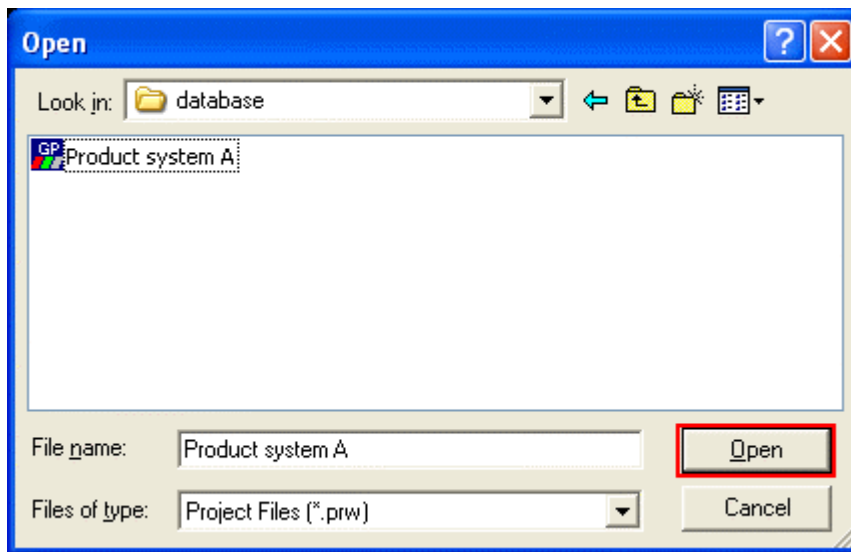

4. In [Convert-To], designate a GP-Pro EX's project file (*.prx). Click the [Browse...] button and enter a new [File Name] (e.g.: "Product system A.prx"). Click [Save], and a new project file will be set to [Convert-To].

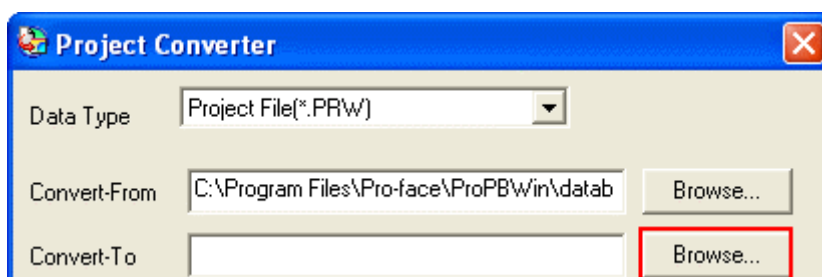

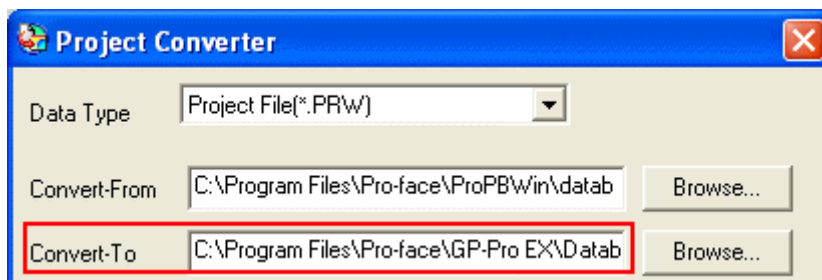
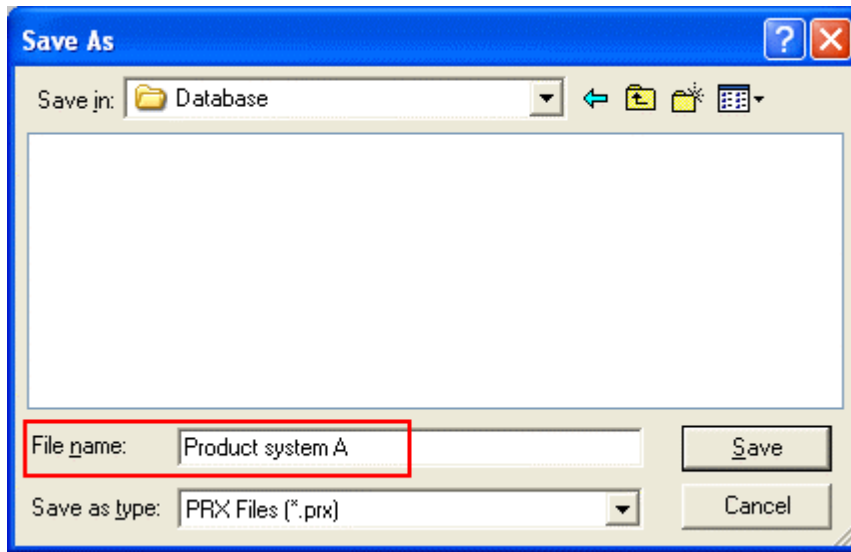

NOTE

When a convert-to file exists, the window that confirms whether or not to overwrite the file is displayed.

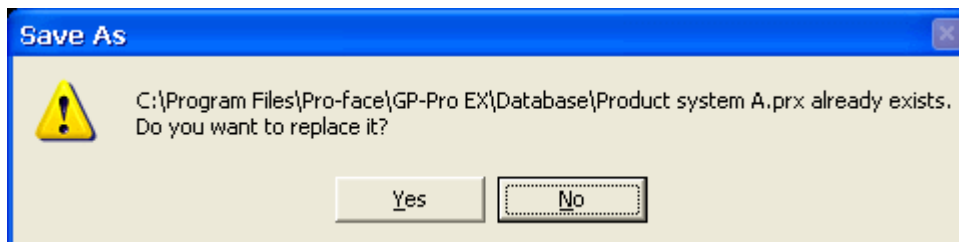

5. Click [Convert] and start the conversion.

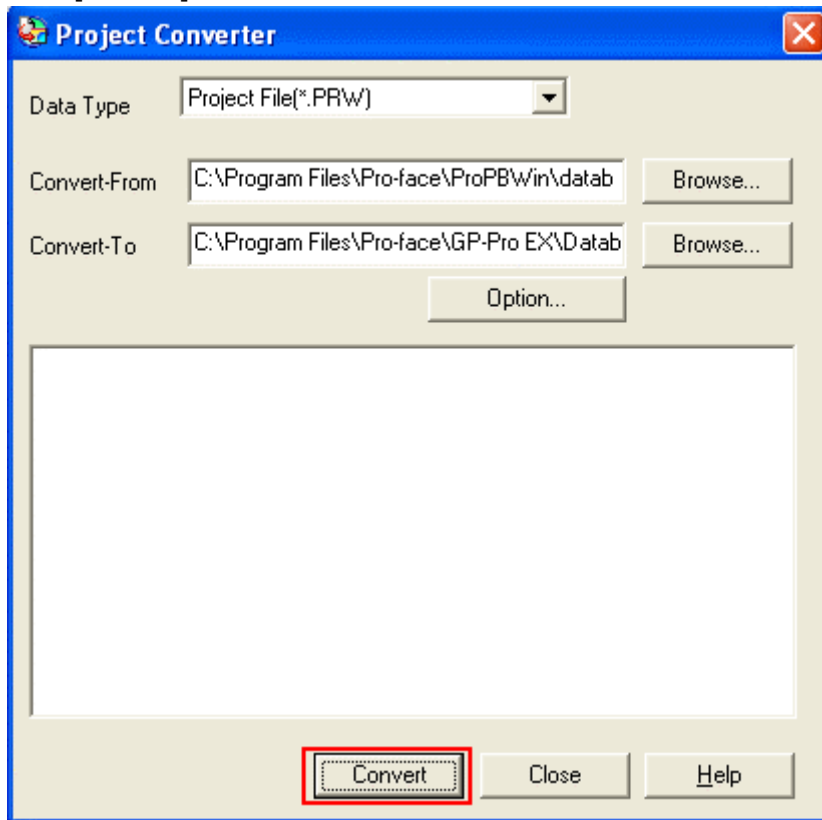

6. If you are asked about the [Convert-To] type as shown below, select the replacement model name on the pull-down menu. Click [OK].

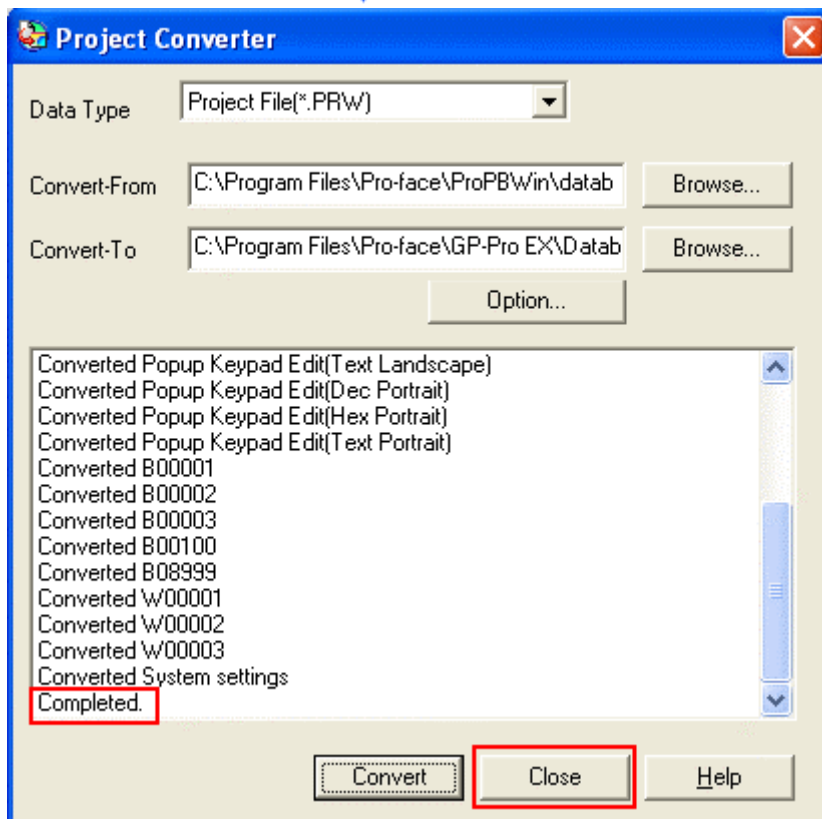
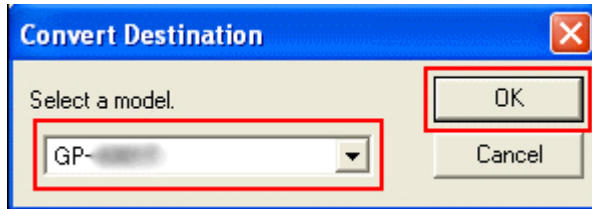

If an error message is displayed during conversion...

If an error message is displayed during conversion, refer to [Project Converter Error Message]

(http://www.pro-face.com/otasuke/qa/gp3000/replace/soft/conv/project_converter_error.html) on our Web site called [OtasukePro!] for the cause and the solution.

7. After conversion, the [Save convert information] dialog box appears. If you click [Save], you can save the conversion information in a CSV file format.

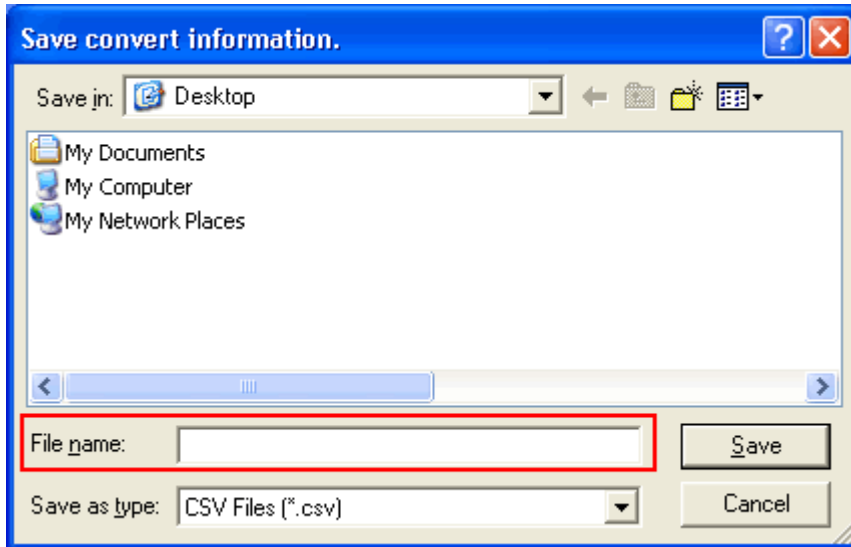

NOTE

Because the differences at the time of conversion from GP-Pro/PBIII for Windows are described in the saved file, the project file (*.prx) after conversion can be checked and modified according to the conversion information.

8. Click [Close] to close the [Project Converter] dialog box.
9. If you double click the project file (*.prx) after conversion, GP-Pro EX will start and the file will open.

3.5 Transfer the project file to LT-3300T.

Transfer the project file after conversion to LT-3300T.

You can transfer data to LT-3300T via

- A USB transfer cable (model: CA3-USBCB-01)
- AUSB storage unit
- Ethernet

But this section explains, as an example, how to transfer screen data with a USB transfer cable (model: CA3-USBCB-01).



1. Connect your PC and LT-3300T with a USB transfer cable (model: CA3-USBCB-01). If the driver of the cable has not been installed on your PC yet, a dialog box will appear. Please follow the instructions.

NOTE

The "Hardware Installation" dialog box as shown below may appear during installing the USB driver depending on a security level of Windows® XP. Click [Continue Anyway] to start installing the driver. When installation is completed, click [Finish].

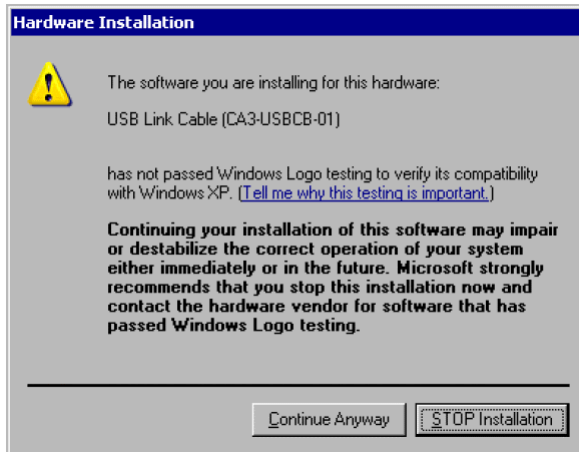

If the following symptoms appear on Microsoft Windows® 7, go to [updating "USB Data Transfer Driver"] on OtasukePro! (<http://www.pro-face.com/otasuke/>) for download.

- An error occurs when GP-Pro EX or Transfer Tool is installed.
- An error occurs when data is transferred via a USB transfer cable (model: CA3-USBCB-01).

2. Turn on the power of LT-3300T. The "Initial Start Mode" screen will appear on the display unit. After transferring a project file once, this screen will not appear again.



3. On the GP-Pro EX's State Toolbar, click the [Transfer Project] icon to open the Transfer Tool.

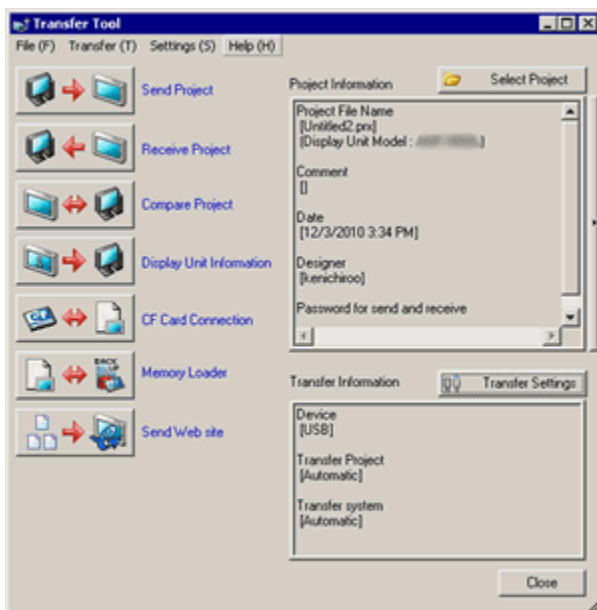

To transfer a different project file, click the [Select Project] button and select a project file.

- Make sure that the [unit] in the "Transfer Settings Information" is set to [USB]. If not, click the [Transfer Setting] button to open the "Transfer Setting" dialog box. Select [USB] in the Communication Port Settings field and click [OK].



- Click [Send Project] to start transfer. When the following dialog box appears, click [Yes]. This dialog box doesn't appear when the same project file is sent again.

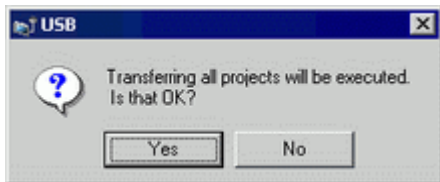

- The following dialog box appears during transfer and you can check the communication status. (The display unit enters the Transferring mode and communication with the unit such as a PLC is terminated.)

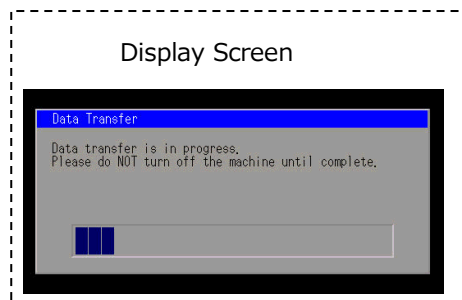
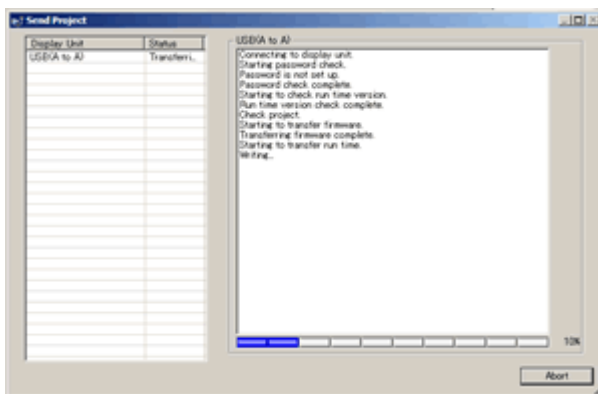

7. When transfer is completed, the status displayed in the dialog box will change from [Transferring] to [Complete Transfer]. Click [Close] to close the dialog box.

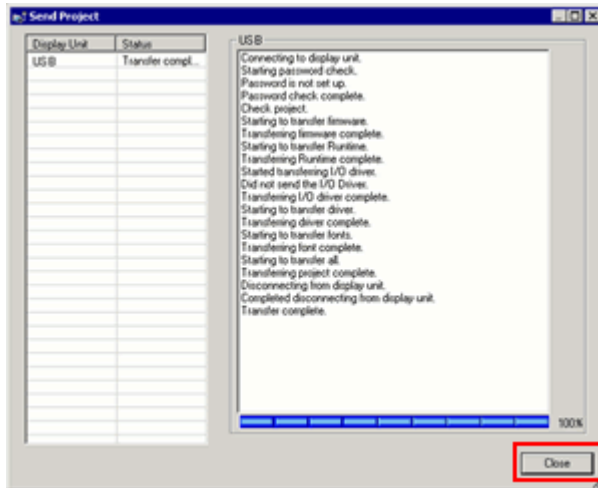

The display unit will be reset and a screen of the transferred project file will be displayed.

8. Close the Transfer Tool.
9. Click the [X] mark on top right of the screen or [Project]->[Exit] to close GP-Pro EX.

3.6 Differences of software

3.6.1 Differences after conversion

Check the differences of screen data after conversion from GP-PRO/PBIII to GP-Pro EX. For the details of each item, refer to our website.

<http://www.pro-face.com/otasuke/ga/gp3000/replace/soft/conv/care/3/>

Differences of software

Differences of screen data

1	Touch Panel Type
2	Compatibility of Bit Switch
3	Compatibility of Alarm
4	Compatibility of Trend Graph
5	Compatibility of K Tag (Input Order)
6	Compatibility of K Tag (Difference of Writing)
7	Compatibility of K Tag (Indirect Setting)
8	Compatibility of N Tag
9	Precautions for using the switch for [History Data Display] of Trend Graph on the window
10	About window display on a momentary switch during momentary operation
11	About the performance when a display area of the system window is overlapping
12	Change of Tag Process
13	About the display when a fixed Draw is placed on a Part
14	Compatibility of Text
15	Compatibility of Fill
16	Compatibility of CF Card Data
17	Precautions for conversion when filing data is saved in a CF card
18	Precautions for setting "Color Settings" to [256 Colors without blinking]
19	Precautions for loading a part with "L Tag (Library Display)"
20	Compatibility of MRK files and CPW files
21	Compatibility of V Tag/v tag and Video Screen
22	Compatibility of Extended SIO Script
23	Compatibility of Sound Data
24	Compatibility of unit Monitor
25	Compatibility of Ladder Monitor
26	Compatibility of J Tag and R Tag
27	Converting Screen Data of DOS
28	Compatibility of Standard Font
29	D Script starts right after screen change or power on.(Compatibility of D Script Trigger Condition)
30	The position shifts when loading a window screen (Compatibility of U Tag)
31	Precautions for using Screen Level Change
32	Compatibility of Symbol
33	Compatibility of H Tag

Logic Program Differences

1	Restriction Comparison	
	1-1	Comparison of Performance Specifications
2	Differences of Settings	
	2-1	Differences of Constant Scan Setting
	2-2	Controller Auto Start Setting
	2-3	Order of storing character string data
	2-4	Types of symbol variables to be used in a command
3	Setting Changes	
	3-1	Ladder Monitor Screen
	3-2	Conversion when a logic program error occurs
	3-3	Converting a logic file (*.WLL)
	3-4	DIO Drivers
	3-5	Differences for Bit Set of integer variables
	3-6	Setting an initial value of a variable
	3-7	Conversion of variables to be undefined addresses
	3-8	Restriction of array elements
	3-9	Assigning array variables via Configure I/O
	3-10	No drivers assigned
	3-11	The system variable '#Screen' for switching screens
	3-12	For Integer Array, when accessing a bit
	3-13	Differences of LS variables
4	Variable/Instruction Conversion	
	4-1	Differences of Fix Variable Mode
	4-2	Differences of LS variables
	4-3	Temporary variables
	4-4	Control block variables of the PID instruction
	4-5	Differences of system variables
	4-6	Instruction Conversion
	4-7	If the second operand of the PID instruction is an integer constant,
	4-8	Values of variables 'LS' and 'LSS'
5	Comment/Label Conversion	
	5-1	Program Comment
	5-2	The number of characters in a rung comment Rung comments including [START], [END], [SUBSTART**], or [SUBEND**] Capacity of a rung comment
	5-3	The number of characters in a variable comment Capacity of a variable comment Comments of reference variables
	5-4	User Label
	5-5	Subroutine
	5-6	Converting the project including comments entered on the OS in another language