

Easy! Smooth!

GP-3310, GP/ST-3400 Series

->GP4000 Series

Replacement Guidebook

Preface

This guidebook introduces the procedures to replace a unit in GP-3310T, GP/ST-3400 series with a GP-4401T unit.

Model in use	Model No.	Recommended Substitution
GP-3310T	AGP3310-T1-D24	GP-4401T
GP-3400T	AGP3400-T1-D24	
GP-3400S	AGP3400-S1-D24	
ST-3401T	AST3401-T1-D24	

Safety Information

HAZARD OF OPERATOR INJURY, OR UNINTENDED EQUIPMENT DAMAGE

Before operating any of these products, be sure to read all related manuals thoroughly.

Failure to follow these instructions can result in death, serious injury or unintended equipment damage.

GP4000 Series Model Number

GP4000 series model number partly differs depending on a specification. Before placing an order, please make sure of the model number.

PFXGP4 * 0 * * * * *

A

B

C

D

E

F

A	2	GP-4200 series (3.5")
	3	GP-4300 series (5.7")
	4	GP-4400 series (7.5"/7.0"W)
	5	GP-4500 series (10.4")
	6	GP-4600 series (12.1")
B	01	RS-232C/422/485
	03	RS-485 (isolation)
C	T	TFT color LCD
	W	TFT color LCD (Wide Type)
D	A	Analog Resistive Film Touch Panel
	M	Matrix Resistive Film Touch Panel
E	A	AC Type Power Supply
	D	DC Type Power Supply
F	W	GP-4201TW/4301TW/4401WW/4501TW
	C	Coated model
	WC	Coated model of GP-4301TW



Contents

<u>PREFACE</u>	<u>2</u>
<u>SAFETY INFORMATION</u>	<u>2</u>
<u>HAZARD OF OPERATOR INJURY, OR UNINTENDED EQUIPMENT DAMAGE</u>	<u>2</u>
<u>GP4000 SERIES MODEL NUMBER</u>	<u>3</u>
<u>CONTENTS</u>	<u>4</u>
<u>CHAPTER 1 SPECIFICATION COMPARISON</u>	<u>6</u>
1.1 SPECIFICATIONS OF GP-3310T AND GP-4401T	6
1.2 SPECIFICATIONS OF GP-3400T/S AND GP-4401T	8
1.3 SPECIFICATIONS OF ST-3401T AND GP-4401T	10
<u>CHAPTER 2 COMPATIBILITY OF HARDWARE</u>	<u>11</u>
2.1 LOCATIONS OF CONNECTOR	11
2.2 PANEL CUTOUT DIMENSIONS(FOR GP-3301T ONLY)	14
2.3 TRANSFER CABLE	14
2.4 INTERFACE	15
2.4.1 SERIAL INTERFACE	15
2.4.2 AUXILIARY I/O INTERFACE (AUX)	16
2.4.3 SOUND OUTPUT INTERFACE (FOR GP-3310T, GP-3400T/S ONLY)	16
2.4.4 CF CARD INTERFACE	16
2.5 PERIPHERAL UNITS AND OPTIONS	16
2.5.1 BARCODE READER CONNECTION	16
2.5.2 PRINTER CONNECTION	17
2.5.3 EXPANSION UNIT (FOR GP-3310T, GP-3400T/S ONLY)	17

2.5.4 ISOLATION UNIT (FOR GP-3310T, GP-3400T/S ONLY)	17
2.6 BACKUP BATTERY	18
2.7 POWER CONSUMPTION	18
2.8 MATERIALS/COLORS OF THE BODY	18
2.9 ABOUT LADDER MONITOR	18
2.10 OTHER NOTES	19
<u>CHAPTER 3 REPLACEMENT PROCEDURE</u>	<u>20</u>
3.1 WORK FLOW	20
3.2 PREPARATION	21
3.3 RECEIVE SCREEN DATA FROM GP/ST-3400 SERIES	22
3.4 CHANGE THE DISPLAY UNIT TYPE	28
3.5 TRANSFER SCREEN DATA TO GP-4401T	29
3.6 DIFFERENCES OF SOFTWARE	33
<u>CHAPTER 4 COMMUNICATION WITH DEVICE/PLC</u>	<u>34</u>
4.1 DRIVERS	34
4.2 SHAPES OF COM PORTS	34
4.3 SIGNALS OF COM PORTS	35
4.3.1 SIGNALS OF COM1	35
4.3.2 SIGNALS OF COM2	38
4.4 MULTILINK CONNECTION	39
4.5 CABLE DIAGRAM AT THE TIME OF REPLACEMENT	40
<u>CHAPTER 5 APPENDIX</u>	<u>43</u>
5.1 CHANGING THE SETTING OF THE EXTERNAL MEDIA TO USE	43



Chapter 1 Specification Comparison

1.1 Specifications of GP-3310T and GP-4401T

		GP-3310T	GP-4401T
			
Display Type		TFT color LCD	
Display Colors		65,536 colors (without blink)/ 16,384 colors (with blink)	
Display Resolution		VGA (640×480 pixels)	
Panel Cutout Dimensions (mm)		156(W)×123.5(H)	NEW! 204.5(W)×159.5(H) -> See 2.2
External Dimensions (mm)		167.5(W)×135(H)×59.5(D)	NEW! 218(W)×173(H)×60(D) -> See 2.2
Touch Panel Type		Resistive film (Analog)	
Memory	Application	8MB	UP! 32MB
	SRAM	320KB	
Backup Battery		Secondary Battery (Rechargeable Lithium battery)	NEW! Primary Battery (Replaceable Lithium battery) -> See 2.5
Input Voltage		DC 24V	
Serial I/F	COM1	D-Sub 9 pin (plug) RS-232C/422/485	NEW! D-Sub 9 pin (plug) RS-232C -> See 2.4.1 and Chapter4
	COM2	D-Sub 9 pin (socket) RS-422/485	NEW! D-Sub 9 pin (plug) RS-422/485 -> See 2.4.1 and Chapter4
Ethernet I/F		10BASE-T/100BASE-TX	
CF Card I/F		✓	- -> See 2.4.4
SD Card I/F		-	NEW! ✓

USB I/F	Type A	✓	✓ -> See 2.3
	Type mini B	-	✓ -> See 2.3
Sound Output I/F		Speaker Output : 70mW	- -> See 2.4.3
Expansion Unit I/F		✓	- -> See 2.5.3
Software		GP-Pro EX 2.50 or more	GP-Pro EX 3.00 or more



1.2 Specifications of GP-3400T/S and GP-4401T

		GP-3400T/S	GP-4401T
			
Display Type	GP-3400T	TFT color LCD	UP! TFT color LCD
	GP-3400S	STN color LCD	
Display Colors	GP-3400T	65,536 colors (without blink)/ 16,384 colors (with blink)	UP! 65,536 colors (without blink)/ 16,384 colors (with blink)
	GP-3400S	4,096 colors	
Display Resolution		VGA (640×480 pixels)	
Panel Cutout Dimensions (mm)		204.5(W)x159.5(H)	
External Dimensions (mm)		215(W)x170(H)x60(D)	NEW! 218(W)x173(H)x60(D)
Touch Panel Type		Resistive film (Analog)	
Memory	Application	16MB *	UP! 32MB
	SRAM	320KB	
Backup Battery		Secondary Battery (Rechargeable Lithium battery)	NEW! Primary Battery (Replaceable Lithium battery) -> See 2.6
Input Voltage		DC 24V	
Serial I/F	COM1	D-Sub 9 pin (plug) RS-232C/422/485	NEW! D-Sub 9 pin (plug) RS-232C -> See 2.4.1 and Chapter4
	COM2	D-Sub 9 pin (socket) RS-422/485	NEW! D-Sub 9 pin (plug) RS-422/485 -> See 2.4.1 and Chapter4
Ethernet I/F		10BASE-T/100BASE-TX	
CF Card I/F		✓ (Type-II)	- -> See 2.4.4
SD Card I/F		-	NEW! ✓
USB I/F	Type A	✓	✓ -> See 2.3
	Type mini B	-	✓ -> See 2.3

Auxiliary I/O I/F	✓	- -> See 2.4.2
Sound Output I/F	✓	- -> See 2.4.3
Expansion Unit I/F	✓	- -> See 2.5.3

* 8MB available if the revision of the unit is earlier than Rev. 4, or GP-Pro EX Ver. 2.5 or earlier is used.

1.3 Specifications of ST-3401T and GP-4401T

		ST-3401T	GP-4401T
			
Display Type		TFT color LCD	
Display Colors		256 colors	UP! 65,536 colors (without blink)/ 16,384 colors (with blink)
Display Resolution		VGA (640×480 pixels)	
Panel Cutout Dimensions (mm)		204.5(W)×159.5(H)	
External Dimensions (mm)		215(W)×170(H)×60(D)	218(W)×173(H)×60(D)
Touch Panel Type		Resistive film (Analog)	
Memory	Application	6MB	UP! 32MB
	SRAM	320KB	
Backup Battery		Secondary Battery (Rechargeable Lithium battery)	NEW! Primary Battery (Replaceable Lithium battery) -> See 2.6
Input Voltage		DC 24V	
Serial I/F	COM1	D-Sub 9 pin (plug) RS-232C	
	COM2	D-Sub 9 pin (plug) RS-422/485	
Ethernet I/F		-	NEW! 10BASE-T/100BASE-TX
CF Card I/F		✓	- -> See 2.4.4
SD Card I/F		-	NEW! ✓
USB I/F	Type A	✓	✓ -> See 2.3
	Type mini B	-	✓ -> See 2.3

Chapter 2 Compatibility of Hardware

2.1 Locations of connector

Connector locations on GP-3310T, GP-3400T/S, ST-3401T and GP-4401T are as follows:

GP-3310T

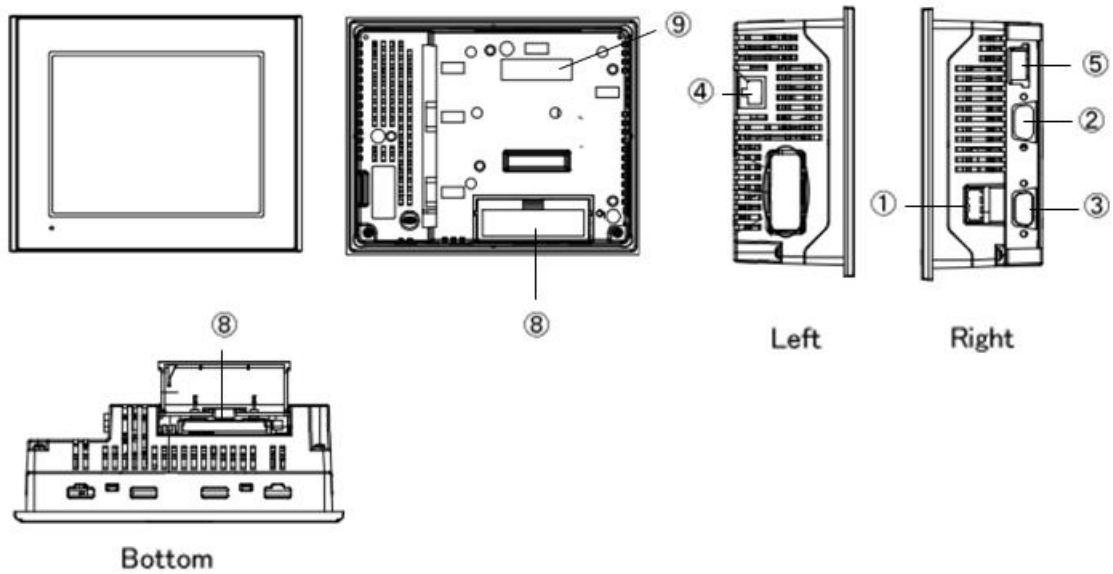

GP-3400T/S

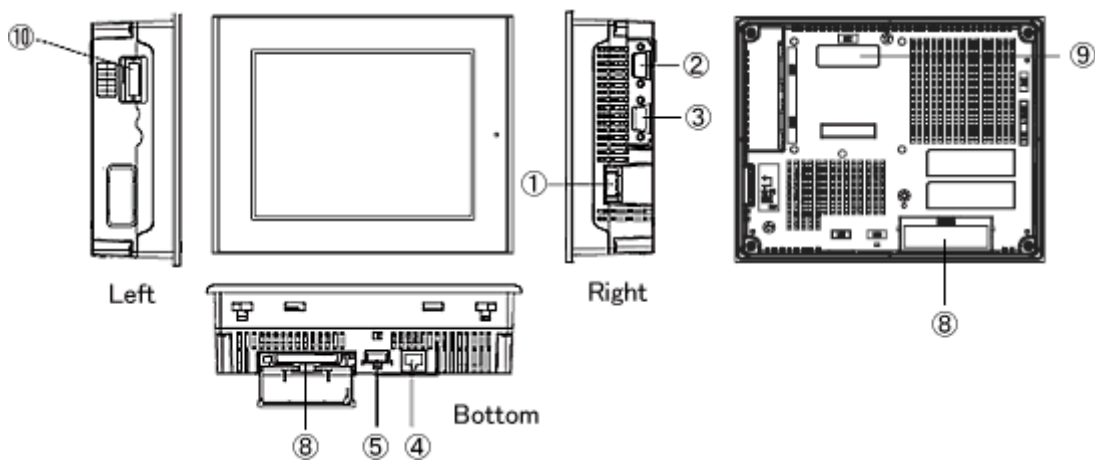

ST-3401T

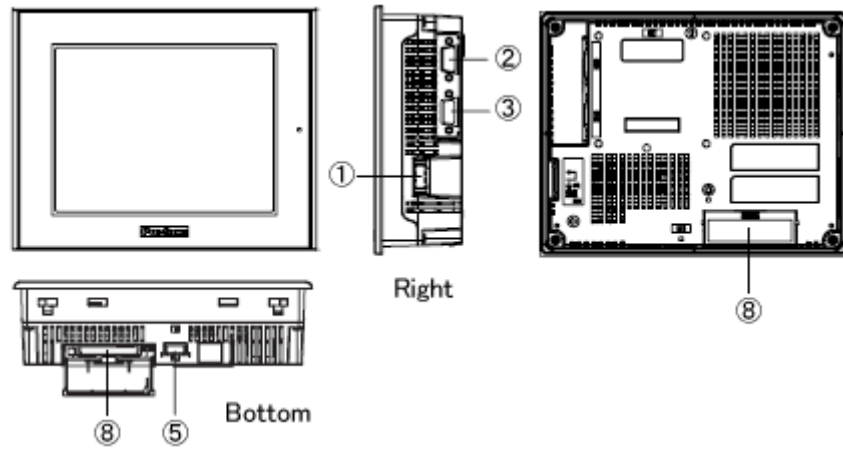

GP-4401T

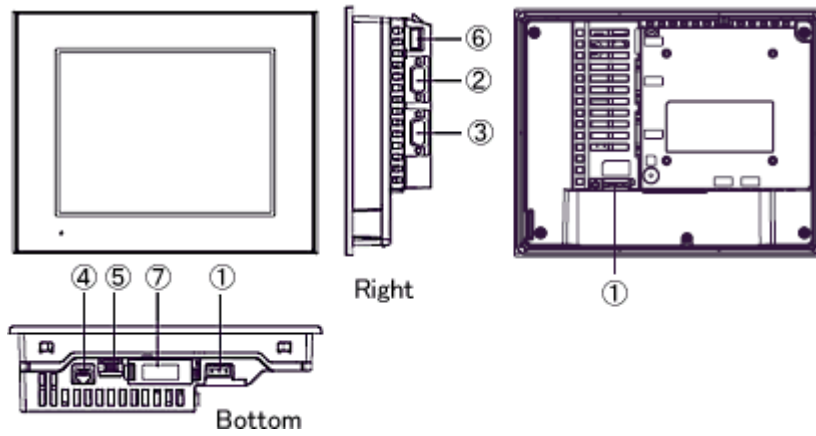

Interface names

	GP-3310T	GP-3400T/S	ST-3401T	GP-4401T
1	Power Connector			
2	Serial Interface (COM1)			
3	Serial Interface (COM2)			
4	Ethernet Interface		-	Ethernet Interface
5	USB Interface (Type A)			
6		-		USB Interface (Type mini B)
7		-		SD Card Interface
8	CF Card Interface			-
9	Expansion Unit Interface			-
10	-	Auxiliary Input/Output (AUX)/ Sound Output		-



2.2 Panel Cutout Dimensions(for GP-3301T only)

For replacing GP-3301T with GP-4401T, the panel cutout dimensions get larger. It's necessary to process the panel.

2.3 Transfer cable

To transfer screen data to GP-4401T, use a USB transfer cable or Ethernet.

The USB cables that can be used for GP-4401T are as follows:

	Model	Connector Type	Connector on GP
Options	CA3-USBCB-01		USB (Type A)
	ZC9USCBMB1		USB (Type mini B)
Commercial Item	-		

The same USB transfer cable (CA3-USBCB-01) as the one for GP-3310T, GP/ST-3400 series can be used.

2.4 Interface

2.4.1 Serial Interface

The pin assignment and the shape of plug/socket connector of ST-3401T are the same as those of GP-4401T, but GP-3310T, GP-3400T/S's are different.

To know the details about them, see [[4.2 Shapes of COM ports](#)] and [[4.3 Signals of COM ports](#)].

Because of it, the existing PLC connection cables for GP-3310T, GP-3400T/S cannot be used as they are. If you use the existing connection cables, see [[4.5 Cable Diagram at the time of replacement](#)].

* For GP-3310T, GP-3400T/S only:

When both the COM1 port and the COM2 port have the RS-422/485 setting, only the COM2 port can be used for RS-422/485 connection after replacement.

Using a USB/RS-422/485 Conversion Adapter (PFXZCBCBCVUSR41) may allow you to use GP4000 series' USB interface as RS-422/485 serial interface for connection.

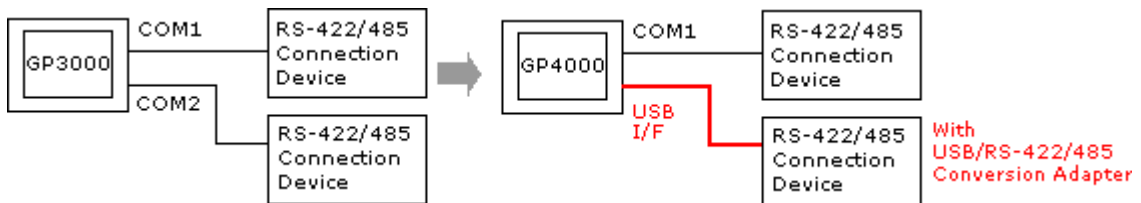

For more information, please refer to USB/RS-422/485 Conversion Adapter Installation Guide.

(<http://www.pro-face.com/otasuke/download/manual/cgi/manual.cgi?mode=33&cat=3>)

IMPORTANT

When using USB/RS-422/485 Conversion Adapter (PFXZCBCBCVUSR41) with a display unit, the device/PLCs you can connect to its serial interface (RS-422/485) are limited. To check the connection configuration, please refer to USB/RS-422/485 Conversion Adapter Connection Guide (http://www.pro-face.com/otasuke/files/manual/gpproex/new/device/data/com_usc.pdf)

2.4.2 Auxiliary I/O Interface (AUX)

GP-4401T is not equipped with Auxiliary I/O Feature. External Reset Input and 3 Outputs (RUN Output, System Alarm Output, and External Buzzer Output) that can be used for GP-3310T, GP-3400T/S cannot be used.

2.4.3 Sound Output Interface (for GP-3310T, GP-3400T/S only)

GP-4401T is not equipped with the sound output function. The sound output function for GP-3310T, GP-3400T/S cannot be used.

In order to continue to use the sound output function, please consider replacement with SP-5400x (Power Box).

2.4.4 CF Card Interface

GP-4401T is not equipped with a CF card slot. But a SD card slot and a USB interface are installed in it. In order to use the GP-3310T, GP/ST-3400 series data saved in the CF card and the functions using the CF card, use a SD card or a USB flash drive instead.

* When using a SD card with GP-4401T, please verify it supports the following specifications:

	File format	Maximum capacity
SD	FAT16	2GB
SDHC	FAT32	32GB

When the setting of the output destination folder is set to "CF Card" on GP-Pro EX, if the display unit type is changed, the setting will be automatically changed to the one that uses a SD card.

To change the setting of the output destination folder, see [[5.1 Changing the setting of the external media to use](#)].

2.5 Peripheral units and options

2.5.1 Barcode reader connection

Like GP-3310T, GP/ST-3400 series, GP-4401T allows you to connect a barcode

reader on its USB interface (Type A) or its serial interface.

For the models GP-4401T supports, see [OtasukePro!]

(http://www.pro-face.com/otasuke/qa/3000/0056_connect_e.html).

2.5.2 Printer connection

Like GP-3310T, GP/ST-3400 series, GP-4401T allows you to connect a printer on its USB interface (Type A).

For the models GP-4401T supports, see [OtasukePro!]

(http://www.pro-face.com/otasuke/qa/3000/0056_connect_e.html).

2.5.3 Expansion Unit (for GP-3310T, GP-3400T/S only)

GP-4401T is not equipped with an expansion unit interface. The expansion units (each kind of unit like CC-LINK Unit) for GP-3310T, GP-3400T/S cannot be used.

2.5.4 Isolation Unit (for GP-3310T, GP-3400T/S only)

RS-485 isolation unit for GP-3310T, GP-3400 series (CA3-ISO485-01) cannot be used for GP-4401T. You can use RS-232C isolation unit (CA3-ISO232-01) for GP-4401T instead.

Note for using RS-232C isolation unit (CA3-ISO232-01)

- Connect it to GP4000 series via COM1 (232C). COM2 cannot be used.
- It's necessary to set the 9th pin of the COM port to VCC.
[Settings on GP-ProEX]
Select "VCC" from [System Settings] -> [Device/PLC] in the [Project] menu on GP-Pro EX.

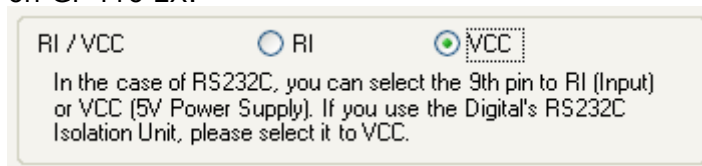

- RS-422/485 (2-wire type) communication and serial multilink are not supported.

2.6 Backup Battery

Unlike GP-3310T, GP/ST-3400 series, GP-4401T does not use rechargeable secondary batteries but replaceable primary ones. (For both a rechargeable type and a replaceable one, contents to be backed up are the same.)

When the time for replacement of backup batteries approaches, the message to urge you to replace the battery, "RAAA053: Running out of power in the backup battery. Please change the battery." appears. When the message appears, replace the battery referring to the GP4000 series hardware manual.

Replaceable Battery Model
PFXZCBBT1

2.7 Power Consumption

The power consumption of GP-3310T, GP/ST-3400 series is different from that of GP-4401T.

GP-3310T	GP-3400T/S	ST-3401T	GP-4401T
26W or less	28W or less	22W or less	12W or less

For the detailed electric specifications, see the hardware manual.

2.8 Materials/Colors of the body

The materials and the colors of GP/ST-3000 series and GP-4401T are as follows:

	GP-3000 Series	ST-3401T	GP-4401T
Color	Silver	Light Gray	
Material	Aluminum alloy	Resin	Resin with glass

2.9 About Ladder monitor

PLC Ladder monitor tool cannot be used for GP4000 series.

2.10 Other Notes

- Do not expose GP4000 series to direct sunlight.
- Do not use GP4000 series outdoors.
- Do not turn on GP4000 series if condensation has occurred inside the device.
- When you are continuously using GP4000 series without oxygen, the brightness might decrease. Please ventilate the control panel periodically.

Chapter 3 Replacement Procedure

3.1 Work Flow

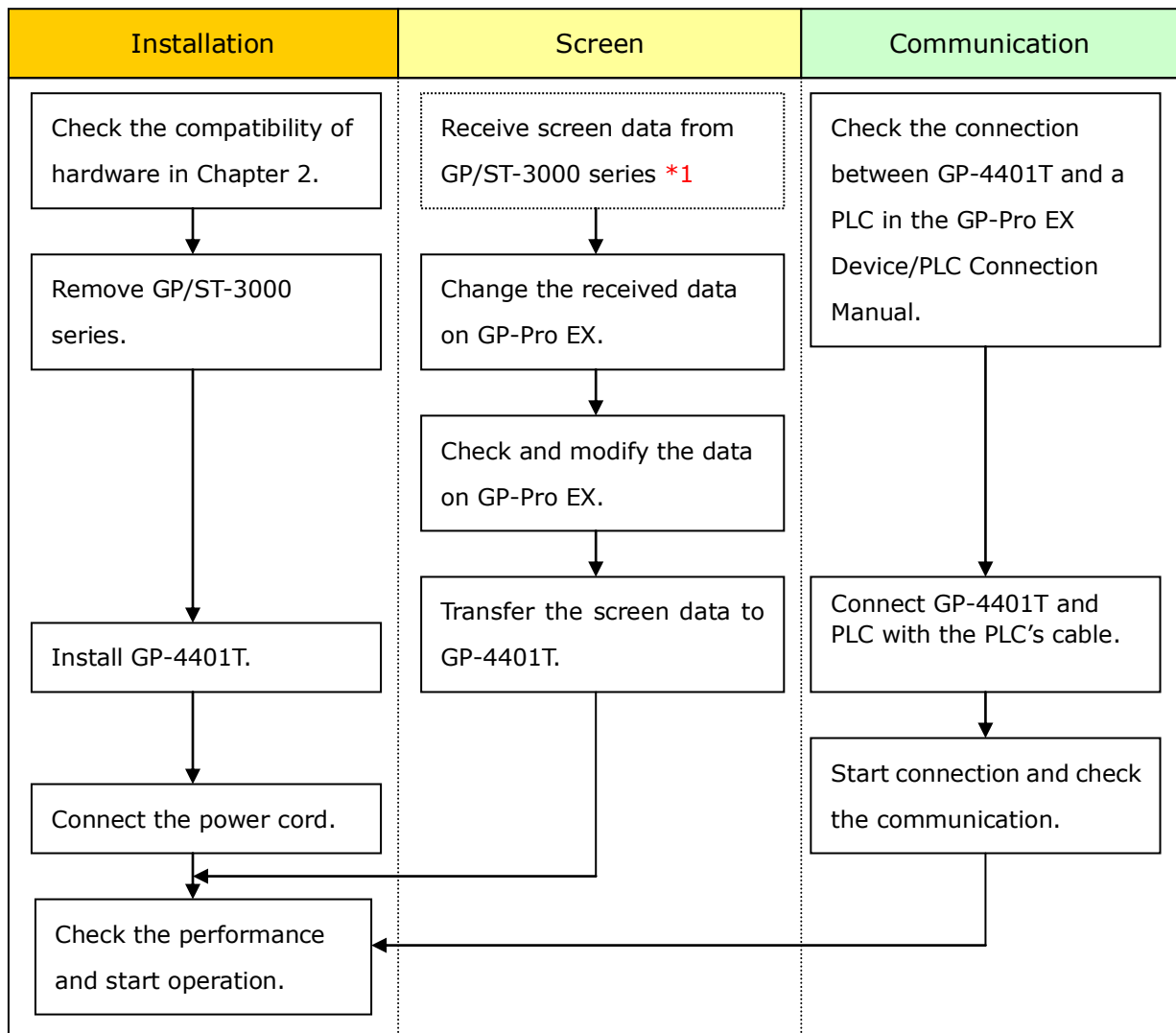

*1: This step is required if screen data is saved only in the GP unit, not in any other device.

3.2 Preparation

Requirements for receiving screen data from GP/ST-3000 series *1	PC in which GP-Pro EX Transfer Tool is installed. *2
	USB Transfer Cable (model: CA3-USBCB-01) *Possible to send/receive a screen via a CF card, an USB storage device, or Ethernet (for GP-3310T, GP-3400T/S only).
Requirements for converting screen data of GP/ST-3000 series and transferring the converted data to GP-4401T	PC in which GP-Pro EX Ver.3.01 or later is installed.
	Transfer Cable (The following three types of cables are available) <ul style="list-style-type: none"> • An USB transfer cable (model: CA3-USBCB-01) • An USB data-transfer cable (model: ZC9USCBMB1) • A commercial USB cable (USB Type A/mini B) *Possible to send/receive a screen via a SD card, an USB storage device, or Ethernet.

*1: This step is required if screen data is saved only in the GP unit, not in any other device.

*2: Please use the same version or later as or than that of the software used during creating screens on GP/ST-3000 series. If you don't know the version, we recommend you to use the newest version. For the newest version, you can download the transfer tool from our web site called [OtasukePro!] (http://www.pro-face.com/otasuke/download/freesoft/gpproex_transfer.htm)

3.3 Receive screen data from GP/ST-3400 series

You can transfer data to GP/ST-3000 series via

- An USB transfer cable (model: CA3-USBCB-01)
- A CF card/USB storage device
- Ethernet (for GP-3310T, GP-3400T/S only)

But this section explains, as an example, how to receive screen data from GP/ST-3000 series using an USB transfer cable (model: CA3-USBCB-01).

If you have backed up screen data, this step is unnecessary, skip to the next section [[3.4 Change the Display Unit Type](#)].



PC



USB transfer cable
(CA3-USBCB-01)



GP

(1) Connect your PC and GP/ST-3000 series with an USB transfer cable.

If the driver of the cable has not been installed on your PC yet, a dialog box will appear. Please follow the instructions.

NOTE

- The "Hardware Installation" dialog box as shown below may appear during installing the USB driver depending on the security level of Windows® XP. Click [Continue Anyway] to start installing the driver. When installation is completed, click [Finish].

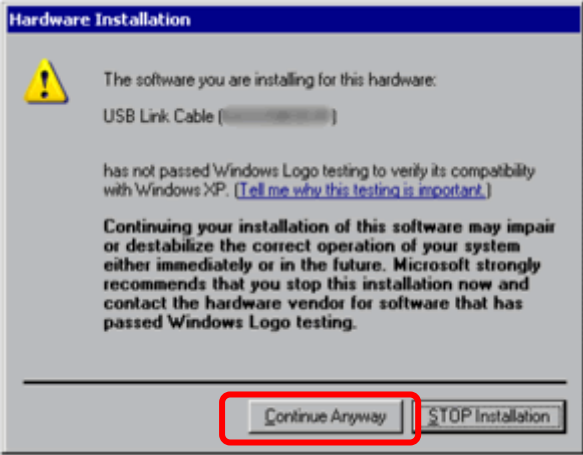

- If the following symptoms appear on Microsoft Windows® 7, go to updating "USB Data Transfer Driver" on [OtasukePro!] for download (http://www.pro-face.com/otasuke/download/freesoft/gproex_transfer.htm).
- An error occurs when GP-Pro EX or Transfer Tool is installed
- An error occurs when data is transferred via a USB transfer cable (model: CA3-USBCB-01).

(2) Start the Transfer Tool of GP-Pro EX.

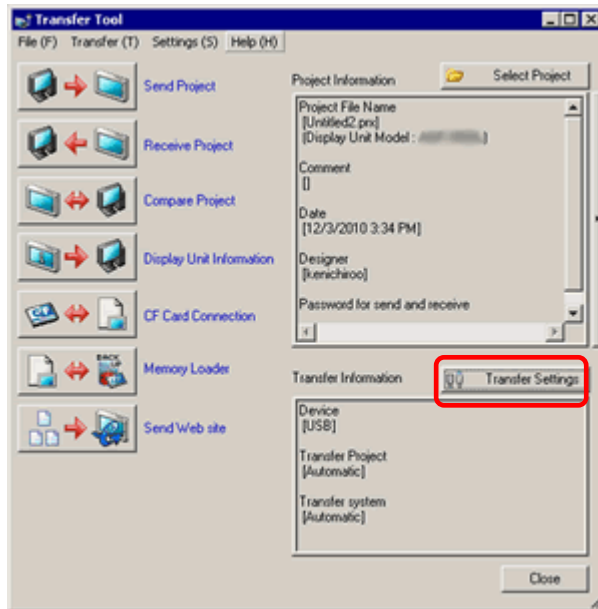

(3) Make sure that the [Device] in the "Transfer Settings Information" is set to [USB]. If not, click the [Transfer Setting] button to open the "Transfer Setting" dialog box. Select [USB] in the Communication Port Settings field and click [OK].

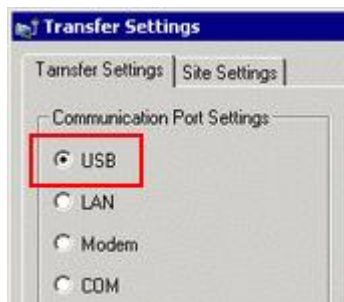

(4) Start GP-Pro EX Transfer Tool and click the [Receive Project] button.



(5) Click [Receive Project], and the following dialog box will appear. Specify a place to save the received data in and a project file name, and then click [Save] to start transfer.

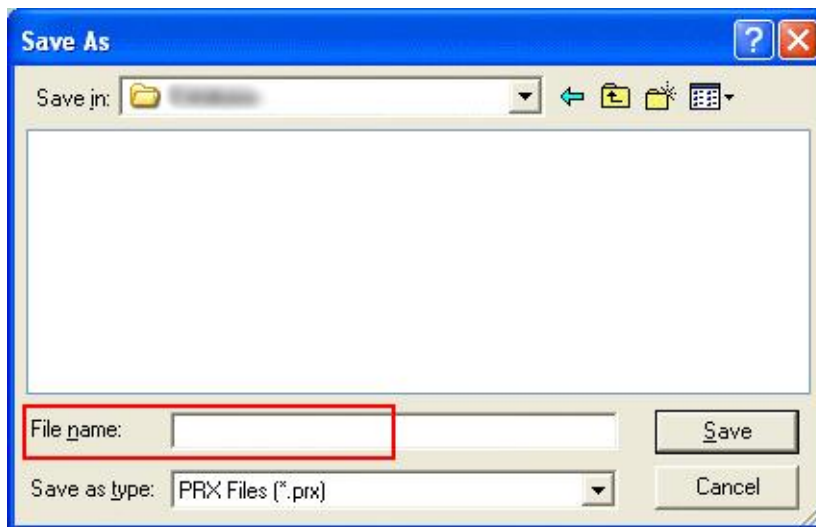

NOTE

When a file exists, the window that confirms whether or not to overwrite the file is displayed.

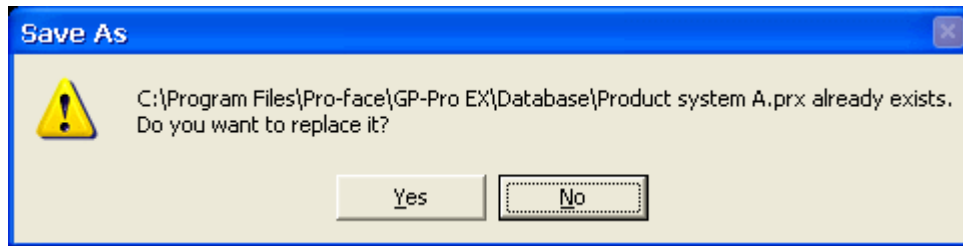

(6) The following dialog box appears during transfer and you can check the communication status. (The display unit enters the Transferring mode and communication with the device such as a PLC is terminated.)

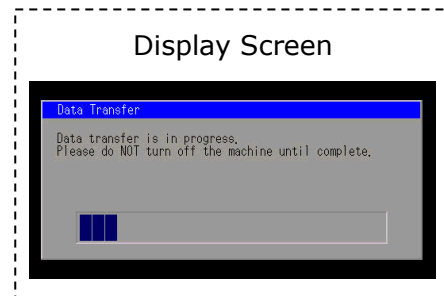
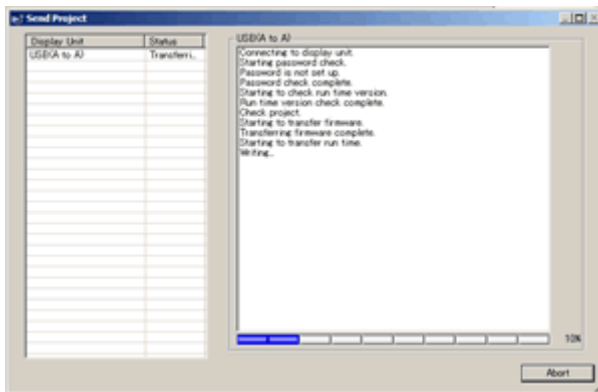

NOTE

- If you receive the project files that use CF card data such as Recipe Function (CSV data), the following dialog box will appear during transfer. Specify a place to save the CF card data in. Click [OK], and the [Receive Project] dialog box will return and transfer will be completed.



- GP-4401T that is a replacement model is not equipped with a CF card slot. If the display unit type is changed to GP-4401T, the CF card setting will be replaced with the SD card setting automatically.
To check or change the destination folder setting, see [\[5.1 Changing the setting of the external media to use\]](#).

- (7) When transfer is completed, the status displayed in the dialog box will change from [Transferring] to [Complete Transfer]. Click [Close] to close the dialog box.

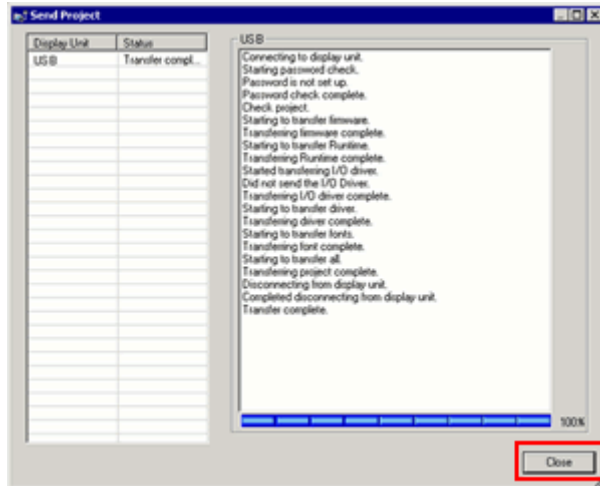

- (8) Close the Transfer Tool.

3.4 Change the Display Unit type

Open the received project file (*.prx) of GP/ST-3000 series on GP-Pro EX and change the display unit type to GP-4401T.

- (1) Open the received project file (*.prx) on GP-Pro EX.
- (2) Click [System Settings]->[Display]->[Change Display] in [Project] menu and change the Display Unit type to GP-4401T.
- (3) Click [Project]->[Save As] and save the changed project file.

3.5 Transfer screen data to GP-4401T

Transfer the project file after display unit type change to GP-4401T.

You can transfer data to GP-4401T via

- An USB transfer cable (model: CA3-USBCB-01)
- An USB data transfer cable (model: ZC9USCBMB1)
- A commercial USB cable (USB Type A/mini B)
- An USB storage device/SD card
- Ethernet

But this section explains, as an example, how to transfer screen data via an USB transfer cable (model: CA3-USBCB-01).



- (1) Connect your PC and the GP unit of GP-4401T with an USB transfer cable. If the driver of the cable has not been installed on you PC, a dialog box will appear. Please follow the instructions.

NOTE

- The "Hardware Installation" dialog box as shown below may appear during installing the USB driver depending on the security level of Windows® XP. Click [Continue Anyway] to start installing the driver. When installation is completed, click [Finish].

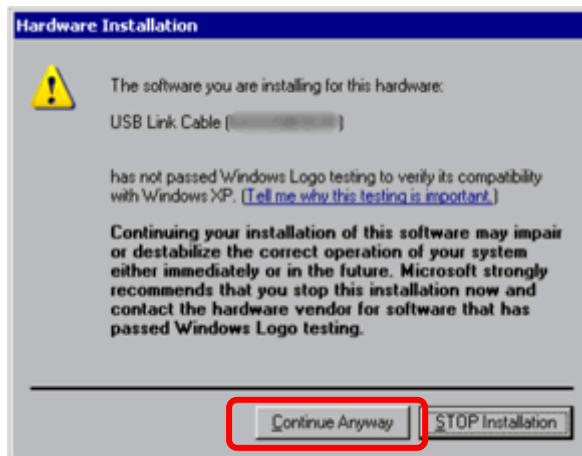

- If the following symptoms appear on Microsoft Windows® 7, go to updating "USB Data Transfer Driver" on [OtasukePro!] for download (http://www.pro-face.com/otasuke/download/freesoft/gpproex_transfer.htm).
- An error occurs when GP-Pro EX or Transfer Tool is installed
- An error occurs when data is transferred via a USB transfer cable (model: CA3-USBCB-01).

- (2) Turn on the power of GP-4401T. The "Initial Start Mode" screen will appear on the display unit. After transferring a project file once, this screen will not appear again.



- (3) On the GP-Pro EX's State Toolbar, click the [Transfer Project] icon to open the Transfer Tool.

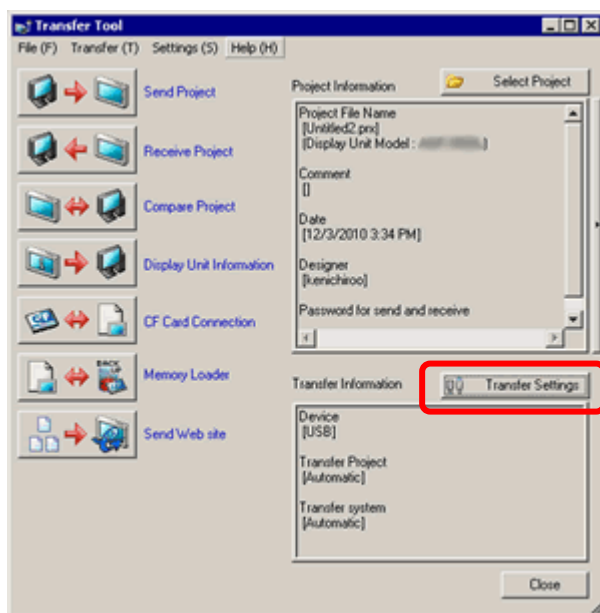

To transfer a different project file, click the [Select Project] button and select a project file.

- (4) Make sure that the [Device] in the "Transfer Settings Information" is set to [USB]. If not, click the [Transfer Setting] button to open the "Transfer Setting" dialog box. Select [USB] in the Communication Port Settings field and click [OK].



- (5) Click [Send Project] to start transfer. When the following dialog box appears, click [Yes]. This dialog box doesn't appear when the same project file is sent again.

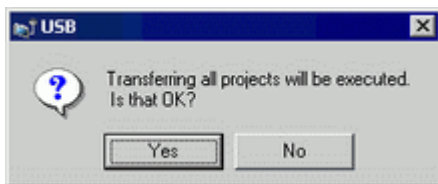

- (6) The following dialog box appears during transfer and you can check the communication status. (The display unit enters the Transferring mode and communication with the device such as a PLC is terminated.)

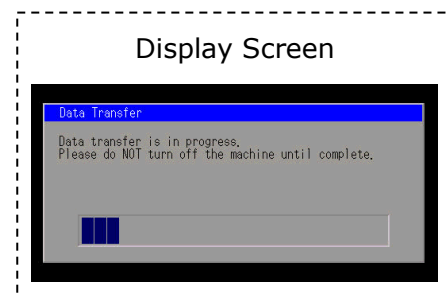
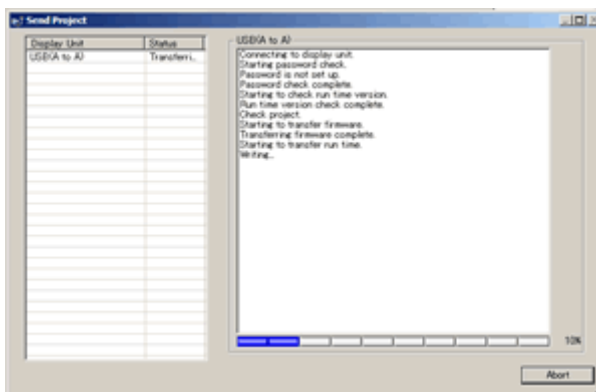

- (7) When transfer is completed, the status displayed in the dialog box will change from [Transferring] to [Complete Transfer]. Click [Close] to close the dialog box.

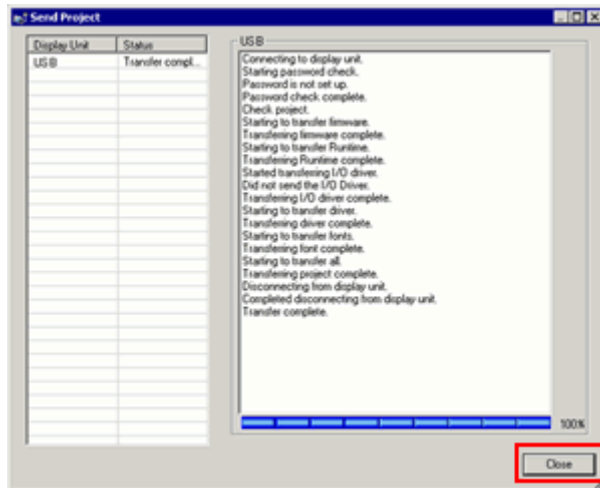

The display unit will be reset and a screen of the transferred project file will be displayed.

- (8) Close the Transfer Tool.
(9) Click the [X] mark on top right of the screen or [Project]->[Exit] to close GP-Pro EX.

3.6 Differences of software

Some functions supported by GP/ST-3400 series are not supported by GP-4401T. For details of the supported parts and functions, refer to [Supported Features] of GP-Pro EX Reference Manual

(<http://www.pro-face.com/otasuke/files/manual/gpproex/new/refer/gpproex.htm>).

Chapter 4 Communication with Device/PLC

4.1 Drivers

More connectable drivers will be added.

For the devices/PLC each driver supports, see [Connectable Devices] (<http://www.pro-face.com/product/soft/gpproex/driver/driver.html>).

4.2 Shapes of COM ports

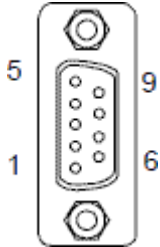
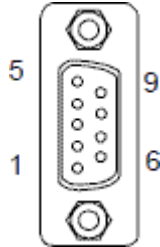
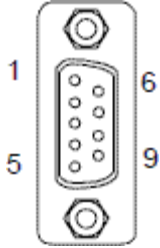
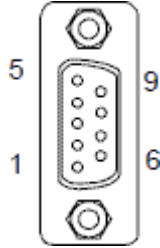
	GP-3400T/S, GP-3310T	ST-3401T	GP-4401T
COM1	D-Sub 9 pin (plug) RS-232C/422/485	D-Sub 9 pin (plug) RS-232C	
			
COM2	D-Sub 9 pin (socket) RS-422/485	D-Sub 9 pin (plug) RS-422/485	
			

4.3 Signals of COM ports

4.3.1 Signals of COM1

For GP-3310T, GP-3400T/S

RS-232C (plug)

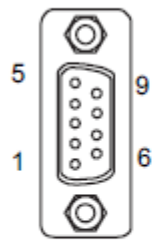
Pin Connection	Pin No.	RS-232C		
		Signal Name	Direction	Meaning
 <p>(GP unit side)</p>	1	CD	Input	Carrier Detect
	2	RD(RXD)	Input	Receive Data
	3	SD(TXD)	Output	Send Data
	4	ER(DTR)	Output	Data Terminal Ready
	5	SG	-	Signal Ground
	6	DR(DSR)	Input	Data Set Ready
	7	RS(RTS)	Output	Request to Send
	8	CS(CTS)	Input	Send possible
	9	CI(RI)/VCC	Input/-	Called Status Display +5V±5% Output 0.25A ^{*1}
	Shell	FG	-	Frame Ground (Common with SG)

*1: RI and VICC of Pin 9 are switched on the software.

VCC Output is not protected from overcurrent.

Please follow the current rating to avoid false operation or breakdown.

RS-422/485 (plug)

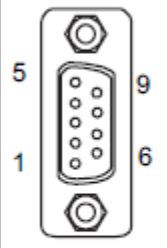
Pin Connection	Pin No.	RS-422/RS-485		
		Signal Name	Direction	Meaning
 <p>(GP unit side)</p>	1	RDA	Input	Receive Data A (+)
	2	RDB	Input	Receive Data B (-)
	3	SDA	Output	Send Data A (+)
	4	ERA	Output	Data Terminal Ready A (+)
	5	SG	-	Signal Ground
	6	CSB	Input	Send Possible B (-)
	7	SDB	Output	Send Data B (-)
	8	CSA	Input	Send Possible A (+)
	9	ERB	Output	Data Terminal Ready B (-)
	Shell	FG	-	Frame Ground (Common with SG)

For ST-3401T
RS-232C (plug)

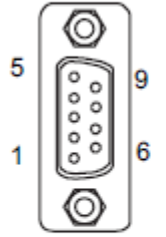
Pin Connection	Pin No.	RS-232C		
		Signal Name	Direction	Meaning
 <p>(GP unit side)</p>	1	CD	Input	Carrier Detect
	2	RD(RXD)	Input	Receive Data
	3	SD(TXD)	Output	Send Data
	4	ER(DTR)	Output	Data Terminal Ready
	5	SG	-	Signal Ground
	6	DR(DSR)	Input	Data Set Ready
	7	RS(RTS)	Output	Request to Send
	8	CS(CTS)	Input	Send possible
	9	CI(RI)/VCC	Input/-	Called Status Display +5V±5% Output 0.25A ^{*1}
	Shell	FG	-	Frame Ground (Common with SG)

*1: RI and VCC of Pin 9 are switched on the software.

VCC Output is not protected from overcurrent.

Please follow the current rating to avoid false operation or breakdown.

For GP-4401T
RS-232C (plug)

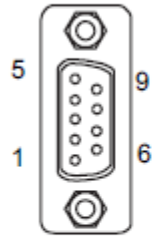
Pin Connection	Pin No.	RS-232C		
		Signal Name	Direction	Meaning
 <p>(GP unit side)</p>	1	CD	Input	Carrier Detect
	2	RD(RXD)	Input	Receive Data
	3	SD(TXD)	Output	Send Data
	4	ER(DTR)	Output	Data Terminal Ready
	5	SG	-	Signal Ground
	6	DR(DSR)	Input	Data Set Ready
	7	RS(RTS)	Output	Request to Send
	8	CS(CTS)	Input	Send possible
	9	CI(RI)/VCC	Input/-	Called Status Display +5V±5% Output 0.25A ^{*1}
	Shell	FG	-	Frame Ground (Common with SG)

*1: RI and VICC of Pin 9 are switched on the software.

VCC Output is not protected from overcurrent.

Please follow the current rating to avoid false operation or breakdown.

4.3.2 Signals of COM2

For GP-3310T, GP-3400T/S

RS-422/485 (socket)

Pin Arrangement	Pin No.	RS422/RS485		
		Signal Name	Direction	Meaning
 <p>(GP unit side)</p>	1	TRMRX	-	Termination (Receiver side: 100Ω)
	2	RDA	Input	Receive Data A(+)
	3	SDA	Output	Send Data A(+)
	4	RS(RTS)	Output	Request for Send
	5	SG	-	Signal Ground
	6	VCC	-	+5V±5% Output 0.25A *1
	7	RDB	Input	Receive Data B(-)
	8	SDB	Output	Send Data B(-)
	9	TRMTX	-	Termination (Receiver side: 100Ω)
	Shell	FG	-	Frame Ground (Common with SG)

For ST-3401T

RS-422/485 (plug)

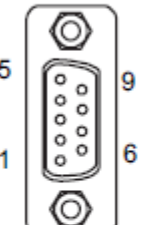
Pin Connection	Pin No.	RS-422/RS-485		
		Signal Name	Direction	Meaning
 <p>(GP unit side)</p>	1	RDA	Input	Receive Data A (+)
	2	RDB	Input	Receive Data B (-)
	3	SDA	Output	Send Data A (+)
	4	ERA	Output	Data Terminal Ready A (+)
	5	SG	-	Signal Ground
	6	CSB	Input	Send Possible B (-)
	7	SDB	Output	Send Data B (-)
	8	CSA	Input	Send Possible A (+)
	9	ERB	Output	Data Terminal Ready B (-)
	Shell	FG	-	Frame Ground (Common with SG)

For GP-4401T

RS-422/485 (plug)

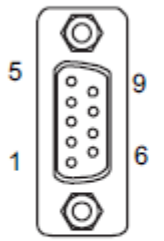
Pin Connection	Pin No.	RS-422/RS-485		
		Signal Name	Direction	Meaning
 <p>(GP unit side)</p>	1	RDA	Input	Receive Data A (+)
	2	RDB	Input	Receive Data B (-)
	3	SDA	Output	Send Data A (+)
	4	ERA	Output	Data Terminal Ready A (+)
	5	SG	-	Signal Ground
	6	CSB	Input	Send Possible B (-)
	7	SDB	Output	Send Data B (-)
	8	CSA	Input	Send Possible A (+)
	9	ERB	Output	Data Terminal Ready B (-)
	Shell	FG	-	Frame Ground (Common with SG)

4.4 Multilink Connection

For the communication drivers that support serial multi-link, see [Which drivers support serial multilink communication?]

(http://www.pro-face.com/otasuke/files/manual/gpproex/new/device/com_mlnk.htm).

4.5 Cable Diagram at the time of replacement

The pin assignment and the shape of plug/socket connector of ST-3401T are the same as those of GP-4401T, but GP-3310T, GP-3400T/S's are different.

Please note that there are precautions and restrictions as described below **when replacing GP-3310T, GP-3400T/S.**

- When a RS-422/485 device is connected via the COM1 port, **if GP-3310T, GP-3400T/S are replaced with GP-4401T, it will be connected via the COM2 port of GP-4401T.** (The cable diagram can be still used.)
Before GP-4401T is connected, be sure to change the port setting to COM2 on the Device/PLC setting. Also, please check the communication settings with GP-Pro EX Device/PLC Connection Manual just in case.
(<http://www.pro-face.com/otasuke/files/manual/gpproex/new/device/index.htm>)
)

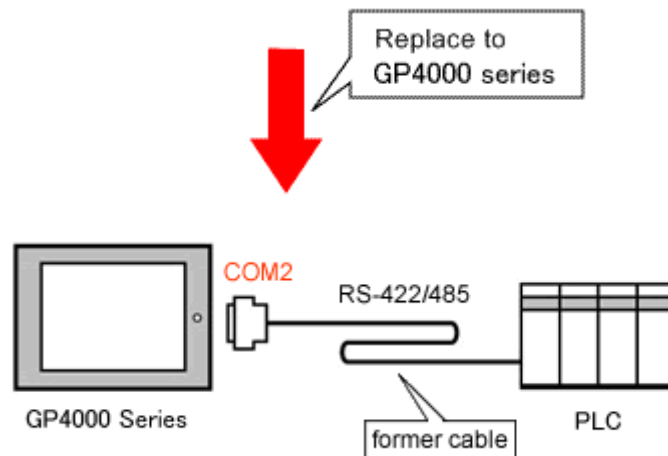

- The cable used for connection to **GP-3310T, GP-3400T/S via COM2** can be used for GP-4401T with a COM Port Conversion Adapter (CA3-ADPCOM-01) added in the following cases;

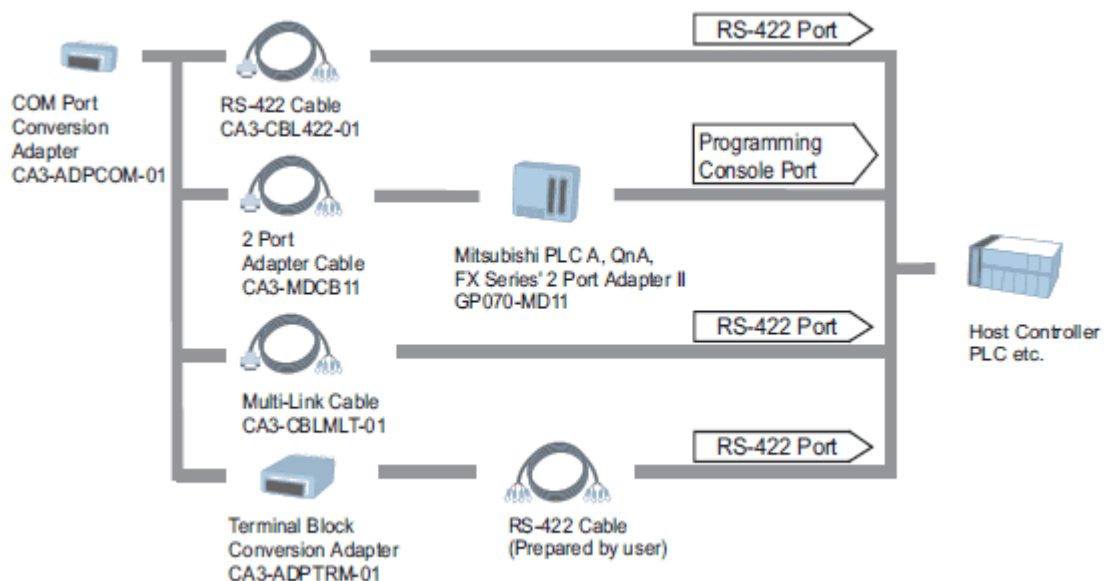

In all other cases, the operation is not guaranteed and it's recommended to prepare a new connection cable. To check the cable diagram, please refer to GP-Pro EX Device/PLC Connection Manual.

Important
 If the homemade COM 2 cable diagram for GP-3310T, GP-3400T/S is used for GP-4401 with a COM port conversion adapter (CA3-ADPCOM-01), no operation is guaranteed.
 It's recommended to get a new cable diagram prepared for GP-4401T. For cable diagrams, see GP-Pro EX Device/PLC Connection Manual.
 (<http://www.pro-face.com/otasuke/files/manual/gpproex/new/device/index.htm>)

- When both the COM1 port and the COM2 port have the RS-422/485 setting, only the COM2 port can be used for RS-422/485 connection after replacement with GP4000 series.
 Using a USB/RS-422/485 Conversion Adapter may allow you to use GP4000 series' USB interface as RS-422/485 serial interface for connection.
 For more information, please refer to USB/RS-422/485 Conversion Adapter Installation Guide.
 (<http://www.pro-face.com/otasuke/download/manual/cgi/manual.cgi?mode=33&cat=3>)

Important

The connected devices/PLC which can connect to the serial interface side of USB/RS-422/485 Conversion Adapter are limited. For details, see USB/RS-422/485 Conversion Adapter Connection Guide (http://www.pro-face.com/otasuke/files/manual/gpproex/new/device/data/com_usc.pdf)

Chapter 5 Appendix

5.1 Changing the setting of the external media to use

If a CF card is used for GP/ST-3000 series, after the display unit type of the project file is changed to GP-4401T, "a CF card" is automatically replaced with "a SD card" for the external media setting.

- (1) After conversion of the project file data, at GP-Pro EX Error Check, if the message, "The project contains features that require a SD card. However, the selected display does not support SD cards so these features will not run." appears,

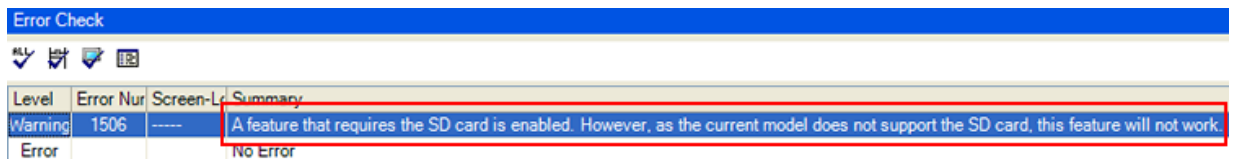

Level	Error Nur	Screen-L	Summary
Warning	1506	----	A feature that requires the SD card is enabled. However, as the current model does not support the SD card, this feature will not work.
Error			No Error

<Cause>

The model without a SD card slot has the setting that uses a SD card.

->[Solution 1](#)

- (2) To use a USB storage device instead of a SD card ->[Solution 1](#)

- (3) To check or change the SD card's data output destination folder setting

->[Solution 2](#)

[Solution]

1. Change the SD card setting to the USB storage setting following the steps below.

<Procedure>

- i. Click [Project]->[Information]->[Destination Folder].
- ii. Uncheck "Enable SD Card" and check "Enable USB Storage".

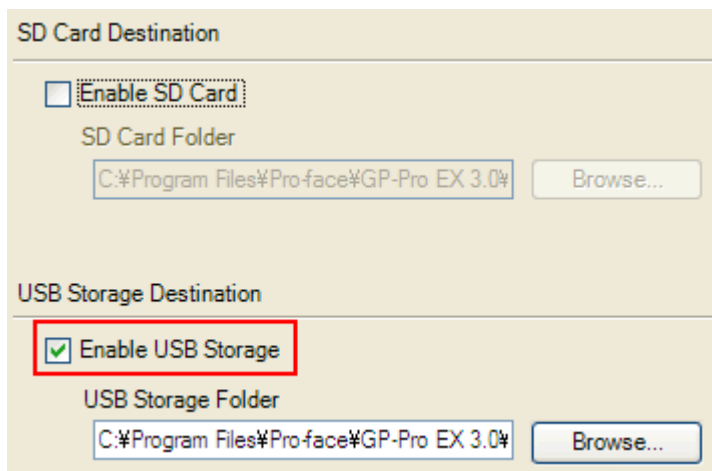

- iii. Click the [Browse] button and specify a destination folder.

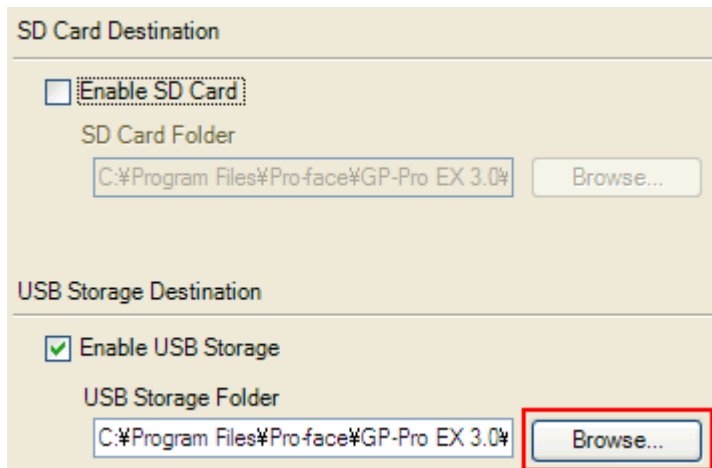

- iv. Click [OK] to confirm the setting.
- v. Click [Project]->[Save] to save changes.
- vi. Check each function that uses the CF card and replace the setting of [SD Card] with the one of [USB Storage].

NOTE

To check each function setting of GP-Pro EX, refer to GP-Pro EX Reference Manual.

2. Check and change the destination folder setting following the steps below.
 - i. Click [Project]->[Information]->[Destination Folder].
 - ii. The current setting is displayed.

The screenshot shows a dialog box with two sections: "SD Card Destination" and "USB Storage Destination".

SD Card Destination:

- Enable SD Card
- SD Card Folder: C:\Program Files\Pro-face\GP-Pro EX 3.0\ Browse...

USB Storage Destination:

- Enable USB Storage
- USB Storage Folder: C:\Program Files\Pro-face\GP-Pro EX 3.0\ Browse...

- iii. After changing it, click [OK] to confirm the setting.
 - iv. Click [Project]->[Save] to save changes.