

Easy! Smooth!
GP-3300 Series->GP4000 Series
Replacement Guidebook

Preface

This guidebook introduces the procedures to replace a unit in GP-3300 series with a GP-4301T/TW unit.

Model in use	Model No.	Recommended Substitution
GP-3300T	AGP3300-T1-D24	GP-4301T
GP-3300S	AGP3300-S1-D24	GP-4301T
		GP-4301TW
GP-3300L	AGP3300-L1-D24	GP-4301T
		GP-4301TW
GP-3301S*1	AGP3301-S1-D24	GP-4301T
		GP-4301TW
GP-3301L*1	AGP3301-L1-D24	GP-4301TW
GP-3302B*1	AGP3302-B1-D24	GP-4301TW
ST-3301T	AST3301-T1-D24	GP-4301T
ST-3301T	AST3301-T1-D24	GP-4301TW
ST-3301S*1	AST3301-S1-D24	GP-4301TW
ST-3301B*1	AST3301-B1-D24	GP-4301TW
ST-3302B	AST3302-B1-D24	GP-4303T

*1: It is also possible to replace GP-3301S/L with GP-4301TM (modular type). For details, please refer to "GP/ST3000 Series -> GP4000M Series Replacement Guidebook".

What is "Modular Type" graphic operator interface, GP-4301TM?

GP-4301TM is the modular type graphic operator interface that can be installed with a $\phi 22$ -mm circular hole as shown below.



Safety Information

HAZARD OF OPERATOR INJURY, OR UNINTENDED EQUIPMENT DAMAGE

Before operating any of these products, be sure to read all related manuals thoroughly.

Failure to follow these instructions can result in death, serious injury or unintended equipment damage.

GP4000 Series Model Number

GP4000 series model number partly differs depending on a specification. Before placing an order, please make sure of the model number.

PFXGP4 * 0 * * * * *

 A
 B
 C
 D
 E
 F

A	2	GP-4200 series (3.5")
	3	GP-4300 series (5.7")
	4	GP-4400 series (7.5"/7.0"W)
	5	GP-4500 series (10.4")
	6	GP-4600 series (12.1")
B	01	RS-232C/422/485
	03	RS-485 (isolation)
C	T	TFT color LCD
	W	TFT color LCD (Wide Type)
D	A	Analog Resistive Film Touch Panel
	M	Matrix Resistive Film Touch Panel
E	A	AC Type Power Supply
	D	DC Type Power Supply
F	W	GP-4201TW/4301TW/4401WW/4501TW
	C	Coated model
	WC	Coated model of GP-4301TW

Contents

<u>PREFACE</u>	<u>2</u>
<u>HAZARD OF OPERATOR INJURY, OR UNINTENDED EQUIPMENT DAMAGE</u>	<u>3</u>
<u>GP4000 SERIES MODEL NUMBER</u>	<u>4</u>
<u>CONTENTS</u>	<u>5</u>
<u>CHAPTER 1 SPECIFICATION COMPARISON</u>	<u>7</u>
1.1 SPECIFICATIONS OF GP-3300T/S/L AND GP-4301T	7
1.2 SPECIFICATIONS OF GP-3300S/L AND GP-4301TW	9
1.3 SPECIFICATIONS OF GP-3301S AND GP-4301T	11
1.4 SPECIFICATIONS OF GP-3301S/L AND GP-4301TW	13
1.5 SPECIFICATIONS OF GP-3302B AND GP-4301TW	15
1.6 SPECIFICATIONS OF ST-3301T AND GP-4301T	16
1.7 SPECIFICATIONS OF ST-3301T/S/B AND GP-4301TW	17
1.8 SPECIFICATIONS OF ST-3302B AND GP-4303T	18
<u>CHAPTER 2 COMPATIBILITY OF HARDWARE</u>	<u>19</u>
2.1 LOCATIONS OF CONNECTOR	19
2.2 TOUCH PANEL SPECIFICATIONS	24
2.3 DISPLAY COLORS(ONLY WHEN REPLACING GP-3300L/3301L/3302B/ ST-3301B/3302B)	25
2.4 TRANSFER CABLE	26
2.5 INTERFACE	26
2.5.1 SERIAL INTERFACE	26
2.5.2 CF CARD INTERFACE (EXCEPT GP-3302B)	27
2.6 PERIPHERAL UNITS AND OPTIONS	28
2.6.1 BARCODE READER CONNECTION	28

2.6.2 PRINTER CONNECTION	28
2.6.3 EXPANSION UNIT	28
2.6.4 ISOLATION UNIT	28
2.7 BACKUP BATTERY (ONLY WHEN REPLACING WITH GP-4301T/4303T)	29
2.8 POWER CONSUMPTION	29
2.9 MATERIALS/COLORS OF THE BODY	30
2.10 BACKUP MEMORY (SRAM) (ONLY WHEN REPLACING WITH GP-4301TW)	30
2.11 ABOUT LADDER MONITOR	31
2.12 OTHER NOTES	31

CHAPTER 3 REPLACEMENT PROCEDURE **32**

3.1 WORK FLOW	32
3.2 PREPARATION	33
3.3 RECEIVE SCREEN DATA FROM GP-3300/ST-3300 SERIES	34
3.4 CHANGE THE DISPLAY UNIT TYPE	40
3.5 TRANSFER SCREEN DATA TO GP-4301T/TW	41
3.6 DIFFERENCES OF SOFTWARE	45

CHAPTER 4 COMMUNICATION WITH DEVICE/PLC **46**



4.1 DRIVERS	46
4.2 SHAPES OF COM PORTS	46
4.3 SIGNALS OF COM PORTS	47
4.3.1 SIGNALS OF COM1	47
4.3.2 SIGNALS OF COM2	49
4.4 MULTILINK CONNECTION	51
4.5 CABLE DIAGRAM AT THE TIME OF REPLACEMENT	51

CHAPTER 5 APPENDIX **52**

5.1 CHANGING THE SETTING OF THE EXTERNAL MEDIA TO USE	52
--	-----------



Chapter 1 Specification Comparison

1.1 Specifications of GP-3300T/S/L and GP-4301T

		GP-3300T/S/L	GP-4301T
			
Display Type	GP-3300T	TFT color LCD	TFT color LCD
	GP-3300S	STN color LCD	
	GP-3300L	Monochrome LCD	
Display Colors, Levels	GP-3300T	65,536 colors (without blink)/ 16,384 colors (with blink)	65,536 colors (without blink)/ 16,384 colors (with blink)
	GP-3300S	4,096 colors	
	GP-3300L	Monochrome, 16 levels	
Display Colors, Levels		65,536 colors (without blink)/16,384 colors (with blink)	
Display Resolution		QVGA (320x240 pixels)	
Panel Cutout Dimensions (mm)		156(W)×123.5(H)	
External Dimensions (mm)		167.5(W)×135(H)×59.5(D)	169.5(W)×137(H)×59.5(D)



Touch Panel Type		Resistive film (Analog)	
Memory	Application	6MB	UP! 16MB
	SRAM	320KB	
Backup Battery		Secondary Battery (Rechargeable Lithium battery)	NEW! Primary Battery (Replaceable Lithium battery) ->See 2.7
Rated Input Voltage		DC 24V	
Serial I/F	COM1	D-Sub 9 pin (plug) RS-232C/422/485	D-Sub 9 pin (plug) RS-232C ->See 2.5.1 and Chapter4
	COM2	D-Sub 9 pin (socket) RS-422/485	D-Sub 9 pin (plug) RS-422/485 ->See 2.5.1 and Chapter4
Ethernet I/F		10BASE-T/100BASE-TX	
CF Card I/F		✓	- ->See 2.5.2
SD Card I/F		-	NEW! ✓
USB I/F	Type A	✓	✓
	Type mini B	-	->See 2.4
Expansion Unit I/F		✓	- ->See 2.6.3

1.2 Specifications of GP-3300S/L and GP-4301TW

		GP-3300S/L	GP-4301TW
			
Display Type	GP-3300S	STN color LCD	UP! TFT color LCD
	GP-3300L	Monochrome LCD	
Display Colors, Levels	GP-3300S	4,096 colors	UP! 65,536 colors (without blink)/ 16,384 colors (with blink) -> See 2.3
	GP-3300L	Monochrome, 16 levels	
Display Resolution		QVGA (320x240 pixels)	
Panel Cutout Dimensions (mm)		156(W)×123.5(H)	
External Dimensions (mm)		167.5(W)×135(H)×59.5(D)	169.5(W)×137(H)×59.5(D)
Touch Panel Type		Resistive film (Analog)	
Memory	Application	6MB	UP! 8MB
	SRAM	320KB	128KB -> See 2.10
Backup Battery		Secondary Battery (Rechargeable Lithium battery)	
Rated Input Voltage		DC 24V	
Serial I/F	COM1	D-Sub 9 pin (plug) RS-232C/422/485	D-Sub 9 pin (plug) RS-232C -> See 2.5.1 and Chapter4
	COM2	D-Sub 9 pin (socket) RS-422/485	D-Sub 9 pin (plug) RS-422/485 -> See 2.5.1 and Chapter4
Ethernet I/F		10BASE-T/100BASE-TX	
CF Card I/F		✓	- -> See 2.5.2
USB I/F	Type A	✓	✓
	Type mini B	-	-> See 2.4



Expansion Unit I/F	✓	- -> See 2.6.3
---------------------------	---	--------------------------------

1.3 Specifications of GP-3301S and GP-4301T

		GP-3301S	GP-4301T
			
Display Type		STN color LCD	UP! TFT color LCD
Display Colors, Levels		4,096 colors	UP! 65,536 colors (without blink)/ 16,384 colors (with blink) ->See 2.3
Display Resolution		QVGA (320x240 pixels)	
Panel Cutout Dimensions (mm)		156(W)x123.5(H)	
External Dimensions (mm)		167.5(W)x135(H)x59.5(D)	169.5(W)x137(H)x59.5(D)
Touch Panel Type		Resistive film (Analog)	
Memory	Application	6MB	UP! 16MB
	SRAM	320KB	
Backup Battery		Secondary Battery (Rechargeable Lithium battery)	NEW! Primary Battery (Replaceable Lithium battery) ->See 2.7
Rated Input Voltage		DC 24V	
Serial I/F	COM1	D-Sub 9 pin (plug) RS-232C/422/485	D-Sub 9 pin (plug) RS-232C ->See 2.5.1 and Chapter4
	COM2	D-Sub 9 pin (socket) RS-422/485	D-Sub 9 pin (plug) RS-422/485 ->See 2.5.1 and Chapter4



Ethernet I/F		-	NEW! 10BASE-T/100BASE-TX
CF Card I/F		✓	- -> See 2.5.2
SD Card I/F		-	NEW! ✓
USB I/F	Type A	✓	✓
	Type mini B	-	-> See 2.4
Expansion Unit I/F		✓	- -> See 2.6.3

1.4 Specifications of GP-3301S/L and GP-4301TW



		GP-3301S/L	GP-4301TW
			
Display Type	GP-3301S	STN color LCD	UP! TFT color LCD
	GP-3301L	Monochrome LCD	
Display Colors, Levels	GP-3301S	4,096 colors	UP! 65,536 colors (without blink)/ 16,384 colors (with blink) -> See 2.3
	GP-3301L	Monochrome, 16 levels	
Display Resolution		QVGA (320x240 pixels)	
Panel Cutout Dimensions (mm)		156(W)x123.5(H)	
External Dimensions (mm)		167.5(W)x135(H)x59.5(D)	169.5(W)x137(H)x59.5(D)
Touch Panel Type		Resistive film (Analog)	
Memory	Application	6MB	UP! 8MB
	SRAM	320KB	128KB -> See 2.10
Backup Battery		Secondary Battery (Rechargeable Lithium battery)	
Rated Input Voltage		DC 24V	
Serial I/F	COM1	D-Sub 9 pin (plug) RS-232C/422/485	D-Sub 9 pin (plug) RS-232C -> See 2.5.1 and Chapter4
	COM2	D-Sub 9 pin (socket) RS-422/485	D-Sub 9 pin (plug) RS-422/485 -> See 2.5.1 and Chapter4
Ethernet I/F		-	NEW! 10BASE-T/100BASE-TX
CF Card I/F		✓	- -> See 2.5.2
USB	Type A	✓	✓

I/F	Type mini B	-	-> See 2.4
Expansion Unit I/F		✓	- -> See 2.6.3



1.5 Specifications of GP-3302B and GP-4301TW

		GP-3302B	GP-4301TW
			
Display Type		Monochrome Blue Mode LCD	UPI! TFT color LCD
Display Colors, Levels		Monochrome, 8 levels	UPI! 65,536 colors (without blink)/ 16,384 colors (with blink) -> See 2.3
Display Resolution		QVGA (320x240 pixels)	
Panel Cutout Dimensions (mm)		156(W)x123.5(H)	
External Dimensions (mm)		167.5(W)x135(H)x59.5(D)	169.5(W)x137(H)x59.5(D)
Touch Panel Type		Resistive film (Analog)	
Memory	Application	6MB	UPI! 8MB
	SRAM	320KB	128KB -> See 2.10
Backup Battery		Secondary Battery (Rechargeable Lithium battery)	
Rated Input Voltage		DC 24V	
Serial I/F	COM1	D-Sub 9 pin (plug) RS-232C	
	COM2	D-Sub 9 pin (plug) RS-422	D-Sub 9 pin (plug) RS-422/485
Ethernet I/F		-	NEW! 10BASE-T/100BASE-TX
USB I/F	Type A	✓	✓
	Type mini B	-	-> See 2.4
Expansion Unit		✓	- -> See 2.6.3

1.6 Specifications of ST-3301T and GP-4301T



		ST-3301T	GP-4301T
			
Display Type		TFT color LCD	
Display Colors		256 colors (without blink)/ 64 colors (with blink)	UP! 65,536 colors (without blink)/ 16,384 colors (with blink) ->See 2.2
Display Resolution		QVGA (320x240 pixels)	
Panel Cutout Dimensions (mm)		156(W)x123.5(H)	
External Dimensions (mm)		167.5(W)x135(H)x59.5(D)	169.5(W)x137(H)x59.5(D)
Touch Panel Type		Resistive film (Analog)	
Memory	Application	6MB	UP! 16MB
	SRAM	320KB ->See 2.9	
Backup Battery		Secondary Battery (Rechargeable Lithium battery)	NEW! Primary Battery (Replaceable Lithium battery) ->See 2.7
Rated Input Voltage		DC 24V	
Serial I/F	COM1	D-Sub 9 pin (plug) RS-232C	
	COM2	D-Sub 9 pin (plug) RS-422/485	
Ethernet I/F		-	NEW! 10BASE-T/100BASE-TX
USB I/F	Type A	✓	✓
	Type mini B	-	->See 2.3

1.7 Specifications of ST-3301T/S/B and GP-4301TW

		ST-3301T/S/B	GP-4301TW
			
Display Type	ST-3301T	TFT color LCD	UP! TFT color LCD
	ST-3301S	STN color LCD	
	ST-3301B	Monochrome Blue Mode LCD	
Display Colors	ST-3301T	256 colors (without blink)/	UP! 65,536 colors (without blink)/ 16,384 colors (with blink) ->See 2.2
	ST-3301S	64 colors (with blink)	
	ST-3301B	Monochrome, 8 levels	
Display Resolution		QVGA (320x240 pixels)	
Panel Cutout Dimensions (mm)		156(W)x123.5(H)	
External Dimensions (mm)		167.5(W)x135(H)x59.5(D)	169.5(W)x137(H)x59.5(D)
Touch Panel Type		Resistive film (Analog)	
Memory	Application	6MB	UP! 8MB
	SRAM	320KB	128KB ->See 2.9
Backup Battery		Secondary Battery (Rechargeable Lithium battery)	
Rated Input Voltage		DC 24V	
Serial I/F	COM1	D-Sub 9 pin (plug) RS-232C	
	COM2	D-Sub 9 pin (plug) RS-422/485 *1	
Ethernet I/F		-	NEW! 10BASE-T/100BASE-TX
USB I/F	Type A	✓	✓
	Type mini B	-	->See 2.3

***1:** RS-485 is supported by Rev. B or later for ST-3301S/B.

1.8 Specifications of ST-3302B and GP-4303T

		ST-3302B	GP-4303T
			
Display Type		Monochrome Blue Mode LCD	UP! TFT color LCD
Display Colors, Levels		Monochrome, 8 levels	UP! 65,536 colors (without blink)/ 16,384 colors (with blink) -> See 2.2
Display Resolution		QVGA (320x240 pixels)	
Panel Cutout Dimensions (mm)		156(W)x123.5(H)	
External Dimensions (mm)		167.5(W)x135(H)x59.5(D)	169.5(W)x137(H)x59.5(D)
Touch Panel Type		Resistive film (Analog)	
Memory	Application	6MB	UP! 16MB
	SRAM	320KB	
Backup Battery		Secondary Battery (Rechargeable Lithium battery)	NEW! Primary Battery (Replaceable Lithium battery) -> See 2.6
Rated Input Voltage		DC 24V	
Serial I/F	COM1	D-Sub 9 pin (plug) RS-232C	
	COM2	D-Sub 9 pin (socket) RS-485 (for MPI only)	
Ethernet I/F		-	NEW! 10BASE-T/100BASE-TX
SD Card I/F		-	NEW! ✓
USB I/F	Type A	✓	✓
	Type mini B	-	-> See 2.3

Chapter 2 Compatibility of Hardware

2.1 Locations of connector

Connector locations on GP-3300 series/ST-3300 series and GP-4301T/TW are as follows:

GP-3300T/S/L

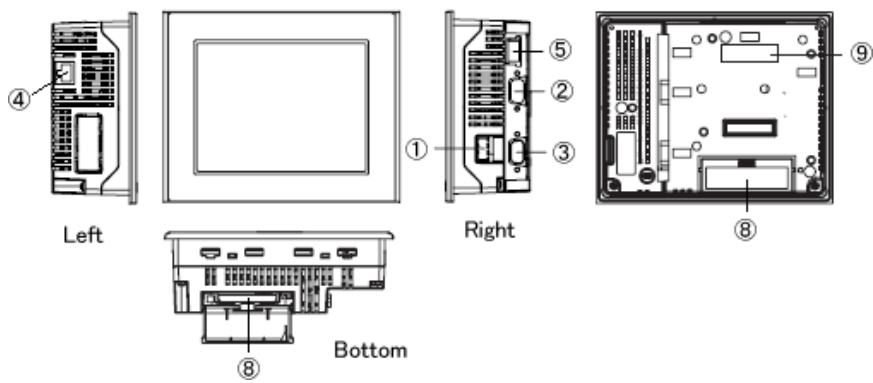

GP-3301S

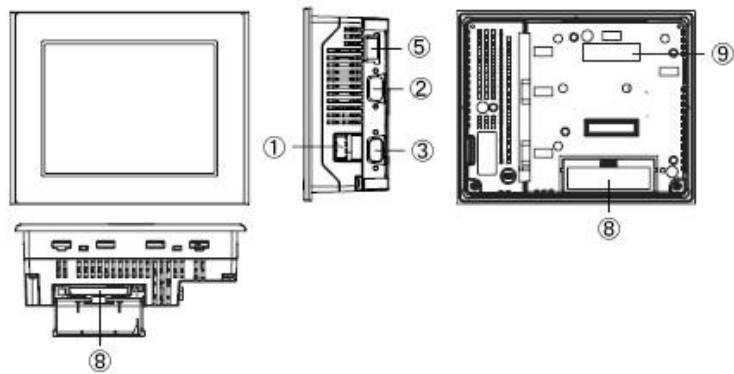

ST-3301T/S/B

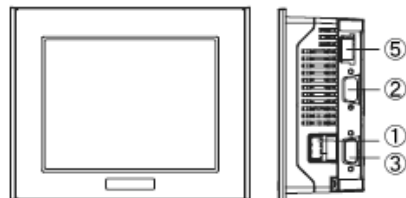

GP-4301T

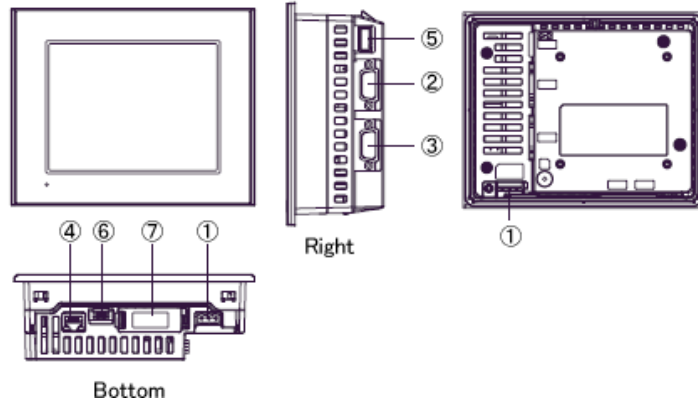

GP-4301TW

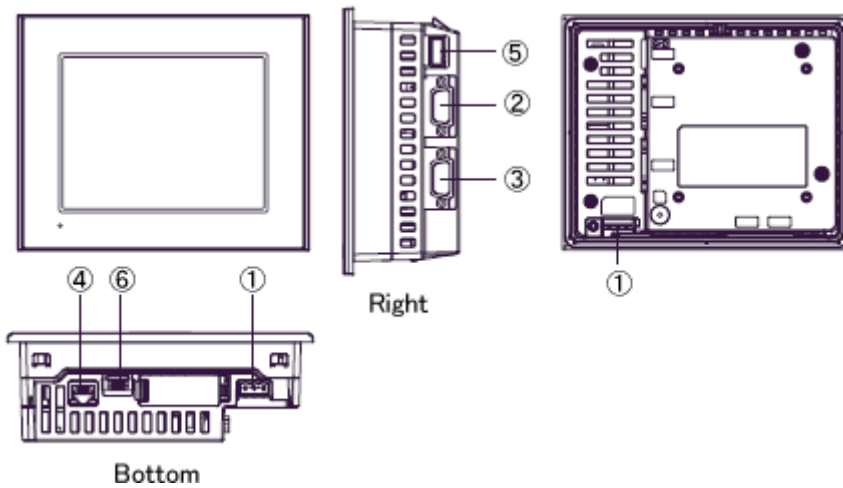

Interface names

	GP-3300T/S/L	GP-3301S	ST-3301T	GP-4301TW	GP-4301T
①	Power Connector				
②	Serial Interface (COM1)				
③	Serial Interface (COM2)				
④	Ethernet Interface	-	-	Ethernet Interface	-
⑤	USB Interface (Type A)				
⑥	-	-	-	USB Interface (Type mini B)	-
⑦	-	-	-	SD Card Interface	-
⑧	CF Card Interface			-	-
⑨	Expansion Unit Interface			-	-

Connector locations on GP-3300S/L, GP-3301S/L, ST-3301T/S/B, GP-3302B and GP-4301TW

GP-3300S/L

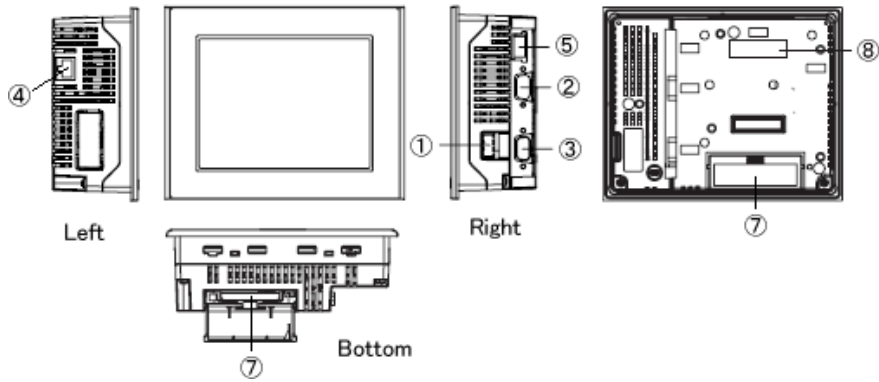

GP-3301S/L

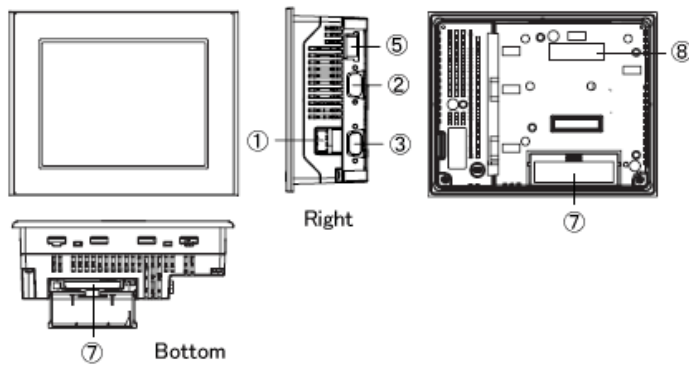

ST-3301T/S/B

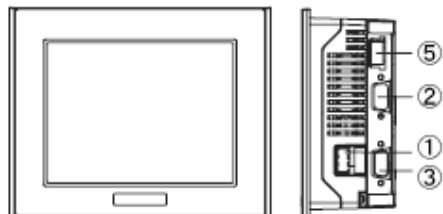

GP-3302B

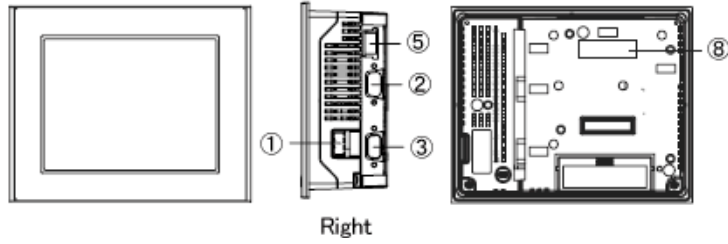

GP-4301TW

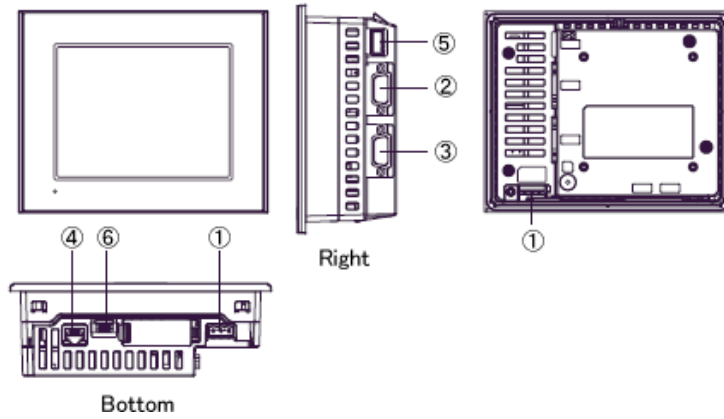

Interface names

	GP-3300S/L	GP-3301S/L	GP-3302B	ST-3301T/S/B	GP-4301TW
1	Power Connector				
2	Serial Interface (COM1)				
3	Serial Interface (COM2)				
4	Ethernet Interface		-		Ethernet Interface
5	USB Interface (Type A)				
6			-		USB Interface (Type mini B)
7	CF Card Interface			-	
8	Expansion Unit Interface				-

Connector locations on ST-3302B and GP-4303T:

ST-3302B

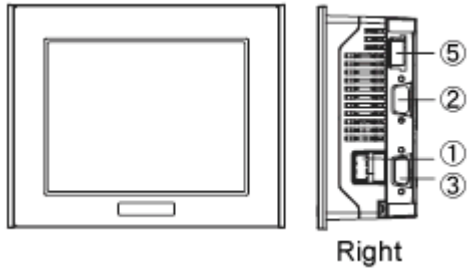

GP-4303T

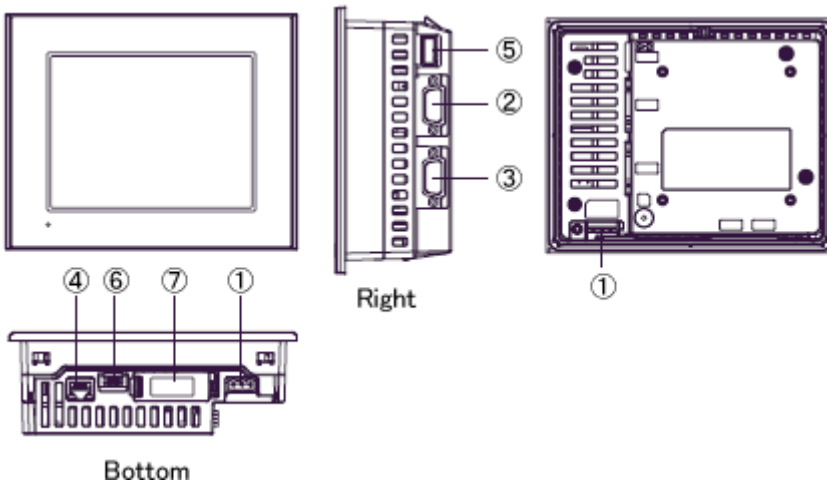

Interface names

	ST-3302B	GP-4303T
1	Power Connector	
2	Serial Interface (COM1)	
3	Serial Interface (COM2)	
4	-	Ethernet Interface
5	USB Interface (Type A)	
6	-	USB Interface (Type mini B)
7	-	SD Card Interface

2.2 Touch panel Specifications

GP-4301T and GP-4301TW adopt Analog resistive film type.

GP-4301T and GP-4301TW doesn't support 2-point touch input (touching 2 points on the screen at the same time).

GP-4301T	Analog type	Even if you touch two points at the same time, only the first touched point is recognized, but the second touched one is not.
GP-4301TW	Analog type	Even if two different points are touched at the same time, that's recognized as touch input on the middle coordinates between those two points.

2.3 Display Colors(only when replacing GP-3300L/3301L/3302B/ST-3301B/3302B)

The display color of GP-3300L/3301L/3302B/ST-3301B/3302B is monochrome, but GP-4301TW has a TFT color LCD. After replacement, the display color changes from monochrome to color.

When the setting of the display unit type is changed from a monochrome model to a color one on GP-Pro EX, the data may be displayed in colors depending on the GP-Pro EX version or settings of the drawing/the parts on the screens.

After changing the display unit type, please confirm the display colors of the drawing or the parts on the screens just in case.

If the display is in colors after changing the display unit type...

GP-Pro EX Ver. 3.01.200 (Service Pack1) or later supports the function which changes drawing in colors to monochrome. To change the color to monochrome, follow the steps below.

- (1) Click [Project]->[System Settings]->[Display Unit].
- (2) Open the [Display Settings] tab.
- (3) Change [Color] setting to "16 Levels Monochrome, 3-Speed Blink".

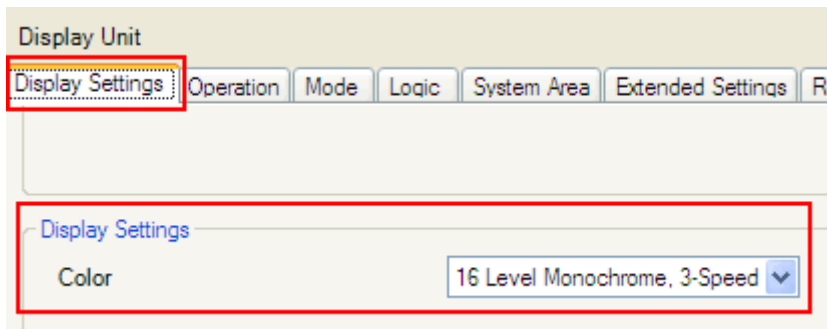

* [Reverse Display] setting is for displaying the screen with black/white reversed. Check on this setting if needed.





* Please confirm the display colors of the drawing or the parts on the screens after

changing the [Color] setting.

2.4 Transfer cable

To transfer screen data to GP-4301T/TW, use a USB transfer cable or Ethernet.
The USB cables that can be used for GP-4301T/TW are as follows:

	Model	Connector Type	Connector on GP
Options	CA3-USBCB-01		USB (Type A)
	ZC9USCBMB1		USB (Type mini B)
Commercial Item	-		

The same USB transfer cable (CA3-USBCB-01) as the one for GP-3300 series can be used.

2.5 Interface

2.5.1 Serial Interface

The pin assignment and the shape of plug/socket connector of GP-3300 series/ST-3300 series are different from those of GP-4301T/TW.

To know the details about them, see [[4.2 Shapes of COM ports](#)] and [[4.3 Signals of COM ports](#)].

Because of it, the existing PLC connection cables cannot be used as they are.

If you use the existing connection cables, see [[4.5 Cable Diagram at the time of replacement](#)].

* For the models except GP-3302B:

When both the COM1 port and the COM2 port have the RS-422/485 setting, only the COM2 port can be used for RS-422/485 connection after replacement.

Using a USB/RS-422/485 Conversion Adapter (PFXZCBCBCVUSR41) allows you to use GP4000 series' USB interface as RS-422/485 serial interface for connection.

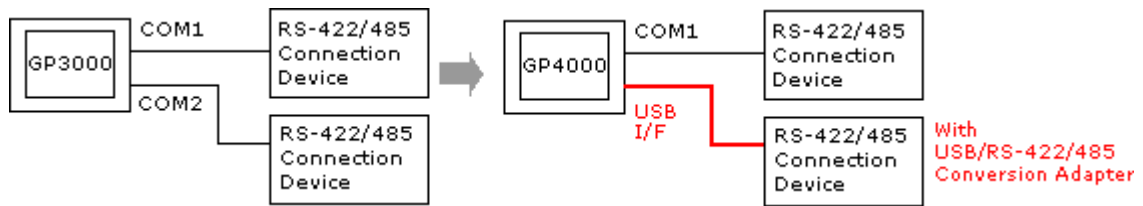

For more information, please refer to USB/RS-422/485 Conversion Adapter Installation Guide.

(<http://www.pro-face.com/otasuke/download/manual/cgi/manual.cgi?mode=33&cat=3>)

IMPORTANT

When using USB/RS-422/485 Conversion Adapter (PFXZCBCBCVUSR41) with a display unit, the device/PLCs you can connect to its serial interface (RS-422/485) are limited. To check the connection configuration, please refer to GP-Pro EX Device/PLC Connection Manual.

(<http://www.pro-face.com/otasuke/files/manual/gpproex/new/device/index.htm>)

If it's not possible to use USB/RS-422/485 Conversion Adapter (PFXZCBCBCVUSR41) for your connection, please contact our sales office in your region. (<http://www.pro-face.com/customer/contact.html>)

2.5.2 CF Card Interface (except GP-3302B)

GP-4301T/TW is not equipped with a CF card slot. But a SD card slot (for GP-4301T only) and a USB interface are installed. In order to use the GP-3300 series functions using the CF card, use a SD card or USB flash drive for GP-4301T/USB flash drive for GP-4301TW instead.

* When using a SD card with GP-4301T, please verify it supports the following specifications:

	File format	Maximum capacity
SD	FAT16	2GB
SDHC	FAT32	32GB

When the setting of the output destination folder is set to "CF Card" on GP-Pro EX, if you change the display unit type, the setting will automatically change to the one that uses a SD card. To change the setting of the output destination folder, see [[5.1 Changing the setting of the external media to use](#)].

2.6 Peripheral units and options

2.6.1 Barcode reader connection

Like GP-3300 series/ST-3300 series, GP-4301T/TW allows you to connect a barcode reader on its USB interface (Type A) or its serial interface.

For the models GP-4301T/TW supports, see [OtasukePro!]

(http://www.pro-face.com/otasuke/qa/3000/0056_connect_e.html).

2.6.2 Printer Connection

Like GP-3300 series/ST-3300 series, GP-4301T/TW allows you to connect a printer on its USB interface (Type A).

For the models GP-4301T/TW supports, see [OtasukePro!]

(http://www.pro-face.com/otasuke/qa/3000/0056_connect_e.html).

2.6.3 Expansion Unit

GP-4301T/TW is not equipped with an expansion unit interface. The expansion units (each kind of unit like CC-LINK Unit) for GP-3300 series cannot be used.

2.6.4 Isolation Unit

RS-485 isolation unit for GP-3300/ST-3300 series (CA3-ISO485-01) cannot be used for GP-4301T/TW. You can use the RS-232C isolation unit (CA3-ISO232-01) for GP-4301T/TW instead. In this case, select "VCC" from [System Settings] -> [Device/PLC] in the [Project] menu on GP-Pro EX.

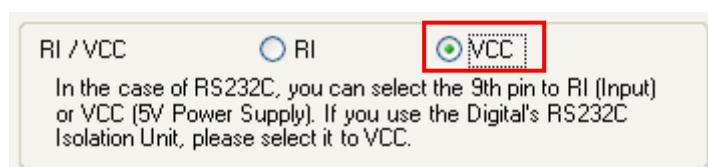

2.7 Backup Battery (only when replacing with GP-4301T/4303T)

Unlike GP-3300/ST-3300 series, GP-4301T/4303T does not use rechargeable secondary batteries but replaceable primary ones. (For both a rechargeable type and a replaceable one, contents to be backed up are the same.)

When the time for replacement of backup batteries approaches, the message to urge you to replace the battery, "RAAA053: Running out of power in the backup battery. Please change the battery." appears. When the message appears, replace the battery referring to the GP4000 series hardware manual.

Replaceable Battery Model
PFXZCBBT1

2.8 Power Consumption

The power consumption of GP-3300/ST-3300 series is different from that of GP-4301T/TW.

GP3300T/S/L	26W or less
GP-3301S/L	
GP-3302B	18W or less
ST-3302B	
ST-3301T/S/B	
GP-4301T/TW	10.5W or less
GP-4303T	

For the detailed electric specifications, see the hardware manual.

2.9 Materials/Colors of the body

The materials and the colors of GP-3300 series and GP-4301T/TW are as follows:

	GP-3300 series	GP-4301T/TW
Color	Silver	Light Gray
Material	Aluminum alloy	Resin with glass

2.10 Backup Memory (SRAM) (only when replacing with GP-4301TW)

When replacing GP-3300/ST-3300 series with GP-4301TW, SRAM size becomes smaller (320KB -> 128KB). In case that SRAM size of your project file is more than 128KB after changing the Display Unit type to GP-4301TW, replace GP-3300/ST-3300 series with GP-4301T instead of GP-4301TW.

To check SRAM size, follow the steps below;

- (1) Double click and open the project file (*.prx) on GP-Pro EX.
- (2) Change the Display Unit type of your project file to "GP-4301TW". To know how to do it, see [\[3.4 Change the Display Unit Type\]](#).
- (3) Click [Project]->[Information]->[Project Information]. The Project Information window appears.
- (4) Click [SRAM Information] to see SRAM size.

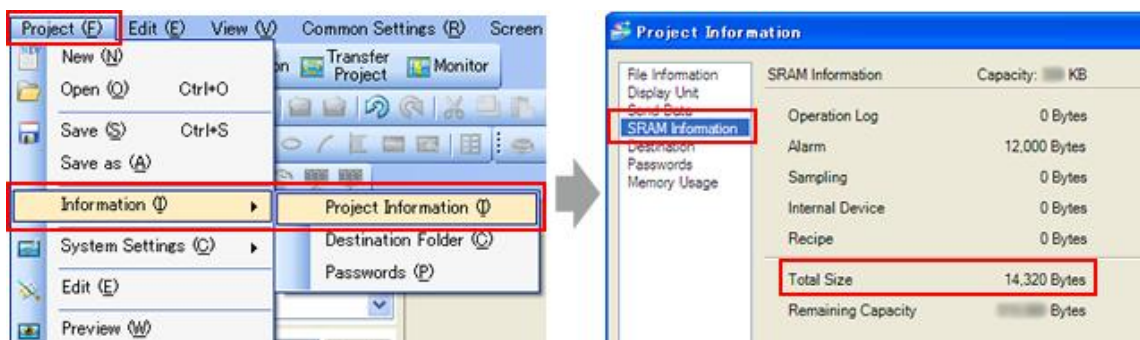

2.11 About Ladder monitor

PLC Ladder monitor tool cannot be used for GP4000 series.

2.12 Other Notes

- Do not expose GP4000 series to direct sunlight.
- Do not use GP4000 series outdoors.
- Do not turn on GP4000 series if condensation has occurred inside the device.
- When you are continuously using GP4000 series without oxygen, the brightness might decrease. Please ventilate the control panel periodically.

Chapter 3 Replacement Procedure

3.1 Work Flow

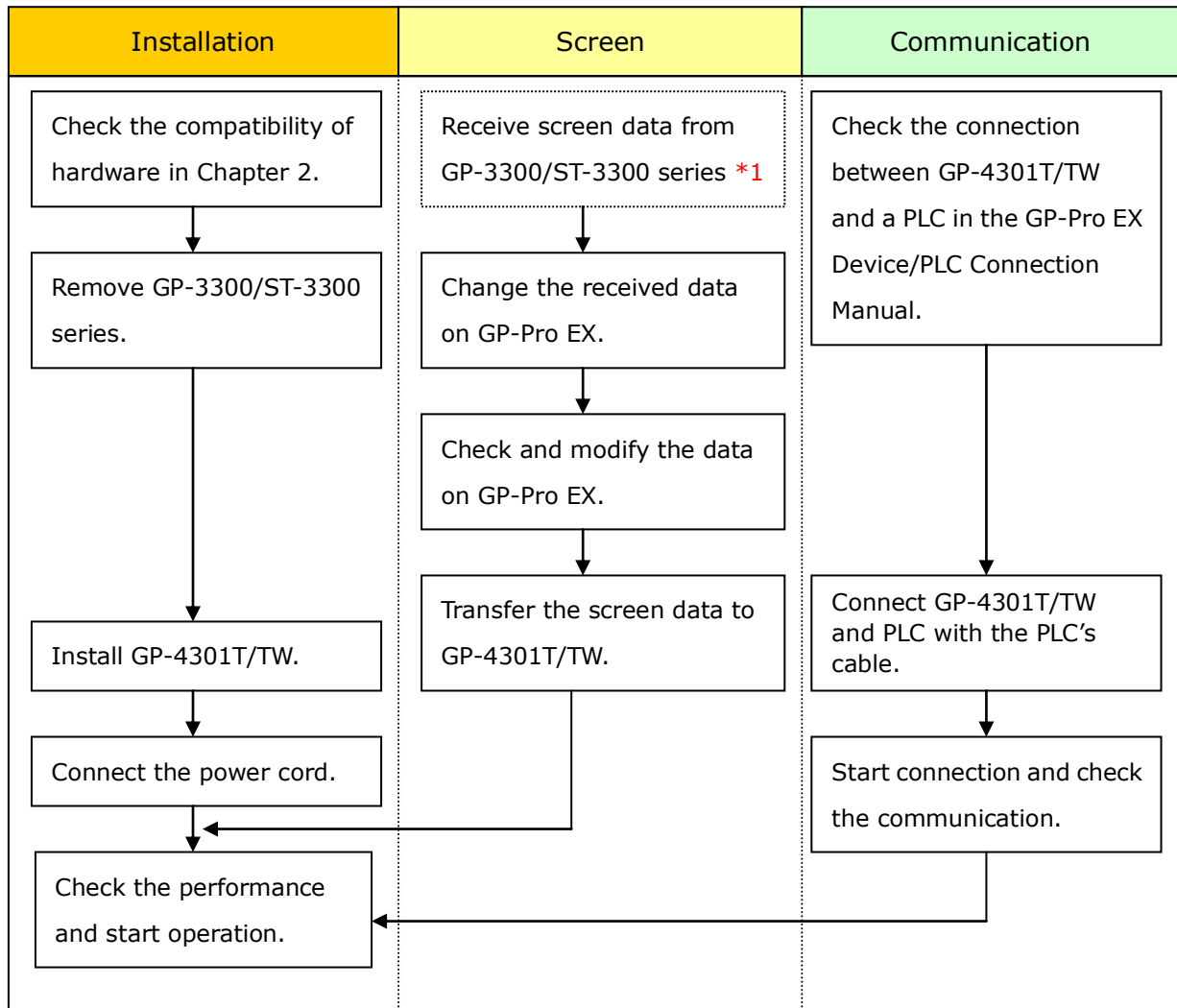

*1: This step is required if screen data is saved only in the GP unit, not in any other device.

3.2 Preparation

Requirements for receiving screen data from GP-3300/ST-3300 series *1	PC in which GP-Pro EX Transfer Tool is installed. *2
	USB Transfer Cable (model: CA3-USBCB-01) * Possible to send/receive a screen with a CF card, an USB storage device, or via Ethernet (for GP-3300T/S/L only).
Requirements for converting screen data of GP-3300/ST-3300 series and transferring the converted data to GP-4301T/TW	PC in which GP-Pro EX Ver.3.00 or later is installed.
	Transfer Cable (The following three types of cables are available) <ul style="list-style-type: none"> • An USB transfer cable (model: CA3-USBCB-01) • An USB data-transfer cable (model: ZC9USCBMB1) • A commercial USB cable (USB Type A/mini B) * Possible to send/receive a screen with a SD card (for GP-4301T only), an USB storage device, or via Ethernet.

*1: This step is required if screen data is saved only in the GP unit, not in any other device

*2: Please use the same version or later as or than that of the software used during creating screens on GP-3300/ST-3300 series. If you don't know the version, we recommend you to use the newest version. For the newest version, you can download the transfer tool from our web site called [OtasukePro!] (http://www.pro-face.com/otasuke/download/freesoft/gpproex_transfer.htm)

3.3 Receive screen data from GP-3300/ST-3300 series

You can transfer data to GP-3300/ST-3300 series via;

- An USB transfer cable (model: CA3-USBCB-01)
- A CF card/USB storage device
- A SD card (for GP-4303T only)/USB storage device
- Ethernet (for GP-3300T/S/L only)

But this section explains, as an example, how to receive screen data from GP-3300 series using a USB transfer cable (model: CA3-USBCB-01).

If you have backed up screen data, this step is unnecessary, skip to the next section [[3.4 Change the Display Unit Type](#)].



- (1) Connect your PC and GP-3300/ST-3300 series with an USB transfer cable.
If the driver of the cable has not been installed on your PC yet, a dialog box will appear. Please follow the instructions.

NOTE

- The "Hardware Installation" dialog box as shown below may appear during installing the USB driver depending on the security level of Windows® XP. Click [Continue Anyway] to start installing the driver. When installation is completed, click [Finish].

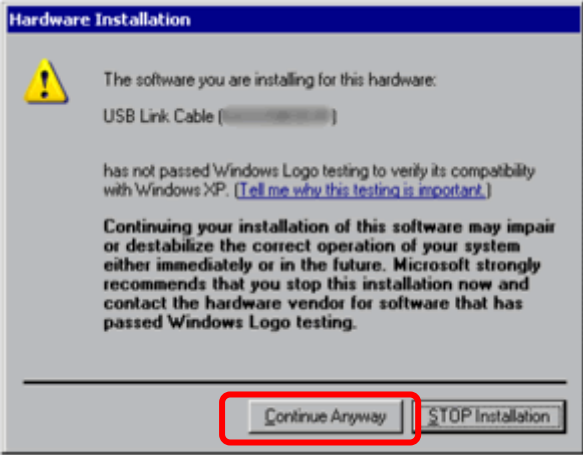

- If the following symptoms appear on Microsoft Windows® 7, go to updating "USB Data Transfer Driver" on [OtasukePro!] for download (http://www.pro-face.com/otasuke/download/freesoft/gproex_transfer.htm).
- An error occurs when GP-Pro EX or Transfer Tool is installed
- An error occurs when data is transferred via a USB transfer cable (model: CA3-USBCB-01).

(2) Start the Transfer Tool of GP-Pro EX.

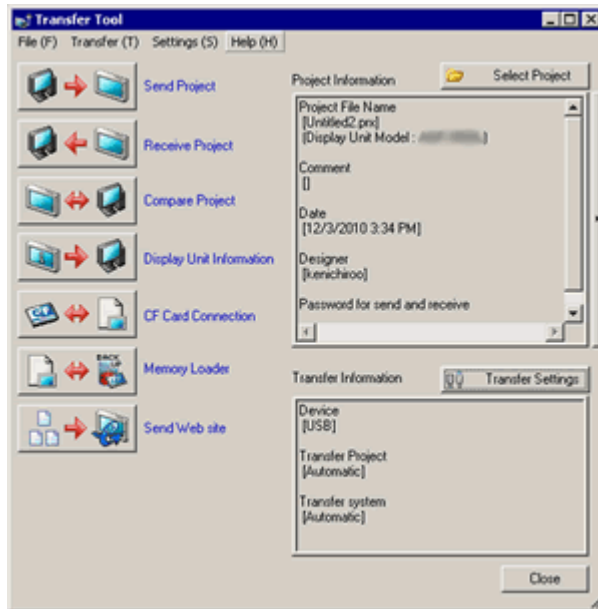

(3) Make sure that the [Device] in the "Transfer Settings Information" is set to [USB]. If not, click the [Transfer Setting] button to open the "Transfer Setting" dialog box. Select [USB] in the Communication Port Settings field and click [OK].



(4) Start GP-Pro EX Transfer Tool and click the [Receive Project] button.

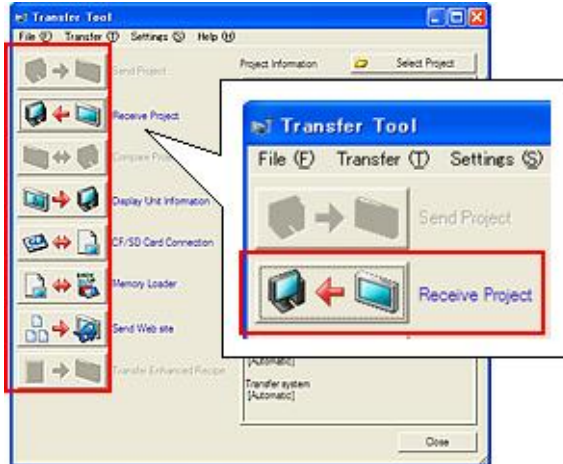

(5) Click [Receive Project], and the following dialog box will appear. Specify a place to save the received data in and a project file name, and then click [Save] to start transfer.

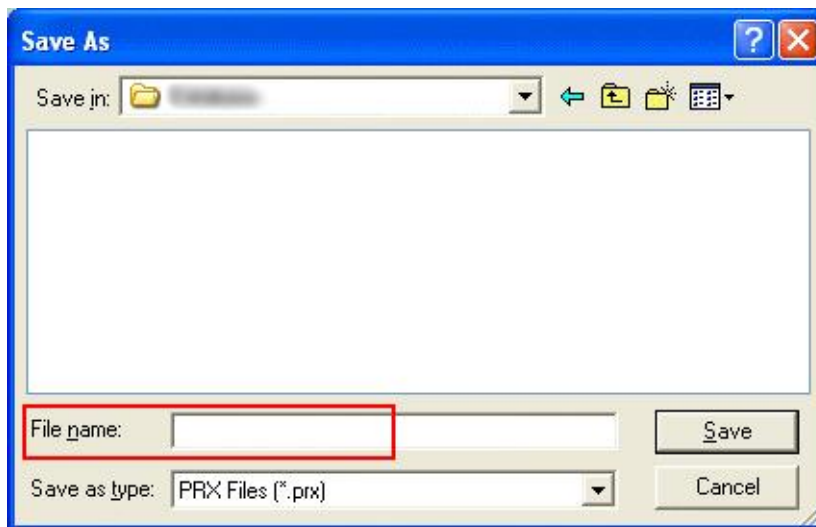

NOTE

When a file exists, the window that confirms whether or not to overwrite the file is displayed.

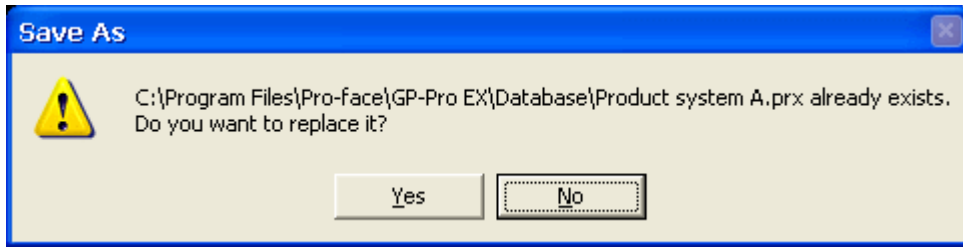

- (6) The following dialog box appears during transfer and you can check the communication status. (The display unit enters the Transferring mode and communication with the device such as a PLC is terminated.)

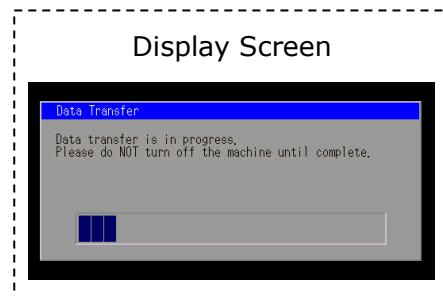
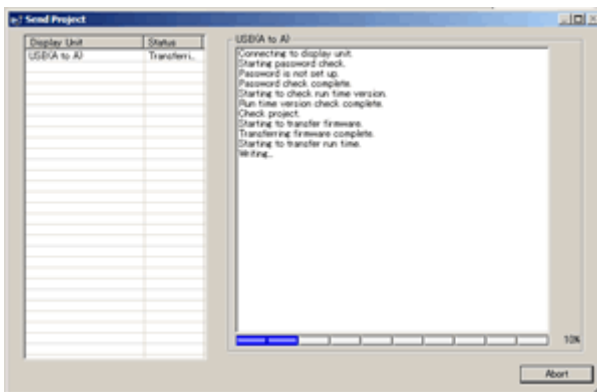

NOTE

- If you receive the project files that use CF card data such as Recipe Function (CSV data), the following dialog box will appear during transfer. Specify a place to save the CF card data in. Click [OK], and the [Receive Project] dialog box will return and transfer will be completed.



- GP-4301T/TW that is a replacement model is not equipped with a CF card slot. If the display unit type is changed to GP-4301T/TW, the CF card setting will be replaced with the SD card setting automatically.
To check or change the destination folder setting, see [[5.1 Changing the setting of the external media to use](#)].

(7) When transfer is completed, the status displayed in the dialog box will change from [Transferring] to [Complete Transfer]. Click [Close] to close the dialog box.

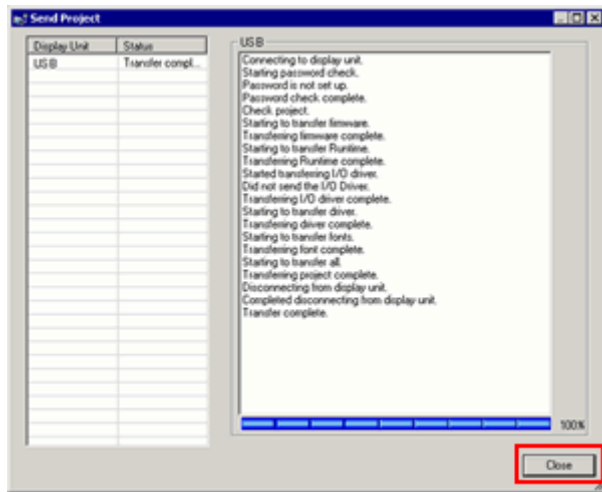

(8) Close the Transfer Tool.

3.4 Change the Display Unit Type

Open the received project file (*.prx) of GP-3300/ST-3300 series on GP-Pro EX and change the display unit type to GP-4301T/TW.

- (1) Open the received project file (*.prx) on GP-Pro EX.
- (2) Click [System Settings]->[Display]->[Change Display] in [Project] menu and change the Display Unit type to the replacement model.
- (3) Click [Project]->[Save As] and save the changed project data.

3.5 Transfer screen data to GP-4301T/TW

Transfer the project file after display unit type change to GP-4301T/TW.

You can transfer data to GP-4301T/TW via;

- An USB transfer cable (model: CA3-USBCB-01)
- An USB data transfer cable (model: ZC9USCBMB1)
- A commercial USB cable (USB Type A/mini B)
- A SD card (for GP-4301T only)/USB storage device
- Ethernet

But this section explains, as an example, how to transfer screen data with an USB transfer cable (model: CA3-USBCB-01).



- (1) Connect your PC and the GP unit of GP-4301T/TW with an USB transfer cable. If the driver of the cable has not been installed on you PC, a dialog box will appear. Please follow the instructions.

(2)

NOTE

- The "Hardware Installation" dialog box as shown below may appear during installing the USB driver depending on the security level of Windows® XP. Click [Continue Anyway] to start installing the driver. When installation is completed, click [Finish].

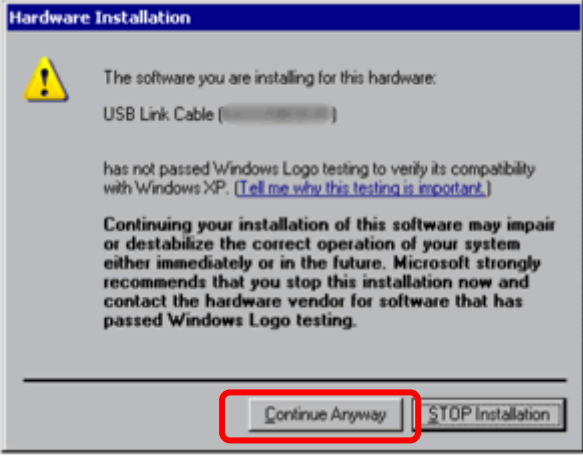

- If the following symptoms appear on Microsoft Windows® 7, go to updating "USB Data Transfer Driver" on [OtasukePro!] for download (http://www.pro-face.com/otasuke/download/freesoft/gproex_transfer.htm).
- An error occurs when GP-Pro EX or Transfer Tool is installed
- An error occurs when data is transferred via a USB transfer cable (model: CA3-USBCB-01).

- (3) Turn on the power of GP-4301T/TW. The “Initial Start Mode” screen will appear on the display unit. After transferring a project file once, this screen will not appear again.



- (4) On the GP-Pro EX's State Toolbar, click the [Transfer Project] icon to open the Transfer Tool.

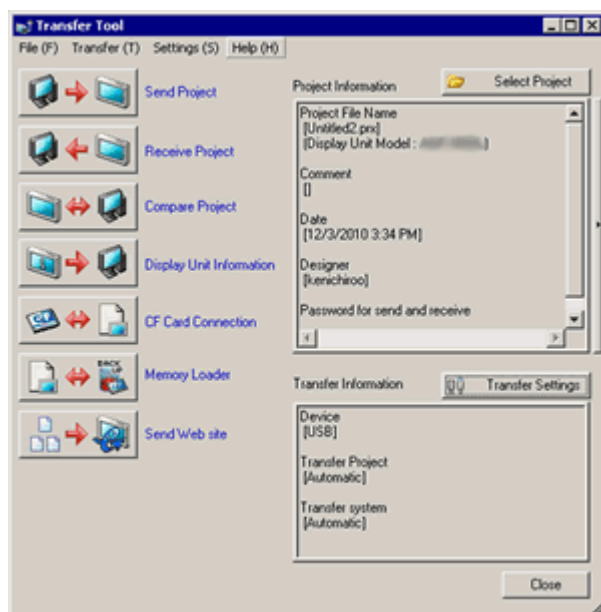

To transfer a different project file, click the [Select Project] button and select a project file.

- (5) Make sure that the [Device] in the "Transfer Settings Information" is set to [USB]. If not, click the [Transfer Setting] button to open the "Transfer Setting" dialog box. Select [USB] in the Communication Port Settings field and click [OK].



- (6) Click [Send Project] to start transfer. When the following dialog box appears, click [Yes]. This dialog box doesn't appear when the same project file is sent again.

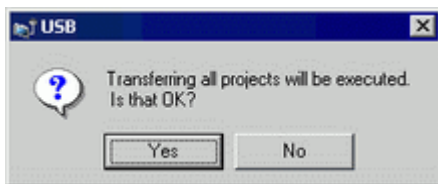

- (7) The following dialog box appears during transfer and you can check the communication status. (The display unit enters the Transferring mode and communication with the device such as a PLC is terminated.)

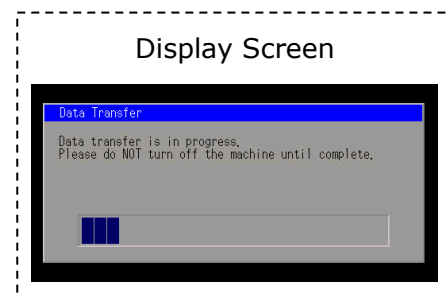
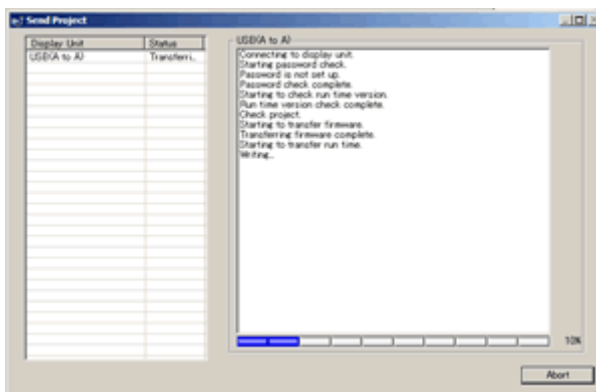

- (8) When transfer is completed, the status displayed in the dialog box will change from [Transferring] to [Complete Transfer]. Click [Close] to close the dialog box.

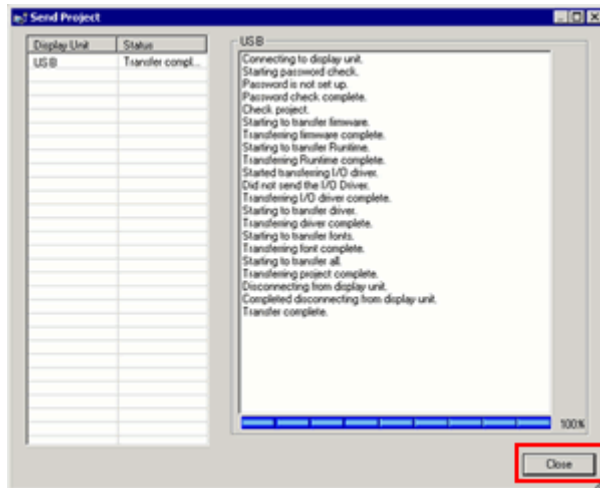

The display unit will be reset and a screen of the transferred project file will be displayed.

- (9) Close the Transfer Tool.
- (10) Click the [X] mark on top right of the screen or [Project]->[Exit] to close GP-Pro EX.

3.6 Differences of software

Some functions supported by GP-3300/ST-3300 series are not supported by GP-4301T/TW. For details of the supported parts and functions, refer to [Supported Features] of GP-Pro EX Reference Manual.

(<http://www.pro-face.com/otasuke/files/manual/gpproex/new/refer/gpproex.htm>).

Chapter 4 Communication with Device/PLC

4.1 Drivers

More connectable drivers will be added.

For the devices/PLC each driver supports, see [Connectable Devices] (<http://www.pro-face.com/product/soft/gpproex/driver/driver.html>).

4.2 Shapes of COM ports

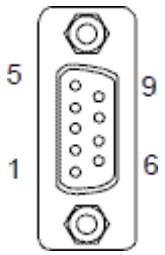
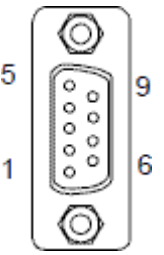
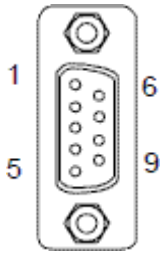
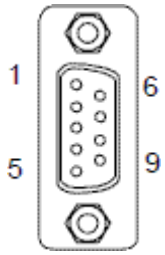
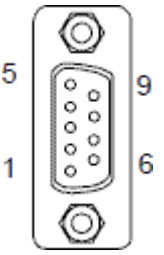
	GP-3300T/S/L GP-3301S/L	ST-3302B GP-4303T	GP-3302B	ST-3301T/S/B	GP-4301T/TW
COM 1	D-Sub 9 pin (plug) RS-232C/422/485	D-Sub 9 pin (plug) RS-232C			
					
COM 2	D-Sub 9 pin (socket) RS-422/485	D-Sub 9 pin (socket) RS-485 (for MPI only)	D-Sub 9 pin (plug) RS-422	D-Sub 9 pin (plug) RS-422/485	
					

4.3 Signals of COM ports

4.3.1 Signals of COM1

For GP-3300T/S/L and GP-3301S/L

RS-232C (plug)

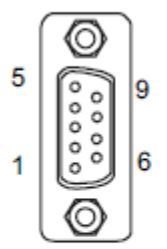
Pin Connection	Pin No.	RS-232C		
		Signal Name	Direction	Meaning
 <p>(GP unit side)</p>	1	CD	Input	Carrier Detect
	2	RD(RXD)	Input	Receive Data
	3	SD(TXD)	Output	Send Data
	4	ER(DTR)	Output	Data Terminal Ready
	5	SG	-	Signal Ground
	6	DR(DSR)	Input	Data Set Ready
	7	RS(RTS)	Output	Request to Send
	8	CS(CTS)	Input	Send possible
	9	CI(RI)/VCC	Input/-	Called Status Display +5V±5% Output 0.25A ^{*1}
	Shell	FG	-	Frame Ground (Common with SG)

*1: RI and VICC of Pin 9 are switched on the software.

VCC Output is not protected from overcurrent.

Please follow the current rating to avoid false operation or breakdown.

RS-422/485 (plug)

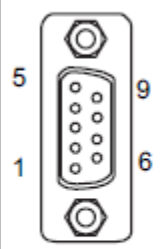
Pin Connection	Pin No.	RS-422/RS-485		
		Signal Name	Direction	Meaning
 <p>(GP unit side)</p>	1	RDA	Input	Receive Data A (+)
	2	RDB	Input	Receive Data B (-)
	3	SDA	Output	Send Data A (+)
	4	ERA	Output	Data Terminal Ready A (+)
	5	SG	-	Signal Ground
	6	CSB	Input	Send Possible B (-)
	7	SDB	Output	Send Data B (-)
	8	CSA	Input	Send Possible A (+)
	9	ERB	Output	Data Terminal Ready B (-)
	Shell	FG	-	Frame Ground (Common with SG)

For GP-3302B, GP-4303T, GP-3302B, ST-3301T/S/B and GP-4301T/TW
RS-232C (plug)

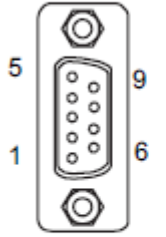
Pin Connection	Pin No.	RS-232C		
		Signal Name	Direction	Meaning
 (GP unit side)	1	CD	Input	Carrier Detect
	2	RD(RXD)	Input	Receive Data
	3	SD(TXD)	Output	Send Data
	4	ER(DTR)	Output	Data Terminal Ready
	5	SG	-	Signal Ground
	6	DR(DSR)	Input	Data Set Ready
	7	RS(RTS)	Output	Request to Send
	8	CS(CTS)	Input	Send possible
	9	CI(RI)/VCC	Input/-	Called Status Display +5V±5% Output 0.25A ^{*1}
	Shell	FG	-	Frame Ground (Common with SG)

*1: RI and VICC of Pin 9 are switched on the software.

VCC Output is not protected from overcurrent.

Please follow the current rating to avoid false operation or breakdown.

For GP-4301T/TW and ST-3301T/S/B
RS-232C (plug)

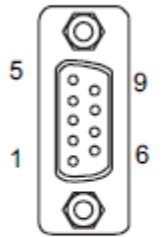
Pin Connection	Pin No.	RS-232C		
		Signal Name	Direction	Meaning
 (GP unit side)	1	CD	Input	Carrier Detect
	2	RD(RXD)	Input	Receive Data
	3	SD(TXD)	Output	Send Data
	4	ER(DTR)	Output	Data Terminal Ready
	5	SG	-	Signal Ground
	6	DR(DSR)	Input	Data Set Ready
	7	RS(RTS)	Output	Request to Send
	8	CS(CTS)	Input	Send possible
	9	CI(RI)/VCC	Input/-	Called Status Display +5V±5% Output 0.25A ^{*1}
	Shell	FG	-	Frame Ground (Common with SG)

*1: RI and VICC of Pin 9 are switched on the software.

VCC Output is not protected from overcurrent.

Please follow the current rating to avoid false operation or breakdown.

4.3.2 Signals of COM2

For GP-3300T/S/L and GP-3301S/L

RS-422/485 (socket)

Pin Arrangement	Pin No.	RS422/RS485		
		Signal Name	Direction	Meaning
 (GP unit side)	1	TRMRX	-	Termination (Receiver side: 100Ω)
	2	RDA	Input	Receive Data A(+)
	3	SDA	Output	Send Data A(+)
	4	RS(RTS)	Output	Request for Send
	5	SG	-	Signal Ground
	6	VCC	-	+5V±5% Output 0.25A *1
	7	RDB	Input	Receive Data B(-)
	8	SDB	Output	Send Data B(-)
	9	TRMTX	-	Termination (Receiver side: 100Ω)
	Shell	FG	-	Frame Ground (Common with SG)

*1: VCC Output is not protected from overcurrent.

Please follow the current rating to avoid false operation or breakdown.

For ST-3302B

RS-485 (for MPI only) (socket)

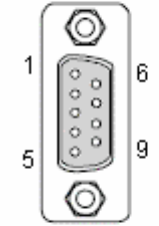
Pin Arrangement	Pin No.	RS485 (MPI only)		
		Signal Name	Direction	Meaning
 (female)	1	NC	-	-
	2	NC	-	-
	3	LINE(+)	Input/ Output	LINE(+)
	4	RS(RTS)	Output	Request to Send
	5	SG	-	Signal Ground*1
	6	5V	-	5V external output*2*3
	7	NC	-	-
	8	LINE(-)	Input/ Output	LINE(-)
	9	NC	-	-
	Shell	FG	-	Frame Ground*1 (Common with SG)

*1: The SG and FG terminals are isolated.

*2: You can supply power to the Siemens PROFIBUS connector only. You cannot supply power to the device/PLC.

For GP-3302B/ST-3301T/S/B

RS-422 (plug)

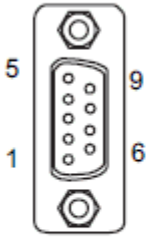
Pin Connection	Pin No.	RS-422		
		Signal Name	Direction	Meaning
 <p>(GP unit side)</p>	1	RDA	Input	Receive Data A (+)
	2	RDB	Input	Receive Data B (-)
	3	SDA	Output	Send Data A (+)
	4	ERA	Output	Data Terminal Ready A (+)
	5	SG	-	Signal Ground
	6	CSB	Input	Send Possible B (-)
	7	SDB	Output	Send Data B (-)
	8	CSA	Input	Send Possible A (+)
	9	ERB	Output	Data Terminal Ready B (-)
	Shell	FG	-	Frame Ground (Common with SG)

For GP-4301T/TW

RS-422/485 (plug)

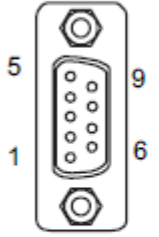
Pin Connection	Pin No.	RS-422/RS-485		
		Signal Name	Direction	Meaning
 <p>(GP unit side)</p>	1	RDA	Input	Receive Data A (+)
	2	RDB	Input	Receive Data B (-)
	3	SDA	Output	Send Data A (+)
	4	ERA	Output	Data Terminal Ready A (+)
	5	SG	-	Signal Ground
	6	CSB	Input	Send Possible B (-)
	7	SDB	Output	Send Data B (-)
	8	CSA	Input	Send Possible A (+)
	9	ERB	Output	Data Terminal Ready B (-)
	Shell	FG	-	Frame Ground (Common with SG)

4.4 Multilink Connection

For the communication drivers that support serial multi-link, see [[Which drivers support serial multilink communication?](#)]

(http://www.pro-face.com/otasuke/files/manual/gpproex/new/device/com_mlnk.htm).

4.5 Cable Diagram at the time of replacement

The connection cable for GP-3300/ST-3300 series can be used for GP-4301T/TW.

But please note that **there are precautions and restrictions as described below when replacing GP-3300T/S/L and GP-3301S/L**.

- When a RS-422/485 device is connected via the COM1 port, **if GP-3300T/S/L or GP-3301S/L is replaced with GP-4301T/TW, it will be connected via the COM2 port of GP-4301T/TW.** (The cable diagram can be still used.)

Before GP-4301T/TW is connected, be sure to change the port setting to COM2 on the Device/PLC setting. Also, please check the communication settings with GP-Pro EX Device/PLC Connection Manual just in case.

(<http://www.pro-face.com/otasuke/files/manual/gpproex/new/device/index.htm>)

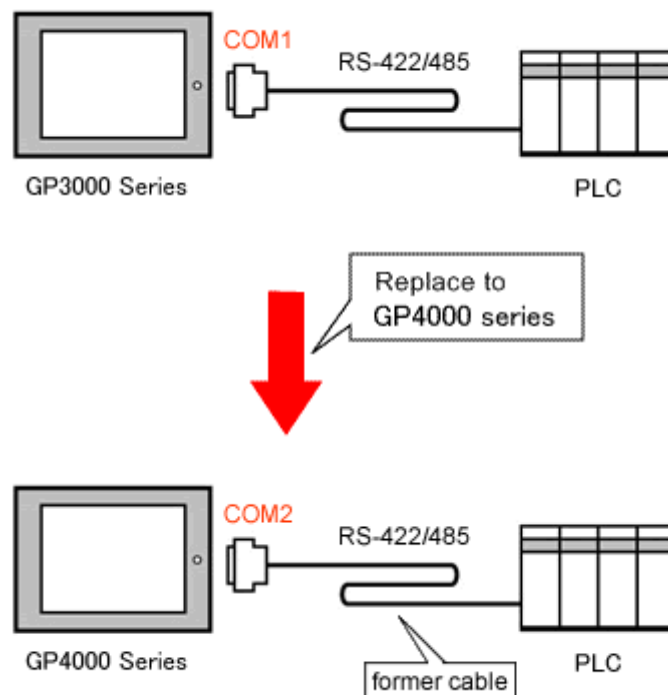

- The cable used for connection to **GP-3300T/S/L or GP-3301S/L via COM2** can be used for GP-4301T/TW with a COM Port Conversion Adapter (CA3-ADPCOM-01) added in the following cases;

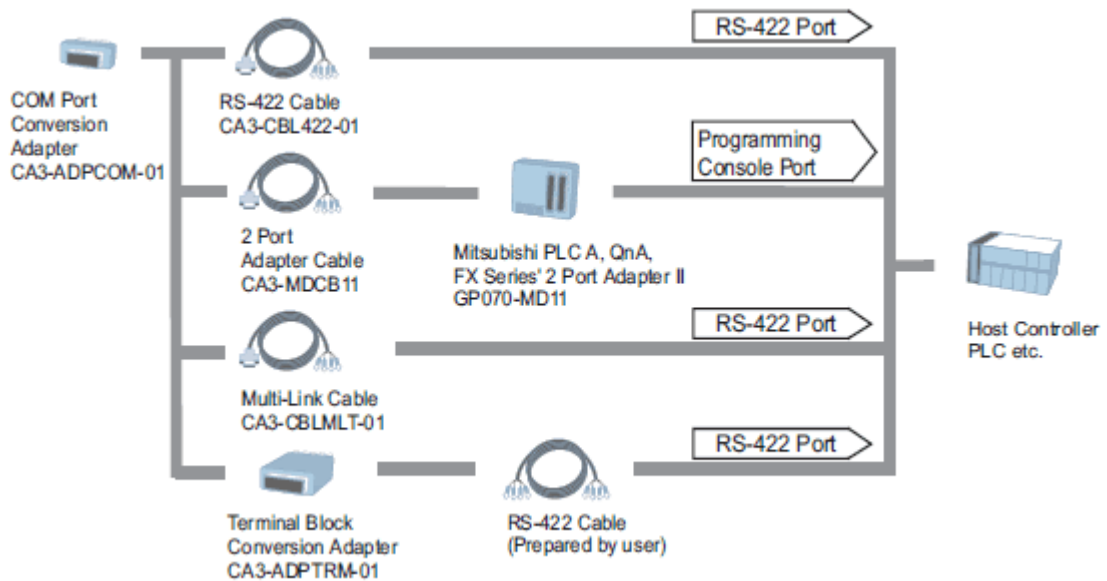

In all other cases, the operation is not guaranteed and it's recommended to prepare a new connection cable. To check the cable diagram, please refer to GP-Pro EX Device/PLC Connection Manual.

Chapter 5 Appendix

5.1 Changing the setting of the external media to use

If a CF card is used for GP-3300 series, after the display unit type of the project file is changed to GP-4301T/TW, "a CF card" is automatically replaced with "a SD card" for the external media setting.

- (1) After conversion of the project file data, at GP-Pro EX Error Check, if the message, "The project contains features that require a SD card. However, the selected display does not support SD cards so these features will not run." appears,

Error Check			
Level	Error Num	Screen-L	Summary
Warning	1506	----	A feature that requires the SD card is enabled. However, as the current model does not support the SD card, this feature will not work.
Error			No Error

<Cause>

The model without a SD card slot has the setting that uses a SD card.

->[Solution 1](#)

(2) To use a USB storage device instead of a SD card->[Solution 1](#)

(3) To check or change the SD card's data output destination folder setting

->[Solution 2](#)

[Solution]

1. Change the SD card setting to the USB storage setting following the steps below.

<Procedure>

- i. Click [Project]->[Information]->[Destination Folder].
- ii. Uncheck "Enable SD Card" and check "Enable USB Storage".

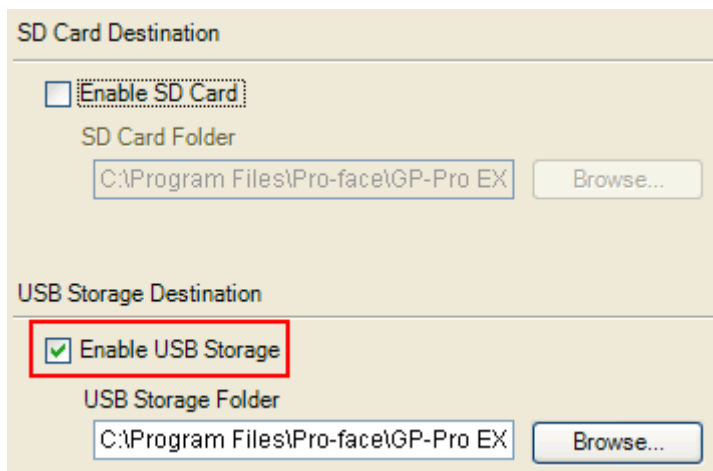

- iii. Click the [Browse] button and specify a destination folder.

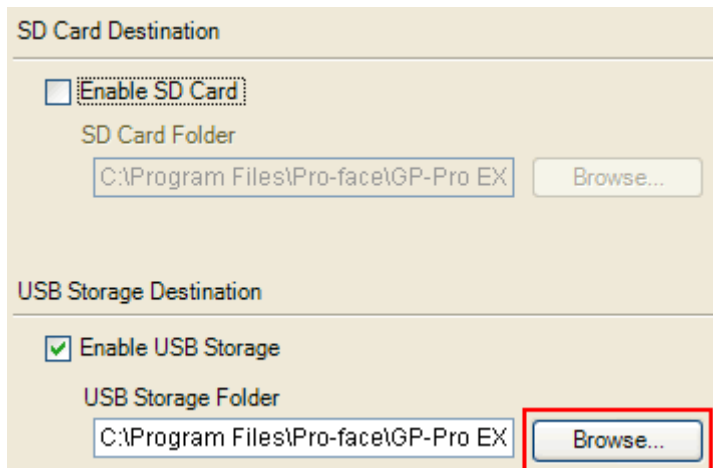

- iv. Click [OK] to confirm the setting.
- v. Click [Project]->[Save] to save changes.
- vi. Check each function that uses the CF card and replace the setting of [SD Card] with the one of [USB Storage].

NOTE

To check each function setting of GP-Pro EX, refer to GP-Pro EX Reference Manual.

2. Check and change the destination folder setting following the steps below.
 - i. Click [Project]->[Information]->[Destination Folder].
 - ii. The current setting is displayed.

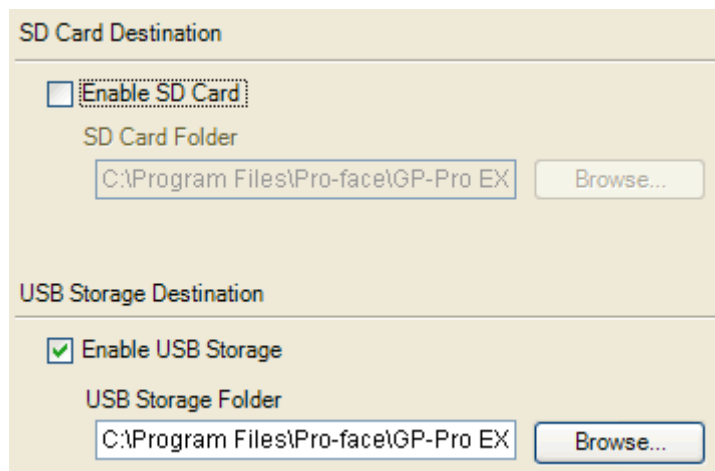

The screenshot shows a dialog box titled "SD Card Destination" and "USB Storage Destination". The "SD Card Destination" section has an unchecked checkbox for "Enable SD Card" and a text field for "SD Card Folder" containing "C:\Program Files\Pro-face\GP-Pro EX" with a "Browse..." button to its right. The "USB Storage Destination" section has a checked checkbox for "Enable USB Storage" and a text field for "USB Storage Folder" containing "C:\Program Files\Pro-face\GP-Pro EX" with a "Browse..." button to its right.

- iii. After changing it, click [OK] to confirm the setting.
 - iv. Click [Project]->[Save] to save changes.