

Easy! Smooth!

GP-577R Series→GP4000 Series



Replacement Guidebook

Preface

This manual introduces the procedures to replace a GP-577RT/S unit with a unit in GP-4501T/TW.

Model in use	Recommended Substitution
GP-577RT/S	GP-4501T*1
	GP-4501TW*1

*1: A recommended substitution differs depending on a power supply type of the model you use.

When replacing AC power supply type (GP577R-TC11/GP577R-SC11);	When replacing DC power supply type (GP577R-TC41-24V/ GP577R-SC41-24V);
 <p>The power supply type is AC, but the panel cutout dimensions are different. An attachment is required.</p>	 <p>We recommend GP-4501TW whose power supply type and panel cutout dimensions are the same as those of GP577R-TC41-24V/ GP577R-SC41-24V.</p>
 <p>The panel cutout dimensions are the same, but the power supply type needs to be changed to a DC type. (*There's no AC power supply type)</p>	

Safety Information

HAZARD OF OPERATOR INJURY, OR UNINTENDED EQUIPMENT DAMAGE

Before operating any of these products, be sure to read all related manuals thoroughly.

Failure to follow these instructions can result in death, serious injury or unintended equipment damage.

GP4000 Series Model Number

GP4000 series model number partly differs depending on a specification. Before placing an order, please make sure of the model number.

PFXGP4 * 0 * * * * *

A

B

C

D

E

F

A	2	GP-4200 series (3.5")
	3	GP-4300 series (5.7")
	4	GP-4400 series (7.5"/7.0W")
	5	GP-4500 series (10.4")
	6	GP-4600 series (12.1")
B	01	RS-232C/422/485
	03	RS-485 (isolation)
C	T	TFT color LCD
	W	TFT color LCD (Wide Type)
D	A	Analog Resistive Film Touch Panel
	M	Matrix Resistive Film Touch Panel
E	A	AC Type Power Supply
	D	DC Type Power Supply
F	W	GP-4201TW/4301TW/4401WW/4501TW
	C	Coated model
	WC	Coated model of GP-4201TW/4301TW/4401WW/4501TW

Contents

<u>PREFACE</u>	<u>2</u>
<u>SAFETY INFORMATION</u>	<u>2</u>
<u>HAZARD OF OPERATOR INJURY, OR UNINTENDED EQUIPMENT DAMAGE</u>	<u>2</u>
<u>GP4000 SERIES MODEL NUMBER</u>	<u>3</u>
<u>CONTENTS</u>	<u>4</u>
<u>CHAPTER 1 SPECIFICATION COMPARISON</u>	<u>7</u>
1.1 SPECIFICATIONS OF GP-577RT/S AND GP-4501T	7
1.2 SPECIFICATIONS OF GP577RT/S AND GP-4501TW	9
<u>CHAPTER 2 COMPATIBILITY OF HARDWARE</u>	<u>11</u>
2.1 LOCATIONS OF CONNECTOR	11
2.2 TOUCH PANEL SPECIFICATIONS	13
2.2.1 WHEN REPLACING GP-577RT/S WITH GP-4501T	13
2.2.2 WHEN REPLACING GP-577RT/S WITH GP-4501TW	13
2.3 PANEL CUTOUT DIMENSIONS (ONLY WHEN REPLACING WITH GP-4501T)	14
2.4 TRANSFER CABLE	14
2.5 INTERFACE	14
2.5.1 SERIAL INTERFACE	14
2.5.2 AUXILIARY I/O INTERFACE (AUX)	15
2.5.3 CF CARD INTERFACE (ONLY WHEN USING "MULTI UNIT" (GP077-MLTS11, GP077-MLTE41))	15
2.6 PERIPHERAL UNITS AND OPTION UNITS	15
2.6.1 BARCODE READER CONNECTION	15

2.6.2	PRINTER CONNECTION	16
2.6.3	EXPANSION UNIT	16
2.6.4	FRONT MAINTENANCE UNIT	16
2.6.5	ISOLATION UNIT	16
2.7	POWER CONNECTOR	16
2.7.1	AC POWER SUPPLY TYPE	16
2.7.2	DC POWER SUPPLY TYPE	17
2.8	BACKUP BATTERY	17
2.9	POWER CONSUMPTION	17
2.10	MATERIALS/COLORS OF THE BODY	18
2.11	ABOUT PRO-SERVER	18
2.12	OTHER NOTES	18

CHAPTER 3 REPLACEMENT PROCEDURE **19**

3.1	WORK FLOW	19
3.2	PREPARATION	20
3.3	RECEIVE SCREEN DATA FROM GP-577RT/S	21
3.4	CONVERT SCREEN DATA WITH THE PROJECT CONVERTER	25
3.5	CHANGE THE DISPLAY UNIT TYPE (ONLY WHEN REPLACING WITH GP-4501TW)	32
3.6	TRANSFER THE SCREEN DATA TO GP-4501T/TW	32
3.7	DIFFERENCES OF SOFTWARE	37
3.7.1	DIFFERENCES AFTER CONVERSION	37

CHAPTER 4 COMMUNICATION WITH DEVICE/PLC **39**

4.1	DRIVER LIST	39
4.2	SHAPES OF COM PORTS	40
4.3	SIGNALS OF COM PORTS	41
4.3.1	SIGNALS OF COM1	41
4.3.2	SIGNALS OF COM2	43
4.4	MULTILINK CONNECTION	44
4.5	INTERNAL 2-PORT FEATURE FOR MITSUBISHI PLC	44
4.6	CABLE DIAGRAM AT THE TIME OF REPLACEMENT	45
4.6.1	WHEN USING A RS-232C CONNECTION CABLE	46



4.6.2 WHEN USING A RS-422 CONNECTION CABLE 47

CHAPTER 5 APPENDIX **51**

5.1 CHANGING THE SETTING OF THE EXTERNAL MEDIA TO USE 51



Chapter 1 Specification Comparison

1.1 Specifications of GP-577RT/S and GP-4501T

		GP-577RT/S	GP-4501T
			
Display Type	GP-577RT	TFT color LCD	TFT color LCD
	GP-577RS	STN color LCD	
Display Colors, Levels	GP-577RT	64 colors (RGB-4 levels)	UP! 65,536 colors (without blink)/ 16,384 colors (with blink)
	GP-577RS	64 colors	
Display Resolution		VGA (640×480 pixels)	
Panel Cutout Dimensions (mm)		302(W) x 228(H)	259(W) x 201(H) →See 2.3
External Dimensions (mm)		317(W) x 243(H) x 85(D)	272.5(W) x 214.5(H) x 57(D)
Touch Panel Type		Matrix	Analog/Matrix →See 2.2.1
Memory	Application	2MB	UP! 32MB
	SRAM	96KB	UP! 320KB
Backup Battery		Secondary Battery (Rechargeable Lithium battery)	NEW! Primary Battery (Replaceable Lithium battery) →See 2.8
Rated Input Voltage		AC 100 to 240V/ DC 24V	
Serial I/F	COM1	25 pin D-Sub (socket) RS-232C/422	9 pin D-Sub (plug) RS-232C →See 2.5.1
	COM2	-	9 pin D-Sub (plug) RS-422/485 →See 2.5.1
Ethernet I/F		-	NEW! 10BASE-T/100BASE-TX

SD Card I/F		-	NEW! ✓
USB I/F	Type A	-	NEW! ✓ → See 2.4
	Type mini B		
Tool Connector I/F		✓	-
Printer I/F		Centronic-compliant (parallel)	NEW! USB (Type A) → See 2.6.2
Auxiliary I/O I/F		✓	- → See 2.5.2
Expansion Unit I/F		✓	- → See 2.6.3

1.2 Specifications of GP577RT/S and GP-4501TW

		GP-577RT/S	GP-4501TW
			
Display Type	GP-577RT	TFT color LCD	TFT color LCD
	GP-577RS	STN color LCD	
Display Colors, Levels	GP-577RT	64 colors (RGB-4 levels)	UP! 65,536 colors (without blink)/ 16,384 colors (with blink)
	GP-577RS	64 colors	
Display Resolution		VGA (640×480 pixels)	
Panel Cutout Dimensions (mm)		302(W) x 228(H)	301.5(W) x 227.5(H)
External Dimensions (mm)		317(W) x 243(H) x 85(D)	315(W) x 241(H) x 56(D)
Touch Panel Type		Matrix	NEW! Analog → See 2.2.2
Memory	Application	2MB	UP! 16MB
	SRAM	96KB	UP! 128KB
Backup Battery		Secondary Battery (Rechargeable Lithium battery)	NEW! Primary Battery (Replaceable Lithium battery) → See 2.8
Rated Input Voltage		AC 100 to 240V/ DC 24V	
Serial I/F	COM1	25 pin D-Sub (socket) RS-232C/422	9 pin D-Sub (plug) RS-232C → See 2.5.1
	COM2	-	9 pin D-Sub (plug) RS-422/485 → See 2.5.1
Ethernet I/F		-	NEW! 10BASE-T/100BASE-TX
SD Card I/F		-	NEW! ✓

USB I/F	Type A	-	NEW! ✓ → See 2.4
	Type mini B		
Tool Connector I/F		✓	-
Printer I/F		Centronic-compliant (parallel)	NEW! USB (Type A) → See 2.6.2
Auxiliary I/O I/F		✓	- → See 2.5.2
Expansion Unit I/F		✓	- → See 2.6.3

Chapter 2 Compatibility of Hardware

2.1 Locations of connector

Connector locations on GP-577RT/S and GP-4501T/TW are as follows;

GP-577RT/S

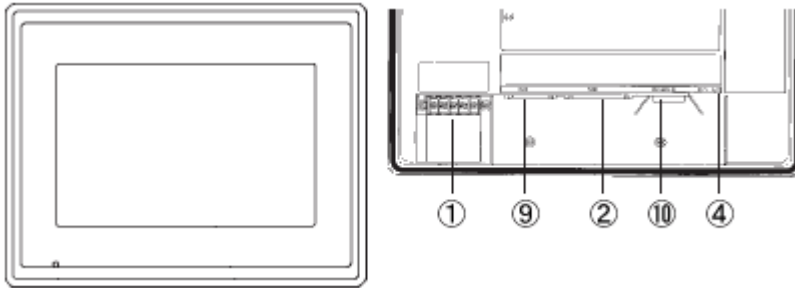

GP-4501T/TW

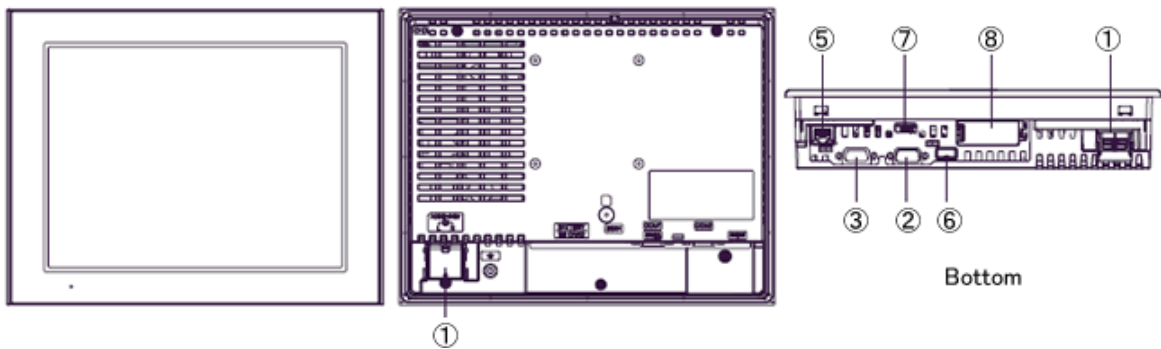

Interface names

	GP-577RT/S	GP-4501T	GP-4501TW
1	Power Input Terminal Block (AC/DC type)	Power Input Terminal Block (AC type)/ Power Connector (DC type)	Power Connector (DC type)
2	Serial I/F (COM1)		
3	-	Serial I/F (COM2)	
4	Tool Connector	-	
5	-	Ethernet I/F	
6	-	USB I/F (Type A)	
7	-	USB I/F (Type mini B)	
8	-	SD Card I/F	
9	Auxiliary I/F (AUX)	-	
10	Printer I/F	-	

2.2 Touch Panel specifications

2.2.1 When replacing GP-577RT/S with GP-4501T

For replacing GP-577RT/S with GP-4501T, you can select the Matrix type (2-point touch input at the same time same as GP-577RT/S) or the Analog type (1-point touch input) for Touch Panel Type.

If you have used the 2-point touch input on GP-577RT/S, please select Matrix type.

GP-4501T model number

	AC power supply type	DC power supply type
Analog type *	PFXGP4601TAA	PFXGP4601TAD
Matrix type	PFXGP4601TMA	PFXGP4601TMD

* For the Analog type, if you have used the 2-point touch input on GP-577RT/S, change to the 1-point touch input setting using the switch delay function of GP-Pro EX.

2.2.2 When replacing GP-577RT/S with GP-4501TW

GP-4501TW adopts the Analog type.

There's a difference between the GP-4501T and GP-4501TW as below,

GP-4501T	Analog type *	Even if you touch two points at the same time, it's recognized that the coordinates located between these two points are touched.
	Matrix type	Supported the 2-point touch input
GP-4501TW	Analog type *	Even if you touch two points at the same time, it's recognized that the coordinates located between these two points are touched.

* For the Analog type, If you have used the 2-point touch input on GP-577RT/S, change to the 1-point touch input setting using the switch delay function of GP-Pro EX.

2.3 Panel cutout dimensions (only when replacing with GP-4501T)



The size of GP-4501T gets smaller. The panel cutout dimensions of GP-4501T are different from those of GP-577RT/S. Attachment (model: CA4-ATM10-01) for installing GP-4501T is available and you can use it when replacing GP-577RT/S with GP-4501T.

For replacing the other models, there's no change in the panel cutout dimensions.

2.4 Transfer cable

To transfer screen data to GP-4501T/TW, use a USB transfer cable or Ethernet.

The USB cables that can be used for GP-4501T/TW are as follows;

	Model	Connector Type	Connector on GP
Options	CA3-USBCB-01	 Type A Type A	USB (Type A)
	ZC9USCBMB1	 Type A Type mini B	USB (Type mini B)
Commercial Item	-		

Please note that the cables (GPW-CB02, GPW-CB03, GP430-CU02-M) for GP-577RT/S cannot be used for GP-4501T/TW.

2.5 Interface

2.5.1 Serial Interface

The pin assignment and the shape of plug/socket connector of GP-577RT/S are different from those of GP-4501T/TW.

To know the details about them, see [[4.2 Shapes of COM ports](#)] and [[4.3 Signals of COM ports](#)].

Because of it, the existing PLC connection cables cannot be used as they are. If you use the existing connection cables, see [[4.5 Cable Diagram at the time of replacement](#)].

2.5.2 Auxiliary I/O Interface (AUX)

GP-4501T/TW is not equipped with Auxiliary I/O Feature. External Reset Input and 3 Outputs (RUN Output, System Alarm Output, and External Buzzer Output) that can be used for GP-577RT/S cannot be used.

2.5.3 CF Card Interface

(only when using "Multi Unit" (GP077-MLTS11, GP077-MLTE41))

GP-4501T/TW is not equipped with a CF card slot. But a SD card slot and a USB interface are installed. In order to use the GP-577RT/S data saved in the CF card and the functions using the CF card with using Multi Unit (GP077-MLTS11, GP077-MLTE41), use a SD card or a USB flash drive instead.

* When using a SD card with GP-4501T/TW, please verify it supports the following specifications:

	File format	Maximum capacity
SD	FAT16	2GB
SDHC	FAT32	32GB

For the GP-PRO/PBIII's "CF Card output folder" setting, if project file is converted on GP-Pro EX, the setting will automatically change to the one that uses a SD card. To change the setting of the output destination folder, see [[5.1 Changing the setting of the external media to use](#)].

(The sound output function of the Multi Unit (GP077-MLTS11, GP077-MLTE41) cannot be used for GP-4501T/TW.)

2.6 Peripheral units and option units

2.6.1 Barcode reader connection

GP-4501T/TW is not equipped with a tool port. A barcode reader that used to be connected to the tool port on GP-577RT/S cannot be used. However, GP-4501T/TW

allows you to connect a barcode reader on its USB interface (Type A) or its serial interface.

For the models GP-4501T/TW supports, see [OtasukePro!]

(http://www.pro-face.com/otasuke/qa/3000/0056_connect_e.html).

2.6.2 Printer connection

GP-4501T/TW is not equipped with Centronics (parallel) Interface for a printer though GP-577RT/S is equipped with it. If the printer for GP-577RT/S is used for GP-4501T/TW, a converter that converts USB I/F on GP-4501T/TW to Centronics I/F is required. And GP-4501T/TW allows you to connect a printer on its USB port.

For the models GP-4501T/TW supports, see [OtasukePro!]

(http://www.pro-face.com/otasuke/qa/3000/0056_connect_e.html).

2.6.3 Expansion Unit

GP-4501T/TW is not equipped with an expansion unit interface. The expansion unit (each kind of unit like CC-LINK Unit) for GP-577RT/S cannot be used.

2.6.4 Front Maintenance Unit

The front maintenance unit for GP-577RT/S (GP077-CFFM10) cannot be used for GP-4501T/TW.

2.6.5 Isolation Unit

The isolation unit for GP-577RT/S (CA2-ISOALL232-01, CA2-ISOALL422-01) cannot be used for GP-4501T/TW. You can use the RS-232C isolation unit for GP-4501T/TW (CA3-ISO232-01) instead.

2.7 Power Connector

2.7.1 AC power supply type

The power connector on GP-4501T (AC type) has the same terminal block as GP-577RT/S (AC type), but the FG location is different.

GP-4501TW has a DC power supply type only. When replacing GP-577RT/S (AC

type) with GP-4501TW, changing to DC power supply is required.

2.7.2 DC power supply type

The power connector on GP-4501T/TW (DC type) is a spring lock type.

If you replace GP-577RT/S (DC type) with GP-4501T/TW (DC type), change the power cable.

2.8 Backup Battery

Unlike GP-577RT/S, GP-4501T/TW does not use rechargeable secondary batteries but replaceable primary ones. (For both a rechargeable type and a replaceable one, contents to be backed up are the same.)

When the time for replacement of backup batteries approaches, the message to urge you to replace the battery, "RAAA053: Running out of power in the backup battery. Please change the battery." appears. When the message appears, replace the battery referring to the GP4000 series hardware manual.

Replaceable Battery Model
PFXZCBBT1

2.9 Power Consumption

The power consumption of GP-577RT/S is different from that of GP-4501T/TW.

	AC Type	DC Type
GP-577RT/S	50VA or less (AC100V)	50W or less
GP-4501T	44VA or less (AC100V) 58VA or less (AC240V)	17W or less
GP-4501TW	-	

For the detailed electric specifications, see the hardware manual.

2.10 Materials/Colors of the body

The materials and the colors of GP-577RT/S and GP-4501T/TW are as follows;

	Color	Material
GP-577RT/S	Dark Gray	Resin
GP-4501T/TW	Light Gray	Resin with glass

2.11 About Pro-Server

If the Pro-Server with Pro-Studio is used, please use the Pro-Server EX Ver.1.30 or later. For details of the installation, refer to the

http://www.pro-face.com/otasuke/qa/server_ex/replace/.

2.12 Other Notes

- Do not expose GP4000 series to direct sunlight.
- Do not use GP4000 series outdoors.
- Do not turn on GP4000 series if condensation has occurred inside the device.
- When you are continuously using GP4000 series without oxygen, the brightness might decrease. Please ventilate the control panel periodically.

Chapter 3 Replacement Procedure

3.1 Work Flow

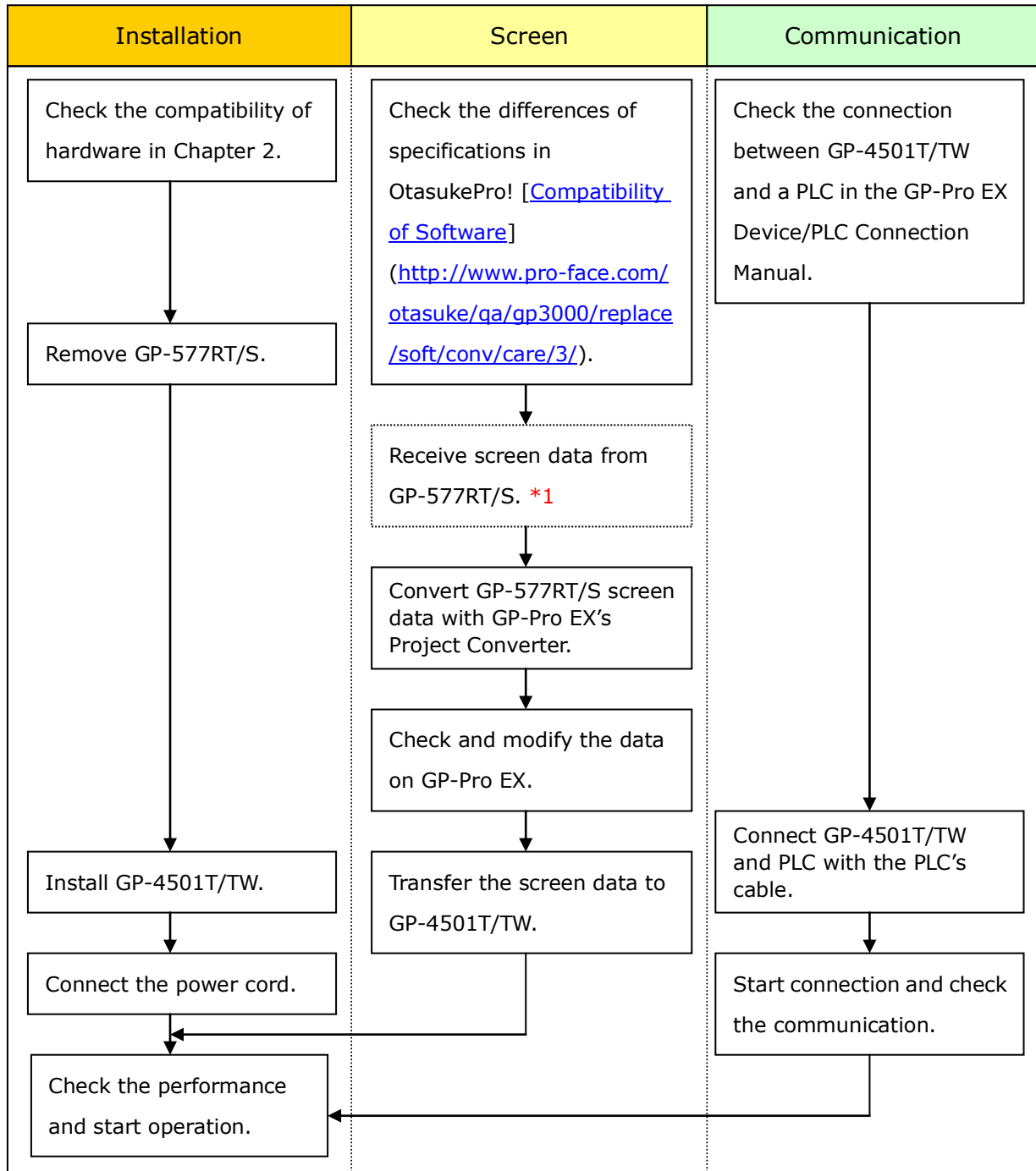

*1: This step is required if screen data is saved only in the GP unit, not in any other device.

3.2 Preparation

Requirements for receiving screen data from GP-577RT/S *1	PC in which GP-PRO/PBIII for Windows V2.1 or later is installed. *2
	Transfer cable (The following three types of cables are available) <ul style="list-style-type: none"> • GPW-CB02 (D-sub 9-pin to the PC) • GPW-CB03 (USB to the PC *3) • GP430-CU02-M or GPW-SET (D-sub 25-pin to the PC)
Requirements for converting screen data of GP-577RT/S and transferring the converted data to GP-4501T/TW	PC in which GP-Pro EX Ver.3.01 or later is installed
	Transfer cable (The following three types of cables are available) <ul style="list-style-type: none"> • A USB transfer cable (model:CA3-USBCB-01) • A USB data-transfer cable (model:ZC9USCBMB1) • A commercial USB cable (USB Type A/mini B) <p>* Possible to send/receive a screen with a SD card, a USB storage device, or via Ethernet.</p>

*1: This step is required if screen data is saved only in the GP unit, not in any other device

*2: Please use the same version or later as or than that of the software used during creating screens on GP-577RT/S.

If you don't know the version, we recommend you to use the newest version. The newest version is GP-PRO/PBIII for Windows C-Package03 (SP2) V7.29. Those who have GP-PRO/PBIII for Windows C-Package03 V7.0 can download it from our web site called [OtasukePro!] (<http://www.pro-face.com/otasuke/download/update/>).

*3: GPW-CB03 is supported by GP-PRO/PBIII for Windows C-Package02 (SP2) V6.23 or later. You need to install a driver from [Download] on our Web site called [OtasukePro!] (<http://www.pro-face.com/otasuke/download/driver/>)

3.3 Receive screen data from GP-577RT/S

This section explains, as an example, how to receive screen data from GP-577RT/S using a transfer cable, GPW-CB02 or GPW-CB03. If you have backed up screen data, this step is unnecessary; skip to the next section [[3.4 Convert screen data with the Project Converter](#)].

(1) Connect a transfer cable to the GP-577RT/S unit.

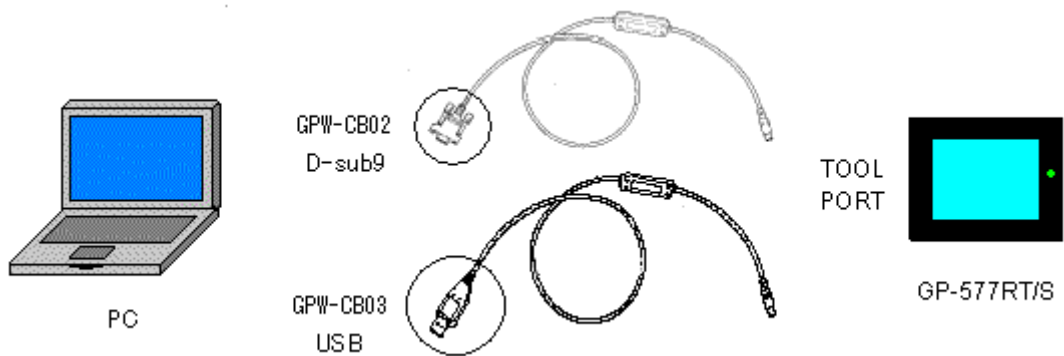

(2) Start up GP-PRO/PBIII for Windows and click the [Transfer] icon on the Project Manager (Specify a desired project file.)



(3) On the [Transfer] window, select the [Setup] menu and click [Transfer Settings...].

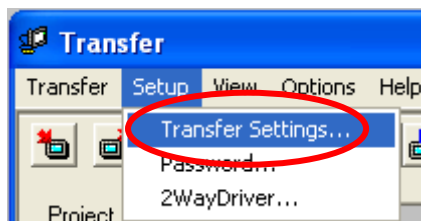

(4) In the Communication Port field, select [COM], specify the COM port to which the cable is connected, and click [OK].

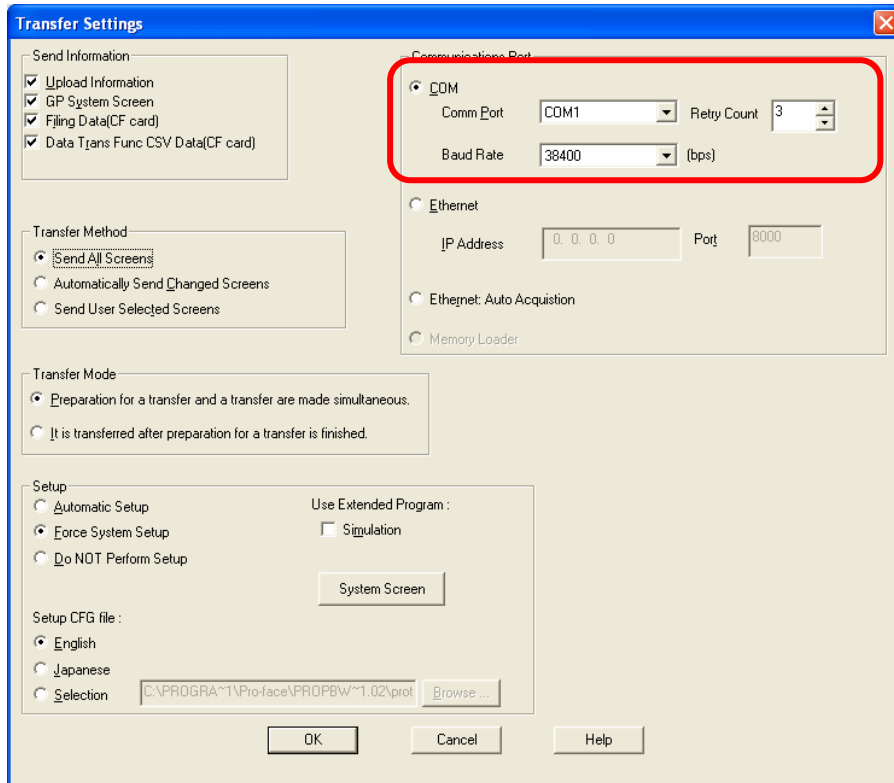

If you use a USB transfer cable (GPW-CB03)

You can check the COM port for the USB transfer cable (GPW-CB03), which is assigned to the PC, with the Device Manager of Windows.

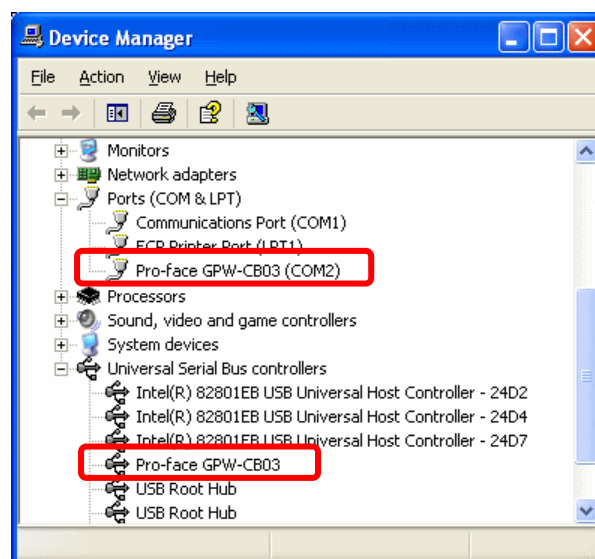

(5) Select the [Transfer] menu and click [Receive...].

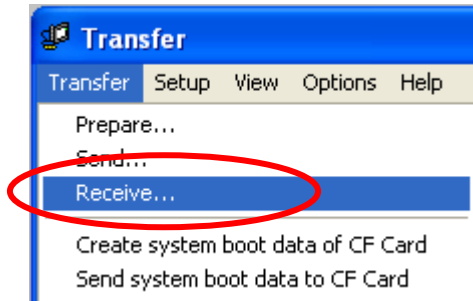

(6) Specify the location to save the received screen data at and the project file name and save them.

In case there is no Upload Information

“Upload Information” is necessary to receive screen data from GP-577RT/S. It needs to be included in screen data when transferring screen data to the display unit beforehand. The Upload Information is sent to the display unit by default, however, you may check off the box of Upload Information to prevent screen reception by a third party.

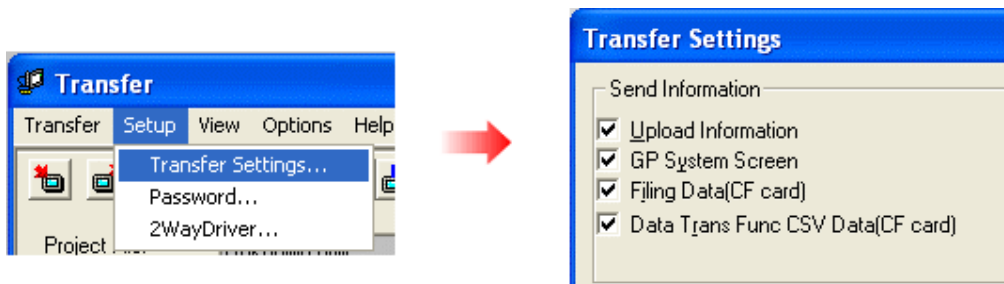

You can check in the following way if the Upload Information has been sent or not.

1. Enter into the GP's Offline mode
2. If there are 2 asterisk (*) marks in the Main menu as shown below, the Upload Information has been sent.

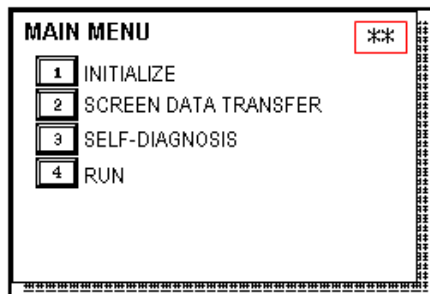

If not, there is no “Upload Information” sent. In this case, a message, which indicates there is no “Upload Information”, appears and you cannot receive the data.

3.4 Convert screen data with the Project Converter

Convert a project file (*.prw) for GP-577RT/S with the GP-Pro EX's Project Converter.

- (1) Click the [Start] button, select [All Programs] (or [Programs])-> [Pro-face]-> [GP-Pro EX *.**]->[Project Converter].

(For this part, [*.**], the version of the software you use is displayed.)

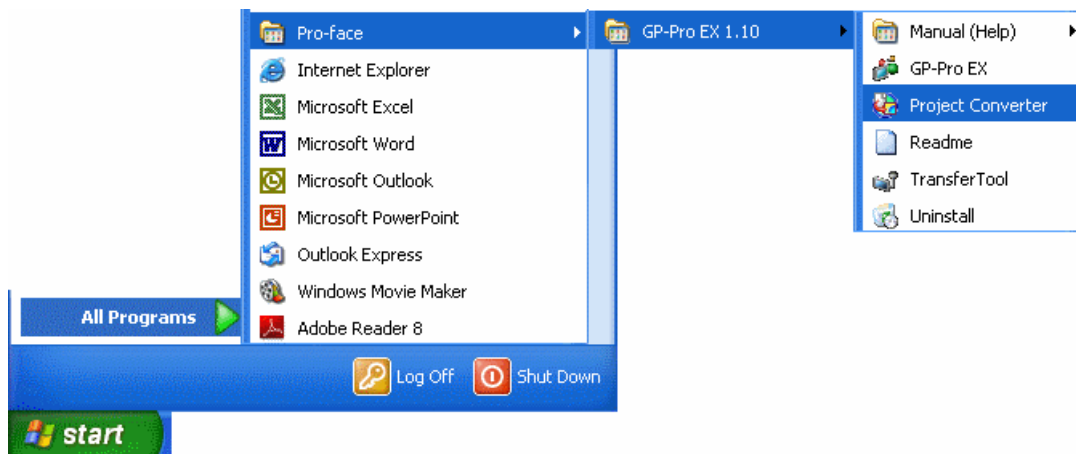

- (2) The Project Converter starts up and the [Project Converter] dialog box opens. Select [Project File (*.PRW)] in the [Data Type].

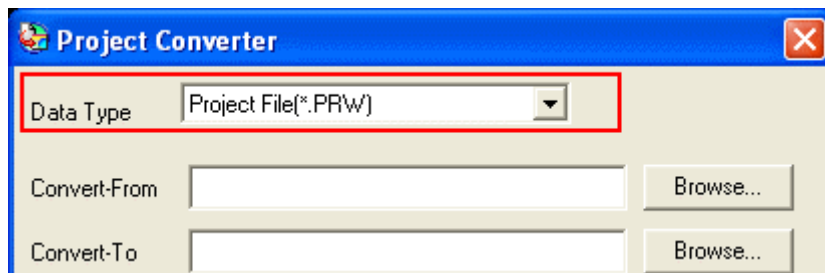

- (3) Click the [Browse...] button and select a project file (e.g.: "Project system A.prw"). Click [Open], and the file will be set in [Convert-From].

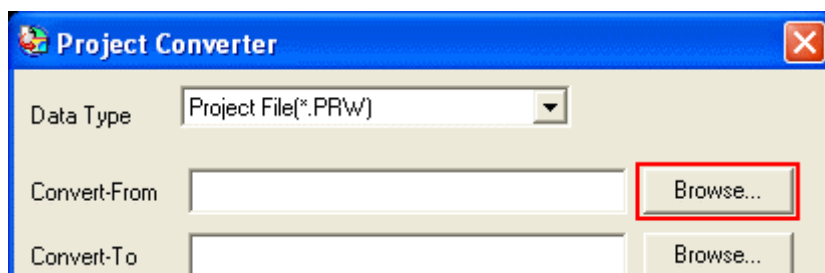

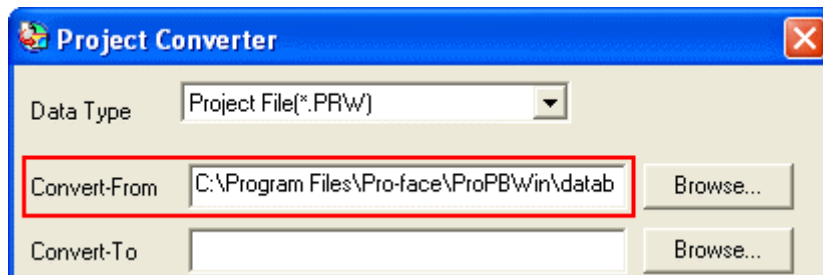
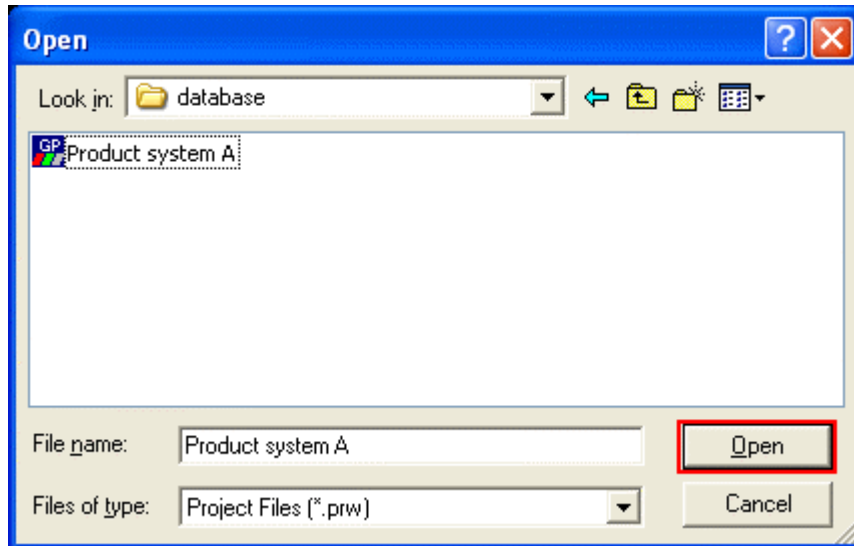

(4) In [Convert-To], designate a GP-Pro EX's project file (*.prx). Click the [Browse...] button and enter a new [File Name] (e.g.: "Product system A.prx"). Click [Save], and a new project file will be set to [Convert-To].

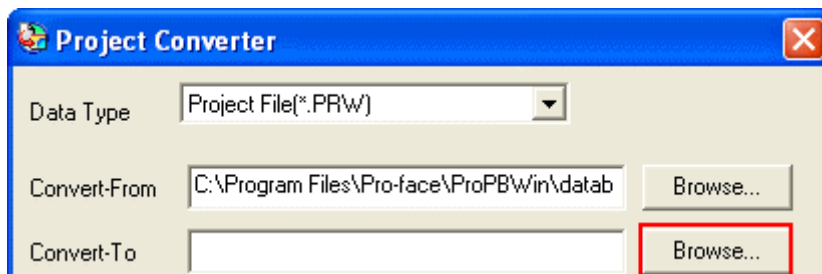

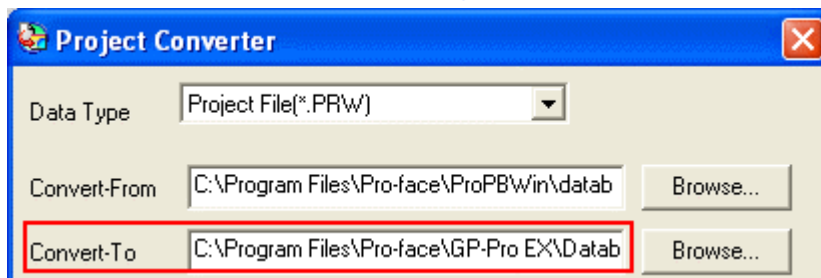
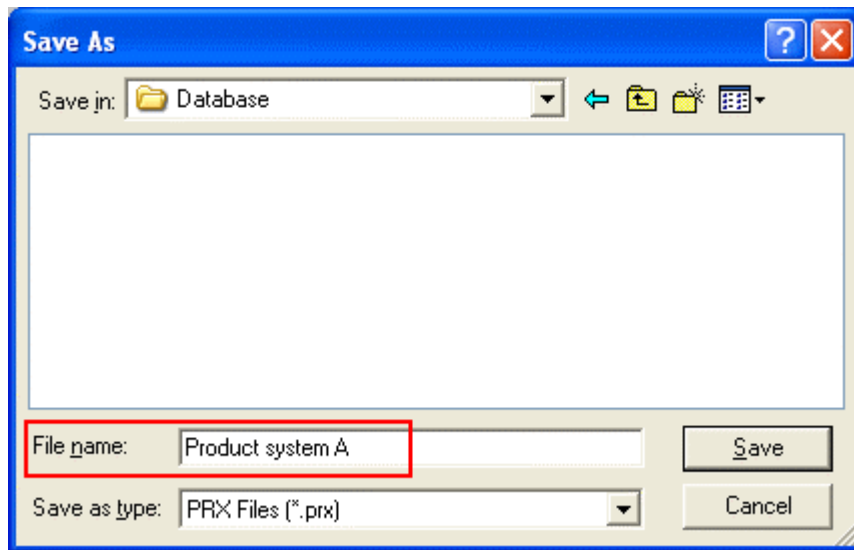

NOTE

When a convert-to file exists, the window that confirms whether or not to overwrite the file is displayed.

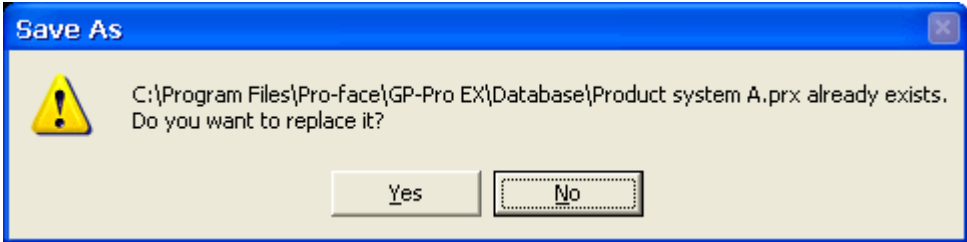

(5) Click [Convert] and start the conversion.

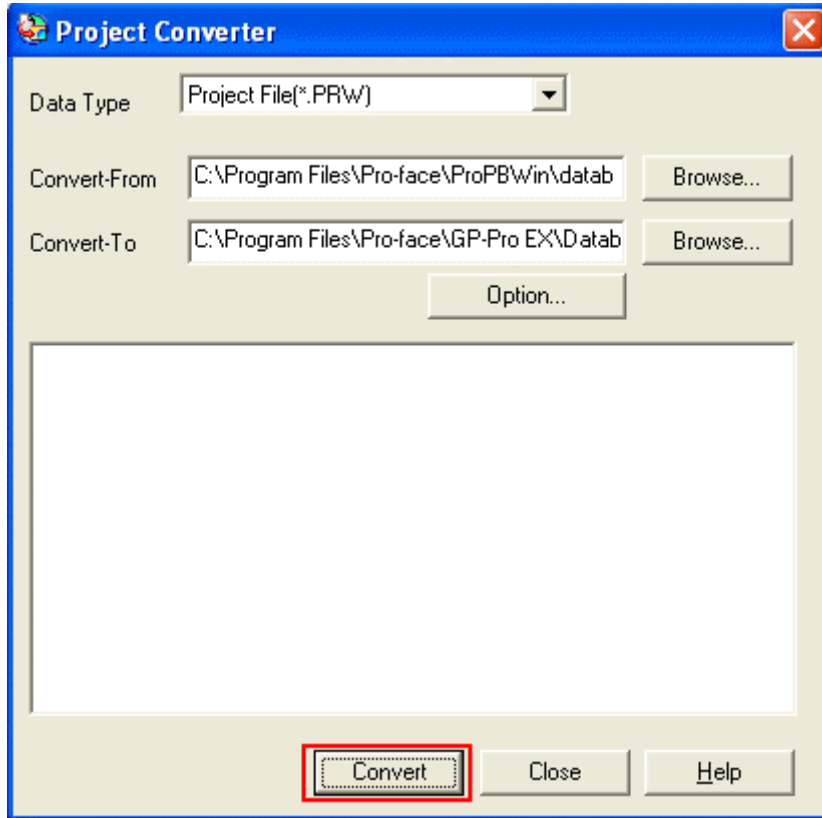

(6) If you are asked about the [Convert-To] type as shown below, select [GP-4501T] on the pull-down menu. Click [OK].

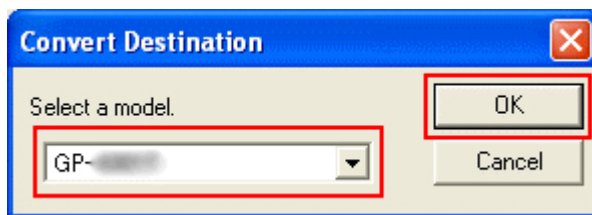

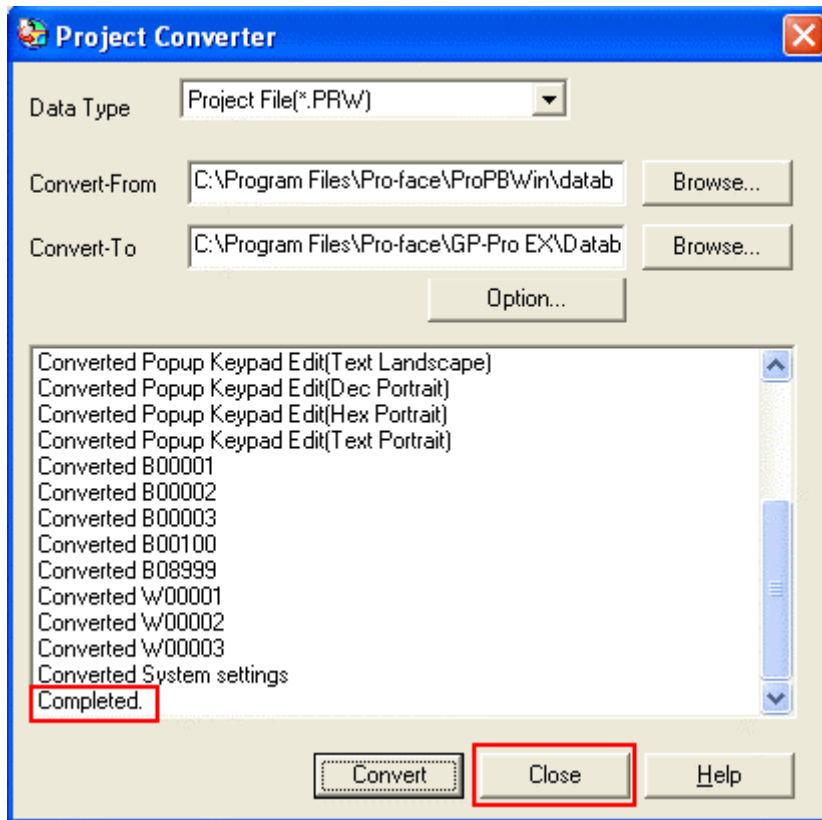

If an error message is displayed during conversion...

If an error message is displayed during conversion, refer to [[Project Converter Error Message](#)] (http://www.pro-face.com/otasuke/qa/gp3000/replace/soft/conv/project_converter_error.html) on our Web site called [OtasukePro!] for the cause and the solution.

NOTE

If the following dialog box appears, CF Card Output Folder setting is required. Please refer to [Convert GP-PRO/PBIII for Windows' "Destination CF Card Folder"](#).

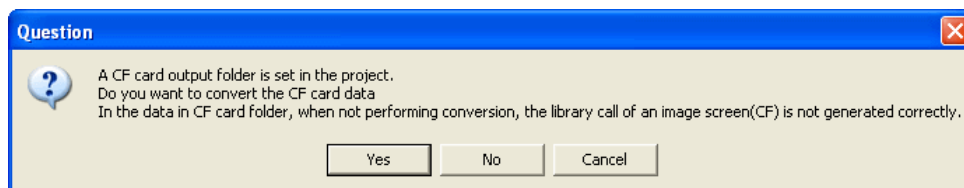

(7) After conversion, the [Save convert information] dialog box appears. If you click [Save], you can save the conversion information in a CSV file format.

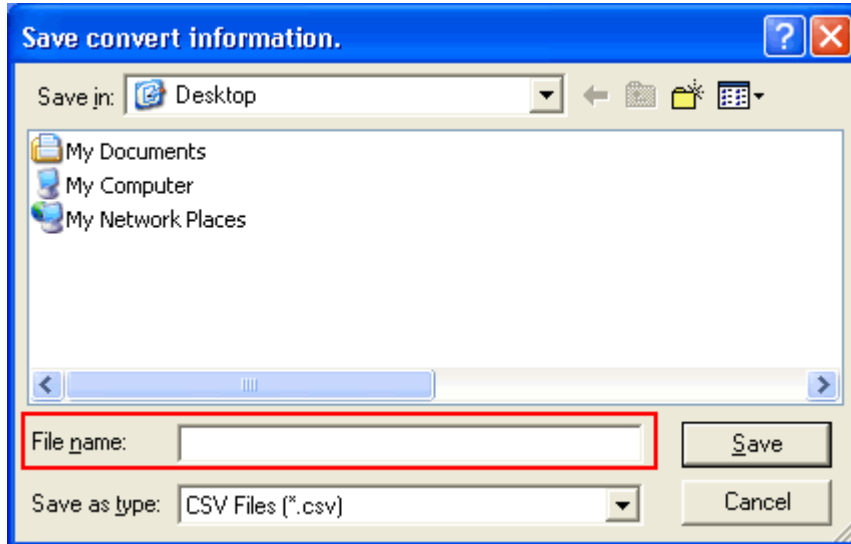

NOTE

Because the differences made at the time of conversion from GP-Pro/PBIII for Windows are described in the saved file, the project file (*.prx) after conversion can be checked and modified according to the conversion information.

(8) Click [Close] to close the [Project Converter] dialog box.

If you double click the project file (*.prx) after conversion, GP-Pro EX will start and the file will open.

Convert GP-PRO/PBIII for Windows “Destination CF Card Folder”

If you convert a project file (*.prw) with a destination CF card folder designated in the step 6, the Question dialog box asking whether or not to designate the destination CF card folder for the convert destination appears again.

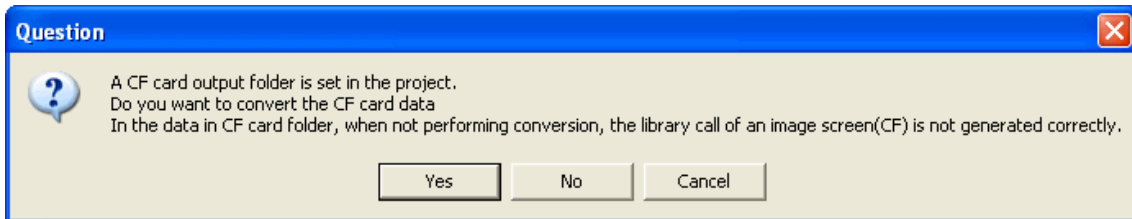

Select a folder (e.g.: “Database”) and click [OK].

If you click the [Make New Folder] button, you can create a new folder at any location.



IMPORTANT

- In the [Question] dialog box, be sure to select [Yes] and specify the destination folder. If you select [No], images will not be called correctly.
- GP-4501T/TW is not equipped with a CF card slot. If you create a destination folder in the step above, the CF card setting will automatically change to the SD card setting.
For checking or changing the destination folder setting, see [[5.1 Changing the setting of the external media to use](#)].

3.5 Change the Display Unit Type (only when replacing with GP-4501TW)

Open the project file (*.prx) on GP-Pro EX that is converted in the Chapter 3.4 and change the display unit type to GP-4501TW.

- (1) Open the converted project file (*.prx) on GP-Pro EX.
- (2) Click GP-Pro EX's [System Settings]->[Display] and there change the Display Unit to GP-4501TW.
- (3) Click [Project]->[Save] or [Save As] to save the change.

3.6 Transfer the screen data to GP-4501T/TW

Transfer the project file after conversion to GP-4501T/TW.

You can transfer data to GP-4501T/TW via;

- A USB transfer cable (model: CA3-USBCB-01)
- A USB data transfer cable (model: ZC9USCBMB1)
- A commercial USB cable (USB Type A/mini B)
- A SD card/A USB storage device
- Ethernet

But, this section explains, as an example, how to transfer screen data with a USB transfer cable (model: CA3-USBCB-01).



(1) Connect your PC and GP-4501T/TW with a USB transfer cable (model: CA3-USBCB-01).

If the driver of the cable has not been installed on you PC yet, a dialog box will appear. Please follow the instructions.

NOTE

- The "Hardware Installation" dialog box as shown below may appear during installing the USB driver depending on the security level of Windows® XP. Click [Continue Anyway] to start installing the driver. When installation is completed, click [Finish].

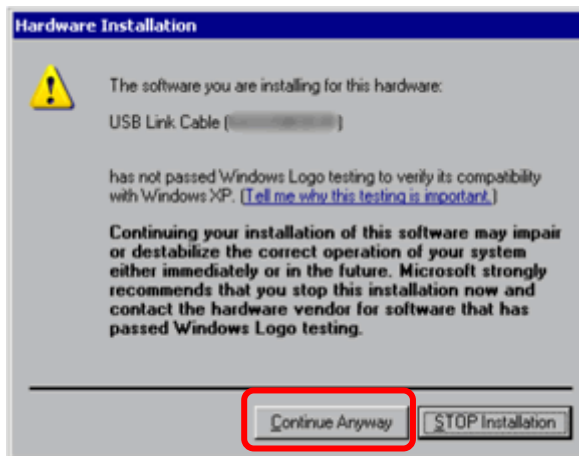

- If the following symptoms appear on Microsoft Windows® 7, go to updating "USB Data Transfer Driver" on [OtasukePro!] for download (http://www.pro-face.com/otasuke/download/update/proex/proex/v260/gpproex_usb_transfer.htm).
 - An error occurs when GP-Pro EX or Transfer Tool is installed
 - An error occurs when data is transferred via a USB transfer cable (model: CA3-USBCB-01).

- (2) Turn on the power of GP-4501T/TW. The "Initial Start Mode" screen will appear on the display unit. After transferring a project file once, this screen will not appear again.



- (3) On the GP-Pro EX's State Toolbar, click the [Transfer Project] icon to open the Transfer Tool.

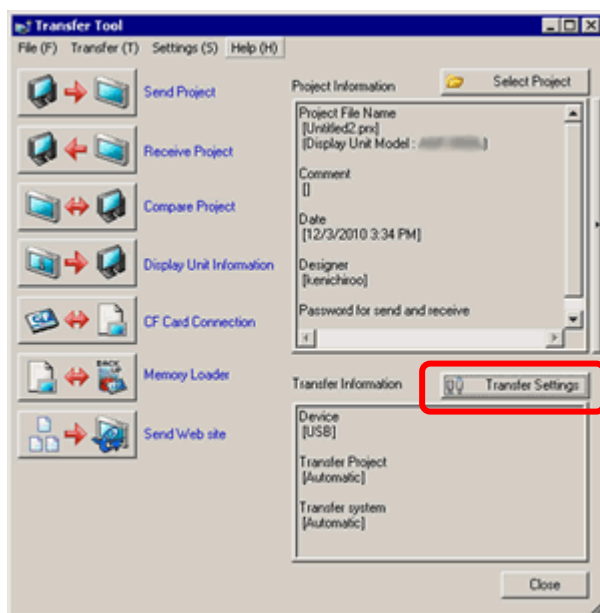

To transfer a different project file, click the [Select Project] button and select a project file.

- (4) Make sure that the [Device] in the "Transfer Settings Information" is set to [USB]. If not, click the [Transfer Setting] button to open the "Transfer Setting" dialog box. Select [USB] in the Communication Port Settings field and click [OK].



- (5) Click [Send Project] to start transfer. When the following dialog box appears, click [Yes]. This dialog box doesn't appear when the same project file is sent again.

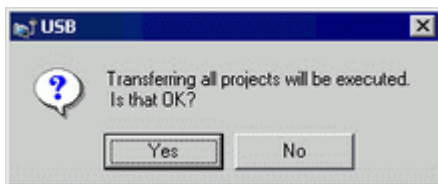

- (6) The following dialog box appears during transfer and you can check the communication status. (The display unit enters the Transferring mode and communication with the device such as a PLC is terminated.)

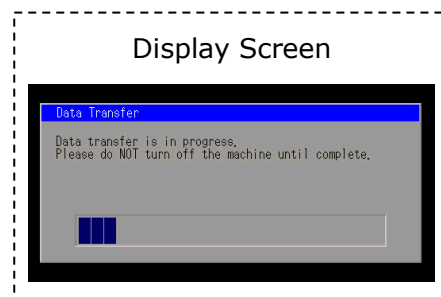
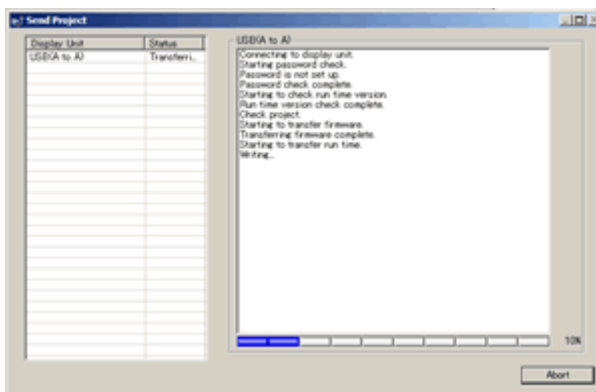

- (7) When transfer is completed, the status displayed in the dialog box will change from [Transferring] to [Complete Transfer]. Click [Close] to close the dialog box.

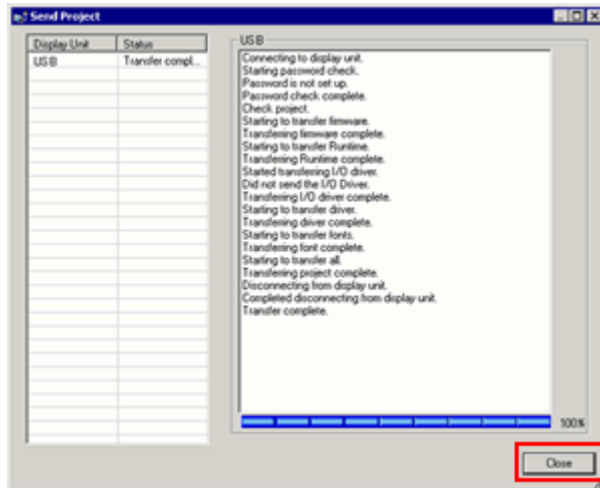

The display unit will be reset and a screen of the transferred project file will be displayed.

- (8) Close the Transfer Tool.
- (9) Click the [X] mark on top right of the screen or [Project]->[Exit] to close GP-Pro EX.

3.7 Differences of software

3.7.1 Differences after conversion

Check the differences of screen data after conversion from GP-PRO/PBIII to GP-Pro EX. For the details of each item, refer to our website.

<http://www.pro-face.com/otasuke/qa/gp3000/replace/soft/conv/care/3/>

Differences of Software

1	Touch Panel Type
2	Compatibility of Bit Switch
3	Compatibility of Alarm
4	Compatibility of Trend Graph
5	Compatibility of K tag (Input Order)
6	Compatibility of K tag (difference of Writing)
7	Compatibility of K tag (Indirect Setting)
8	Compatibility of N tag
9	Precautions for using the switch for [History Data Display] of Trend Graph on the window
10	About window display on a momentary switch during momentary operation
11	About the performance when a display area of the system window is overlapping
12	Change of Tag Process
13	About the display when a fixed Draw is placed on a Part
14	Compatibility of Text
15	Compatibility of Fill
16	Compatibility of CF Card Data
17	Precautions for conversion when filing data is saved in a CF card
18	Precautions for setting "Color Settings" to [256 Colors without blinking]
19	Precautions for loading a part with "L Tag (Library Display)"
20	Compatibility of MRK files and CPW files
21	Compatibility of V Tag/v tag and Video Screen
22	Compatibility of Extended SIO Script
23	Compatibility of Sound Data
24	Compatibility of Device Monitor

25	Compatibility of Ladder Monitor
26	Compatibility of J Tag and R Tag
27	Converting Screen Data of DOS
28	Compatibility of Standard Font
29	D Script starts right after screen change or power on. (Compatibility of D Script Trigger Condition)
30	The position shifts when loading a window screen (Compatibility of U Tag)
31	Precautions for using Screen Level Change
32	Compatibility of H tag

Chapter 4 Communication with Device/PLC

4.1 Driver list

More connectable drivers will be added.

For the devices/PLC each driver supports, see [Connectable Devices]
(<http://www.pro-face.com/product/soft/gpproex/driver/driver.html>).

4.2 Shapes of COM ports

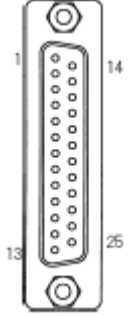
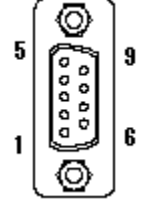
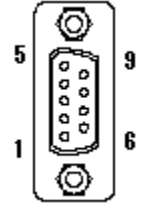
	GP-577RT/S	GP-4501T/TW
COM1	D-Sub 25 pin (socket) RS-232C/422	D-Sub 9 pin (plug) RS-232C
		
COM2	-	D-Sub 9 pin (plug) RS-422/485
	-	

NOTE

For the COM ports of GP-577RT/S and GP-4501T/TW, the pin assignment and the shape of plug/socket connector are different. Because of it, the existing PLC connection cables cannot be used as they are. If you use the existing connection cables, see [[4.5 Cable Diagram at the time of replacemet](#)].

4.3 Signals of COM ports

4.3.1 Signals of COM1

For GP-577RT/S

RS-232C or RS-422 (socket)

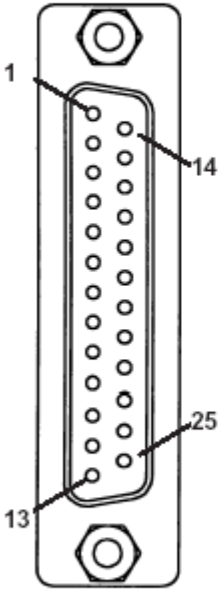
Pin Assignments	Pin #	Signal Name	Condition
(D-Sub 25pin female) SIO 	1	FG	Frame ground
	2	SD	Send data (RS-232C)
	3	RD	Receive data (RS-232C)
	4	RS	Request send (RS-232C)
	5	CS	Clear send (RS-232C)
	6	DR	Data Set Ready (RS-232C)
	7	SG	Signal ground
	8	CD	Carrier detect (RS-232C)
	9	TRMX	Termination (RS-422)
	10	RDA	Receive data A (RS-422)
	11	SDA	Send data A (RS-422)
	12	NC	No connection (Reserved)
	13	NC	No connection (Reserved)
	14	VCC	5V±5% output 0.25A
	15	SDB	Send data B (RS-422)
	16	RDB	Receive data B (RS-422)
	17	RI	Ring Indicate (RS-232C)
	18	CSB	Clear send B (RS-422)
	19	ERB	Enable receive B (RS-422)
	20	ER	Enable receive (RS-232C)
	21	CSA	Clear send A (RS-422)
	22	ERA	Enable receive A (RS-422)
	23	NC	No connection (Reserved)
	24	NC	No connection (Reserved)
	25	NC	No connection (Reserved)

For GP-4501T/TW
RS-232C (plug)

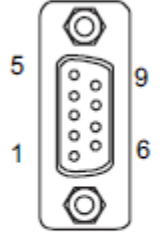
Pin Connection	Pin No.	RS-232C		
		Signal Name	Direction	Meaning
 <p>(GP unit side)</p>	1	CD	Input	Carrier Detect
	2	RD(RXD)	Input	Receive Data
	3	SD(TXD)	Output	Send Data
	4	ER(DTR)	Output	Data Terminal Ready
	5	SG	-	Signal Ground
	6	DR(DSR)	Input	Data Set Ready
	7	RS(RTS)	Output	Request to Send
	8	CS(CTS)	Input	Send possible
	9	CI(RI)/VCC	Input/-	Called Status Display +5V±5% Output 0.25A ^{*1}
	Shell	FG	-	Frame Ground (Common with SG)

*1: RI and VCC of Pin 9 are switched on the software.

VCC Output is not protected from overcurrent.

Please follow the current rating to avoid false operation or breakdown.

4.3.2 Signals of COM2

For GP-577RT/S

None

For GP-4501T/TW

RS-422/485 (plug)

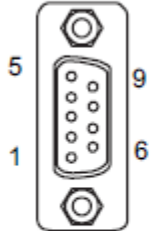
Pin Connection	Pin No.	RS-422/RS-485		
		Signal Name	Direction	Meaning
 <p>(GP unit side)</p>	1	RDA	Input	Receive Data A (+)
	2	RDB	Input	Receive Data B (-)
	3	SDA	Output	Send Data A (+)
	4	ERA	Output	Data Terminal Ready A (+)
	5	SG	-	Signal Ground
	6	CSB	Input	Send Possible B (-)
	7	SDB	Output	Send Data B (-)
	8	CSA	Input	Send Possible A (+)
	9	ERB	Output	Data Terminal Ready B (-)
	Shell	FG	-	Frame Ground (Common with SG)

4.4 Multilink Connection

For GP-4501T/TW, some communication drivers do not support multi-link connection (n:1) via RS-422.

When converting the project file with the setting of the communication driver that does not support multi-link connection (n:1) via RS-422, the connection is automatically converted to (1:1).

For the communication drivers that support serial multi-link, see [[Which drivers support serial multilink communication?](#)]

(http://www.pro-face.com/otasuke/files/manual/gpproex/new/device/com_mlnk.htm).

4.5 Internal 2-Port feature for Mitsubishi PLC

For GP-4501TW, the internal 2-Port feature for Mitsubishi PLC cannot be used.

If [GP Setup]->[Mode Settings]->[Option]->[Internal 2 port] is selected on GP-PRO/PBIII, the following message will appear when converting the project file with the GP-Pro EX Project Converter.



4.6 Cable Diagram at the time of replacement

The connection cable for GP-577RT/S can be used for GP-4501T/TW. But please note that there are precautions and restrictions as described below.

IMPORTANT

- Please check the connection configurations GP-4501T/TW supports with GP-Pro EX Device/PLC Connection Manual before using a connection cable.
(<http://www.pro-face.com/otasuke/files/manual/gpproex/new/device/index.htm>).
- **The Siemens MPI connection cable, MPI adapter (GP070-MPI-41)** cannot be used.
Please refer to the above-mentioned GP-Pro EX Device/PLC Connection Manual and prepare a connection cable for GP-4501T/TW newly.
- When using Mitsubishi PLC A/QnA series (CPU Direct), please refer the following notes,
 - [When using GP430-IP10-O/ GP430-IP11-O,](#)
Refer > 4.6.1 When using a RS-232C connection cable > When using CPU I/F Cable for Mitsubishi PLC...
 - [When using GP2000-CBLA/5M-01 \(* including User-created cable\)](#)
Refer > 4.6.2 When using a RS-422 connection cable > When using Mitsubishi A/QnA series (CPU Direct) connection cable (GP2000-CBLA/5M-01)
 - [When using GP2000-CBLFX/5M-01, GP2000-CBLFX/1M-01\(* including User-created cable\)](#)
Refer > 4.6.2 When using a RS-422 connection cable > When using Mitsubishi FX series (CPU Direct) connection cable (GP2000-CBLFX/5M-01, GP2000-CBLFX/1M-01)

4.6.1 When using a RS-232C connection cable

GP-577RT/S System Configuration (connecting to **COM1**)

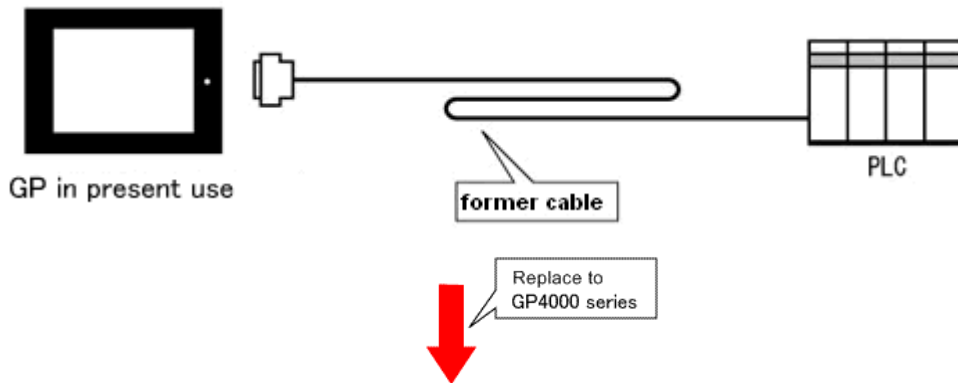

GP-4501T/TW System Configuration (connecting to **COM1**)

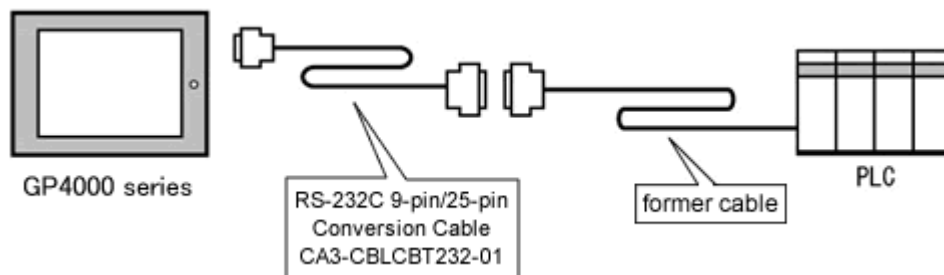

To replace GP-577RT/S with GP-4501T/TW, prepare the following item.

Product Name	Model
RS-232C 9-pin/25-pin Conversion Cable (20cm)	CA3-CBLCBT232-01

When using CPU I/F Cable for Mitsubishi PLC...

When using CPU I/F Cables for Mitsubishi PLC (GP430-IP10-O/ GP430-IP11-O) with GP-2500 series, be sure to select "VCC" in the Device/PLC Setting on GP-Pro EX after converting a project file, or the communication will not work properly.

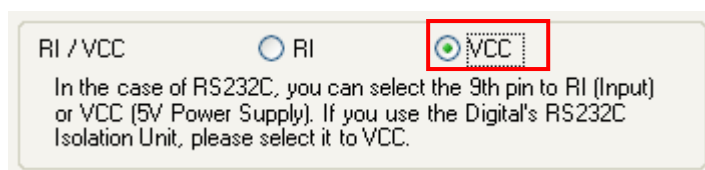

To change this setting, select [System Settings] -> [Device/PLC] in the [Project] menu on GP-Pro EX.

4.6.2 When using a RS-422 connection cable

GP-577RT/S System Configuration (connecting to **COM1**)

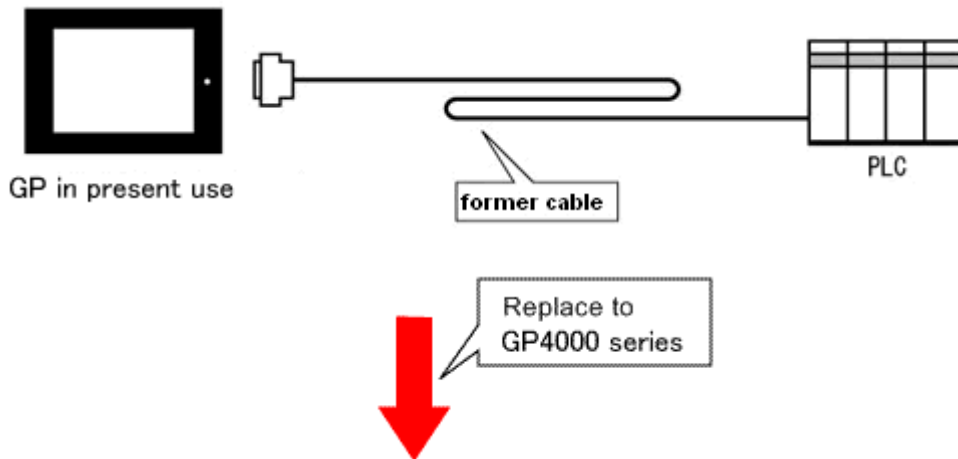

GP-4501T/TW System Configuration (connecting to **COM2**)

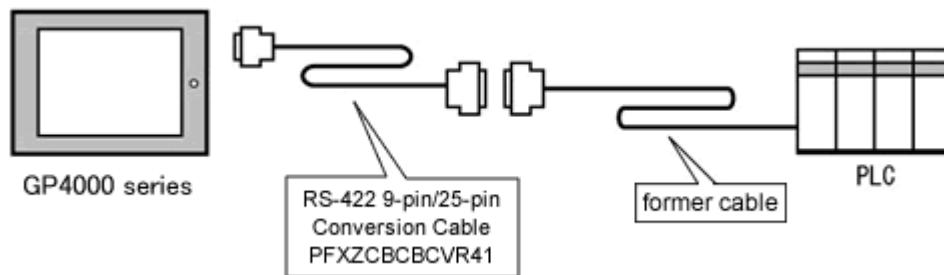

IMPORTANT

Before connecting to GP-4501T/TW, be sure to change the port setting to [**COM2**] on Device/PLC Setting of GP-Pro EX. Please check the communication setting with GP-Pro EX Device/PLC Connection Manual just in case.

(<http://www.pro-face.com/otasuke/files/manual/gpproex/new/device/index.htm>)

To replace GP-577RT/S with GP-4501T/TW, prepare the following item.

Product Name	Model
RS-422 9-pin/25-pin Conversion Cable (20cm)	PFXZCBCBCVR41

NOTE

When using a terminal block adapter (GP070-CN10-O), we recommend you to replace it with a terminal block conversion adapter (PFXZCBADTM1) for GP-4501T/TW.

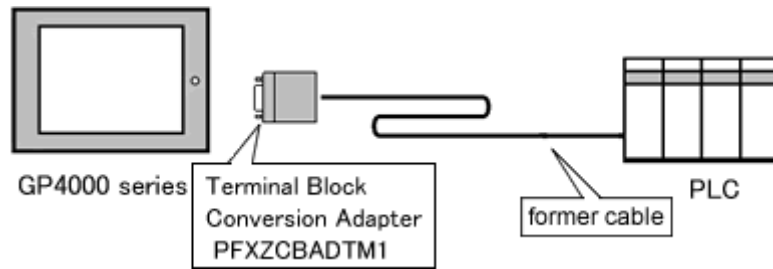

For replacement in this connection method, prepare the following item.

Product Name	Model
Terminal Block Conversion Adapter	PFXZCBADTM1

When using Mitsubishi A/QnA series (CPU Direct) connection cable
(GP2000-CBLA/5M-01) * Including User-created cable

9/25-pin Conversion Cable cannot be used.

**Please replace to Mitsubishi A connection cable by Pro-face
(CA3-CBLA-01).**

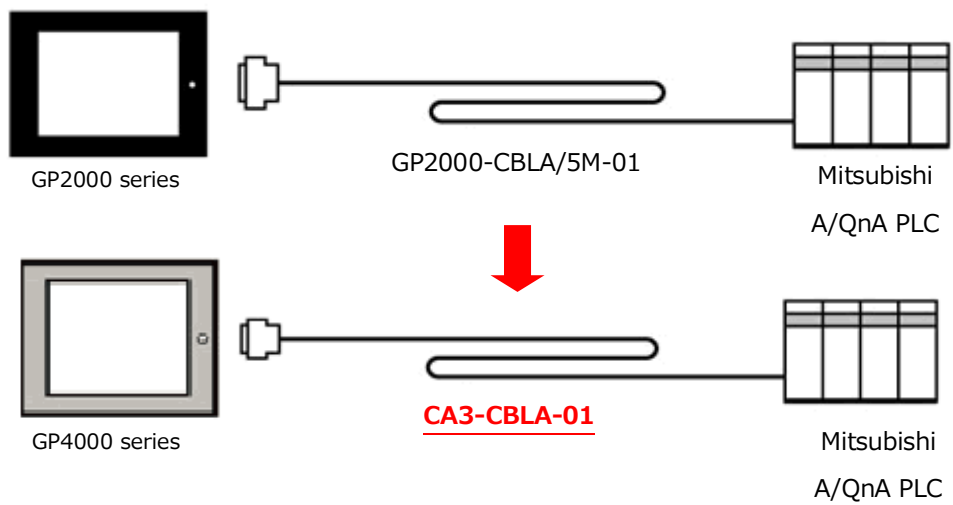

Not available options for 4000 series

RS-422 9/25-pin Conversion Cable (20cm) (PFXZCBCBCVR41)

COM Port Conversion Adapter (CA3-ADPCOM-01)

+ RS-422 9/25-pin Conversion Cable (20cm) (CA3-CBLCBT422-01)

When using Mitsubishi FX series (CPU Direct) connection cable
(GP2000-CBLFX/5M-01, GP2000-CBLFX/1M-01)

* Including User-created cable

9/25-pin Conversion Cable cannot be used.

**Please replace to Mitsubishi FX connection cable by Pro-face
(CA3-CBLFX/5M-01(5m) or CA3-CBLFX/ 1 M-01(1m)) .**

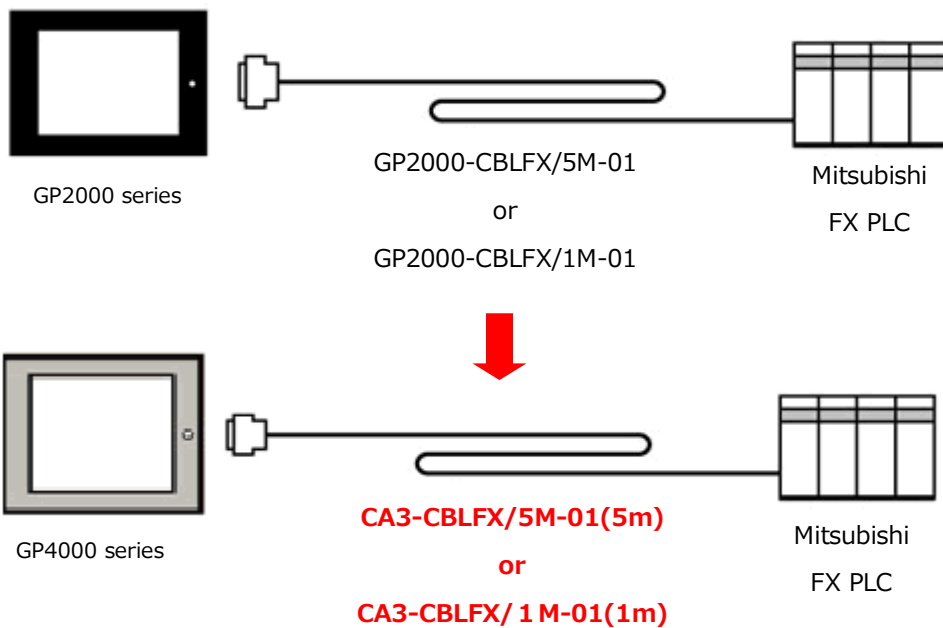

Not available options for 4000 series

RS-422 9/25-pin Conversion Cable (20cm) (PFXZCBCBCVR41)

COM Port Conversion Adapter (CA3-ADPCOM-01)

+ RS-422 9/25-pin Conversion Cable (20cm) (CA3-CBLCBT422-01)

Chapter 5 Appendix

5.1 Changing the setting of the external media to use

If a CF card is used for GP-PRO/PBIII, after GP-577RT/S is replaced with GP-4501T/TW with the Project Converter of GP-Pro EX, "a CF card" is automatically replaced with "a SD card" for the external media setting.

- (1) After conversion of the project file data, at GP-Pro EX Error Check, if the message, "The project contains features that require a SD card. However, the selected display does not support SD cards so these features will not run." appears,

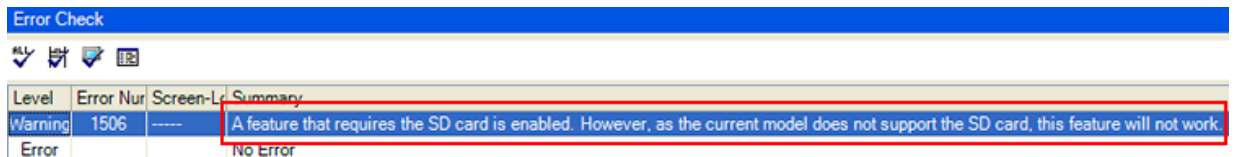

Level	Error Num	Screen-L	Summary
Warning	1506	----	A feature that requires the SD card is enabled. However, as the current model does not support the SD card, this feature will not work.
Error			No Error

<Cause>

The model without a SD card slot has the setting that uses a SD card.

->[Solution 1](#)

- (2) To use a USB flash drive instead of a SD card ->[Solution 1](#)

- (3) To check or change the SD card's data output destination folder setting

->[Solution 2](#)

[Solution]

1. Change the SD Card setting to the USB storage setting following the steps below.

<Procedure>

- i. Click [Project]->[Information]->[Destination Folder].
- ii. Uncheck "Enable SD Card" and check "Enable USB Storage.

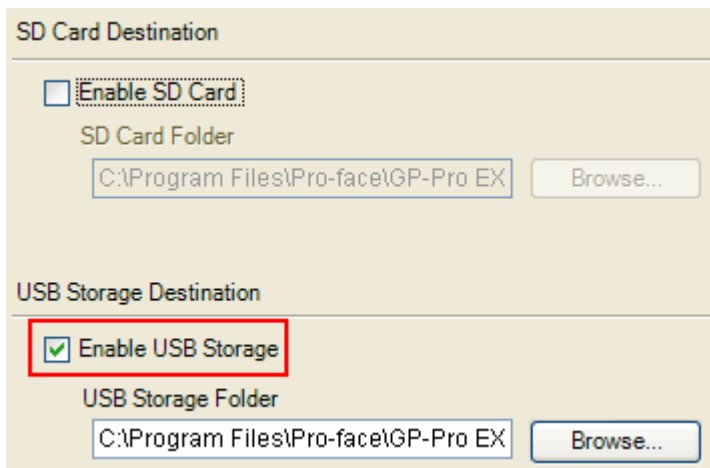

SD Card Destination

Enable SD Card

SD Card Folder

C:\Program Files\Pro-face\GP-Pro EX

USB Storage Destination

Enable USB Storage

USB Storage Folder

C:\Program Files\Pro-face\GP-Pro EX

- iii. Click the [Browse] button and specify a destination folder.

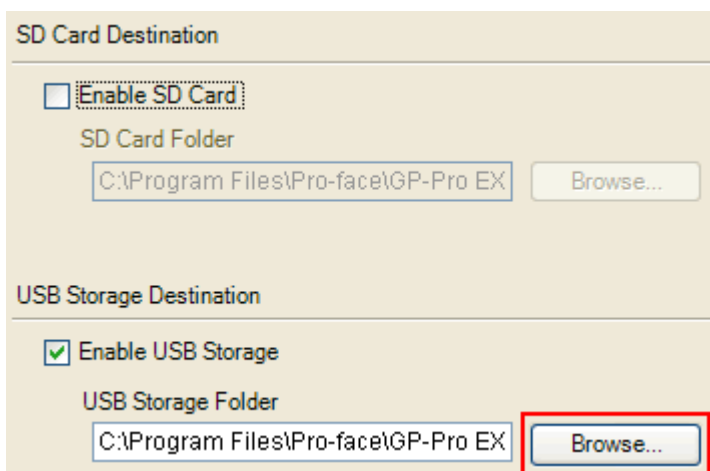

SD Card Destination

Enable SD Card

SD Card Folder

C:\Program Files\Pro-face\GP-Pro EX

USB Storage Destination

Enable USB Storage

USB Storage Folder

C:\Program Files\Pro-face\GP-Pro EX

- iv. Click [OK] to confirm the setting.
- v. Click [Project]->[Save] to save changes.
- vi. Check each function that uses the CF card and replace the setting of [SD Card] with the one of [USB Storage].

NOTE

- To see how the tags or the parts of GP-PRO/PBIII for Windows are replaced on GP-Pro EX, refer to [OtasukePro!] "Feature Comparison between GP-PRO/PBIII and GP-Pro EX"
(<http://www.pro-face.com/otasuke/qa/gp3000/replace/soft/conv/care/3/compare.htm>)
- To check each function setting of GP-Pro EX, refer to GP-Pro EX Reference Manual.

2. Check and change the destination folder setting following the steps below.
 - i. Click [Project]->[Information]->[Destination Folder].
 - ii. The current setting is displayed.

The screenshot shows two sections of a settings dialog box. The top section is titled "SD Card Destination" and contains an unchecked checkbox labeled "Enable SD Card". Below it is the label "SD Card Folder" followed by a text input field containing the path "C:\Program Files\Pro-face\GP-Pro EX" and a "Browse..." button. The bottom section is titled "USB Storage Destination" and contains a checked checkbox labeled "Enable USB Storage". Below it is the label "USB Storage Folder" followed by a text input field containing the path "C:\Program Files\Pro-face\GP-Pro EX" and a "Browse..." button.

- iii. After changing it, click [OK] to confirm the setting.
- iv. Click [Project]->[Save] to save changes.