

Easy! Smooth!

GP-2500 Series->GP4000 Series

Replacement Guidebook

Preface

This guidebook introduces the procedures to replace a unit in GP-2500 series with a GP-4501T/TW unit.

Model in use	Recommended Substitution
GP-2500T/S/L	GP-4501TW
GP-2501T/S/L	
GP-2500T	GP-4501T
GP-2501T	

Safety Information

HAZARD OF OPERATOR INJURY, OR UNINTENDED EQUIPMENT DAMAGE

Before operating any of these products, be sure to read all related manuals thoroughly.

Failure to follow these instructions can result in death, serious injury or unintended equipment damage.

GP4000 Series Model Number

GP4000 series model number partly differs depending on a specification. Before placing an order, please make sure of the model number.

PFXGP4 * 0 * * * * *

A

B

C

D

E

F

A	2	GP-4200 series (3.5")
	3	GP-4300 series (5.7")
	4	GP-4400 series (7.5"/7.0"W)
	5	GP-4500 series (10.4")
	6	GP-4600 series (12.1")
B	01	RS-232C/422/485
	03	RS-485 (isolation)
C	T	TFT color LCD
	W	TFT color LCD (Wide Type)
D	A	Analog Resistive Film Touch Panel
	M	Matrix Resistive Film Touch Panel
E	A	AC Type Power Supply
	D	DC Type Power Supply
F	W	GP-4201TW/4301TW/4401WW/4501TW
	C	Coated model
	WC	Coated model of GP-4301TW

Contents

<u>PREFACE</u>	<u>2</u>
<u>SAFETY INFORMATION</u>	<u>2</u>
<u>HAZARD OF OPERATOR INJURY, OR UNINTENDED EQUIPMENT DAMAGE</u>	<u>2</u>
<u>GP4000 SERIES MODEL NUMBER</u>	<u>3</u>
<u>CONTENTS</u>	<u>4</u>
<u>CHAPTER 1 SPECIFICATION COMPARISON</u>	<u>6</u>
1.1 SPECIFICATIONS OF GP-2500T/S/L AND GP-4501TW	6
1.2 SPECIFICATIONS OF GP-2501T/S/L AND GP-4501TW	8
1.3 SPECIFICATIONS OF GP-2500T AND GP-4501T	10
1.4 SPECIFICATIONS OF GP-2501T AND GP-4501T	12
<u>CHAPTER 2 COMPATIBILITY OF HARDWARE</u>	<u>14</u>
2.1 LOCATIONS OF CONNECTOR	14
2.2 TOUCH PANEL SPECIFICATIONS	17
2.2.1 FOR REPLACEMENT WITH GP-4501T	17
2.2.2 FOR REPLACEMENT WITH GP-4501TW	17
2.3 DISPLAY COLORS (FOR GP-2500L/2501L ONLY)	18
2.4 TRANSFER CABLE	19
2.5 INTERFACE	19
2.5.1 SERIAL INTERFACE	19
2.5.2 AUXILIARY I/O INTERFACE (AUX)	19
2.5.3 SOUND OUTPUT INTERFACE (FOR GP-2500T/S/L ONLY)	19
2.5.4 CF CARD INTERFACE	19
2.6 PERIPHERAL UNITS AND OPTIONS	20
2.6.1 BARCODE READER CONNECTION	20
2.6.2 PRINTER CONNECTION	20
2.6.3 EXPANSION UNIT	20
2.6.4 FRONT MAINTENANCE UNIT	20
2.6.5 ISOLATION UNIT	21
2.7 POWER SUPPLY	21
2.7.1 AC POWER SUPPLY TYPE	21

2.7.2 DC POWER SUPPLY TYPE	21
2.8 BACKUP BATTERY	22
2.9 POWER CONSUMPTION	23
2.10 MATERIALS/COLORS OF THE BODY	23
2.11 BACKUP MEMORY (SRAM)	23
2.12 ABOUT PRO-SERVER	24
2.13 PANEL CUTOUT DIMENSIONS	24
2.14 OTHER NOTES	24

CHAPTER 3 REPLACEMENT PROCEDURE **25**

3.1 WORK FLOW	25
3.2 PREPARATION	26
3.3 RECEIVE SCREEN DATA FROM GP-2500 SERIES	26
3.4 CONVERT SCREEN DATA WITH THE PROJECT CONVERTER	30
3.5 CHANGE THE DISPLAY UNIT TYPE	36
3.6 TRANSFER SCREEN DATA TO GP-4501T/TW	37
3.7 DIFFERENCES OF SOFTWARE	41
3.7.1 DIFFERENCES AFTER CONVERSION	41

CHAPTER 4 COMMUNICATION WITH DEVICE/PLC **43**



4.1 DRIVERS	43
4.2 SHAPES OF COM PORTS	43
4.3 SIGNALS OF COM PORTS	44
4.3.1 SIGNALS OF COM1	44
4.3.2 SIGNALS OF COM2	46
4.4 MULTILINK CONNECTION	47
4.5 INTERNAL 2-PORT FEATURE FOR MITSUBISHI PLC	47
4.6 CABLE DIAGRAM AT THE TIME OF REPLACEMENT	48
4.6.1 WHEN USING A RS-232C CONNECTION CABLE	49
4.6.2 WHEN USING A RS-422 CONNECTION CABLE	51

CHAPTER 5 APPENDIX **55**

5.1 CHANGING THE SETTING OF THE EXTERNAL MEDIA TO USE	55
--	-----------



Chapter 1 Specification Comparison

1.1 Specifications of GP-2500T/S/L and GP-4501TW

		GP-2500T/S/L	GP-4501TW
			
Display Type	GP-2500T	TFT color LCD	TFT color LCD
	GP-2500S	STN color LCD	
	GP-2500L	Monochrome LCD	
Display Colors, Levels	GP-2500T	256 colors (without blink)/ 64 colors (with blink)	UP! 65,536 colors (without blink)/ 16,384 colors (with blink) -> See 2.3
	GP-2500S	64 colors	
	GP-2500L	Monochrome, 2 levels/8 levels	
Display Resolution		VGA (640x480 pixels)	
Panel Cutout Dimensions (mm)		301.5(W)x227.5(H)	
External Dimensions (mm)		317(W)x243(H)x58(D)	315(W)x241(H)x56(D)
Touch Panel Type		Resistive film (Matrix)	NEW! Resistive film (Analog) -> See 2.2
Memory	Application	4MB	UP! 16MB
	SRAM	256KB	UP! 128KB -> See 2.11
Backup Battery		Secondary Battery (Rechargeable Lithium battery)	NEW! Primary Battery (Replaceable Lithium battery) -> See 2.8
Rated Input Voltage	GP-2500T	AC 100 to 240V/ DC 24V	DC 24V
	GP-2500S	DC 24V	
	GP-2500L		
Serial I/F	COM1	D-Sub 25 pin (socket) RS-232C/422	D-Sub 9 pin (plug) RS-232C -> See 2.5.1 and Chapter4
	COM2	D-Sub 9 pin (plug) RS-232C	D-Sub 9 pin (plug) RS-422/485 > See 2.5.1 and Chapter4
Ethernet I/F		10BASE-T	UP! 10BASE-T/100BASE-TX



CF Card I/F		✓	- -> See 2.5.4
SD Card I/F		-	NEW! ✓
USB I/F	Type A	-	NEW! ✓ -> See 2.4
	Type mini B		
Tool Connector I/F		✓	-
Printer I/F		Centronic-compliant (parallel)	- -> See 2.6.2
Auxiliary I/O I/F		✓	- -> See 2.5.2
Sound Output I/F		✓	- -> See 2.5.3
Expansion Unit I/F		✓	- -> See 2.6.3

1.2 Specifications of GP-2501T/S/L and GP-4501TW

		GP-2501T/S/L	GP-4501TW
			
Display Type	GP-2501T	TFT color LCD	TFT color LCD
	GP-2501S	STN color LCD	
	GP-2501L	Monochrome LCD	
Display Colors, Levels	GP-2501T	256 colors (without blink)/ 64 colors (with blink)	UP! 65,536 colors (without blink)/ 16,384 colors (with blink) ->See 2.3
	GP-2501S	64 colors	
	GP-2501L	Monochrome, 8 levels	
Display Resolution		VGA (640x480 pixels)	
Panel Cutout Dimensions (mm)		301.5(W)x227.5(H)	
External Dimensions (mm)		317(W)x243(H)x58(D)	315(W)x241(H)x56(D)
Touch Panel Type		Resistive film (Matrix)	NEW! Resistive film (Analog) ->See 2.2
Memory	Application	2MB	UP! 16MB
	SRAM	128KB	
Backup Battery		Secondary Battery (Rechargeable Lithium battery)	NEW! Primary Battery (Replaceable Lithium battery) ->See 2.8
Rated Input Voltage	GP-2501T	AC 100 to 240V/ DC 24V	DC 24V ->See 2.7
	GP-2501S		
	GP-2501L	DC 24V	
Serial I/F	COM1	D-Sub 25 pin (socket) RS-232C/422	D-Sub 9 pin (plug) RS-232C ->See 2.5.1 and Chapter4
	COM2	-	D-Sub 9 pin (plug) RS-422/485 ->See 2.5.1 and Chapter4



Ethernet I/F		-	NEW! 10BASE-T/100BASE-TX
CF Card I/F		✓	- -> See 2.5.4
SD Card I/F		-	NEW! ✓
USB I/F	Type A	-	NEW! ✓
	Type mini B	-	-> See 2.4
Tool Connector I/F		✓	-
Printer I/F		Centronic-compliant (parallel)	- -> See 2.6.2
Auxiliary I/O I/F		✓	- -> See 2.5.2
Expansion Unit I/F		✓	- -> See 2.6.3

1.3 Specifications of GP-2500T and GP-4501T

		GP-2500T	GP-4501T
			
Display Type		TFT color LCD	
Display Colors, Levels		256 colors (without blink)/ 64 colors (with blink)	UP! 65,536 colors (without blink)/ 16,384 colors (with blink) ->See 2.3
Display Resolution		VGA (640x480 pixels)	
Panel Cutout Dimensions (mm)		301.5(W)x227.5(H)	259(W)x201(H) ->See 2.13
External Dimensions (mm)		317(W)x243(H)x58(D)	272.5(W)x214.5(H)x57(D)
Touch Panel Type		Resistive film (Matrix)	NEW! Resistive film (Analog) or Resistive film (Matrix) ->See 2.2
Memory	Application	4MB	UP! 32MB
	SRAM	256KB	UP! 320KB ->See 2.11
Backup Battery		Secondary Battery (Rechargeable Lithium battery)	NEW! Primary Battery (Replaceable Lithium battery) ->See 2.8
Rated Input Voltage		AC 100 to 240V/ DC 24V	DC 24V
Serial I/F	COM1	D-Sub 25 pin (socket) RS-232C/422	D-Sub 9 pin (plug) RS-232C ->See 2.5.1 and Chapter4
	COM2	D-Sub 9 pin (plug) RS-232C	D-Sub 9 pin (plug) RS-422/485 >See 2.5.1 and Chapter4
Ethernet I/F		10BASE-T	UP! 10BASE-T/100BASE-TX
CF Card I/F		✓	- ->See 2.5.4
SD Card I/F		-	NEW! ✓
USB I/F	Type A	-	NEW! ✓
	Type mini B	-	->See 2.4

Tool Connector I/F	✓	-
Printer I/F	Centronic-compliant (parallel)	- -> See 2.6.2
Auxiliary I/O I/F	✓	- -> See 2.5.2
Sound Output I/F	✓	- -> See 2.5.3
Expansion Unit I/F	✓	- -> See 2.6.3

1.4 Specifications of GP-2501T and GP-4501T

		GP-2501T	GP-4501T
			
Display Type		TFT color LCD	
Display Colors, Levels		256 colors (without blink)/ 64 colors (with blink)	UP! 65,536 colors (without blink)/ 16,384 colors (with blink) ->See 2.3
Display Resolution		VGA (640x480 pixels)	
Panel Cutout Dimensions (mm)		301.5(W)x227.5(H)	259(W)x201(H) ->See 2.13
External Dimensions (mm)		317(W)x243(H)x58(D)	272.5(W)x214.5(H)x57(D)
Touch Panel Type		Resistive film (Matrix)	NEW! Resistive film (Analog) or Resistive film (Matrix) ->See 2.2
Memory	Application	2MB	UP! 32MB
	SRAM	128KB	UP! 320KB ->See 2.11
Backup Battery		Secondary Battery (Rechargeable Lithium battery)	NEW! Primary Battery (Replaceable Lithium battery) ->See 2.8
Rated Input Voltage		AC 100 to 240V/ DC 24V	DC 24V
Serial I/F	COM1	D-Sub 25 pin (socket) RS-232C/422	D-Sub 9 pin (plug) RS-232C ->See 2.5.1 and Chapter4
	COM2	-	D-Sub 9 pin (plug) RS-422/485 >See 2.5.1 and Chapter4
Ethernet I/F		-	UP! 10BASE-T/100BASE-TX
CF Card I/F		✓	- ->See 2.5.4
SD Card I/F		-	NEW! ✓
USB I/F	Type A	-	NEW! ✓
	Type mini B	-	->See 2.4

Tool Connector I/F	✓	-
Printer I/F	Centronic-compliant (parallel)	- -> See 2.6.2
Auxiliary I/O I/F	✓	- -> See 2.5.2
Expansion Unit I/F	✓	- -> See 2.6.3

Chapter 2 Compatibility of Hardware

2.1 Locations of connector

Connector locations on GP-2500 series and GP-4501T/TW are as follows:

GP-2500T/S/L

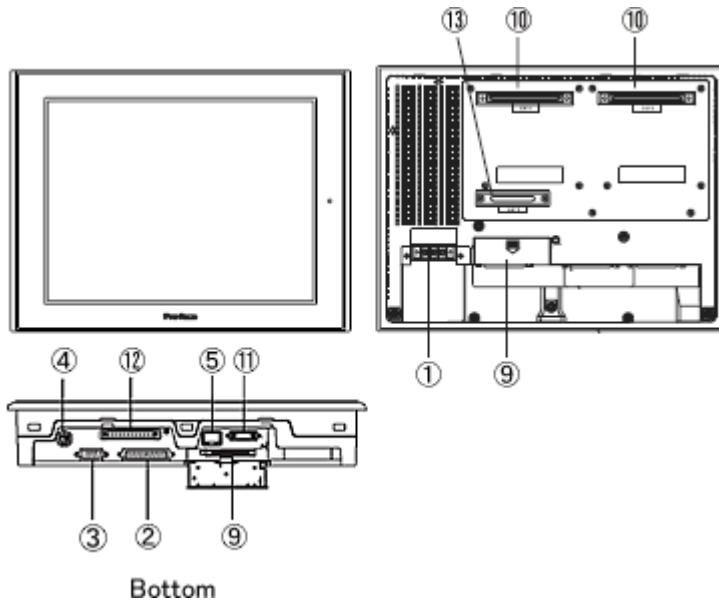

GP-2501T/S/L

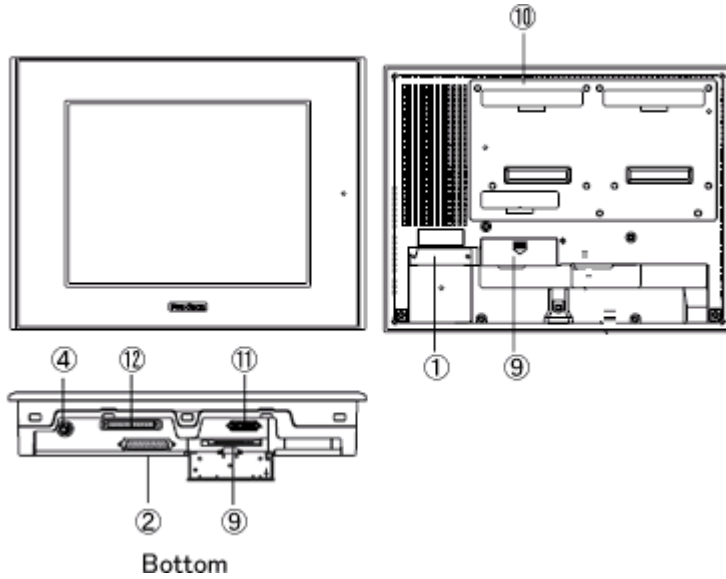

GP-4501T

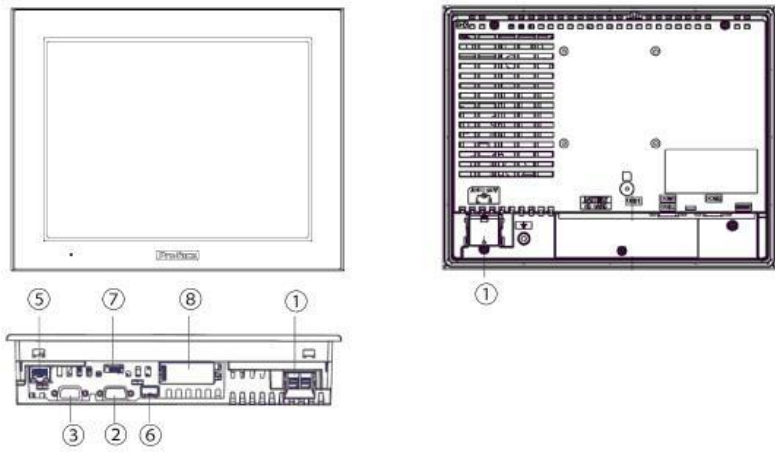

GP-4501TW

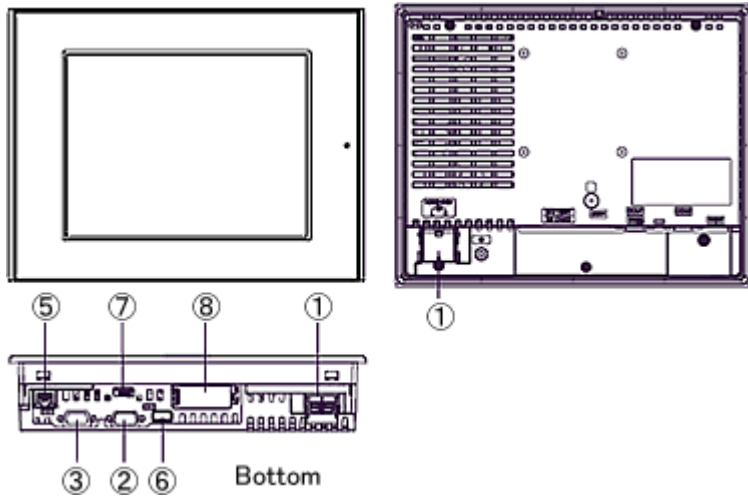

Interface names

	GP-2500T/S/L	GP-2501T/S/L	GP-4501T	GP-4501TW
1	Power Input Terminal Block (AC/DC type)		Power Connector	Power Connector (DC type)
2	Serial I/F (COM1)			
3	Serial I/F (COM2)	-	Serial I/F (COM2)	
4	Tool Connector		-	
5	Ethernet I/F	-	Ethernet I/F	
6	-		USB I/F (Type A)	
7	-		USB I/F (Type mini B)	
8	-		SD Card I/F	
9	CF Card I/F		-	
10	Expansion Unit I/F		-	
11	Printer I/F		-	
12	Auxiliary I/O I/F (AUX), Sound Output I/F	Auxiliary I/O I/F (AUX)	-	
13	Expansion CF Card I/F	-		

2.2 Touch Panel specifications

2.2.1 For replacement with GP-4501T

For replacement with GP-4501T, the Matrix resistive film type which enables simultaneous 2-point touch input or the Analog resistive film type with 1-point touch input only can be selected.

When you use 2-point touch input (touching 2 points on the screen at the same time), please select the Matrix resistive film type.

	AC power supply type	DC power supply type
Analog type	PFXGP4501TAA	PFXGP4501TAD
Matrix type	PFXGP4501TMA	PFXGP4501TMD

2.2.2 For replacement with GP-4501TW

GP-4501TW adopts the Analog type.

For the Analog type, even if you touch two points at the same time, it's recognized that the coordinates located between these two points are touched.

If you have used the 2-point touch input on GP-2500 series, change to the 1-point touch input setting using the switch delay function of GP-Pro EX.

If you use the Matrix type that enables 2-point touch input at the same time, you can replace GP-2500 series with GP-4501T.

There's a model number difference between the Analog type and the Matrix type. Before placing an order, please make sure of the model number.

For AC power supply	PFXGP4501TMA
For DC power supply	PFXGP4501TMD

2.3 Display Colors (for GP-2500L/2501L only)

The display color of GP-2500L/2501L is monochrome, but GP-4501T/TW has a TFT color LCD. After replacement, the display color changes from monochrome to color.

When data of a monochrome model is converted to data of a color model with GP-Pro EX, the data may be displayed in colors depending on the version of the Project Converter or settings of the drawing/the parts on the screen.

After conversion, please confirm the display colors of the drawing or the parts on the screens just in case.

If the display is in colors after the data conversion to GP-4501T/TW...

GP-Pro EX Ver. 3.01.200 (Service Pack1) or later supports the function which changes drawing in colors to in monochrome. To change the setting, follow the steps below.

- (1) Click [Project]->[System Settings]->[Display Unit].
- (2) Open the [Display Settings] tab.
- (3) Change [Color] setting to "16 Levels Monochrome, 3-Speed Blink".

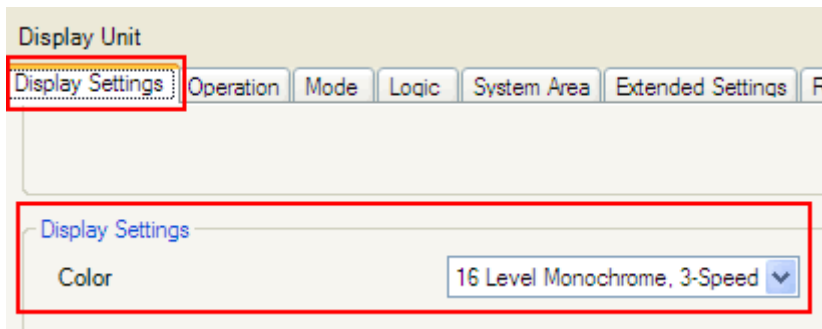



* [Reverse Display] setting is for displaying the screen with black/white reversed. Check on it if needed.



* Please confirm the display colors of the drawing or the parts on the screens after changing the [Color] setting to "16 Levels Monochrome, 3-Speed Blink".

2.4 Transfer cable

To transfer screen data to GP-4501T/TW, use a USB transfer cable or Ethernet.
The USB cables that can be used for GP-4501T/TW are as follows:

	Model	Connector Type	Connector on GP
Options	CA3-USBCB-01		USB (Type A)
	ZC9USCBMB1		USB (Type mini B)
Commercial Item	-		

Please note that the cables (GPW-CB02, GPW-CB03, GP430-CU02-M) for GP-2500 series cannot be used for GP-4501T/TW.

2.5 Interface

2.5.1 Serial Interface

The pin assignment and the shape of plug/socket connector of GP-2500 series are different from those of GP-4501T/TW.

To know the details about them, see [[4.2 Shapes of COM ports](#)] and [[4.3 Signals of COM ports](#)].

Because of it, the existing PLC connection cables cannot be used as they are. If you use the existing connection cables for GP-4501T/TW, see [[4.6 Cable Diagram at the time of replacement](#)].

And even though the both COM1 and COM2 ports on GP-2500T/S/L are used with RS-232C setting, only the COM1 port can be used for GP-4501T/TW. In this case, please contact our sales office in your region.

(<http://www.pro-face.com/customer/contact.html>)

2.5.2 Auxiliary I/O Interface (AUX)

GP-4501T/TW is not equipped with Auxiliary I/O Feature. External Reset Input and 3 Outputs (RUN Output, System Alarm Output, and External Buzzer Output) that can be used for GP-2500 series cannot be used.

2.5.3 Sound Output Interface (for GP-2500T/S/L only)

GP-4501T/TW is not equipped with the sound output function. The sound output function for GP-2500T/S/L cannot be used.

2.5.4 CF Card Interface

GP-4501T/TW is not equipped with a CF card slot. But a SD card slot and a USB interface are installed. In order to use the GP-2500 series data saved in the CF card

and the functions using the CF card, use a SD card or a USB flash drive instead.

* When using a SD card with GP-4501T/TW, please verify it supports the following specifications:

	File format	Maximum capacity
SD	FAT16	2GB
SDHC	FAT32	32GB

For the GP-PRO/PBIII's "CF Card output folder" setting, if project file is converted on GP-Pro EX, the setting will automatically change to the one that uses a SD card.

To change the setting of the output destination folder, see [[5.1 Changing the setting of the external media to use](#)].

2.6 Peripheral units and options

2.6.1 Barcode reader connection

GP-4501T/TW is not equipped with a tool port. A barcode reader that used to be connected to the tool port on GP-2500 series cannot be used. However, GP-4501T/TW allows you to connect a barcode reader on its USB interface (Type A) or its serial interface.

For the models GP-4501T/TW supports, see [OtasukePro!]

(http://www.pro-face.com/otasuke/qa/3000/0056_connect_e.html).

2.6.2 Printer Connection

GP-4501T/TW is not equipped with Centronics (parallel) Interface for a printer though GP-2500 series is equipped with it. If the printer for GP-2500 series is used for GP-4501T/TW, a converter that converts USB interface on GP-4501T/TW to Centronics interface is required. And GP-4501T/TW allows you to connect a printer on its USB port.

For the models GP-4501T/TW supports, see [OtasukePro!]

(http://www.pro-face.com/otasuke/qa/3000/0056_connect_e.html).

2.6.3 Expansion Unit

GP-4501T/TW is not equipped with an expansion unit interface. The expansion unit (each kind of unit like CC-LINK Unit) for GP-2500 series cannot be used.

2.6.4 Front Maintenance Unit

The front maintenance unit for GP-2500 series (GP077-CFFM10) cannot be used for GP-4501T/TW.

2.6.5 Isolation Unit

The isolation unit for GP-2500 series (CA2-ISOALL232-01, CA2-ISOALL422-01) cannot be used for GP-4501T/TW. You can use RS-232C isolation unit for GP-4501T/TW (CA3-ISO232-01) instead. In this case, select "VCC" from [System Settings] -> [Device/PLC] in the [Project] menu on GP-Pro EX.

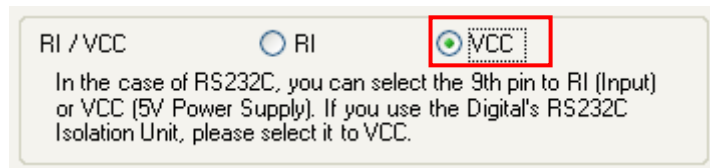

2.7 Power Supply

2.7.1 AC Power Supply Type

GP-4501TW has a DC power supply type only. When replacing GP-2500T or GP-2501T/S (AC Type) with GP-4501TW, changing to DC power supply is required. If you use the AC power supply, you can replace GP-2500 series with GP-4501T. There's a model number difference between the DC power supply type and the AC power supply type. Before placing an order, please make sure of the model number.

For Resistive film (Analog)	PFXGP4501TAA
For Resistive film (Matrix)	PFXGP4501TMA

2.7.2 DC Power Supply Type

The power connector on GP-4501T/TW is a spring lock type. If you replace GP-2500 series with GP-4501T/TW, change the power cable.

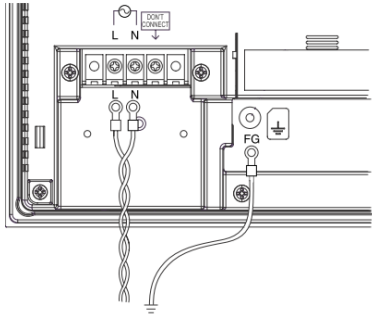
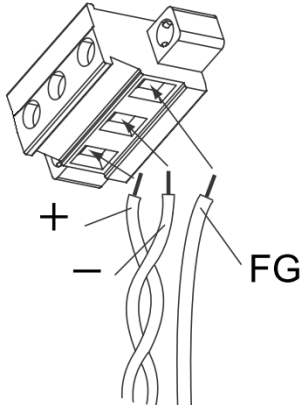
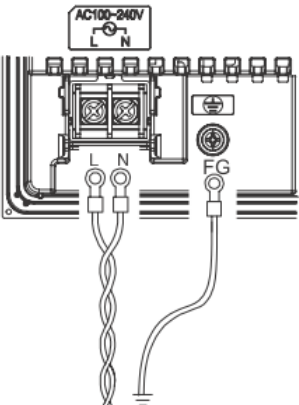
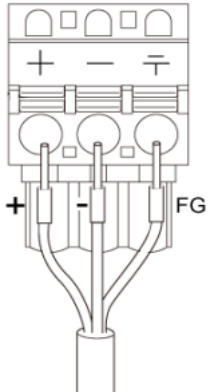
	AC Type	DC Type	
GP3000 Series			CA5-DCCNL-01 made by Pro-face Or GMVSTBW2,5/3-S TF-7,62 made by PHOENIX CONTACT
GP4000 Series			PFXZCBCNDC2 made by Pro-face
Compatibility	Compatible because of a terminal block. FG has been relocated.	Not compatible because of different pitch though the connectors have the same shape. Use the specified type of connector.	

2.8 Backup Battery

Unlike GP-2500 series, GP-4501T/TW does not use rechargeable secondary batteries but replaceable primary ones. (For both a rechargeable type and a replaceable one, contents to be backed up are the same.)

When the time for replacement of backup batteries approaches, the message to urge you to replace the battery, "RAAA053: Running out of power in the backup battery. Please change the battery." appears. When the message appears, replace the battery referring to the GP4000 series hardware manual.

Replaceable Battery Model
PFXZCBBT1

2.9 Power Consumption

The power consumption of GP-2500 series is different from that of GP-4501T/TW.

	AC Type	DC Type
GP-2500T	50VA or less (AC100V) 85VA or less (AC240V)	50W or less
GP-2500S/L	-	
GP-2501T/S	50VA or less (AC100V) 85VA or less (AC240V)	
GP-2501L	-	
GP-4501T	44VA or less (AC100V) 58VA or less (AC240V)	17W or less
GP-4501TW	-	

For the detailed electric specifications, see the hardware manual.

2.10 Materials/Colors of the body

The materials and the colors of GP-2500 series and GP-4501T/TW are as follows:

	Color	Material
GP-2500T/S/L	Dark Gray	Resin
GP-2501T/S/L		
GP-4501T/TW	Light Gray	Resin with glass

2.11 Backup Memory (SRAM)

When replacing GP-2500T/S/L with GP-4501TW, SRAM size becomes smaller (256KB -> 128KB). In case that SRAM size of your project file is more than 128KB after converting GP-2500T/S/L project file (*.prw) with GP-Pro EX Project Converter, replace GP-2500T/S/L with GP-4501T instead of GP-4501TW.

To check SRAM size, follow the steps below;

- (1) Convert GP-2500T/S/L project file (*.prw) to GP-Pro EX's project file (*.prx).
To know how to convert a project file (*.prw), see [[3.4 Convert screen data with the Project Converter](#)].
- (2) Double click and open the converted project file (*.prx) on GP-Pro EX.
- (3) Click [Project]->[Information]->[Project Information]. The Project Information window appears.
- (4) Click [SRAM Information] to see SRAM size.

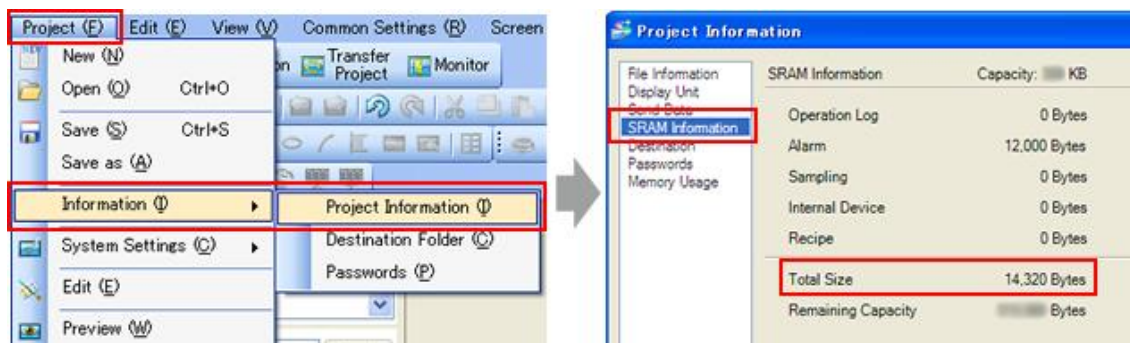

2.12 About Pro-Server

If the Pro-Server with Pro-Studio is used, please use the Pro-Server EX Ver.1.30 or later.

For details of the installation, refer to the

http://www.pro-face.com/otasuke/qa/server_ex/replace/.

2.13 Panel Cutout Dimensions

For replacing ST-2500T/ST-2501T with GP-4501T, the panel cutout dimensions get larger. It's necessary to process the panel.

In other cases, there's no change in the panel cutout dimensions.

2.14 Other Notes

- Do not expose GP4000 series to direct sunlight.
- Do not use GP4000 series outdoors.
- Do not turn on GP4000 series if condensation has occurred inside the device.
- When you are continuously using GP4000 series without oxygen, the brightness might decrease. Please ventilate the control panel periodically.

Chapter 3 Replacement Procedure

3.1 Work Flow

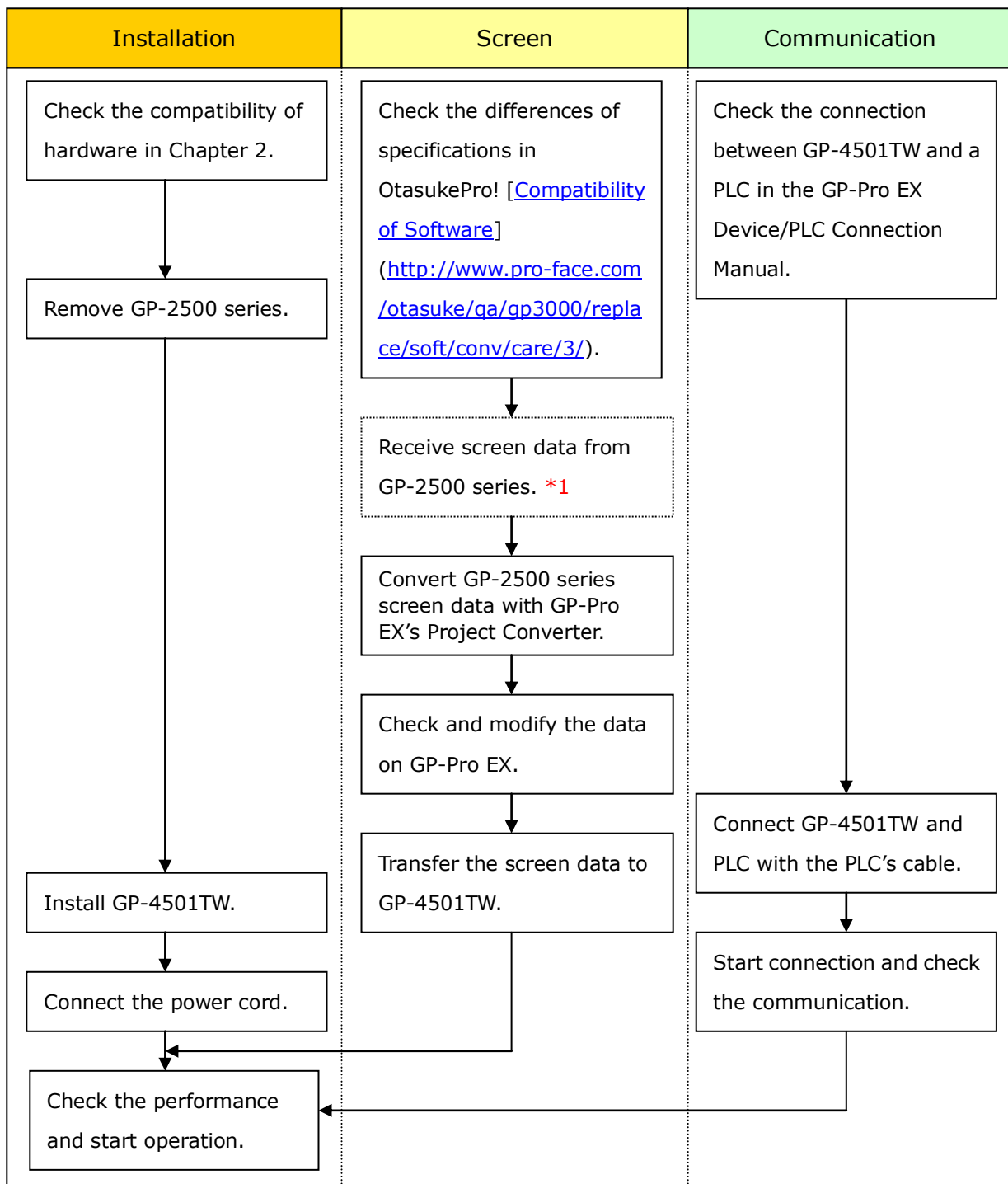

*1: This step is required if screen data is saved only in the GP unit, not in any other device.

3.2 Preparation

Requirements for receiving screen data from GP-2500 series. *1	<p>GP-2500T: PC in which GP-PRO/PBIII for Windows V5.0 or later is installed. *2</p> <p>GP-2500S/L, GP-2501T/S: PC in which GP-PRO/PBIII for Windows C-Package02 V6.0 or later is installed. *2</p> <p>GP-2501L: PC in which GP-PRO/PBIII for Windows C-Package02 V6.3 or later is installed. *2</p>
	<p>Transfer Cable (The following three types of cables are available.)</p> <ul style="list-style-type: none"> • GPW-CB02 (D-sub 9 pin to PC) • GPW-CB03 (USB to PC) *3 • GP430-CU02-M or GPW-SET (D-sub 25 pin to PC) <p>*For GP-2500 series, it's possible to send/receive a screen via Ethernet (GP-2500T/S/L only) or with a CF card.</p>
Requirements for converting screen data of GP-2500 series and transferring the converted data to GP-4501T/TW	<p>PC in which GP-Pro EX Ver.3.01 or later is installed.</p>
	<p>Transfer Cable (The following three types of cables are available.)</p> <ul style="list-style-type: none"> • A USB transfer cable (model: CA3-USBCB-01) • A USB data-transfer cable (model: ZC9USCBMB1) • A commercial USB cable (USB Type A/mini B) <p>* Possible to send/receive a screen with a SD card, a USB storage device, or via Ethernet.</p>

***1:** This step is required if screen data is saved only in the GP unit, not in any other device.

***2:** Please use the same version or later as or than that of the software used during creating screens on GP-2500 series. If you don't know the version, we recommend you to use the newest version. The newest version is GP-PRO/PBIII for Windows C-Package03 (SP2) V7.29. Those who have GP-PRO/PBIII for Windows C-Package03 V7.0 can download it from our web site called [OtasukePro!] (<http://www.pro-face.com/otasuke/download/update/>).

***3:** GPW-CB03 is supported by GP-PRO/PBIII for Windows C-Package02 (SP2) V6.23 or later. You need to install a driver from [Download] on our Web site called [OtasukePro!] (<http://www.pro-face.com/otasuke/download/driver/>).

3.3 Receive screen data from GP-2500 series

This section explains, as an example, how to receive screen data from GP-2500 series using a transfer cable, GPW-CB02 or GPW-CB03. If you have backed up screen data, this step is unnecessary; skip to the next section [[3.4 Convert screen data with the Project Converter](#)].

(1) Connect a transfer cable to the GP-2500 series.

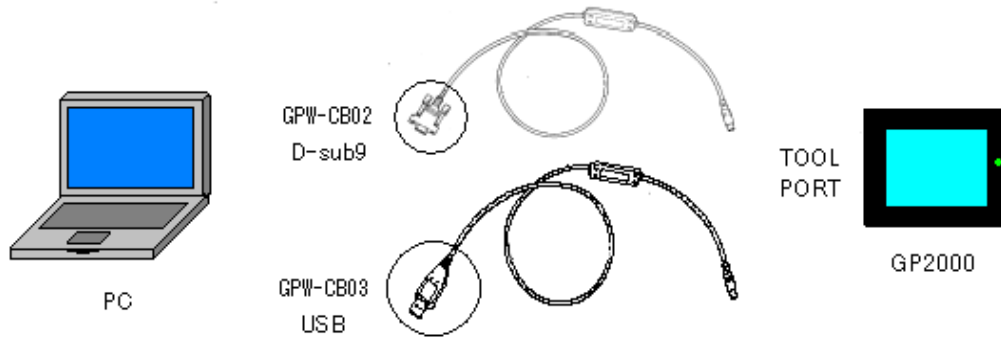

(2) Start up GP-PRO/PBIII for Windows and click the [Transfer] icon on the Project Manager (Specify a desired project file.)



(3) On the [Transfer] window, select the [Setup] menu and click [Transfer Settings...]

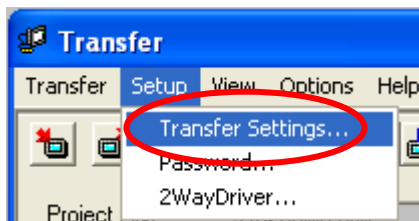

- (4) In the Communication Port field, select [COM], specify the COM port to which the cable is connected, and click [OK].

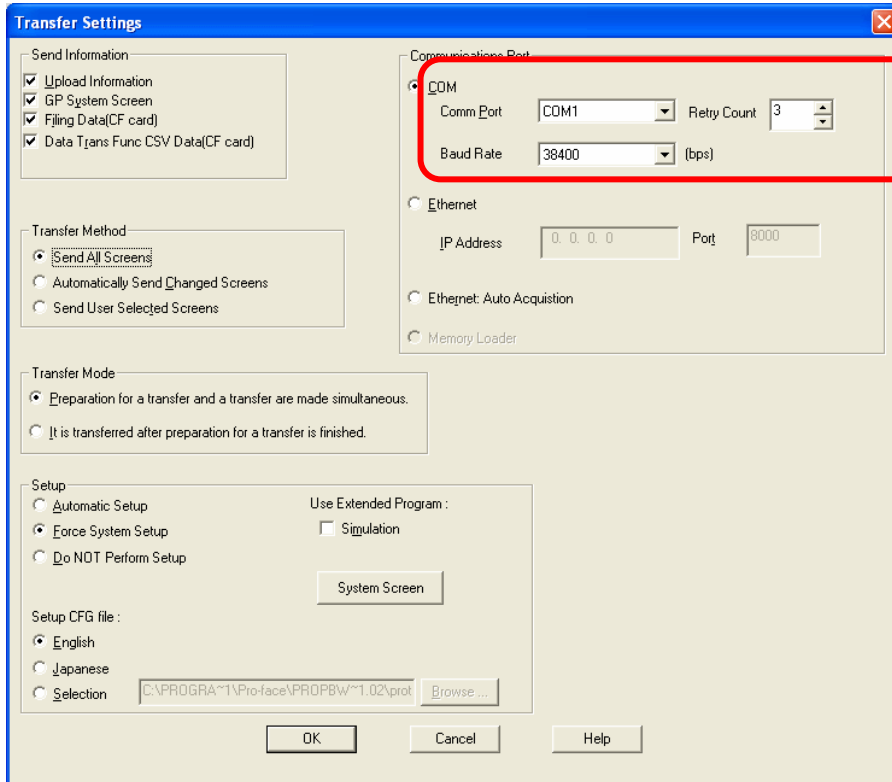

If you use a USB transfer cable (GPW-CB03)

You can check the COM port for the USB transfer cable (GPW-CB03), which is assigned to the PC, with the Device Manager of Windows.

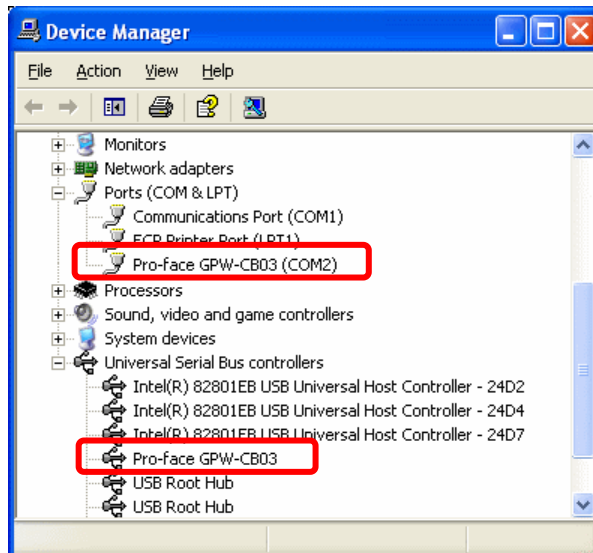

(5) Select the [Transfer] menu and click [Receive...].

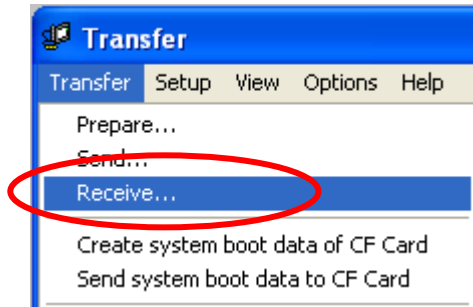

(6) Specify the location to save the received screen data at and the project file name and save them.

In case there is no Upload Information

"Upload Information" is necessary to receive screen data from GP-2500 series. It needs to be included in screen data when transferring screen data to the display unit beforehand. The Upload Information is sent to the display unit by default, however, you may check off the box of Upload Information to prevent screen reception by a third party.

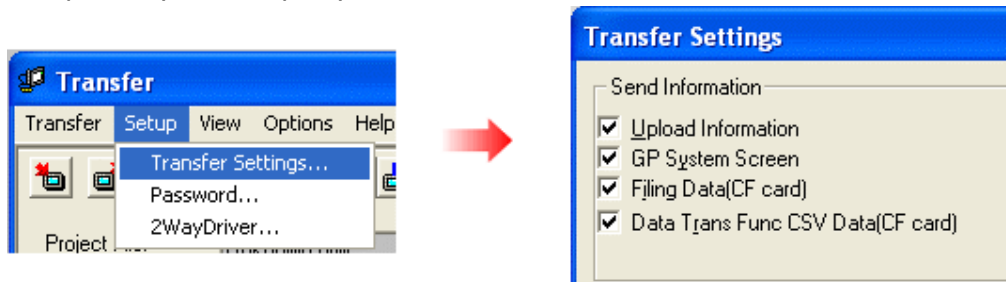

You can check in the following way if the Upload Information has been sent or not.

1. Enter into the GP's Offline mode.
2. If there are 2 asterisk (*) marks in the Main menu as shown below, the Upload Information has been sent.

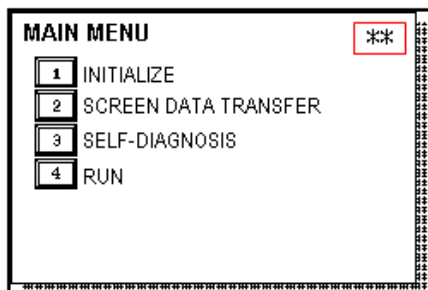

If not, there is no "Upload Information" sent. In this case, a message, which indicates there is no "Upload Information", appears and you cannot receive the data.

3.4 Convert screen data with the Project Converter

Convert a project file (*.prw) for GP-2500 series with the GP-Pro EX's Project Converter.

- (1) Click the [Start] button, select [All Programs] (or [Programs])->[Pro-face]-> [GP-Pro EX *.**]->[Project Converter]
(For the [*.**] part, the version of the software you use is displayed.)

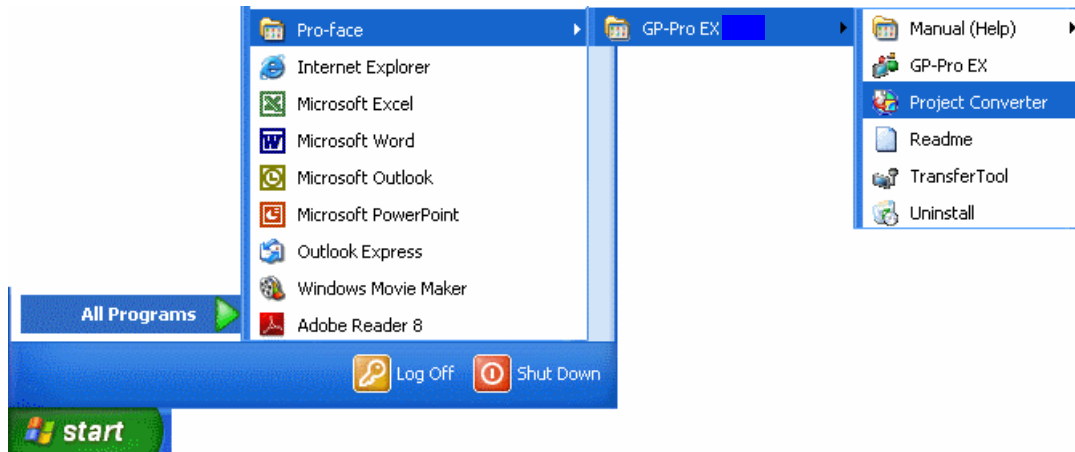

- (2) The Project Converter starts up and the [Project Converter] dialog box opens. Select [Project File (*.PRW)] in the [Data Type].

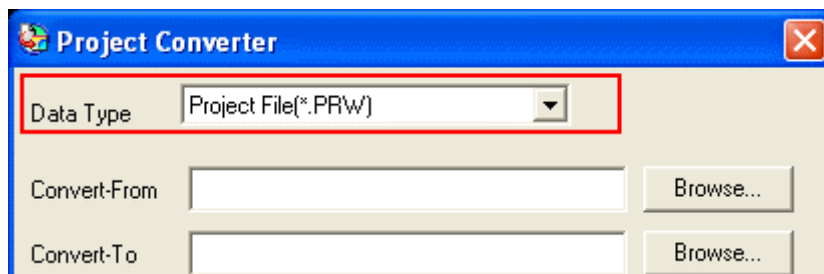

- (3) Click the [Browse...] button and select a project file (e.g.: "Project system A.prw"). Click [Open], and the file will be set in [Convert-From].

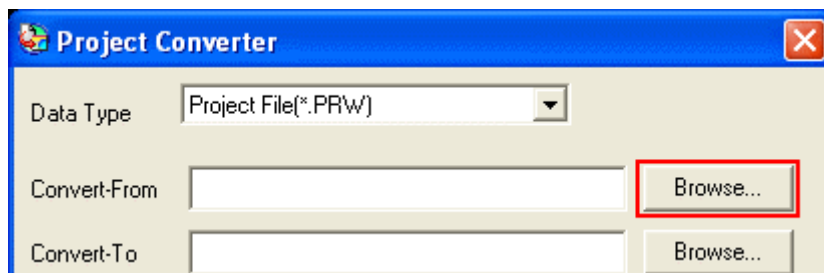

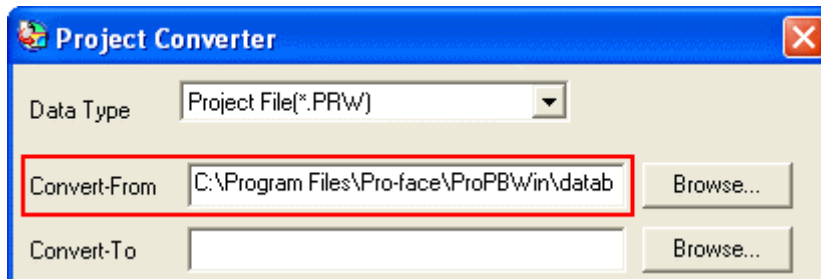
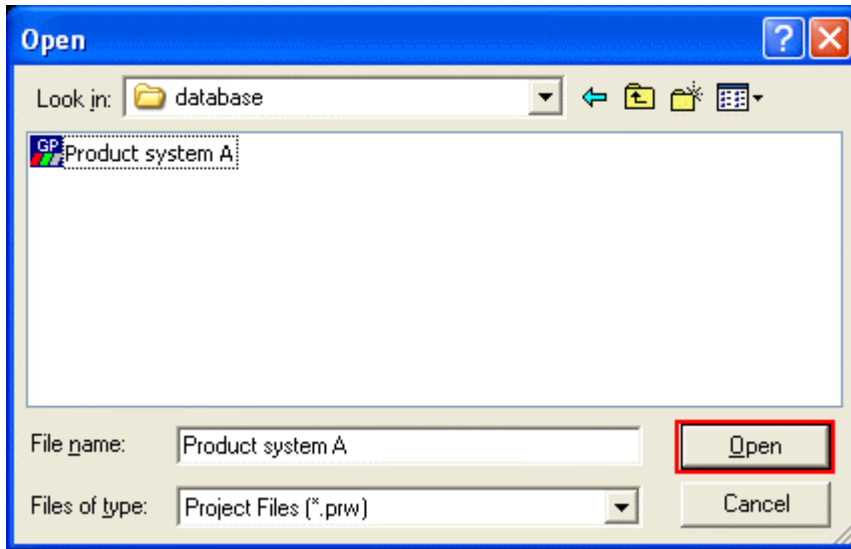

(4) In [Convert-To], designate a GP-Pro EX's project file (*.prx). Click the [Browse...] button and enter a new [File Name] (e.g.: "Product system A.prx"). Click [Save], and a new project file will be set to [Convert-To].

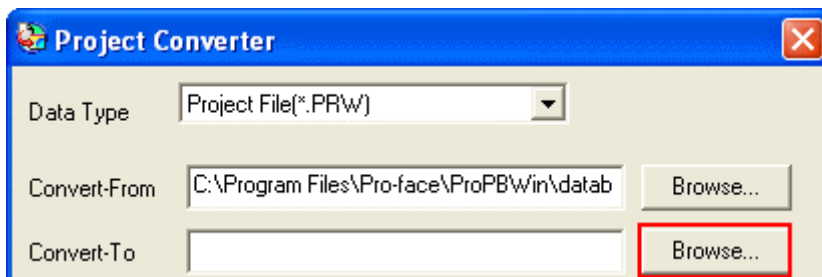

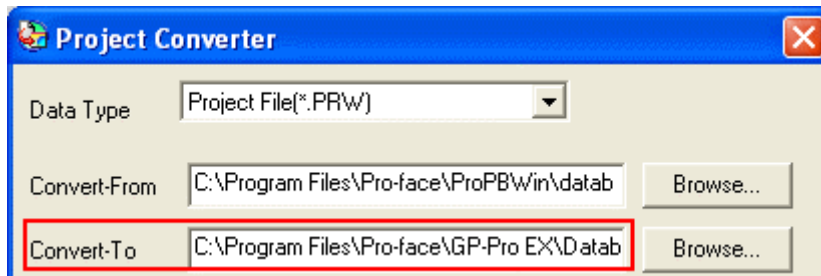
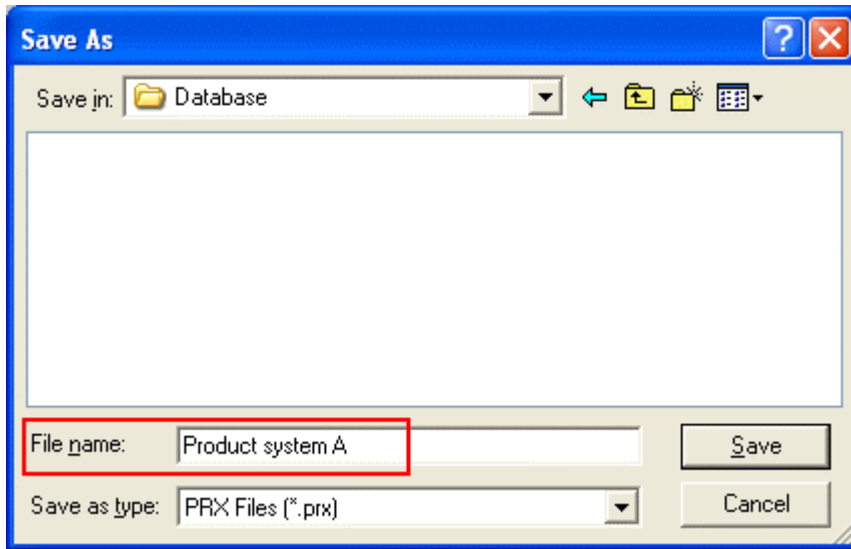

NOTE

When a convert-to file exists, the window that confirms whether or not to overwrite the file is displayed.

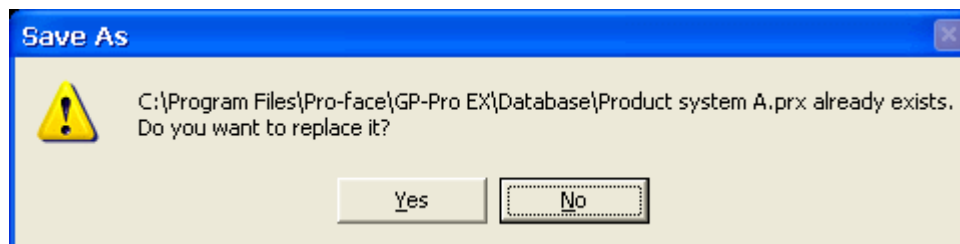

(5) Click [Convert] and start the conversion.

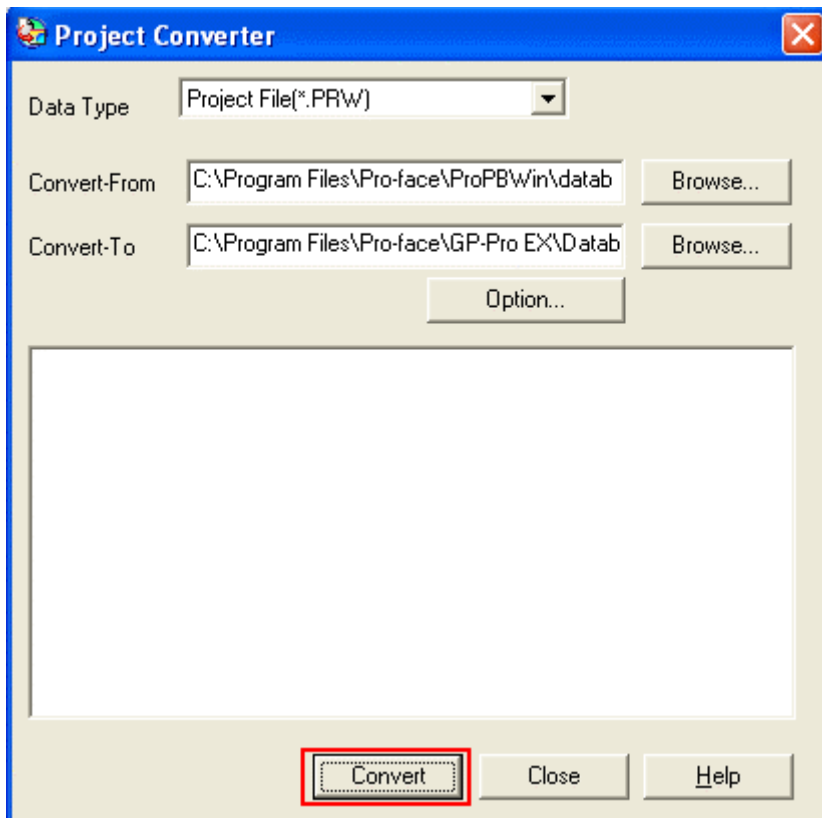

(6) If you are asked about the [Convert-To] type as shown below, select a replacement model's name on the pull-down menu. Click [OK].

NOTE

When replacing GP-2500 series with GP-4501TW, select [GP-4501T] if you don't find [GP-4501TW] on the pull-down menu.

If you select [GP-4501T] here, follow the instructions on [\[3.5 Change the Display Unit Type\]](#) to set the Display Unit type to GP-4501TW.

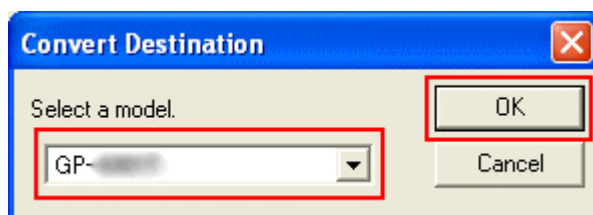

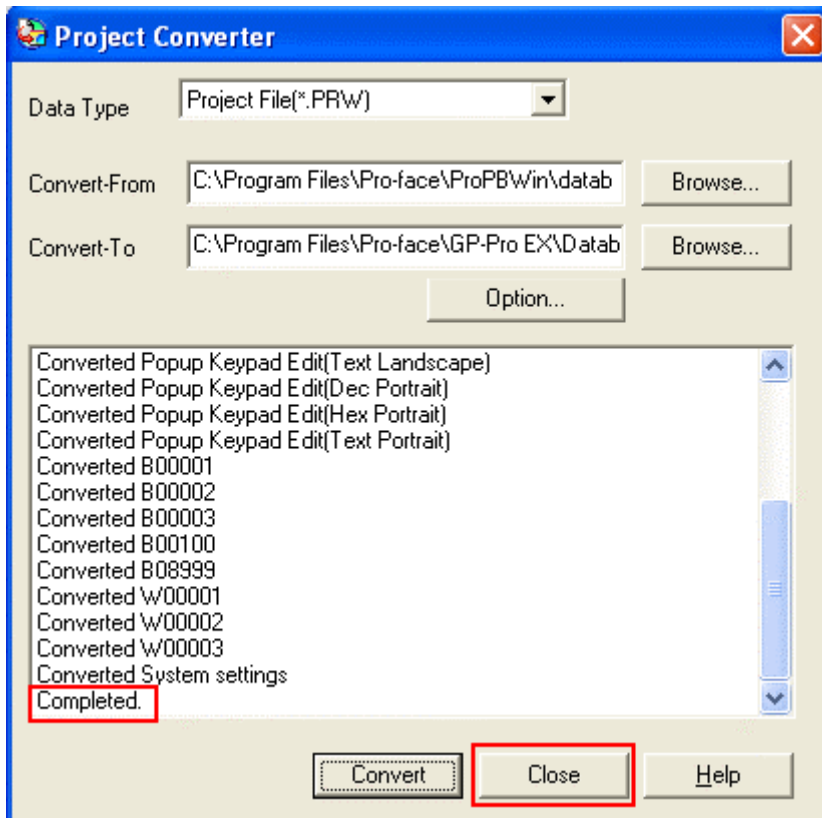

If an error message is displayed during conversion

If an error message is displayed during conversion, refer to [[Project Converter Error Message](#)] (http://www.pro-face.com/otasuke/qa/gp3000/replace/soft/conv/project_converter_error.html) on our Web site called [OtasukePro!] for the cause and the solution.

NOTE

If the following dialog box appears, CF Card Output Folder setting is required. Please refer to [Convert GP-PRO/PBIII for Windows' "Destination CF Card Folder"](#)

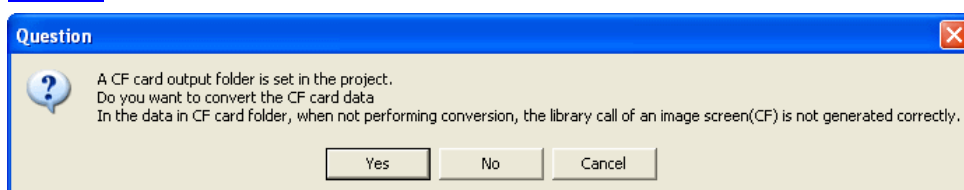

(7) After conversion, the [Save convert information] dialog box appears. If you click [Save], you can save the conversion information in a CSV file format.

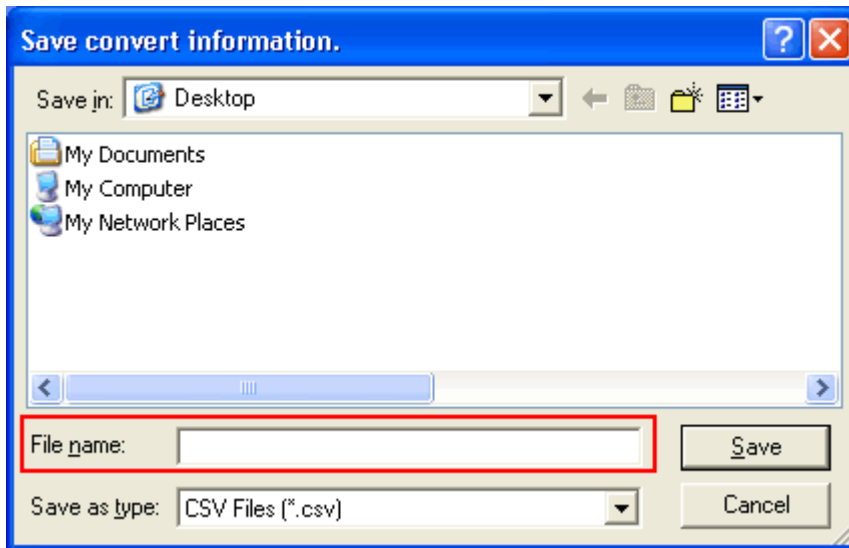

NOTE

Because the differences made at the time of conversion from GP-Pro/PBIII for Windows are described in the CSV saved file, the project file (*.prx) after conversion can be checked and modified according to the conversion information.

(8) Click [Close] to close the [Project Converter] dialog box.

If you double click the project file (*.prx) after conversion, GP-Pro EX will start and the file will open.

IMPORTANT

When the settings for the both COM1 and COM2 ports are configured for GP-2500T/S/L, the settings for the COM2 port are not converted on GP-Pro EX. If you still need the settings of the COM2 port for GP-2500T/S/L, add Device/PLC setting from [System Settings] on the [Project] menu of GP-Pro EX.

Convert GP-PRO/PBIII for Windows "Destination CF Card Folder"

If you convert a project file (*.prw) with a destination CF card folder designated in the step 6, the Question dialog box asking whether or not to designate the destination CF card folder for the convert destination appears again.

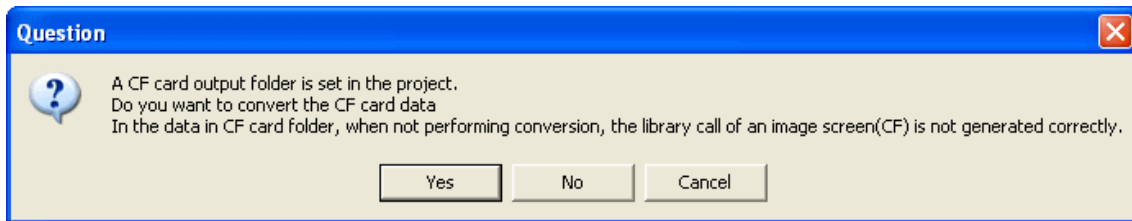

Select a folder (e.g.: "Database") and click [OK].

If you click the [Make New Folder] button, you can create a new folder at any location.



IMPORTANT

- In the [Question] dialog box, be sure to select [Yes] and specify the destination folder. If you select [No], images will not be called correctly.
- GP-4501T/TW is not equipped with a CF card slot. If a destination folder is created in the work above, a CF card will be automatically replaced with a SD card for the external device setting.
To check or change the destination folder setting, see [[5.1 Changing the setting of the external media to use](#)]

3.5 Change the Display Unit Type

(* Only when select [GP-4501T] on step 6 of [[3.4 Convert screen data with Project Converter](#)])

Open the project file (*.prx) on GP-Pro EX that is converted in the Chapter 3.4 and change the display unit type to GP-4501TW.

- (1) Open the converted project file (*.prx) on GP-Pro EX.
- (2) Click GP-Pro EX's [System Settings]->[Display] and there change the Display Unit to GP-4501TW.
- (3) Click [Project]->[Save] or [Save As] to save the change.

3.6 Transfer screen data to GP-4501T/TW

Transfer the project file after conversion to GP-4501T/TW.

You can transfer data to GP-4501T/TW via;

- An USB transfer cable (model: CA3-USBCB-01)
- An USB data transfer cable (model: ZC9USCBMB1)
- A commercial USB cable (USB Type A/mini B)
- A SD card/A USB storage device
- Ethernet

But this section explains, as an example, how to transfer screen data with an USB transfer cable (model: CA3-USBCB-01).



- (1) Connect your PC and GP-4501T/TW with an USB transfer cable (model: CA3-USBCB-01). If the driver of the cable has not been installed on your PC yet, a dialog box will appear. Please follow the instructions.

NOTE

- The "Hardware Installation" dialog box as shown below may appear during installing the USB driver depending on the security level of Windows® XP. Click [Continue Anyway] to start installing the driver. When installation is completed, click [Finish].

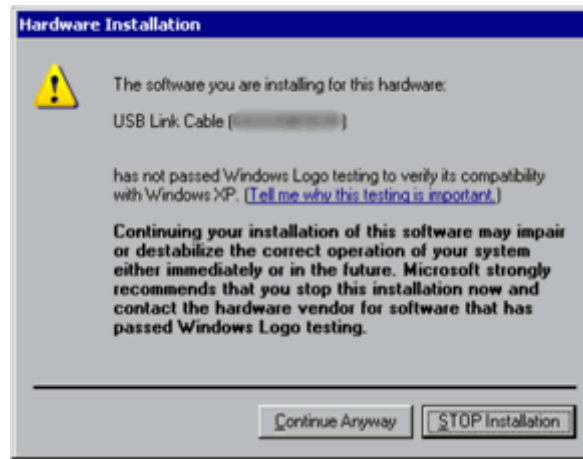

- If the following symptoms appear on Microsoft Windows® 7, go to updating “USB Data Transfer Driver” on [OtasukePro!] for download (http://www.pro-face.com/otasuke/download/freesoft/gpproex_transfer.htm).
- An error occurs when GP-Pro EX or Transfer Tool is installed
- An error occurs when data is transferred via an USB transfer cable (model: CA3-USBCB-01).

(2) Turn on the power of GP-4501T/TW. The “Initial Start Mode” screen will appear on the display unit. After transferring a project file once, this screen will not appear again.



- (3) On the GP-Pro EX's State Toolbar, click the [Transfer Project] icon to open the Transfer Tool.

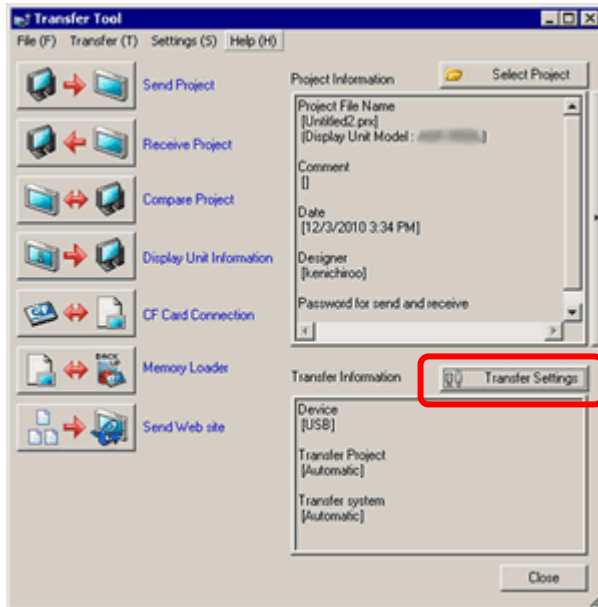

To transfer a different project file, click the [Select Project] button and select a project file.

- (4) Make sure that the [Device] in the "Transfer Settings Information" is set to [USB]. If not, click the [Transfer Setting] button to open the "Transfer Setting" dialog box. Select [USB] in the Communication Port Settings field and click [OK].



- (5) Click [Send Project] to start transfer.

When the following dialog box appears, click [Yes]. This dialog box doesn't appear when the same project file is sent again.

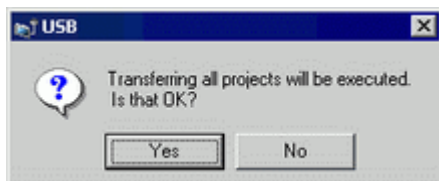

- (6) The following dialog box appears during transfer and you can check the communication status. (The display unit enters the Transferring mode and communication with the device such as a PLC is terminated.)

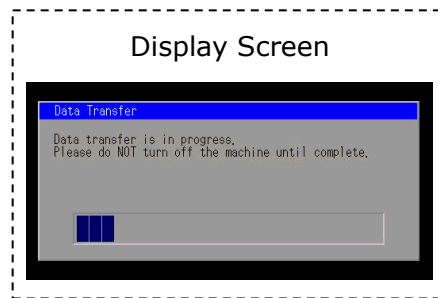
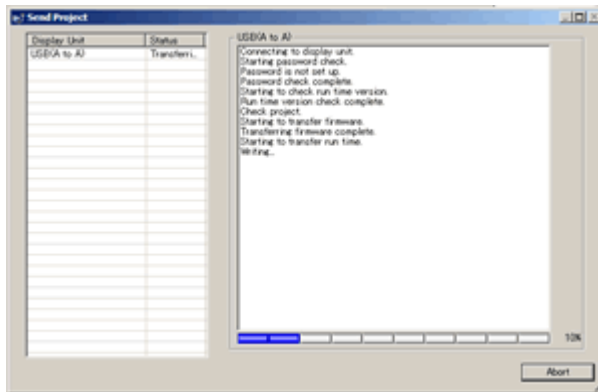

- (7) When transfer is completed, the status displayed in the dialog box will change from [Transferring] to [Complete Transfer]. Click [Close] to close the dialog box.

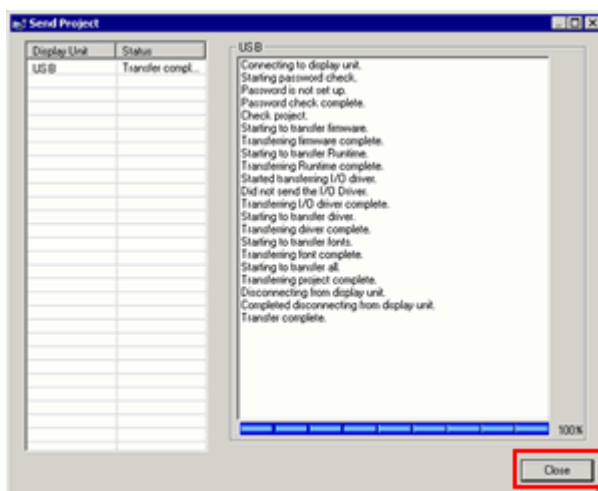

The display unit will be reset and a screen of the transferred project file will be displayed.

- (8) Close the Transfer Tool.
 (9) Click the [X] mark on top right of the screen or [Project]->[Exit] to close GP-Pro EX.

3.7 Differences of software

3.7.1 Differences after conversion

Check the differences of screen data after conversion from GP-PRO/PBIII to GP-Pro EX. For the details of each item, refer to our website.

<http://www.pro-face.com/otasuke/qa/gp3000/replace/soft/conv/care/3/>

Differences of Software

1	Touch Panel Type
2	Compatibility of Bit Switch
3	Compatibility of Alarm
4	Compatibility of Trend Graph
5	Compatibility of K tag (Input Order)
6	Compatibility of K tag (difference of Writing)
7	Compatibility of K tag (Indirect Setting)
8	Compatibility of N tag
9	Precautions for using the switch for [History Data Display] of Trend Graph on the window
10	About window display on a momentary switch during momentary operation
11	About the performance when a display area of the system window is overlapping
12	Change of Tag Process
13	About the display when a fixed Draw is placed on a Part
14	Compatibility of Text
15	Compatibility of Fill
16	Compatibility of CF Card Data
17	Precautions for conversion when filing data is saved in a CF card
18	Precautions for setting "Color Settings" to [256 Colors without blinking]
19	Precautions for loading a part with "L Tag (Library Display)"
20	Compatibility of MRK files and CPW files
21	Compatibility of V Tag/v tag and Video Screen
22	Compatibility of Extended SIO Script
23	Compatibility of Sound Data
24	Compatibility of Device Monitor
25	Compatibility of Ladder Monitor
26	Compatibility of J Tag and R Tag
27	Converting Screen Data of DOS
28	Compatibility of Standard Font

29	D Script starts right after screen change or power on. (Compatibility of D Script Trigger Condition)
30	The position shifts when loading a window screen (Compatibility of U Tag)
31	Precautions for using Screen Level Change
32	Compatibility of H tag

Chapter 4 Communication with Device/PLC

4.1 Drivers

More connectable drivers will be added.

For the devices/PLC each driver supports, see [Connectable Devices]

(<http://www.pro-face.com/product/soft/gpproex/driver/driver.html>).

4.2 Shapes of COM ports

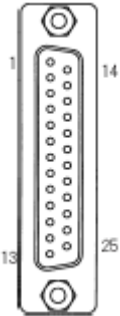
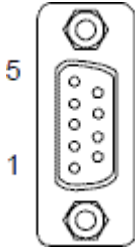
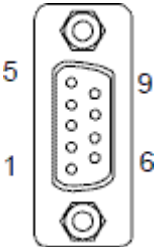
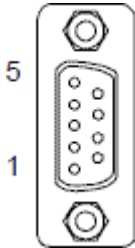
	GP-2501T/S/L	GP-2500T/S/L	GP-4501T/TW
COM1	D-Sub 25 pin (socket) RS-232C/422		D-Sub 9 pin (plug) RS-232C
			
COM2	-	D-Sub 9 pin (plug) RS-232C	D-Sub 9 pin (plug) RS-422/485
			

4.3 Signals of COM ports

4.3.1 Signals of COM1

For GP-2500 series

RS-232C or RS-422 (socket)

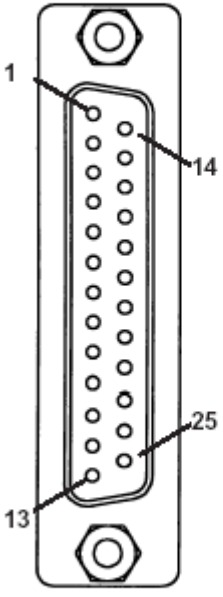
Pin Assignments	Pin #	Signal Name	Condition
<p>(D-Sub 25pin female)</p> <p>SIO</p> 	1	FG	Frame ground
	2	SD	Send data (RS-232C)
	3	RD	Receive data (RS-232C)
	4	RS	Request send (RS-232C)
	5	CS	Clear send (RS-232C)
	6	DR	Data Set Ready (RS-232C)
	7	SG	Signal ground
	8	CD	Carrier detect (RS-232C)
	9	TRMX	Termination (RS-422)
	10	RDA	Receive data A (RS-422)
	11	SDA	Send data A (RS-422)
	12	NC	No connection (Reserved)
	13	NC	No connection (Reserved)
	14	VCC	5V±5% output 0.25A
	15	SDB	Send data B (RS-422)
	16	RDB	Receive data B (RS-422)
	17	RI	Ring Indicate (RS-232C)
	18	CSB	Clear send B (RS-422)
	19	ERB	Enable receive B (RS-422)
	20	ER	Enable receive (RS-232C)
	21	CSA	Clear send A (RS-422)
	22	ERA	Enable receive A (RS-422)
	23	NC	No connection (Reserved)
	24	NC	No connection (Reserved)
	25	NC	No connection (Reserved)

For GP-4501T/TW

RS-232C (plug)

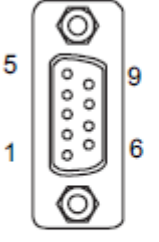
Pin Connection	Pin No.	RS-232C		
		Signal Name	Direction	Meaning
 <p>(GP unit side)</p>	1	CD	Input	Carrier Detect
	2	RD(RXD)	Input	Receive Data
	3	SD(TXD)	Output	Send Data
	4	ER(DTR)	Output	Data Terminal Ready
	5	SG	-	Signal Ground
	6	DR(DSR)	Input	Data Set Ready
	7	RS(RTS)	Output	Request to Send
	8	CS(CTS)	Input	Send possible
	9	CI(RI)/VCC	Input/-	Called Status Display +5V±5% Output 0.25A ^{*1}
	Shell	FG	-	Frame Ground (Common with SG)

*1: RI and VICC of Pin 9 are switched on the software.

VCC Output is not protected from overcurrent.

Please follow the current rating to avoid false operation or breakdown.

4.3.2 Signals of COM2

For GP-2500T/S/L

RS-232C (plug)

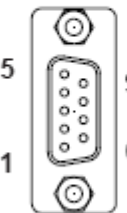
Pin Assignments	Pin No.	Signal Name	Signal Direction	Condition
(D-Sub 9pin male) 	1	CD	Input	Carrier detect (RS-232C)
	2	RD	Input	Receive data (RS-232C)
	3	SD	Output	Send data (RS-232C)
	4	ER	Output	Enable receive (RS-232C)
	5	SG	—	Signal Ground
	6	DR	Input	Data Set Ready (RS-232C)
	7	RS	Output	Request Send (RS-232C)
	8	CS	Input	Clear send (RS-232C)
	9	R/VCC	Input/Output	Ring Indicate (RS-232C) +5V+5% 0.25A

For GP-2501T/S/L

N/A

For GP-4501T/TW

RS-422/485 (plug)

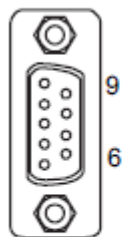
Pin Connection	Pin No.	RS-422/RS-485		
		Signal Name	Direction	Meaning
 (GP unit side)	1	RDA	Input	Receive Data A (+)
	2	RDB	Input	Receive Data B (-)
	3	SDA	Output	Send Data A (+)
	4	ERA	Output	Data Terminal Ready A (+)
	5	SG	-	Signal Ground
	6	CSB	Input	Send Possible B (-)
	7	SDB	Output	Send Data B (-)
	8	CSA	Input	Send Possible A (+)
	9	ERB	Output	Data Terminal Ready B (-)
	Shell	FG	-	Frame Ground (Common with SG)

4.4 Multilink Connection

For GP-4501T/TW, some communication drivers do not support multi-link connection (n:1) via RS-422.

When converting the project file with the setting of the communication driver that does not support multi-link connection (n:1) via RS-422, the connection is automatically converted to (1:1).

For the communication drivers that support serial multi-link, see [[Which drivers support serial multilink communication?](#)]

(http://www.pro-face.com/otasuke/files/manual/gpproex/new/device/com_mlnk.htm)

.

4.5 Internal 2-Port feature for Mitsubishi PLC

For GP-4501T/TW, the internal 2-Port feature for Mitsubishi PLC cannot be used.

If [GP Setup]->[Mode Settings]->[Option]->[Internal 2 port] is selected on GP-PRO/PBIII, the following message will appear when converting the project file with the GP-Pro EX Project Converter.



4.6 Cable Diagram at the time of replacement

The connection cable for GP-2500 series can be used for GP-4501T/TW.

But please note that there are precautions and restrictions as described below.

IMPORTANT

- Please check the connection configurations GP-4501T/TW supports with GP-Pro EX Device/PLC Connection Manual before using a connection cable.
(<http://www.pro-face.com/otasuke/files/manual/gpproex/new/device/index.htm>)

- **The Siemens MPI connection cable, MPI adapter (GP070-MPI-41)** cannot be used.
Please refer to the above-mentioned GP-Pro EX Device/PLC Connection Manual and prepare a connection cable for GP-4501T/TW newly.

- When using Mitsubishi PLC A/QnA series (CPU Direct), please refer the following notes,
 - [When using GP430-IP10-O/ GP430-IP11-O,](#)
Refer > 4.6.1 When using a RS-232C connection cable > When using CPU I/F Cable for Mitsubishi PLC...

 - [When using GP2000-CBLA/5M-01 \(* including User-created cable\)](#)
Refer > 4.6.2 When using a RS-422 connection cable > When using Mitsubishi A/QnA series (CPU Direct) connection cable (GP2000-CBLA/5M-01)

 - [When using GP2000-CBLFX/5M-01, GP2000-CBLFX/1M-01\(* including User-created cable\)](#)
Refer > 4.6.2 When using a RS-422 connection cable > When using Mitsubishi FX series (CPU Direct) connection cable (GP2000-CBLFX/5M-01, GP2000-CBLFX/1M-01)

4.6.1 When using a RS-232C connection cable

GP-2500 series System Configuration (connecting to **COM1**)

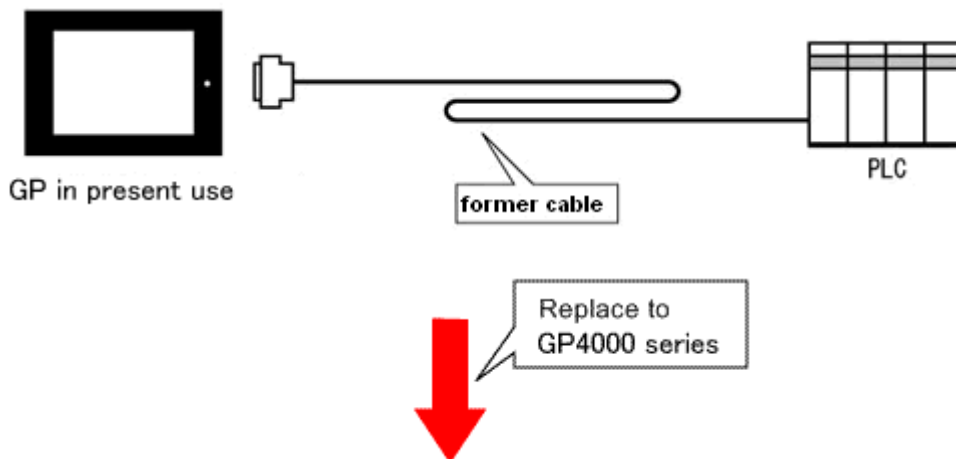

GP-4501T/TW System Configuration (connecting to **COM1**)

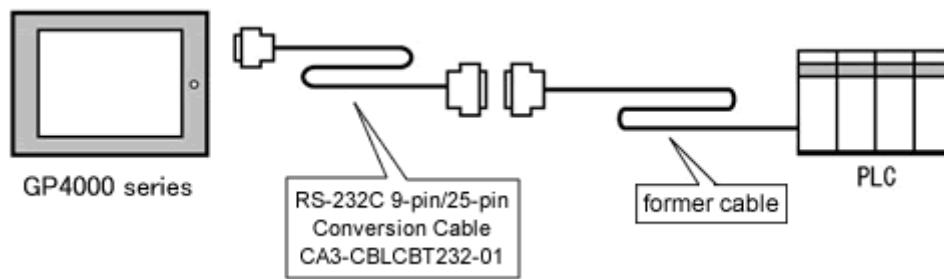

To replace GP-2500 series with GP-4501T/TW, prepare the following item.

Product Name	Model
RS-232C 9-pin/25-pin Conversion Cable (20cm)	CA3-CBLCBT232-01

When using CPU I/F Cable for Mitsubishi PLC...

When using CPU I/F Cables for Mitsubishi PLC (GP430-IP10-O/ GP430-IP11-O) with GP-2500 series, be sure to select "VCC" in the Device/PLC Setting on GP-Pro EX after converting a project file, or the communication will not work properly.

RI / VCC

RI

VCC

In the case of RS232C, you can select the 9th pin to RI (Input) or VCC (5V Power Supply). If you use the Digital's RS232C Isolation Unit, please select it to VCC.

To change this setting, select [System Settings] -> [Device/PLC] in the [Project] menu on GP-Pro EX.

* For GP-2500T/S/L only:

GP-2500T/S/L System Configuration (connecting to **COM2**)

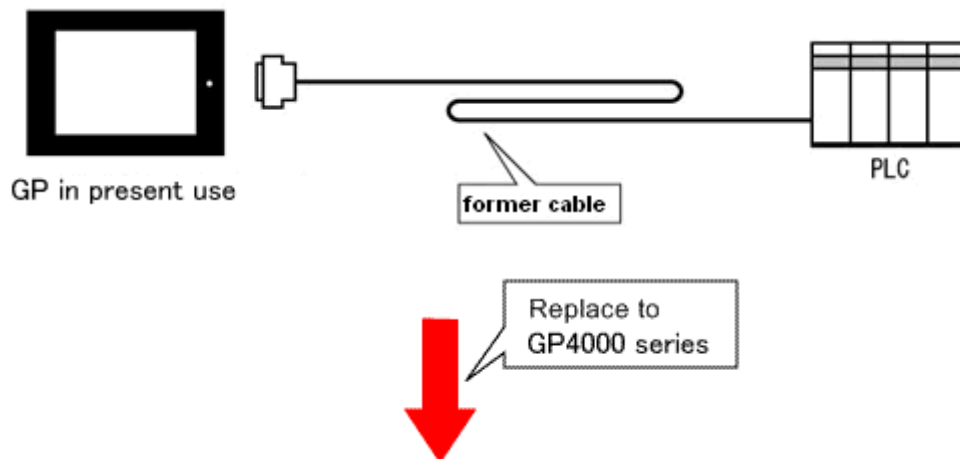

GP-4501T/TW System Configuration (connecting to **COM1**)

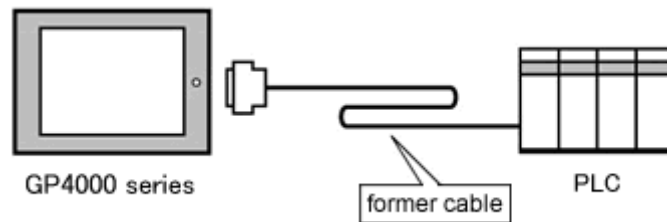

*The same cable can be used.

4.6.2 When using a RS-422 connection cable

GP-2500 series System Configuration (connecting to **COM1**)

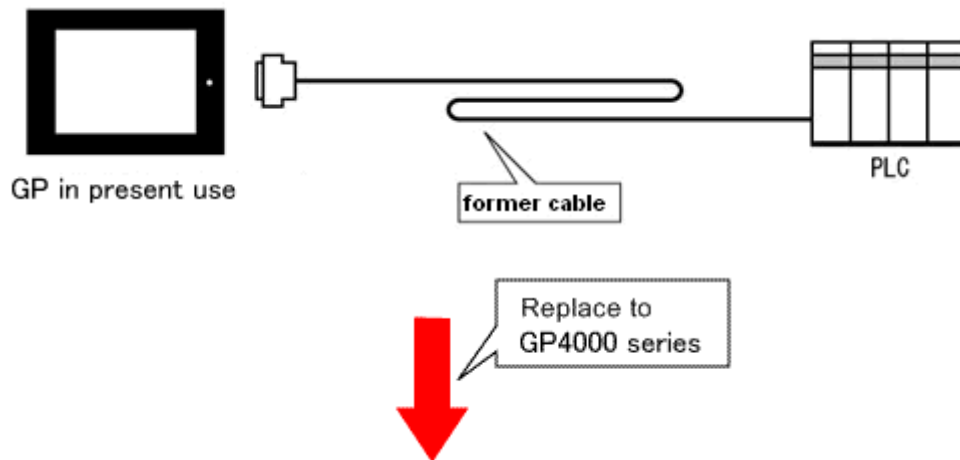

GP-4501T/TW System Configuration (connecting to **COM2**)

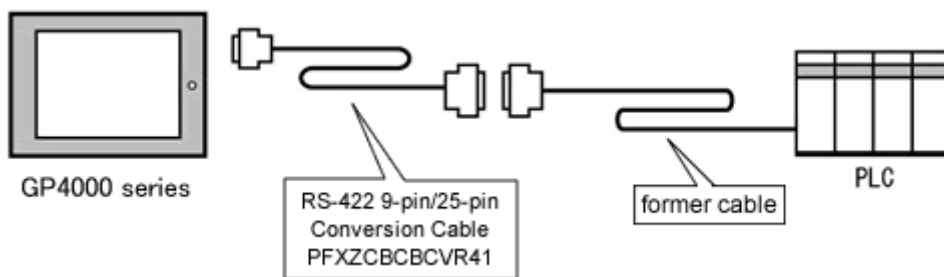

IMPORTANT

Before connecting to GP-4501T/TW, be sure to change the port setting to [**COM2**] on Device/PLC Setting of GP-Pro EX. Please check the communication setting with GP-Pro EX Device/PLC Connection Manual just in case.
<http://www.pro-face.com/otasuke/files/manual/gpproex/new/device/index.htm>

To replace GP-2500 series with GP-4501T/TW, prepare the following item.

Product Name	Model
RS-422 9-pin/25-pin Conversion Cable (20cm)	PFXZCBCBCVR41

NOTE

When using a terminal block adapter (GP070-CN10-O), we recommend you to replace it with a terminal block conversion adapter (PFXZCBADTM1) for GP-4501T/TW.

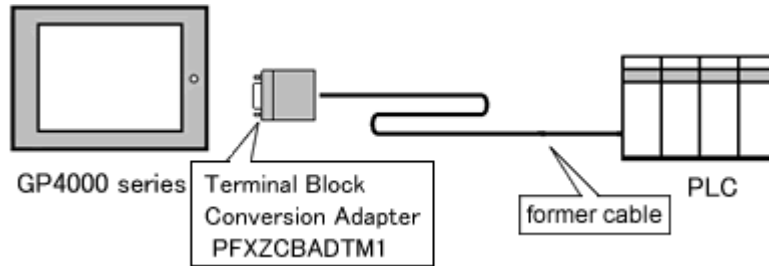

For replacement in this connection method, prepare the following item.

Product Name	Model
Terminal Block Conversion Adapter	PFXZCBADTM1

When using Mitsubishi A/QnA series (CPU Direct) connection cable
(GP2000-CBLA/5M-01) * Including User-created cable

9/25-pin Conversion Cable cannot be used.

**Please replace to Mitsubishi A connection cable by Pro-face
(CA3-CBLA-01).**

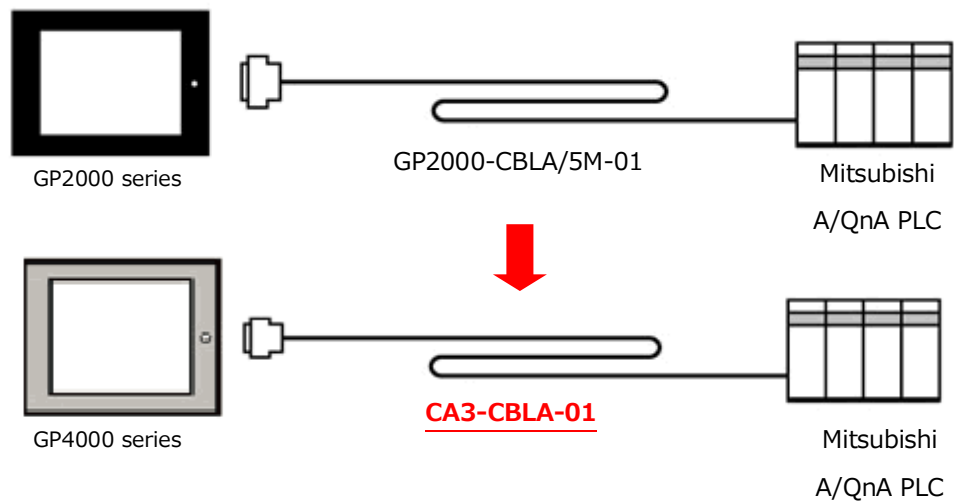

Not available options for 4000 series

RS-422 9/25-pin Conversion Cable (20cm) (PFXZCBCBCVR41)

COM Port Conversion Adapter (CA3-ADPCOM-01)

+ RS-422 9/25-pin Conversion Cable (20cm) (CA3-CBLCBT422-01)

When using Mitsubishi A/QnA series (CPU Direct) connection cable
(GP2000-CBLFX/5M-01, GP2000-CBLFX/1M-01)

* Including User-created cable

9/25-pin Conversion Cable cannot be used.

Please replace to Mitsubishi FX connection cable by Pro-face

(CA3-CBLFX/5M-01(5m) or CA3-CBLFX/ 1 M-01(1m)) .

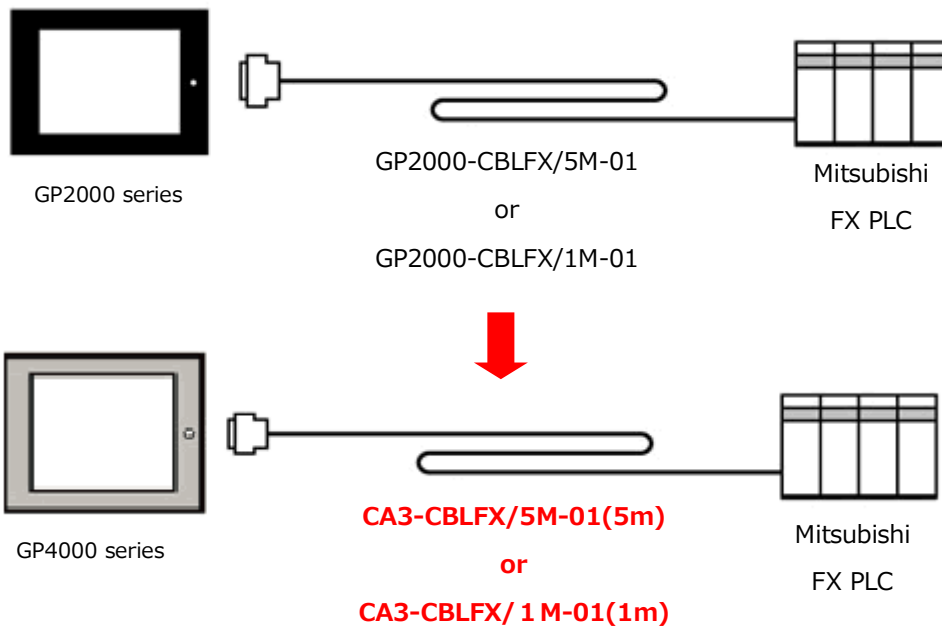

Not available options for 4000 series

RS-422 9/25-pin Conversion Cable (20cm) (PFXZCBCBCVR41)

COM Port Conversion Adapter (CA3-ADPCOM-01)

+ RS-422 9/25-pin Conversion Cable (20cm) (CA3-CBLCBT422-01)

Chapter 5 Appendix

5.1 Changing the setting of the external media to use

If a CF card has been used for GP-PRO/PBIII, after GP-2500 series is replaced with GP-4501T/TW with GP-Pro EX, "a CF card" is automatically replaced with "a SD card" for the external media setting.

- (1) After conversion of the project file data, at GP-Pro EX Error Check, if the message, "The project contains features that require a SD card. However, the selected display does not support SD cards so these features will not run." appears,

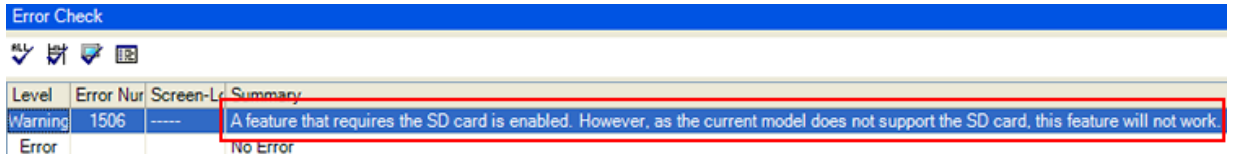

Level	Error Num	Screen-Id	Summary
Warning	1506	----	A feature that requires the SD card is enabled. However, as the current model does not support the SD card, this feature will not work.
Error			No Error

<Cause>

The model without a SD card slot has the setting that uses a SD card.

-> [Solution 1](#)

- (2) To use a USB storage device instead of a SD card -> [Solution 1](#)

- (3) To check or change the SD card's data output destination folder setting

-> [Solution 2](#)

[Solution]

1. Change the SD Card setting to the USB storage setting following the steps below.

<Procedure>

- i. Click [Project]->[Information]->[Destination Folder].
- ii. Uncheck "Enable SD Card" and check "Enable USB Storage".

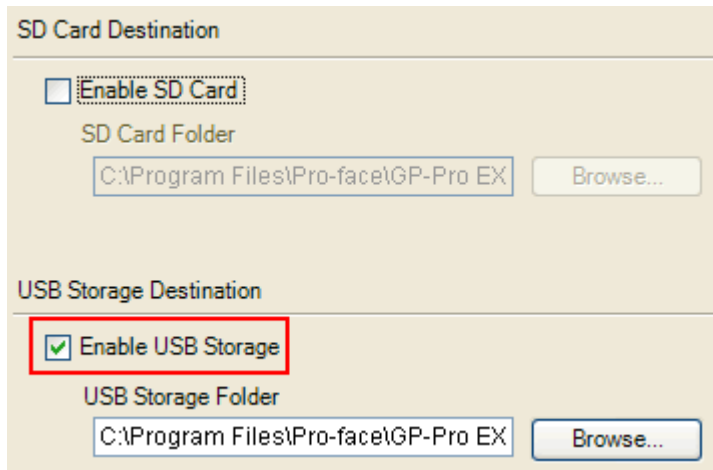

iii. Click the [Browse] button and specify a destination folder.

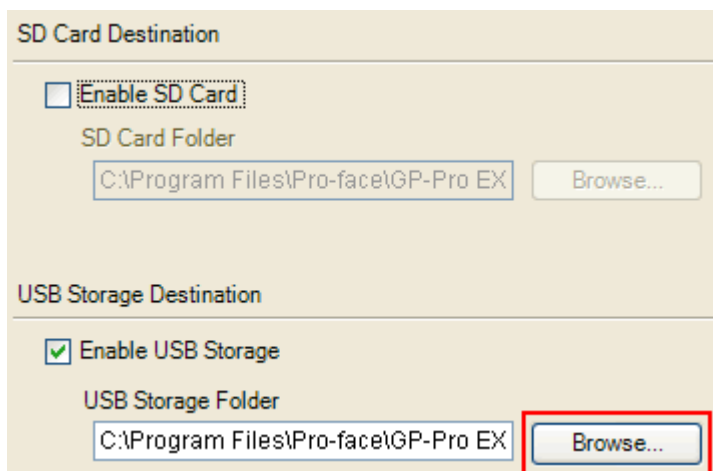

iv. Click [OK] to confirm the setting.

v. Click [Project]->[Save] to save changes.

vi. Check each function that uses the CF card and replace the setting of [SD Card] with [USB Storage] for the media setting.

NOTE

- To see how the tags or the parts of GP-PRO/PBIII for Windows are replaced on GP-Pro EX, refer to [OtasukePro!] "Feature Comparison between GP-PRO/PBIII and GP-Pro EX" (<http://www.pro-face.com/otasuke/qa/gp3000/replace/soft/conv/care/3/compare.htm>)
- To check each function setting of GP-Pro EX, refer to GP-Pro EX Reference Manual.

2. Check and change the destination folder setting following the steps below.

i. Click [Project]->[Information]->[Destination Folder].

ii. The current setting is displayed.

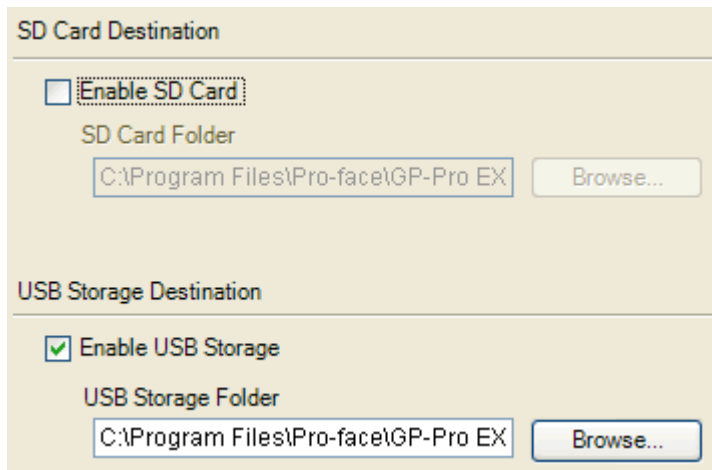

The image shows a dialog box with two sections. The top section is titled "SD Card Destination" and contains an unchecked checkbox labeled "Enable SD Card". Below it is a text field labeled "SD Card Folder" containing the path "C:\Program Files\Pro-face\GP-Pro EX" and a "Browse..." button. The bottom section is titled "USB Storage Destination" and contains a checked checkbox labeled "Enable USB Storage". Below it is a text field labeled "USB Storage Folder" containing the same path "C:\Program Files\Pro-face\GP-Pro EX" and a "Browse..." button.

iii. After changing it, click [OK] to confirm the setting.

iv. Click [Project]->[Save] to save changes.