

Easy! Smooth!

GP-2400 Series→GP4000 Series

Replacement Guidebook

Preface

This guidebook introduces the procedures to replace a unit in GP-2400 series with a unit in GP-4401T.

Model in use	Recommended Substitution
GP-2400T	GP-4401T
GP-2401T	

Safety Information

HAZARD OF OPERATOR INJURY, OR UNINTENDED EQUIPMENT DAMAGE

Before operating any of these products, be sure to read all related manuals thoroughly.

Failure to follow these instructions can result in death, serious injury or unintended equipment damage.

Contents

PREFACE	2
SAFETY INFORMATION	2
HAZARD OF OPERATOR INJURY, OR UNINTENDED EQUIPMENT DAMAGE	2
CONTENTS	3
CHAPTER 1 SPECIFICATION COMPARISON	5
1.1 SPECIFICATIONS OF GP-2400T AND GP-4401T	5
1.2 SPECIFICATIONS OF GP-2401T AND GP-4401T	7
CHAPTER 2 COMPATIBILITY OF HARDWARE	9
2.1 LOCATIONS OF CONNECTOR	9
2.2 TOUCH PANEL SPECIFICATIONS	11
2.4 TRANSFER CABLE	11
2.5 INTERFACE	12
2.5.1 SERIAL INTERFACE	12
2.5.2 AUXILIARY I/O INTERFACE (AUX)	12
2.5.3 SOUND OUTPUT INTERFACE (FOR GP-2400T ONLY)	12
2.5.4 CF CARD INTERFACE	12
2.6 PERIPHERAL UNITS AND OPTIONS	13
2.6.1 BARCODE READER CONNECTION	13
2.6.2 PRINTER CONNECTION	13
2.6.3 EXPANSION UNIT	13
2.6.4 ISOLATION UNIT	13
2.7 POWER CONNECTOR	13

2.8 BACKUP BATTERY	14
2.9 POWER CONSUMPTION	14
2.10 MATERIALS/COLORS OF THE BODY	14
2.11 ABOUT PRO-SERVER	14
2.12 OTHER NOTES	15

CHAPTER 3 REPLACEMENT PROCEDURE **16**

3.1 WORK FLOW	16
3.2 PREPARATION	17
3.3 RECEIVE SCREEN DATA FROM GP-2400 SERIES	18
3.4 CONVERT SCREEN DATA WITH THE PROJECT CONVERTER	23
3.5 TRANSFER SCREEN DATA TO GP-4401T	30
3.6 DIFFERENCES OF SOFTWARE	35
3.6.1 DIFFERENCES AFTER CONVERSION	35

CHAPTER 4 COMMUNICATION WITH DEVICE/PLC **37**



4.1 DRIVER LIST	37
4.2 SHAPES OF COM PORTS	38
4.3 SIGNALS OF COM PORTS	39
4.3.1 SIGNALS OF COM1	39
4.3.2 SIGNALS OF COM2	41
4.4 MULTILINK CONNECTION	42
4.5 CABLE DIAGRAM AT THE TIME OF REPLACEMENT	43
4.5.1 WHEN USING A RS-232C CONNECTION CABLE,	44
4.5.2 WHEN USING A RS-422 CONNECTION CABLE,	46

CHAPTER 5 APPENDIX **48**

5.1 CHANGING THE SETTING OF THE EXTERNAL MEDIA TO USE	48
--	-----------



Chapter 1 Specification Comparison

1.1 Specifications of GP-2400T and GP-4401T

		GP-2400T	GP-4401T
			
Display Type		TFT Color LCD	
Display Colors, Levels		256 colors (without blink)/ 64 colors (with blink)	UP! 65,536 colors (without blink)/ 16,384 colors (with blink)
Display Resolution		VGA (640x480 pixels)	
Panel Cutout Dimensions (mm)		204.5(W)x159.5(H)	
External Dimensions (mm)		215(W)x170(H)x60(D)	218(W)x173(H)x60(D)
Touch Panel Type		Matrix	NEW! Analog → See 2.2
Memory	Application	4MB	UP! 32MB
	SRAM	256KB	UP! 320KB
Backup Battery		Secondary Battery (Rechargeable Lithium battery)	NEW! Primary Battery (Replaceable Lithium battery) → See 2.8
Rated Input Voltage		DC 24V	

Serial I/F	COM1	D-Sub 25 pin (socket) RS-232C/422	D-Sub 9 pin (plug) RS-232C → See 2.5.1
	COM2	D-Sub 9 pin (plug) RS-232C	D-Sub 9 pin (plug) RS-422/485 → See 2.5.1
Ethernet I/F		10BASE-T	UP! 10BASE-T/100BASE-TX
CF Card I/F		✓	- → See 2.5.4
SD Card I/F		-	NEW! ✓
USB I/F	Type A	-	NEW! ✓
	Type mini B	-	→ See 2.4
Tool Connector I/F		✓	-
Printer I/F		Centronic-compliant (parallel)	NEW! USB(Type A) → See 2.6.2
Auxiliary I/O I/F		✓	- → See 2.5.2
Sound Output I/F		✓	- → See 2.5.3
Expansion Unit I/F		✓	- → See 2.6.3

1.2 Specifications of GP-2401T and GP-4401T

		GP-2401T	GP-4401T
			
Display Type		TFT Color LCD	
Display Colors, Levels		256 colors (without blink)/ 64 colors (with blink)	UP! 65,536 colors (without blink)/ 16,384 colors (with blink)
Display Resolution		VGA (640x480 pixels)	
Panel Cutout Dimensions (mm)		204.5(W)x159.5(H)	
External Dimensions (mm)		215(W)x170(H)x60(D)	218(W)x173(H)x60(D)
Touch Panel Type		Matrix	NEW! Analog → See 2.2
Memory	Application	2MB	UP! 32MB
	SRAM	128KB	UP! 320KB
Backup Battery		Secondary Battery (Rechargeable Lithium battery)	NEW! Primary Battery (Replaceable Lithium battery) → See 2.8

Serial I/F	COM1	D-Sub 25 pin (socket) RS-232C/422	D-Sub 9 pin (plug) RS-232C → See 2.5.1
	COM2	-	D-Sub 9 pin (plug) RS-422/485 → See 2.5.1
Ethernet I/F		-	NEW! 10BASE-T/100BASE-TX
CF Card I/F		✓	- → See 2.5.4
SD Card I/F		-	NEW! ✓
USB I/F	Type A	-	NEW! ✓ → See 2.4
	Type mini B		
Tool Connector I/F		✓	-
Printer I/F		Centronic-compliant (parallel)	NEW! USB(Type A) See 2.6.2
Auxiliary I/O I/F		✓	- → See 2.5.2
Expansion Unit I/F		✓	- → See 2.6.3

Chapter 2 Compatibility of Hardware

2.1 Locations of connector

Connector locations on GP-2400 series and GP-4401T are as follows:

GP-2400T

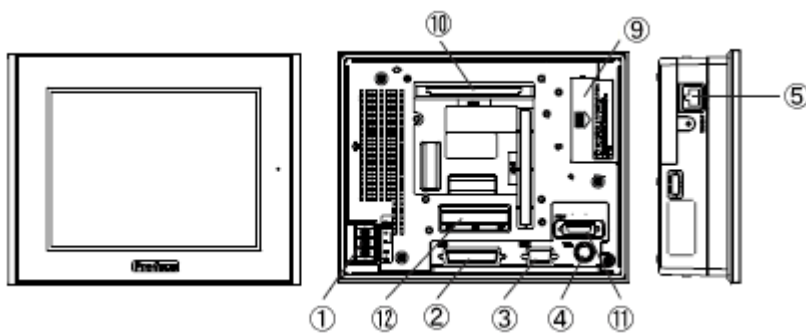

GP-2401T

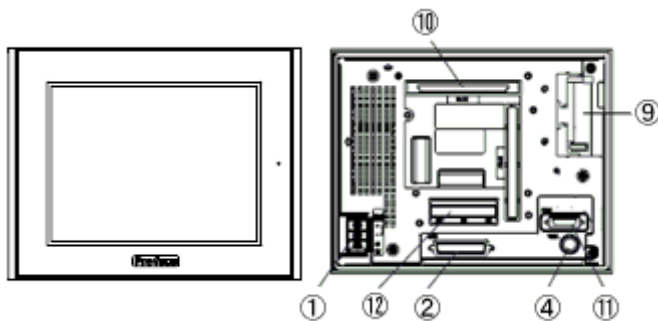

GP-4401T

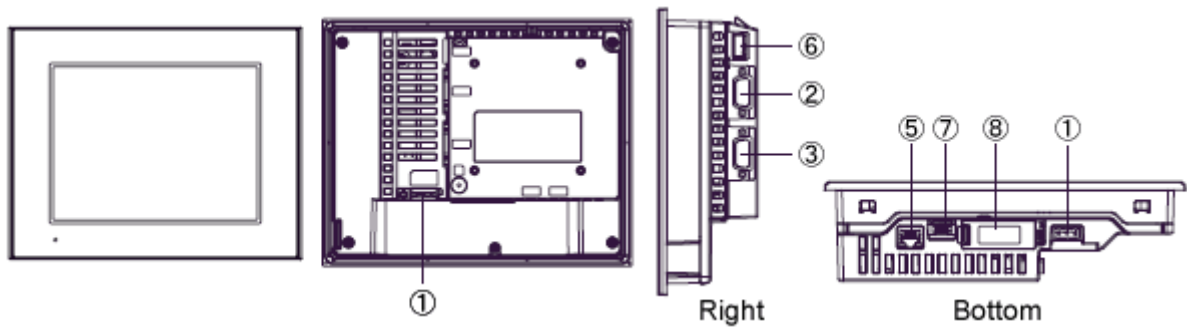

Interface names

	GP-2400T	GP-2401T	GP-4401T
1	Power Input Terminal Block		Power Connector
2	Serial I/F (COM1)		
3	Serial I/F (COM2)	-	Serial I/F (COM2)
4	Tool Connector		-
5	Ethernet I/F	-	Ethernet I/F
6	-		USB I/F (Type A)
7	-		USB I/F (Type mini B)
8	-		SD Card I/F
9	CF Card I/F		-
10	Expansion Unit I/F		-
11	Printer I/F		-
12	Auxiliary I/O I/F (AUX)		-

2.2 Touch Panel specifications

GP-4401T adopts the Analog type.



For the Analog type, if you touch two points at the same time, only the first touched point is recognized, but the second touched one is not.

If you have applied the two-point touch input on GP-2400 series, we recommend you to change to the one-point touch input using the switch delay function of GP-Pro EX.

2.4 Transfer cable

To transfer screen data to GP-4401T, use a USB transfer cable or Ethernet.

The USB cables that can be used for GP-4401T are as follows:

	Model	Connector Type	Connector on GP
Options	CA3-USBCB-01	 Type A Type A	USB (Type A)
	ZC9USCBMB1	 Type A Type mini B	USB (Type mini B)
Commercial Item	-		

Please note that the cables (GPW-CB02, GPW-CB03, GP430-CU02-M) for GP-2400 series cannot be used for GP-4401T.

2.5 Interface

2.5.1 Serial Interface

The pin assignment and the shape of plug/socket connector of GP-2400 series are different from those of GP-4401T.

To know the details about them, see [[4.2 Shapes of COM ports](#)] and [[4.3 Signals of COM ports](#)].

Because of it, the existing PLC connection cables cannot be used as they are. If you use the existing connection cables for GP-4401T, see [[4.5 Cable Diagram at the time of replacement](#)].

2.5.2 Auxiliary I/O Interface (AUX)

GP-4401T is not equipped with Auxiliary I/O Feature. External Reset Input and 3 Outputs (RUN Output, System Alarm Output, and External Buzzer Output) that can be used for GP-2400 series cannot be used.

2.5.3 Sound Output Interface (for GP-2400T only)

GP-4401T is not equipped with the sound output function. The sound output function for GP-2400T cannot be used.

2.5.4 CF Card Interface

GP-4401T is not equipped with a CF card slot. But a SD card slot and a USB interface are installed. In order to use the GP-2400 series data saved in the CF card and the functions using the CF card, use a SD card or a USB flash drive instead.

* When using a SD card with GP-4401T, please verify it supports the following specifications:

	File forma	Maximum capacity
SD	FAT16	2GB
SDHC	FAT32	32GB

For the GP-PRO/PBIII's "CF Card output folder" setting, if project file is converted on GP-Pro EX, the setting will automatically change to the one that uses a SD card. To change the setting of the output destination folder, see [[5.1 Changing the setting of the external media to use](#)].

2.6 Peripheral units and options

2.6.1 Barcode reader connection

GP-4401T is not equipped with a tool port. A barcode reader that used to be connected to the tool port on GP-2400 series cannot be used. However, GP-4401T allows you to connect a barcode reader on its USB interface (Type A) or its serial interface.

For the models GP-4401T supports, see [OtasukePro!] (http://www.pro-face.com/otasuke/qa/3000/0056_connect_e.html).

2.6.2 Printer Connection

GP-4401T is not equipped with Centronics (parallel) Interface for a printer though GP-2400 series is equipped with it. If the printer for GP-2400 series is used for GP-4401T, a converter that converts USB I/F on GP-4401T to Centronics I/F is required. And GP-4401T allows you to connect a printer on its USB port.

For the models GP-4401T supports, see [OtasukePro!] (http://www.pro-face.com/otasuke/qa/3000/0056_connect_e.html).

2.6.3 Expansion Unit

GP-4401T is not equipped with an expansion unit interface. The expansion unit (each kind of unit like CC-LINK Unit) for GP-2400 series cannot be used.

2.6.4 Isolation Unit

The isolation unit for GP-2400 series (CA2-ISOALL232-01, CA2-ISOALL422-01) cannot be used for GP-4401T. You can use the RS-232C isolation unit for GP-4401T (CA3-ISO232-01) instead.

2.7 Power Connector

The power connector on GP-4401T is a spring lock type. If you replace GP-2400 series with GP-4401T, change the power cable.

2.8 Backup Battery

Unlike GP-2400 series, GP-4401T does not use rechargeable secondary batteries but replaceable primary ones. (For both a rechargeable type and a replaceable one, contents to be backed up are the same.)

When the time for replacement of backup batteries approaches, the message to urge you to replace the battery, "RAAA053: Running out of power in the backup battery. Please change the battery." appears. When the message appears, replace the battery referring to the GP4000 series hardware manual.

Replaceable Battery Model
PFXZCBBT1

2.9 Power Consumption

The power consumption of GP-2400 series is different from that of GP-4401T.

GP-2400 series	GP-4401T
28W or less	12W or less

For the detailed electric specifications, see the hardware manual.

2.10 Materials/Colors of the body

The materials and the colors of GP-2400 series and GP-4401T are as follows:

	Color	Material
GP-2400T	Dark Gray	Resin
GP-2401T		
GP-4401T	Light Gray	Resin with glass

2.11 About Pro-Server

If the Pro-Server with Pro-Studio is used, please use the Pro-Server EX Ver.1.30 or later.

For details of the installation, refer to the

http://www.pro-face.com/otasuke/qa/server_ex/replace/.

2.12 Other Notes

- Do not expose GP4000 series to direct sunlight.
- Do not use GP4000 series outdoors.
- Do not turn on GP4000 series if condensation has occurred inside the device.
- When you are continuously using GP4000 series without oxygen, the brightness might decrease. Please ventilate the control panel periodically.

Chapter 3 Replacement Procedure

3.1 Work Flow

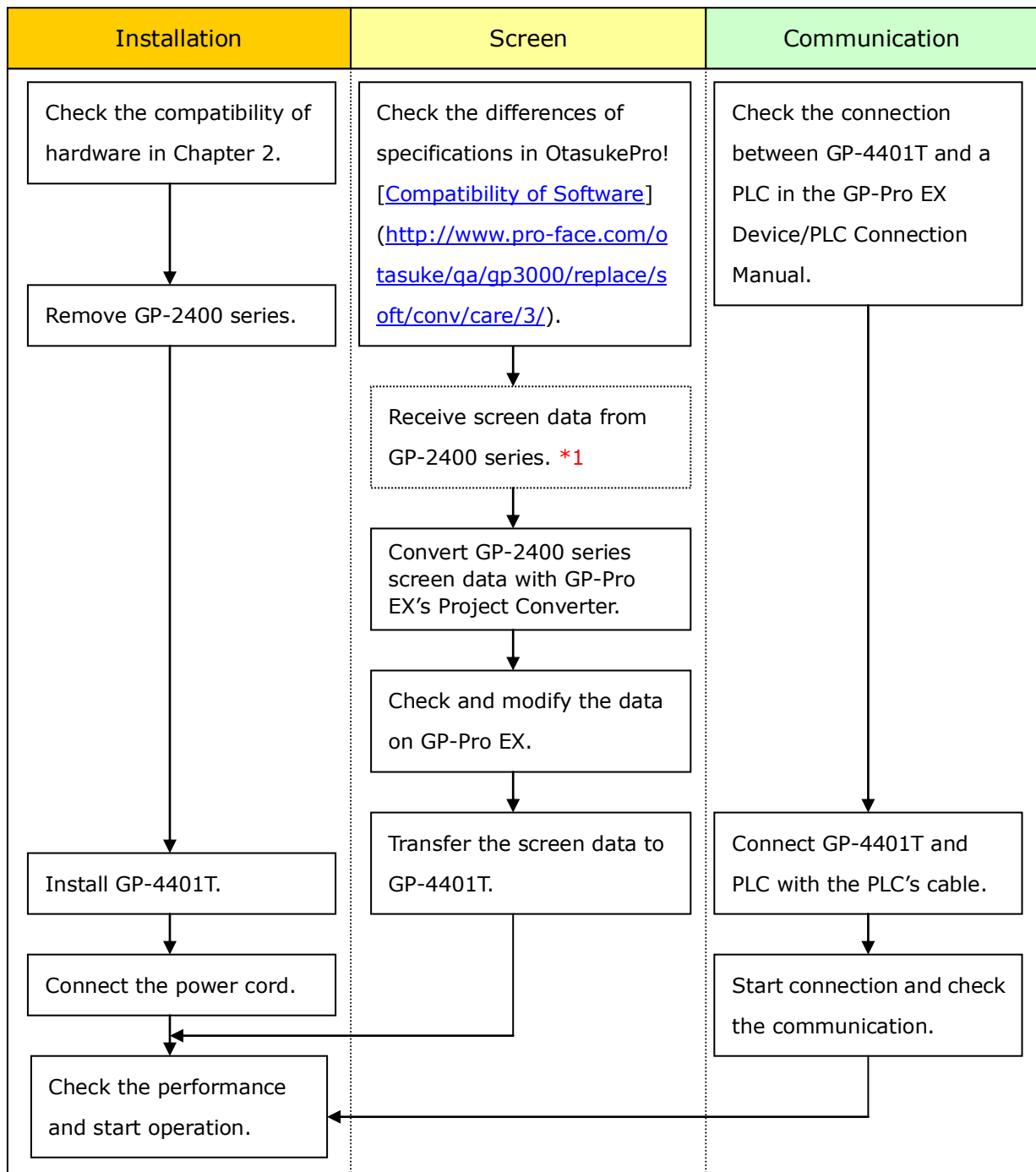

*1: This step is required if screen data is saved only in the GP unit, not in any other device.

3.2 Preparation

Requirements for receiving screen data from GP-2400 series. *1	GP-2400T: PC in which GP-PRO/PBIII for Windows V5.0 or later is installed. *2 GP- 2401T: PC in which GP-PRO/PBIII for Windows C-Package02 V6.3 or later is installed. *2
	Transfer Cable (The following three types of cables are available.) <ul style="list-style-type: none"> • GPW-CB02 (D-sub 9 pin to PC) • GPW-CB03 (USB to PC) *3 • GP430-CU02-M or GPW-SET (D-sub 25 pin to PC) *Possible to send/receive a screen via Ethernet (for GP-2400T only) or with a CF card.
Requirements for converting screen data of GP-2400 series and transferring the converted data to GP-4401T	PC in which GP-Pro EX Ver. 3.0 or later is installed
	Transfer Cable (The following three types of cables are available.) <ul style="list-style-type: none"> • A USB transfer cable (model: CA3-USBCB-01) • A USB data-transfer cable (model: ZC9USCBMB1) • A commercial USB cable (USB Type A/mini B) *Possible to send/receive a screen with a SD card, a USB storage device, or via Ethernet.

***1:** This step is required if screen data is saved only in the GP unit, not in any other device

***2:** Please use the same version or later as or than that of the software used during creating screens on GP-2400 series. If you don't know the version, we recommend you to use the newest version. The newest version is GP-PRO/PBIII for Windows C-Package03 (SP2) V7.29. Those who have GP-PRO/PBIII for Windows C-Package03 V7.0 can download it from our web site called [OtasukePro!] (<http://www.pro-face.com/otasuke/download/update/>).

***3:** GPW-CB03 is supported by GP-PRO/PBIII for Windows C-Package02 (SP2) V6.23 or later. You need to install a driver from [Download] on our Web site called [OtasukePro!] (<http://www.pro-face.com/otasuke/download/driver/>).

3.3 Receive screen data from GP-2400 series

This section explains, as an example, how to receive screen data from GP-2400 series using a transfer cable, GPW-CB02 or GPW-CB03. If you have backed up screen data, this step is unnecessary; skip to the next section [[3.4 Convert screen data with the Project Converter](#)].

(1) Connect a transfer cable to the GP-2400 series.

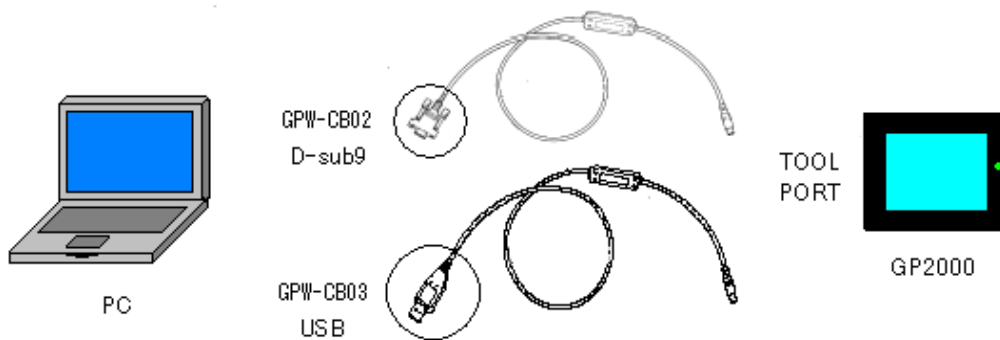

(2) Start up GP-PRO/PBIII for Windows and click the [Transfer] icon on the Project Manager (Specify a desired project file.)



(3) On the [Transfer] window, select the [Setup] menu and click [Transfer Settings.]

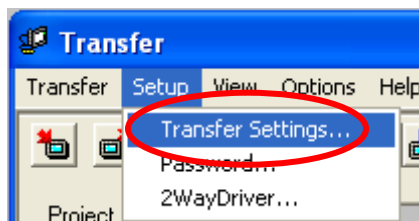

(4) In the Communication Port field, select [COM], specify the COM port to which the cable is connected, and click [OK].

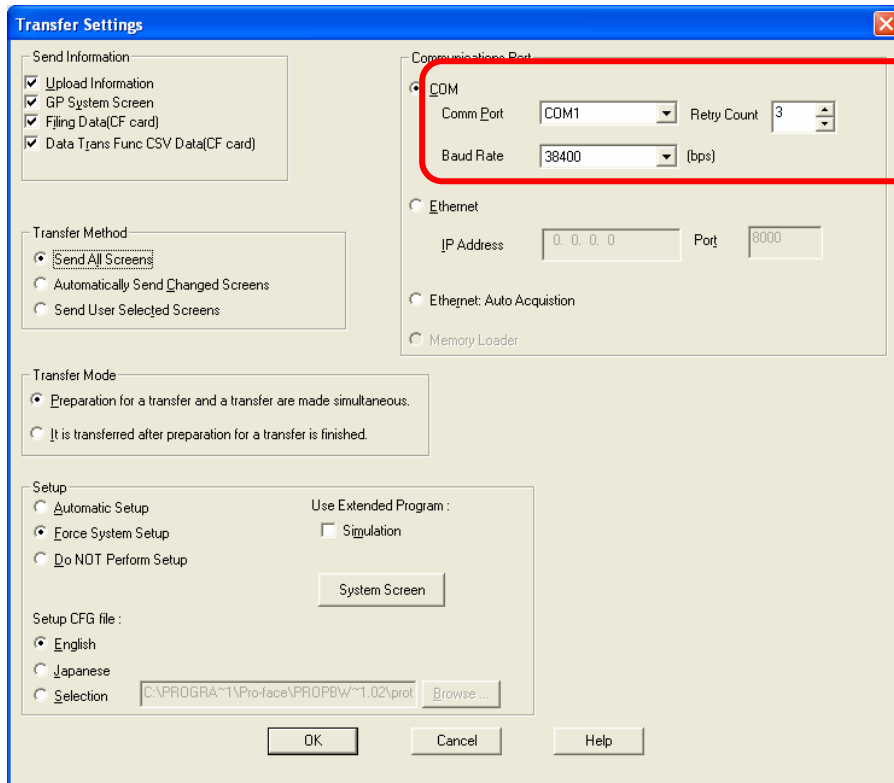

If you use a USB transfer cable (GPW-CB03)

You can check the COM port for the USB transfer cable (GPW-CB03), which is assigned to the PC, with the Device Manager of Windows.

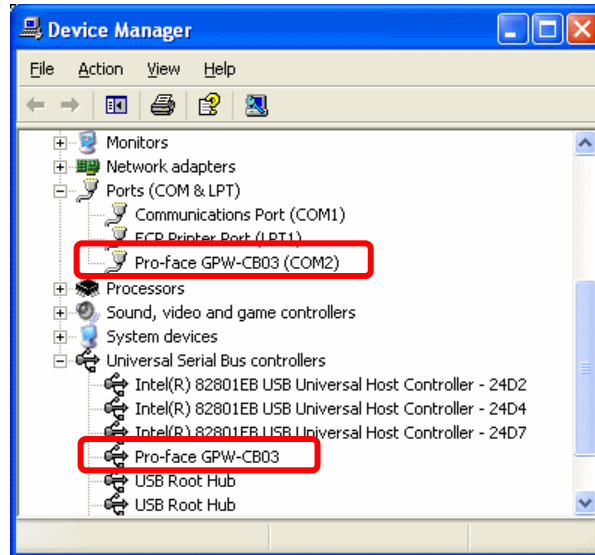

(5) Select the [Transfer] menu and click [Receive...].

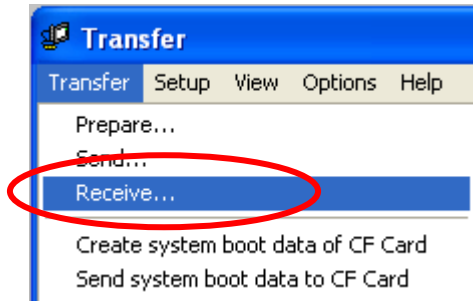

(6) Specify the location to save the received screen data at and the project file name and save them.

In case there is no Upload Information

“Upload Information” is necessary to receive screen data from GP-2400 series. It needs to be included in screen data when transferring screen data to the display unit beforehand. The Upload Information is sent to the display unit by default, however, you may check off the box of Upload Information to prevent screen reception by a third party.

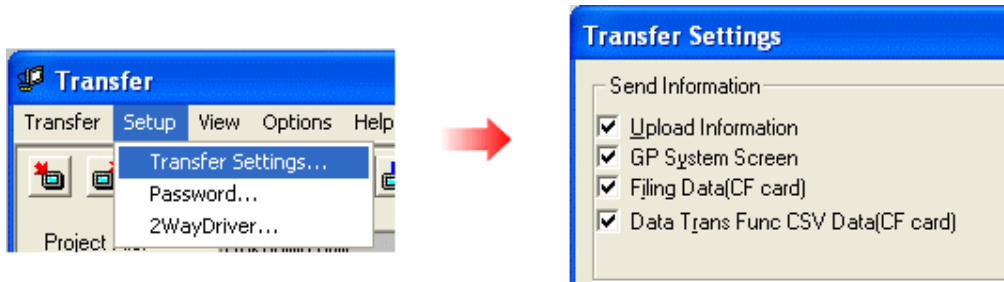

You can check in the following way if the Upload Information has been sent or not.

1. Enter into the GP's Offline mode.
2. If there are 2 asterisk (*) marks in the Main menu as shown below, the Upload Information has been sent.

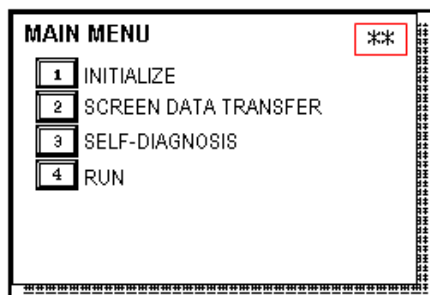

If not, there is no “Upload Information” sent. In this case, a message, which indicates there is no “Upload Information”, appears and you cannot receive the data.

3.4 Convert screen data with the Project Converter

Convert a project file (*.prw) for GP-2400 series with the GP-Pro EX's Project Converter.

- (1) Click the [Start] button, select [All Programs] (or [Programs])->[Pro-face]-> [GP-Pro EX *.**]->[Project Converter]
(For the [*.**] part, the version of the software you use is displayed.)

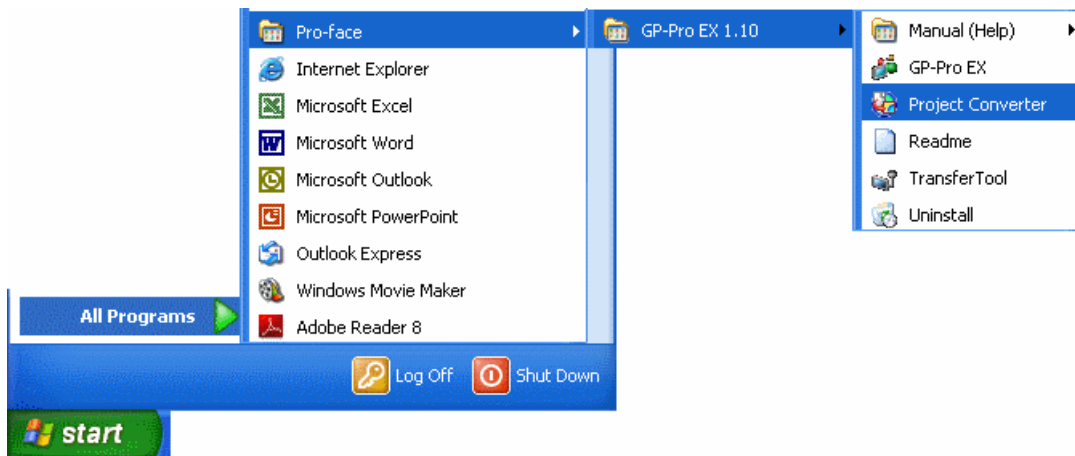

- (2) The Project Converter starts up and the [Project Converter] dialog box opens. Select [Project File (*.PRW)] in the [Data Type].

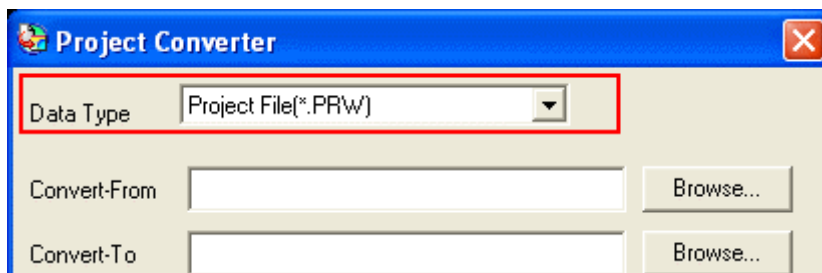

- (3) Click the [Browse...] button and select a project file (e.g.: "Project system A.prw"). Click [Open], and the file will be set in [Convert-From].

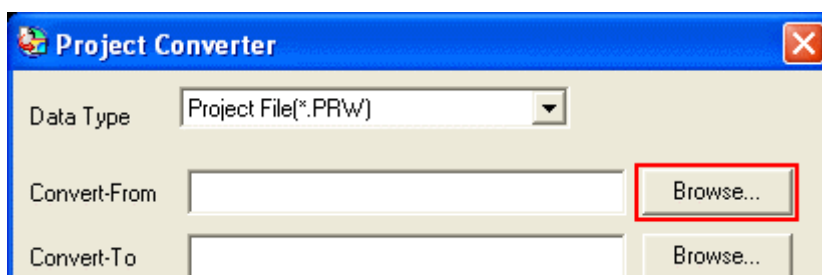

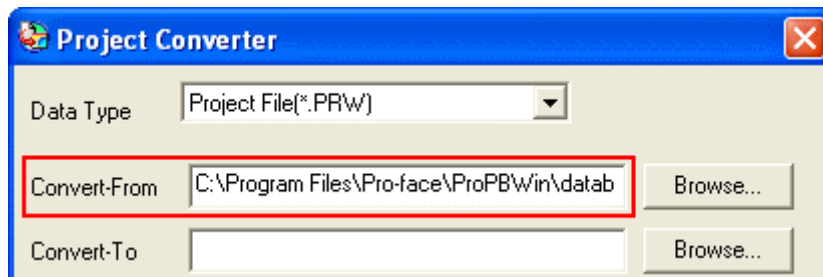
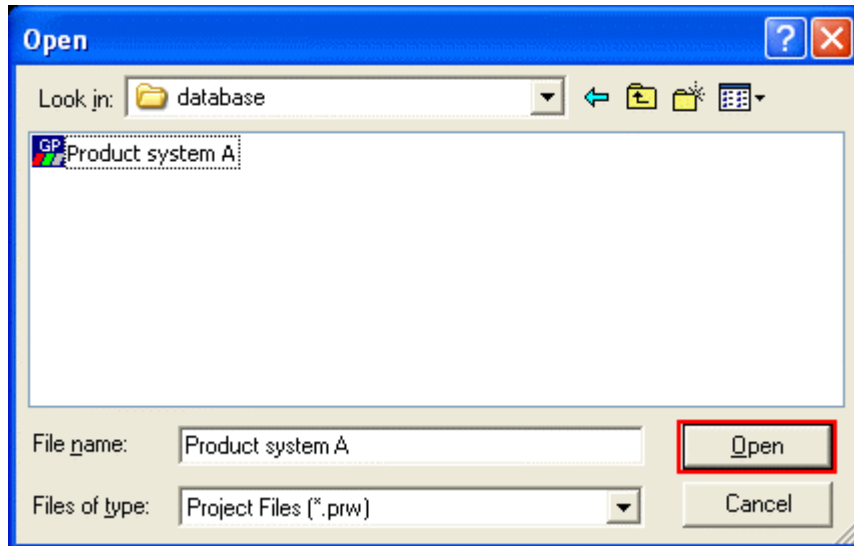

(4) In [Convert-To], designate a GP-Pro EX's project file (*.prx). Click the [Browse...] button and enter a new [File Name] (e.g.: "Product system A.prx"). Click [Save], and a new project file will be set to [Convert-To].

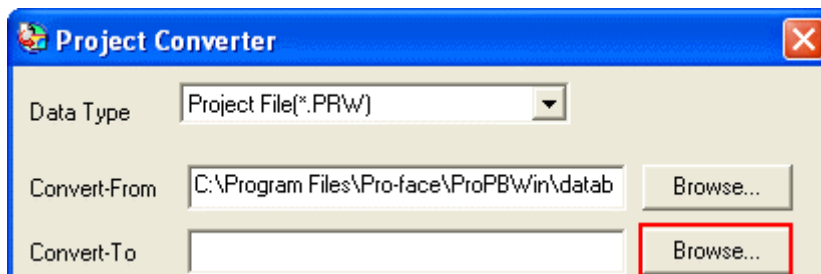

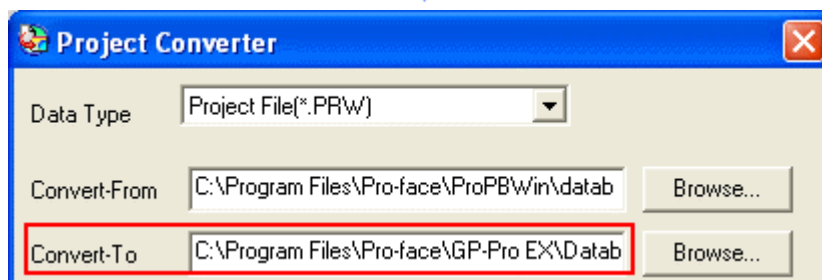
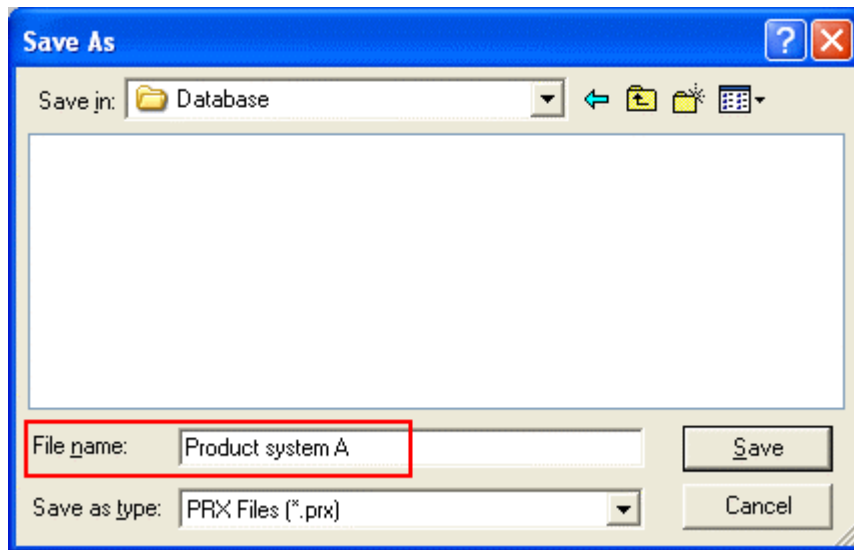

NOTE

When a convert-to file exists, the window that confirms whether or not to overwrite the file is displayed.

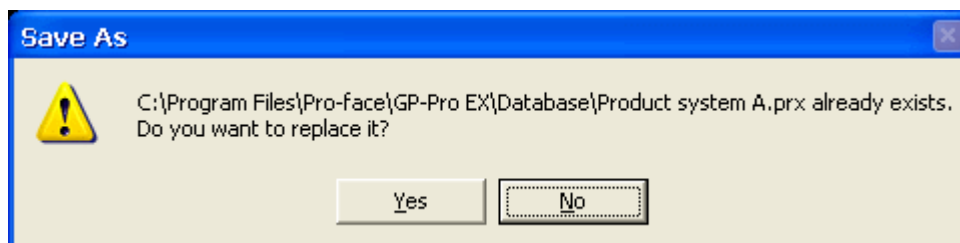

(5) Click [Convert] and start the conversion.

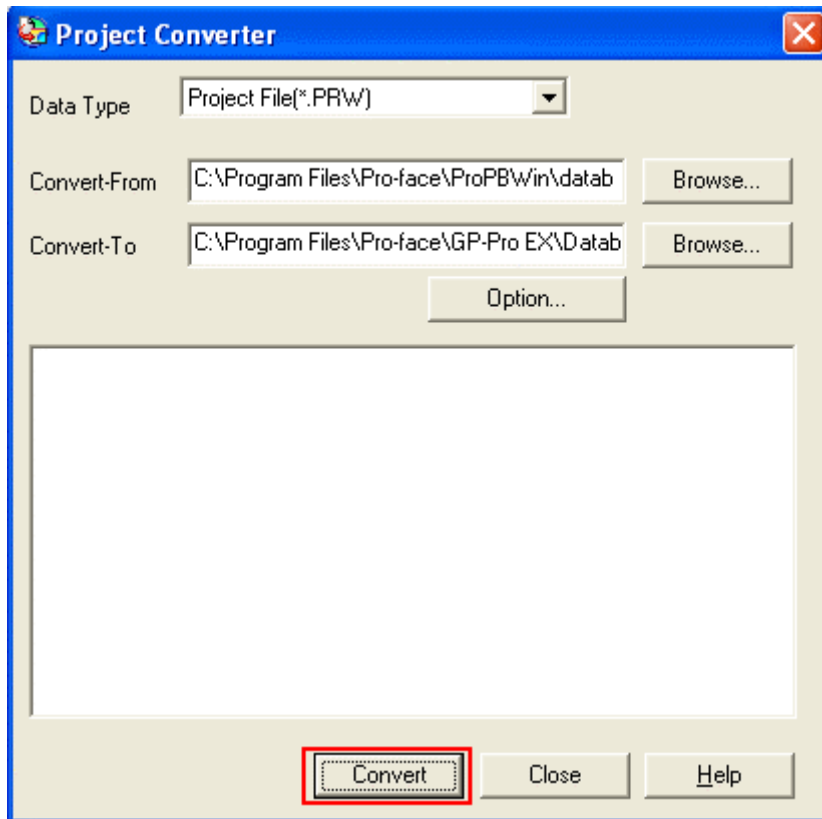

(6) If you are asked about the [Convert-To] type as shown below, select a replacement model's name on the pull-down menu. Click [OK].

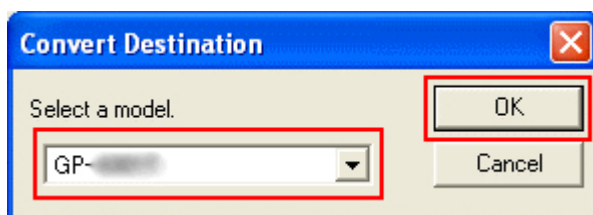

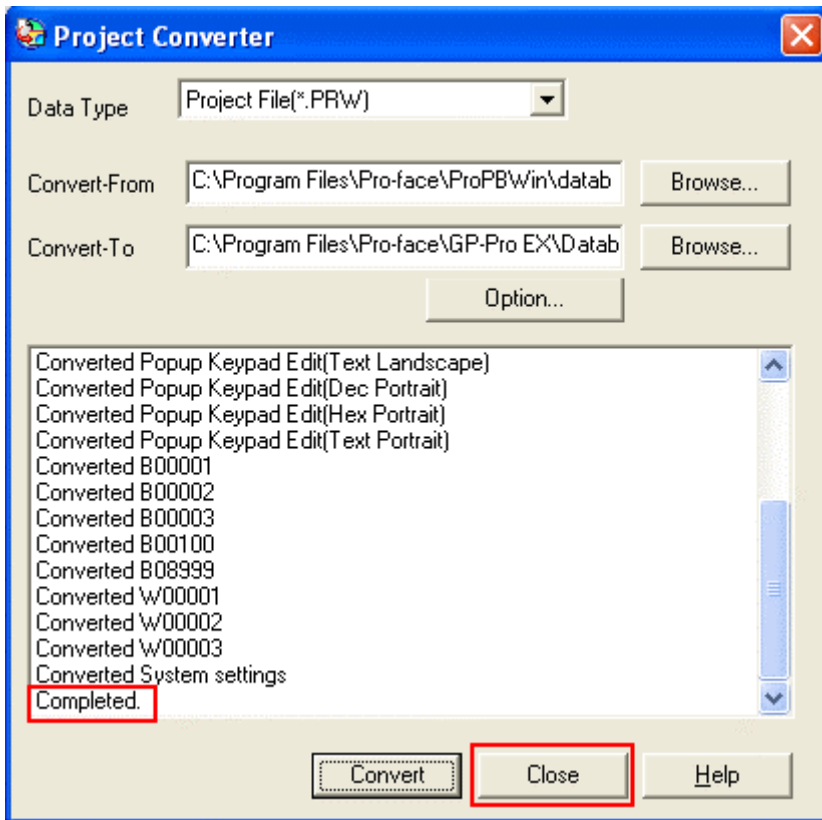

If an error message is displayed during conversion...

If an error message is displayed during conversion, refer to [[Project Converter Error Message](#)] (http://www.pro-face.com/otasuke/qa/gp3000/replace/soft/conv/project_converter_error.html) on our Web site called [OtasukePro!] for the cause and the solution.

NOTE

If the following dialog box appears, CF Card Output Folder setting is required. Please refer to [Convert GP-PRO/PBIII for Windows“Destination CF Card Folder”](#)

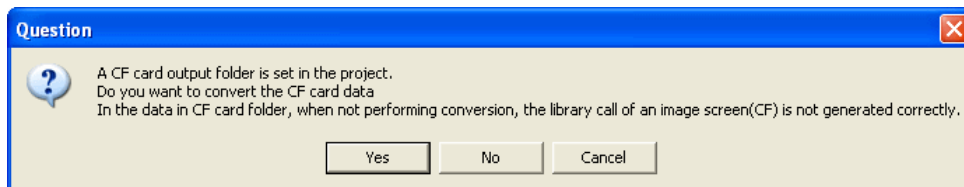

(7) After conversion, the [Save convert information] dialog box appears. If you click [Save], you can save the conversion information in a CSV file format.

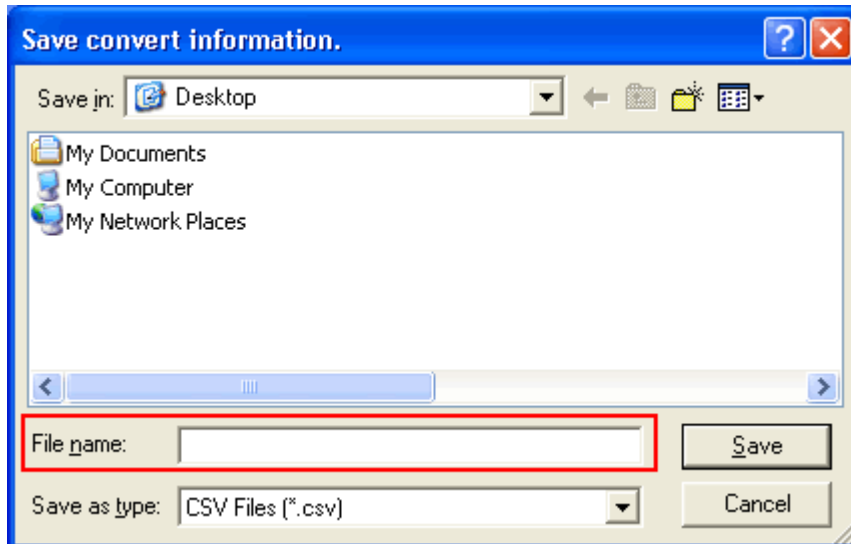

NOTE

Because the differences made at the time of conversion from GP-Pro/PBIII for Windows are described in the CSV saved file, the project file (*.prx) after conversion can be checked and modified according to the conversion information.

(8) Click [Close] to close the [Project Converter] dialog box.

If you double click the project file (*.prx) after conversion, GP-Pro EX will start and the file will open.

Convert GP-PRO/PBIII for Windows “Destination CF Card Folder”

If you convert a project file (*.prw) with a destination CF card folder designated in the step 6, the Question dialog box asking whether or not to designate the destination CF card folder for the convert destination appears again.

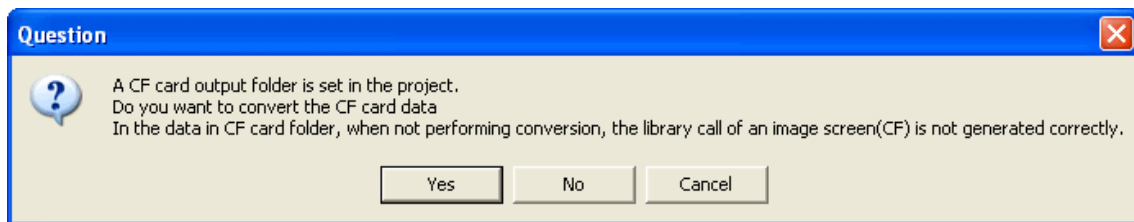

Select a folder (e.g.: “Database”) and click [OK].

If you click the [Make New Folder] button, you can create a new folder at any location.



IMPORTANT

- In the [Question] dialog box, be sure to select [Yes] and specify the destination folder. If you select [No], images will not be called correctly.
- GP-4401T that is a replacement model is not equipped with a CF card slot. If a destination folder is created in the work above, the CF card setting will be replaced with the SD card setting automatically. To check or change the destination folder setting, see [[5.1 Changing the setting of the external media to use](#)]

3.5 Transfer screen data to GP-4401T

Transfer the project file after conversion to GP-4401T.

You can transfer data to GP-4401T via

- A USB transfer cable (model: CA3-USBCB-01)
- A USB data transfer cable (model: ZC9USCBMB1)
- A commercial USB cable (USB Type A/mini B)
- A SD card/A USB storage device
- Ethernet

But this section explains, as an example, how to transfer screen data with a USB transfer cable (model: CA3-USBCB-01).



PC



USB transfer cable
(CA3-USBCB-01)



GP

- (1) Connect your PC and GP-4401T with a USB transfer cable (model: CA3-USBCB-01). If the driver of the cable has not been installed on your PC yet, a dialog box will appear. Please follow the instructions.

NOTE

- The "Hardware Installation" dialog box as shown below may appear during installing the USB driver depending on the security level of Windows® XP. Click [Continue Anyway] to start installing the driver. When installation is completed, click [Finish].

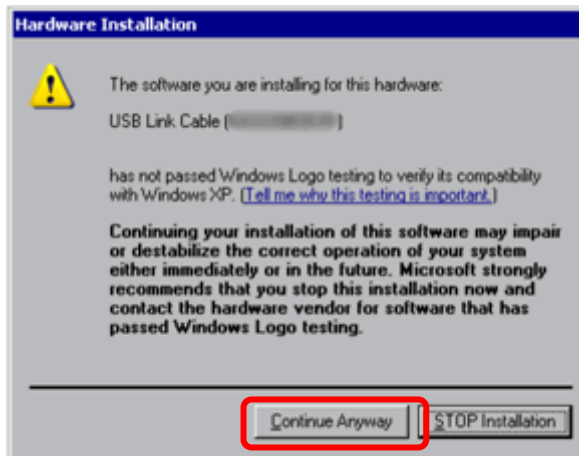

- If the following symptoms appear on Microsoft Windows® 7, go to updating "USB Data Transfer Driver" on [OtasukePro!] for download (http://www.pro-face.com/otasuke/download/update/proex/proex/v260/gpproex_usb_transfer.htm).
 - An error occurs when GP-Pro EX or Transfer Tool is installed
 - An error occurs when data is transferred via a USB transfer cable (model: CA3-USBCB-01).

- (2) Turn on the power of GP-4401T. The "Initial Start Mode" screen will appear on the display unit. After transferring a project file once, this screen will not appear again.



- (3) On the GP-Pro EX's State Toolbar, click the [Transfer Project] icon to open the Transfer Tool.

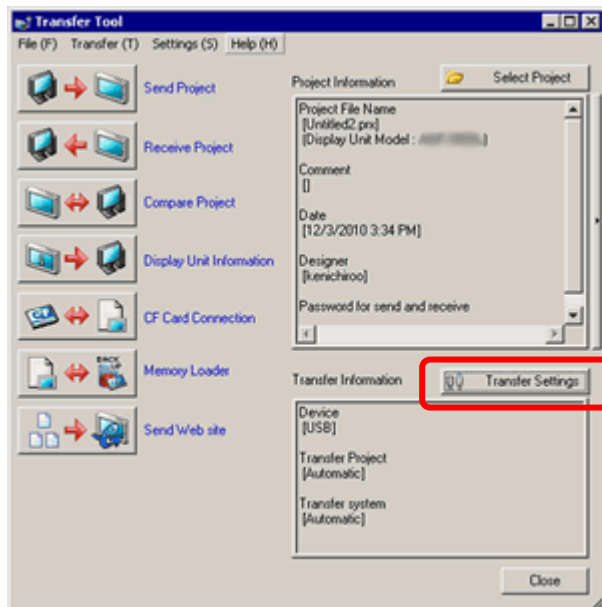

To transfer a different project file, click the [Select Project] button and select a project file.

- (4) Make sure that the [Device] in the "Transfer Settings Information" is set to [USB]. If not, click the [Transfer Setting] button to open the "Transfer Setting" dialog box. Select [USB] in the Communication Port Settings field and click [OK].



- (5) Click [Send Project] to start transfer. When the following dialog box appears, click [Yes]. This dialog box doesn't appear when the same project file is sent again.

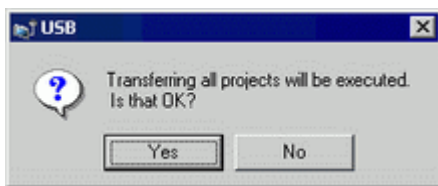

- (6) The following dialog box appears during transfer and you can check the communication status. (The display unit enters the Transferring mode and communication with the device such as a PLC is terminated.)

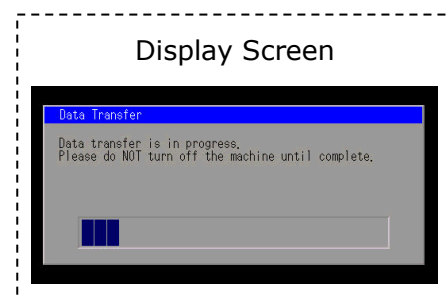
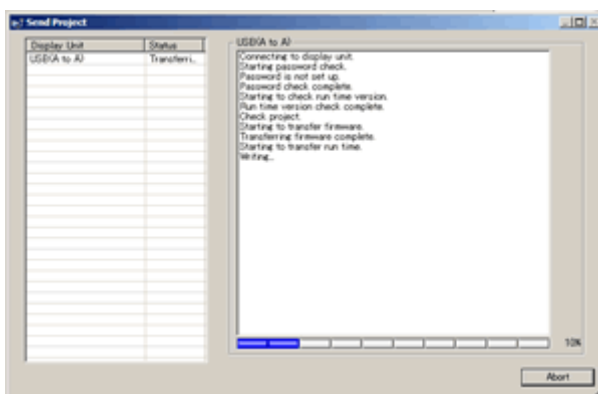

- (7) When transfer is completed, the status displayed in the dialog box will change from [Transferring] to [Complete Transfer]. Click [Close] to close the dialog box.

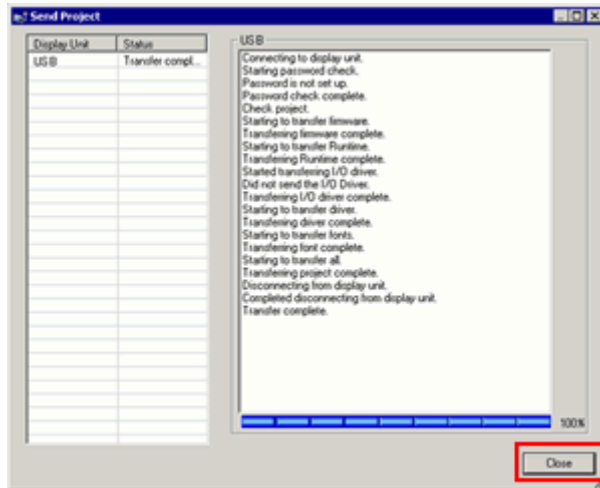

The display unit will be reset and a screen of the transferred project file will be displayed.

- (8) Close the Transfer Tool.
- (9) Click the [X] mark on top right of the screen or [Project]->[Exit] to close GP-Pro EX.

3.6 Differences of software

3.6.1 Differences after conversion

Check the differences of screen data after conversion from GP-PRO/PBIII to GP-Pro EX. For the details of each item, refer to our website,

<http://www.pro-face.com/otasuke/qa/gp3000/replace/soft/conv/care/3/>

Differences of Software

1	Touch Panel Type
2	Compatibility of Bit Switch
3	Compatibility of Alarm
4	Compatibility of Trend Graph
5	Compatibility of K tag (Input Order)
6	Compatibility of K tag (difference of Writing)
7	Compatibility of K tag (Indirect Setting)
8	Compatibility of N tag
9	Precautions for using the switch for [History Data Display] of Trend Graph on the window
10	About window display on a momentary switch during momentary operation
11	About the performance when a display area of the system window is overlapping
12	Change of Tag Process
13	About the display when a fixed Draw is placed on a Part
14	Compatibility of Text
15	Compatibility of Fill
16	Compatibility of CF Card Data
17	Precautions for conversion when filing data is saved in a CF card
18	Precautions for setting "Color Settings" to [256 Colors without blinking]
19	Precautions for loading a part with "L Tag (Library Display)"
20	Compatibility of MRK files and CPW files
21	Compatibility of V Tag/v tag and Video Screen
22	Compatibility of Extended SIO Script
23	Compatibility of Sound Data
24	Compatibility of Device Monitor

25	Compatibility of Ladder Monitor
26	Compatibility of J Tag and R Tag
27	Converting Screen Data of DOS
28	Compatibility of Standard Font
29	D Script starts right after screen change or power on. (Compatibility of D Script Trigger Condition)
30	The position shifts when loading a window screen (Compatibility of U Tag)
31	Precautions for using Screen Level Change
32	Compatibility of H tag

Chapter 4 Communication with Device/PLC

4.1 Driver list

More connectable drivers will be added.

For the devices/PLC each driver supports, see [Connectable Devices]
(<http://www.pro-face.com/product/soft/gpproex/driver/driver.html>).

4.2 Shapes of COM ports

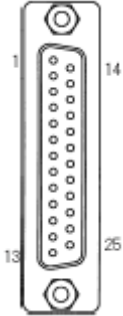
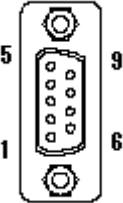
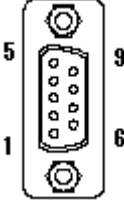
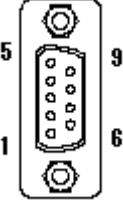
	GP-2400T	GP-2401T	GP-4401T
COM1	D-Sub 25 pin (socket) RS-232C/422		D-Sub 9 pin (plug) RS-232C
			
COM2	D-Sub 9 pin (plug) RS-232C	-	D-Sub 9 pin (plug) RS-422/485
		-	

NOTE

- For the COM ports of GP-2400 series and GP-4401T, the pin assignment and the shape of plug/socket connector are different. Because of it, the existing PLC connection cables cannot be used as they are. If you use the existing connection cables, see [\[4.5 Cable Diagram at the time of replacemet\]](#).
- Even though the both COM1 and COM2 ports on GP-2400T are used with RS-232C setting, only the COM1 port can be used for GP-4401T.

4.3 Signals of COM ports

4.3.1 Signals of COM1

For GP-2400 series

RS-232C or RS-422 (socket)

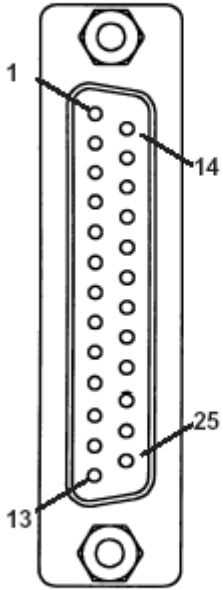
Pin Assignments	Pin #	Signal Name	Condition
<p>(D-Sub 25pin female)</p> <p>SIO</p> 	1	FG	Frame ground
	2	SD	Send data (RS-232C)
	3	RD	Receive data (RS-232C)
	4	RS	Request send (RS-232C)
	5	CS	Clear send (RS-232C)
	6	DR	Data Set Ready (RS-232C)
	7	SG	Signal ground
	8	CD	Carrier detect (RS-232C)
	9	TRMX	Termination (RS-422)
	10	RDA	Receive data A (RS-422)
	11	SDA	Send data A (RS-422)
	12	NC	No connection (Reserved)
	13	NC	No connection (Reserved)
	14	VCC	5V±5% output 0.25A
	15	SDB	Send data B (RS-422)
	16	RDB	Receive data B (RS-422)
	17	RI	Ring Indicate (RS-232C)
	18	CSB	Clear send B (RS-422)
	19	ERB	Enable receive B (RS-422)
	20	ER	Enable receive (RS-232C)
	21	CSA	Clear send A (RS-422)
	22	ERA	Enable receive A (RS-422)
	23	NC	No connection (Reserved)
	24	NC	No connection (Reserved)
	25	NC	No connection (Reserved)

For GP-4401T
RS-232C (plug)

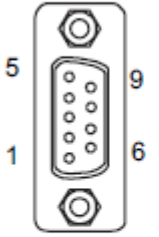
Pin Connection	Pin No.	RS-232C		
		Signal Name	Direction	Meaning
 <p>(GP unit side)</p>	1	CD	Input	Carrier Detect
	2	RD(RXD)	Input	Receive Data
	3	SD(TXD)	Output	Send Data
	4	ER(DTR)	Output	Data Terminal Ready
	5	SG	-	Signal Ground
	6	DR(DSR)	Input	Data Set Ready
	7	RS(RTS)	Output	Request to Send
	8	CS(CTS)	Input	Send possible
	9	CI(RI)/VCC	Input/-	Called Status Display +5V±5% Output 0.25A ^{*1}
	Shell	FG	-	Frame Ground (Common with SG)

*1: RI and VICC of Pin 9 are switched on the software.

VCC Output is not protected from overcurrent.

Please follow the current rating to avoid false operation or breakdown.

4.3.2 Signals of COM2

For GP-2400T

RS-232C

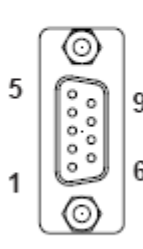
Pin Assignments	Pin No.	Signal Name	Signal Direction	Condition
(D-Sub 9pin male) 	1	CD	Input	Carrier detect (RS-232C)
	2	RD	Input	Receive data (RS-232C)
	3	SD	Output	Send data (RS-232C)
	4	ER	Output	Enable receive (RS-232C)
	5	SG	—	Signal Ground
	6	DR	Input	Data Set Ready (RS-232C)
	7	RS	Output	Request Send (RS-232C)
	8	CS	Input	Clear send (RS-232C)
	9	RIVCC	Input/Output	Ring Indicate (RS-232C) +5V+5% 0.25A

For GP-2401T

N/A

For GP-4401T

RS-422/485 (plug)

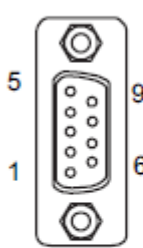
Pin Connection	Pin No.	RS-422/RS-485		
		Signal Name	Direction	Meaning
 (GP unit side)	1	RDA	Input	Receive Data A (+)
	2	RDB	Input	Receive Data B (-)
	3	SDA	Output	Send Data A (+)
	4	ERA	Output	Data Terminal Ready A (+)
	5	SG	-	Signal Ground
	6	CSB	Input	Send Possible B (-)
	7	SDB	Output	Send Data B (-)
	8	CSA	Input	Send Possible A (+)
	9	ERB	Output	Data Terminal Ready B (-)
	Shell	FG	-	Frame Ground (Common with SG)

4.4 Multilink Connection

For GP-4401T, some communication drivers do not support multi-link connection (n:1) via RS-422. When converting the project file with the setting of the communication driver that does not support multi-link connection (n:1) via RS-422, the connection is automatically converted to (1:1).

For the communication drivers that support serial multi-link, see [[Which drivers support serial multilink communication?](#)]

(http://www.pro-face.com/otasuke/files/manual/gpproex/new/device/com_mlnk.htm).

4.5 Cable Diagram at the time of replacement

The connection cable for GP-2400 series can be used for GP-4401T.

But please note that there are precautions and restrictions as described below.

IMPORTANT

- Please check the connection configurations GP-4401T supports with GP-Pro EX Device/PLC Connection Manual before using a connection cable.
(<http://www.pro-face.com/otasuke/files/manual/gpproex/new/device/index.htm>)
- **The Siemens MPI connection cable** cannot be used.
Please refer to the above-mentioned GP-Pro EX Device/PLC Connection Manual and prepare a connection cable for GP-4401T newly.

4.5.1 When using a RS-232C connection cable,
 GP-2400 series System Configuration (connecting to **COM1**)

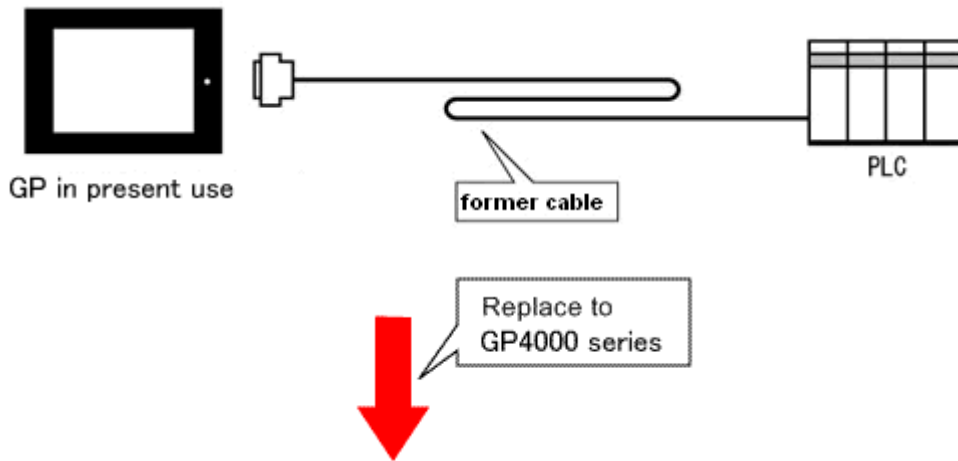

GP-4401T System Configuration (connecting to **COM1**)

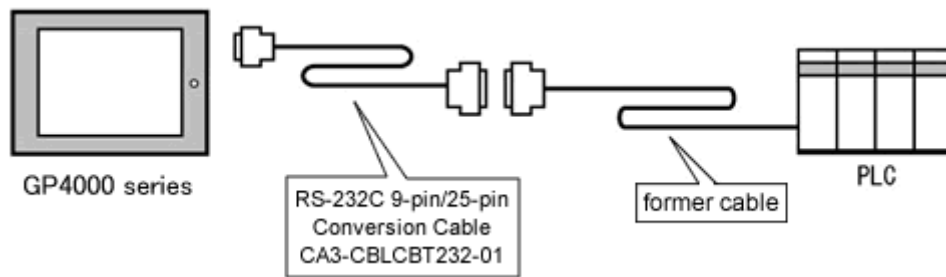

To replace GP-2400 series with GP-4401T, prepare the following item.

Product Name	Model
RS-232C 9-pin/25-pin Conversion Cable (20cm)	CA3-CBLCBT232-01

* For GP-2400T only:

GP-2400T System Configuration (connecting to **COM2**)

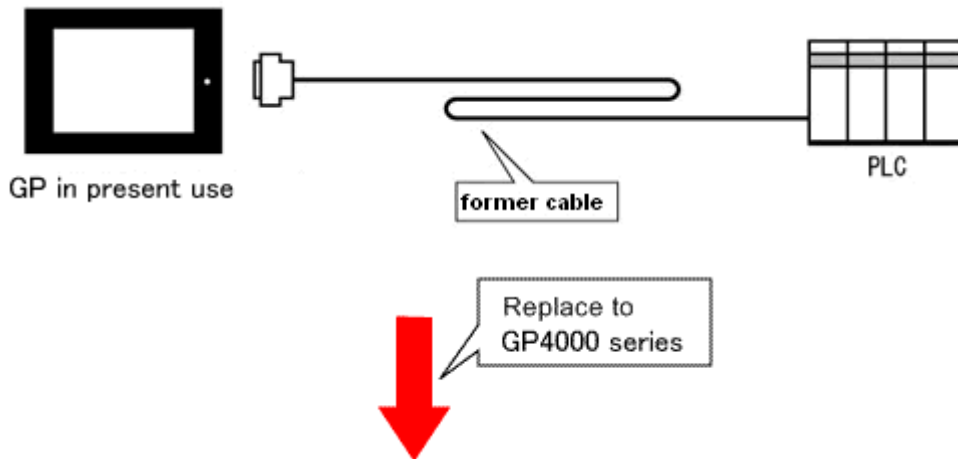

GP-4401T System Configuration (connecting to **COM1**)

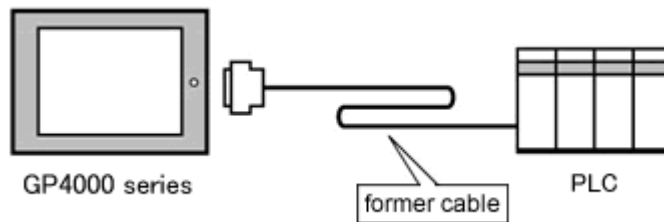

*The same cable can be used.

IMPORTANT

- Even though the both COM1 and COM2 ports on GP-2400T are used with RS-232C setting, only the COM1 port can be used for GP-4401T.
- When the settings for the both COM1 and COM2 ports are configured for GP-2400T, the settings for the COM2 port are not converted on GP-Pro EX. If you still need the settings of the COM2 port for GP-2400T, add Device/PLC setting from [System Settings] on the [Project] menu of GP-Pro EX.

4.5.2 When using a RS-422 connection cable,
 GP-2400 series System Configuration (connecting to **COM1**)

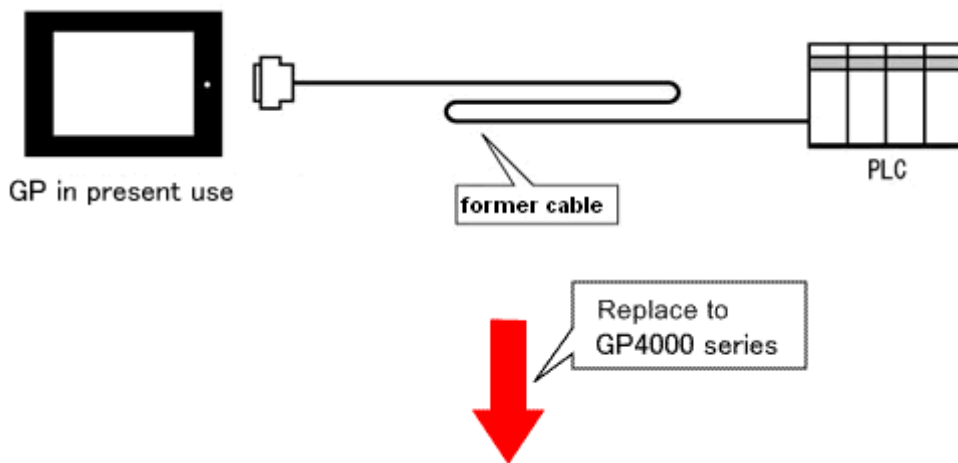

GP-4401T System Configuration (connecting to **COM2**)

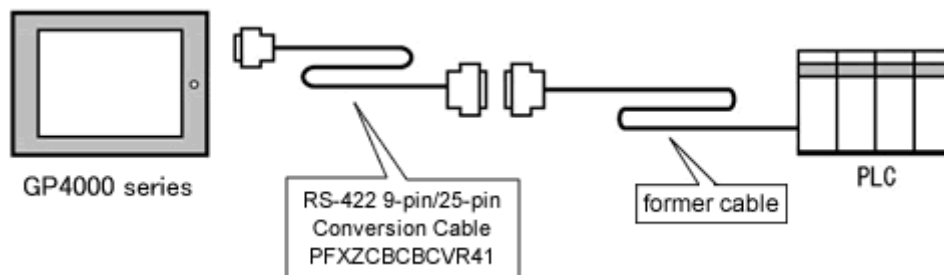

IMPORTANT

Before connecting to GP-4401T, be sure to change the port setting to [**COM2**] on Device/PLC Setting of GP-Pro EX. Please check the communication setting with GP-Pro EX Device/PLC Connection Manual just in case.

(<http://www.pro-face.com/otasuke/files/manual/gpproex/new/device/index.htm>)

To replace GP-2400 series with GP-4401T, prepare the following item.

Product Name	Model
RS-422 9-pin/25-pin Conversion Cable (20cm)	PFXZCBCBCVR41

NOTE

When using a terminal block adapter (GP070-CN10-O), we recommend you to replace it with a terminal block conversion adapter (PFXZCBADTM1) for GP-4401T.

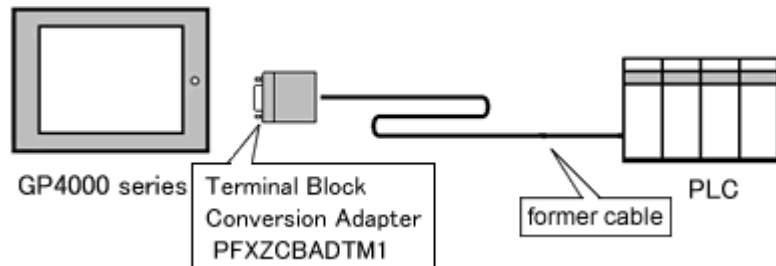

For replacement in this connection method, prepare the following item.

Product Name	Model
Terminal Block Conversion Adapter	PFXZCBADTM1

Chapter 5 Appendix

5.1 Changing the setting of the external media to use

If a CF card has been used for GP-PRO/PBIII, after GP-2400 series is replaced with GP-4401T with GP-Pro EX, "a CF card" is automatically replaced with "a SD card" for the external media setting.

- (1) After conversion of the project file data, at GP-Pro EX Error Check, if the message, "The project contains features that require a SD card. However, the selected display does not support SD cards so these features will not run." appears,

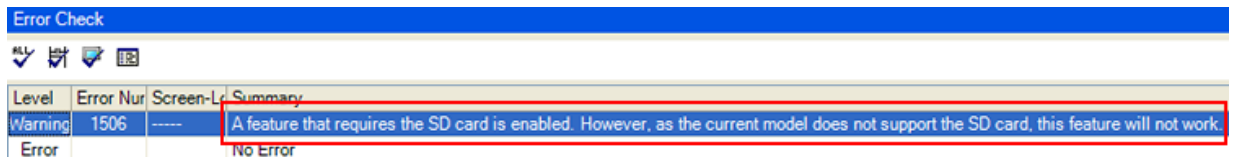

Level	Error Num	Screen-L	Summary
Warning	1506	----	A feature that requires the SD card is enabled. However, as the current model does not support the SD card, this feature will not work.
Error			No Error

<Cause>

The model without a SD card slot has the setting that uses a SD card.

-> [Solution 1](#)

- (2) To use a USB storage device instead of a SD card -> [Solution 1](#)

- (3) To check or change the SD card's data output destination folder setting

-> [Solution 2](#)

[Solution]

1. Change the SD Card setting to the USB storage setting following the steps below.

<Procedure>

- i. Click [Project]->[Information]->[Destination Folder].
- ii. Uncheck "Enable SD Card" and check "Enable USB Storage."

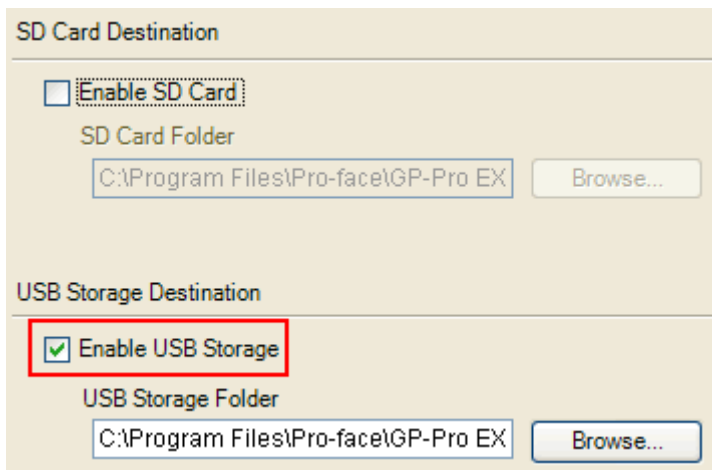

iii. Click the [Browse] button and specify a destination folder.

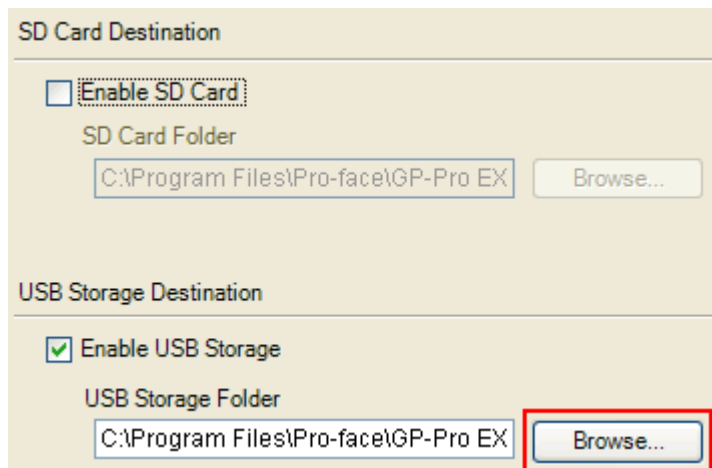

- iv. Click [OK] to confirm the setting.
- v. Click [Project]->[Save] to save changes.
- vi. Check each function that uses the CF card and replace the setting of [SD Card] with the one of [USB Storage].

NOTE

- To see how the tags or the parts of GP-PRO/PBIII for Windows are replaced on GP-Pro EX, refer to [OtasukePro!] (<http://www.pro-face.com/>)
"Feature Comparison between GP-PRO/PBIII and GP-Pro EX"
(<http://www.pro-face.com/otasuke/qa/gp3000/replace/soft/conv/care/3/compare.htm>)
- To check each function setting of GP-Pro EX, refer to GP-Pro EX Reference Manual.

2. Check and change the destination folder setting following the steps below.
 - i. Click [Project]->[Information]->[Destination Folder].
 - ii. The current setting is displayed.

The screenshot shows a dialog box titled "SD Card Destination" and "USB Storage Destination". The "SD Card Destination" section has an unchecked checkbox for "Enable SD Card" and a text field for "SD Card Folder" containing "C:\Program Files\Pro-face\GP-Pro EX" with a "Browse..." button next to it. The "USB Storage Destination" section has a checked checkbox for "Enable USB Storage" and a text field for "USB Storage Folder" containing "C:\Program Files\Pro-face\GP-Pro EX" with a "Browse..." button next to it.

- iii. After changing it, click [OK] to confirm the setting.
- iv. Click [Project]->[Save] to save changes.