

Easy! Smooth!
GP2000H Series
Replacement Guidebook

Preface

This guidebook introduces the procedures to replace the unit in the GP2000H series (GP-2401HT, GP-2301HS/L) with the GP3000H series (GP-3310HT, GP-3300HS/L). The recommended replacement models are as follows:

Model in use	Replacement model
GP-2401HT	GP-3310HT
GP-2301HS	GP-3300HS
GP-2301HL	GP-3300HL

About the order model number of the GP3000H Series

Emergency Switch and Key Switch are options. When ordering a GP3000H unit, please confirm the model number.

Model no.

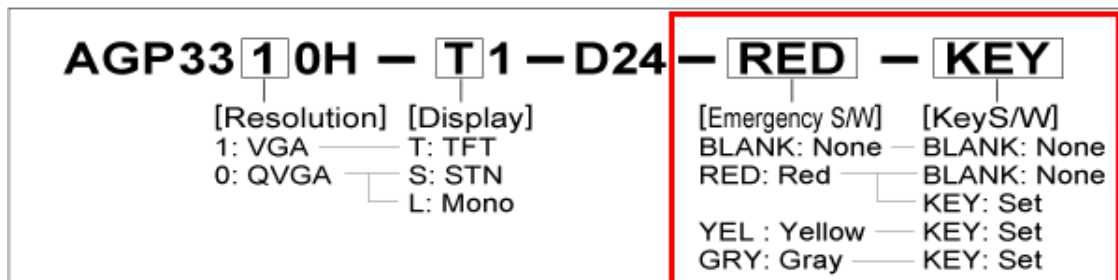

Safety Information

HAZARD OF OPERATOR INJURY, OR UNINTENDED EQUIPMENT DAMAGE

Before operating any of these products, be sure to read all related manuals thoroughly.

Failure to follow these instructions can result in death, serious injury or unintended equipment damage.

5th Edition: Jan 2015



Table of Contents

<u>PREFACE</u>	2
<u>ABOUT THE ORDER MODEL NUMBER OF THE GP3000H SERIES</u>	2
<u>CHAPTER 1. SPECIFICATION COMPARISON</u>	5
1.1 SPECIFICATIONS OF GP-2401HT AND GP-3310HT	5
1.2 SPECIFICATIONS OF GP-2301HS/L AND GP-3300HS/L	6
<u>CHAPTER 2. COMPATIBILITY OF HARDWARE</u>	7
2.1 LOCATIONS OF INTERFACES	7
2.2 SCREEN SIZE	8
2.3 TOUCH PANEL SPECIFICATIONS	8
2.4 VIBRATION FUNCTION	8
2.5 FUNCTION SWITCH	8
2.6 GP-H70 COMPATIBILITY MODE	8
2.7 KEY SWITCH	8
2.8 EXTERNAL OUTPUT INTERFACE	8
2.9 BARCODE READER CONNECTION	9
2.10 SCREEN DATA TRANSFER	9
2.11 OPTIONAL PRODUCTS	9
2.12 CONNECTION TO HOST CONTROLLER	9
2.13 OVERSEAS STANDARDS	10
2.14 ABOUT PRO-SERVER	11
<u>CHAPTER 3. REPLACEMENT PROCEDURE</u>	12
3.1 WORK FLOW	12
3.2 PREPARATION	14
3.3 RECEIVE SCREEN DATA FROM THE GP2000H SERIES	15
3.4 CONVERT SCREEN DATA WITH THE PROJECT CONVERTER	18
3.5 DIFFERENCES OF SOFTWARE AFTER CONVERSION	24
3.6 TRANSFER SCREEN DATA TO THE GP3000H SERIES	25
<u>CHAPTER 4. COMMUNICATION WITH DEVICE/PLC</u>	29

4.1 DRIVER LIST	29
4.2 DIFFERENCES OF SYSTEM STRUCTURES	32
4.2.1 SYSTEM STRUCTURE BEFORE REPLACEMENT (GP2000H SERIES)	32
4.2.2 WORK FLOW OF REPLACEMENT OF GP2000H WITH GP3000H	33
4.2.3 SYSTEM STRUCTURE AFTER REPLACEMENT (GP3000H SERIES)	34
4.2.3.1 STRUCTURE 1	34
4.2.3.2 STRUCTURE 2	35
4.2.3.3 STRUCTURE 3	36
4.2.3.4 STRUCTURE 4	37
4.2.3.5 STRUCTURE 5	38
4.2.3.6 STRUCTURE 6	41
4.3 MULTILINK CONNECTION	44
APPENDIX 1 SIGNALS OF CABLES (TO HOST, NO CONNECTOR)	45
A.1.1 GP2000H SERIES SPECIAL PURPOSE RS-232C CABLE (GP2000H-C232-3M/10M)	45
A.1.2 GP2000H SERIES SPECIAL PURPOSE RS-422 CABLE (GP2000H-C422-3M/10M)	46
A.1.3 GP3000H HARD-TYPE DIRECT-CONNECT CABLE (GP3000H-CBLH-10M) GP3000H SOFT-TYPE DIRECT-CONNECT CABLE (GP3000H-CBLS-3M/5M/10M)	47
APPENDIX 2 INTERFACES OF CONVERSION ADAPTERS	49
A.2.1 GP-H70 RS-232C CONVERSION ADAPTER (GPH70-AP232-O)	49
A.2.2 GP-H70 RS-422 CONVERSION ADAPTER (GPH70-AP422-O)	50
A.2.3 GP2000H SERIES RS-232C CONVERSION ADAPTER (GP2000H-AP232)	51
A.2.4 GP2000H SERIES RS-422 CONVERSION ADAPTER (GP2000H-AP422)	53
A.2.5 GP3000H CONVERSION ADAPTER (AGP3000H-ADPCOM-01)	55





Chapter 1. Specification Comparison

1.1 Specifications of GP-2401HT and GP-3310HT

		GP-2401HT	GP-3310HT
			
Display Type		TFT color LCD	
Display Colors		256 colors	UP! 65,536 colors
Display Resolution		VGA (640×480 pixels) → See 2.2	
External Dimensions (Unit: mm [in.])		W253[9.96]×H185[7.28]×D58[2.28] (When including the Emergency Switch: D76[2.99])	W224[8.82]×H174[6.85]×D87.1[3.43] (When including the Emergency Switch: D107.5[4.23])
Touch Panel Type		Matrix	NEW! Resistive Film (Analog) → See 2.3
Memory	Application	2MB	UP! 8MB
	SRAM	128KB	UP! 320KB
Serial Interface		RS-232C/422	UP! RS-232C/422/485
Ethernet Interface		10BASE-T	UP! 10BASE-T/100BASE-TX
Vibration		Yes	No → See 2.4
Function Switch		15 switches	11 switches → See 2.5
3-Position Enable Switch Output Interface		Rear panel switch 3-position output → See 2.6	
Emergency Switch Output Interface		Push-lock switch *1	
Key Switch Output Interface		No	NEW! Yes → See 2.7
External Output Interface		Yes → See 2.8	
CF Card Interface		Yes	
USB Host Interface		No	NEW! Yes
Printer Interface		No	NEW! USB → See 2.8

*1: Emergency Switch is an option. For details, please refer to [\[About the order model number of the GP3000H Series\]](#).

1.2 Specifications of GP-2301HS/L and GP-3300HS/L

		GP-2301HS/L	GP-3300HS/L
			
Display Type	GP-****HS	STN color LCD	
	GP-****HL	Monochrome LCD	
Display Color	GP-****HS	64 colors	UP! 4,096 colors
	GP-****HL	2 levels / 8 levels	UP! 16 levels
Display Resolution		QVGA (320 × 240 pixels)	
External Dimensions (Unit: mm [in.])		W253[9.96]×H185[7.28]×D58[2.28] (When including the Emergency Switch: D76[2.99])	W224[8.82]×H174[6.85]×D87.1[3.43] (When including the Emergency Switch: D107.5[4.23])
Touch Panel Type		Matrix	NEW! Resistive film (Analog) → See 2.3
Memory	Application	1MB	UP! 6MB
	SRAM	128KB	UP! 320KB
Serial Interface		RS-232C/422	UP! RS-232C/422/485
Ethernet Interface		No	UP! 10BASE-T/100BASE-TX
Vibration		Yes	No → See 2.4
Function Switch		11 switches	
3-Position Enable Switch Output Interface		Rear panel switch 3-position output → See 2.6	
Emergency Switch Output Interface		Push-lock switch *1	
Key Switch Output Interface		No	NEW! Yes → See 2.7
External Output Interface		Yes → See 2.8	
CF Card Interface		Yes	
USB Host Interface		No	NEW! Yes
Printer Interface		No	NEW! USB → See 2.8
Overseas Standards			 → See 2.13

*1: Emergency Switch is an option. For details, please refer to [\[About the order model number of the GP3000H Series\]](#).

Chapter 2. Compatibility of Hardware

2.1 Locations of interfaces

Locations of connectors and switches on the GP2000H series and the GP3000H series are as follows:

GP2000H (2401H)

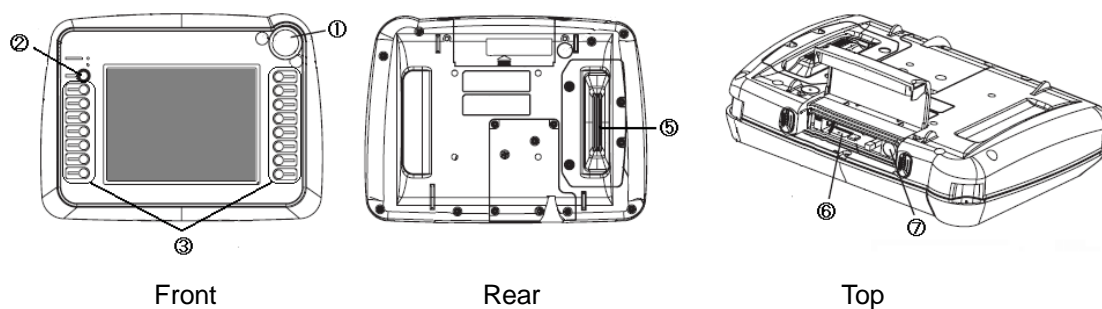

GP3000H (3310H)

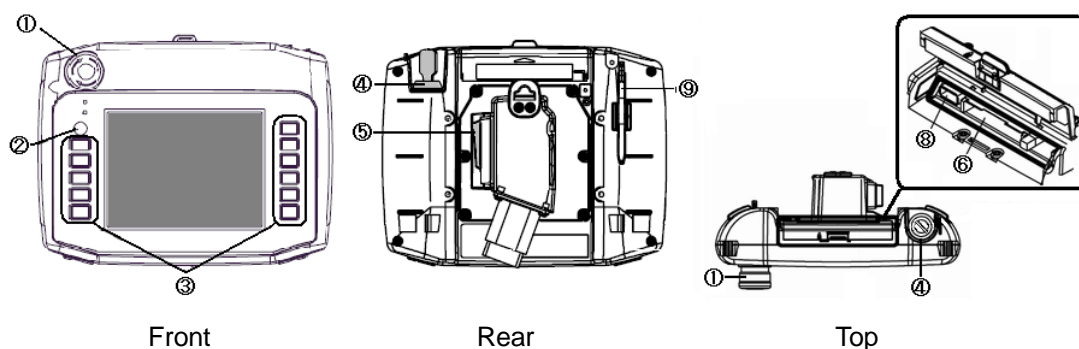

Interface names

	GP2000H Series	GP3000H Series
1	Emergency Switch *1	
2	Operation Switch	
3	Function Switches	
4	-	Key Switch
5	3-Position Enable Switch	
6	CF Card Interface	
7	Tool Connector	-
8	-	USB Host Interface
9	-	Touch Pen

*1: Emergency Switch is an option. For details, please refer to [\[About the order model number of the GP3000H Series\]](#).

2.2 Screen size

The screen size of GP-3310HT, which is 5.7 inches, is smaller than that of GP-2401HT (6.5 inches). However, its display resolution is same.

Displays of texts, parts, etc. become smaller after conversion. If they are too small to touch with your finger, please use the provided touch pen.

2.3 Touch panel specifications

The GP3000H series units are analog resistive. An analog resistive touch panel does not recognize the touch input when you touch two points at the same time. If you applied the two-point touch input on the GP2000H unit, we recommend you change to the one-point touch input using the switch delay function.

2.4 Vibration function

The GP3000H series doesn't have the vibration function. Please aware of it when converting project data. If you use the vibration function in the GP2000H series, change it to another function as necessary.

2.5 Function switch

The GP-2401HT has 15 function switches. However, the GP-3310HT has only 11 switches, as the GP3000H series is designed lightweight. Please aware of it when converting project data.

2.6 GP-H70 Compatibility Mode

The GP3000H series doesn't have the GP-H70 Compatibility Mode. The operation switch and the 3-Position Operation Switch on the rear operate in the GP2000H Mode.

For the details of the GP2000H Mode and the GP-H70 Compatibility Mode, refer to GP2000H Series User Manual "3.3.3 2000H Mode / GP-H70 Compatibility Mode."

2.7 Key switch

In case of setting up an external circuit (an emergency stop circuit) using the Key switch, the GP3000H series allows you to remove it from the conversion adapter without stopping the system.

However, to use the Key switch, the GP3000H conversion adapter (AGP3000H-ADPCOM-01) and the GP3000H cable with a connector (GP3000H-CBL*D- * M) are required. The Key switch is disabled when the GP2000H conversion adapter (GP2000H-AP***) is used.

2.8 External output interface

To use the DOUT, Operation Switch Output, or External Buzzer Output, the GP3000H Conversion Adapter (AGP3000H-ADPCOM-01) is required. These interfaces are disabled when the GP2000H conversion adapter (GP2000H-AP***) is used.

2.9 Barcode reader connection

The GP3000H units are not equipped with a tool port. A barcode reader connected from the tool port on the GP2000H unit cannot be used with the GP3000H. However, the GP3000H series allows you to connect a barcode reader on its USB interface.

2.10 Screen data transfer

To transfer screen data to the GP3000H unit, use a USB or Ethernet cable to transfer screen data. For USB transfer, use a transfer cable for the GP3000 series (model: CA3-USBCB-01). Please note that any commercial USB cable cannot be used.

Transfer cables (GPW-CB02, GPW-CB03, GP430-CU02-M) that are used via the tool port cannot be used with the GP3000H series.

2.11 Optional products

Optional products for the GP3000H series are different from those for the GP2000H series, other than the neck strap (model: GP2000H-STRAP11). For the GP3000H series, prepare the followings as necessary:

- ◆ Screen Protection Sheet (GP3000H-DFS6-01)
Disposable, dirt-resistant sheet for the GP unit's screen (5 sheets/set, hard type)
- ◆ Wall Adapter Attachment (GP3000H-WMA-01)
Bracket for mounting the GP3000H series unit to a commercially available arm or panel.
- ◆ Touch Pen (CA7-TPPEN/ALL-01)
Pen for screen operation (5 pens/set, 1 pen is provided in the package.)
- ◆ Hand Strap (GP3000H-HS-01)
Strap for hanging GP3000H by hand (1 strap is provided in the package.)
- ◆ Emergency Switch Guard (GP3000H-EMGD11)
Guard for preventing accidental operation. Includes 3 mounting screws. (1 guard is provided in the package.)
- ◆ Function Switch Sheet (1 set is provided in the package.)

2.12 Connection to host controller

For replacement of the GP2000H with the GP3000H, you may need to rewire. For the details, see [4.2 Differences of system structures](#).

2.13 Overseas standards

The GP2000H series and GP3000H series conform to the following standards:

	UL	c-UL (CSA)	CE
GP2000H Series	UL60950 Third edition (Safety Standard for Information Technology Equipment)	CAN/CSA-C22.2 No. 60950-00 (Standard for Safety of Information Technology Equipment)	EN55011 Class A and EN61000-6-2
GP3000H Series	UL508 (Safety Standard for Industrial Control Equipment) *	CAN/CSA-C22.2 No.142-M1987 (c-UL approval) (Industrial Control Equipment)	

* The following system design is UL approved.

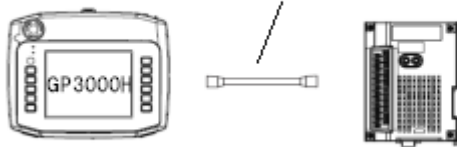
UL approved system structure using a conversion adapter	
GP3000H Series	<p>▼ The GP3000H unit in the following structure conforms to UL508:</p> <p>GP3000H Soft/Hard-type Direct-connect cable (GP3000H-CBL*D-*m)</p>  <p>GP3000H Conversion Adapter (AGP3000H-ADPCM-01)</p>

NOTE

The system structure using a GP3000H series unit + a GP3000H cable + a GP2000 conversion adapter is not UL508 listed. If you need it UL508 approved, the application shall be made at your end. For the detailed documents of the product, contact the nearest Pro-face office.

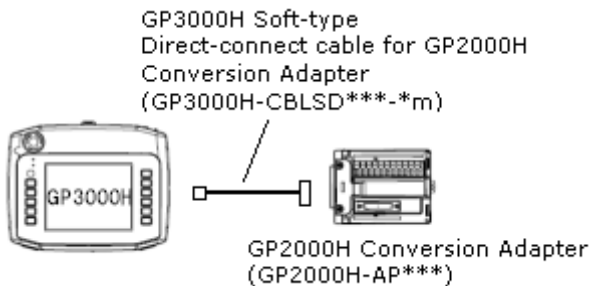

2.14 About Pro-Server

If the Pro-Server with Pro-Studio is used, please use the Pro-Server EX Ver.1.30 or later. For details of the installation, refer to the http://www.pro-face.com/otasuke/qa/server_ex/replace/.

Chapter 3. Replacement Procedure

3.1 Work Flow

- ◆ To change the equipment designed for the GP2000H series to the GP3000H series

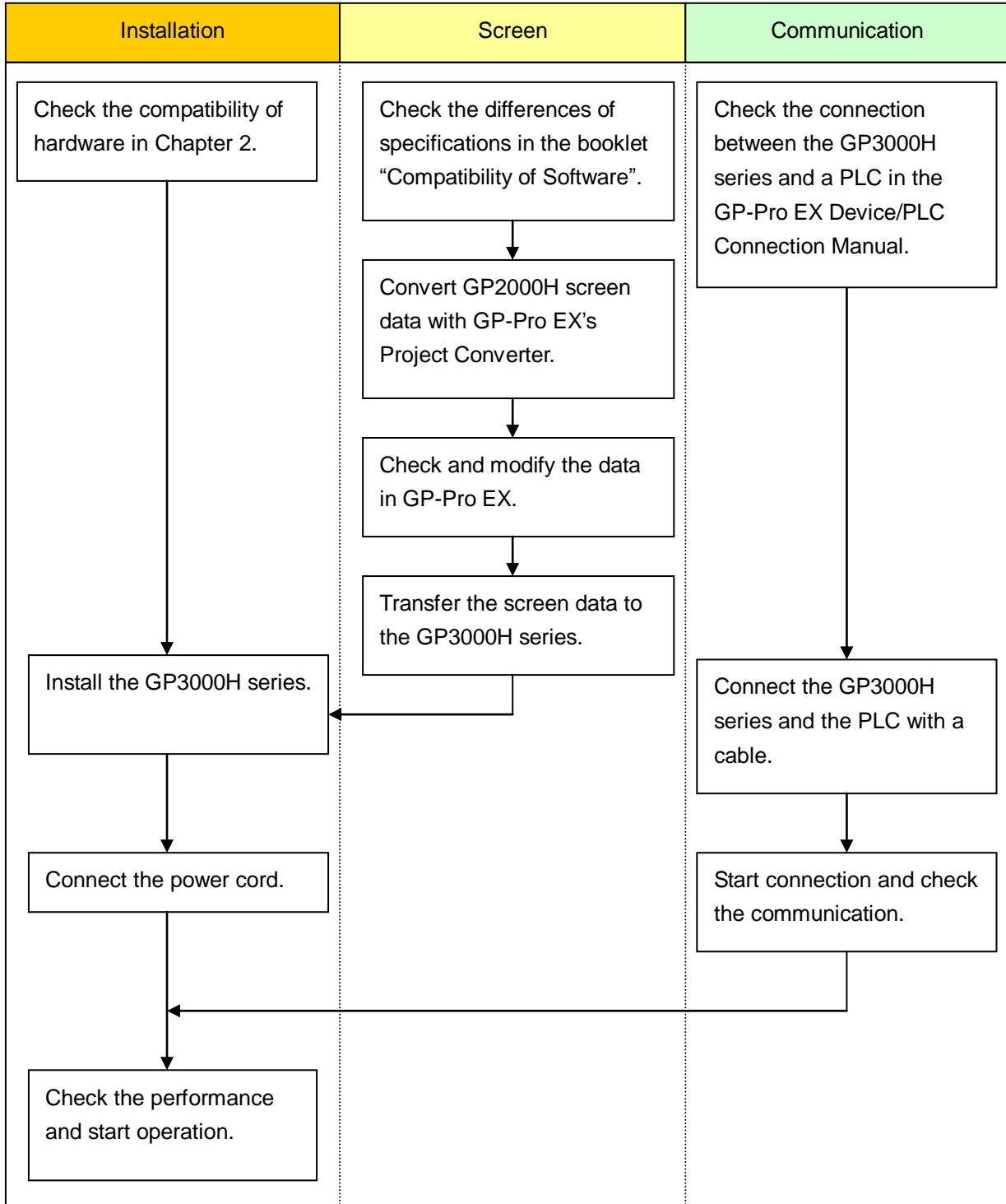

- ◆ To replace the 2000H series mounted to the equipment with the 3000H series

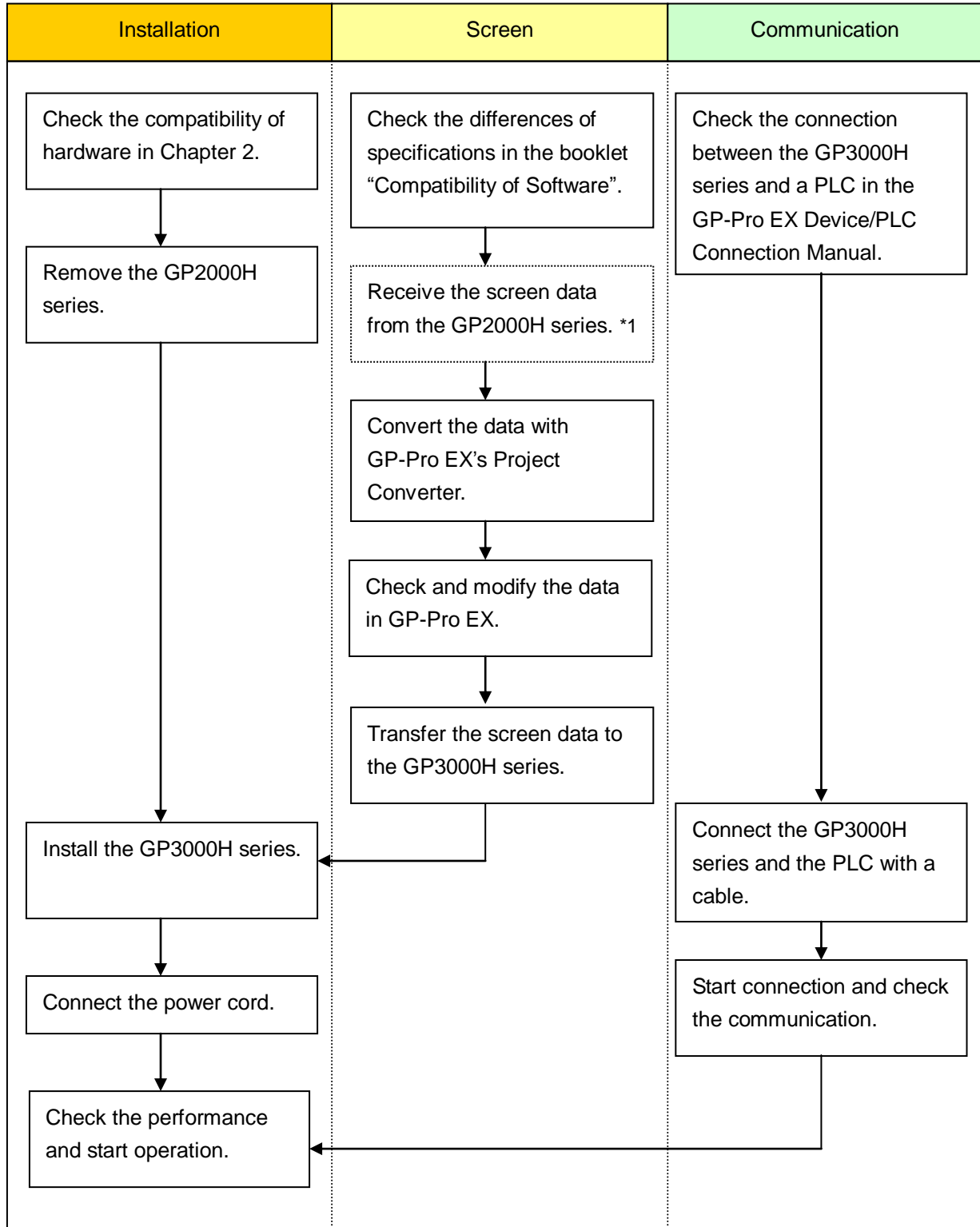

*1 This step is required if screen data is saved only in the GP unit, not in any other device.

3.2 Preparation

Requirements for receiving screen data from the GP2000H series *1	PC in which GP-PRO/PB3 for Windows V.6.01 or later is installed Note: The software version must be the same or higher than the version that you used when creating screen data for the GP2000H series. We recommend you upgrade to the latest version, which is Ver. 7.29 as of June 2009.
	Transfer cable (the following three types of cable are available) <ul style="list-style-type: none"> ▪ GPW-CB02 (9-pin D-sub to the PC) ▪ GPW-CB03 (USB to the PC) (*2) ▪ GP430-CU02-M or GPW-SET <p>The GP2000H series also allows you to transfer screen data via a CF card.</p>
Requirements for converting screen data of the GP2000H series and transferring to the 3000H series	PC in which GP-Pro EX is installed
	Transfer cable (model: CA3-USBCB-01) The GP3000H series also allows you to transfer screen data via an Ethernet cable, CF card, or USB flash drive.

*1: This step is required if screen data is saved only in the GP unit, not in any other device.

*2: GPW-CB03 is compliant with GP-PRO/PB3 for Windows C-Package02 SP2 Ver. 6.23 or later.

To use it, you may need to [install the driver](#).

Go to our support website [Otasuke Pro!](#)

-> Download

-> Updates/Drivers

-> GP-PRO/PB3: USB Data Transfer Cable (GPW-CB03)

3.3 Receive screen data from the GP2000H series

This section explains, as an example, how to receive screen data from the GP unit using a transfer cable GPW-CB02 or GPW-CB03. If you have backed up screen data, this step is unnecessary; slip to the next section “3.4 Convert screen data with the Project Converter.”

1. Connect a transfer cable to the GP2000H series.

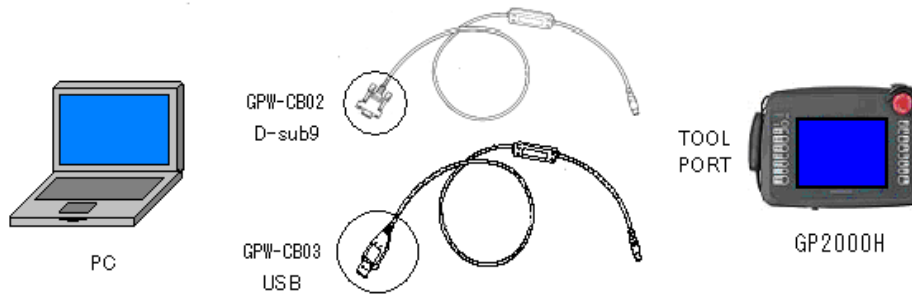

2. Start up GP-PRO/PB3 C-Package and click the [Transfer] icon on the Project Manager. (Specify a desired project file.)



3. On the [Transfer] window, select the [Setup] menu and click [Transfer Settings...].

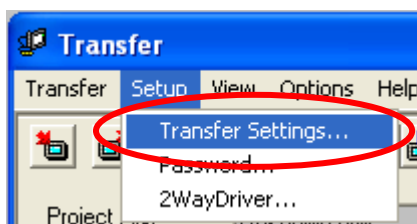

4. In the Communication Port field, select [COM], specify the COM port to which the cable is connected, and click [OK].

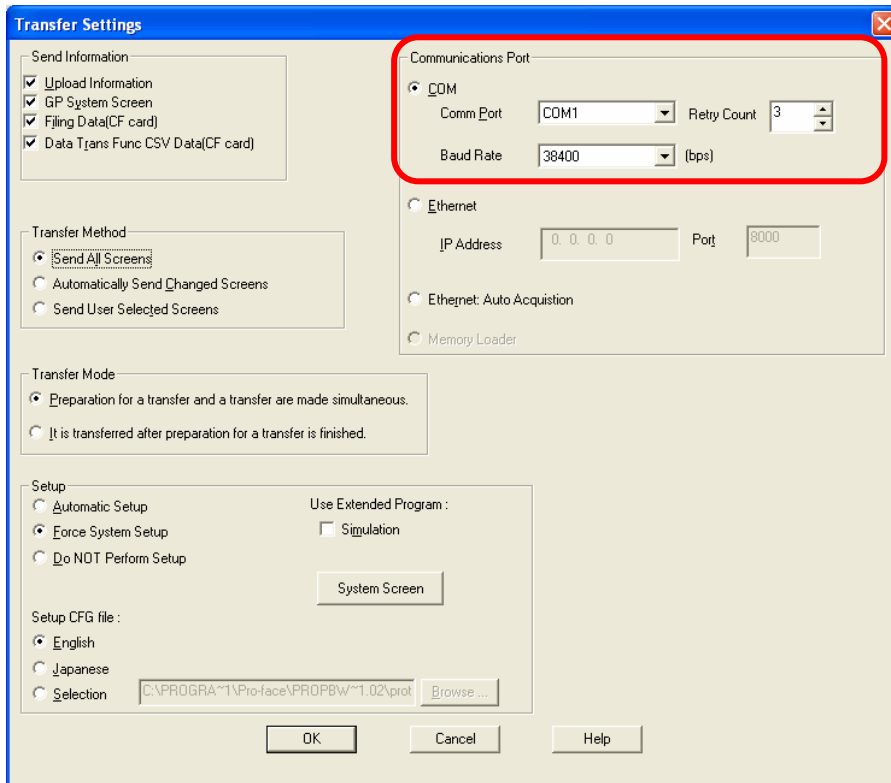

If you use a USB transfer cable (GPW-CB03)...

You can check the COM port for the USB transfer cable (GPW-CB03), which is assigned to the PC with the Device Manager of Windows.

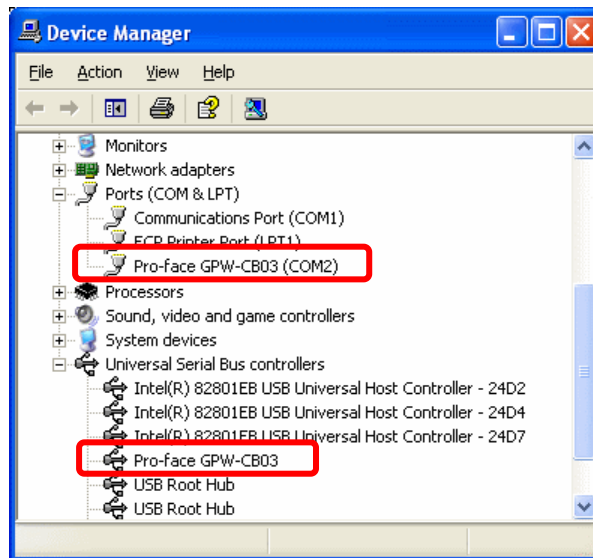

5. Select the [Transfer] menu and click [Receive...].

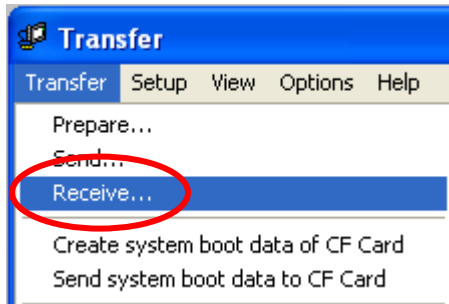

6. Specify the location to save the received screen data in and the project file name and save.

In case there is no Upload Information...

“Upload Information” is necessary to receive screen data from the display unit. It needs to be included in screen data when transferring screen data to the display unit beforehand. The Upload Information is sent to the display unit by default, however, you may check off the box of Upload Information to prevent screen reception by a third party.

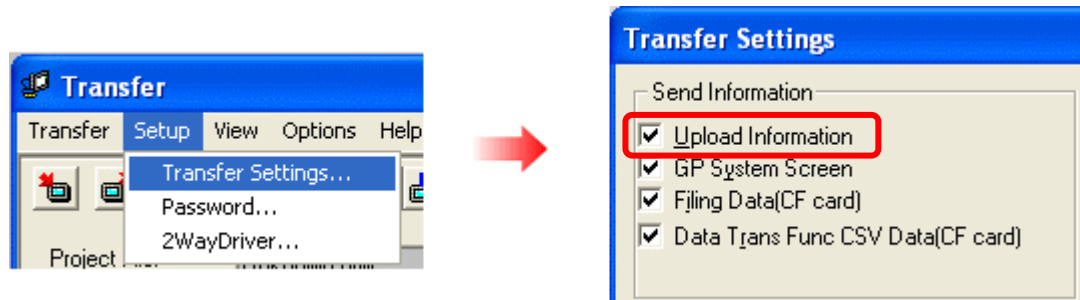

In this case, a message, which indicates there is no Upload Information,” appears and you cannot receive the data.

You can check if the Upload Information has been sent or not in the following way.

Enter into the GP’s Offline mode. If there are 2 asterisk (*) marks in the Main menu as below, the Upload Information has been sent. If not, there is no Upload Information sent.

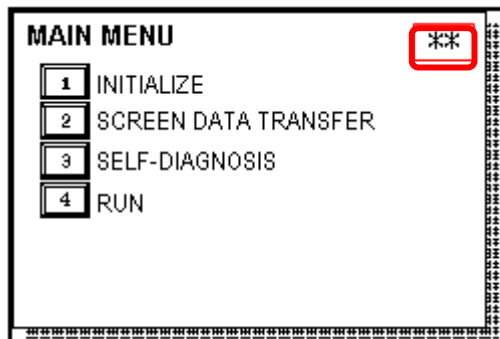

3.4 Convert screen data with the Project Converter

Convert a project file (*.prw) for the GP-37W2 unit with the GP-Pro EX's Project Converter.

1. Click the [Start] button, select the [All Programs] ([Programs] on Windows® 2000 menu → [Pro-face] → [GP-Pro EX*.**]. (Where *.** is the version of the software you use.)

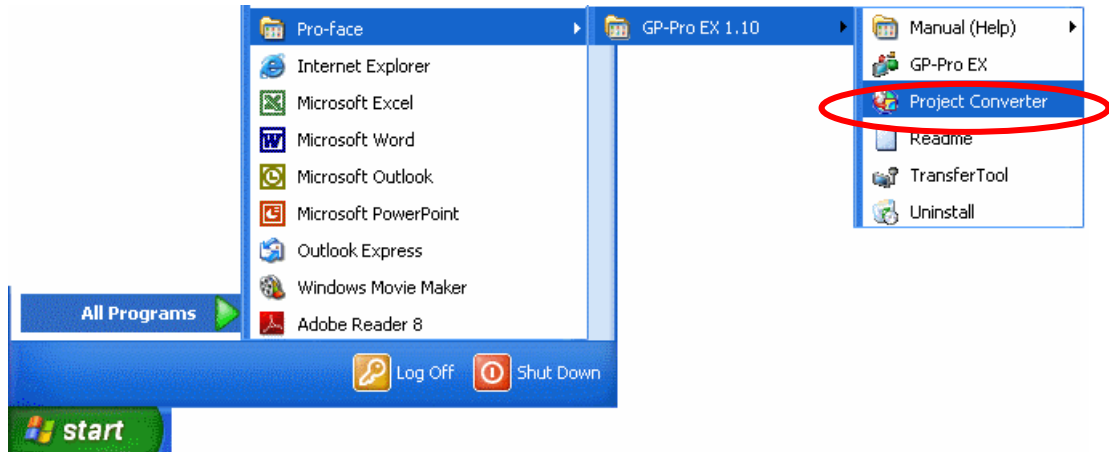

2. The Project Converter starts up and the [Project Converter] dialog box opens. Select [Project File (*.PRW)] in the [Data Type].

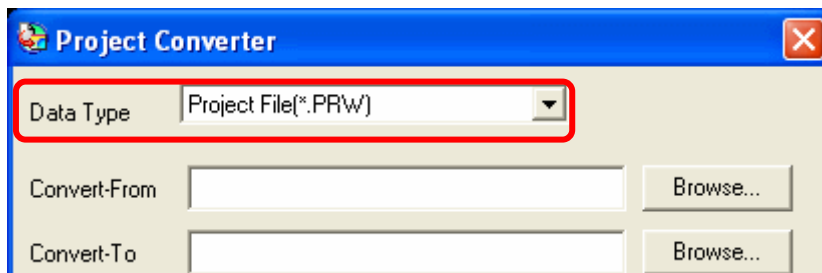

3. Designate a GP-PRO/PB3 for Windows' project file (*.prw) in [Convert-From]. Click the [Browse...] button and select a project file (e.g.: "Project system A.prw"). Click [Open], and the file will be set in [Convert-From].

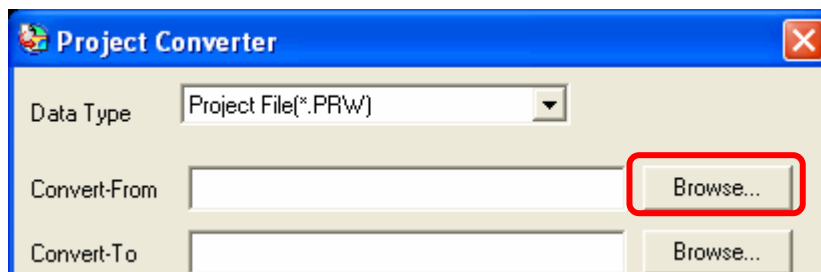

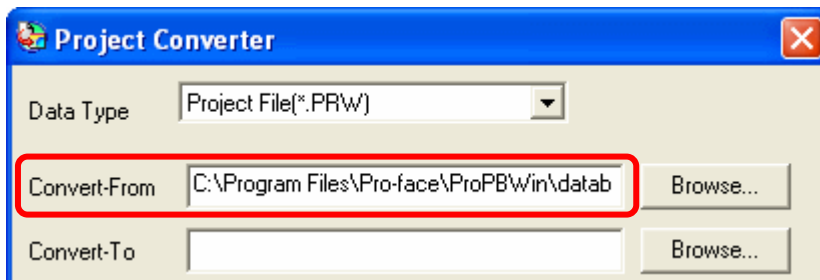
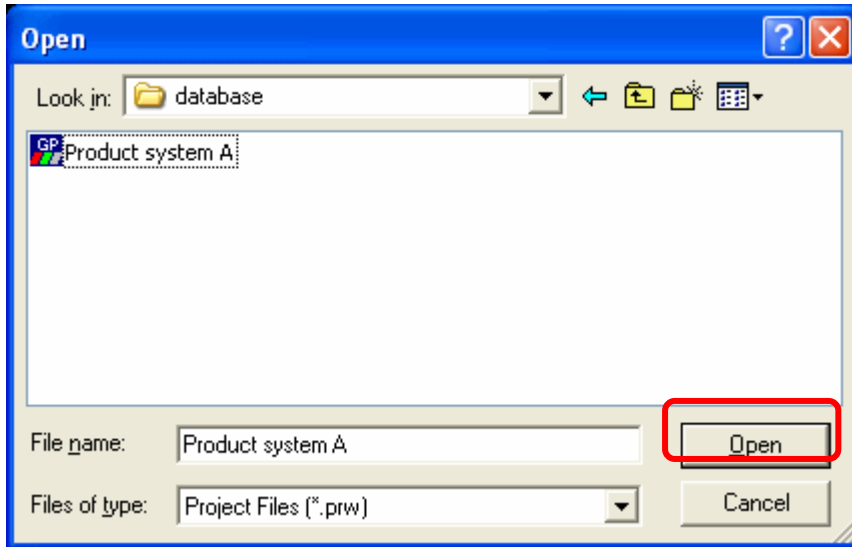

4. In [Convert-To], designate a GP-Pro EX's project file (*.prx). Click the [Browse...] button and enter a new [File Name] (e.g.: "Product system A.prx"). Click [Save], and a new project file will be set to [Convert-To].

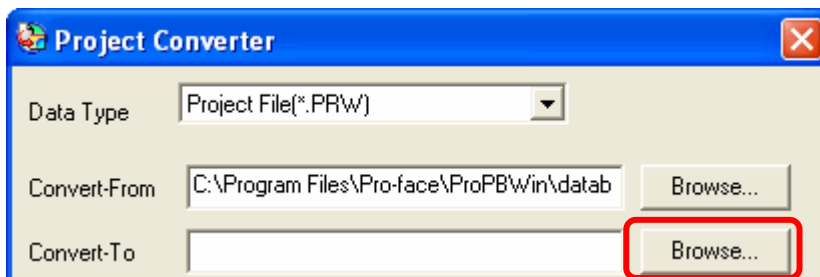

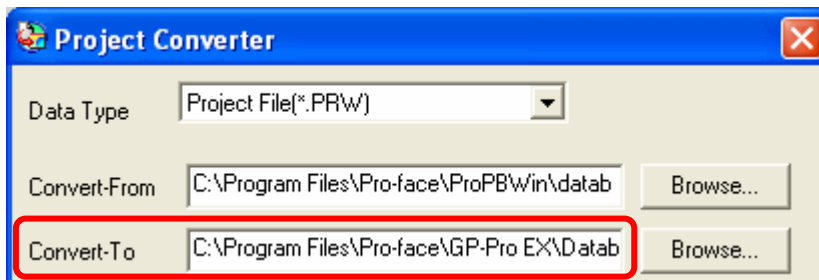
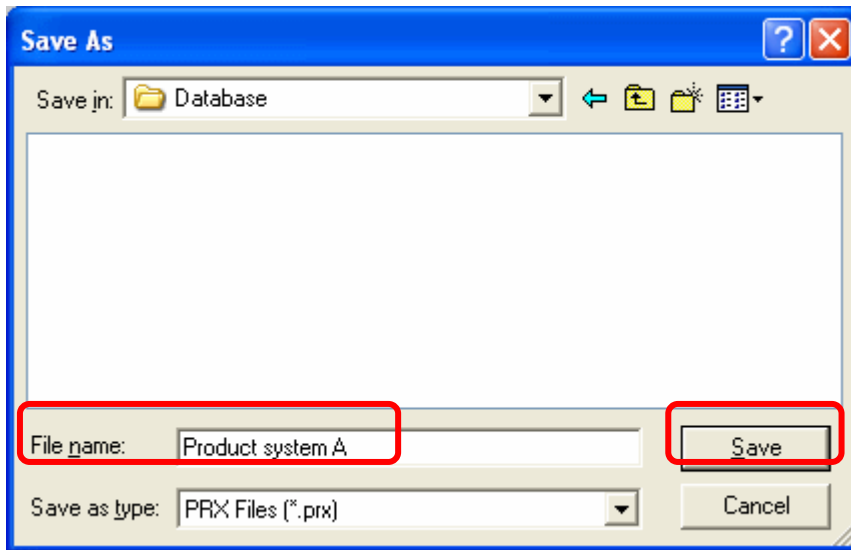

NOTE

- When a convert-to file exists, the window that confirms whether or not to overwrite the file is displayed.

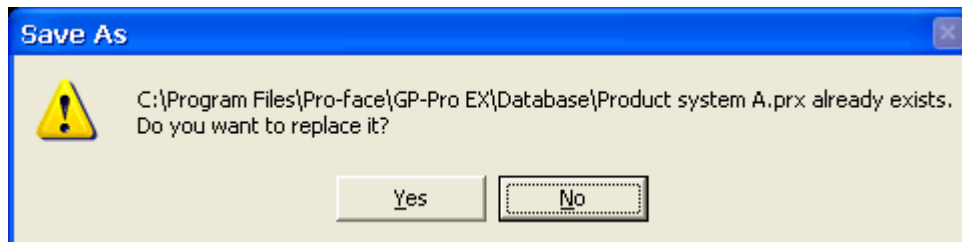

5. Click [Convert] and start the conversion.

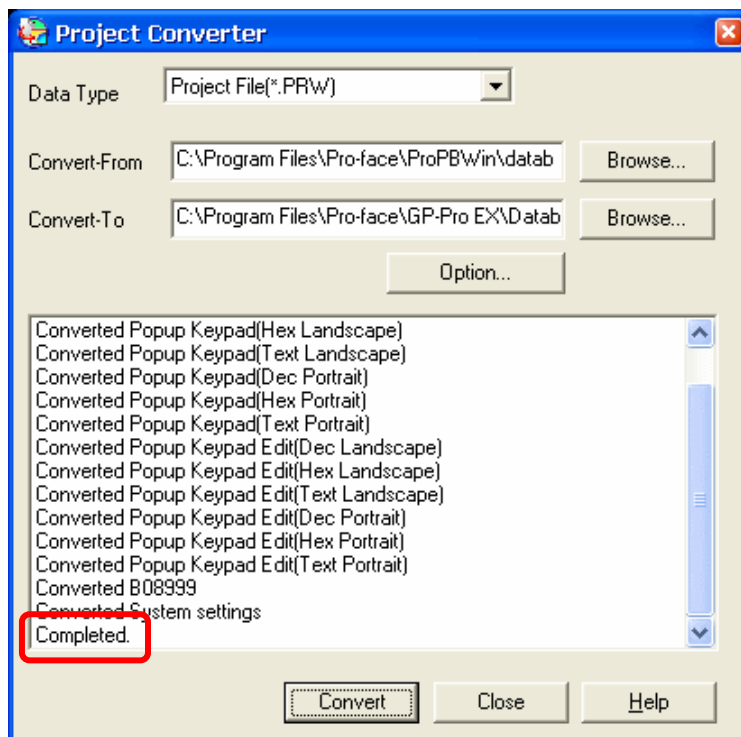
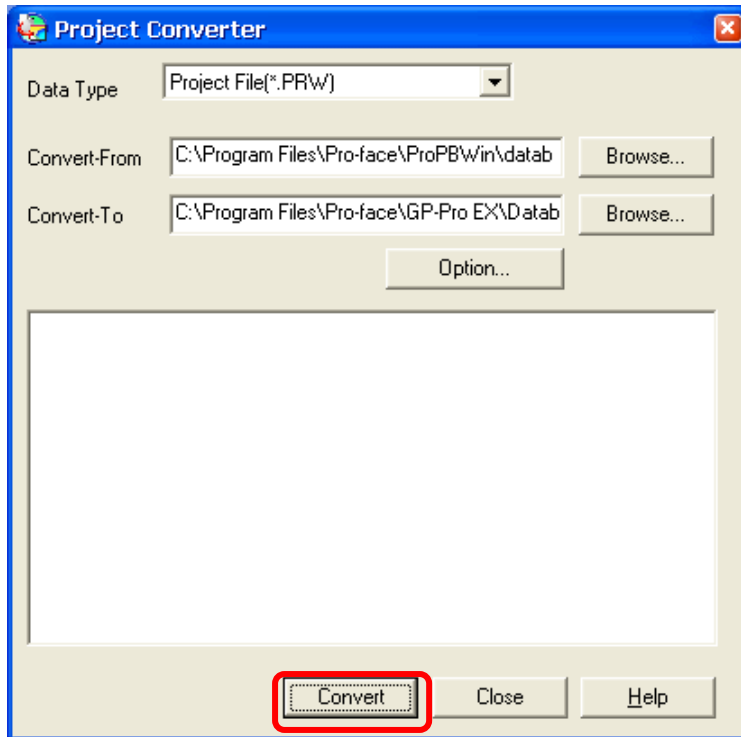

NOTE

- Depending on the model you are converting from, the [Convert Destination] dialog box may appear and you can select the type and the model.
- If the following dialog box appears, set a CF card output folder.

→ [See the next page](#)

Convert GP-PRO/PB3 for Windows' "Destination CF Card Folder"

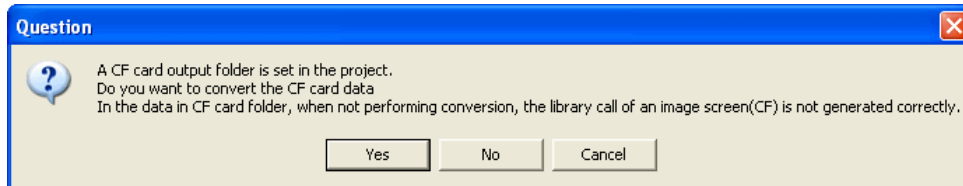

6. After conversion, the [Save convert information] dialog box appears. If you click [Save], you can save the conversion information in a text file.

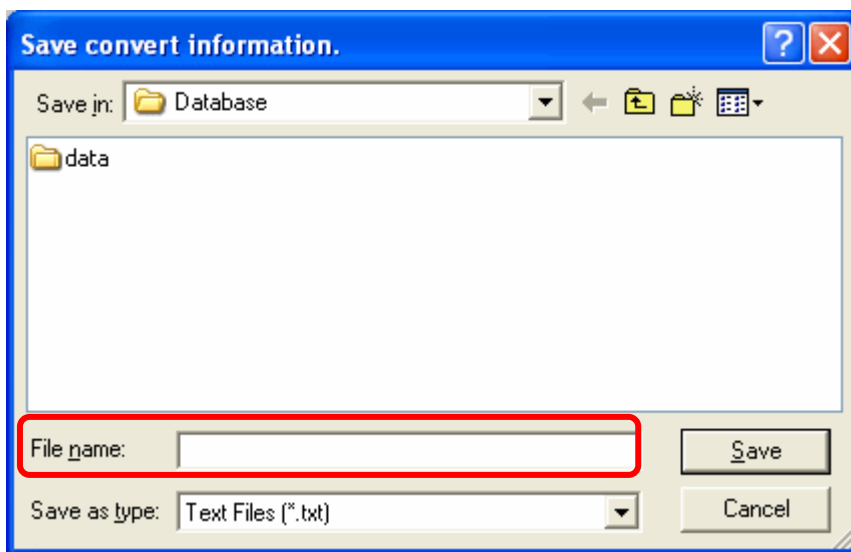

7. Click [Close] to close the [Project Converter] dialog box.

◆ **Convert GP-PRO/PB3 for Windows' "Destination CF Card Folder"**

If you convert a project file (*.prw) with a destination CF card folder designated in the step 5, the Question dialog box asking whether or not to designate the destination CF card folder for the convert destination appears again.

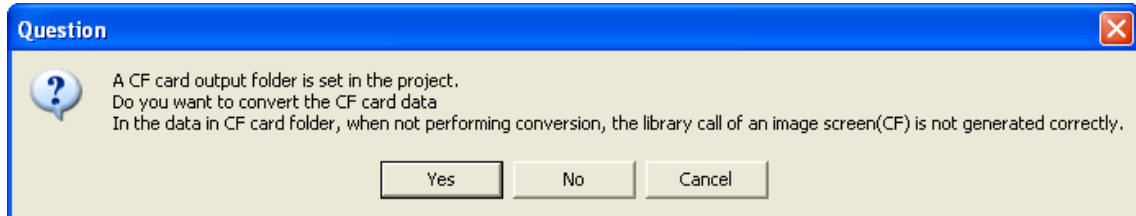

Select a folder (e.g.: "Database") and click [OK].

If you click the [Make New Folder] button, you can create a new folder at any location.



IMPORTANT

In the [Question] dialog box, be sure to select [Yes] and specify the destination folder. If you select [No], images will not be called correctly.

3.5 Differences of software after conversion

Check the differences of screen data after conversion.

For the details of each item, refer to the booklet “Compatibility of Software” or visit our website.

<http://www.pro-face.com/otasuke/qa/gp3000/replace/soft.htm>

1	Touch Panel Type
2	Compatibility of Bit Switch
3	Compatibility of Trend Graph
4	Compatibility of K Tag (Input Order)
5	Compatibility of K Tag (Difference of Writing)
6	Compatibility of K Tag (Indirect Setting)
7	Compatibility of N Tag
8	About the performance when a window is overlapping on a momentary switch
9	About the performance when display area of the system window is overlapping
10	Change of Tag Process
11	Compatibility of Text
12	Compatibility of Fill
13	Compatibility of CF Card Data
14	Precautions for conversion when filing data is saved in a CF card
15	Precautions for setting “Color Settings” to [256 Colors without blinking]
16	Precautions for loading a part with “L Tag (Library Display)”
17	Compatibility of MRK files and CPW files
18	Compatibility of VM Unit Settings
19	Compatibility of Extended SIO Script
20	Compatibility of Sound Data
21	Compatibility of Device Monitor
22	Compatibility of J Tag and R Tag
23	DOS Screen Data Conversion
24	Compatibility of Standard Fonts
25	Compatibility of D-Script Trigger Conditions (D-Script runs immediately after the screen is changed or the power is turned on)
26	Compatibility of U Tag (Window Screen is positioned in an unexpected area when called)
27	Precaution for Conversion when Screen Level Change is configured
28	Precaution for Use of Project Converter
29	Compatibility of LS Area
30	Compatibility of L Tag

3.6 Transfer screen data to the GP3000H series

Transfer the converted project file to the GP3000H unit. Although you can transfer data to the GP3000H unit via a USB flash drive, this section explains, as an example, how to transfer screen data with a USB transfer cable (model: CA3-USBCB-01).

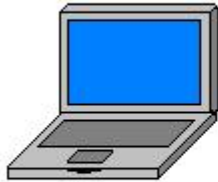

PC



CA3-USBCB-01



GP3000H

1. Connect your PC and the GP3000H series with a USB transfer cable. If the driver of the cable has not been installed on your PC yet, a dialog box will appear. Please follow the instructions.

NOTE

The “Hardware Installation” dialog box as follows may appear during installing the driver of a USB depending on the security level of Windows XP. Click [Continue Anyway] to start installing the driver for CA3-USBCB-01. When installation is completed, click [Finish].



2. Turn on the display unit's power. The "Initial Start Mode" screen will appear on the display unit.

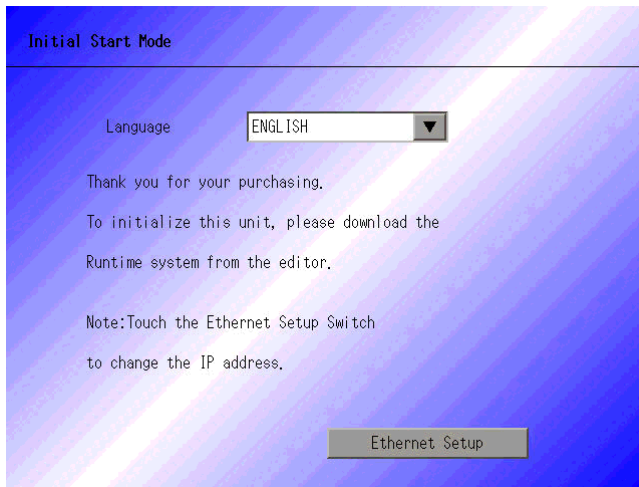

This screen will appear when you first connect the display unit's power code. After transferring a project file once, this screen will not appear again.

3. On the GP-Pro EX's State Toolbar, click the [Transfer Project] icon to open the Transfer Tool.

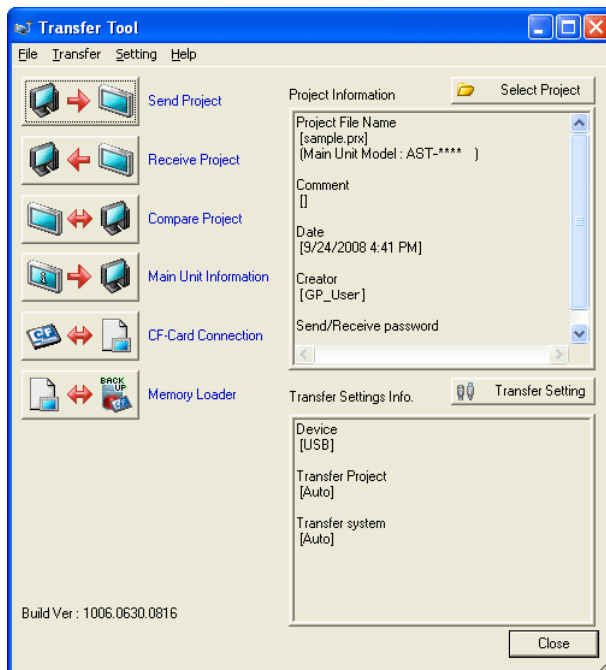

4. Check the project file name and other data to be transferred in the Project Information. To transfer a different project file, click the [Select Project] button and select a project file.

5. Make sure that the [Device] in the “Transfer Information” is set to [USB]. If not, click the [Transfer Setting] button to open the “Transfer Settings” dialog box. Select [USB] in the Communication Port Settings field and click [OK].

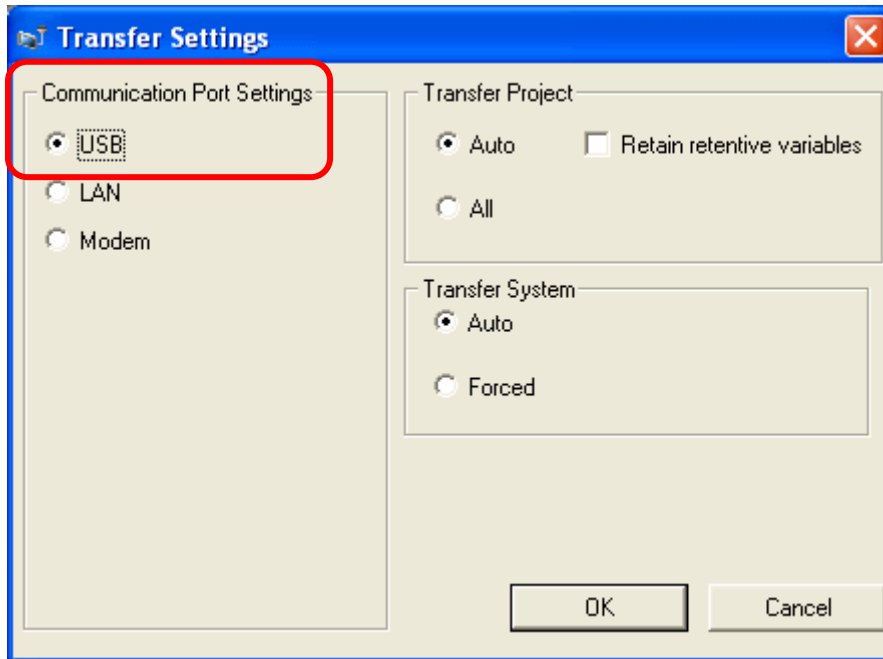

6. Click [Send Project] to start transfer. When the following dialog box appears, click [Yes]. This dialog box doesn't appear when the same project file is sent again.

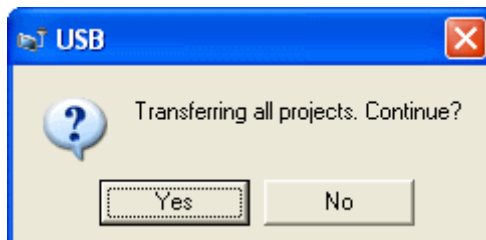

- The following dialog box appears during transfer and you can check the communication status. (The display unit enters the Transferring mode and communication with the device such as a PLC is terminated.)

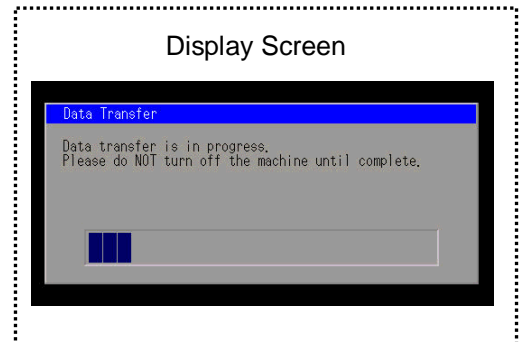
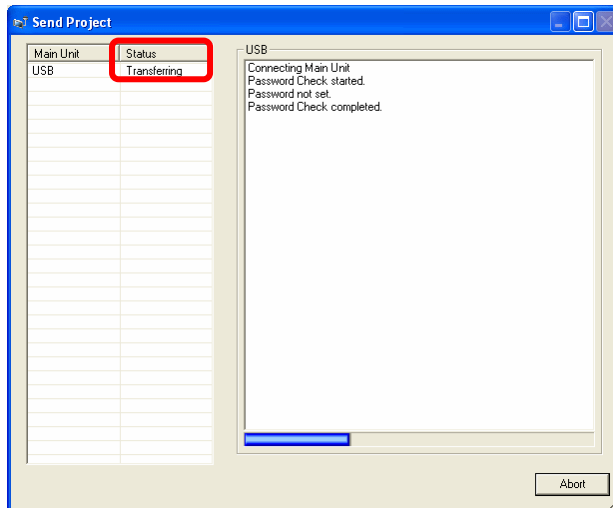

- When transfer is completed, the status displayed in the dialog box will change from [Transferring] to [Complete Transfer]. Click [Close] to close the dialog box. (The display unit will be reset and a screen of the transferred project file will be displayed.)

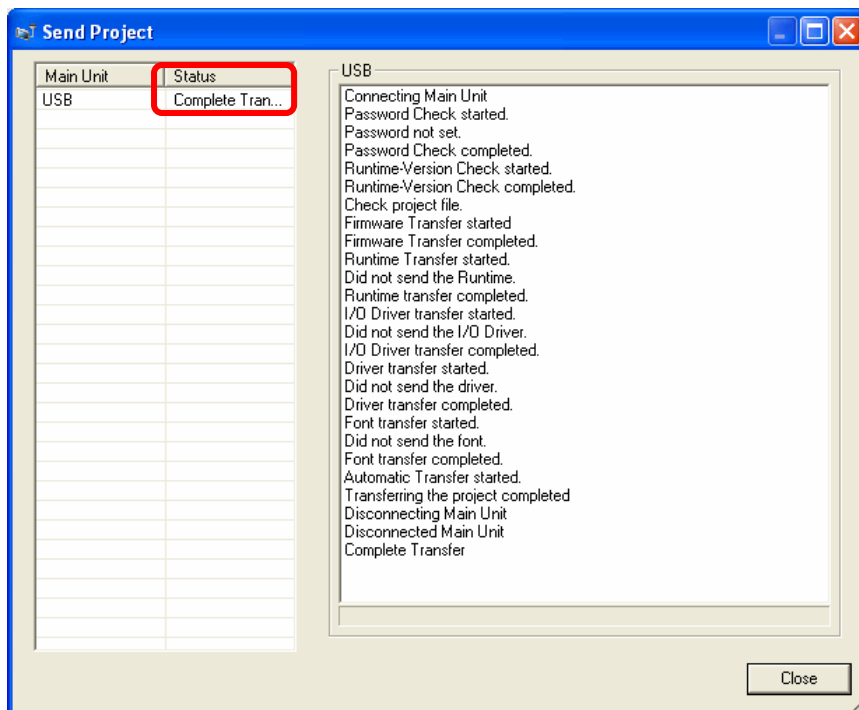

- Close the Transfer Tool.

Chapter 4. Communication with Device/PLC

4.1 Driver list

IMPORTANT

The followings are information as of May 2009.

More connectable drivers will be added. Please check our website "Otasuke Pro!" for the latest information.

PLC		
Manufacturer	Series	GP3000H
Mitsubishi Electric Corporation	A Series CPU Direct	✓
	A Series Ethernet	✓
	A Series Computer Link	✓
	FX Series CPU Direct	✓
	FX Series Computer Link	✓
	Q Series CPU Direct	✓
	Q/QnA Serial Communication	✓
	Q/QnA Series Ethernet	✓
	QnA Series CPU Direct	✓
	QUTE Series CPU Direct	✓
	Q Series QnU CPU Ethernet	✓
OMRON Corporation	C/CV Series HOST Link	✓
	CS/CJ Series HOST Link	✓
	CS/CJ Series Ethernet	✓
YASKAWA Electric Corporation	MEMOBUS SIO	✓
	MEMOBUS Ethernet	✓
	MP Series SIO (Extension)	✓
	MP Series Ethernet (Extension)	✓
Hitachi IES Co., Ltd.	H Series SIO	✓
	H Series Ethernet	✓
Panasonic Electric Works, Ltd. (Formerly Matsushita Electric Works, Ltd.)	FP Series Computer Link SIO	✓
YOKOGAWA Electric Corporation	Personal Computer Link SIO	✓
	Personal Computer Link Ethernet	✓
JTEKT Corporation (Formerly Toyoda Machine Works)	TOYOPUC CMP-LINK SIO	✓
	TOYOPUC CMP-LINK Ethernet	✓
Fuji Electric Co., Ltd.	MICREX-F Series SIO	✓
	MICREX-SX Series SIO	✓
	MICREX-SX Series Ethernet	✓
GE Fanuc Automation	Series 90 Ethernet	✓

	Series 90-30/70 SNP	✓
	Series 90-30/70 SNP-X	✓
FUNUC Ltd	Power Mate Series	✓
Siemens AG	SIMATIC S7 MPI Direct	✓
	SIMATIC S7 3964(R)/RK512	✓
	SIMATIC S7 Ethernet	✓
	SIMATIC S5 CPU Direct	✓
Rockwell Automation, Inc.	DF1	✓
	EtherNet/IP	✓
	DH-485	✓
KEYENCE Corporation	KV-700/1000/3000/5000 CPU Direct	✓
	KV-700/1000/3000/5000 Ethernet	✓
	KV Series CPU Direct	✓
	KZ10_80R/Tseries CPU Direct	✓
Schneider Electric Industries	MODBUS SIO Master	✓
	MODBUS TCP Master	✓
	Uni-Telway	✓
	MODBUS Slave	✓
SHARP MS Corporation	JW Series Computer Link SIO	✓
	JW Series Computer Link Ethernet	✓
LS Industrial System	MASTER-K Series Cnet	✓
	XGT Series FEnet	✓
	XGT Series Cnet	✓
Mitsubishi Heavy Industries, Ltd.	DIASYS Netmation MODBUS TCP	✓
	MHI STEP3 Ethernet	✓
Saia-Burgess Controls Ltd.	SAIA S-Bus SIO	✓
MEIDENSHA Corporation	UNISEQUE Series Ethernet	✓
Hitachi, Ltd.	S10V Series Ethernet	✓
	S10 Series SIO	✓
TOSHIBA Machine Co., Ltd.	TCmini/TC200	✓
TOSHIBA Corporation	Computer Link SIO	✓
	Computer Link Ethernet	✓
Koyo Electronics Co., Ltd.	KOSTAC/DL Series CCM SIO	✓
	KOSTAC/DL Series MODBUS TCP	✓
FATEK AUTOMATION Corporation	FB Series SIO	✓

Temperature Controller		
Manufacturer	Series	GP3000H
Yamatake Corporation	Digital Controller SIO	✓
RKC Instrument Inc.	Temp. Controller MODBUS SIO	✓
	Temperature Controller	✓
OMRON Corporation	Temp. Controller CompoWay/F	✓
Shinko Technos Co., Ltd.	Controller SIO	✓
YOKOGAWA Electric Corporation	Personal Computer Link SIO	✓
CHINO Corporation	Temp. Controller MODBUS SIO	✓
Fuji Electric Systems Co., Ltd.	Temp. Controller MODBUS SIO	✓

Inverter/Servo		
Manufacturer	Series	GP3000H
Mitsubishi Electric Corporation	FREQROL Inverter	✓
YASKAWA Electric Corporation	Inverter SIO	✓
Hitachi IES Co., Ltd.	Inverter ASCII SIO	✓
	InverterModbus RTU	✓
Sanmei Electric Co., Ltd.	Si/CutyAxisSeries SIO	✓

Industrial Robot		
Manufacturer	Series	GP3000H
Hyundai Heavy Industries	Hi4 Robot	✓
IAI Corporation	ROBO CYLINDER MODBUS SIO	✓
	X-SEL Controller	✓

Other Devices		
Manufacturer	Series	GP3000H
Digital Electronics Corporation	Memory Link *1	✓
	General SIO *2	✓
	General Ethernet *2	✓
MODBUS IDA	General Modbus SIO Master	✓
	General Modbus TCP Master	✓

*1: The product doesn't need to choose a host controller like PC, Microcomputer board, etc. It communicates via the storage space built into the main unit

*2: A program driver for the send/receive command process by D-Script.

4.2 Differences of system structures

4.2.1 System structure before replacement (GP2000H Series)

The following system structure is one of the typical structures for the connection of the GP2000H series:

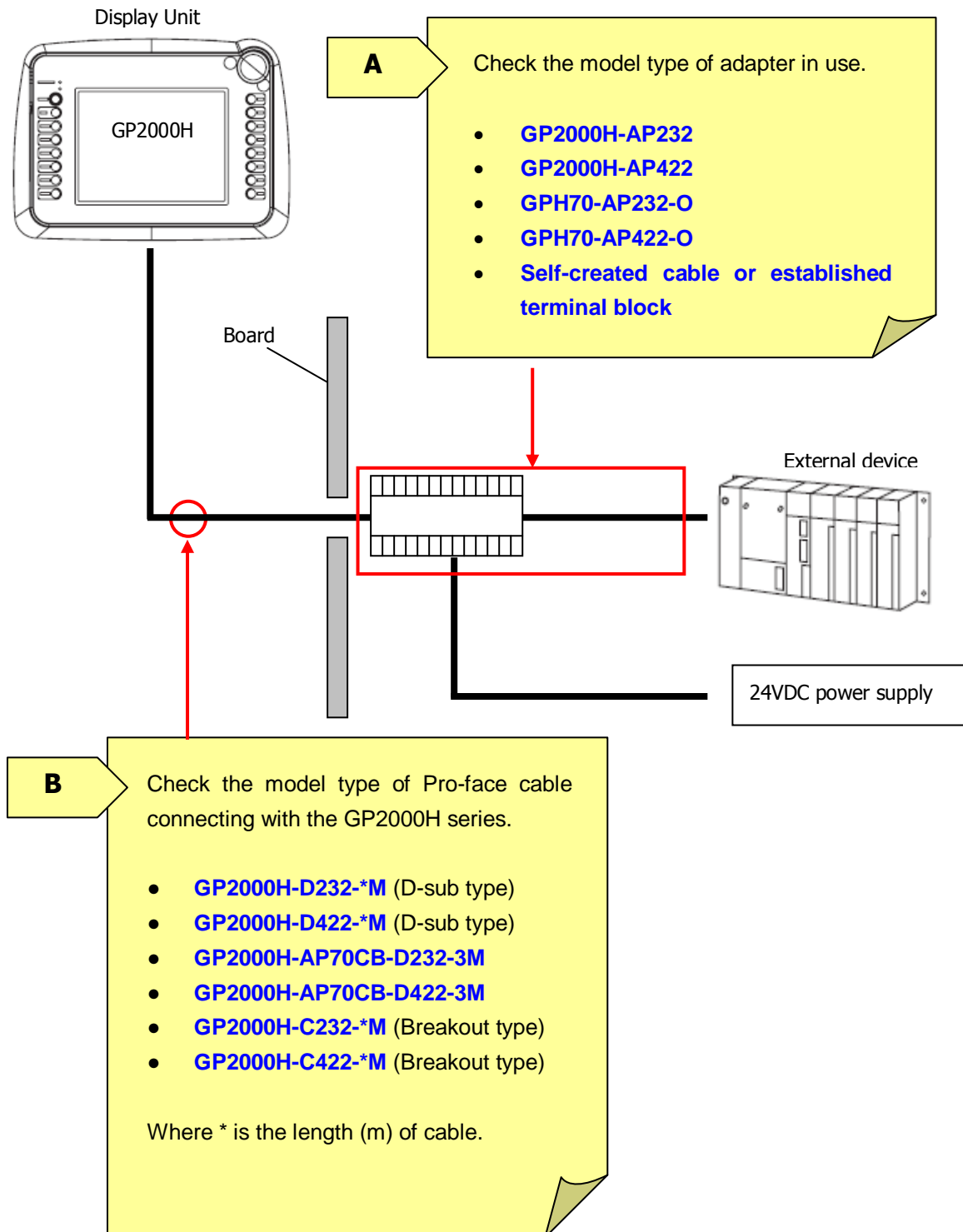

4.2.2 Work flow of replacement of GP2000H with GP3000H

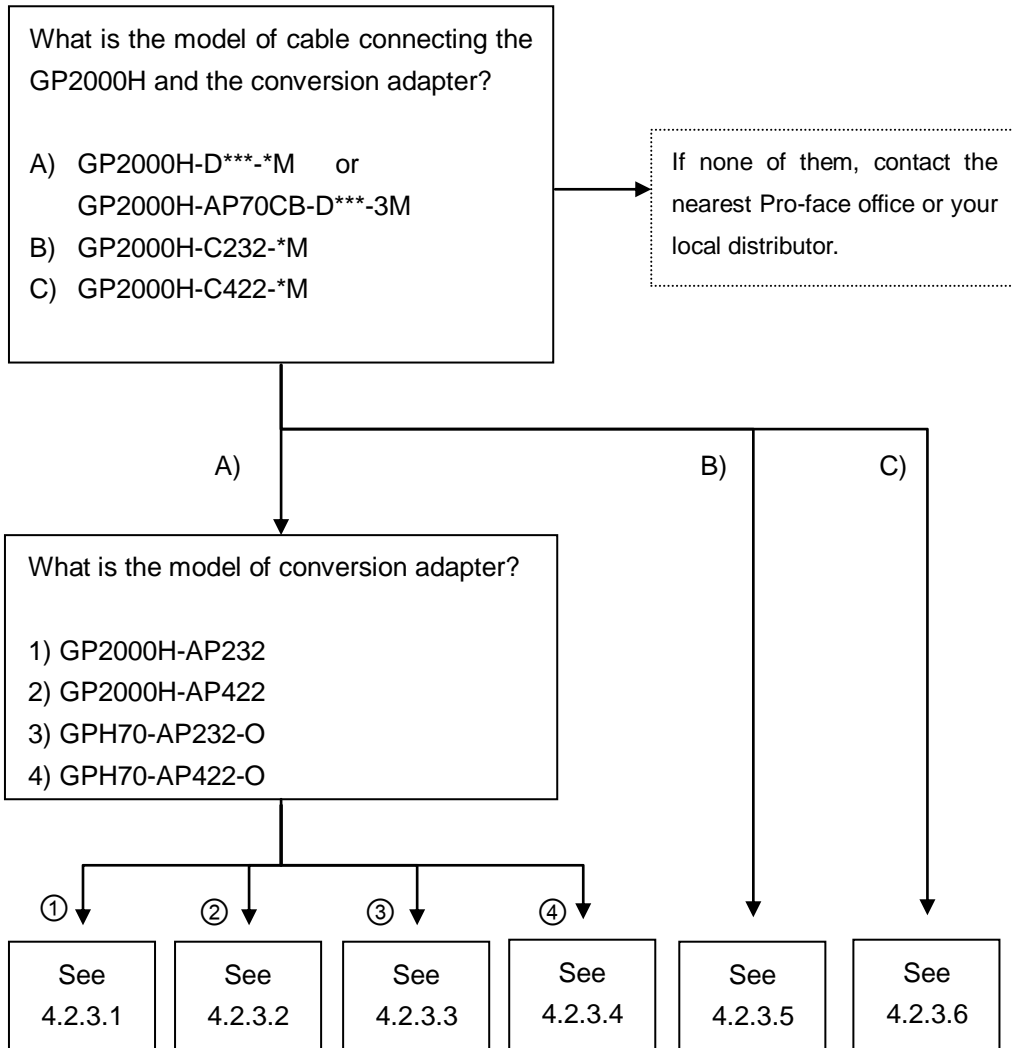

NOTE

Where *** in the model name is the communication method and * is the length of the cable.

4.2.3 System structure after replacement (GP3000H Series)

4.2.3.1 Structure 1

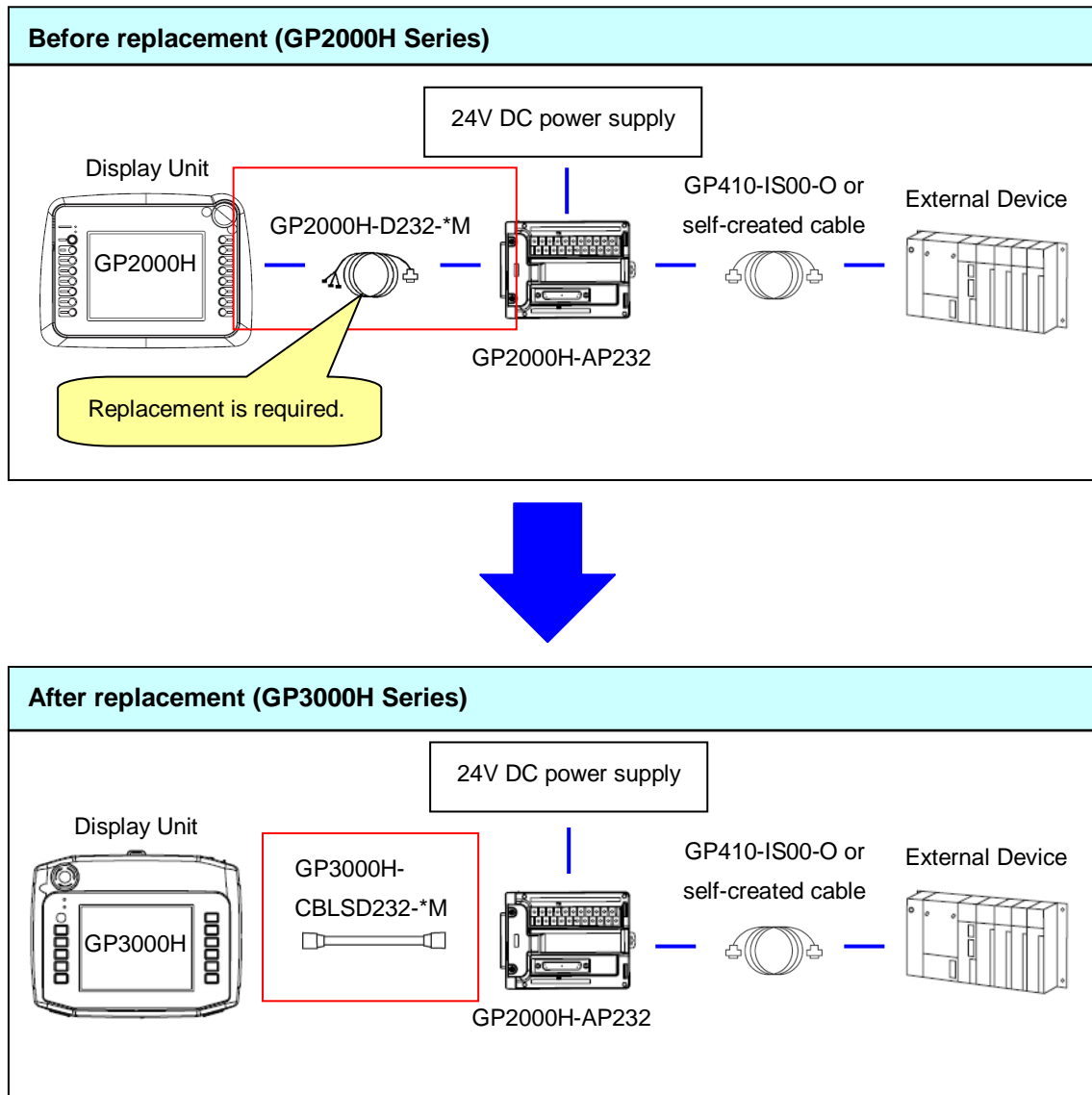

About replacement

When you replace the GP2000H unit with the GP3000H unit, you also need to replace the GP2000H cable ([GP2000H-D232-*M](#)) with the GP3000H cable ([GP3000H-CBLSD232-*M](#)). However, you can use the GP2000H conversion adapter ([GP2000H-AP232](#)) and the cable [GP410-IS00-O](#) or [self-created cable](#) without changing.

If you use [GP2000H-AP232](#) to connect the GP3000H, some features are restricted. For the details, see [A.1.3 "IMPORTANT."](#)

4.2.3.2 Structure 2

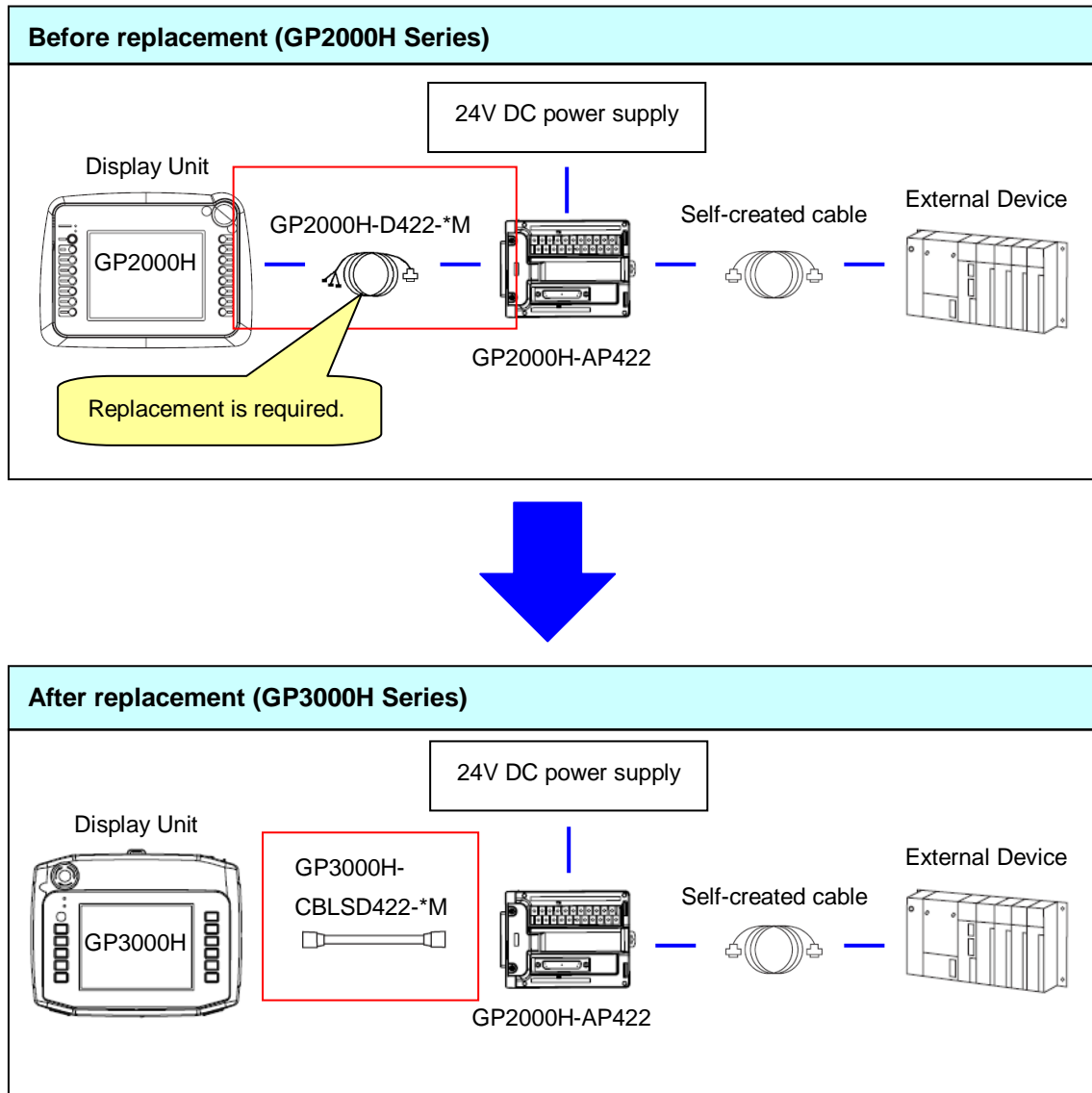

About replacement

When you replace the GP2000H unit with the GP3000H unit, you also need to replace the GP2000H cable (GP2000H-D422-*M) with the GP3000H cable (GP3000H-CBLSD422-*M). However, you can use the GP2000H conversion adapter (GP2000H-AP422) and the self-created cable without changing.

If you use GP2000H-AP422 to connect the GP3000H, some features are restricted. For the details, see A.1.3 "IMPORTANT."

4.2.3.3 Structure 3

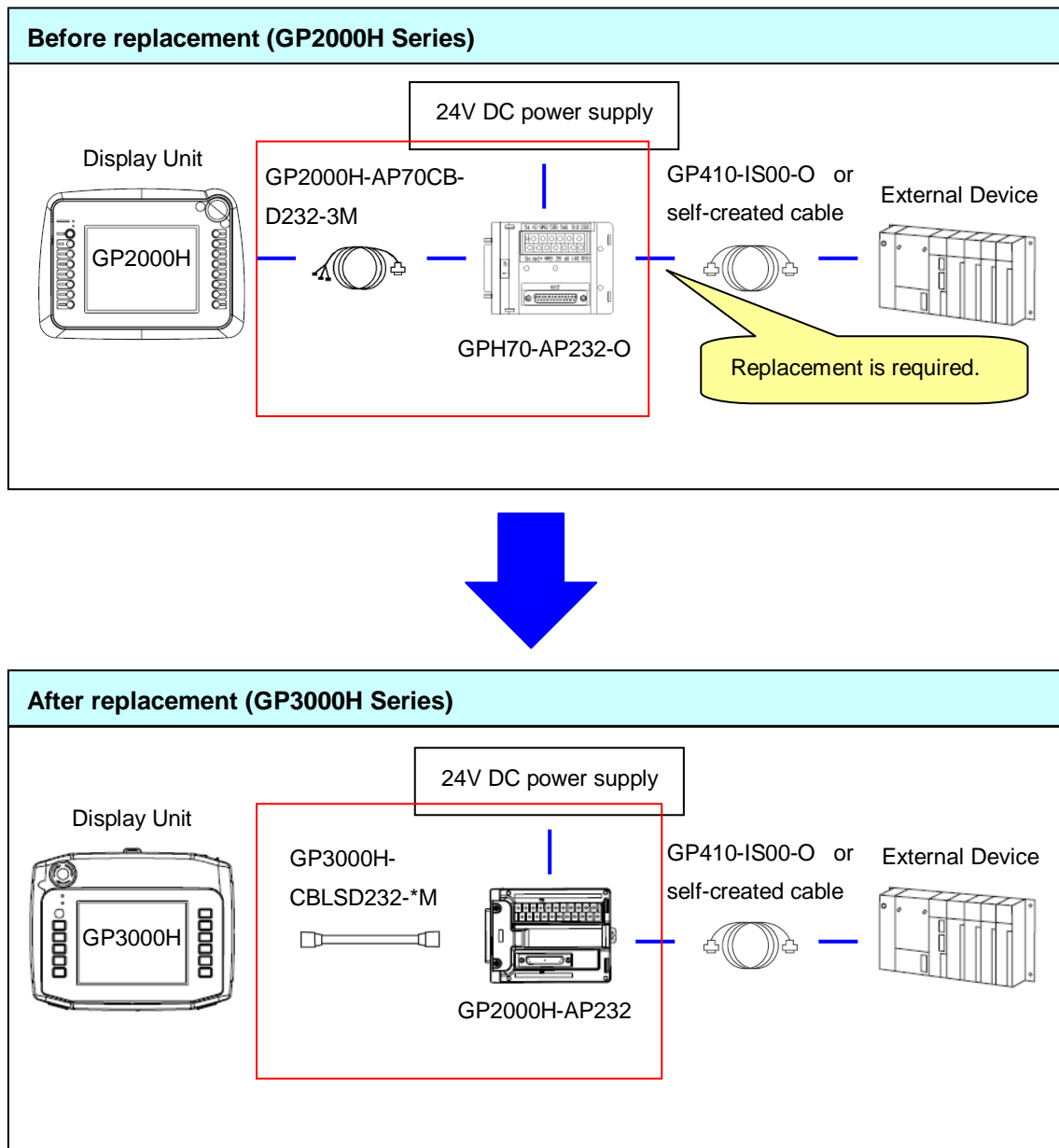

About replacement

When you replace the GP2000H unit with the GP3000H unit, you also need to replace the GP2000H series GP-H70 conversion adapter connection cable ([GP2000H-AP70CB-D232-3M](#)) with the GP3000H cable ([GP3000H-CBLSD232-*M](#)), and the GP-H70 conversion adapter ([GPH70-AP232-O](#)) with the GP2000H conversion adapter ([GP2000H-AP232](#)). However, you can use the cable [GP410-IS00-O](#) or [self-created cable](#) without changing.

If you use [GP2000H-AP232](#) to connect the GP3000H, some features are restricted. For the details, see [A.1.3 "IMPORTANT."](#)

4.2.3.4 Structure 4

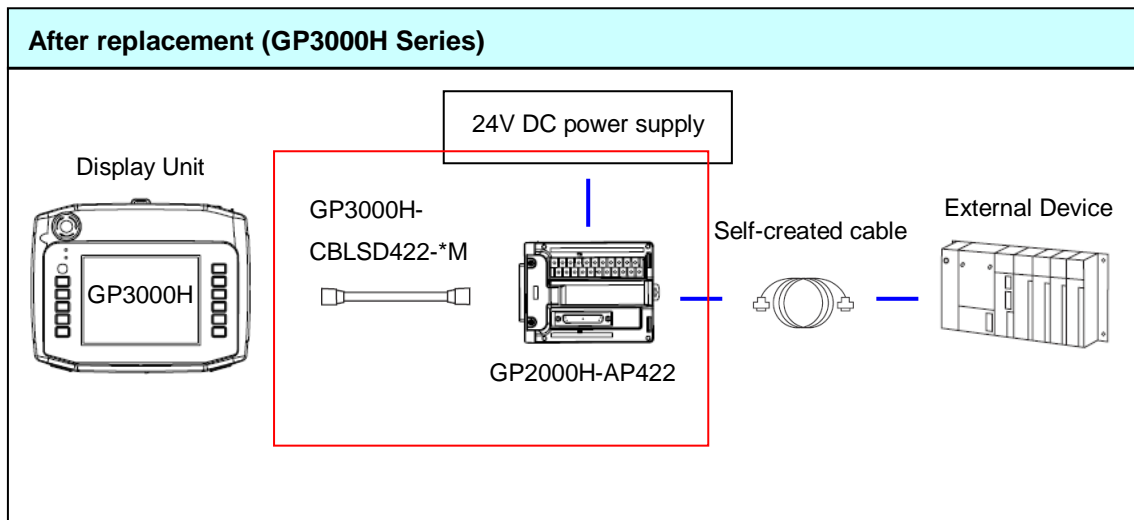
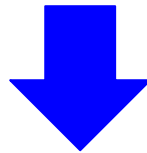
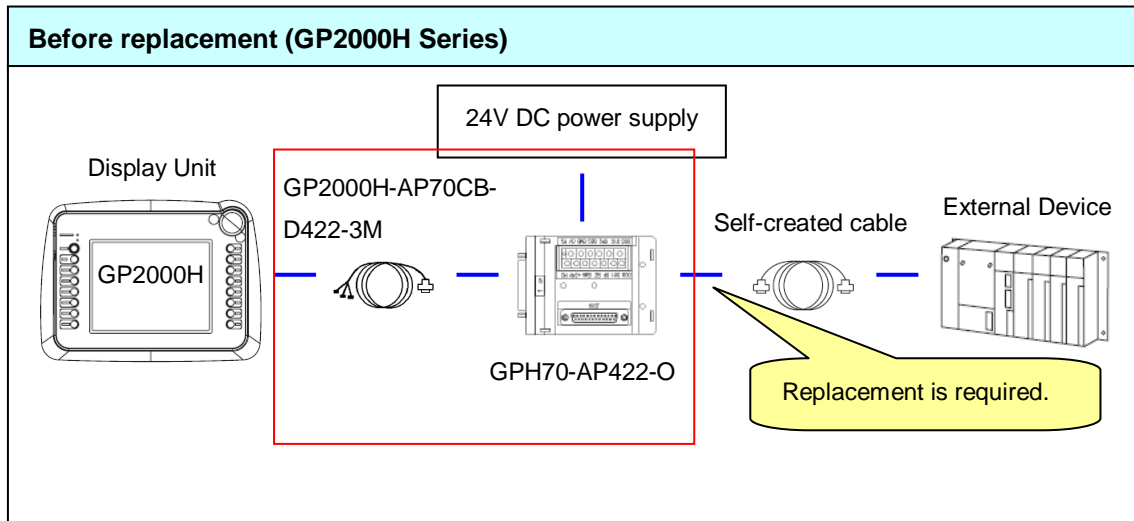

About replacement

When you replace the GP2000H unit with the GP3000H unit, you also need to replace the GP2000H series GP-H70 conversion adapter connection cable ([GP2000H-AP70CB-D422-3M](#)) with the GP3000H cable ([GP3000H-CBLSD422-*M](#)), and the GP-H70 conversion adapter ([GPH70-AP422-O](#)) with the GP2000H conversion adapter ([GP2000H-AP422](#)). However, you can use the [self-created cable](#) without changing.

If you use [GP2000H-AP422](#) to connect the GP3000H, some features are restricted. For the details, see [A.1.3 "IMPORTANT."](#)

4.2.3.5 Structure 5

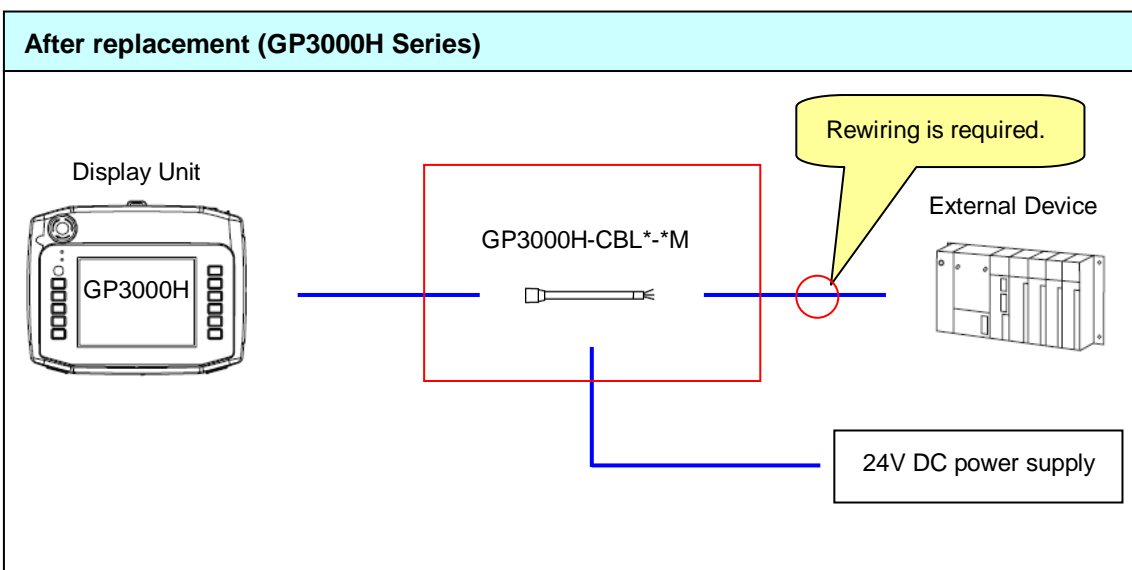
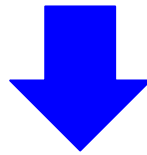
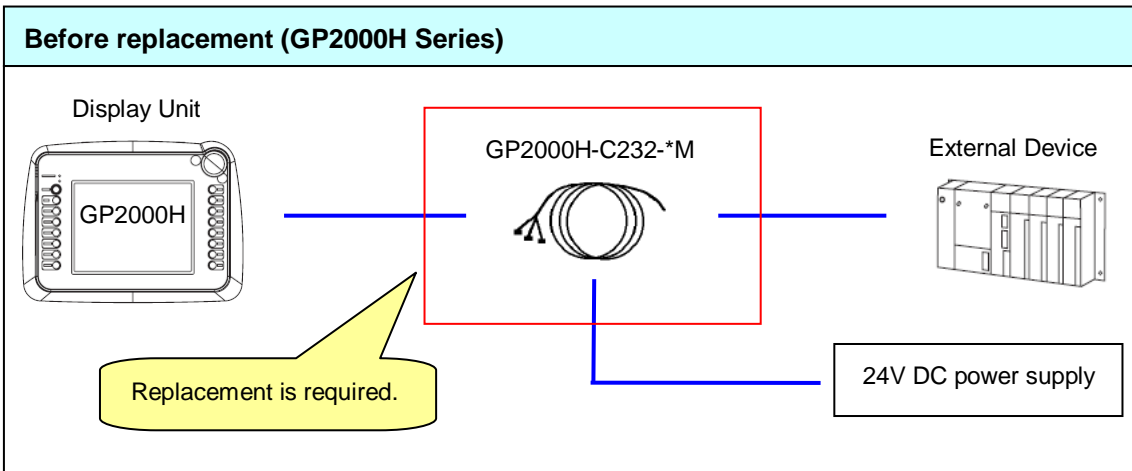

About replacement

When you replace the GP2000H unit with the GP3000H unit, you also need to replace the GP2000H cable (without connector) (GP2000H-C232-*M) with the GP3000H cable (without connector) (GP3000H-CBL*-*M). For the details of wiring to the connection device, check the cable diagram for connection using [your self-created cable \(your own cable\)](#) in the GP3000 Series Device/PLC Connection Manual. The cable-wiring diagram is different depending on the connection device to use.

Cable diagram 1

Display (Connection Port)	Cable	
GP (COM1)	A	Mitsubishi Q link cable by Pro-face CA3-CBLLNKMQ-01
ST (COM1) IPC*1 PC/AT	B	Your own cable

Example of Device/PLC Connection Manual

About cable color and identification mark

The wire jacket colors of the GP2000H cable are different from those of the GP3000H cable as follows:

GP2000H-C232-*M

GP3000H-CBL*-*M

Jacket color		Jacket color	Identification mark	Signal
Purple	⇒	Brown	White 1	CD
Orange	⇒	Brown	Black 1	RD (RXD)
Blue	⇒	Brown	White 2	SD (TXD)
Gray	⇒	Brown	White 4	ER (DTR)
White	⇒	Brown	-	SG
-		Brown	Black 3	DR (DSR)
Red	⇒	Brown	Black 2	RS (RTS)
Brown	⇒	Brown	White 3	CS (CTS)
-		Brown	Black 4	CI (RI)
Black/Green	⇒	Red	-	Power input 24V DC
Red/Green	⇒	Black	-	Power input 0V
Shield	⇒	Green	-	FG

Example of GP3000H-CBL*-*M

In the right figure, the jacket color of the wire is brown and two black marks are on it. Therefore, this wire can be identified as RS (RTS).

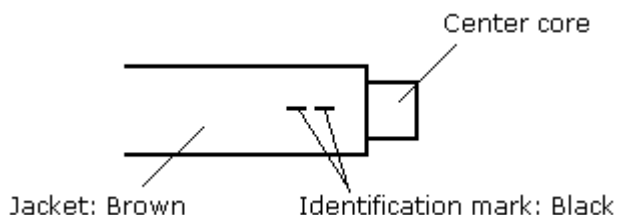

NOTE

System structure using the GP3000H conversion adapter (AGP3000H-ADPCOM-01)

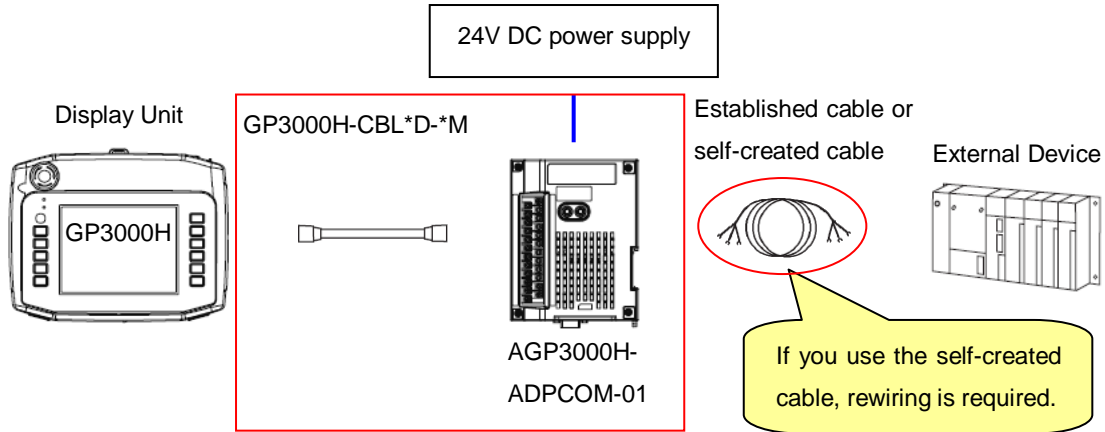

About replacement

You can also replace the GP2000H cable (without connector) (GP2000H-C232-*M) with the combination of the GP3000H cable (with connector) (GP3000H-CBL*D-*M) and the GP3000H conversion adapter (AGP3000H-ADPCOM-01).

As the shape of the serial interface on AGP3000H-ADPCOM-01 is same as that of the COM1 port of the GP3000H series, you can use not only the self-created cable (B in the table below) but also established cable (A in the table).

For the details of wiring AGP3000H-ADPCOM-01 to the connection device, check the cable diagram in the GP3000 Series Device/PLC Connection Manual. The cable-wiring diagram is different depending on the connection device to use.

Cable diagram 1

Display (Connection Port)	Cable	
GP (COM1) ST (COM1) IPC*1 PC/AT	A	Mitsubishi Q link cable by Pro-face CA3-CBLLNKMQ-01
	B	Your own cable

Example of Device/PLC Connection Manual

4.2.3.6 Structure 6

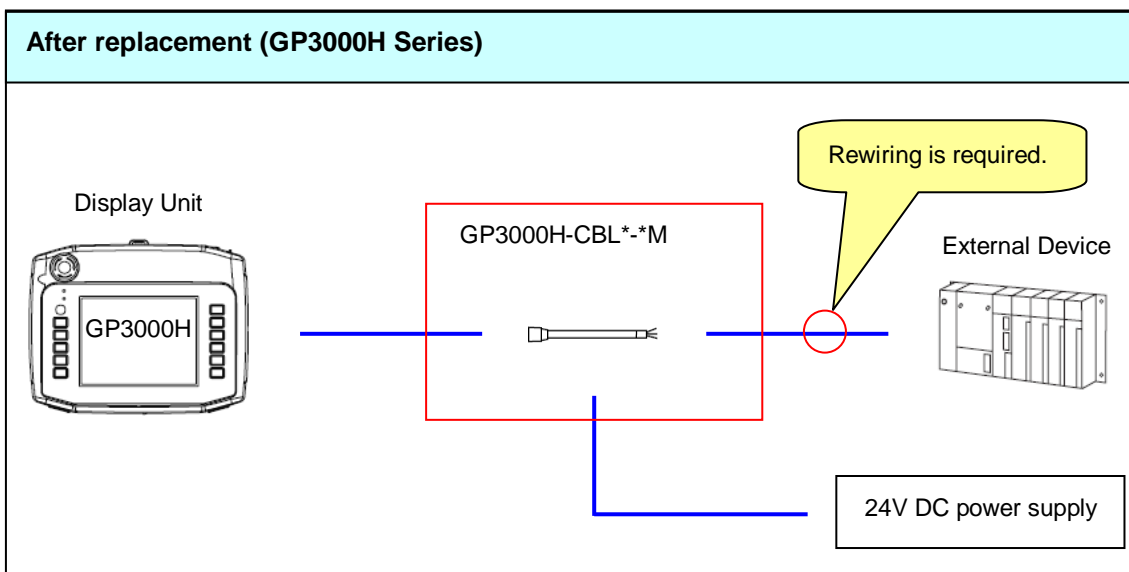
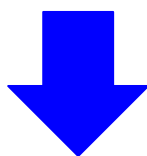
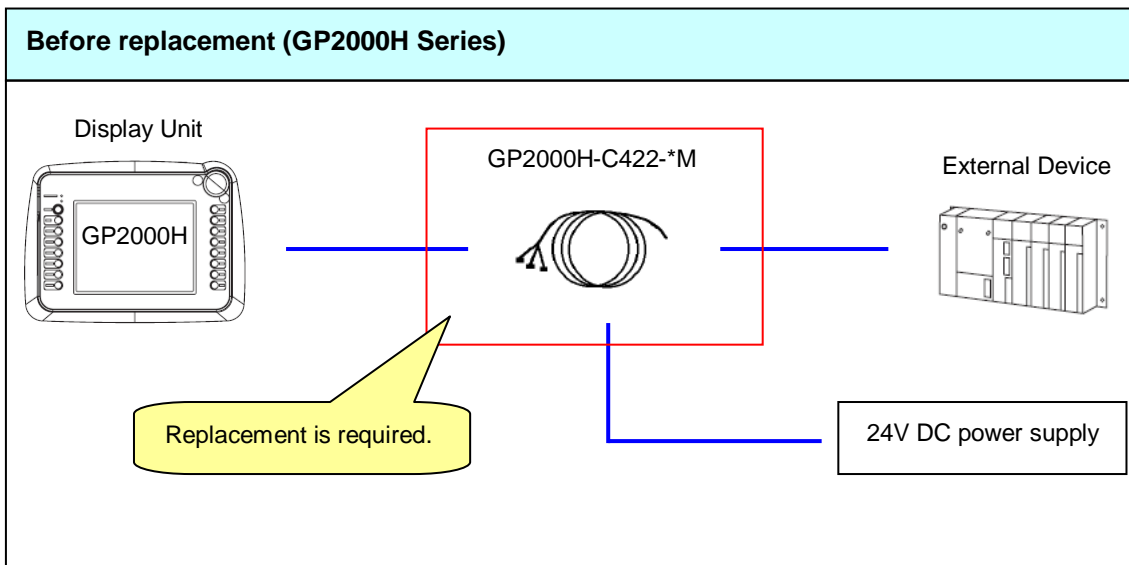

About replacement

When you replace the GP2000H unit with the GP3000H unit, you also need to replace the GP2000H cable (without connector) (GP2000H-C422-*M) with the GP3000H cable (without connector) (GP3000H-CBL*-*M). For the details of wiring to the connection device, check the cable diagram for connection using [your self-created cable \(your own cable\)](#) in the GP3000 Series Device/PLC Connection Manual. The cable-wiring diagram is different depending on the connection device to use.

Cable diagram 2

Display (Connection Port)	Cable	
<div style="border: 1px solid red; padding: 2px;">GP^{*1} (COM1)</div> AGP-3302B (COM2) ST ^{*2} (COM2) IPC ^{*3}	A	COM port conversion adapter by Pro-face CA3-ADPCOM-01 + Connector terminal block conversion adapter by Pro-face CA3-ADPTRM-01 + Your own cable
	B	<div style="border: 1px solid red; padding: 2px;">Your own cable</div>

Example of Device/PLC Connection Manual

About cable color and identification mark

The wire jacket colors of the GP2000H cable are different from those of the GP3000H cable as follows:

GP2000H-C422-*M

GP3000H-CBL*-*M

Jacket color		Jacket color	Identification mark	Signal
White	⇒	Brown	White 1	RDA
Black	⇒	Brown	Black 1	RDB
Yellow	⇒	Brown	White 2	SDA
Green	⇒	Brown	Black 2	SDB
Gray	⇒	Brown	-	SG
Brown	⇒	Brown	White 4	ERA
Red/Green	⇒	Brown	White 3	CSA
Orange	⇒	Brown	Black 4	ERB
Blue	⇒	Brown	Black 3	CSB
Black/Green	⇒	Red	-	Power input 24V DC
Red/Green	⇒	Black	-	Power input 0V
Shield	⇒	Green	-	FG

Example of GP3000H-CBL*-*M

In the right figure, the jacket color of the wire is brown and two black marks are on it. Therefore, this wire can be identified as SDB.

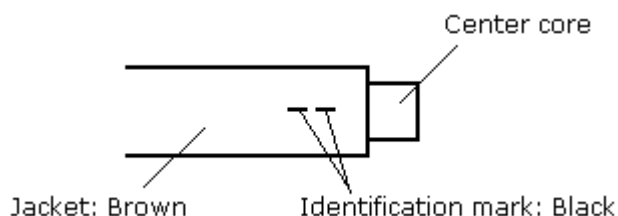

NOTE

System structure using the GP3000H conversion adapter (AGP3000H-ADPCOM-01)

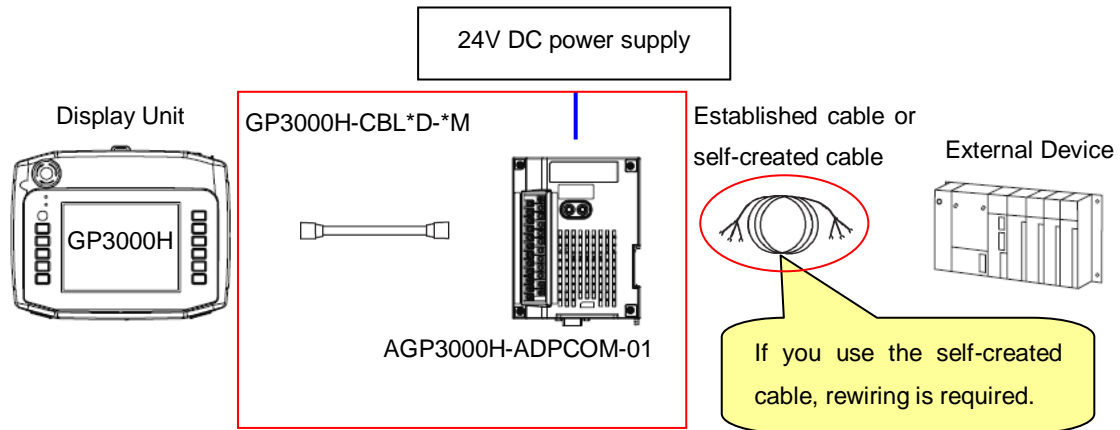

About replacement

You can also replace the GP2000H cable (without connector) (GP2000H-C422-*M) with the combination of the GP3000H cable (with connector) (GP3000H-CBL*D-*M) and the GP3000H conversion adapter (AGP3000H-ADPCOM-01).

As the shape of the serial interface on AGP3000H-ADPCOM-01 is same as that of the COM1 port of the GP3000H series, you can use not only the self-created cable (B in the table below) but also established cable (A in the table).

For the details of wiring AGP3000H-ADPCOM-01 to the connection device, check the cable diagram in the GP3000 Series Device/PLC Connection Manual. The cable-wiring diagram is different depending on the connection device to use.

Cable diagram 2

Display (Connection Port)	Cable	
GP* ¹ (COM1)	A	COM port conversion adapter by Pro-face CA3-ADPCOM-01 +
AGP-3302B (COM2)		Connector terminal block conversion adapter by Pro-face CA3-ADPTRM-01 +
ST* ² (COM2)		Your own cable
IPC* ³	B	Your own cable

Example of Device/PLC Connection Manual

4.3 Multilink Connection

There are some communication drivers that do not support multi-link connection (n:1) with RS-422 in GP3000 Series.

When converting the project file with the communication driver that multi-link connection (n:1) with RS-422 is not supported, it will be automatically converted to (1:1) connection.

[[Which drivers support serial multilink communication?](#)]

(http://www.pro-face.com/otasuke/files/manual/gpproex/new/device/com_mlnk.htm)

Appendix 1 Signals of Cables (to Host, no connector)

A 1.1 GP2000H Series Special Purpose RS-232C Cable (GP2000H-C232-3M/10M)

I/F	No.	Signal Name	Description	Wire Color	Wire Type	Non-GP2000H SIO Pin No.
External Device I/F	1	RESERVE	Reserved ^{*1}	Black/Gray	AWG22	
	2	DOUT0.C	DOUT 0(ZERO) Output	Black/White	AWG22	
	3	RESERVE	Reserved ^{*1}	Red/White	AWG22	
	4	DOUT1.C	DOUT 1(ONE) Output	Green/Brown	AWG22	
	5	OP.GND	OP Ground	Red/Yellow	AWG22	
	6	OP.C	OP Output	Red/Blue	AWG22	
	7	DOUT.GND	DOUT Ground ^{*2}	Red/Pink	AWG22	
	8	BUZZ OUT	External Buzzer Output	Black/Orange	AWG22	
	9	EMG0B	Push-Lock Switch 0B (Operates like A contact)	Red/Gray	AWG22	
	10	EMG0A	Push-Lock Switch 0A (Operates like A contact)	White/Orange	AWG22	
	11	EMG1B	Push-Lock Switch 1B (B contact)	Black/Yellow	AWG22	
	12	EMG1A	Push-Lock Switch 1A (B contact)	Green/White	AWG22	
	13	EMG2B	Push-Lock Switch 2B (B contact)	White/Blue	AWG22	
	14	EMG2A	Push-Lock Switch 2A (B contact)	Black/Blue	AWG22	
	15	ENB0B	Enable Switch 0B (A contact)	Black/Pink	AWG22	
	16	ENB0A	Enable Switch 0A (A contact)	LightGreen	AWG22	
	17	ENB1B	Enable Switch 1B (A contact) ^{*3}	Pink	AWG22	
	18	ENB1A	Enable Switch 1A (A contact) ^{*3}	SkyBlue	AWG22	
DC24V I/F	1	+24V	Power Input +24V (to GP2000H)	Black/Green	AWG22	
	2	0V	Power Input 0V (to GP2000H)	Red/Green	AWG22	
	3	FG	Frame Ground	shield		1
Serial I/F	1	RS	Request to Send	Red	AWG28	4
	2	SD	Send Data	Blue	AWG28	2
	3	CS	Clear to Send	Brown	AWG28	5
	4	RD	Receive Data	Orange	AWG28	3
	5	CD	Carrier Detect	Purple	AWG28	8
	6	ER	Enable to Receive	Gray	AWG28	20
	7	+5V	DC +5V±5% Output 0.25A (from GP2000H) ^{*4}	Yellow	AWG28	14
	8	SG	Signal Ground	White	AWG28	7

*1: External Device I/F lines #1 and #3 are reserved. Be sure not to connect anything to these lines.

*2: The DOUT Ground is used in common with External Buzzer Output (BUZZ OUT), DOUT 0 (zero) Output (DOUT0.C), and DOUT 1 (one) Output (DOUT1.C).

*3: Disabled when the GP-H70 Compatible Mode (set via GP2000H) is used.

*4: When connected to the GP2000H, the power used should be a maximum of 0.25A. Be sure not to exceed this level.

A.1.2 GP2000H Series Special Purpose RS-422 Cable (GP2000H-C422-3M/10M)

I/F	No.	Signal Name	Description	Wire Color	Wire Size	Non-GP2000H SIO Pin No.
External Device I/F	1	RESERVE	Reserved ¹	Black/Gray	AWG22	
	2	DOUT0.C	DOUT 0(ZERO) Output	Black/White	AWG22	
	3	RESERVE	Reserved ¹	Red/White	AWG22	
	4	DOUT1.C	DOUT 1(ONE) Output	Green/Brown	AWG22	
	5	OP.GND	OP Ground	Red/Yellow	AWG22	
	6	OP.C	OP Output	Red/Blue	AWG22	
	7	DOUT.GND	DOUT Ground ²	Red/Pink	AWG22	
	8	BUZZ OUT	External Buzzer Output	Black/Orange	AWG22	
	9	EMG0B	Push-Lock Switch 0B (Operates like A contact)	Red/Gray	AWG22	
	10	EMG0A	Push-Lock Switch 0A (Operates like A contact)	White/Orange	AWG22	
	11	EMG1B	Push-Lock Switch 1B (B contact)	Black/Yellow	AWG22	
	12	EMG1A	Push-Lock Switch 1A (B contact)	Green/White	AWG22	
	13	EMG2B	Push-Lock Switch 2B (B contact)	White/Blue	AWG22	
	14	EMG2A	Push-Lock Switch 2A (B contact)	Black/Blue	AWG22	
	15	ENB0B	Enable Switch 0B (A contact)	Black/Pink	AWG22	
	16	ENB0A	Enable Switch 0A (A contact)	LightGreen	AWG22	
	17	ENB1B	Enable Switch 1B (A contact) ³	Pink	AWG22	
	18	ENB1A	Enable Switch 1A (A contact) ³	SkyBlue	AWG22	
DC24V I/F	1	+24V	Power Input +24V (to GP2000H)	Black/Green	AWG22	
	2	0V	Power Input 0V (to GP2000H)	Red/Green	AWG22	
	3	FG	Frame Ground	shield		1
Serial I/F	7	+5V	DC +5V±5% Output 0.25A (from GP2000H) ⁴	Purple	AWG28	14
	8	SG	Signal Ground	Gray	AWG28	7
	13	RDA	Receive Data A	White	AWG28	10
	14	RDB	Receive Data B	Black	AWG28	16
	15	SDA	Send Data A	Yellow	AWG28	11
	16	SDB	Send Data B	Green	AWG28	15
	17	CSA	Clear to Send A	Red	AWG28	21
	18	CSB	Clear to Send B	Blue	AWG28	18
	19	ERA	Enable Receive A	Brown	AWG28	22
20	ERB	Enable Receive B	Orange	AWG28	19	

*1: External Device I/F lines #1 and #3 are reserved. Be sure not to connect anything to these lines.

*2: The DOUT Ground is used in common with External Buzzer Output (BUZZ OUT), DOUT 0 (zero) Output (DOUT0.C), and DOUT 1 (one) Output (DOUT1.C).

*3: Disabled when the GP-H70 Compatible Mode (set via GP2000H) is used.

*4: When connected to the GP2000H, the power used should be a maximum of 0.25A. Be sure not to exceed this level.

A.1.3 GP3000H Hard-type Direct-connect Cable (GP3000H-CBLH-10M)

GP3000H Soft-type Direct-connect Cable (GP3000H-CBLS-3M/5M/10M)

Serial Interface

Wire Color / Marking Color, Number	RS232C		RS422/RS485	
	Signal	Description	Signal	Description
Brown / White 1	CD	Carrier Detect	RDA	Receive Data A (+)
Brown / Black 1	RD (RXD)	Receive Data	RDB	Receive Data B (-)
Brown / White 2	SD (TXD)	Send Data	SDA	Send Data A (+)
Brown / White 4	ER (DTR)	Data Terminal Ready	ERA	Data Terminal Ready A (+)
Brown / None	SG	Signal Ground	SG	Signal Ground
Brown / Black 3	DR (DSR)	Data Set Ready	CSB	Clear to Send B (-)
Brown / Black 2	RS (RTS)	Request to Send	SDB	Send Data B (-)
Brown / White 3	CS (CTS)	Clear to Send	CSA	Clear to Send A (+)
Brown / Black 4	CI (RI) / VCC	Called status display +5V \pm 5% Output 0.25A *1	ERB	Data Terminal Ready B (-)
Green / None	FG *2	Frame Ground (Common with SG)	FG *2	Frame Ground (Common with SG)

*1: The RI/VCC selection is switched via software. The VCC output is not protected against overcurrent. To prevent damage or unit malfunctions, use only the rated current.

*2: Select the AWG22 cable to use out of two green cables. Be sure to twist wires from a part close to the power supply.

Ethernet Interface

Ethernet (IEEE802.3u, 10BASE-T/100BASE-TX) with modular jack connector (RJ-45)

Wire Color	Signal	Direction	Description
Blue	TX +	Output	Ethernet Send (+)
White	TX -	Output	Ethernet Send (-)
Brown	RX +	Input	Ethernet Receive (+)
Gray	RX -	Input	Ethernet Receive (-)

DC24V Interface

Wire Color	Signal	Direction	Description
Red	DC24V	Input	Power Input 24V DC
Black	0V	Input	Power Input 0V
Green	FG *1	-	Frame Ground (Common with SG)

*1: Select the AWG16 cable to use out of two green cables. Be sure to twist wires from a part close to the power supply.

3-Position Enable Switch Output Interface

Wire Color / Marking Color, Number	Signal Name	Description
Blue / Black2	ENB0A	0A (a-contact) Rating: 30V DC, 700mA (min. applicable load: 3V DC, 5mA)
Blue / Black3	ENB0B	0B (a-contact)
Blue / None	ENB1A	1A (a-contact) Rating: 30V DC, 700mA (min. applicable load: 3V DC, 5mA)
Blue / Black1	ENB1B	1B (a-contact)

Emergency Switch Output Interface

Wire Color / Marking Color, Number	Signal Name	Description
Purple / Black 2	EMG0A	0A (a-contact) Rating: 30V DC, 1A (min. applicable load: 5V DC, 1mA)
Purple / White 3	EMG0B	0B (a-contact)
Purple / Black 1	EMG1A	1A (b-contact) Rating: 30V DC, 1A (min. applicable load: 5V DC, 1mA)
Purple / White 2	EMG1B	1B (b-contact)
Purple / None	EMG2A	2A (b-contact) Rating: 30V DC, 1A (min. applicable load: 5V DC, 1mA)
Purple / White 1	EMG2B	2B (b-contact)

Key Switch Output Interface

Wire Color / Marking Color, Number	Signal Name	Description
Orange / None	KEY_NC	b-contact (normally closed) Rating: 24V DC, 300mA
Orange / Black 1	KEY_NO	a-contact (normally open) Rating: 24V DC, 300mA

IMPORTANT

External Output Interface

To use the DOUT, Operation Switch Output, or External Buzzer Output, the GP3000H Conversion Adapter (AGP3000H-ADPCOM-01) is required.

<Connection to GP3000H>

Insert the cable plug to the GP3000H series cable socket until it clicks. To remove it, unlock.

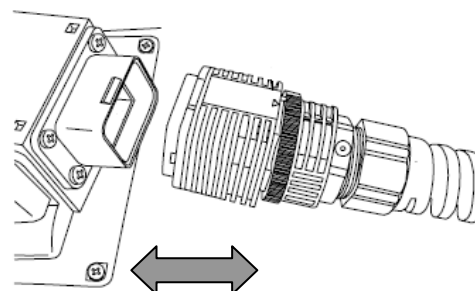

Appendix 2 Interfaces of Conversion Adapters

A.2.1 GP-H70 RS-232C Conversion Adapter (GPH70-AP232-O)

External View

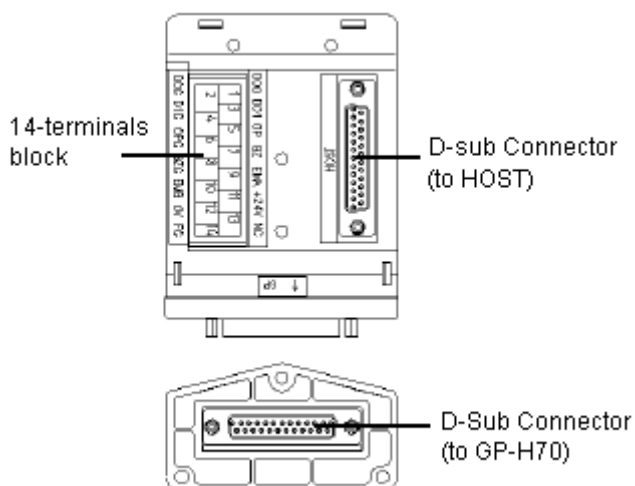

14-terminals Block

(power, external outputs, etc.)

Pin No.	Signal Name(Drawing Name)
1	DOUT0.C (D00)
2	DOUT0.GND (D0G)
3	DOUT1.C (D01)
4	DOUT1.GND (D1G)
5	OP.C (OP)
6	OP.GND (OPG)
7	BUZZ OUT (BZ)
8	BUZZ GND (BZG)
9	EMG A (EMA)
10	EMG B (EMB)
11	+24(in) (+24V)
12	0V (0V)
13	NC (NC)
14	FG (FG)

D-sub Connector (to GP)

Pin No.	Signal Name	Description
1	FG	Frame Ground
2	ER	Enable to Receive (RS-232C)
3	RS	Request to Send (RS-232C)
4	SD	Send Data (RS-232C)
5	+5V	Output +5V (GP-H70)
6	NC	Not Connected
7	DOUT0. GND	DOUT 0 GND
8	DOUT1. GND	DOUT 1 GND
9	OP. GND	OP GND
10	BUZZ GND	External Buzzer Ground
11	EMG B	Push-Lock Switch B
12	0V	Power Input 0V
13	NC	Not Connected
14	SG	Signal Ground
15	CS	Clear to Send (RS-232C)
16	RD	Receive Data (RS-232C)
17	CD	Carrier Detect (RS-232C)
18	NC	Not Connected
19	NC	Not Connected
20	DOUT0. C	DOUT 0 Output
21	DOUT1. C	DOUT 1 Output
22	OP. C	OP Output
23	BUZZ OUT	External Buzzer Output
24	EMG A	Push-Lock Switch A
25	+24V	Power Input +24V

D-sub Connector (to Host)

Pin No.	Signal Name
1	FG
2	SG
3	RD
4	RS
5	CS
7	SG
8	CD
14	+5v(out)
20	ER

A.2.2 GP-H70 RS-422 Conversion Adapter (GPH70-AP422-O)

External View

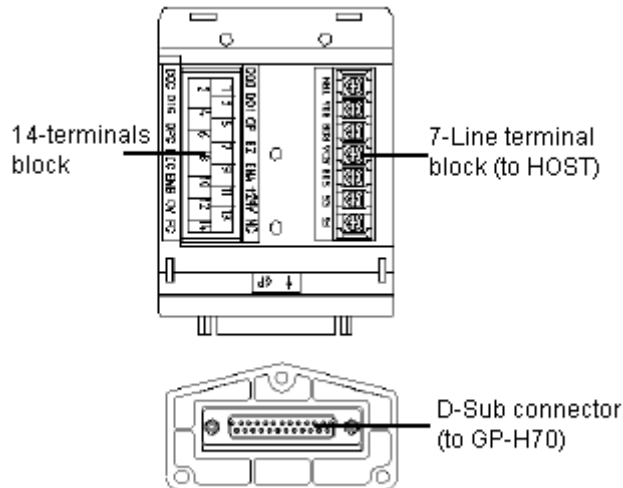

14-terminals Block

(power, external outputs, etc.)

Pin No.	Signal Name(Drawing Name)
1	DOUT0.C (DO0)
2	DOUT0.GND (D0G)
3	DOUT1.C (DO1)
4	DOUT1.GND (D1G)
5	OP.C (OP)
6	OP.GND (OPG)
7	BUZZ OUT (BZ)
8	BUZZ GND (BZG)
9	EMG A (EMA)
10	EMG B (EMB)
11	+24(in) (+24V)
12	0V (0V)
13	NC (NC)
14	FG (FG)

D-sub Connector (to GP)

Pin No.	Signal Name	Description
1	FG	Frame Ground
2	SDB	Send Data B (RS-422)
3	RDB	Receive Data B (RS-422)
4	TRMX	Termination (RS-422)
5	CSA	Clear to Send A (RS-422)* ¹
6	NC	Not Connected
7	DOUT0. GND	DOUT 0 GND
8	DOUT1. GND	DOUT 1 GND
9	OP. GND	OP GND
10	BUZZ GND	External Buzzer Ground
11	EMG B	Push-Lock Switch B
12	0V	Power Input 0V
13	NC	Not Connected
14	SG	Signal Ground
15	SDA	Clear to Send (RS-422)
16	RDA	Receive Data (RS-422)
17	CSB	Carrier Detect (RS-422)* ¹
18	NC	Not Connected
19	+5V	Output +5V (GP-H70)
20	DOUT0. C	DOUT 0 Output
21	DOUT1. C	DOUT 1 Output
22	OP. C	OP Output
23	BUZZ OUT	External Buzzer Output
24	EMG A	Push-Lock Switch A
25	+24V	Power Input +24V

7-terminals Block (to Host)

Pin No.	Signal Name
1	FG
2	SG
3	SDB
4	SDA
5	RDB
6	RDA
7	TRMX (TRM)

*1: In this adapter, pins #5, #14, #17, and #19 have been connected.

A.2.3 GP2000H Series RS-232C Conversion Adapter (GP2000H-AP232)

External View

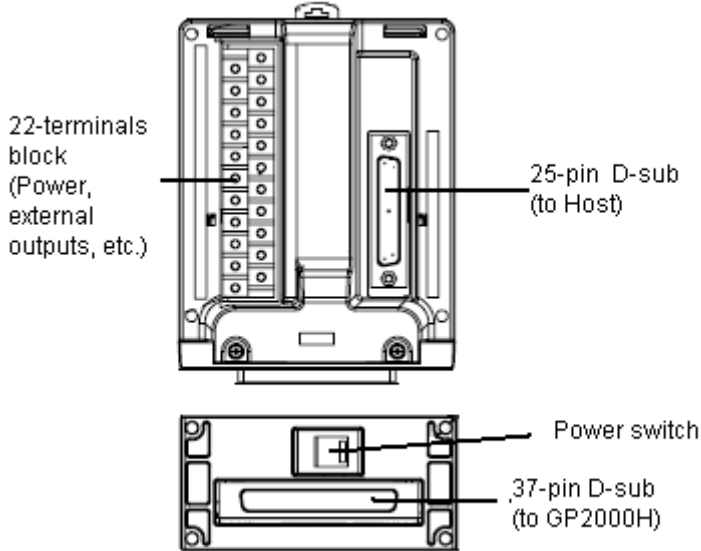

22-terminals Block (power, external outputs, etc.)

Pin No.	Signal Name (Drawing Name)	Description
1	DOUT0.C (D00)	DOUT 0 Output
2	RESERVE	Reserved
3	DOUT1.C (D01)	DOUT 1 Output
4	RESERVE	Reserved
5	OP.C (OP)	OP Output
6	OP.GND (OPG)	OP Ground
7	BUZZ OUT (BZ)	External Buzzer Output
8	DOUT.GND (DOG)	DOUT Ground
9	EMG0A (EM0A)	Push-Lock Switch 0A (Operates like A contact)
10	EMG0B (EM0B)	Push-Lock Switch 0B (Operates like A contact)
11	EMG1A (EM1A)	Push-Lock Switch 1A (B contact)
12	EMG1B (EM1B)	Push-Lock Switch 1B (B contact)
13	EMG2A (EM2A)	Push-Lock Switch 2A (B contact)
14	EMG2B (EM2B)	Push-Lock Switch 2B (B contact)
15	ENB0A (EN0A)	Enable Swith 0A (A contact)
16	ENB0B (EN0B)	Enable Swith 0B (A contact)
17	ENB1A (EN1A)	Enable Swith 1A (A contact) *1
18	ENB1B (EN1B)	Enable Swith 1B (A contact) *1
19	+24V (+24V)	Power Input +24V
20	0V (0V)	Power Input 0V
21	NC (NC)	Not Connected
22	FG (FG)	Frame Ground

*1: Disabled when the GP-H70 Compatible Mode (set via GP2000H) is used.

25-pin D-sub (to Host)

Pin No.	Signal Name	Description
1	FG	Frame Ground
2	SD	Send Data
3	RD	Receive Data
4	RS	Request to Send
5	CS	Clear to Send
7	SG	Signal Ground
8	CD	Carrier Detect
14	+5V	DC +5V±5% Output 0.25A
20	ER	Enable to Receive

37-pin D-sub (to GP2000H)

Pin No.	Signal Name	Description
1	FG	Frame Ground
2	FG	Frame Ground
3	ER	Enable to Receive
4	NC	Not Connected
5	NC	Not Connected
6	+5V	DC +5V±5% Output 0.25A (from GP2000H)
7	CD	Carrier Detect
8	RD	Receive Data
9	NC	Not Connected
10	RESERVE	Reserved
11	RESERVE	Reserved
12	OP.GND	OP Ground
13	DOUT.GND	DOUT Ground
14	EMG0B	Push-Lock Switch 0B (Operates like A contact)
15	EMG1B	Push-Lock Switch 1B (B contact)
16	EMG2B	Push-Lock Switch 2B (B contact)
17	ENB0B	Enable Switch 0B (A contact)
18	ENB1B	Enable Switch 1B (A contact) **1
19	0V	Power Input 0V (to GP2000H)
20	FG	Frame Ground
21	SD	Send Data
22	RS	Request to Send
23	NC	Not Connected
24	NC	Not Connected
25	SG	Signal Ground
26	CS	Clear to Send
27	NC	Not Connected
28	DOUT0.C	DOUT 0 Output
29	DOUT1.C	DOUT 1 Output
30	OP.C	OP Output
31	BUZZ OUT	External Buzzer Output
32	EMG0A	Push-Lock Switch 0A (Operates like A contact)
33	EMG1A	Push-Lock Switch 1A (B contact)
34	EMG2A	Push-Lock Switch 2A (B contact)
35	ENB0A	Enable Switch 0A (A contact)
36	ENB1A	Enable Switch 1A (A contact) **1
37	+24V	Power Input +24V (to GP2000H)

*1: Disabled when the GP-H70 Compatible Mode (set via GP2000H) is used.

A.2.4 GP2000H Series RS-422 Conversion Adapter (GP2000H-AP422)

External View

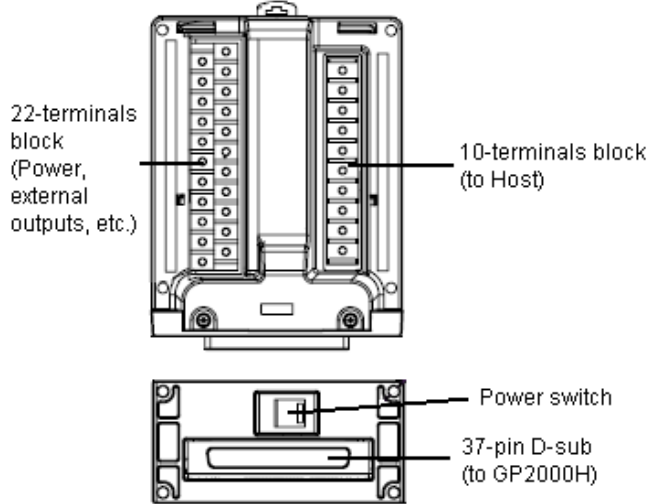

22-terminals Block (power, external outputs, etc.)

Pin No.	Signal Name (Drawing Name)	Description
1	DOUT0.C (DO0)	DOUT 0 Output
2	RESERVE	Reserved
3	DOUT1.C (DO1)	DOUT 1 Output
4	RESERVE	Reserved
5	OP.C (OP)	OP Output
6	OP.GND (OPG)	OP Ground
7	BUZZ OUT (BZ)	External Buzzer Output
8	DOUT.GND (DOG)	DOUT Ground
9	EMG0A (EM0A)	Push-Lock Switch 0A (Operates like A contact)
10	EMG0B (EM0B)	Push-Lock Switch 0B (Operates like A contact)
11	EMG1A (EM1A)	Push-Lock Switch 1A (B contact)
12	EMG1B (EM1B)	Push-Lock Switch 1B (B contact)
13	EMG2A (EM2A)	Push-Lock Switch 2A (B contact)
14	EMG2B (EM2B)	Push-Lock Switch 2B (B contact)
15	ENB0A (EN0A)	Enable Swith 0A (A contact)
16	ENB0B (EN0B)	Enable Swith 0B (A contact)
17	ENB1A (EN1A)	Enable Swith 1A (A contact) *1
18	ENB1B (EN1B)	Enable Swith 1B (A contact) *1
19	+24V (+24V)	Power Input +24V
20	0V (0V)	Power Input 0V
21	NC (NC)	Not Connected
22	FG (FG)	Frame Ground

*1: Disabled when the GP-H70 Compatible Mode (set via GP2000H) is used.

10-terminals Block (to Host)

Pin No.	Signal Name	Description
1	FG	Frame Ground
2	SG	Signal Ground
3	SDB	Send Data B
4	SDA	Send Data A
5	RDB	Receive Data B
6	RDA	Receive Data A
7	CSA	Clear to Send A ^{*1}
8	ERA	Enable Receive A ^{*1}
9	CSB	Clear to Send B ^{*1}
10	ERB	Enable Receive B ^{*1}

*1: Pins #7 (CSA), #8 (ERA), #9 (CSB), and #10 (ERB) are shorted together with shorting clips at the factory.

37-pin D-sub (to GP2000H)

Pin No.	Signal Name	Description
1	FG	Frame Ground
2	FG	Frame Ground
3	NC	Not Connected
4	ERB	Enable Receive B
5	CSB	Clear to Send B
6	+5V	DC +5V±5% Output 0.25A (from GP2000H)
7	SDB	Send Data B
8	RDB	Receive Data B
9	NC	Not Connected
10	RESERVE	Reserved
11	RESERVE	Reserved
12	OP.GND	OP Ground
13	DOUT.GND	DOUT Ground
14	EMG0B	Push-Lock Switch 0B (Operates like A contact)
15	EMG1B	Push-Lock Switch 1B (B contact)
16	EMG2B	Push-Lock Switch 2B (B contact)
17	ENB0B	Enable Switch 0B (A contact)
18	ENB1B	Enable Switch 1B (A contact) ^{*1}
19	0V	Power Input 0V (to GP2000H)
20	FG	Frame Ground
21	NC	Not Connected
22	NC	Not Connected
23	ERA	Enable Receive A
24	CSA	Clear to Send A
25	SG	Signal Ground
26	SDA	Send Data A
27	RDA	Receive Data A
28	DOUT0.C	DOUT 0 Output
29	DOUT1.C	DOUT 1 Output
30	OP.C	OP Output
31	BUZZ OUT	External Buzzer Output
32	EMG0A	Push-Lock Switch 0A (Operates like A contact)
33	EMG1A	Push-Lock Switch 1A (B contact)
34	EMG2A	Push-Lock Switch 2A (B contact)
35	ENB0A	Enable Switch 0A (A contact)
36	ENB1A	Enable Switch 1A (A contact) ^{*1}
37	+24V	Power Input +24V (to GP2000H)

*1: Disabled when the GP-H70 Compatible Mode (set via GP2000H) is used.

A.2.5 GP3000H Conversion Adapter (AGP3000H-ADPCOM-01)

External View

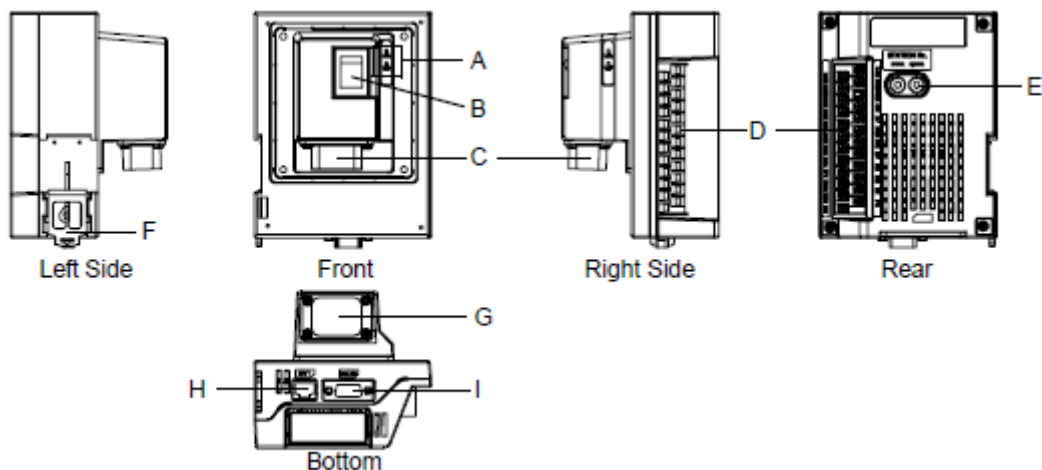

A	LED	The color changes depending on the GP's status.
B	Power Switch	I: ON, O:OFF
C	External Interface	Connect the GP3000H Conversion Adapter Connection Cable to the GP unit.
D	24-terminals block	Connect DOUT signals and other external outputs, power supply lines, etc. Use a self-created cable.
E	Rotary Switch	Sets the ID number for this adapter. *1
F	DIN Rail Hook	For mounting to a DIN rail (35mm [1.38 inch])
G	Connector Cover	Remove when connecting the GP3000H Conversion Adapter Connection Cable.
H	Ethernet Interface	The Ethernet transmission interface (10BASE-T/100BASE-TX). An RJ-45 type modular jack connector (8-terminals) is used.
I	Serial Interface	RS232C/RS422/RS485 serial interface 9-pin D-sub plug type connector The communication method is switched via software.

*1: The GP stores the ID number for the conversion adapter in the system variable [#H_MachineNo] at fixed intervals to make sure it recognizes the conversion adapter is connected to the GP correctly. For details on system variables, refer to the GP-Pro EX Reference Manual.

D: 24-terminals Block (power, external outputs, etc.)

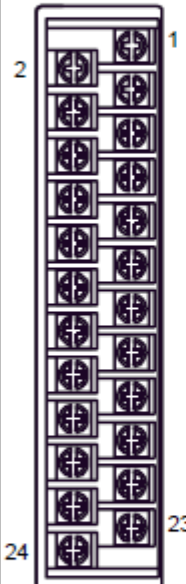
Pin Arrangement	Pin No.	Signal Name	Description
 <p>(Conversion adapter side)</p>	1	DC24V	Power Input DC24V
	2	0V	Power Input 0V
	3	FG	Frame Ground (Common with SG)
	4	KEY_COM ^{*1}	Key Switch Common. When this adapter's power on, DC24V is output. Rating: DC24V±20%, 200mA
	5	KEY_NO	Key Switch a-contact (normally open)
	6	KEY_NC	Key Switch b-contact (normally closed)
	7	ENB0A	3-position operation switch 0A (a-contact: normally open) Rating: DC30V, 700mA (Minimum applicable load: DC3V, 5mA)
	8	ENB0B	3-position operation switch 0B (a-contact : normally open)
	9	ENB1A	3-position operation switch 1A (a-contact : normally open) Rating: DC30V, 700mA (Minimum applicable load: DC3V, 5mA)
	10	ENB1B	3-position operation switch 1B (a-contact : normally open)
	11	EMG0A	Emergency switch 0A (a-contact : normally open) Rating: DC30V, 1A (Minimum applicable load: DC5V, 1mA)
	12	EMG0B	Emergency switch 0B (a-contact : normally open)
	13	EMG1A	Emergency switch 1A (b-contact : normally closed) Rating: DC30V, 1A (Minimum applicable load: DC5V, 1mA)
	14	EMG1B	Emergency switch 1B (b-contact : normally closed)
	15	EMG2A	Emergency switch 2A (b-contact : normally closed) Rating: DC30V, 1A (Minimum applicable load: DC5V, 1mA)
	16	EMG2B	Emergency switch 2B (b-contact : normally closed)
	17	OP	OP. Output Open collector: DC24V, 300mA
	18	OP_GND	OP. GND
	19	DOUT1	DOUT1 Output Open collector: DC24V, 300mA
	20	DOUT1_GND	DOUT1 GND
	21	DOUT0	DOUT0 Output Open collector: DC24V, 300mA
	22	DOUT0_GND	DOUT0 GND
	23	BUZZ	Buzzer Output Open collector: DC24V, 300mA
	24	BUZZER_GND	BUZZER GND

I: Serial Interface

Communication method: RS232C/RS422/RS485
 Asynchronous communication method

Data length: 7 bit / 8 bit

Parity: Odd / Even / None

Stop bit: 1 bit / 2 bit

Baud rate: 2400bps to 115.2kbps, 187.5kbps(MPI)

Max. communication distance: 15m (RS-232C), 1200m (RS-422, 115.2kbps)
 (Includes length of the cable between the GP and this adapter)

Pin #	RS232C		RS422/RS485	
	Signal Name	Description	Signal Name	Description
1	CD	Carrier Detect	RDA	Receive Data A(+)
2	RD(RXD)	Receive Data	RDB	Receive Data B(-)
3	SD(TXD)	Send Data	SDA	Send Data A(+)
4	ER(DTR)	Data Terminal Ready	ERA	Data Terminal Ready A(+)
5	SG	Signal Ground	SG	Signal Ground
6	DR(DSR)	Data Set Ready	CSB	Clear to Send B(-)
7	RS(RTS)	Request to Send	SDB	Send Data B(-)
8	CS(CTS)	Clear to Send	CSA	Clear to Send A(+)
9	CI(RI)/VCC	Called status display/ +5V±5% Output 0.25A*1	ERB	Data Terminal Ready B(-)
Shell	FG	Frame Ground (Common with SG)	FG	Frame Ground (Common with SG)

*1: The RI/VCC selection for the pin #9 is switched via software. The VCC output is not protected against overcurrent. To prevent damage or unit malfunctions, use only the rated current.