

6



Writing Device/PLC Data in Excel File

6.1	Monitoring Device Value on Excel.....	6-2
6.2	Correcting and Restoring Once Read Data	6-34
6.3	Setting Guide	6-62
6.4	Restrictions	6-69

6.1 Monitoring Device Value on Excel

-
- NOTE** • To read next data while keeping data read on Excel, refer to "5 Creating a Form Using Excel".
Since this function is One-Shot action, data is overwritten in the next capturing action.
-

[Action Example]

Detect the rising of the trigger device (Bit device: "M01") of Device/PLC, write 5 device values of device address (Word device: address "D50" to "D54") onto an Excel file, and monitor.

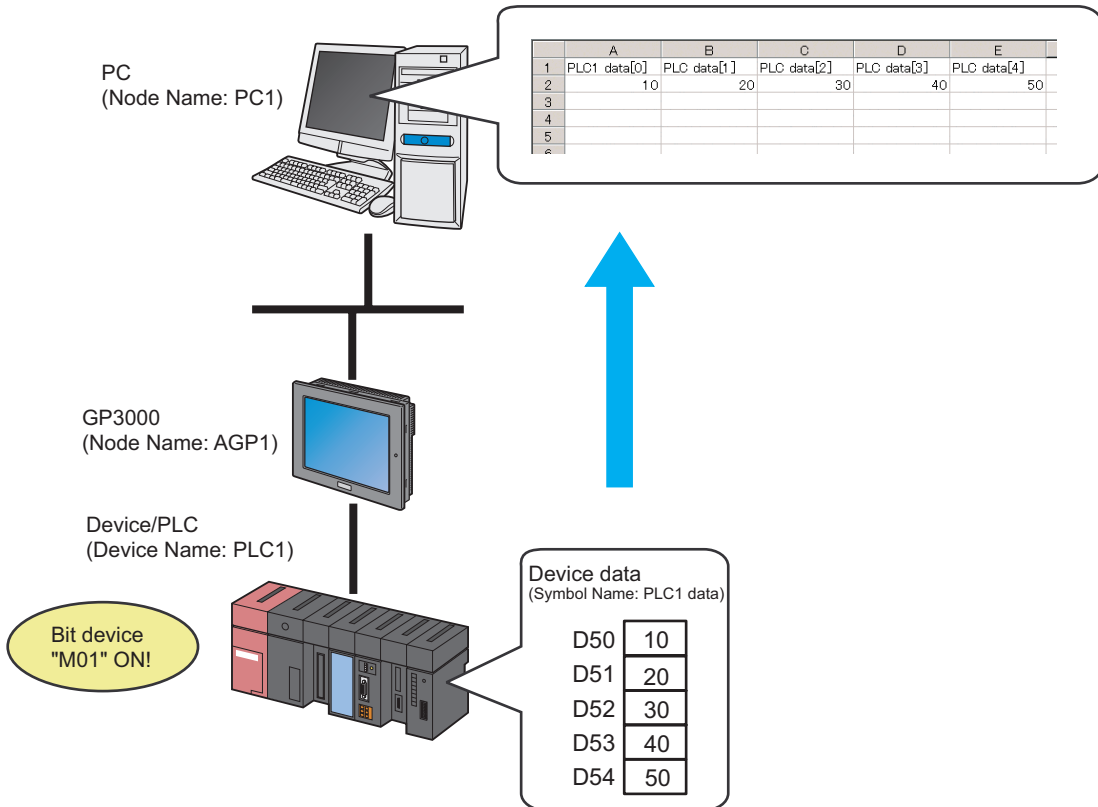

This section describes the setting procedures for executing the above action (ACTION) as an example.

-
- NOTE** • Use only sequential address to write on an Excel file. If you specify non-sequential address, use a group symbol.
• For more details about a group symbol, refer to "29.2 Grouping Symbols".
-

[Setting Procedure]

1	Creating a Template	This step creates a template to write device data of Device/PLC on.
↓		
2	Starting 'Pro-Studio EX'	This step starts 'Pro-Studio EX'.
↓		
3	Registering Entry Nodes	This step registers the PC and the GPs as entry nodes.
↓		
4	Registering Symbols	This step registers as a symbol the device of Device/PLC from which data is read.
↓		
5	Specifying an Excel Template and its Output Book	This step sets the following items: <ul style="list-style-type: none"> • Specify a template book • Specify an output book
↓		
6	Setting Content of an Excel Template	This step sets the following items: <ul style="list-style-type: none"> • Set device to read • Set write layout
↓		
7	Setting ACTION Node/Process Completion Notification	This step sets the name of an ACTION node and the alert setting whether it should be tuned on or off when the ACTION is completed.
↓		
8	Verifying Setting Result	This step verifies setting results on the setting content list screen.
↓		
9	Saving a Network Project File	This step saves the current settings as a network project file and reloads.
↓		
10	Transferring a Network Project File	This step transfers a saved network project file to the GP.
↓		
11	Executing ACTION	This step verifies that the data of Device/PLC is written in the specified area of Excel when the preset trigger condition has become effective.

6.1.1 Creating a Template

This step creates a template to write device data of Device/PLC on.

1 Start 'Microsoft Excel'.

Leave the template blank to write data in.

You can write each data on space below when executing action.

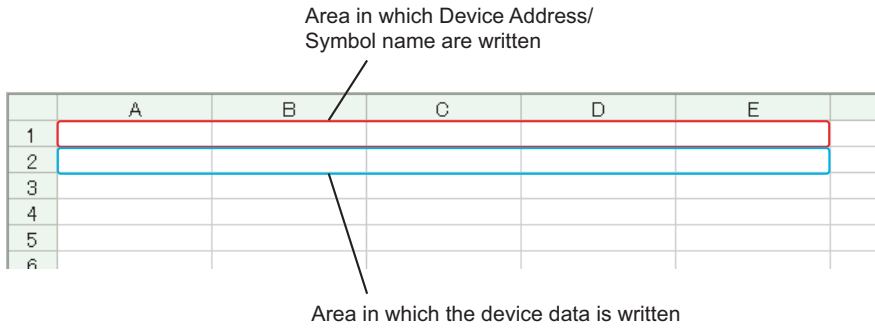

2 Save the file on PC desktop naming "template.xls".

6.1.2 Starting 'Pro-Studio EX'

This step starts 'Pro-Studio EX'.

Refer to "3 Trial of Pro-Server EX" for details about starting method.

6.1.3 Registering Entry Nodes

This step registers the PC and the GP connected with network as nodes.

Refer to "31 Node Registration" for details about entry nodes.



Node Name : PC1

IP Address : 192.168.0.1



Node Name : AGP1

IP Address : 192.168.0.100

Device/PLC Information

Ex.

Entry node	Setting item	Setting example
PC	Node Name	PC1
	IP Address	192.168.0.1
GP	Type	GP3000 series
	Node Name	AGP1
	IP Address	192.168.0.100

6.1.4 Registering Symbols

This step registers as a symbol the device address of Device/PLC from which data is read.
Refer to "32 Symbol Registration" for details about symbols.

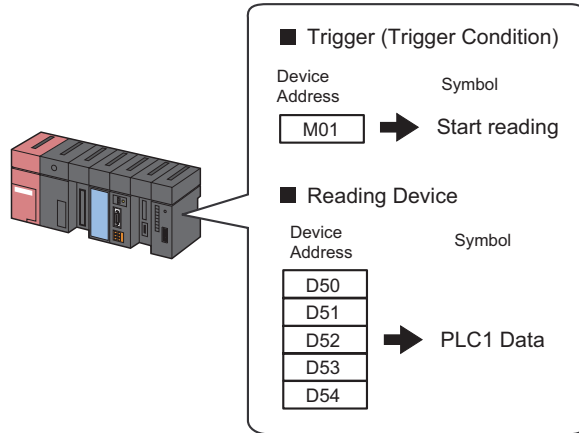

Ex.

- Trigger (Trigger Condition)

Setting item	Setting content
Symbol Name	Start reading
Data Type	Bit
Device address for symbol registration	"01" of Device/PLC (PLC1)
No. of Devices	1

- Reading Device

Setting item	Setting content
Symbol Name	PLC1 data
Data Type	16Bit (Signed)
Device address for symbol registration	"D50" to "D54" of Device/PLC (PLC1)
No. of Devices	5

6.1.5 Specifying an Excel Template and its Output Book

Specify the form template and output book created in (1).

Refer to "6.3 Setting Guide" for more details.

Ex.

Setting item		Setting content
Specify a Template	Template Book	C:\Documents and Settings\Administrator\Desktop\templete.xlt
Output Book	Folder Name	C:\Documents and Settings\Administrator\Desktop
	File Name	monitor.xls
	Start with the output book displayed	Checked
	Do not save the output file when ACTION runs.	Not checked

1 Click the [Feature] icon on the status bar.

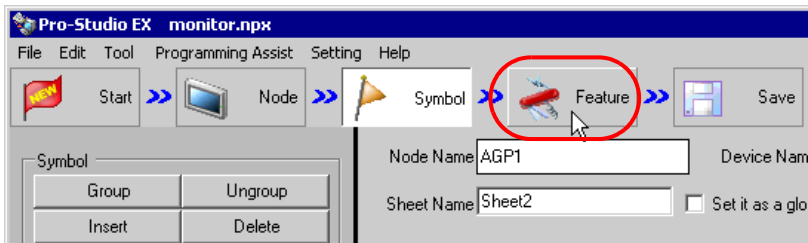

2 Select [ACTION] from the tree display on the left of the screen, then click the [Add] button.

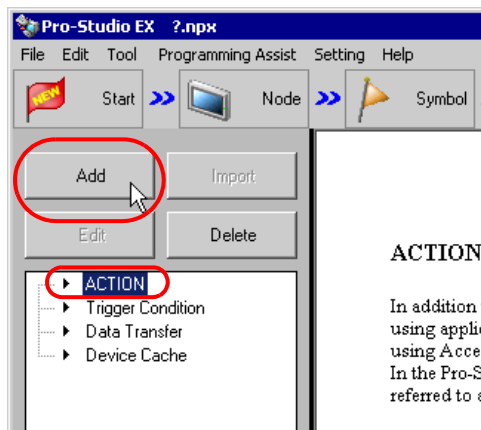

3 Click the [ACTION Type] list button, and select "Create form using Excel".

Then, enter the name of ACTION to set in the [ACTION Name] field. In this example, enter "Monitor".

NOTE • [ACTION Name] can be an arbitrary name.

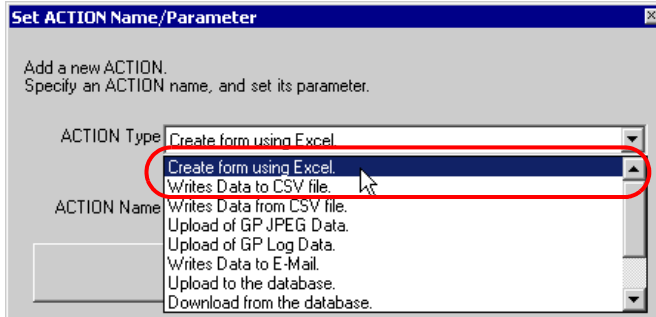

4 Click the [Click here to set the ACTION parameter] button.

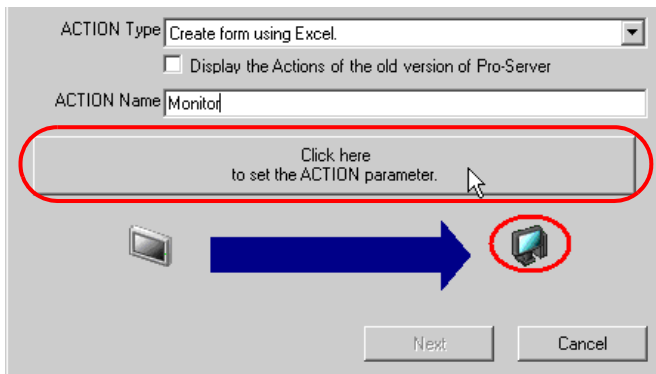

5 Set an Excel template and its output book.

- 1) Click the [Reference] button of [Template File] to set the Excel file "template.xls" which you created.

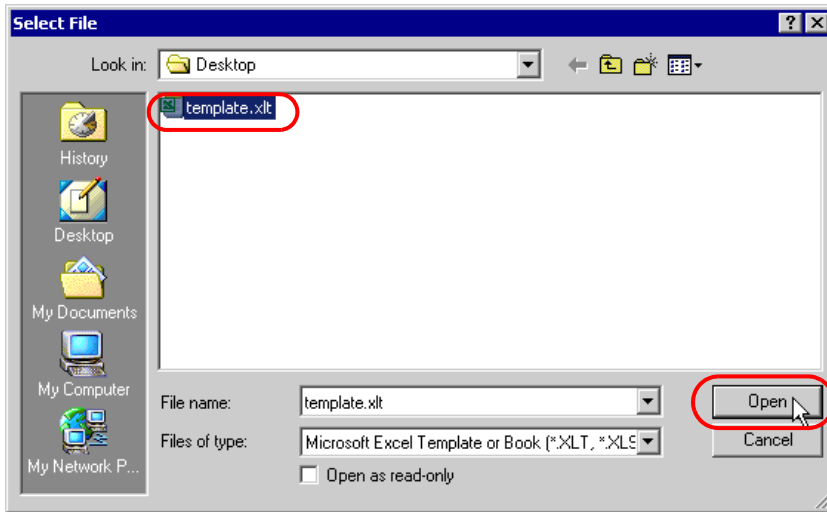
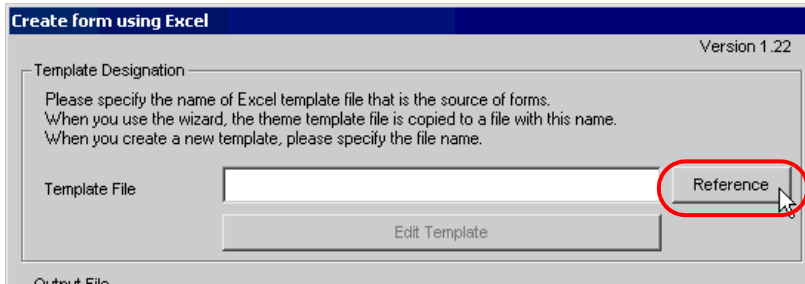

- 2) Click the [Reference] button of [Folder Name] and specify "Desktop" as a folder to save the output book.

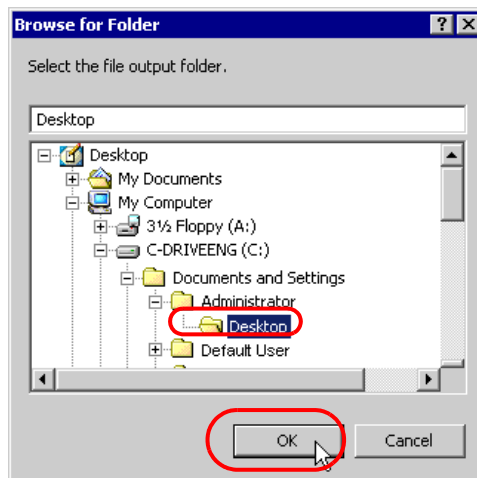
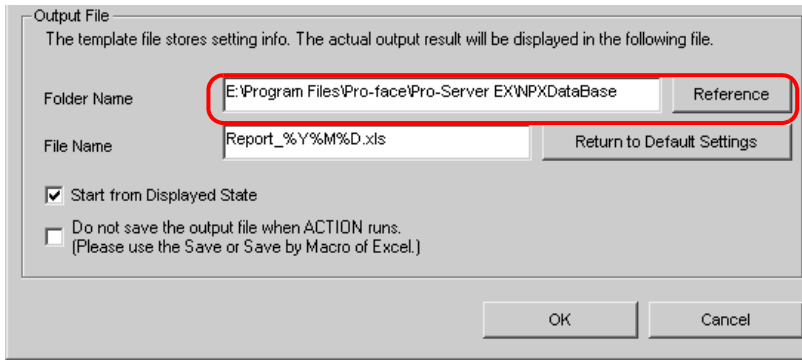

- 3) Set the file name "monitor.xls" for the output book to set.

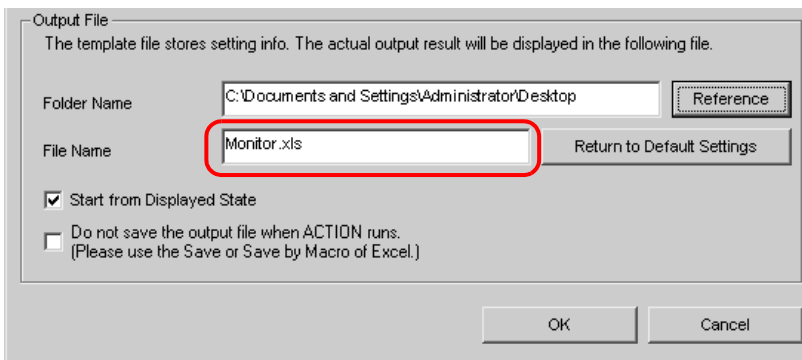

NOTE

- "%Y%M%D" is preset as "Year/Month/Date". For more details, refer to "37.1 Restrictions on Names".

- 4) Check the [Start from Displayed State] check box.

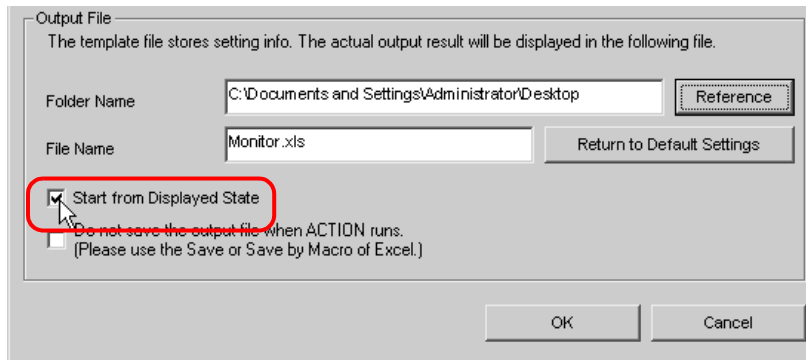

NOTE

- If you check [Start from Displayed State], you can read/write data with an output book displayed. This is useful if you need to confirm data immediately.
-

6.1.6 Setting Content of an Excel Template

Set the content of an Excel template to monitor data on Excel.

The example below shows the setting of data write area (Device one-shot area) in a template.

Refer to "6.3 Setting Guide" for more details.

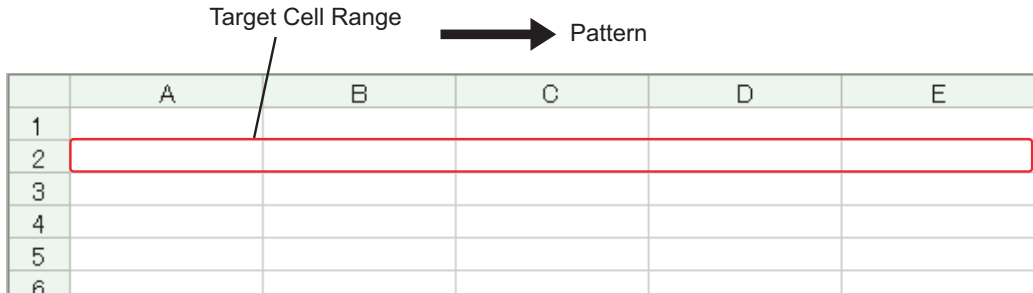

Ex.

Setting item	Setting content
Entry Node	AGP1
Device Name	PLC1
Device Address/Symbol Group	PLC1 data
Add Device Address/Symbol Group	Checked
Target Cell Range	1 to E2
Pattern	Z type
Trigger Condition Name	Turn on read start bit
Trigger Condition	When "Start reading" (M01) is ON

- 1 Click the [Edit Template] button.

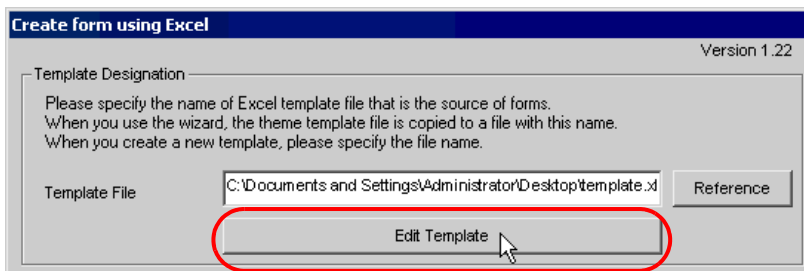

The Excel template will appear.

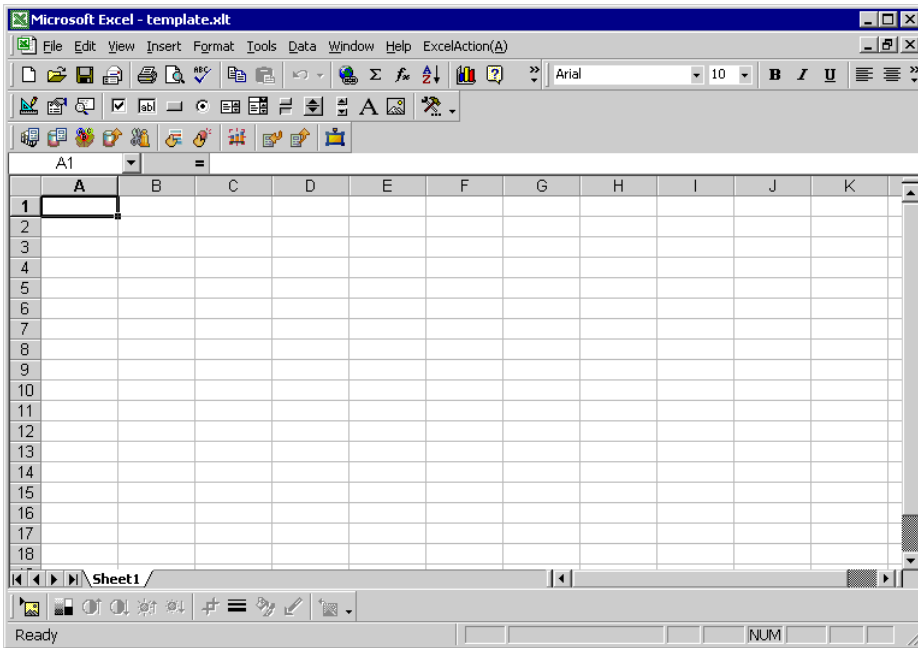

2 Set a data write area.

- 1) Click the [Device One-Shot Area] icon on Excel.

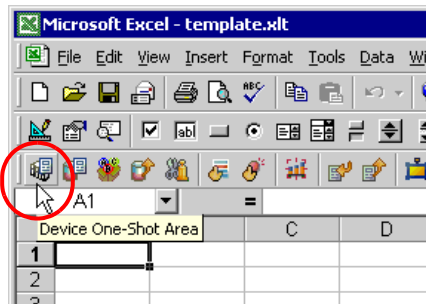

The "Device OneShot" screen will appear.

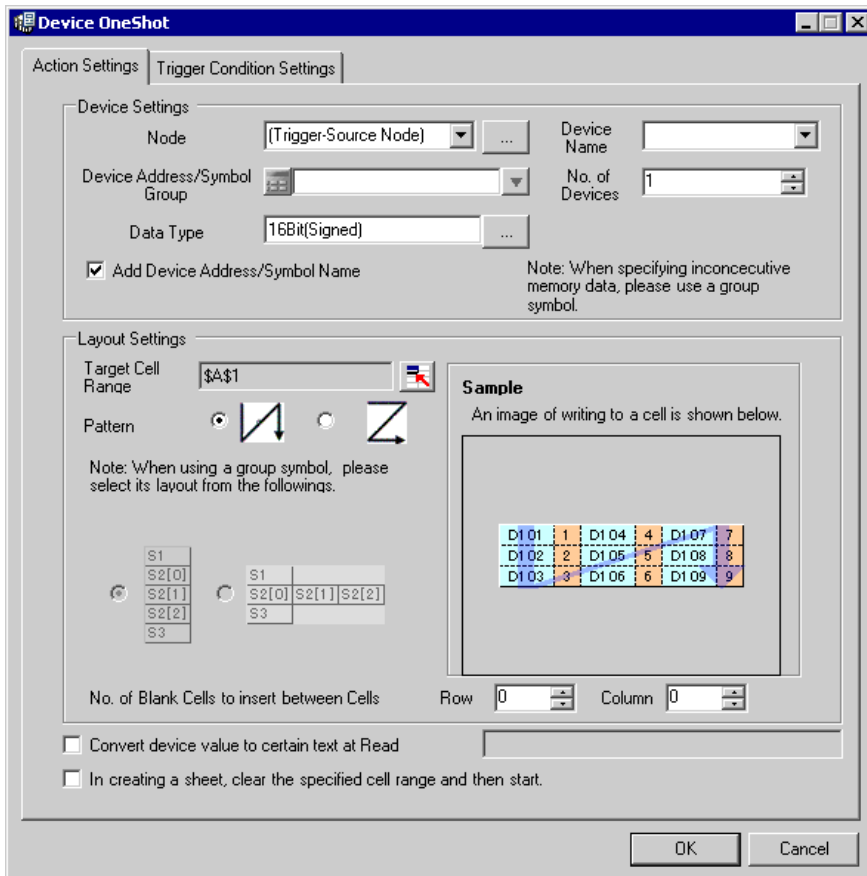

NOTE • Selecting "Device One-Shot Area" from [Excel Action] of the menu displays the same screen.

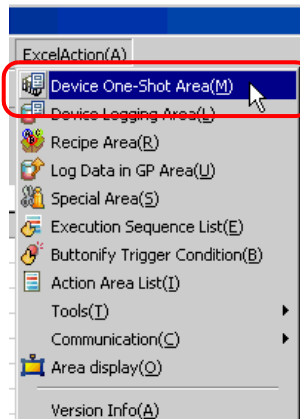

- Click the list button of [Node] and select "AGP1" as a data transfer source node.

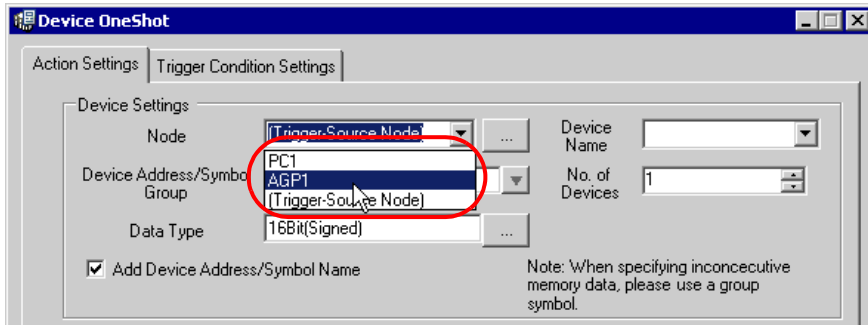

- Click the list button of [Device Name] and select "PLC1" as a data transfer source device.

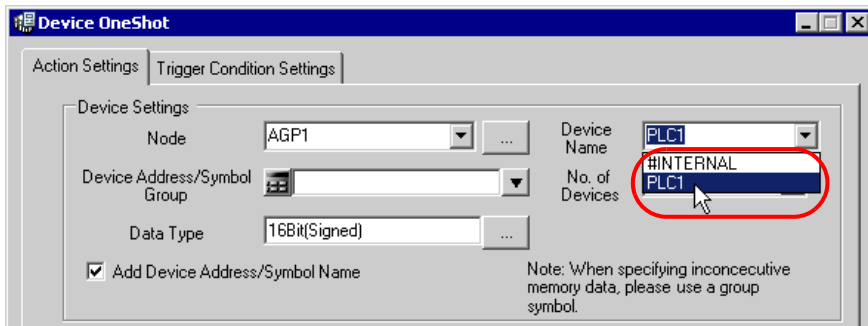

- Click the list button of [Device Address/Symbol Group] and select "PLC1 data" as a symbol of the data to read out.

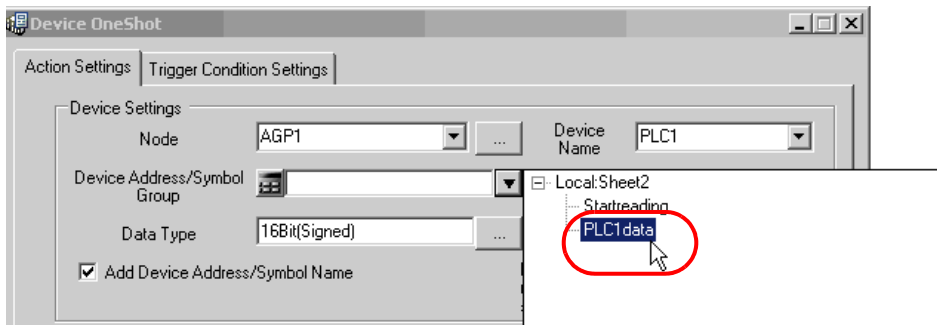

The device number "5" will be automatically entered in [No. of Devices], and "16Bit(Signed)" in [Data Type].

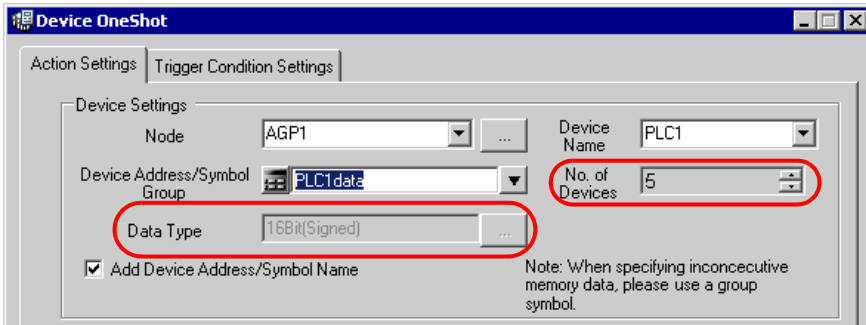

5) Check [Add Device Address/Symbol Name].

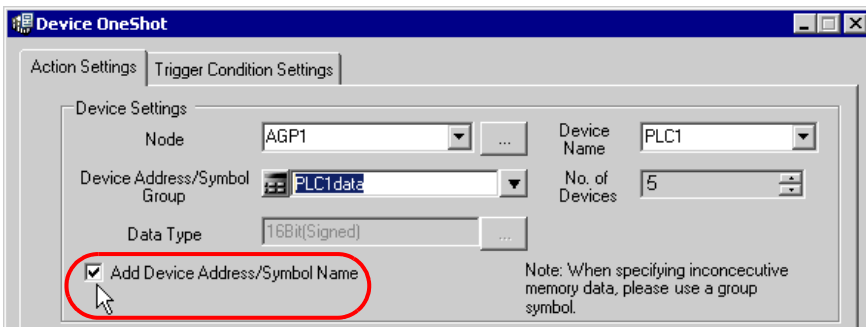

NOTE

- Device Address/Symbol Name is to appear in the right or upper cell of the data read in Excel. Refer to [Sample] on screen.

- Click the cell range specify button of [Target Cell Range].

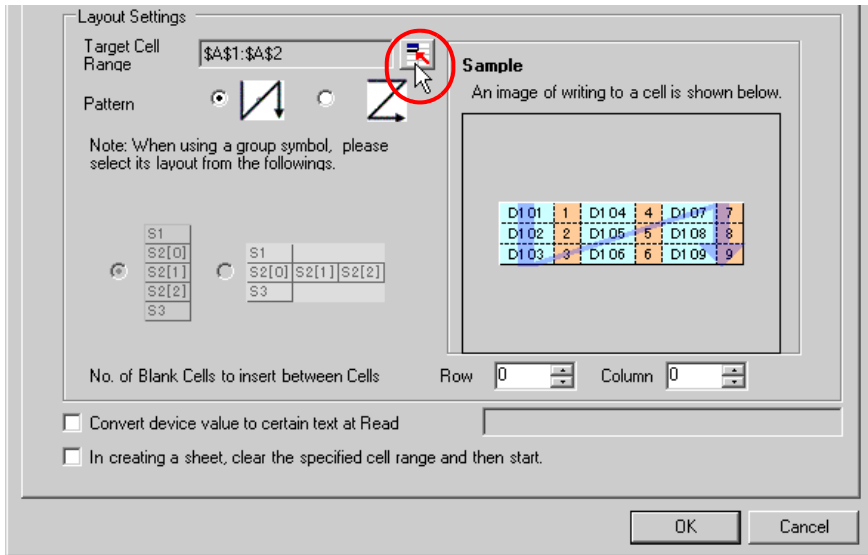

- Drag the mouse to specify the data write area (cells A1 to E2). Then click the [OK] button.

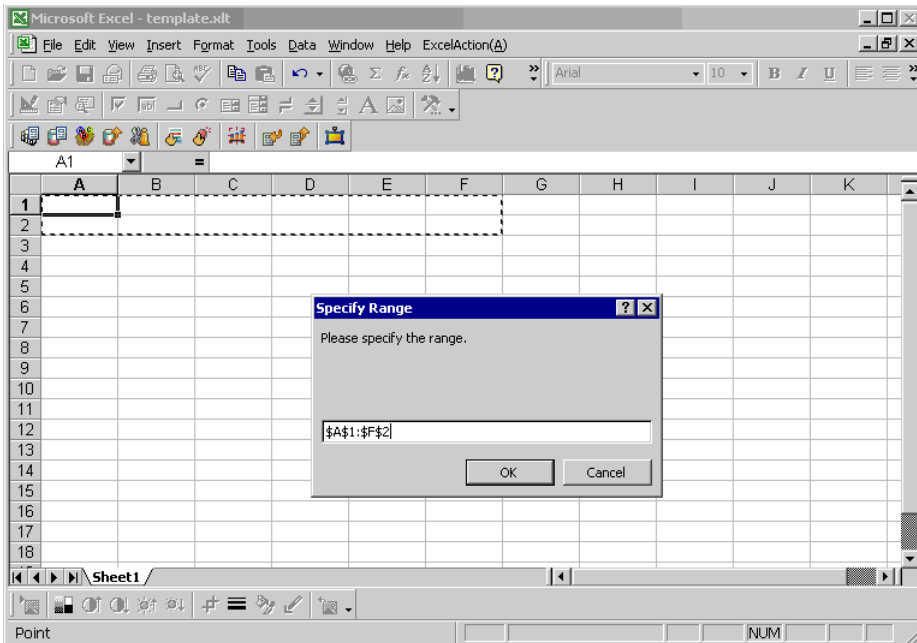

- 8) Select "Z type" of [Pattern].

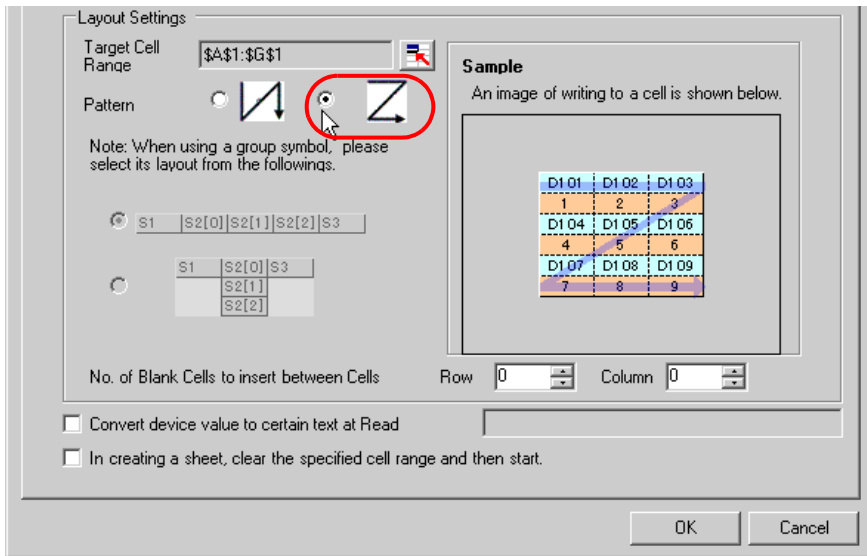

3 Set trigger conditions.

- 1) Click the [Trigger Condition Settings] tab.

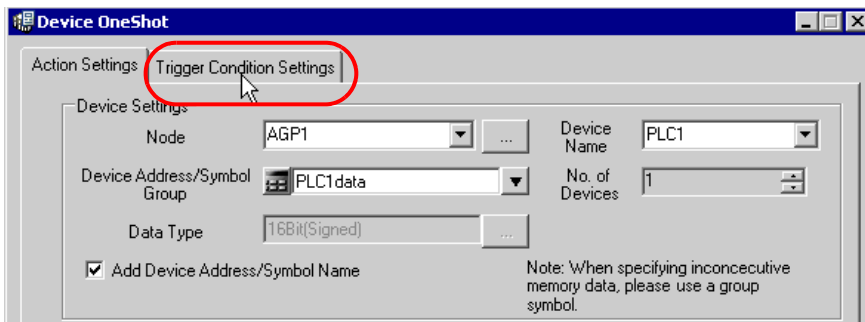

The "Trigger Condition Settings" screen will appear.

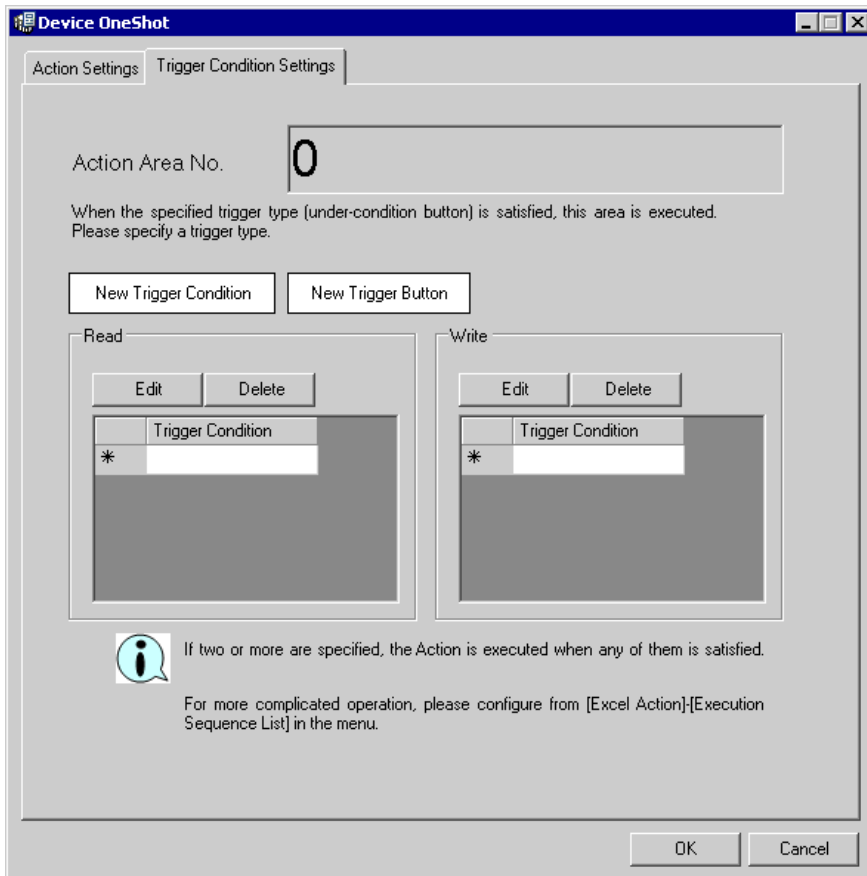

- 2) Click the [New Trigger Condition] button.

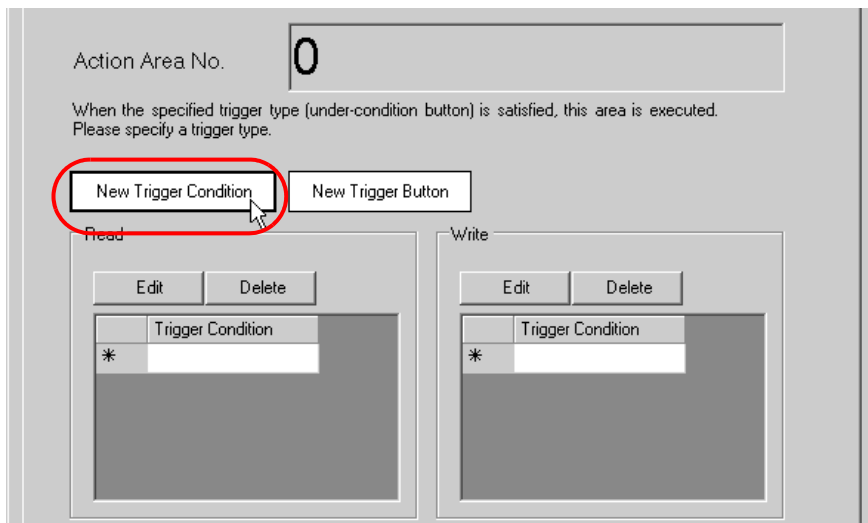

- 3) Click the [New Trigger Condition] button.

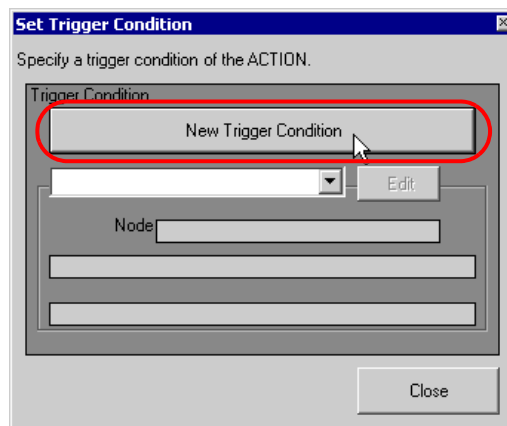

- 4) Enter the trigger condition name "TurnOnReadStartBit" in [Trigger Condition Name], and select "AGP1" in [Node Name] as a name of the data transfer source.

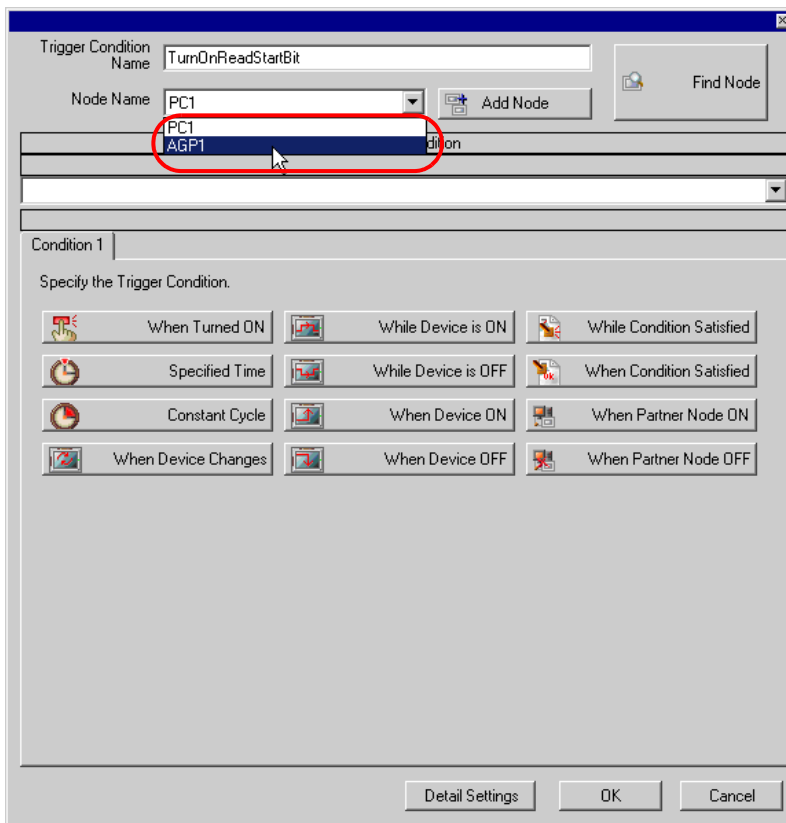

- 5) Click the [When Device ON] button in the [Condition 1] tab and select "PLC1" for the device name.

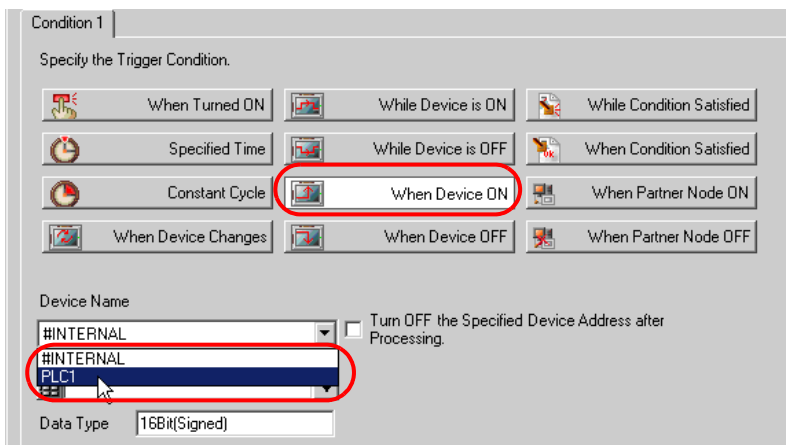

- 6) Click the [Device Address] list button and select "Start reading" for the device symbol name which serves as a trigger.

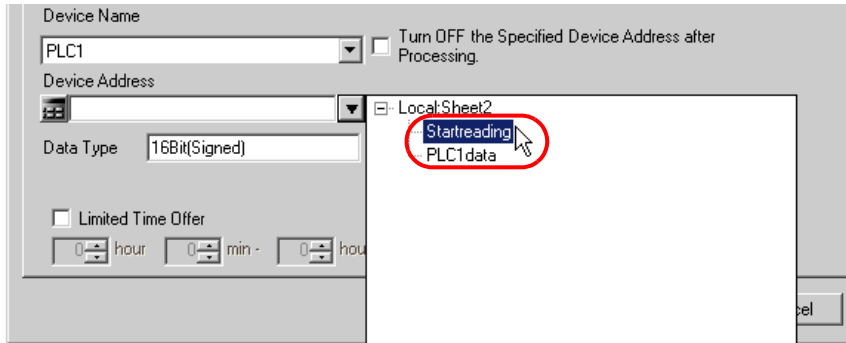

[Data Type] automatically appears after selection, too.

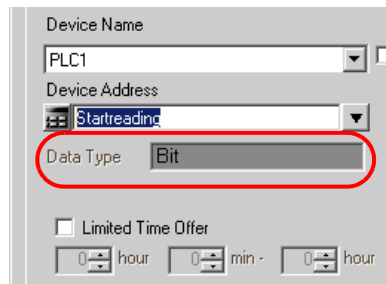

- 7) Click the [OK] button.

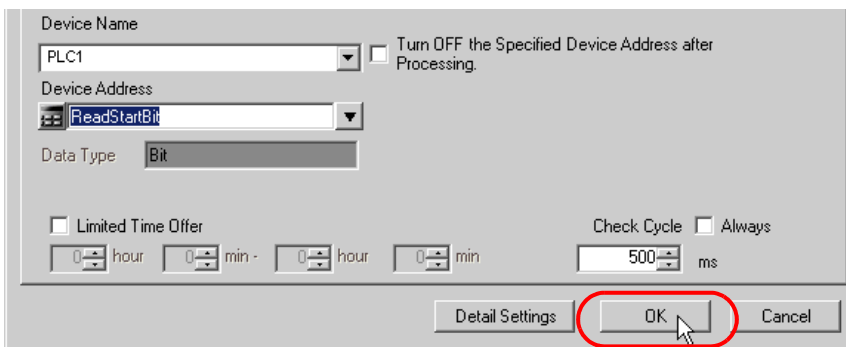

- 8) Click the [Close] button.

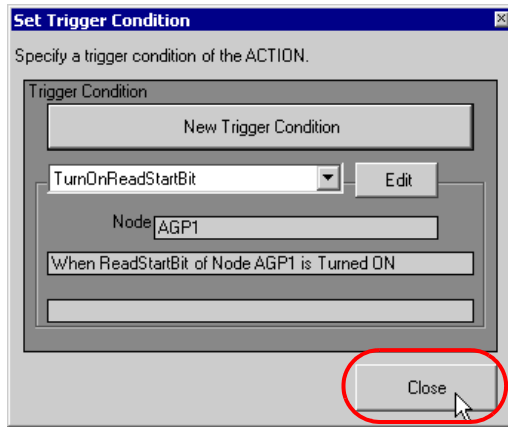

- 9) Click the blank line of [Trigger Condition] of [Logging].

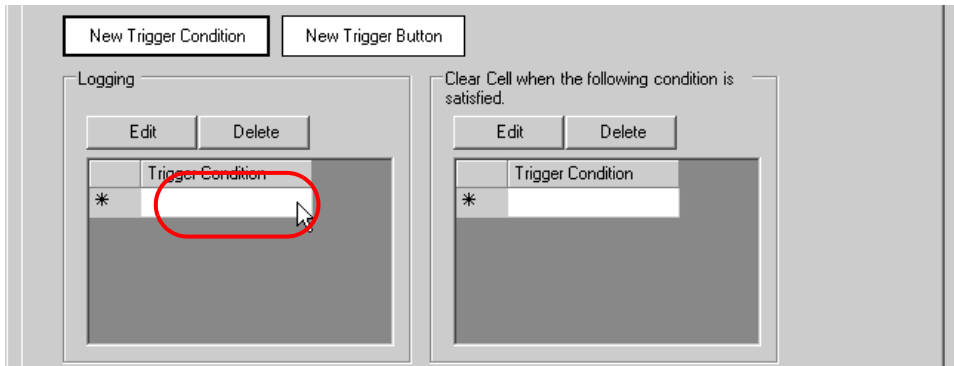

10) Click the list button and select "TurnOnReadStartBit" as a trigger condition.

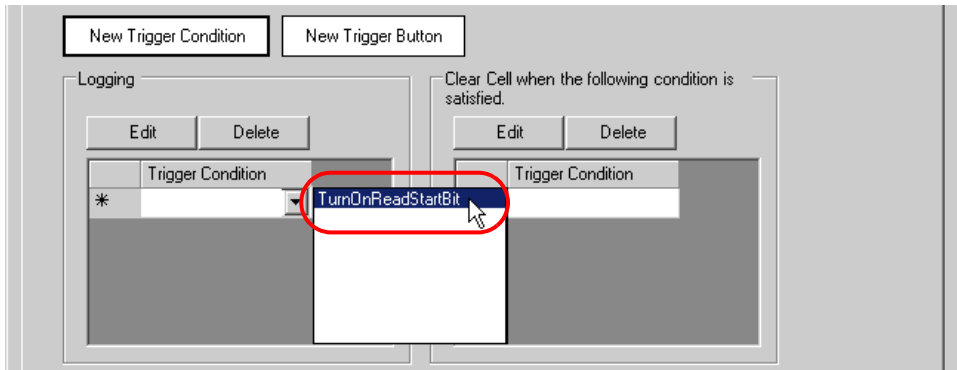

11) Click the [OK] button.

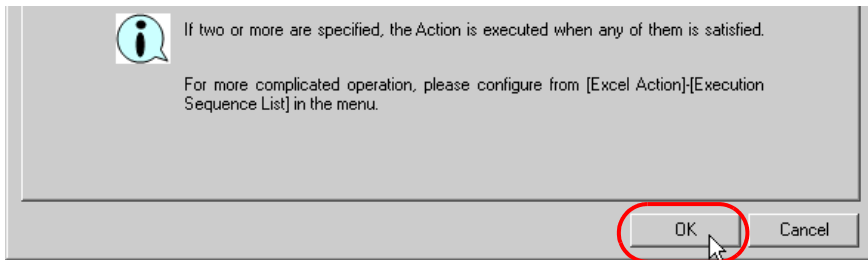

This is the end of the content settings of an Excel template.

4 Close "Excel".

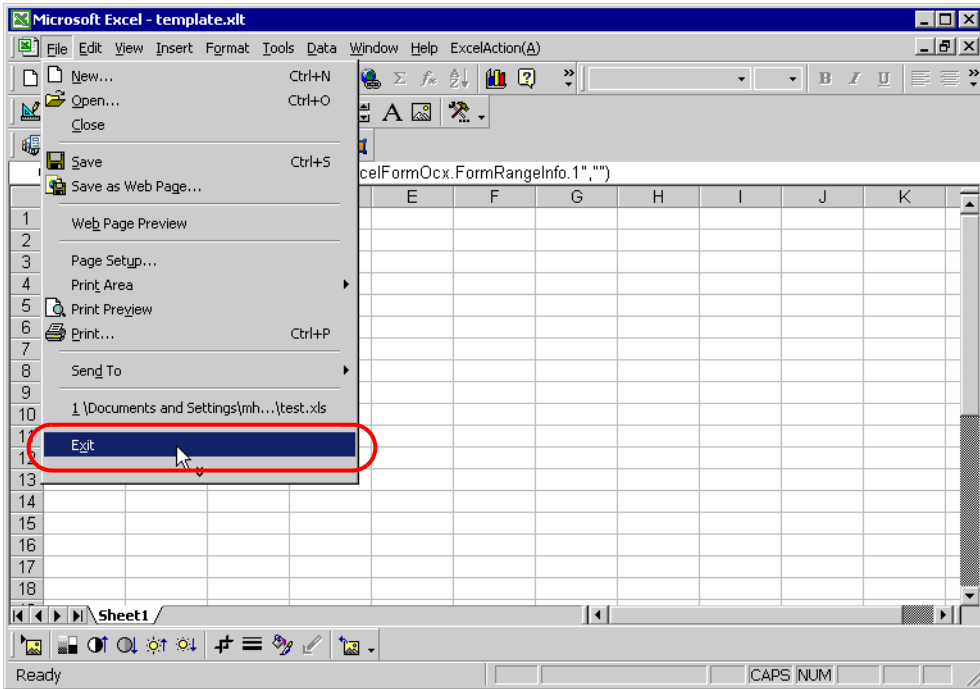

The following dialog box will appear, asking you if you want to save changes before closing. Click the [Yes] button.

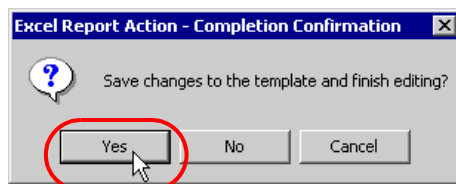

5 On the "Create form using Excel" screen, click the [OK] button.

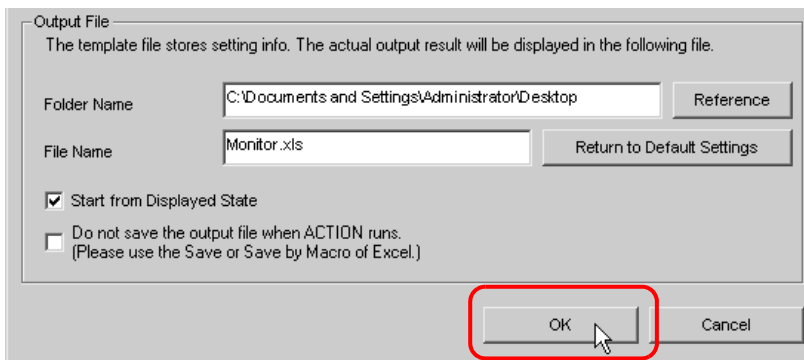

6.1.7 Setting ACTION Node/Process Completion Notification

This step sets the name of an ACTION node and the alert setting whether it should be tuned on or off when the ACTION is completed.

Ex.

- ACTION Node : PC1
- Receive Notification: OFF

1 On the "Set ACTION Name/Parameter" screen, click the [Next] button.

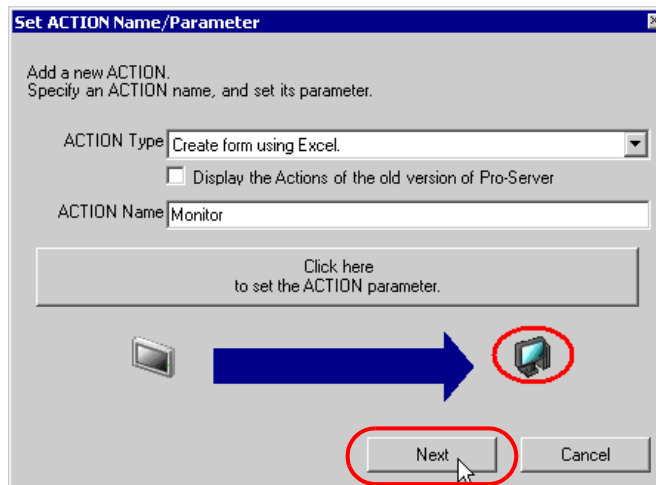

2 Click the list button of [ACTION Node] and select "PC1" as a node where ACTION operates.

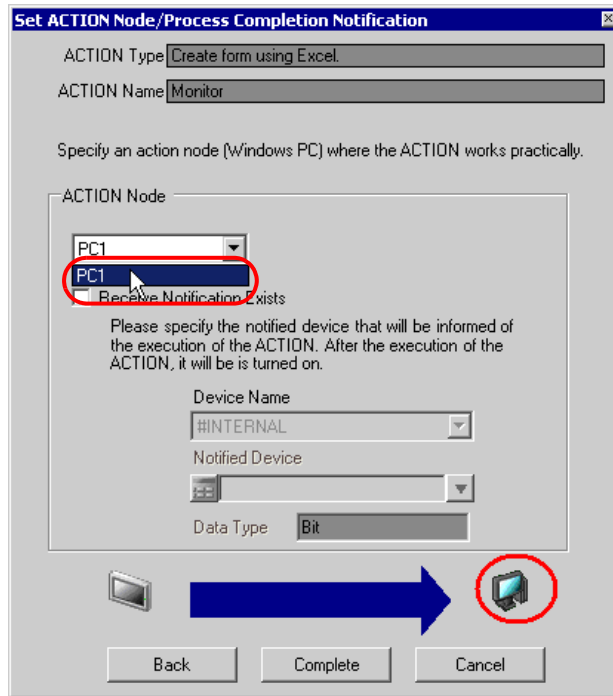

3 Turn off the check box of [Receive Notification Exists], if checked.

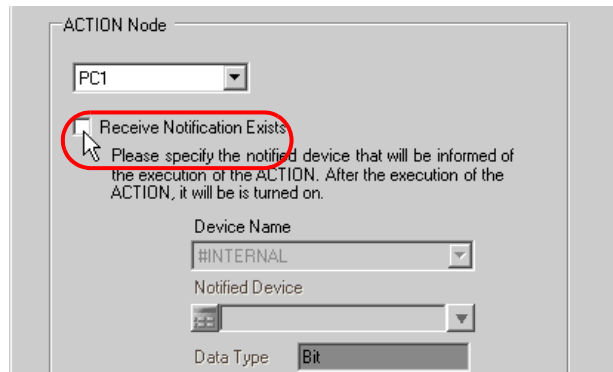

NOTE • Do not check "Receive Notification Exists".

4 Click the [End] button.

The "Set ACTION Node/Process Completion Notification" screen will disappear. On the left of the screen, the name of ACTION you set will appear.

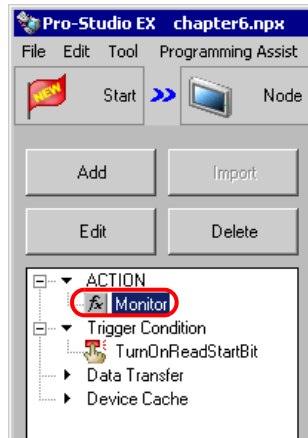

This is the end of the settings of the ACTION node and process completion notification.

6.1.8 Verifying Setting Result

This step verifies setting results on the setting content list screen.

- 1 Select the ACTION name "Monitor" from the tree display on the left of the screen.

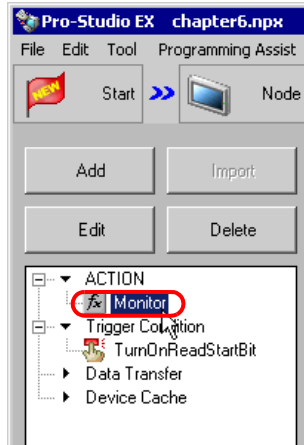

Confirm that the setting content appears on the right of the screen.

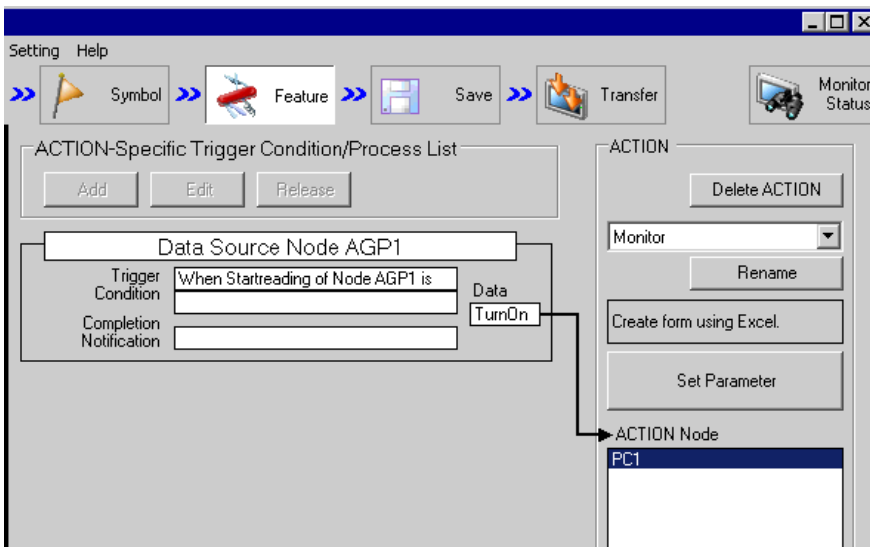

2 Select the trigger condition name "TurnOnReadStartBit" from the tree display on the left of the screen.

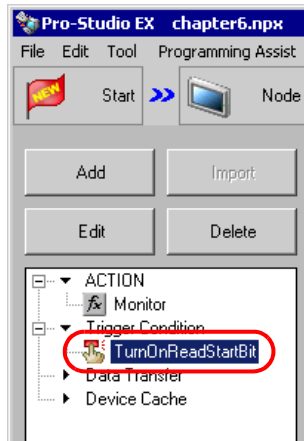

Confirm that the setting content appears on the right of the screen.

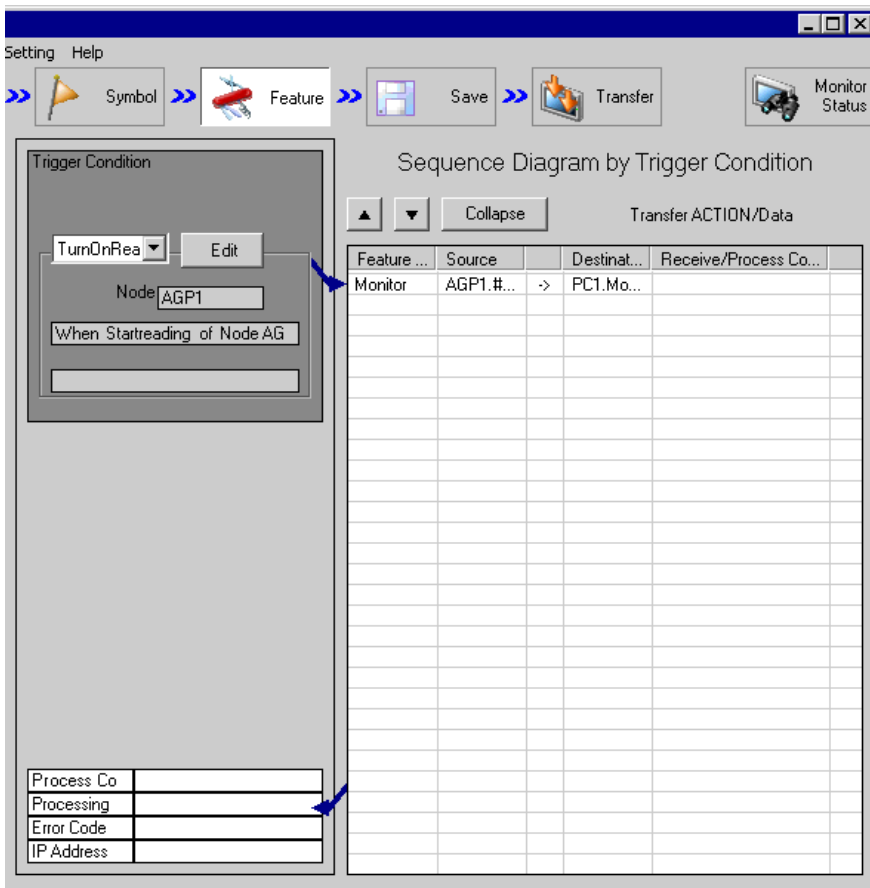

This is the end of the verification of the settings.

6.1.9 Saving a Network Project File

This step saves the current settings as a network project file and reloads to 'Pro-Server EX'.

Refer to "25 Saving" for details about saving a network project file.

-
- IMPORTANT**
- 'Pro-Server EX' reads a created network project file, and then executes ACTION according to the settings in the file. The settings therefore need be saved in the network project file.
 - Be sure to reload the network project file to 'Pro-Server EX' If not, ACTION will not work.
-

Ex.

- Path of network project file : Desktop\monitor.npx
- Title : EXCEL Report ACTION

6.1.10 Test Read

You can check if the settings are correct before transferring a created network project file to entry nodes.

When executing ACTION, the setting data is output to an output file. However, when executing a test read, it is reflected in a template file.

-
- NOTE**
- You do not necessarily have to perform a test read.
If you skip this, proceed to "6.1.11 Transferring a Network Project File".
-

- IMPORTANT**
- To perform a test read, it is necessary that 'Pro-Server EX', to which a created network project file has been loaded, is running.
-

- 1 Click the [Feature] button.
- 2 Click "ACTION" from the tree display on the left of the screen, then click the [Edit] button.
- 3 On the "Set ACTION Name/Parameter" screen, click the [Click here to set the ACTION parameter] button.
- 4 On the "Create form using Excel" screen, click the [Edit Template] button.

5 With the ACTION area selected, click the [Test Read] icon.

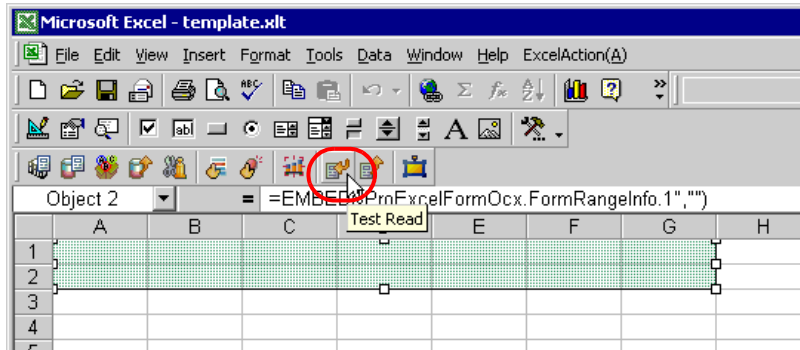

The setup contents will be read in the template.

NOTE • Refer to "6.4 Restrictions" for details about the restrictions on test reads.

6.1.11 Transferring a Network Project File

This step loads a saved network project file to 'Pro-Server EX' and then transfers to entry nodes.

Refer to "26 Transferring" for details about transferring a network project file.

NOTE • Be sure to transfer a network project file. If not, ACTION will not work.

6.1.12 Executing ACTION

This step verifies that enabling trigger conditions activates ACTION, opens an Excel book (file name: "Monitor.xls"), and then writes the device data in the specified location in Excel.

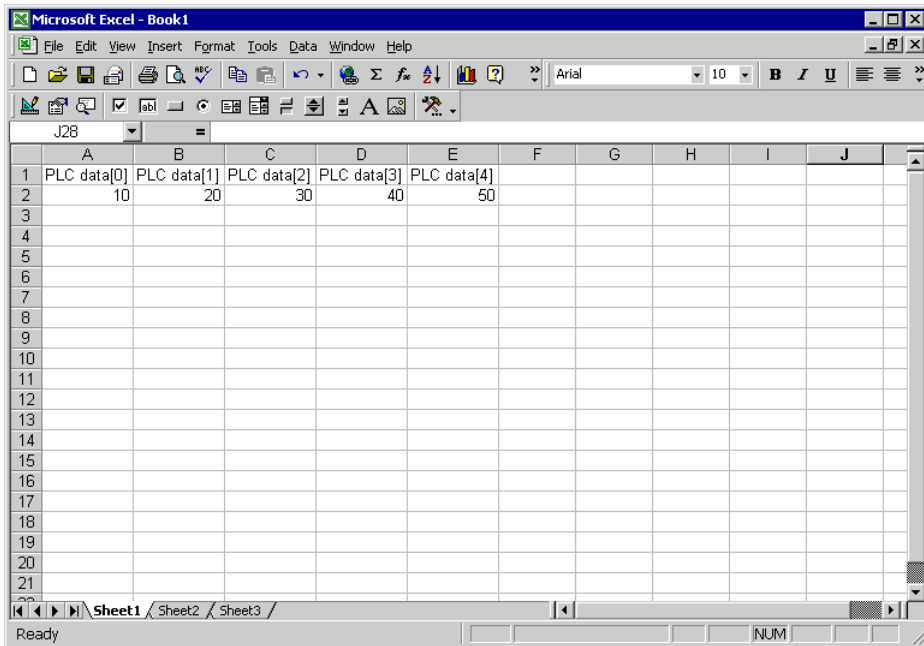

This is the end of the explanation of this ACTION.

NOTE

- If you want to achieve faster communication during ACTION, refer to "29 Tips for Faster Communication".

6.2 Correcting and Restoring Once Read Data

- NOTE** • If you want to select data case by case among several recipe data on Excel, refer to "12 Writing Excel Data in Device/PLC".
This function, which is One-Shot action, is fixed to 1 recipe.

[Action Example]

Restore data to Device/PLC after correcting device address value of Device/PLC (word device: address "D50" to "D54") from which data was read into Excel and detecting the rising of trigger device (bit device: "M01") of Device/PLC.

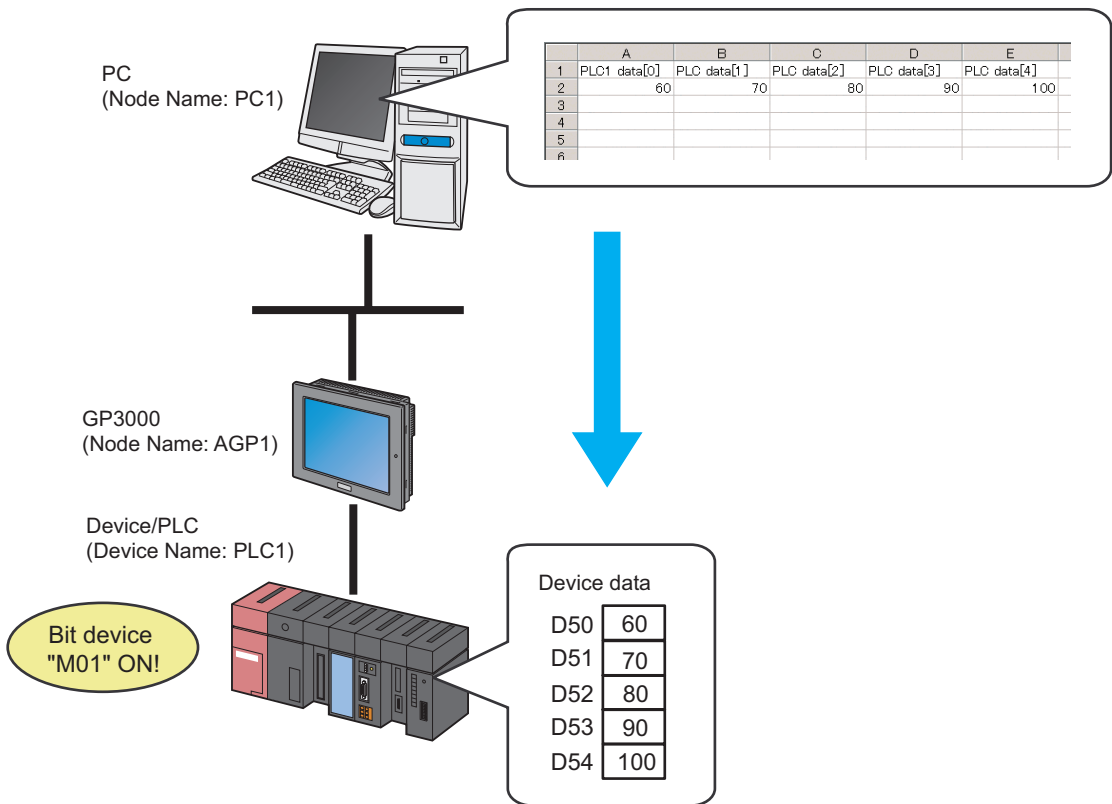

This section describes the setting procedures for executing the above action (ACTION) as an example.

[Setting Procedure]

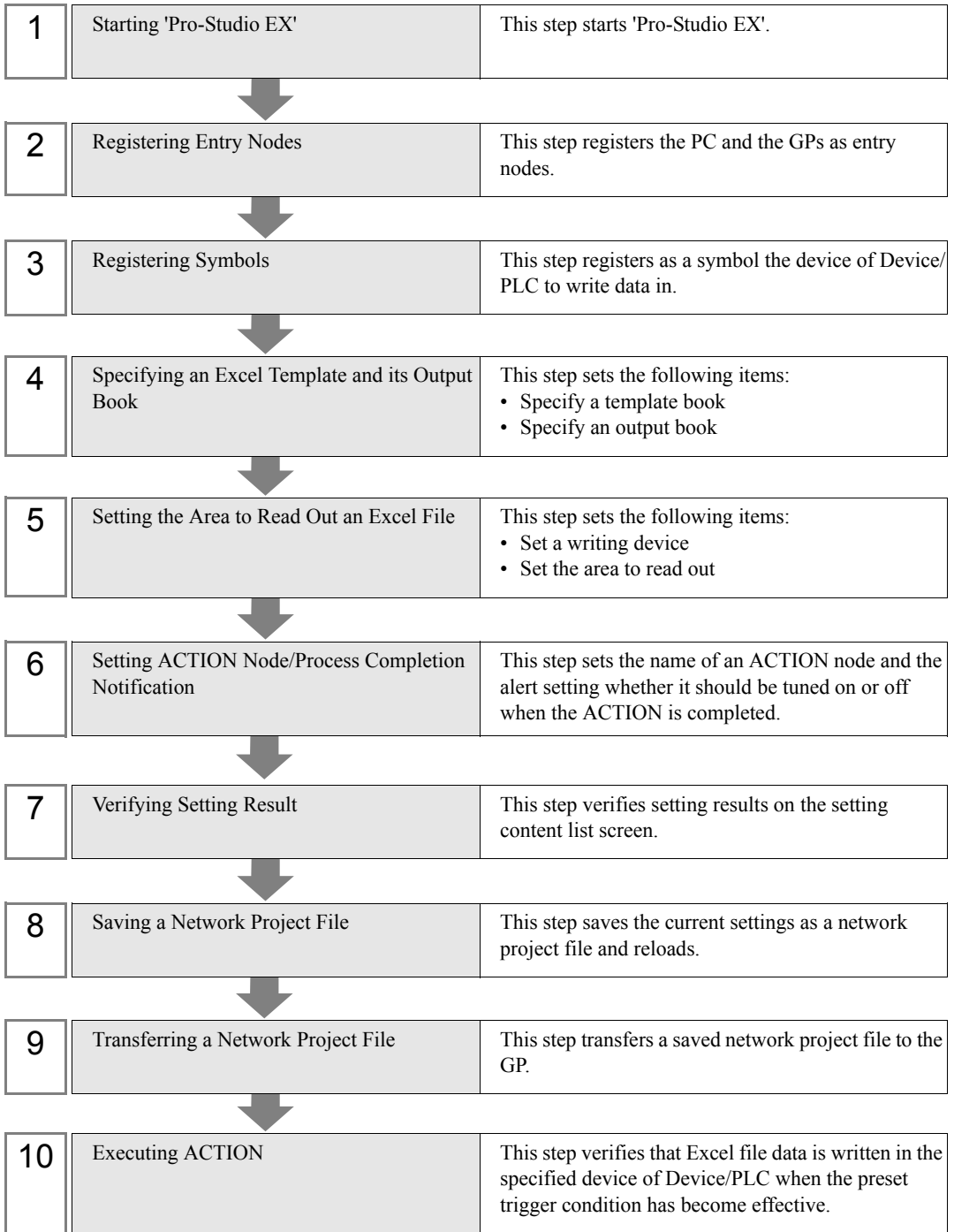

6.2.1 Starting 'Pro-Studio EX'

This step starts 'Pro-Studio EX'.

Refer to "3 Trial of Pro-Server EX" for details about starting method.

6.2.2 Registering Entry Nodes

This step registers the PC and the GP connected with network as nodes.

Refer to "31 Node Registration" for details about entry nodes.



Node Name : PC1

IP Address : 192.168.0.1



Node Name : AGP1

IP Address : 192.168.0.100

Device/PLC Information

Ex.

Entry Node	Setting item	Setting example
PC	Node Name	PC1
	IP Address	192.168.0.1
GP	Type	GP3000 series
	Node Name	AGP1
	IP Address	192.168.0.100

6.2.3 Registering Symbols

This step registers as a symbol the device address of Device/PLC to which Excel device data is written. Refer to "32 Symbol Registration" for details about symbols.

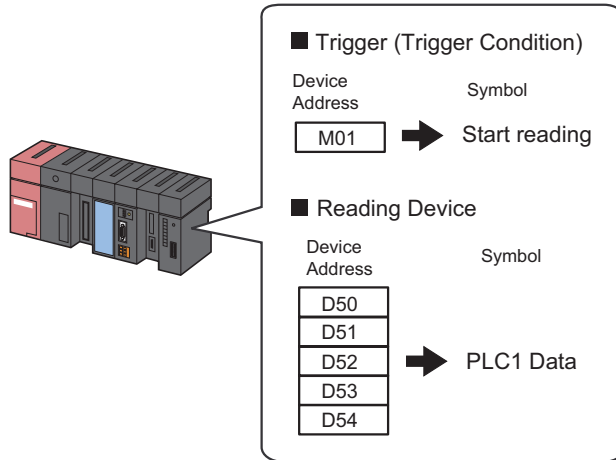

Ex.

- Trigger (Trigger Condition)

Setting item	Setting content
Symbol Name	Start writing
Data Type	Bit
Device address for symbol registration	"M01" of Device/PLC (PLC1)
No. of Devices	1

- Writing Device

Setting item	Setting content
Symbol Name	PLC1 data
Data Type	16Bit (Signed)
Device address for symbol registration	"D50" to "D54" of Device/PLC (PLC1)
No. of Devices	5

6.2.4 Specifying an Excel Template and its Output Book

This step specifies an Excel file and an output book where device data has been written.
 Refer to "6.3 Setting Guide" for more details.

Ex.

Setting item		Setting content
Specify a Template	Template Book	C:\Documents and Settings\Administrator\Desktop\monitor.xls
Output Book	Folder Name	C:\Documents and Settings\Administrator\Desktop
	File Name	Device data modification.xls
	Start with the output book displayed	Not checked
	Do not save the output file when ACTION runs.	Not checked

1 Click the [Feature] icon on the status bar.

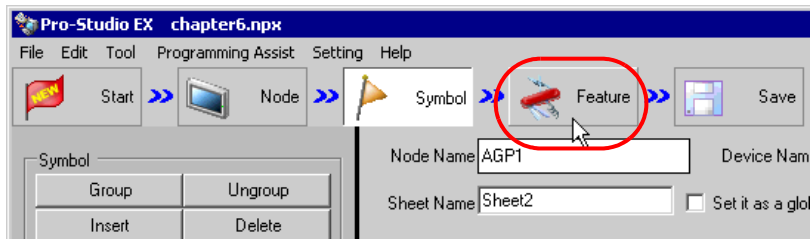

2 Select [ACTION] from the tree display on the left of the screen, then click the [Add] button.

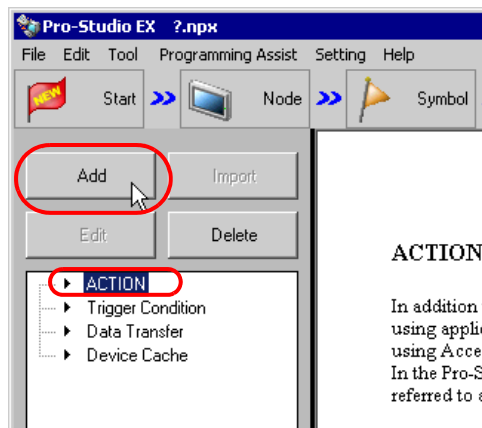

3 Click the [ACTION Type] list button, and select "Create form using Excel".

Then, enter the name of ACTION to set in the [ACTION name] field. In this example, enter "DeviceData Modification".

NOTE • [ACTION Name] can be an arbitrary name.

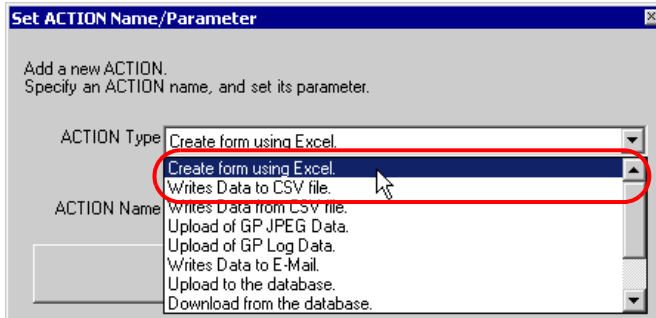

4 Click the [Click here to set the ACTION parameter] button.

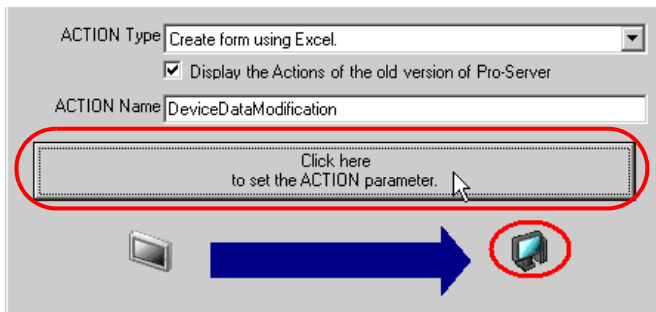

5 Set an Excel template and its output book.

- 1) Click the [Reference] button of [Template File] to set the Excel file "monitor.xls" where device data has been written.

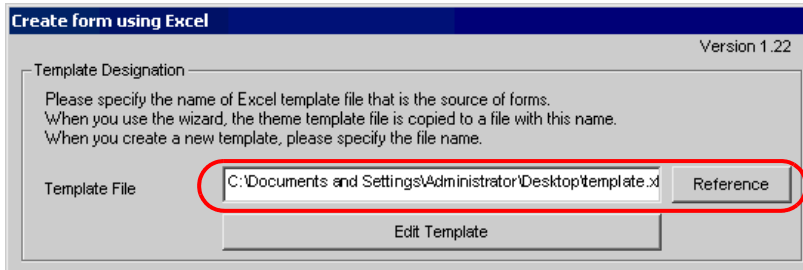

- 2) Click the [Reference] button of [Folder Name] and specify "Desktop" as a folder to save the output book.

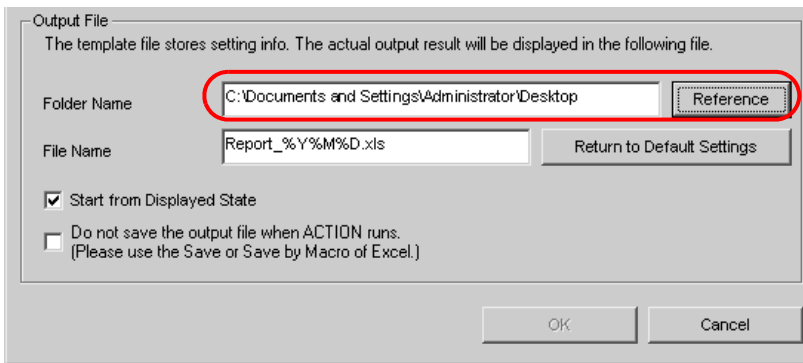

NOTE • "%Y%M%D" is preset as "Year/Month/Date". For more details, refer to "37 Restrictions".

- 3) Set the file name "DeviceDataModification.xls" in the [File Name] field, for the output book to set.

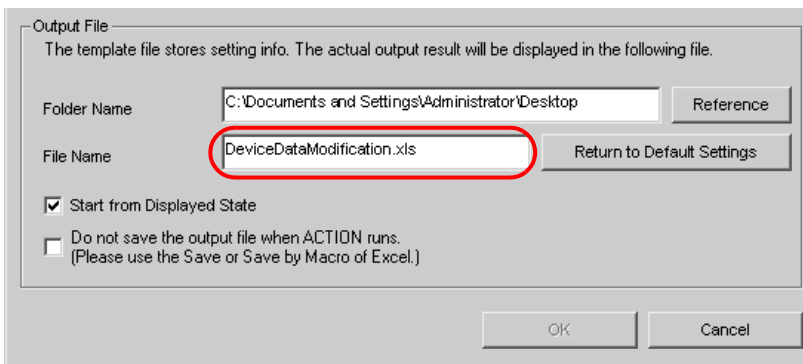

6.2.5 Setting Data Read Range of Excel File

This step sets data read range on Excel file to write in Device/PLC.

The example below shows the setting of data read area (Device One-Shot Area) of Excel file.

Refer to "6.3 Setting Guide" for more details.

	A	B	C	D	E
1	PLC1 data[0]	PLC1 data[1]	PLC1 data[2]	PLC1 data[3]	PLC1 data[4]
2	60	70	80	90	100
3					
4					
5					
6					

Ex.

Setting item	Setting content
Entry Node	AGP1
Device Name	PLC1
Device Address/ Symbol Group	PLC1 data
Add Device Address/ Symbol Name	Not checked
Target Cell Range	A2 to E2
Pattern	Z type
Trigger Condition Name	Turn on write start bit
Trigger Condition	When "Start writing" (M01) is ON

- 1 Click the [Edit Template] button.

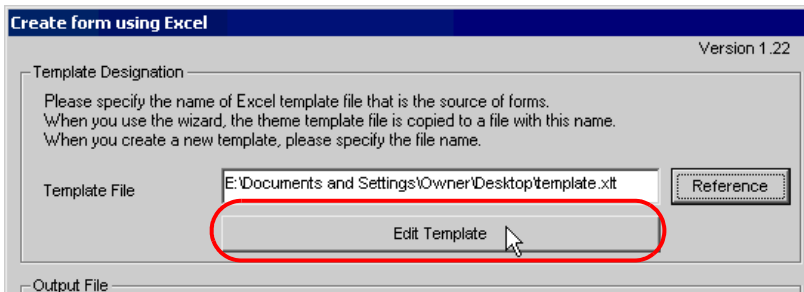

The Excel file contents will appear.

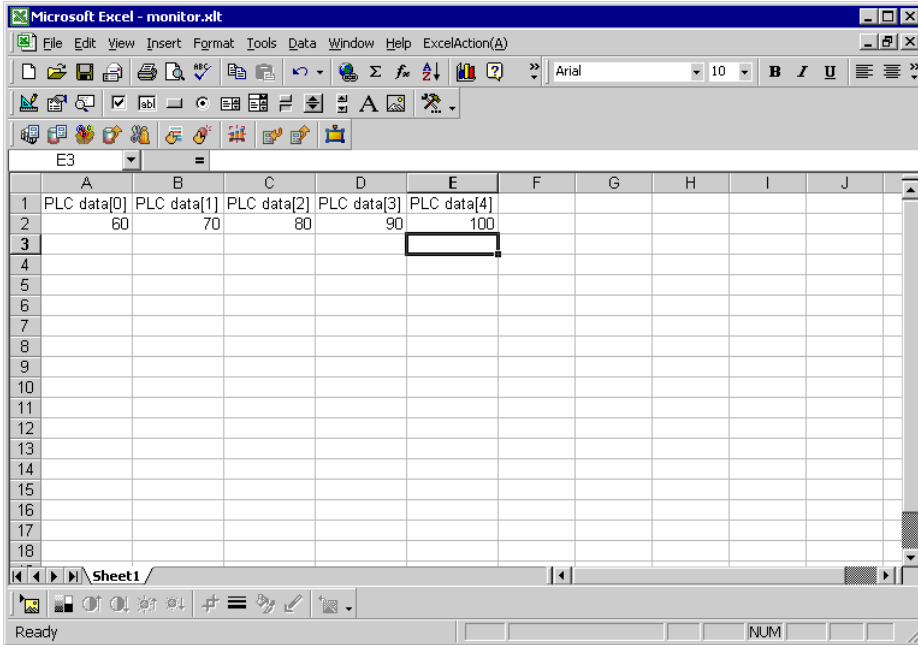

2 Set a data read area.

- 1) Click the [Device One-Shot Area] icon on Excel.

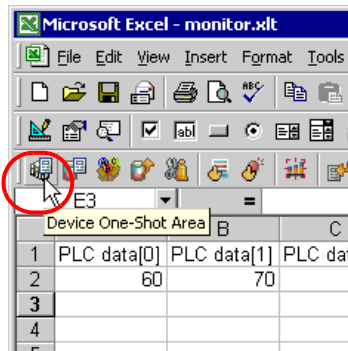

The "Device OneShot" screen will appear.

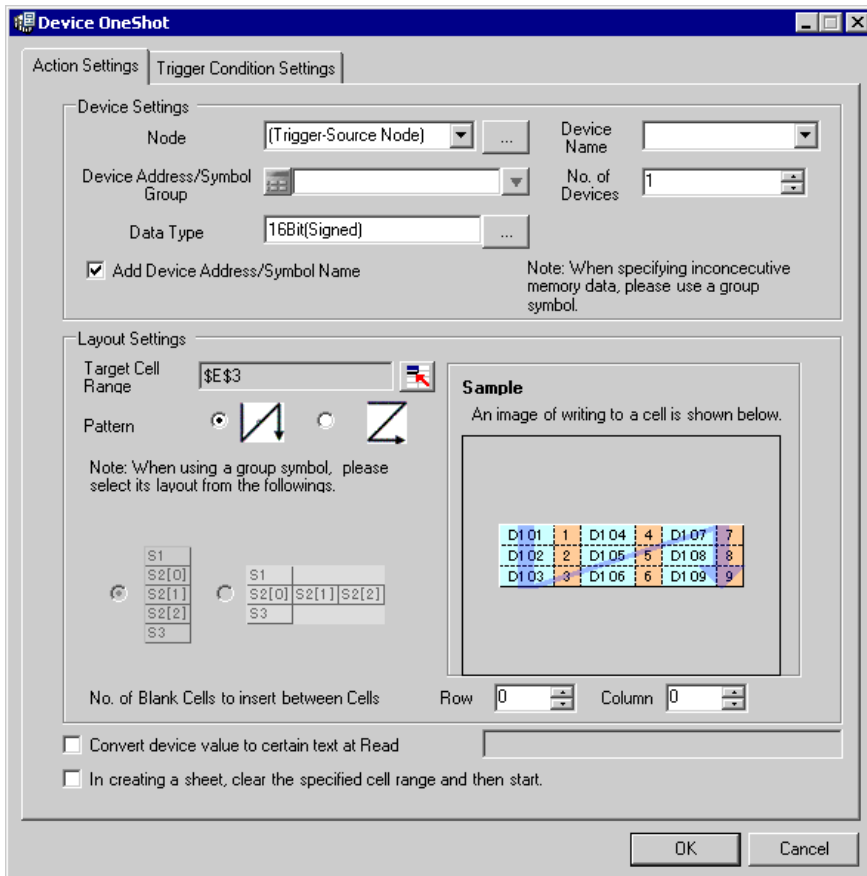

NOTE • Selecting "Device One-Shot Area" from [Excel Action] of the menu displays the same screen.

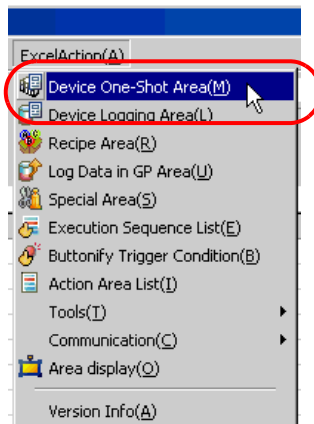

- 2) Click the list button of [Node] and select "AGP1" as a data transfer destination node.

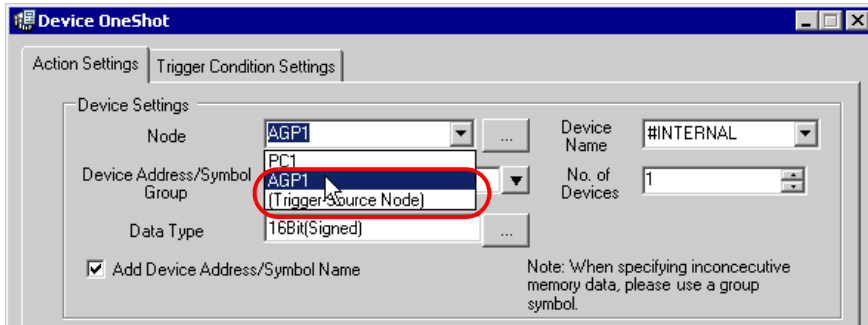

- 3) Click the list button of [Device Name] and select "PLC1" as a data transfer destination device.

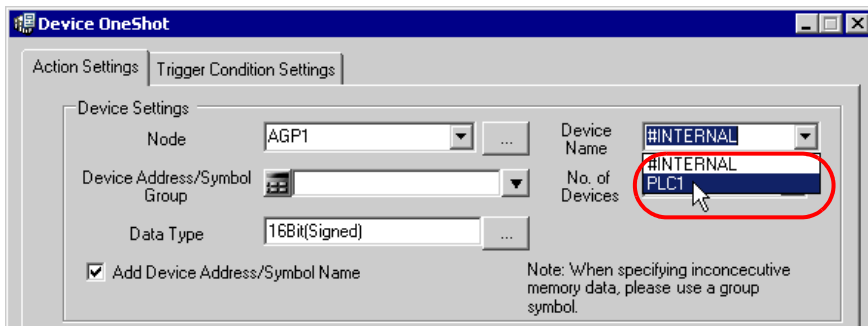

- 4) Click the list button of [Device Address/Symbol Group] and select "PLC1 data" as a symbol of the data to read out.

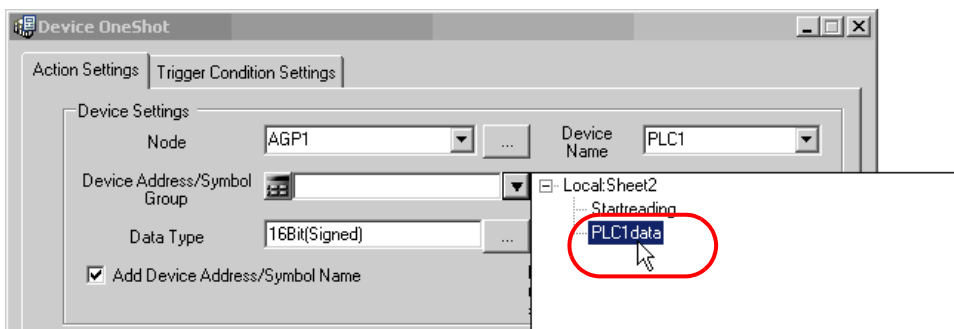

The device number "5" will be automatically entered in [No. of Devices], and "16Bit(Signed)" in [Data Type].

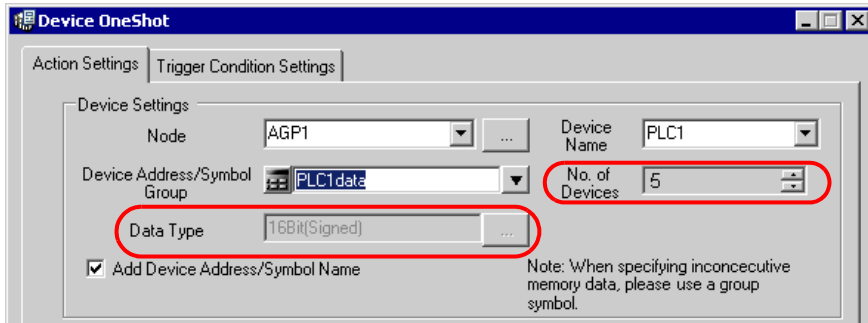

5) Click the cell range specify button of [Target Cell Range].

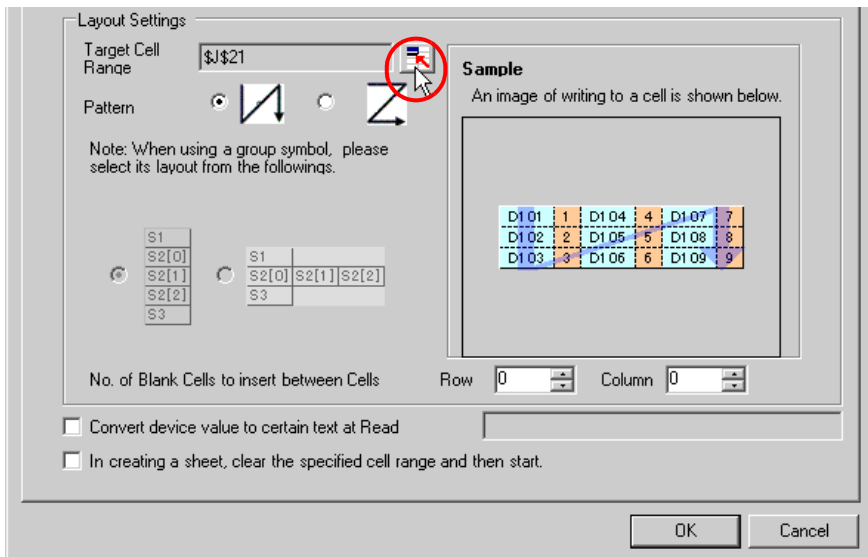

- 6) Drag the mouse to specify the data read area (cells A2 to E2). Then click the [OK] button.

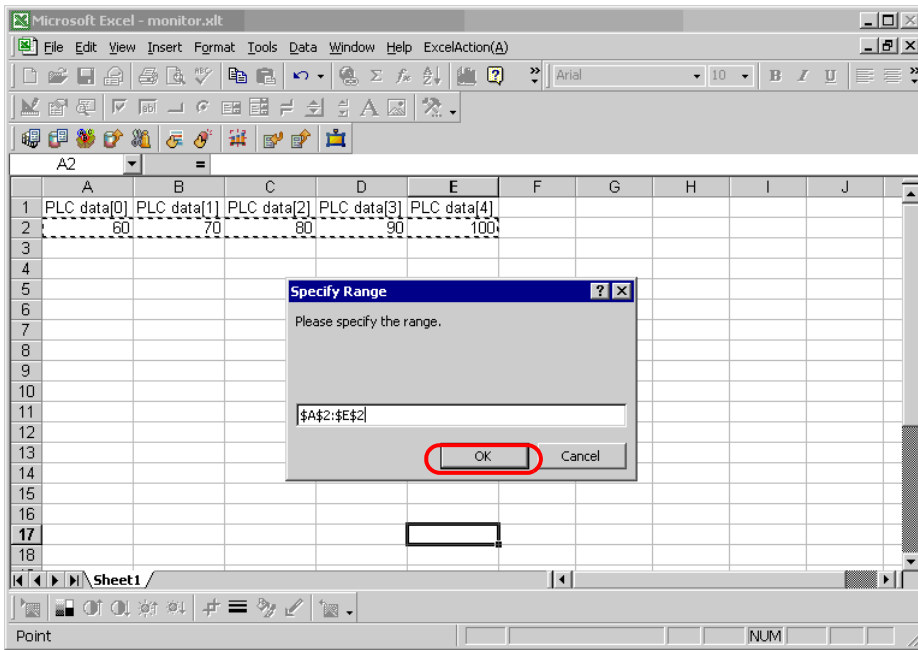

- 7) Select "Z type" of [Pattern].

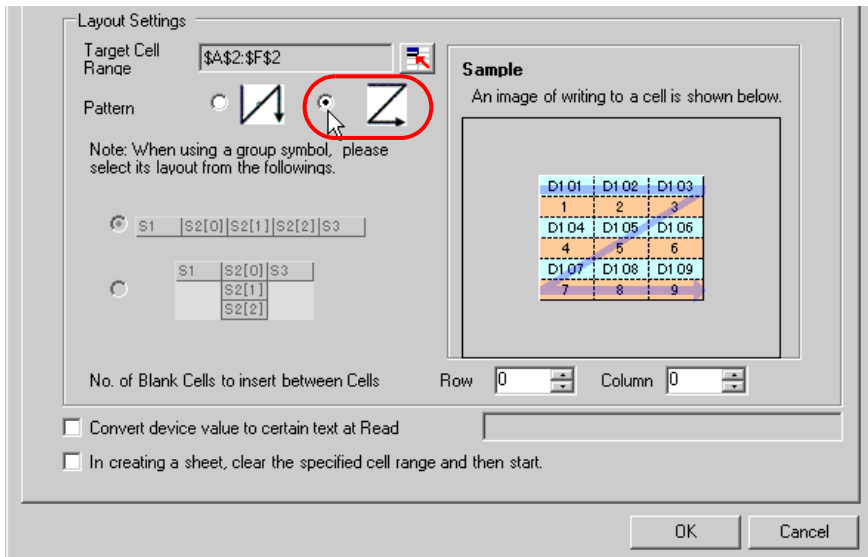

3 Set trigger conditions.

- 1) Click the [Trigger Condition Settings] tab.

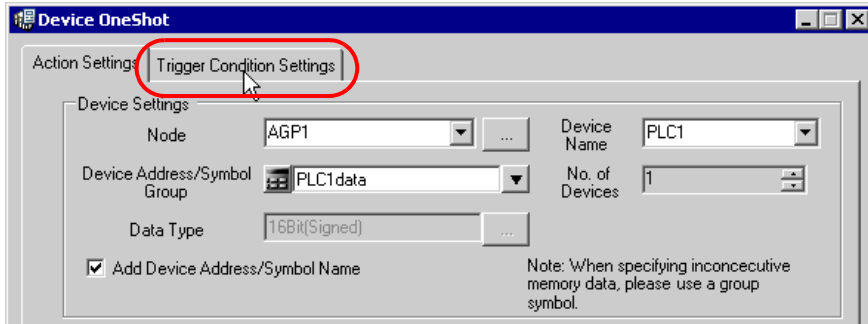

The "Device OneShot" screen will appear.

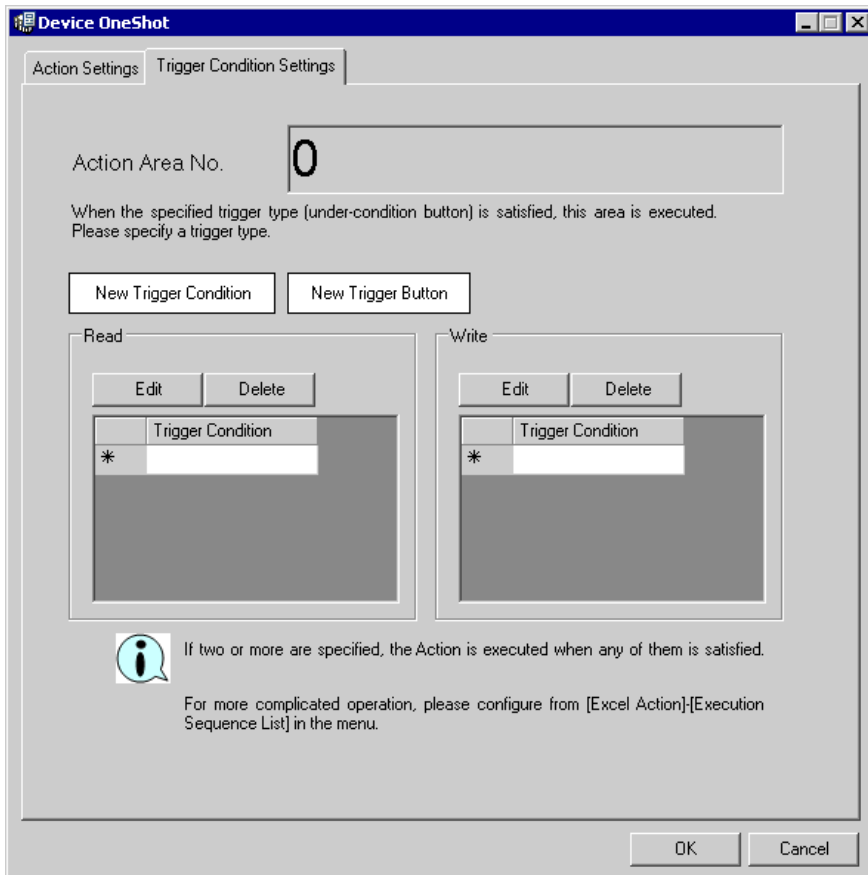

- 2) Click the [New Trigger Condition] button.

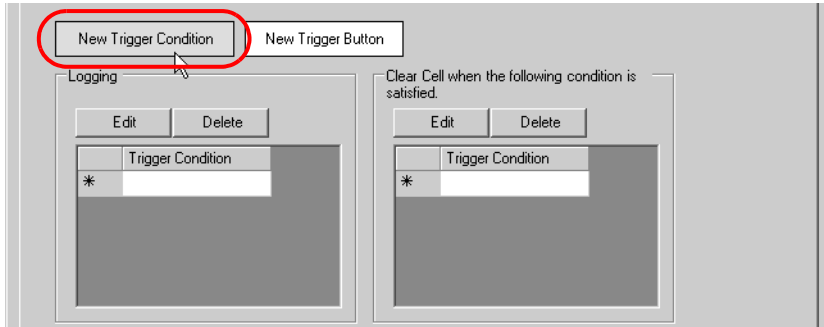

- 3) Click the [New Trigger Condition] button.

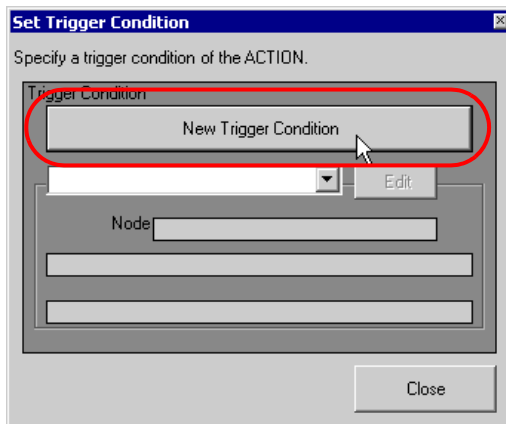

- 4) Enter the trigger condition name "TurnOnWritesStartBit" in [Trigger Condition Name], and select "AGP1" in [Node Name] as a name of the data transfer source.

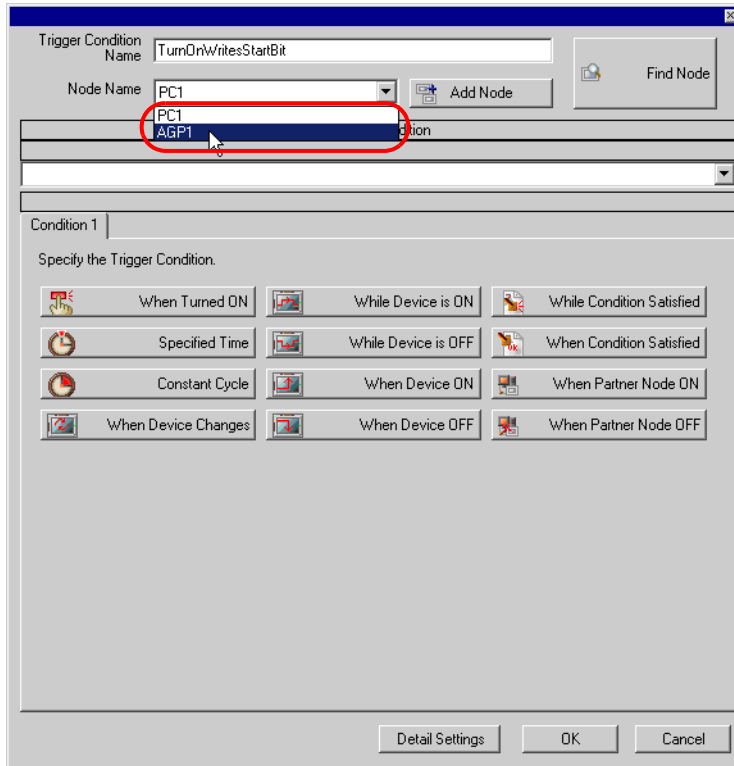

- Click the [When Device ON] button in the [Condition 1] tab and select "PLC1" for the device name.

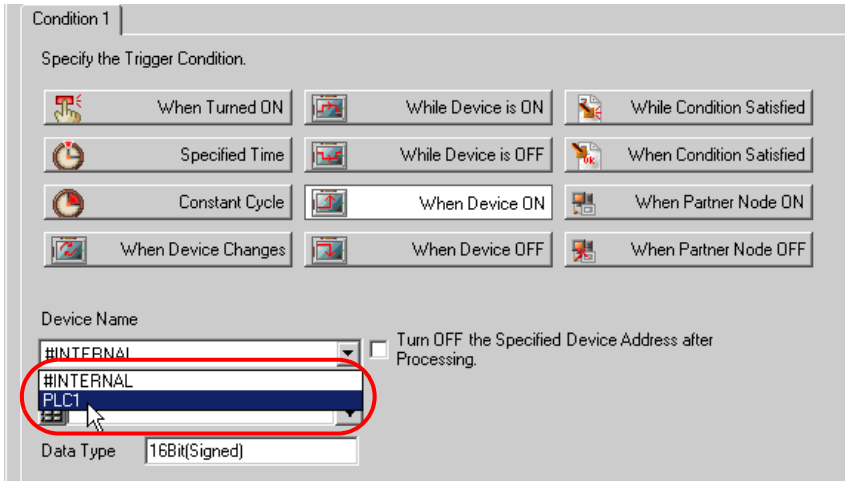

- Click the [Device Address] list button and select "Start writing" for the device symbol name which serves as a trigger.

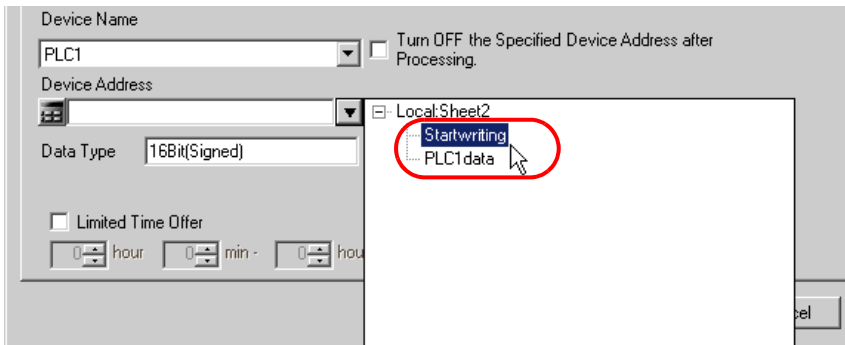

[Data Type] automatically appears after selection, too.

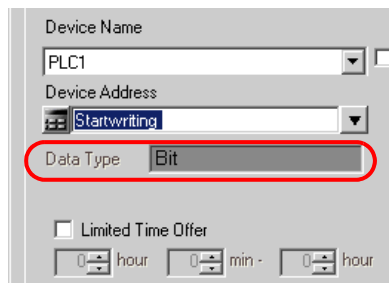

7) Click the [OK] button.

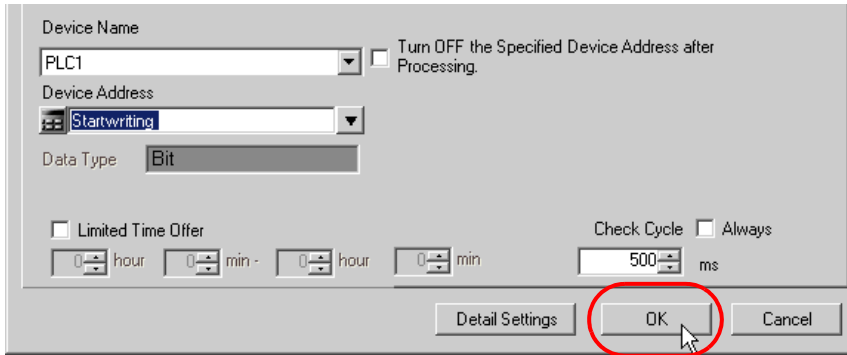

8) Click the [Close] button.

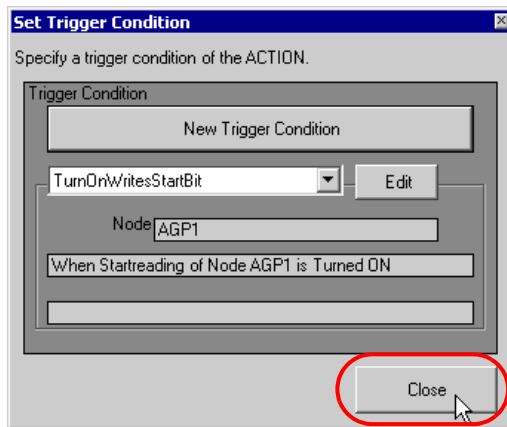

9) Click the blank line of [Trigger Condition] of [Write].

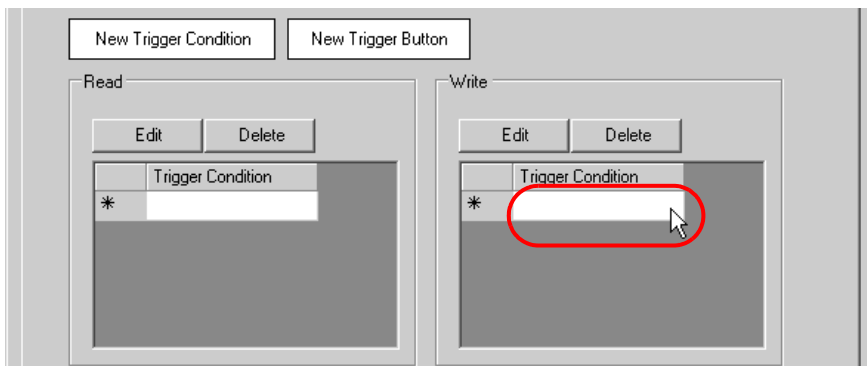

10) Click the list button and select "TurnOnWritesStartBit" as a trigger condition.

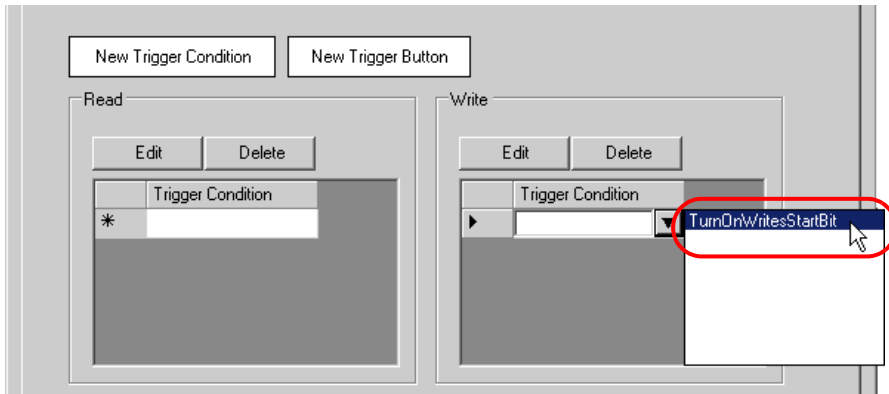

11) Click the [OK] button.

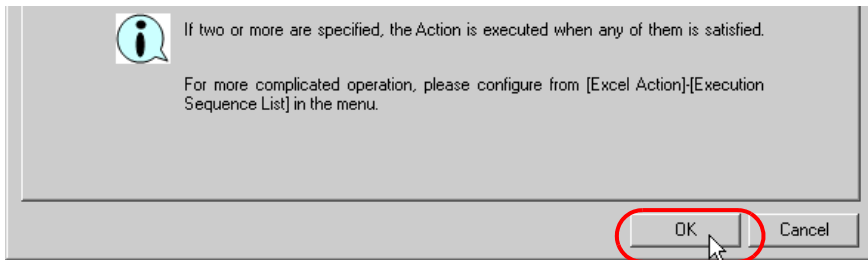

This is the end of the content settings of an Excel template.

4 Close 'Excel'.

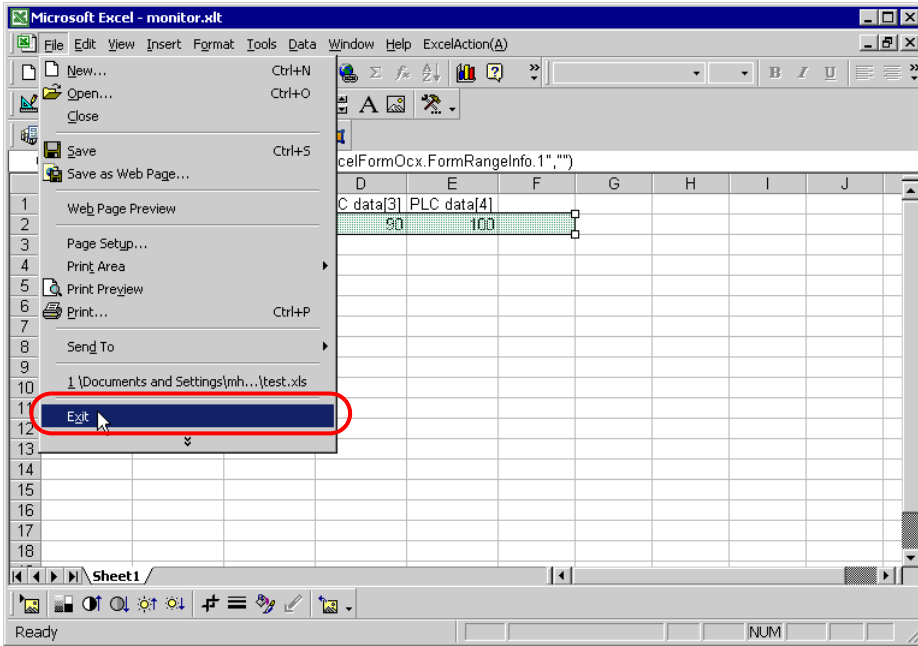

The following dialog box will appear, asking you if you want to save changes before closing. Click the [Yes] button.

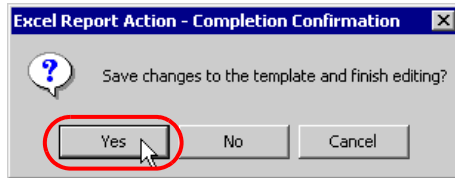

5 On the "Create form using Excel" screen, click the [OK] button.

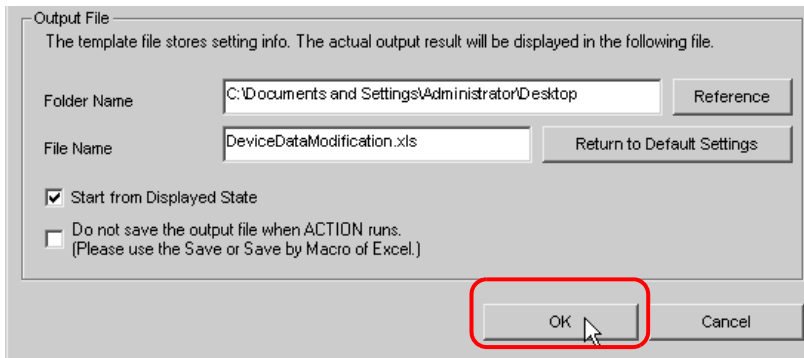

6.2.6 Setting ACTION Node/Process Completion Notification

This step sets the name of an ACTION node and the alert setting whether it should be tuned on or off when the ACTION is completed.

Ex.

- ACTION Node : PC1
- Receive Notification: OFF

1 On the "Set ACTION Name/Parameter" screen, click the [Next] button.

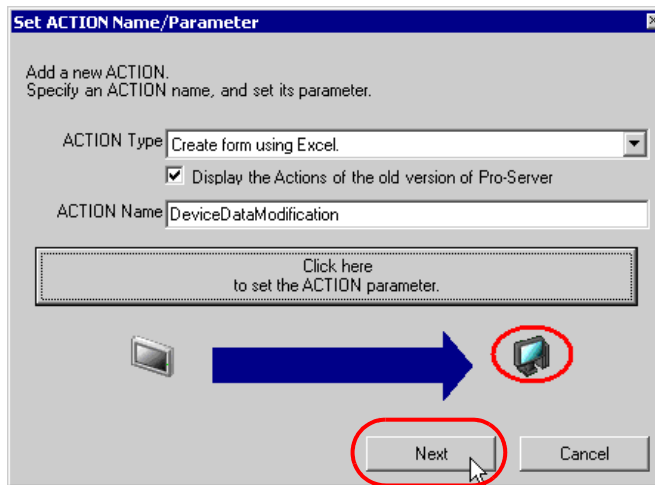

2 Click the list button of [ACTION Node] and select "PC1" as a node where ACTION operates.

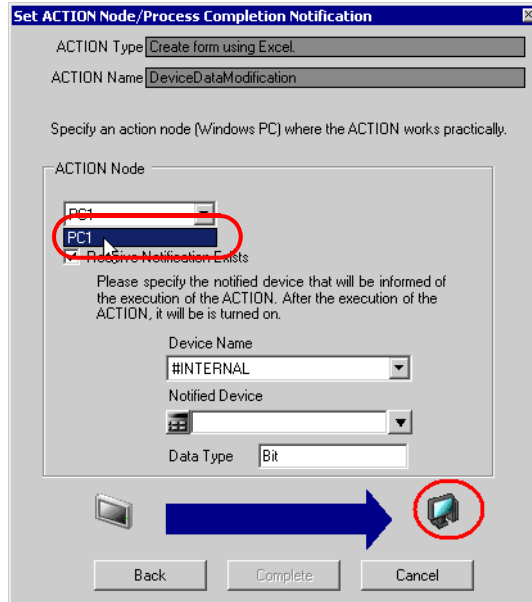

3 Turn off the check box of [Receive Notification Exists], if checked.

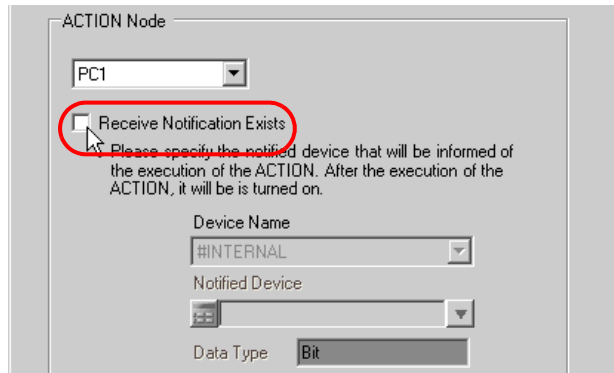

NOTE • Do not check "Receive Notification Exists".

4 Click the [Complete] button.

The "Set ACTION Node/Process Completion Notification" screen will disappear. On the left of the screen, the name of ACTION you set will appear.

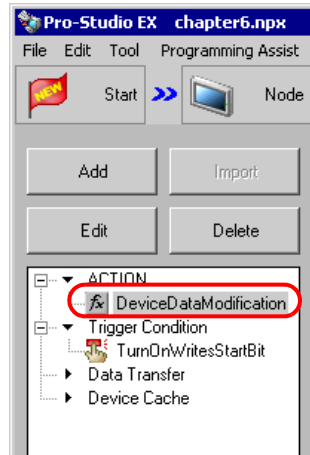

This is the end of the settings of the ACTION node and process completion notification.

6.2.7 Verifying Setting Result

This step verifies setting results on the setting content list screen.

- NOTE**
- With the "Excel Report" ACTION, you cannot add, edit or delete a trigger condition in "ACTION-specific Trigger Condition/Process List". To change a preset condition, click the [Set Parameter] button, and select [Edit Template] to change data on Excel.

1 Select the ACTION name "DeviceDataModification" from the tree display on the left of the screen.

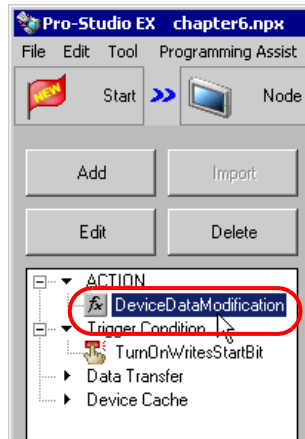

Confirm that the setting content appears on the right of the screen.

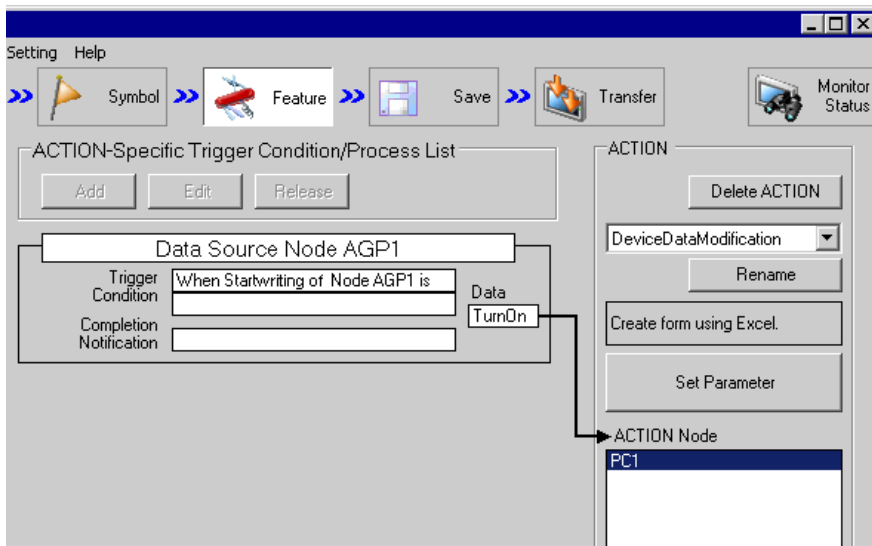

2 Select the trigger condition name "TurnOnWritesStartBit" from the tree display on the left of the screen.

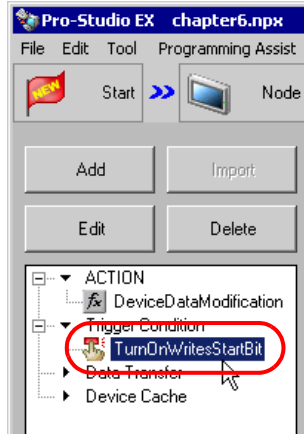

Confirm that the setting content appears on the right of the screen.

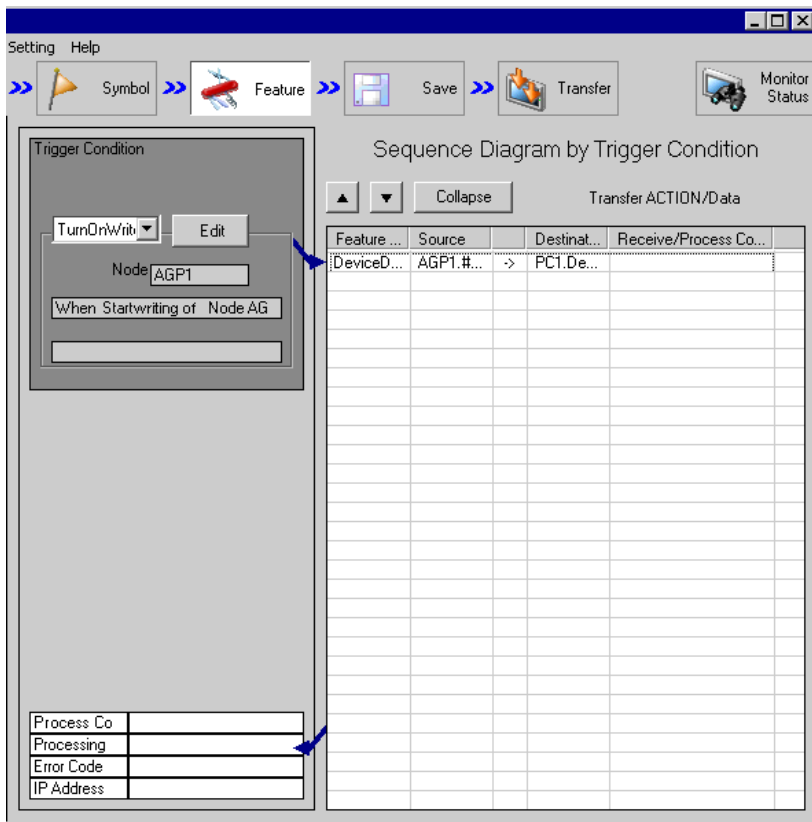

This is the end of the verification of the settings.

6.2.8 Saving a Network Project File

This step saves the current settings as a network project file and reloads to 'Pro-Server EX'.

Refer to "25 Saving" for details about saving a network project file.

IMPORTANT

- 'Pro-Server EX' reads a created network project file, and then executes ACTION according to the settings in the file. The settings therefore need be saved in the network project file.
- Be sure to reload the network project file to 'Pro-Server EX'. If not, ACTION will not work.

Ex.

- Path of network project file : Desktop\monitor_write.npx
- Title : EXCEL Report ACTION

6.2.9 Test Write

You can check if the settings are correct before transferring a created network project file to entry nodes.

NOTE

- You do not necessarily have to perform a test write. If you skip this, proceed to "6.2.10 Transferring a Network Project File".

IMPORTANT

- Note that the data will be actually written in the Device/PLC when you specify the device of Device/PLC as a write destination.
- To perform a test write, it is necessary that 'Pro-Server EX', to which a created network project file has been loaded, is running.

- 1 Click the [Feature] button.
- 2 Click "ACTION" from the tree display on the left of the screen, then click the [Edit] button.
- 3 On the "Set ACTION Name/Parameter" screen, click the [Click here to set the ACTION parameter] button.
- 4 On the "Create form using Excel" screen, click the [Edit Template] button.
- 5 With the ACTION area selected, click the [Test Write] icon.

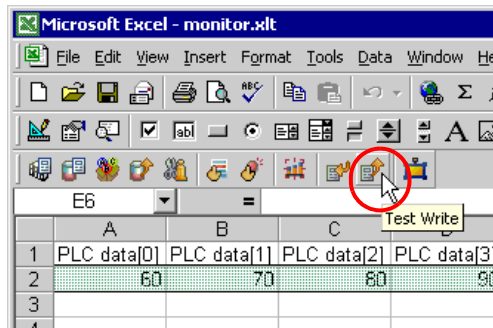

At this point, data is written in the Device/PLC.

NOTE

- You can check that data is being written in the "Symbol Monitor" screen of "Status Monitor". For more details, see "28 Simply Confirming On-site Status".
- Refer to "6.4 Restrictions" for details about the restrictions on test writes.

6.2.10 Transferring a Network Project File

This step loads a saved network project file to 'Pro-Server EX' and then transfers to entry nodes.

Refer to "26 Transferring" for details about transferring a network project file.

NOTE

- Be sure to transfer a network project file. If not, ACTION will not work.
-

6.2.11 Executing ACTION

This step verifies that enabling trigger conditions activates ACTION and writes Excel data to the specified device of Device/PLC.

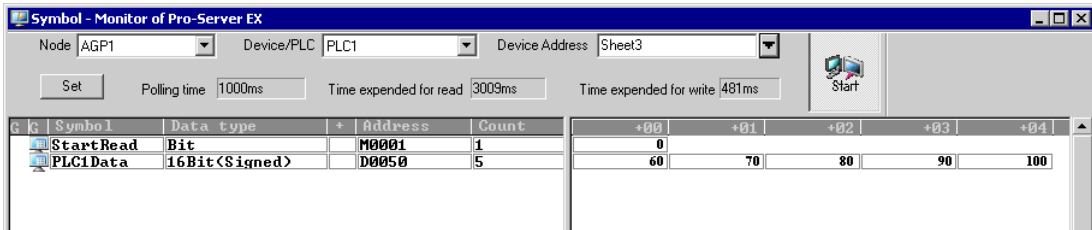

NOTE

- Check actually written value with such function as monitor of rudder creation software.
- If you want to achieve faster communication during ACTION, refer to "29 Tips for Faster Communication".

This is the end of the explanation of this ACTION.

6.3 Setting Guide

This section explains how to set each screen in detail.

6.3.1 "Create form using Excel" Screen

☞ ■ "Creating form using Excel" Screen"

6.3.2 "Device OneShot" Screen

■ "Action Settings" Tab

Device OneShot

Action Settings | Trigger Condition Settings

Device Settings

Node: (Trigger-Source Node) ... Device Name: []

Device Address/Symbol Group: [] No. of Devices: 1

Data Type: 16Bit(Signed) ...

Add Device Address/Symbol Name Note: When specifying inconsecutive memory data, please use a group symbol.

Layout Settings

Target Cell Range: \$B\$6

Pattern: [] [] [] []

Note: When using a group symbol, please select its layout from the followings.

S1
 S2[0]
 S2[1]
 S2[2]
 S3

S1
 S2[0] S2[1] S2[2]
 S3

No. of Blank Cells to insert between Cells: Row: 0 Column: 0



Sample
An image of writing to a cell is shown below.

D1 01	1	D1 04	4	D1 07	7
D1 02	2	D1 05	5	D1 08	8
D1 03	3	D1 06	6	D1 09	9

Convert device value to certain text at Read

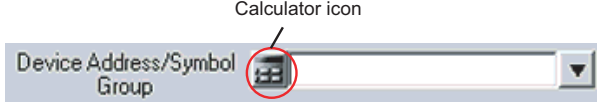

In creating a sheet, clear the specified cell range and then start.

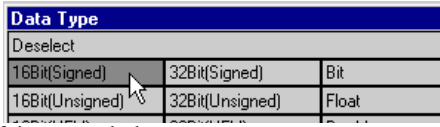
OK Cancel

Setting item		Setting content								
Device Settings	Node	<p>Selects nodes which have a device to read/write data</p> <p>NOTE</p> <ul style="list-style-type: none"> Clicking the [...] button can retrieve or add entry nodes. Selecting "(Trigger-Source Node)" will select the entry node that has triggered the action. <table border="1"> <thead> <tr> <th>Trigger Cause</th> <th>Target Entry Node</th> </tr> </thead> <tbody> <tr> <td>The trigger condition satisfied</td> <td>Trigger condition node</td> </tr> <tr> <td>The trigger button clicked</td> <td>Pro-Server EX node on which you clicked the button</td> </tr> <tr> <td>Started directly from the user program</td> <td>Pro-Server EX node on which the user program is operated</td> </tr> </tbody> </table>	Trigger Cause	Target Entry Node	The trigger condition satisfied	Trigger condition node	The trigger button clicked	Pro-Server EX node on which you clicked the button	Started directly from the user program	Pro-Server EX node on which the user program is operated
	Trigger Cause	Target Entry Node								
	The trigger condition satisfied	Trigger condition node								
	The trigger button clicked	Pro-Server EX node on which you clicked the button								
	Started directly from the user program	Pro-Server EX node on which the user program is operated								
Device Name	<p>Selects nodes which have a device to read/write data</p> <p>NOTE</p> <ul style="list-style-type: none"> It is not necessary to set when the entry nodes are GP Series nodes and Pro-Server EX nodes. 									
Device Address/ Symbol Group	<p>Sets the device address or symbol to be used.</p> <ul style="list-style-type: none"> When specifying a device address: Enter directly from the Calculator icon.  <ul style="list-style-type: none"> When specifying a symbol: Select the symbol by clicking the list button. 									
Data Type	<ul style="list-style-type: none"> When specifying a device address: Specify the data type.  <ul style="list-style-type: none"> When specifying a symbol: Data type automatically appears. 									
No. of Devices	<p>Sets the number of devices to read/write. Enabled only when the device address has been directly input.</p> <p>NOTE</p> <ul style="list-style-type: none"> When the symbol or group symbol is specified, this is set automatically. 									

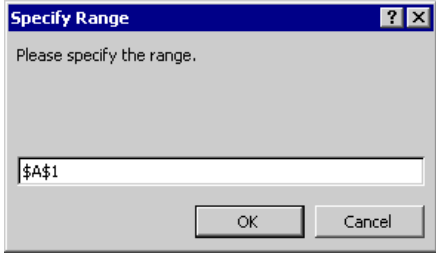
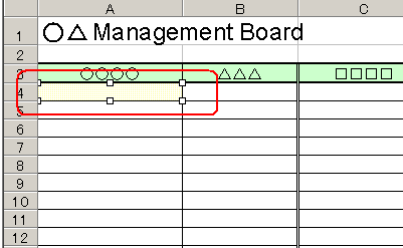
Setting item		Setting content																		
Device Settings	Add Device Address/Symbol Name	<p>Displays the device address, symbol name, or group symbol name in the Excel cells next to the cells in which data have been written. In this case, depending on the data write pattern, the device address, symbol name, or group symbol name will be written in the different cells as follows.</p> <table border="1"> <thead> <tr> <th>Write Pattern</th> <th>Display Cell Position</th> </tr> </thead> <tbody> <tr> <td>N type</td> <td>On the left of the value</td> </tr> <tr> <td>Z type</td> <td>Above the value</td> </tr> </tbody> </table> <p>Example)</p> <ul style="list-style-type: none"> Device address "D100", No. of devices "3", Write pattern "N type" <table border="1"> <tbody> <tr> <td>D100</td> <td>(Value of D100)</td> </tr> <tr> <td>D101</td> <td>(Value of D101)</td> </tr> <tr> <td>D102</td> <td>(Value of D102)</td> </tr> </tbody> </table> <ul style="list-style-type: none"> Device address "D100", No. of devices "3", Write pattern "Z type" <table border="1"> <thead> <tr> <th>D100</th> <th>D101</th> <th>D102</th> </tr> </thead> <tbody> <tr> <td>(Value of D100)</td> <td>(Value of D101)</td> <td>(Value of D102)</td> </tr> </tbody> </table>	Write Pattern	Display Cell Position	N type	On the left of the value	Z type	Above the value	D100	(Value of D100)	D101	(Value of D101)	D102	(Value of D102)	D100	D101	D102	(Value of D100)	(Value of D101)	(Value of D102)
		Write Pattern	Display Cell Position																	
N type	On the left of the value																			
Z type	Above the value																			
D100	(Value of D100)																			
D101	(Value of D101)																			
D102	(Value of D102)																			
D100	D101	D102																		
(Value of D100)	(Value of D101)	(Value of D102)																		

Setting item		Setting content
Layout Settings	Target Cell Range	<p>Specifies the cell range to which data will be written. Clicking the button can select the cell range on Excel. Drag the mouse to select the cell range.</p> <p>NOTE</p> <ul style="list-style-type: none"> Set the target cell range under the following conditions. Row: 65536 or less Column: 256 or less Instead of using the mouse, you can type the cell range. Click the Excel screen, enter the cell range on the "Specify Range" screen, and then click the [OK] button.  <ul style="list-style-type: none"> When you specify the cell range including 1501 lines or more, only the top-left cell of the selected range seems to be specified on the display.  <ul style="list-style-type: none"> The useful function is available to check the specified cell range (Action area). Refer to "■ Action Area List" in "5.1.2 Setting Guide".

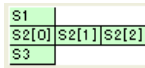
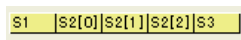
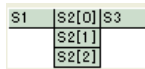
Setting item		Setting content
Layout Settings	Pattern	<p>Sets the data write/read direction when selecting multiple cells.</p> <ul style="list-style-type: none">  (N type) Sequentially from top to bottom.  (Z type) Sequentially from left to right. <p>NOTE</p> <ul style="list-style-type: none"> The write/read image of the content set in "Layout Settings" appears in [Sample].
	Layout to Cell	<p>Specifies write/read layout of symbols making up a group if group symbols have been specified.</p> <p>(Example)</p> <ul style="list-style-type: none"> N type  <p>Aligns symbols from up to bottom to write/read.</p>  <p>Aligns symbols from left to right to write/read.</p> <ul style="list-style-type: none"> Z type  <p>Aligns symbols from left to right to write/read.</p>  <p>Aligns symbols from up to bottom to write/read.</p>
	No. of Blank Cells to insert between Cells	<p>Sets the number of blank cells to insert (blank cells to insert between data and data) when writing data in plural cells.</p> <p>You can use different settings for columns and rows, respectively.</p>
Convert device value to certain text at Read		<p>Converts the read device values into text.</p> <p>Turning on this check box will display "Text Substitution Table Settings" screen.</p> <p>Refer to "■ "Text Substitution Table Settings" Screen" for more details.</p> <p>NOTE</p> <ul style="list-style-type: none"> If checked, the data write function is not available.
In creating a sheet, clear the specified cell range and then start.		<p>Before copying a sheet from the template file, if data are written in the cell range of the sheet, clears the data and starts copying.</p>

■ "Trigger Condition Settings" tab

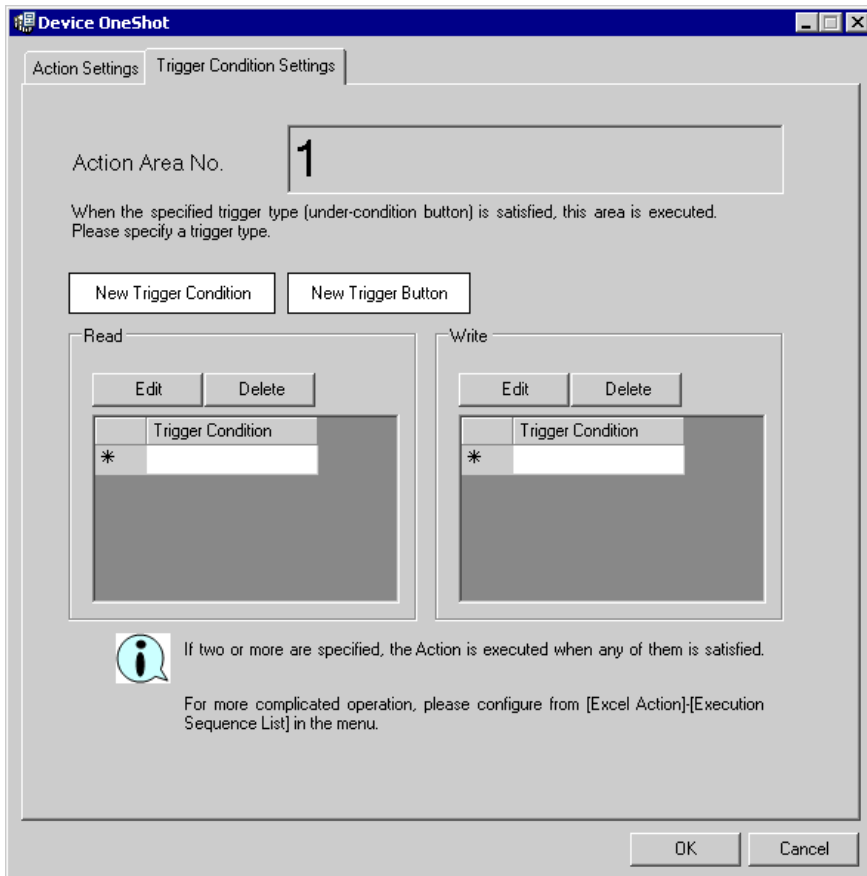

Setting item	Setting content
Action Area No.	Displays No. allocated to each ACTION area by template.
New Trigger Condition	Displays the "Trigger Condition Settings" dialog box. Click here to set a new trigger condition.
New Trigger Button	Displays the "Create Trigger Button" dialog box. Refer to "5.6.2 Setting Guide" Screen" for more details.
Read	<p>Selects a trigger condition to read data. Click the blank line of [Trigger Condition] and then the list button to display the registered trigger condition.</p> <p>NOTE</p> <ul style="list-style-type: none"> • When plural trigger conditions have been specified, satisfying at least one of those conditions executes ACTION. • Clicking the [Edit] button can edit the specified trigger conditions. • Clicking the [Delete] button deletes the specified trigger conditions.

Setting item	Setting content
Write	<p>Selects a trigger condition for writing data. Click the blank line of [Trigger Condition] and then the list button to display the registered trigger condition.</p> <p>NOTE</p> <ul style="list-style-type: none"> • When plural trigger conditions have been specified, satisfying at least one of those conditions executes ACTION. • Clicking the [Edit] button can edit the specified trigger conditions. • Clicking the [Delete] button deletes the specified trigger conditions.

■ "Text Substitution Table Settings" Screen

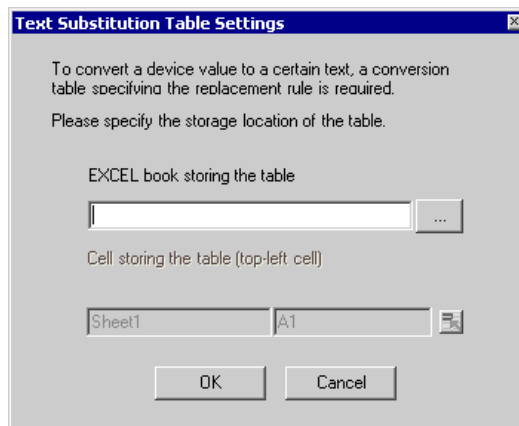

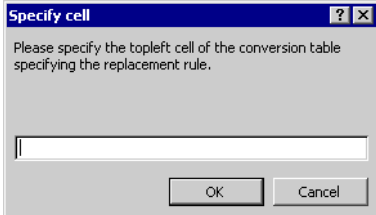
Setting item	Setting content
Excel book storing the table	<p>Specifies the Excel book in which the text substitution table is stored. Click the [...] button, and then specify the file on the "Open File" screen.</p>
Cell storing the table	<p>Specifies the book name in which the text substitution table is stored and then the cell number of the top-left of the table. On the "Specify Cell" screen, click the button and enter the cell number of the top-left of the table.</p> 

Refer to "■ About Text Substitution of Data" for more details about a text substitution table.

6.4 Restrictions

■ Writing data of Excel in the Device/PLCs

When writing the cell value and the cell is empty, 0 will be written for the numeral type, blank will be written for the character string type.

Also, when the data type is the character string, but you do not set the target cell format to "character string", you sometimes fail to write correctly.

In this case, you need to change the cell format to "character string" in advance.

■ Operation in ACTION area when error occurs

When you actually write/read in "Device One-Shot" function and exceed the ACTION area, perform the common operation as follows:

1) When performing a test read/ a test write

Error screen is displayed.

2) When executing ACTION in runtime

It will be recorded as ACTION error in the Log Viewer of the 'Pro-Server EX'.

■ Functions which are not executed by a Test Write/Read

The following function is not executed by a Test Read/Write.

"Clear the cell range specified in creating a sheet to start"

■ In the case of closing the displayed output book

If you have mistakenly closed an output book of Excel Report ACTION, follow these steps to open it again:

Dragging and dropping the book to open will make it read-only and the start button etc. invalid.

1. Double-click the output book.

2. When the following dialog box appears, select "No" to open it.

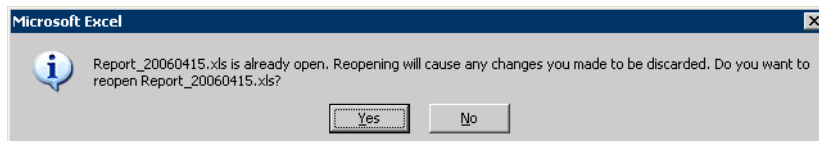

■ Receive notification

You cannot set the receive notification which indicates the completion of ACTION.

■ When setting "Trigger-Source Node"

When setting "Trigger-Source Node" at node in Excel Report action, node type and device are uncertain.

Therefore, the device address is displayed in red. But, it is no problem.

■ Edit the output file

While Excel Report Action is executing, you can not edit the output file.

Therefore, it becomes very difficult to operate Excel at the setting in which the Trigger condition satisfies at a short cycle. Moreover, the following error message is displayed when the Action is executed during editing the output file.

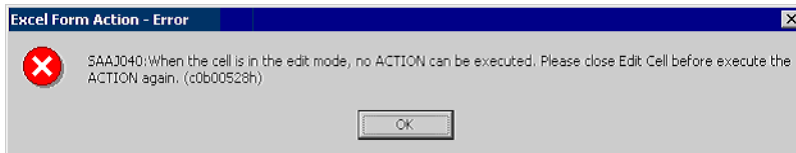

■ Restrictions on Copying or Cutting and Pasting the Action Area

When you paste the Action area using Ctrl+C & Ctrl+V or Ctrl+X & Ctrl+V, specify [Target Cell Range] for the copied Action area.

The Action area just after pasting remains the same [Target Cell Range] as that for the original Action area.

	A	B	C	D
1				
2				
3				
4				
5				
6				
7				

■ Excel Auto Save Function

The Excel auto save function does not operate due to the Excel restrictions. To save automatically, create the Excel save macro using the following procedure and execute the created save macro by Action.

- 1 Open a template you want to save automatically using 'Pro-Studio EX'.

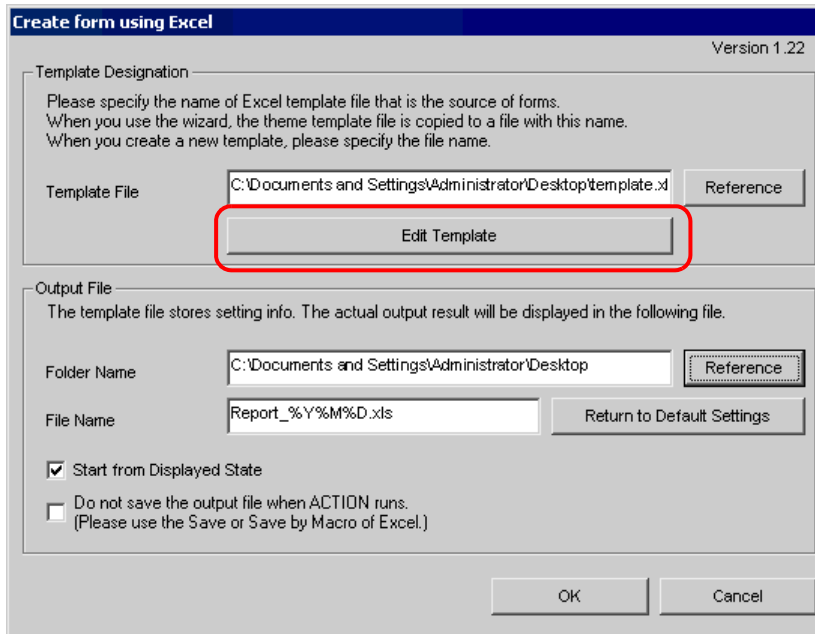

- 2 Select "Macro" and "Record New Macro" from the "Tools" menu.

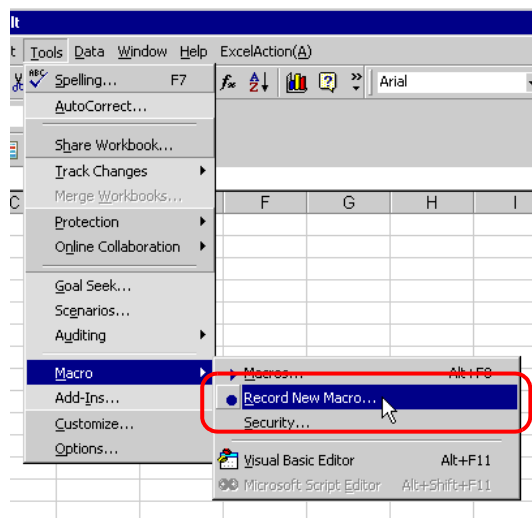

- 3 Enter the macro name "Macro1" and click the [OK] button.

Recording the macro starts.

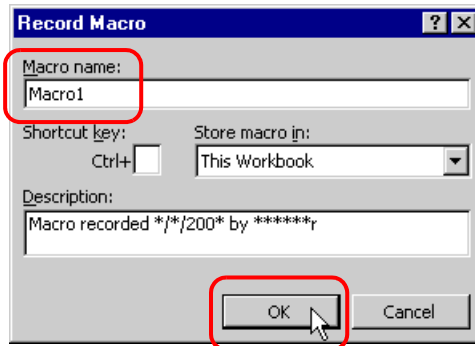

- 4 Select "Save" from the "File" menu.

"Macro1" is recorded in the macro.

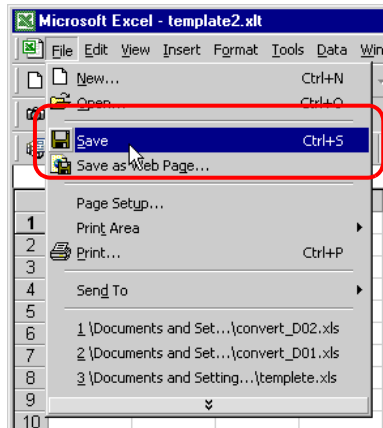

- 5 Select "Macro" and "Stop Recording" from the "Tools" menu.

Recording the macro is complete.

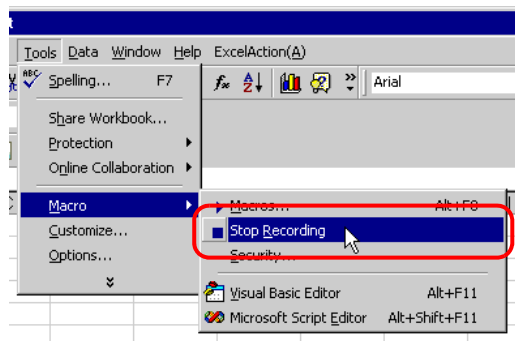

6 Select "Execution Sequence List" from the "Excel Action" menu.

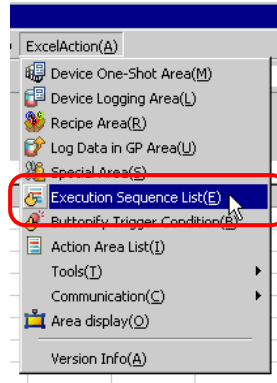

7 Create the trigger condition save automatically.

8 Select the created trigger condition and "Excel Operation Function".

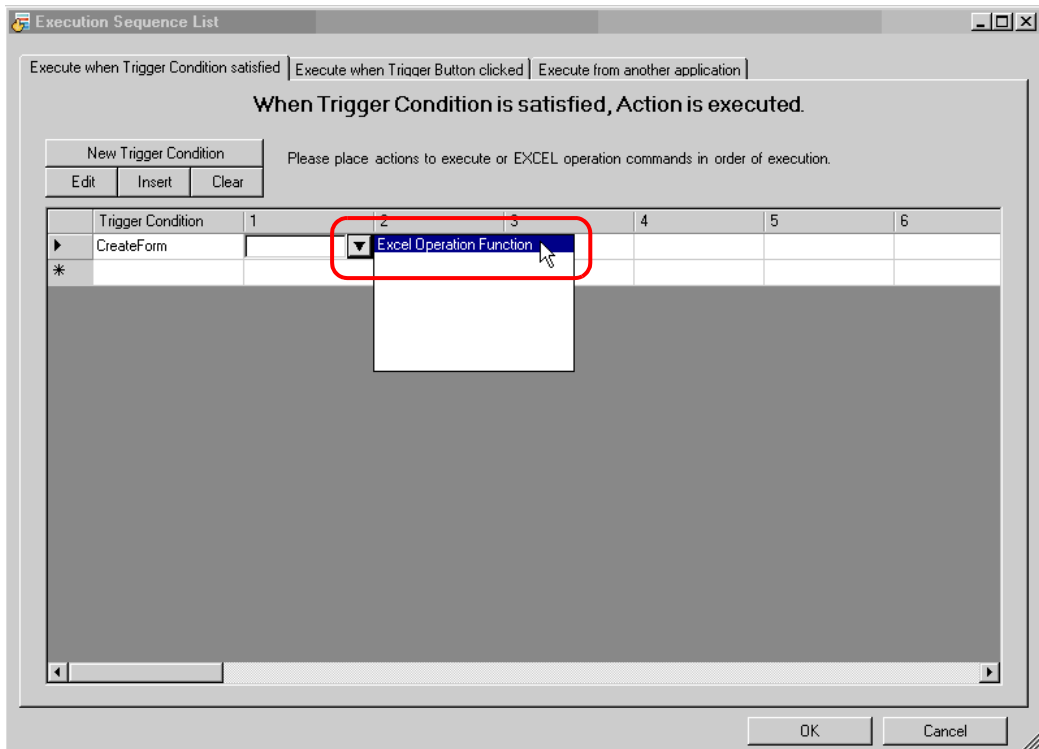

9 Select "Execute Macro" and enter the macro name "Macro1".

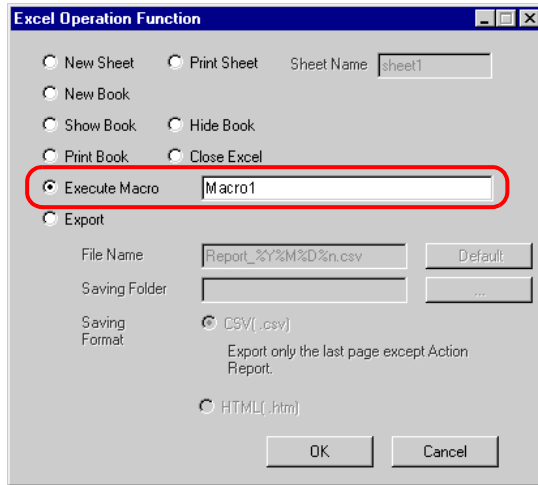

10 Click the [OK] button.

11 Finish editing the template.

12 Save/Reload the setting contents.

According to the created trigger condition, the template is automatically saved.