



H Series Ethernet Driver

1	System Configuration.....	3
2	Selection of External Device	6
3	Example of Communication Setting	7
4	Setup Items	27
5	Supported Device.....	31
6	Device Code and Address Code.....	38
7	Error Messages.....	41

PREFACE

This manual describes how to connect the Display (GP3000 series) and the External Device (target PLC).

In this manual, the connection procedure will be described by following the below sections:

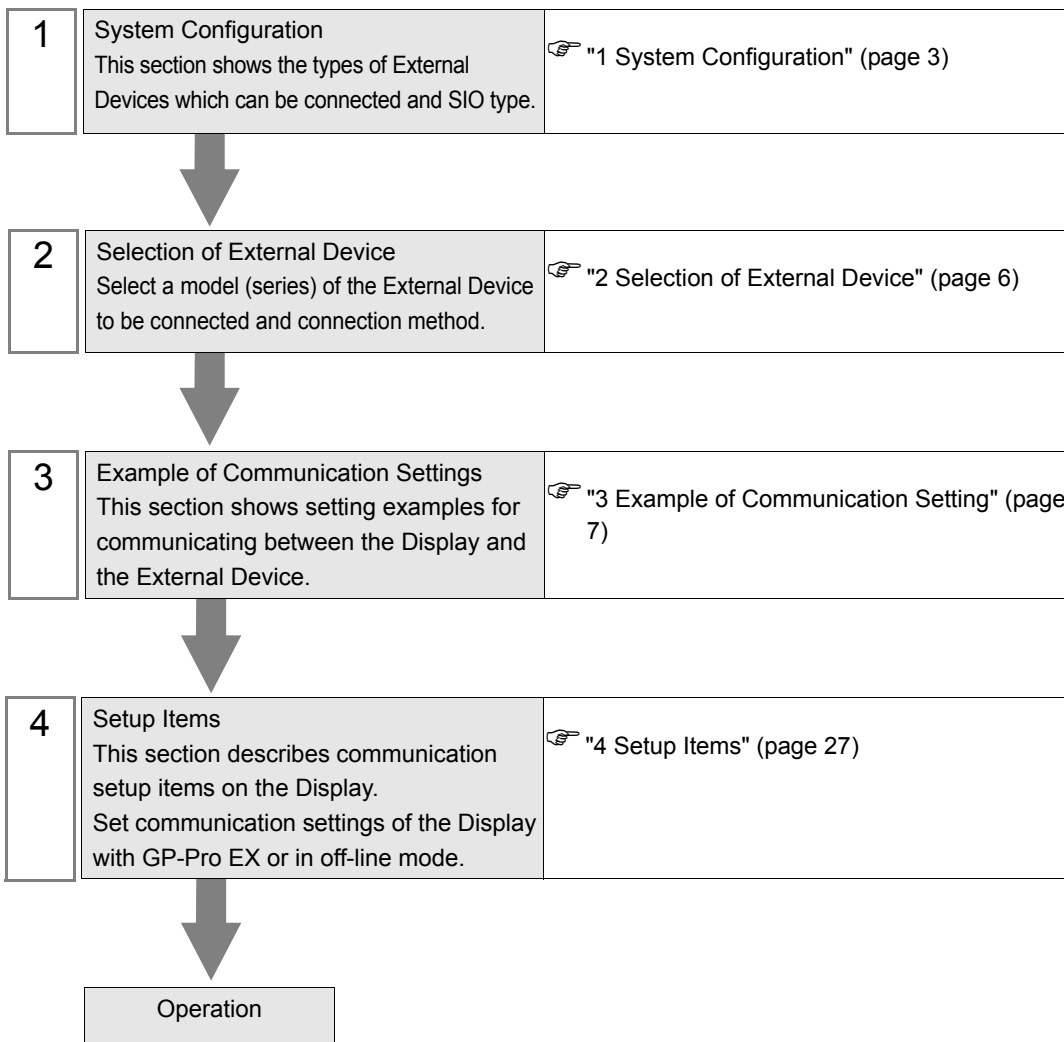

1 System Configuration

The system configuration in the case when the External Device of Hitachi IES Co., Ltd. and the Display are connected is shown.

Series Name	CPU	Link I/F	SIO Type	Setting Example
H	H-4010(CPU3-40H) H-2002(CPU2-20H) H-1002(CPU2-10H) H-702(CPU2-07H) H-302(CPU2-03H)	LAN_ETH2 LAN_ETH	Ethernet (TCP)	Setting Example 1 (page 7)
			Ethernet (UDP)	Setting Example 2 (page 9)
EH-150	EH-150(EH-CPU548) EH-150(EH-CPU516) EH-150(EH-CPU448A) EH-150(EH-CPU448) EH-150(EH-CPU316A) EH-150(EH-CPU308A)	EH-ETH*1	Ethernet (TCP)	Setting Example 3 (page 11)
			Ethernet (UDP)	Setting Example 4 (page 13)
Web Controller	EH-WD10DR EH-WA23DR	Ethernet port on CPU	Ethernet (TCP)	Setting Example 5 (page 15)
			Ethernet (UDP)	Setting Example 6 (page 17)
EHV	EHV-CPU128 EHV-CPU64 EHV-CPU32 EHV-CPU16	Ethernet port on CPU	Ethernet (TCP)	Setting Example 7 (page 19)
			Ethernet (UDP)	Setting Example 8 (page 21)
		EH-ETH*1	Ethernet (TCP)	Setting Example 9 (page 23)
			Ethernet (UDP)	Setting Example 10 (page 25)

*1 When connecting with Display, EH-ETH with SOFTWARE VER.06 or later is required. (Check the label of EH-ETH main body for the version.)

■ Connection Configuration

[1:1 Connection]

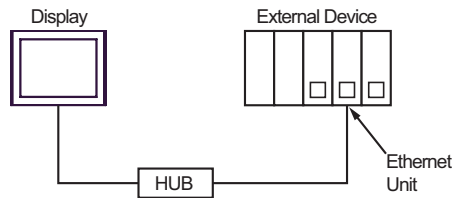

[1:n Connection]

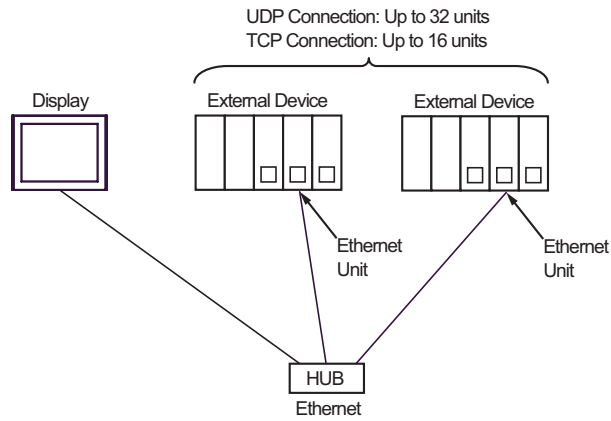

[n :1 Connection]

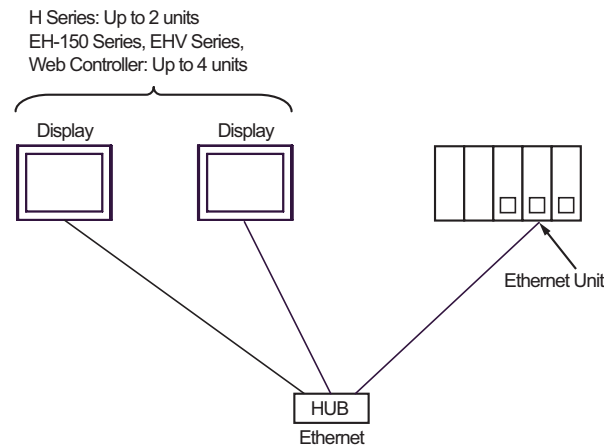

[n:m Connection]

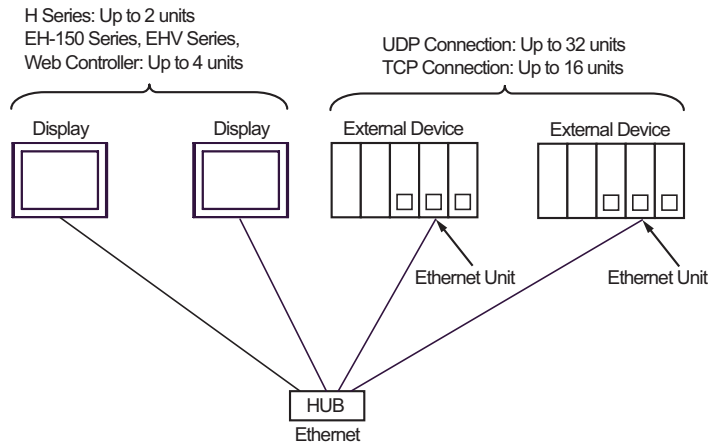

[Multiple CPU link]

Web Controller does not support this pattern.

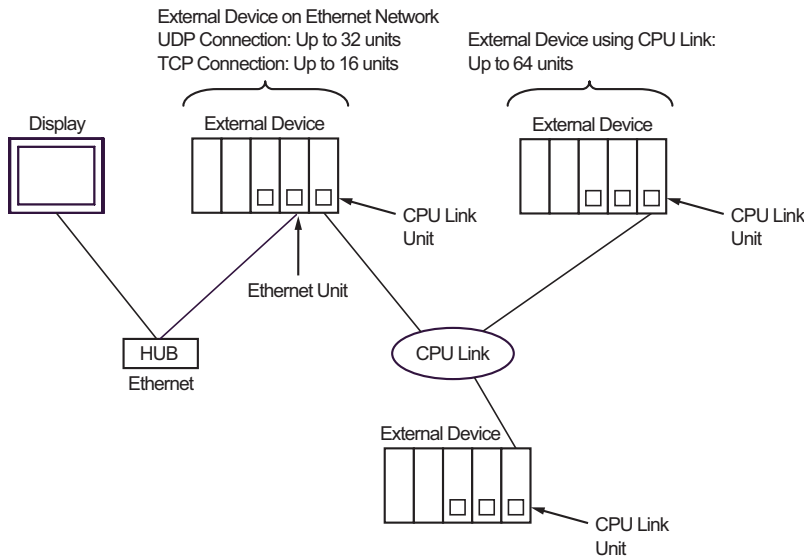

2 Selection of External Device

Select the External Device to be connected to the Display.

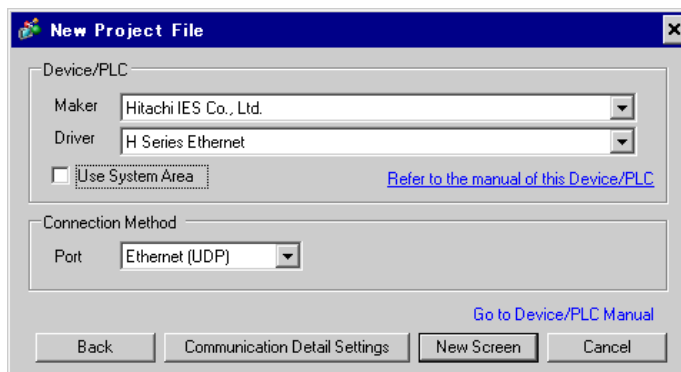

Setup Items	Setup Description
Maker	Select the maker of the External Device to be connected. Select "Hitachi IES Co., Ltd."
Series	Select a model (series) of the External Device to be connected and connection method. Select "H Series Ethernet". Check the External Device which can be connected in " H Series Ethernet" in system configuration. ☞ "1 System Configuration" (page 3)
Use System Area	Check this option when you synchronize the system data area of the Display and the device (memory) of the External Device. When synchronized, you can use the ladder program of the External Device to switch the display or display the window on the Display. Cf. GP-Pro EX Reference Manual "Appendix 1.4 LS Area (only for direct access method)" This can be also set with GP-Pro EX or in off-line mode of the Display. Cf. GP-Pro EX Reference Manual "6.13.6[Setting Guide of [System Setting Window], Setting Guide of [Main Unit Settings], System Area Setting" Cf. GP3000 Series User's Manual "4.3.6 System Area Setting"
Port	Select the port of the display to be connected to the External Device from "Ethernet (UDP)" and "Ethernet (TCP)".

3 Example of Communication Setting

Examples of communication settings of the Display and the External Device, recommended by Digital Electronics Corp., are shown.

3.1 Setting Example 1

■ Settings of GP-Pro EX

◆ Communication Settings

To display the setting screen, select [Device/PLC Settings] from [System setting window] in workspace.

◆ Device Setting

To display the setting screen, click  ([Setting]) of the External Device you want to set from [Device-Specific Settings] of [Device/PLC Settings]. Select [H/EH-150 Series] from [Series].

◆ Notes

- Check with a network administrator about IP address. Do not set the duplicate IP address in the same network.
- Set IP address and Port Number on the External Device for IP address and Port Number in Device-specific settings.
- You need to set IP address on the Display in the off-line mode of the display.

■ Settings of External Device (LAN-ETH, LAN-ETH2)

Use the ladder software (Ladder Editor for Windows) to enter the value for appointed I/O No. for communication setting.

Please refer to the manual of the ladder software for more details.

1. Assign the Ethernet unit in the CPU unit.

Perform the environmental setting to allow the CPU unit to communicate with the ladder software.

2. Use the [I/O assign] of the ladder software to assign the Ethernet unit to I/O.
3. Use [CPU Write] in the ladder software to write the I/O assignment setting in the External Device.

That completes the environmental setting of the External Device.

4. Next, perform the communication settings of the External Device.

Set the DIP switch of the Ethernet unit as shown below.

The setting below enables to set the IP address of the Ethernet unit.

DIP Switch	Settings	Requirements
1	OFF	Mode Selection (Always OFF)
2	ON ^{*1}	10BASE-T(ON)/10BASE-5(OFF) Switch
3	OFF	Reservation (Always OFF)
4	OFF	IP address rewrite setting (OFF: Rewritable)
5	OFF	Selection by function type You can set IP address at the status on the left.
6	ON	
7	ON	
8	OFF	

*1 For LAN-ETH2, always set OFF (10BASE-T only).

5. Enter IP address or port No. for appointed I/O No. in the I/O monitor of the ladder software.
I/O No. to be entered varies depending on the slot position to which the Ethernet unit is assigned.
Please refer to the manual of the External Device for more details.
6. Write the communication setting in the Ethernet unit.
Display the address "R0" in I/O monitor of the ladder software and enter 1 for the setting value in the [Force Set/Reset] dialog box.
7. Turn OFF the power of the External Device. After turning OFF DIP switches 5 to 8 in the Ethernet unit, turn ON the power of the External Device

◆ Notes

- Check with a network administrator about IP address. Do not set the duplicate IP address in the same network.

3.2 Setting Example 2

■ Settings of GP-Pro EX

◆ Communication Settings

To display the setting screen, select [Device/PLC Settings] from [System setting window] in workspace.

◆ Device Setting

To display the setting screen, click  ([Setting]) of the External Device you want to set from [Device-Specific Settings] of [Device/PLC Settings]. Select [H/EH-150 Series] from [Series].

◆ Notes

- Check with a network administrator about IP address. Do not set the duplicate IP address in the same network.
- Set IP address and Port Number on the External Device for IP address and Port Number in Device-specific settings.
- You need to set IP address on the Display in the off-line mode of the display.

■ Settings of External Device (LAN-ETH, LAN-ETH2)

Use the ladder software (Ladder Editor for Windows) to enter the value for appointed I/O No. for communication setting.

Please refer to the manual of the ladder software for more details.

1. Assign the Ethernet unit in the CPU unit.

Perform the environmental setting to allow the CPU unit to communicate with the ladder software.

2. Use the [I/O assign] of the ladder software to assign the Ethernet unit to I/O.
3. Use [CPU Write] in the ladder software to write the I/O assignment setting in the External Device.

That completes the environmental setting of the External Device.

4. Next, perform the communication settings of the External Device.

Set the DIP switch of the Ethernet unit as shown below.

The setting below enables to set the IP address of the Ethernet unit.

DIP Switch	Settings	Requirements
1	OFF	Mode Selection (Always OFF)
2	ON ^{*1}	10BASE-T(ON)/10BASE-5(OFF) Switch
3	OFF	Reservation (Always OFF)
4	OFF	IP address rewrite setting (OFF: Rewritable)
5	OFF	Selection by function type You can set IP address at the status on the left.
6	ON	
7	ON	
8	OFF	

*1 For LAN-ETH2, always set OFF (10BASE-T only).

5. Enter IP address or port No. for appointed I/O No. in the I/O monitor of the ladder software.
I/O No. to be entered varies depending on the slot position to which the Ethernet unit is assigned.
Please refer to the manual of the External Device for more details.
6. Write the communication setting in the Ethernet unit.
Display the address "R0" in I/O monitor of the ladder software and enter 1 for the setting value in the [Force Set/Reset] dialog box.
7. Turn OFF the power of the External Device. After turning OFF DIP switches 5 to 8 in the Ethernet unit, turn ON the power of the External Device

◆ Notes

- Check with a network administrator about IP address. Do not set the duplicate IP address in the same network.

3.3 Setting Example 3

■ Settings of GP-Pro EX

◆ Communication Settings

To display the setting screen, select [Device/PLC Settings] from [System setting window] in workspace.

Device/PLC 1

Summary [Change Device/PLC](#)

Maker Hitachi IES Co., Ltd. Driver H Series Ethernet Port Ethernet (TCP)

Text Data Mode 1 [Change](#)

Communication Settings

Port No. 1024 Auto

Timeout 3 (sec)

Retry 0

Wait To Send 0 (ms) [Default](#)

Device-Specific Settings

Allowable No. of Device/PLCs 16 Unit(s)

No.	Device Name	Settings
1	PLC1	Series=H/EH-150 Series, IP Address=192.168.000.001, Port No.=3004

◆ Device Setting

To display the setting screen, click ([Setting]) of the External Device you want to set from [Device-Specific Settings] of [Device/PLC Settings]. Select [H/EH-150 Series] from [Series].

Individual Device Settings

PLC1

Series H/EH-150 Series

Please reconfirm all of address settings that you are using if you have changed the series.

IP Address 192.168.0.1

Port No. 3004

[Default](#)

[OK \(O\)](#) [Cancel](#)

◆ Notes

- Check with a network administrator about IP address. Do not set the duplicate IP address in the same network.
- Set IP address and Port Number on the External Device for IP address and Port Number in Device-specific settings.
- You need to set IP address on the Display in the off-line mode of the display.

■ Settings of External Device (EH-ETH)

Use the Web Browser to access the Ethernet unit for communication setting.

Note that the ladder software (Ladder Editor for Windows) is used for environmental setting of the External Device.

Please refer to the manual of the EH-ETH for more details.

1. Assign the Ethernet unit to CPU unit by using the [I/O assign] of the ladder software.
2. Turn ON the DIP switch 1 and 6 of the Ethernet unit, and turn ON the power. Then, a temporary address (192.168.0.4) for accessing the Ethernet unit will be set.

Bit No.*1								Operation Mode
1	2	3	4	5	6	7	8	
ON	OFF	OFF	OFF	OFF	ON	OFF	OFF	Ethernet Information Setting Mode

*1 Use Bit No.3 to No.8 to set the lowest byte of IP address. The upper 3 bytes are fixed to 192.168.0..

3. Connect the PC's Ethernet port and the EH-ETH's Ethernet port by LAN cable. (Connect via HUB or connect directly by a crossing cable.)
4. Enter "http://192.168.0.4/" in the address input box of the Web Browser to access the Ethernet unit.
To access, you need to set the upper 3 bytes of PC's IP address to 192.168.0.. (ex. 192.168.0.10)
5. Select [IP Address] from the menu frame in the displayed screen and set IP address.
6. Similarly, select [Task Code] from the menu frame and set [Port No.] and [Protocol].
Also, please set the IP Address, [Port No.] and [Protocol] as the same value as those set on the Display side.
7. Turn OFF the power of the External Device. After turning OFF all DIP switches, turn ON the power of the External Device.

◆ Notes

- Check with a network administrator about IP address. Do not set the duplicate IP address in the same network.

3.4 Setting Example 4

■ Settings of GP-Pro EX

◆ Communication Settings

To display the setting screen, select [Device/PLC Settings] from [System setting window] in workspace.

◆ Device Setting

To display the setting screen, click  ([Setting]) of the External Device you want to set from [Device-Specific Settings] of [Device/PLC Settings]. Select [H/EH-150 Series] from [Series].

◆ Notes

- Check with a network administrator about IP address. Do not set the duplicate IP address in the same network.
- Set IP address and Port Number on the External Device for IP address and Port Number in Device-specific settings.
- You need to set IP address on the Display in the off-line mode of the display.

■ Settings of External Device (EH-ETH)

Use the Web Browser to access the Ethernet unit for communication setting.

Note that the ladder software (Ladder Editor for Windows) is used for environmental setting of the External Device.

Please refer to the manual of the EH-ETH for more details.

1. Assign the Ethernet unit to CPU unit by using the [I/O assign] of the ladder software.
2. Turn ON the DIP switch 1 and 6 of the Ethernet unit, and turn ON the power. Then, a temporary address (192.168.0.4) for accessing the Ethernet unit will be set.

Bit No.*1								Operation Mode
1	2	3	4	5	6	7	8	
ON	OFF	OFF	OFF	OFF	ON	OFF	OFF	Ethernet Information Setting Mode

*1 Use Bit No.3 to No.8 to set the lowest byte of IP address. The upper 3 bytes are fixed to 192.168.0..

3. Connect the PC's Ethernet port and the EH-ETH's Ethernet port by LAN cable. (Connect via HUB or connect directly by a crossing cable.)
4. Enter "http://192.168.0.4/" in the address input box of the Web Browser to access the Ethernet unit.
To access, you need to set the upper 3 bytes of PC's IP address to 192.168.0.. (ex. 192.168.0.10)
5. Select [IP Address] from the menu frame in the displayed screen and set IP address.
6. Similarly, select [Task Code] from the menu frame and set [Port No.] and [Protocol].
Also, please set the IP Address, [Port No.] and [Protocol] as the same value as those set on the Display side.
7. Turn OFF the power of the External Device. After turning OFF all DIP switches, turn ON the power of the External Device.

◆ Notes

- Check with a network administrator about IP address. Do not set the duplicate IP address in the same network.

3.5 Setting Example 5

■ Settings of GP-Pro EX

◆ Communication Settings

To display the setting screen, select [Device/PLC Settings] from [System setting window] in workspace.

Device/PLC 1

Summary [Change Device/PLC](#)

Maker Driver Port

Text Data Mode [Change](#)

Communication Settings

Port No. Auto

Timeout (sec)

Retry

Wait To Send (ms)

Device-Specific Settings

Allowable No. of Device/PLCs 16 Unit(s)

No.	Device Name	Settings
1	PLC1	Series=Web Controller Series,IP Address=192.168.0.001,Port No.=3004

◆ Device Setting

To display the setting screen, click ([Setting]) of the External Device you want to set from [Device-Specific Settings] of [Device/PLC Settings]. Select [Web Controller Series] from [Series].

Individual Device Settings

PLC1

Series

Please reconfirm all of address settings that you are using if you have changed the series.

IP Address

Port No.

◆ Notes

- Check with a network administrator about IP address. Do not set the duplicate IP address in the same network.
- Set IP address and Port Number on the External Device for IP address and Port Number in Device-specific settings.
- You need to set IP address on the Display in the off-line mode of the display.

■ Settings of External Device (Web Controller)

Use the Web Browser to access the External Device for communication setting.

Please refer to the manual of the Web Controller for more details.

1. By setting up the Operation Mode Setting Switch of the External Device as shown below, the temporary IP address of the Ethernet port will be set to "192.168.0.1".

<Operation Mode Setting Switch>

EH-WD10DR: Set the Rotary switch to "2".

EH-WA23DR: Turn ON the DIP switch 4 only.

2. Connect the PC's Ethernet port and the Web Controller's Ethernet port by LAN cable. (Connect via HUB or connect directly by a crossing cable.)

3. Enter "http://192.168.0.1/mwconfig.cgi" in the address input box of the Web Browser to access the External Device.

To access, you need to set the upper 3 bytes of PC's IP address to 192.168.0..(ex. 192.168.0.10)

4. Login in the displayed System Configuration Login screen.

5. Select [Ethernet Protocol]-[Passive HIProtocol] from [System Configuration] and set [Task Code Port] and [Port No.].

6. Similarly, select [IP Address] from [System Configuration] in the displayed screen and set IP address.

Also, please set [Task Code Port], [Port No.] and the IP Address as the same value as those set on the Display side.

MEMO

- The Web Controller will be rebooted after IP address settings.
Enter "http://192.168.0.1/mwconfig.cgi" in the address input box of the Web Browser, and login on the System Configuration Login screen. Then, check the settings.
-

7. Setup the Operation Mode Setting Switch of the External Device as shown below, and turn the power ON again.

<Operation Mode Setting Switch>

EH-WD10DR: Set the Rotary switch to "0".

EH-WA23DR: Turn OFF the all DIP switches.

◆ Notes

- Check with a network administrator about IP address. Do not set the duplicate IP address in the same network.

3.6 Setting Example 6

■ Settings of GP-Pro EX

◆ Communication Settings

To display the setting screen, select [Device/PLC Settings] from [System setting window] in workspace.

◆ Device Setting

To display the setting screen, click  ([Setting]) of the External Device you want to set from [Device-Specific Settings] of [Device/PLC Settings]. Select [Web Controller Series] from [Series].

◆ Notes

- Check with a network administrator about IP address. Do not set the duplicate IP address in the same network.
- Set IP address and Port Number on the External Device for IP address and Port Number in Device-specific settings.
- You need to set IP address on the Display in the off-line mode of the display.

■ Settings of External Device (Web Controller)

Use the Web Browser to access the External Device for communication setting.

Please refer to the manual of the Web Controller for more details.

1. By setting up the Operation Mode Setting Switch of the External Device as shown below, the temporary IP address of the Ethernet port will be set to "192.168.0.1".

<Operation Mode Setting Switch>

EH-WD10DR: Set the Rotary switch to "2".

EH-WA23DR: Turn ON the DIP switch 4 only.

2. Connect the PC's Ethernet port and the Web Controller's Ethernet port by LAN cable. (Connect via HUB or connect directly by a crossing cable.)

3. Enter "http://192.168.0.1/mwconfig.cgi" in the address input box of the Web Browser to access the External Device.

To access, you need to set the upper 3 bytes of PC's IP address to 192.168.0..(ex. 192.168.0.10)

4. Login in the displayed System Configuration Login screen.

5. Select [Ethernet Protocol]-[Passive HIProtocol] from [System Configuration] and set [Task Code Port] and [Port No.].

6. Similarly, select [IP Address] from [System Configuration] in the displayed screen and set IP address.

Also, please set [Task Code Port], [Port No.] and the IP Address as the same value as those set on the Display side.

MEMO

- The Web Controller will be rebooted after IP address settings.
Enter "http://192.168.0.1/mwconfig.cgi" in the address input box of the Web Browser, and login on the System Configuration Login screen. Then, check the settings.
-

7. Setup the Operation Mode Setting Switch of the External Device as shown below, and turn the power ON again.

<Operation Mode Setting Switch>

EH-WD10DR: Set the Rotary switch to "0".

EH-WA23DR: Turn OFF the all DIP switches.

◆ Notes

- Check with a network administrator about IP address. Do not set the duplicate IP address in the same network.

3.7 Setting Example 7

■ Settings of GP-Pro EX

◆ Communication Settings

To display the setting screen, select [Device/PLC Settings] from [System setting window] in workspace.

◆ Device Setting

To display the setting screen, click  ([Setting]) of the External Device you want to set from [Device-Specific Settings] of [Device/PLC Settings]. Select [EHV Series] from [Series].

◆ Notes

- Check with a network administrator about IP address. Do not set the duplicate IP address in the same network.
- Set IP address and Port Number on the External Device for IP address and Port Number in Device-specific settings.
- You need to set IP address on the Display in the off-line mode of the display.

■ Settings of External Device (Ethernet Port on EHV-CPU)

Use the programming software (Control Editor) for communication setting.

Please refer to the manual of the EHV for more details.

1. Start the programming software and create the project. The project is displayed in the offline mode.
2. Select [Editor Communication Setting] from the [Tool] menu to display the communication setting dialog box.
3. Select the communication method to transfer the External Device between "USB" and "Serial", and then click [Setting].
4. Connect the PC and the External Device by a USB cable or a serial cable (Hitachi IES Co., Ltd.).
5. Select [Mode Change] - [Online] from the [Online] menu to move to the online mode.
6. Select [CPU Setting] - [IP Address Setting] from the [Tool] menu to set IP address.
7. Select [CPU Setting] - [Ethernet Communication (Task Code) Setting] from the [Tool] menu to set [Port No.] and [Protocol].

Also, please set the IP Address, [Port No.] and [Protocol] as the same value as those set on the Display side.

8. Turn ON the power of the External Device again.

◆ Notes

- Check with a network administrator about IP address. Do not set the duplicate IP address in the same network.

3.8 Setting Example 8

■ Settings of GP-Pro EX

◆ Communication Settings

To display the setting screen, select [Device/PLC Settings] from [System setting window] in workspace.

◆ Device Setting

To display the setting screen, click  ([Setting]) of the External Device you want to set from [Device-Specific Settings] of [Device/PLC Settings]. Select [EHV Series] from [Series].

◆ Notes

- Check with a network administrator about IP address. Do not set the duplicate IP address in the same network.
- Set IP address and Port Number on the External Device for IP address and Port Number in Device-specific settings.
- You need to set IP address on the Display in the off-line mode of the display.

■ Settings of External Device (Ethernet Port on EHV-CPU)

Use the programming software (Control Editor) for communication setting.

Please refer to the manual of the EHV for more details.

1. Start the programming software and create the project. The project is displayed in the offline mode.
2. Select [Editor Communication Setting] from the [Tool] menu to display the communication setting dialog box.
3. Select the communication method to transfer the External Device between "USB" and "Serial", and then click [Setting].
4. Connect the PC and the External Device by a USB cable or a serial cable (Hitachi IES Co., Ltd.).
5. Select [Mode Change] - [Online] from the [Online] menu to move to the online mode.
6. Select [CPU Setting] - [IP Address Setting] from the [Tool] menu to set IP address.
7. Select [CPU Setting] - [Ethernet Communication (Task Code) Setting] from the [Tool] menu to set [Port No.] and [Protocol].

Also, please set the IP Address, [Port No.] and [Protocol] as the same value as those set on the Display side.

8. Turn ON the power of the External Device again.

◆ Notes

- Check with a network administrator about IP address. Do not set the duplicate IP address in the same network.

3.9 Setting Example 9

■ Settings of GP-Pro EX

◆ Communication Settings

To display the setting screen, select [Device/PLC Settings] from [System setting window] in workspace.

◆ Device Setting

To display the setting screen, click  ([Setting]) of the External Device you want to set from [Device-Specific Settings] of [Device/PLC Settings]. Select [EHV Series] from [Series].

◆ Notes

- Check with a network administrator about IP address. Do not set the duplicate IP address in the same network.
- Set IP address and Port Number on the External Device for IP address and Port Number in Device-specific settings.
- You need to set IP address on the Display in the off-line mode of the display.

■ Settings of External Device (EH-ETH)

Use the Web Browser to access the Ethernet unit for communication setting.

Note that the ladder software (Ladder Editor for Windows) is used for environmental setting of the External Device.

Please refer to the manual of the EH-ETH for more details.

1. Assign the Ethernet unit to CPU unit by using the [I/O assign] of the ladder software.
2. Turn ON the DIP switch 1 and 6 of the Ethernet unit, and turn ON the power. Then, a temporary address (192.168.0.4) for accessing the Ethernet unit will be set.

Bit No.*1								Operation Mode
1	2	3	4	5	6	7	8	
ON	OFF	OFF	OFF	OFF	ON	OFF	OFF	Ethernet Information Setting Mode

*1 Use Bit No.3 to No.8 to set the lowest byte of IP address. The upper 3 bytes are fixed to 192.168.0..

3. Connect the PC's Ethernet port and the EH-ETH's Ethernet port by LAN cable. (Connect via HUB or connect directly by a crossing cable.)
4. Enter "http://192.168.0.4/" in the address input box of the Web Browser to access the Ethernet unit.
To access, you need to set the upper 3 bytes of PC's IP address to 192.168.0.. (ex. 192.168.0.10)
5. Select [IP Address] from the menu frame in the displayed screen and set IP address.
6. Similarly, select [Task Code] from the menu frame and set [Port No.] and [Protocol].
Also, please set the IP Address, [Port No.] and [Protocol] as the same value as those set on the Display side.
7. Turn OFF the power of the External Device. After turning OFF all DIP switches, turn ON the power of the External Device.

◆ Notes

- Check with a network administrator about IP address. Do not set the duplicate IP address in the same network.

3.10 Setting Example 10

■ Settings of GP-Pro EX

◆ Communication Settings

To display the setting screen, select [Device/PLC Settings] from [System setting window] in workspace.

Device/PLC 1

Summary [Change Device/PLC](#)

Maker Hitachi IES Co., Ltd. Driver H Series Ethernet Port Ethernet (UDP)

Text Data Mode 1 [Change](#)

Communication Settings

Port No. 1024

Timeout 3 (sec)

Retry 2

Wait To Send 0 (ms) [Default](#)

Device-Specific Settings

Allowable No. of Device/PLCs 32 Unit(s) [Settings](#)

No.	Device Name	Settings
1	PLC1	Series=EHV Series,IP Address=192.168.0.001,Port No.=3004

◆ Device Setting

To display the setting screen, click ([Setting]) of the External Device you want to set from [Device-Specific Settings] of [Device/PLC Settings]. Select [EHV Series] from [Series].

Individual Device Settings

PLC1

Series EHV Series

Please reconfirm all of address settings that you are using if you have changed the series.

IP Address 192.168.0.1

Port No. 3004

[Default](#)

[OK \(O\)](#) [Cancel](#)

◆ Notes

- Check with a network administrator about IP address. Do not set the duplicate IP address in the same network.
- Set IP address and Port Number on the External Device for IP address and Port Number in Device-specific settings.
- You need to set IP address on the Display in the off-line mode of the display.

■ Settings of External Device (EH-ETH)

Use the Web Browser to access the Ethernet unit for communication setting.

Note that the ladder software (Ladder Editor for Windows) is used for environmental setting of the External Device.

Please refer to the manual of the EH-ETH for more details.

1. Assign the Ethernet unit to CPU unit by using the [I/O assign] of the ladder software.
2. Turn ON the DIP switch 1 and 6 of the Ethernet unit, and turn ON the power. Then, a temporary address (192.168.0.4) for accessing the Ethernet unit will be set.

Bit No.*1								Operation Mode
1	2	3	4	5	6	7	8	
ON	OFF	OFF	OFF	OFF	ON	OFF	OFF	Ethernet Information Setting Mode

*1 Use Bit No.3 to No.8 to set the lowest byte of IP address. The upper 3 bytes are fixed to 192.168.0..

3. Connect the PC's Ethernet port and the EH-ETH's Ethernet port by LAN cable. (Connect via HUB or connect directly by a crossing cable.)
4. Enter "http://192.168.0.4/" in the address input box of the Web Browser to access the Ethernet unit.
To access, you need to set the upper 3 bytes of PC's IP address to 192.168.0.. (ex. 192.168.0.10)
5. Select [IP Address] from the menu frame in the displayed screen and set IP address.
6. Similarly, select [Task Code] from the menu frame and set [Port No.] and [Protocol].
Also, please set the IP Address, [Port No.] and [Protocol] as the same value as those set on the Display side.
7. Turn OFF the power of the External Device. After turning OFF all DIP switches, turn ON the power of the External Device.

◆ Notes

- Check with a network administrator about IP address. Do not set the duplicate IP address in the same network.

4 Setup Items

Set communication settings of the Display with GP-Pro Ex or in off-line mode of the Display.

The setting of each parameter must be identical to that of External Device.

☞ "3 Example of Communication Setting" (page 7)

4.1 Setup Items in GP-Pro EX

■ Communication Settings

To display the setting screen, select [Device/PLC Settings] from [System setting window] in workspace.

Setup Items	Setup Description
Port No.	Use an integer from 1024 to 65535 to enter the port No. of the Display. When you check the option of [Auto], the port No. will be automatically set. MEMO • [Auto] option is available to set only when you select "Ethernet (TCP)" in [Connecting Method].
Timeout	Use an integer from 1 to 127 to enter the time (s) for which the Display waits for the response from the External Device.
Retry	In case of no response from the External Device, use an integer from 0 to 255 to enter how many times the Display retransmits the command.
Wait To Send	Use an integer from 0 to 255 to enter standby time (ms) for the Display from receiving packets to transmitting next commands.

■ Device Setting

To display the setting screen, click  ([Setting]) of the External Device you want to set from [Device-Specific Settings] of [Device/PLC Settings].

When connecting multiple External Devices, you can click  from [Device-Specific Settings] of [Device/PLC Settings] to add the External Device which is available to set.



Setup Items	Setup Description
Series	Select a model of the External Device.
IP Address	Set IP address of the External Device. <div style="border: 1px solid black; padding: 2px; display: inline-block; margin-bottom: 5px;">MEMO</div> <ul style="list-style-type: none"> Check with a network administrator about IP address. Do not set the duplicate IP address.
Port No.	Use an integer from 1024 to 65535 to enter the port No. of the External Device.

4.2 Settings in Off-Line Mode

MEMO

- Please refer to GP3000 Series User's Manual for more information on how to enter off-line mode or about operation.

Cf. GP3000 Series User's Manual "Chapter 4 Setting"

■ Communication Settings

To display the setting screen, touch [Device/PLC Settings] from [Peripheral Equipment Settings] in the off-line mode. Touch the External Device you want to set from the displayed list.

Comm.	Device			
H Series Ethernet		[UDP]	Page 1/1	
Port No.	<input type="radio"/> Fixed <input checked="" type="radio"/> Auto	<input type="text" value="1024"/> <input type="button" value="▼"/> <input type="button" value="▲"/>		
Timeout(s)		<input type="text" value="3"/> <input type="button" value="▼"/> <input type="button" value="▲"/>		
Retry		<input type="text" value="2"/> <input type="button" value="▼"/> <input type="button" value="▲"/>		
Wait To Send(ms)		<input type="text" value="0"/> <input type="button" value="▼"/> <input type="button" value="▲"/>		
Exit		Back		2006/05/15 11:33:02

Setup Items	Setup Description
Port No.	Set the Port No. of the display. In UDP connection, entered port No. will be assigned regardless of whether you select [Fixed] or [Auto]. In TCP connection, select either of [Fixed] or [Auto]. When you select [Fixed], use an integer from 1024 to 65535 to enter the port No. of the display. When you select [Auto], the port No. will be automatically assigned regardless of the entered value.
Timeout	Use an integer from 1 to 127 to enter the time (s) for which the Display waits for the response from the External Device.
Retry	In case of no response from the External Device, use an integer from 0 to 255 to enter how many times the Display retransmits the command.
Wait To Send	Use an integer from 0 to 255 to enter standby time (ms) for the Display from receiving packets to transmitting next commands.

■ Device Setting

To display the setting screen, touch [Device/PLC Settings] from [Peripheral Equipment Settings]. Touch the External Device you want to set from the displayed list, and touch [Device Settings].

Comm.	Device			
H Series Ethernet		[UDP]	Page 1/1	
Device/PLC Name		[PLC1] ▼		
Series	H/EH-150 Series			
IP Address	192 168 0 1			
Port No.	3004 ▼ ▲			
Exit		Back		2006/05/15 11:33:05



Setup Items	Setup Description
Device/PLC Name	Select the External Device for device setting. Device name is a title of External Device set with GP-Pro EX.(Initial value [PLC1])
Series	Display a model of the External Device.
IP Address	Set IP address of the External Device. MEMO Check with a network administrator about IP address. Do not set the duplicate IP address.
Port No.	Use an integer from 1024 to 65535 to enter the port No. of the External Device.

5 Supported Device

Range of supported device address is shown in the table below. Please note that the actually supported range of the devices varies depending on the External Device to be used. Please check the actual range in the manual of your External Device.

5.1 H / EH-150 Series

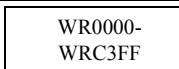
 This address can be specified as system data area.

Device	Bit Address	Word Address	Double Word Address	32 bit	Remarks
External Input	X00000-X05A95	WX0000- WX05A7	DX0000-DX05A6	[L / H]	*1 *2
External Output	Y00000-Y05A95	WY0000- WY05A7	DY0000-DY05A6		*2
Remote Input Relay	X10000-X49995	WX1000-WX4997	DX1000-DX4996		*1 *3
Remote Output Relay	Y10000-Y49995	WY1000-WY4997	DY1000-DY4996		*3
Inner Output	R000-R7BF	-	-		
Special Inner Output	R7C0-R7FF	-	-		
Data Area	M0000-M3FFF	WM000-WM3FF	DM000-DM3FE		
First CPU Link	L00000-L03FFF	WL0000-WL03FF	DL0000-DL03FE		
Second CPU Link	L10000-L13FFF	WL1000-WL13FF	DL1000-DL13FE		
On Delay Timer	TD000 -TD255	-	-		
Single-shot Timer	SS000-SS255	-	-		
Watchdog Timer	WDT000- WDT255	-	-		
Mono Stable Timer	MS000-MS255	-	-		
Retentive Timer	TMR000-TMR255	-	-		
Up Counter	CU000-CU511	-	-		
Ring Counter	RCU000-RCU511	-	-		
Up-down Counter	CT000-CT511	-	-		
Timer Counter (Elapsed Value)	-	TC000-TC511	-		
Word Inner Output	-	 WR0000- WRC3FF	DR0000-DRC3FE		
Network Link Area	-	WN0000- WN7FFF	DN0000-DN7FFE		

*1 Write disable

*2 Specify as shown below.

(Example) External input unit No.1, Slot No.2, Inner Module Bit No.34

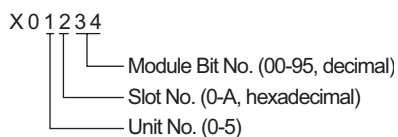

(Example) External input unit No.1, Slot No.2, Inner Module Word No.3

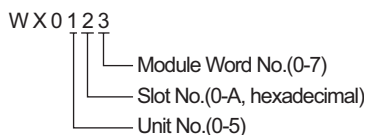

*3 Specify as shown below.

(Example) Remote External Input Remote Master No.1, Remote Slave No.2, Slot No.3, Inner Module Bit No.45

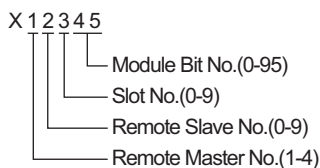

(Example) Remote External Input Remote Master No.1, Remote Slave No.2, Slot No.3, Inner Module Word No.4

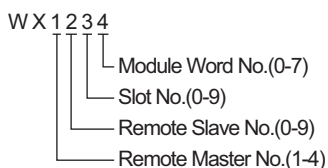

MEMO

- Available type and range of device vary depending on CPU. Be sure to check them in each CPU manual before using.
-

■ CPU How to set address when using the link

Set the check box of "Use CPU Link" to ON.

When using CPU Link, loop No. and unit No. are added to the address.

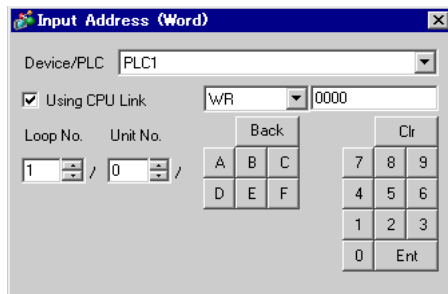

(Example) Loop No.1, Unit No.2

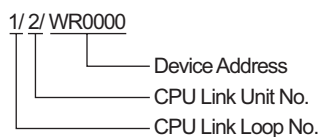





MEMO

- Please refer to the GP-Pro EX Reference Manual for system data area.
Cf. GP-Pro EX Reference Manual "Appendix 1.4 LS Area (only for direct access method)"
- Please refer to the precautions on manual notation for icons in the table.
☞ "Manual Symbols and Terminology"

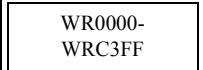
5.2 Web Controller Series

 This address can be specified as system data area.

Device	Bit Address	Word Address	Double Word Address	32 bits	Remarks
External Input	X0000-X0012 X1000-X1015 X2000-X2015 X3000-X3015 X4000-X4015	WX030-WX031 WX100-WX104 WX200-WX204 WX300-WX304 WX400-WX404	DX030 DX100-DX103 DX200-DX203 DX300-DX303 DX400-DX403	[L/H]	*1
External Output	Y0100-Y0109 Y1016-Y1031 Y2016-Y2031 Y3016-Y3031 Y4016-Y4031	WY40 WY105-WY107 WY205-WY207 WY305-WY307 WY405-WY407	DY105-DY106 DY205-DY206 DY305-DY306 DY405-DY406		
Inner Output	R000-R7BF	-	-		
Special Inner Output	R7C0-R7FF	-	-		
Data Area	M0000-M3FFF	WM000-WM3FF	DM000-DM3FE		
On Delay Timer	TD000-TD255	-	-		*2
Single-shot Timer	SS000-SS255	-	-		*2
Up Counter	CU000-CU255	-	-		*2
Up-down Counter	CT000-CT255	-	-		*2*3
Timer Counter (Elapsed Value)	-	TC000-TC255	-		
Word Inner Output	-	 WR0000- WRC3FF	DR0000-DR3FE	*4 	
Word Special Inner Output		 WRF000- WRF1FF	DRF000-DRF1FE		

*1 Write disable

*2 Each timer or counter needs to be defined on the ladder program.

*3 Both the Up-down counter Up input and Down input are defined by CT, however, the device names of the External Device are CTU, CTD respectively.

To access CTU, define the corresponding address as CTU on the ladder program of the External Device. Similarly, to access CTD, define the corresponding address as CTD on the ladder program of the External Device.

*4 For EH-WD10DR, the address range is [WR0000-WR3FFF] for Word Address and [DR0000-DR3FFE] for Double Word Address.

MEMO

- Please refer to the GP-Pro EX Reference Manual for system data area.
Cf. GP-Pro EX Reference Manual "Appendix 1.4 LS Area (only for direct access method)"
- Please refer to the precautions on manual notation for icons in the table.
- "Manual Symbols and Terminology"

5.3 EHV Series

 This address can be specified as system data area.

Device	Bit Address	Word Address	Double Word Address	32 bit	Remarks
External Input	X00000-X05A95	WX0000- WX05A7	DX0000-DX05A6	[L/H]	*1 *2
External Output	Y00000-Y05A95	WY0000- WY05A7	DY0000-DY05A6		*2
Remote Input Relay	X10000-X45A95	WX1000- WX45A7	DX1000-DX45A6		*1 *3
Remote Output Relay	Y10000-Y45A95	WY1000- WY45A7	DY1000-DY45A6		*3
Extension External Input	EX00000- EX5A7FF	WEX0000- WEX5A7F	DEX0000- DEX5A7E		*1
Extension External Output	EY00000- EY5A7FF	WEY0000- WEY5A7F	DEY0000- DEY5A7E		
Inner Output	R000-R7BF	-	-		
Data Area	M00000-M7FFFF	WM0000- WM7FFF	DM0000- DM7FFE		
First CPU Link	L00000-L03FFF	WL0000-WL03FF	DL0000-DL03FE		
Second CPU Link	L10000-L13FFF	WL1000-WL13FF	DL1000-DL13FE		
Third CPU Link	L20000-L23FFF	WL2000-WL23FF	DL2000-DL23FE		
Fourth CPU Link	L30000-L33FFF	WL3000-WL33FF	DL3000-DL33FE		
Fifth CPU Link	L40000-L43FFF	WL4000-WL43FF	DL4000-DL43FE		
Sixth CPU Link	L50000-L53FFF	WL5000-WL53FF	DL5000-DL53FE		
Seventh CPU Link	L60000-L63FFF	WL6000-WL63FF	DL6000-DL63FE		
Eighth CPU Link	L70000-L73FFF	WL7000-WL73FF	DL7000-DL73FE		
On Delay Timer	TD0000-TD2559	-	-		
Off Delay Timer	TDN0000- TDN2559	-	-		
Single-shot Timer	SS0000-SS2559	-	-		
Watchdog Timer	WDT0000- WDT2559	-	-		
Mono Stable Timer	MS0000-MS2559	-	-		
Retentive Timer	TMR0000- TMR2559	-	-		
Up-down Counter	CT000-CT511	-	-		
Up Counter	CU000-CU511	-	-		
Ring Counter	RCU000-RCU511	-	-		

Device	Bit Address	Word Address	Double Word Address	32 bit	Remarks
Timer Counter (Elapsed Value)	-	TC0000-TC2559	-	[L / H]	
Word Inner Output	WR00000- WREFFFF	WR0000- WREFFF	DR0000-DREFFE		
Data Area	WN000000- WN1FFFFFF	WN00000- WN1FFFF	DN00000- DN1FFFE		

*1 Write disable

*2 Specify as shown below.

(Example) External input unit No.1, Slot No.2, Inner Module Bit No.34

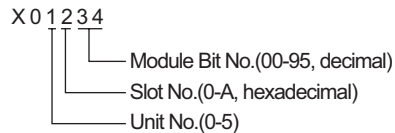

(Example) External input unit No.1, Slot No.2, Inner Module Word No.3

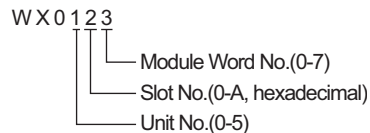

*3 Specify as shown below.

(Example) Remote External Input Remote Master No.1, Remote Slave No.2, Slot No.3, Inner Module Bit No.45

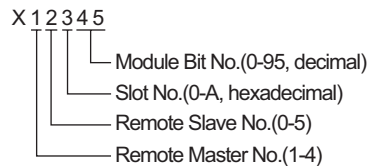

(Example) Remote External Input Remote Master No.1, Remote Slave No.2, Slot No.3, Inner Module Word No.4

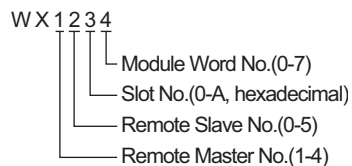

■ When using CPU Link

Set the check box of "Use CPU Link" to ON.

When using CPU Link, loop No. and unit No. are added to the address.

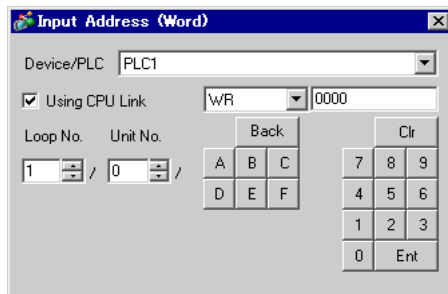

(Example) Loop No.1, Unit No.2

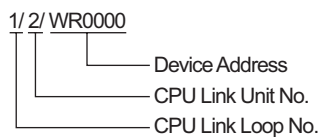

MEMO

- Please refer to the GP-Pro EX Reference Manual for system data area.
Cf. GP-Pro EX Reference Manual "Appendix 1.4 LS Area (only for direct access method)"
- Please refer to the precautions on manual notation for icons in the table.
☞ "Manual Symbols and Terminology"

6 Device Code and Address Code

Use device code and address code when you select "Device Type & Address" for the address type in data displays.

6.1 H / EH-150 Series

Device	Device Name	Device Code (HEX)	Address Code
Input Relay	X	0080	Word Address
	WX		Word Address
	DX	0020	Word Address
Output Relay	Y	0081	Word Address
	WY		Word Address
	DY	0021	Word Address
Data Area	M	0082	Word Address
	WM		Word Address
	DM	0022	Word Address
CPU Link	L	0083	Word Address
	WL		Word Address
	DL	0023	Word Address
Timer Counter (Elapsed Value)	TC	0060	Word Address
Word Inner Output	WR	0000	Word Address
	DR	0024	Word Address
Network Link Area	WN	0001	Word Address
	DN	0025	Word Address

6.2 Web Controller Series

Device	Device Name	Device Code (HEX)	Address Code
External Input	X	0080	Word Address
	WX		Word Address
	DX	0020	Word Address
External Output	Y	0081	Word Address
	WY		Word Address
	DY	0021	Word Address
Inner Output	M	0082	Word Address
	WM		Word Address
	DM	0022	Word Address
Timer Counter (Elapsed Value)	TC	0060	Word Address
Word Inner Output Word Special Inner Output	WR	0000	Word Address
	DR	0024	Word Address

6.3 EHV Series

Device	Device Name	Device Code (HEX)	Address Code
External Input	X	0080	Word Address
	WX		Word Address
	DX	0020	Word Address
External Output	Y	0081	Word Address
	WY		Word Address
	DY	0021	Word Address
Extension External Input	EX	0084	Word Address
	WEX		Word Address
	DEX	0026	Word Address
Extension External Output	EY	0085	Word Address
	WEY		Word Address
	DEY	0027	Word Address
Data Area	M	0082	Word Address
	WM		Word Address
	DM	0022	Word Address
CPU Link	L	0083	Word Address
	WL		Word Address
	DL	0023	Word Address
Word Inner Output	WR	0000	Word Address
	DR	0024	Word Address
Data Area	WN	0001	Word Address
	DN	0025	Word Address
Timer Counter (Elapsed Value)	TC	0060	Word Address

7 Error Messages

Error messages are displayed on the screen of the Display as follows: "No. :Device Name:Error Message(Error Occurrence Area)". Each description is shown below.

Item	Requirements
No.	Error No.
Device Name	Name of the External Device where error occurs. Device name is a title of the External Device set with GP-Pro EX.(Initial value[PLC1])
Error Message	Displays messages related to the error which occurs.
Error Occurrence Area	Displays IP address or device address of the External Device where error occurs, or error codes received from the External Device. <div style="border: 1px solid black; padding: 2px; display: inline-block; margin-top: 5px;">MEMO</div> <ul style="list-style-type: none"> IP address is displayed such as "IP address(Decimal): MAC address(Hex)". Device address is displayed such as "Address: Device address". Received error codes are displayed such as "[Hex, Hex]".

Display Examples of Error Messages

"RHAA035: PLC1: Error has been responded for device write command (Error Code: [02H,02H])"

MEMO

- Please refer to the manual of the External Device for more detail of received error codes.

■ Driver-Specific Error Codes

Error codes are sent as separated 2 bytes codes

Example:

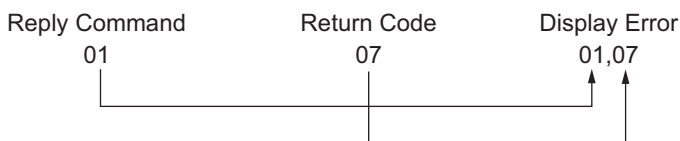

Error Code	Description
01,05	The requested number of points is beyond the designated range.
01,06	Designated device does not exist.
01,07	Designated device address is beyond the range.

MEMO

- Please refer to the manual of the External Device for more detail of received error codes.

