

APL-SM3000
Software Mirroring Utility

Reference Manual

Preface

Thank you for purchasing Pro-face's APL-SM3000 Software Mirroring Utility, hereafter referred to as the "APL-SM3000".

Prior to using the APL-SM3000, please be sure to read this manual thoroughly to understand the correct and safe usage of this product and its features.

<Note>

- (1) It is forbidden to copy the contents of this manual, in whole or in part, except for the user's personal use, without the express permission of Digital Electronics Corporation of Japan.
- (2) The information provided in this manual is subject to change without notice.
- (3) This manual has been written with care and attention to detail; however, should you find any errors or omissions, please contact Digital Electronics Corporation and inform us of your findings.
- (4) Digital Electronics Corporation shall not be held responsible for any damages, losses or third-party damages resulting from the use of this product.

All Company/Manufacturer names used in this manual are the registered trademarks of those companies.

© Copyright 2007 Digital Electronics Corporation. All rights reserved.

TRADEMARK RIGHTS



The company names and product names used in this manual are the trade names, trademarks (including registered trademarks), and service marks of their respective companies. This product omits individual descriptions of each of these rights.

Trademark / Tradename	Right Holder
Microsoft, Windows	Microsoft, U.S.
Pro-face	Digital Electronics Corporation (in Japan and other countries)

Documentation Conventions



■ Safety Icons

The list below describes the documentation conventions used in this manual.

 WARNING	Indicates situations where severe bodily injury, death or major equipment damage can occur.
 IMPORTANT	Indicates important information or procedures that must be followed to prevent Software Mirroring operation or data-related problems.

■ Information Symbols

This manual uses the following icons:

 NOTE	Contains additional or useful information.
*	Indicates useful or important supplemental information.
	Indicates pages containing related information.

Package Contents

The Software Mirroring unit's package contains the items listed below. Please check to confirm that all items shown below have been included.

CD-ROM (1)



Software Mirroring Installation Guide (1)

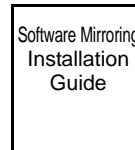

This unit has been carefully packed with special attention to quality. However, should you find anything damaged or missing, please contact your local distributor immediately.

Usage Environment

In order to use the Software Mirroring Utility, two hard disk drive units are required. It is also possible to use a preinstalled hard disk as the Boot HDD (main).

Supported Model

- PL3000 Series

Supported HDD and OS

	APL3000-HD60	APL3000-HD250
Windows 2000 [®] Professional Service Pack 4	○	X
Windows XP [®] Professional Service Pack 2 ^{*1}	○	○

*1 Including Digital Windows[®] XP Embedded

IMPORTANT

- To use the Software Mirroring Utility, please use two Hard Disk units with the same capacity.
- It doesn't support a Dynamic Disk feature of Windows[®] 2000/Windows[®] XP.
- The Software Mirroring Utility does not support SSD units.

Table of Contents

Preface.....	1
TRADEMARK RIGHTS.....	2
Documentation Conventions.....	2
Package Contents.....	3
Usage Environment	3
Table of Contents.....	4

Chapter 1 Software Mirroring Disk Utility

1.1 Software Mirroring Disk Utility Features.....	1-2
1.2 Software Design.....	1-3
1.3 CD-ROM Contents.....	1-4

Chapter 2 Mirroring Disk Setup

2.1 Boot HDD Preparation	2-2
2.2 Software Mirroring Utility Installation.....	2-3
2.3 Software Mirroring HDD Preparation	2-14
2.4 Software Mirroring Disk Configuration	2-15

Chapter 3 Software Mirroring Disk Operation

3.1 Software Mirroring Disk Operation.....	3-2
3.2 Error Messages.....	3-7
3.3 Restrictions	3-9

1 **Software Mirroring Disk Utility**

1.1	Software Mirroring Disk Utility Features	1-2
1.2	Software Design	1-3
1.3	CD-ROM Contents	1-4

1.1 Software Mirroring Disk Utility Features

The APL-SM3000 Software Mirroring Utility uses RAID1 as the hard disk management technology.

RAID (Redundant Array of Independent Disks) is a multiple hard disk management system that allows high speed access and redundancy of user data to increase user system reliability and protect from data loss in the case of a hard disk failure.

Five levels of RAID are available - RAID0, RAID1, RAID3, RAID4, and RAID5, as well as combinations, such as RAID0+1.

RAID1, which is used in the system, uses two HDD units and saves the same data simultaneously to both HDD units. This provides a high level of system reliability.

However, since this system considers both HDD drives to be a single unit, the data capacity of the system is equal to only one of the drives. For example, if both drives are 60GB drives, the total system capacity is 60GB, not 120GB.

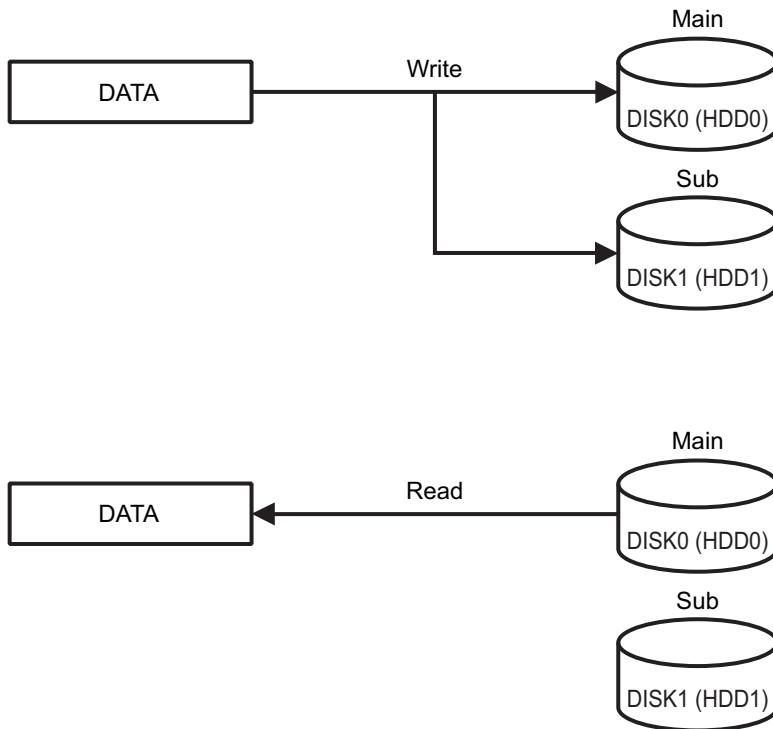
**NOTE**

- The write is performed to both main and sub disks, but the read is done from the main disk only.

Pro-face's Software Mirroring Utility and hard disks support hot swapping. When one of the HDDs becomes faulty, it can be replaced with a new HDD while the other is operating.

1.2 Software Design

To use the Software Mirroring Utility, the following software is available.

- **Software Mirroring Disk Driver**
Your PL or PS-B unit's system (OS) requires that, in order to write data to both drives (same size), and to detect HDD errors that occur during the data write process, this utility reports those errors to the Mirroring Disk Utility.
- **Software Mirroring Disk Utility**
This program monitors the condition of the Mirroring Disk Driver, and reports errors to the user. This utility also includes the feature of combining two (same size) HDD units into a single Mirroring disk.

1.3 CD-ROM Contents

The Software Mirroring unit's CD-ROM data is organized as follows.

APL-SM3000 CD-ROM

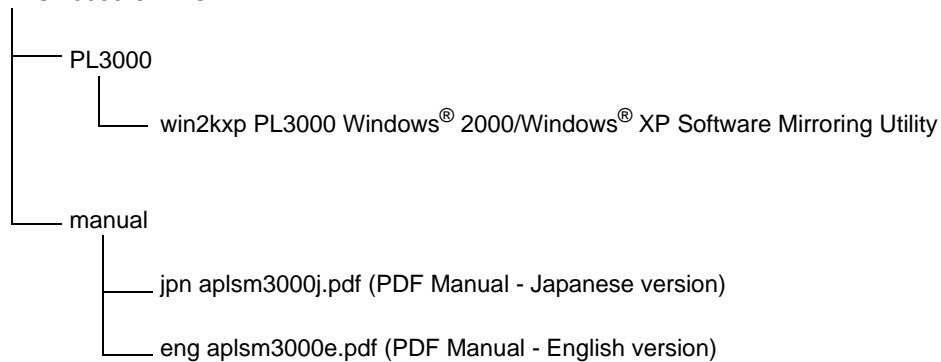

2 | Mirroring Disk Setup

2.1	Boot HDD Preparation	2-2
2.2	Software Mirroring Utility Installation.....	2-3
2.3	Software Mirroring HDD Preparation	2-14
2.4	Software Mirroring Disk Configuration	2-15

2.1 Boot HDD Preparation



To prevent an electrical shock, prior to installing the HDD units in the PL, be sure the PL unit's power cord is disconnected and the main power supply is turned OFF.

Install a Boot HDD as DISK0 (HDD0).

The Boot HDD must be installed as DISK0 (HDD0).

When the Boot HDD becomes faulty and is removed, the HDD installed as DISK1 (HDD1) automatically assumes the role of the Boot HDD.

When a normal HDD is installed as DISK0 (HDD0), it is recognized automatically as the Boot HDD again.

 PL3000 Series Hardware Manual

Set up the OS.

When a model with the OS preinstalled is used, this procedure is not required.

When a non-OS model is used, refer to the following instructions.

 PL3000 Series Reference Manual

2.2 Software Mirroring Utility Installation

Install the Software Mirroring Disk Utility in the Boot HDD.

IMPORTANT

- If you use a version earlier than Windows[®] 2000 SP4 or Windows[®] XP SP2, there is a possibility that Windows will fail to boot. Be sure to use SP4 or higher for Windows[®] 2000 and SP2 or higher for Windows[®] XP.
 - To install the Software Mirroring Disk Utility, System Monitor must be installed in advance. When a PL with the OS preinstalled is used, System Monitor is factory installed. When a non-OS type PL is used, download and install the System Monitor utility from the “Otasuke Pro!” support site.
-

■ When Windows 2000 is used

- 1 Execute setup.exe in [PL3000]-[win2kxp] from the CD-ROM and follow the instructions on the screen to install the Software Mirroring Disk Utility.
- 2 After installation is finished, select [Control Panel] - [System] - [Hardware] to open [Device Manager]. Under [IDE ATA/ATAPI controllers], double-click [Intel® 82801GBM SATA AHCI Controller].

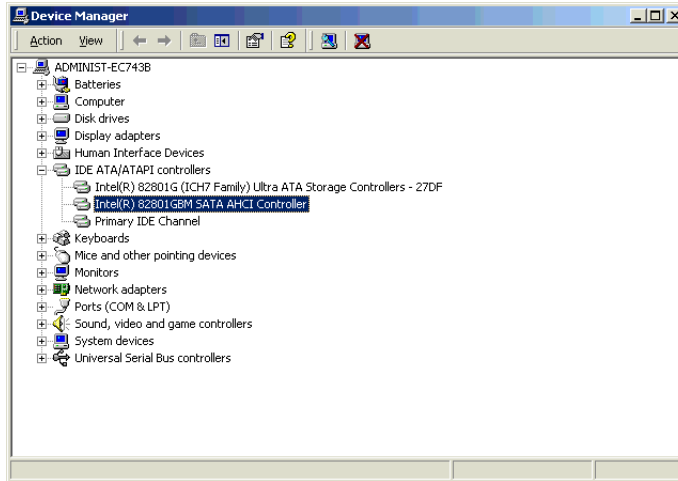

- 3 When the driver's properties dialog box opens, select the [Driver] tab and click the [Update Driver] button.

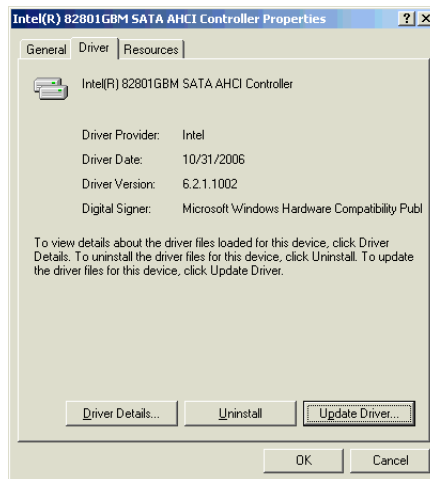

4 When the hardware update wizard starts, click [Next].



5 Select [Display a list of the known drivers for this device so that I can choose a specific driver], and then click [Next].

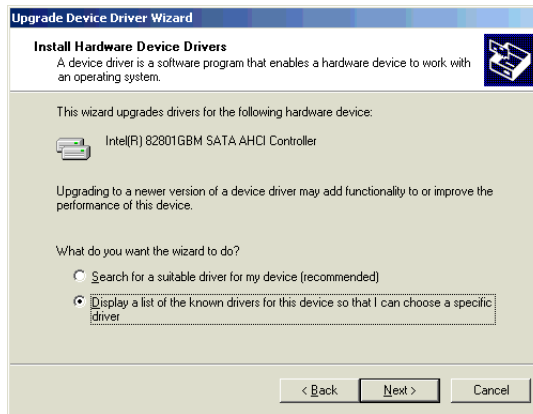

6 Click the [Have Disk] button.

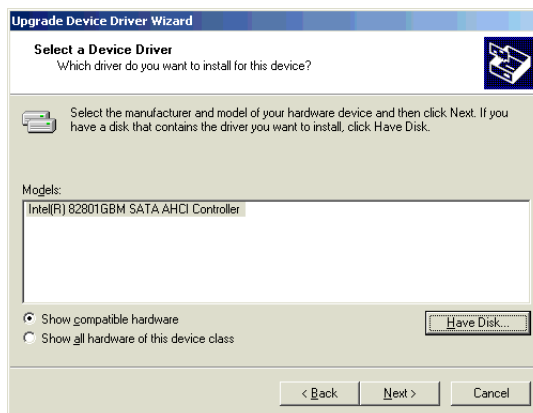

7 When the file specification dialog box appears, select “C:\Proface\SM3000\Driver” and click [OK].

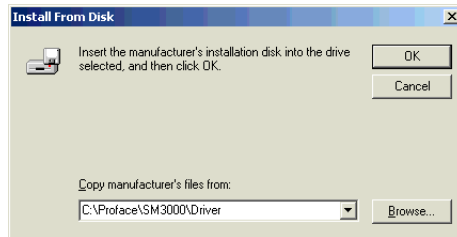

8 Confirm that SoftMirror SATA AHCI Driver is selected, and then click [Next].

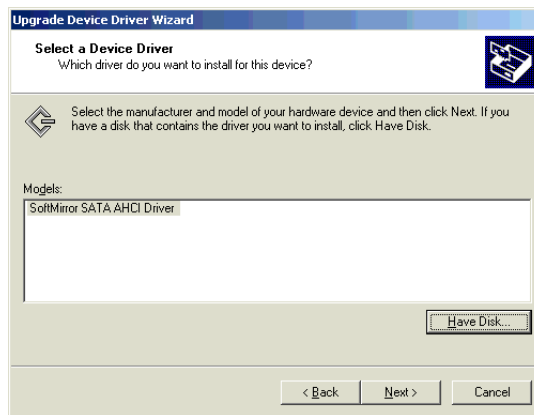

NOTE

- If you cannot find the file, install the utility first.

9 A confirmation screen appears during the driver installation. Click [Yes].



- 10 Click the [Finish] button, close the Device Manager, and restart the PL unit. After restarting, the System Settings Change dialog box will appear. After this dialog box appears, restart the PL again.



NOTE

- Because the Software Mirroring Disk is not configured just after installation, a System Monitor error message is displayed. After installing the Software Mirroring Utility, configure the Software Mirroring Disk. For details regarding Software Mirroring Disk configuration, refer to the following.
☞ “2.4 Software Mirroring Disk Configuration” (page 2-15)

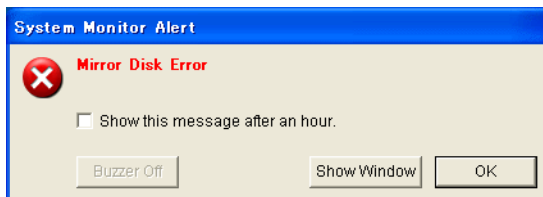

■ Uninstallation

To uninstall the Software Mirroring Disk Utility, follow the steps below:

- 1 Remove [PL-SM3000 SoftMirror Utility] from [Add or Remove Program].
- 2 Open [Device Manager] and double-click [SoftMirror STAT AHCI Driver] under [SCSI and RAID Controllers] with PL turned on.

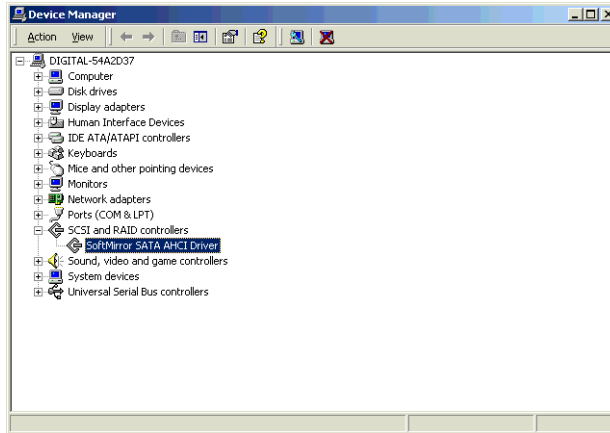

- 3 When the driver's properties dialog box opens, select the [Driver] tab and click the [Update Driver] button.
- 4 When the hardware update wizard starts, select [No, not this time] and click [Next].
- 5 Select [Install from a list or specific location] and click [Next]
- 6 Select [Don't search, I will choose the driver to install.] and click [Next]
- 7 Select [Intel® 82801 GBM SATA AHCI Controller] from the list of the model.

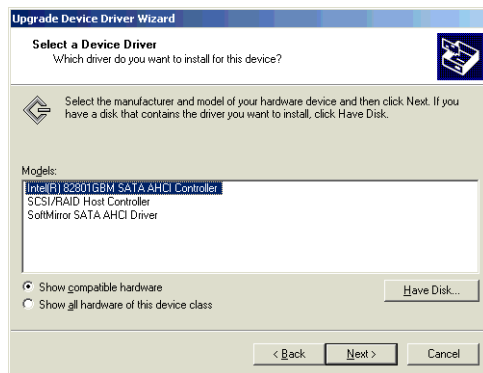

- 8 Click the [Finish] button, close the Device Manager, and restart the PL unit. This completes the installation.

■ When Windows XP is used

- 1 Execute setup.exe in [PL3000]-[win2kxp] from the CD-ROM and follow the instructions on the screen to install the Software Mirroring Disk Utility.
- 2 After installation is finished, select [Control Panel] - [Performance and Maintenance] - [System] - [Hardware], and open [Device Manager]. Under [IDE ATA/ATAPI controllers], double-click [Intel® 82801GBM SATA AHCI Controller] or [Intel® ICH7M/MDH SATA AHCI Controller].

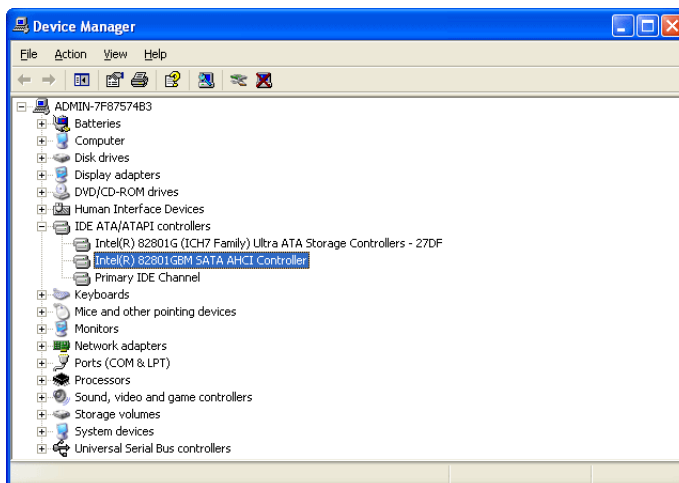

- 3 When the driver's properties dialog box opens, select the [Driver] tab and click the [Update Driver] button.

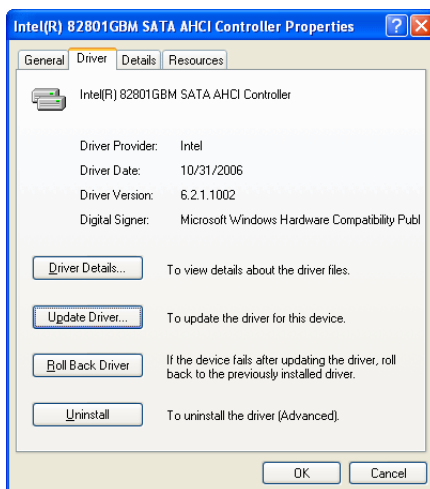

4 When the hardware update wizard starts, select [No, not this time] and click [Next].



5 Select [Install from a list or specific location] and click [Next].

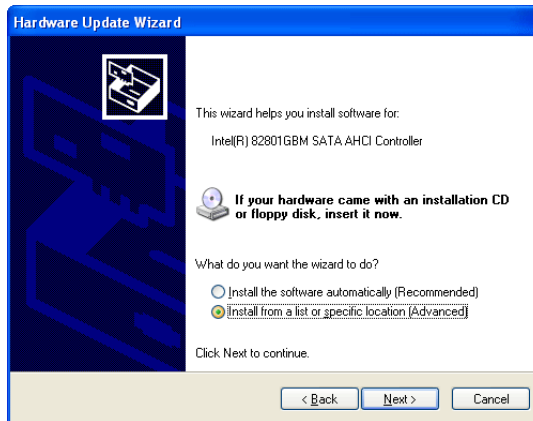

6 Select [Don't search, I will choose the driver to install.] and click [Next].

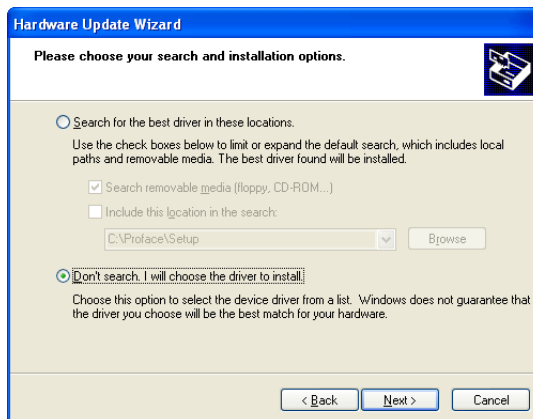

7 Click the [Have Disk] button.

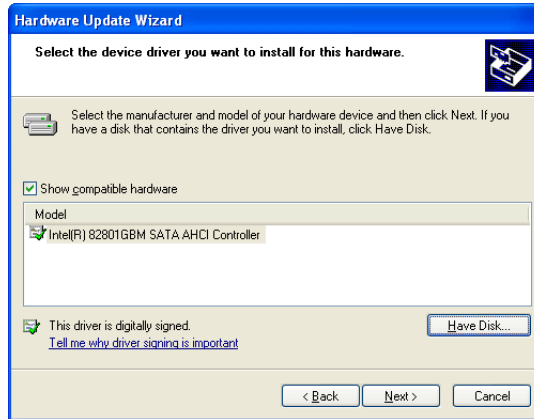

8 When the file specification dialog box appears, select “C:\Proface\SM3000\Driver” and click [OK].

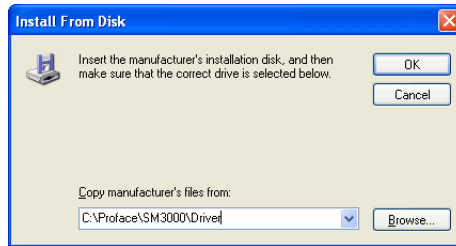

9 Confirm that SoftMirror SATA AHCI Driver is selected, and then click [Next].

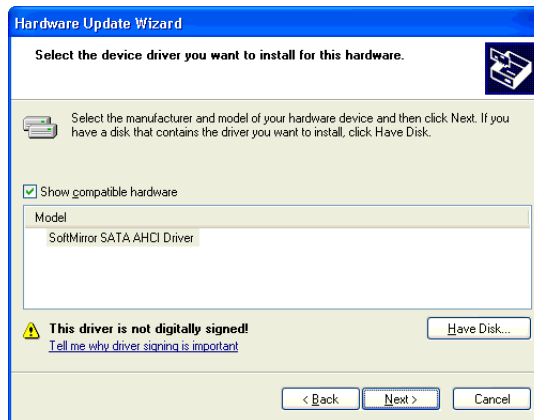

NOTE

- If you cannot find the file, install the utility first.

10 A confirmation screen appears during the driver installation. Click [Continue Anyway].



11 Click the [Finish] button, close the Device Manager, and restart the PL unit. This completes the installation.

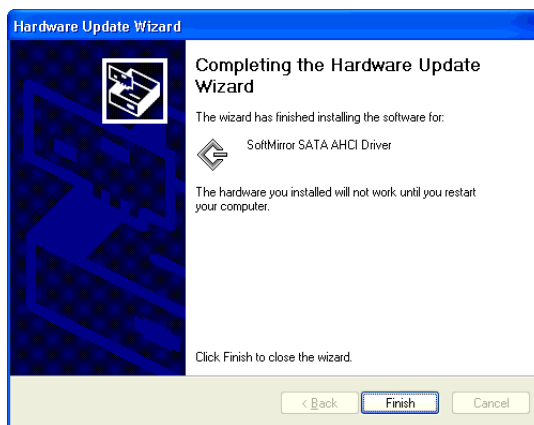

NOTE

- Because the Software Mirroring Disk is not configured just after installation, a System Monitor error message is displayed. After installing the Software Mirroring Utility, configure the Software Mirroring Disk. For details regarding Software Mirroring Disk configuration, refer to the following.
☞ "2.4 Software Mirroring Disk Configuration" (page 2-15)

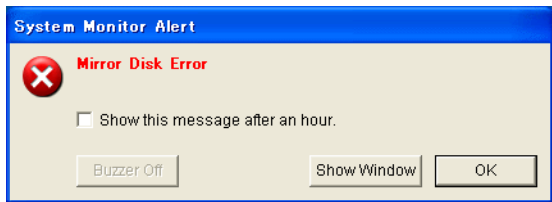

■ Uninstallation

To uninstall the Software Mirroring Disk Utility, follow the steps below:

- 1 Remove [PL-SM3000 SoftMirror Utility] from [Add or Remove Program].
- 2 Open [Device Manager] and double-click [SoftMirror SATA AHCI Driver] under [SCSI and RAID Controllers] with PL turned on.

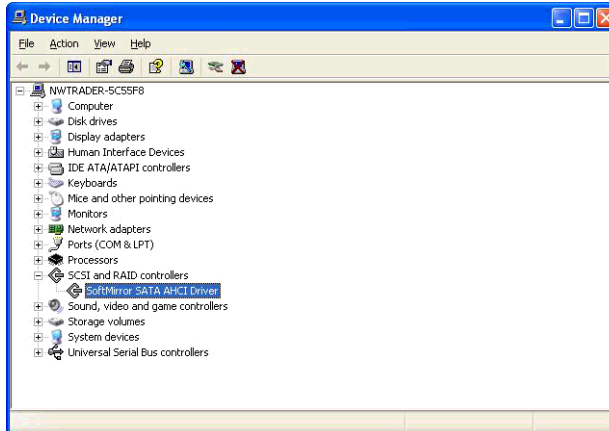

- 3 When the driver's properties dialog box opens, select the [Driver] tab and click the [Update Driver] button.
- 4 When the hardware update wizard starts, select [No, not this time] and click [Next].
- 5 Select [Install from a list or specific location] and click [Next]
- 6 Select [Don't search, I will choose the driver to install.] and click [Next]
- 7 Select [Intel® 82801 GBM SATA AHCI Controller] from the list of the model. When [Intel® ICH7M/MDH SATA AHCI Controller] is not listed, download and install the AHCI Driver (for update) from the "Otasuke Pro!" support site.

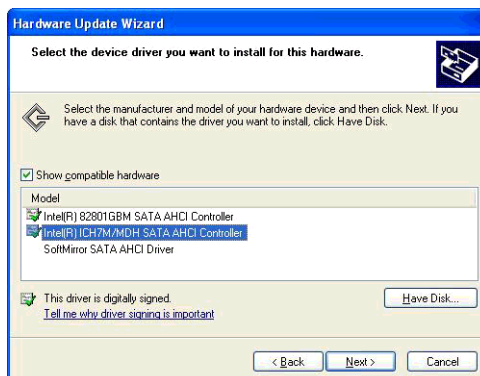

- 8 Click the [Finish] button, close the Device Manager, and restart the PL unit. This completes the installation.

2.3 Software Mirroring HDD Preparation

■ Install the Mirroring HDD as DISK1 (HDD1).

IMPORTANT

- The Mirroring HDD must be installed as DISK1 (HDD1).
☞ PL3000 Series Hardware Manual

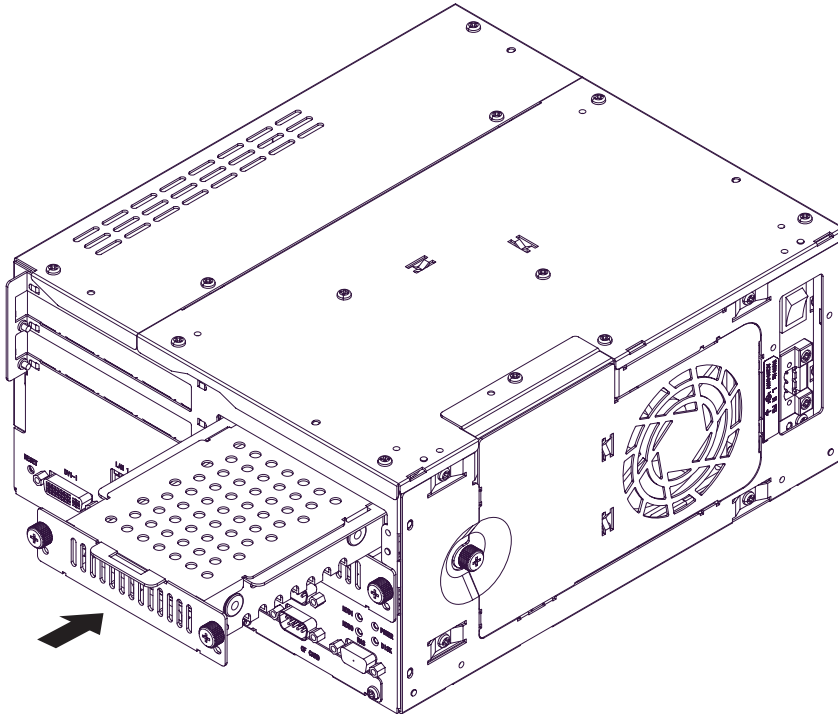

2.4 Software Mirroring Disk Configuration

1 Double-click the System Monitor icon in the task tray, to display the System Monitor screen.



2 In the System Monitor screen, click the [Rebuild] button. This starts copying the contents of the first HDD to the second HDD.

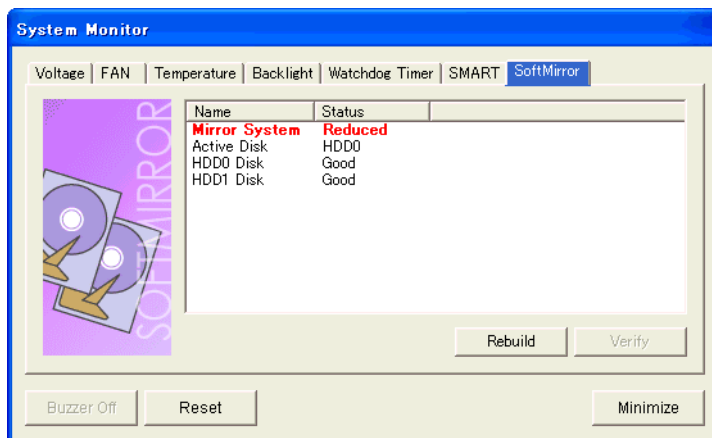

Time to reconstruct the mirrored disk depends on the HDD and operating environment.

For more information, please refer to Pro-face's "Otasuke Pro!" support site.

☞ <http://www.pro-face.com/otasuke/>

During the rebuild process a progress bar appears at the bottom of the window to show the progress.

If desired, the HDD can be accessed during the rebuild process.

- When the rebuild process is finished, the status of [Mirror System] changes to [Good] and the Mirroring Disk feature will begin to operate. Click the [Reset] button to clear the SoftMirror errors.

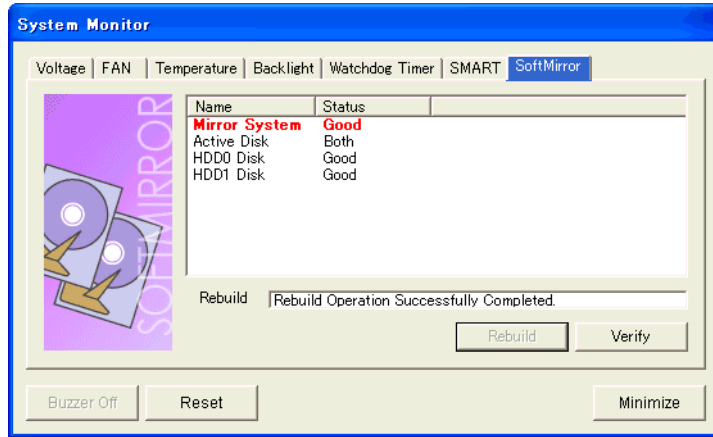

- To set the system to automatically report error occurrences, select [Control Panel]-[System Monitor Property] to display the [System Monitor Property] screen. To enable the error notification action, select the [SoftMirror] tab and check the error actions that you want to set.

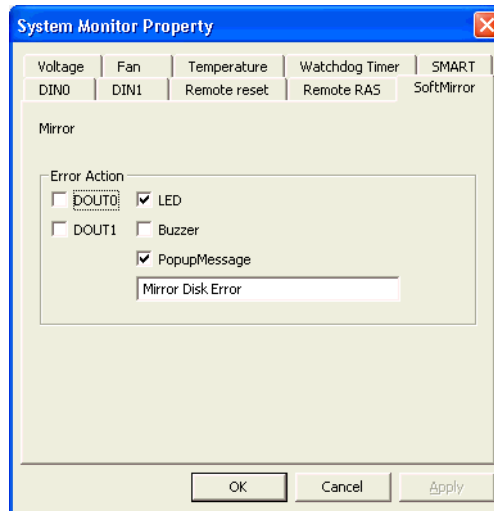

■ Using the Mirroring Disk Feature

After the rebuilding process of the Software Mirroring Disk is finished, the Mirroring Disk feature will automatically become available unless there are drive errors.

3 | **Software Mirroring Disk Operation**

3.1	Software Mirroring Disk Operation	3-2
3.2	Error Messages.....	3-7
3.3	Restrictions	3-9

3.1 Software Mirroring Disk Operation

After the Mirroring Disk is rebuilt, mirroring will be performed continually unless the drives have any errors.

When the [System Monitor] icon is double-clicked on the task tray, the System Monitor window appears. The status of the Software Mirroring Disk, DISK0 (HDD0), and DISK1 (HDD1) can be checked in this window.

IMPORTANT

- Do not perform the following operations. Performing them could damage the Software Mirroring Disk.
 - Do not replace the HDD with the HDD that was configured for software mirroring using another panel computer.
 - Do not use a non-Windows operating system to run the PL or to write data to the HDD unit.
 - After configuring the Mirroring Disk, do not change the previously specified Boot Drive settings.
 - Do not turn OFF the power of the PL while the HDD is being accessed.

■ Drive Condition Detailed Information

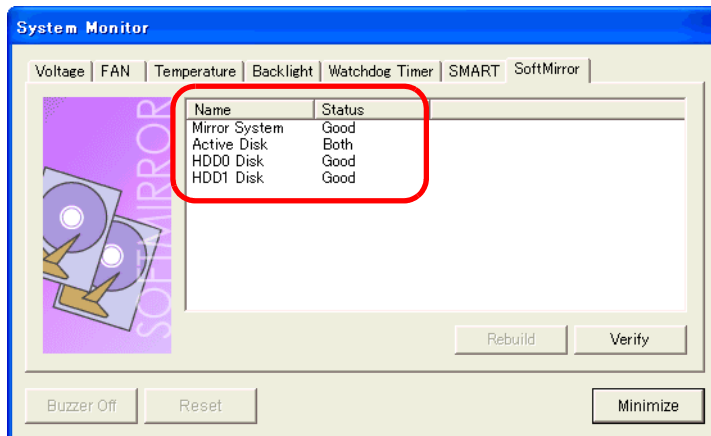

◆ Mirror Status

This menu provides the current status of the Mirroring Disk operation. The status will be any of “Rebuild”, “Good”, “Reduced”, or “Dead”.

Rebuild	The Mirroring Disk unit is now being rebuilt.
Good	Indicates Mirroring is being performed normally.
Reduced	During “Good” operation, indicates that an error has occurred in one of the HDD units and that only one is operating. After confirming which disk is not operating, change the unit for a new one as soon as possible.
Dead	During “Reduced” operation, indicates that an error has occurred. If operation continues, there is the possibility that the PL unit’s OS (system) can stop operating. Therefore, it is strongly recommended that you backup your current PL data and replace the non-operating HDD unit as soon as possible.

When Windows is restarted or shutdown, disk status information is destroyed. This may prevent the Hard Disk Mirroring utility from being able to identify which HDD is damaged. In this case, use the [Event Viewer] to check which HDD is damaged.

☞ “3.2 Error Messages” (page 3-7)

NOTE

- Select [Start] - [Program] - [System Monitor] to open the System Monitor Property screen. On the [Smart] tab, enable the SMART monitoring, and the SMART monitoring (self-monitoring of hardware) will be applied to each HDD.

☞ PL3000 Series Reference Manual

◆ Active Disk

This item displays which HDD is in current operation. The HDD displayed in this item can be “HDD0”, “HDD1” or “Both”.

HDD0	Only DISK0 (HDD0) is operating.
HDD1	Only DISK1 (HDD1) is operating.
Both	Both DISK0(HDD0) and DISK1(HDD1) are operating.

◆ DISK0 (HDD0)/DISK1 (HDD1) Status

These items display the condition of the HDD units connected to the PL. HDD conditions can be “No Device”, “Good” or “Broken”.

No Device	Indicates that no device is connected.
Good	Indicates normal disk unit operation.
Broken	Indicates a disk error has occurred.

■ Software Mirroring Disk Operation Flow

The Software Mirroring Disk operation cycle, from installation to error handling, is as follows.

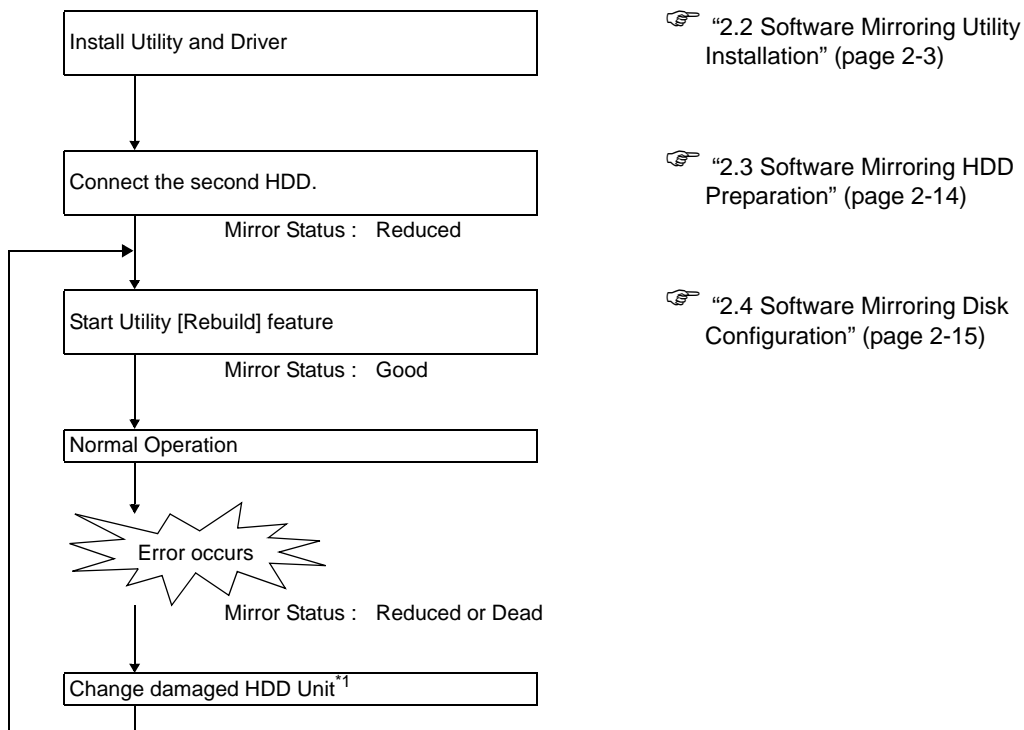

*1 Do not change the Boot HDD settings.

NOTE

- You can replace only the faulty HDD while the normal HDD is operating.

■ **Cautions for the “Reduced” operation**

When an error occurs in a single HDD unit, and its status becomes “Reduced”, as soon as possible, change the drive for a new one and configure it.

You can replace only the faulty HDD while the active HDD is operating.

If both HDD units have errors and the system is still operating, save all important data to a separate, external media.

Then, replace both HDD units.

■ **Replacing the HDD**

- 1 If an error occurs, an error message dialog is displayed. Click the [Show Window] button in the dialog or double-click the System Monitor icon in the task tray. The System Monitor screen will appear.

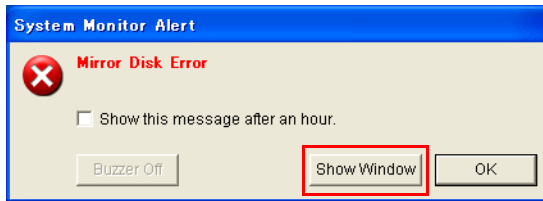

NOTE

- To set the system to automatically display error occurrences, it is necessary to set the error notification action on the [System Monitor Property] screen.
 ☞ “2.4 Software Mirroring Disk Configuration” (page 2-15)

- 2 Select the [Soft Mirror] tab to check which HDD is damaged.

The damaged HDD is displayed as "Broken". In addition, the LED for the damaged HDD illuminates in orange.

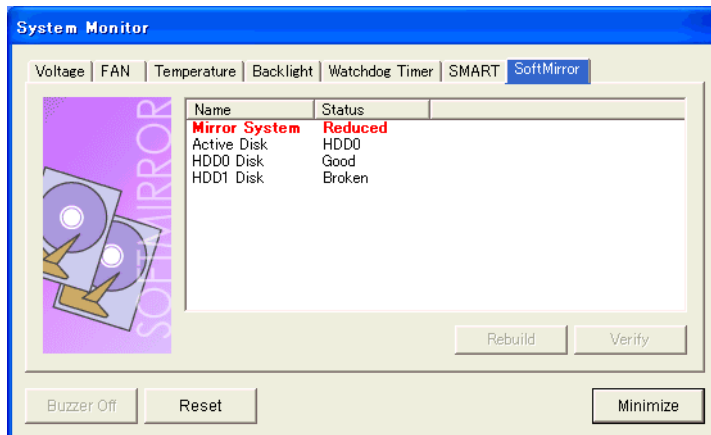

3 Remove the damaged HDD.

4 After the HDD is removed, the LED for the HDD goes out and the display of System Monitor is changed to “No Device”.

NOTE

- Do not use the removed HDD. Even if the HDD is installed again, it cannot be used because it is recognized as broken.

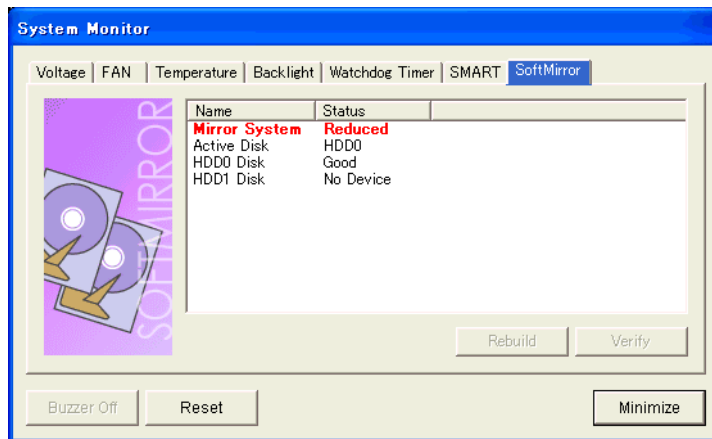

5 Install a new HDD.

👉 PL3000 Series Hardware Manual

6 Set up the Mirroring Disk.

👉 “2.4 Software Mirroring Disk Configuration” (page 2-15)

3.2 Error Messages

■ LED

If the Software Mirroring Disk error is detected during RAS System Monitor operation, the LED indicator will illuminate in orange.

■ Event Log

Whenever Software Mirroring Disk features are changed, or a device error is detected, the driver will write data to an Event Log.

The events output by the Software Mirroring Disk Driver will be written to the Event Log's System Log.

Event Log data can be viewed using the Event Viewer or the Soft Mirror Log Viewer.

■ Event Log Details Display in the Event Viewer

◆ How to start the Event Viewer

Start [Event Viewer] from [Control Tools] in [Control Panel]. The System log is displayed.

◆ Display in the Event Viewer

The Event Log details will appear as follows.

Event ID : 11

Source : smsata

Type : Error

Category : None

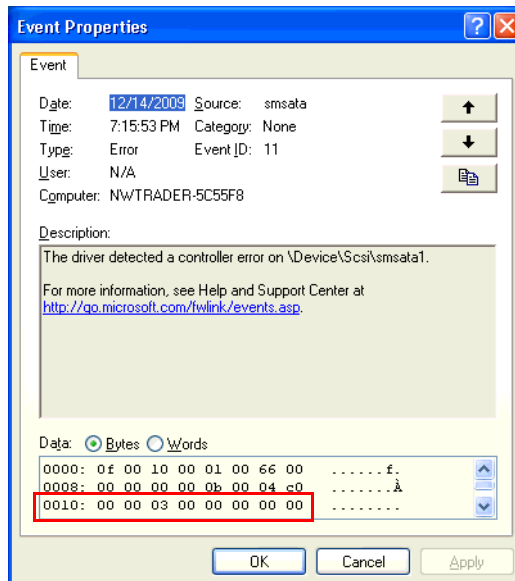

NOTE

- Refer to the following page for the procedure to display the Event Viewer.
 “ ■ Event Log Details Display in the Soft Mirror Log Viewer” (page 3-8)

The previous page's picture shows the code data output by the Software Mirroring Disk Driver during Event Log creation. This data can be seen in the above rectangle, which frames the four (4) bytes of data following “0010h”. Depending on the code data output, you can diagnose if the problem is due to a Mirroring Disk condition change or a device error.

■ Event Log Details Display in the Soft Mirror Log Viewer

◆ How to start the Soft Mirror Log Viewer

[Start] -> [Program] -> [Soft Mirror Disk Utility] -> [Soft Mirror Log Viewer] will start the Soft Mirror Log Viewer.

◆ Display in the Soft Mirror Log Viewer

The Event Log details will appear as follows.

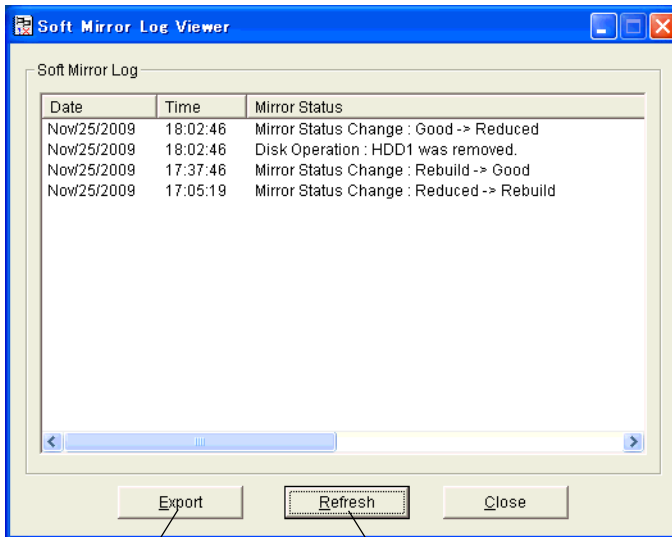

Outputs the Event Log contents to a CSV file.

Acquires the latest Event Log information.

[Soft Mirror Log viewer] displays only the Event Log information which belongs to “Software Mirroring Utility”. Click on the [Refresh] button, and the latest Event Log information can be viewed on [Soft Mirror Log viewer]. (it won’t be automatically renewed.)

LED display status

The LED display status of each HDD changes depending on the status of the corresponding HDD.

Disk status	LED	Remarks
No HDD	Not lit	
HDD is normal	Green (lit)	
HDD is damaged	Orange (lit)	
Copy destination HDD during rebuilding	Green/Orange (blinking)	Copy source HDD (active disk): Green (lit)

3.3 Restrictions

- To use the Software Mirroring Utility, please use two Hard Disk units with the same capacity.
- The APL-SM3000 does not support the dynamic disk of Windows® 2000/Windows® XP.
- Data transfer mode only operates in DMA mode.
- To extend the operating life of the PL unit's HDD, Pro-face recommends you use one of the following procedures to turn the HDD OFF when the unit is not being operated.
 - Set the Windows [Control Panel] - [Power Options] - [Power Schemes] tab's [Turn off hard disks:] selection. Pro-face recommends a setting of [After 5 mins].
- Do not use a HDD which has previously failed.
- Do not use a HDD which was used for another device.
- Do not interchange DISK0 (HDD0) and DISK1 (HDD1).
- Do not remove the HDD while the Mirroring Disk status is "Good" or "Rebuild".
- After an HDD is removed, wait at least three seconds before installing it again.
- After removing an HDD for which rebuilding is canceled, do not use it again.

