

# PL-7920 Series Installation Guide



## WARNINGS

- To prevent an electric shock, be sure to disconnect the power cord to the PL before connecting it to the main power supply.
- A fire or electrical shock may occur if voltages used with the PL are beyond the specified range. Be sure to use only the specified voltage.
- Before opening the PL's protective cover, be sure to turn the unit's power OFF. This is because the PL's internal parts carry high voltages.
- To avoid fires or electrical hazards, do not modify the PL in any way.
- Do not create touch panel switches that are used to either control or to ensure the safety of equipment and personnel. Mechanical switches, such as an emergency stop switch, a deadman (two-handed) start switch, etc., must be installed and operated via a separate control system.
- Do not create touch panel switches which could possibly endanger the safety of humans or equipment. This is due to the possibility of a malfunction in the PL or its cable(s) causing the output of a signal that could result in a major accident. All of a system's major, safety-related switches should be designed to be operated separately from the PL.
- After the PL's backlight burns out, unlike the PL's "Standby Mode", the touch panel is still active. If the operator fails to notice that the backlight is burned out and touches the panel, a potentially dangerous machine miss-operation can occur.  
If your PL's backlight suddenly turns OFF, use the following steps to determine if the backlight is actually burned out.
  - 1) If your PL is not set to "Standby Mode" and the screen has gone blank, your backlight is burned out.
  - 2) Or, if your PL is set to Standby Mode, but touching the screen does not cause the display to reappear, your backlight is burned out.
- If metal particles, water or other types of liquids contact any of the PL's internal parts, immediately turn the unit's power OFF, unplug the power cord, and contact either your PL distributor or the Digital Electronics Corporation.
- Before either plugging in or unplugging a board or interface connector, be sure to turn the PL's power OFF.
- To prevent a possible explosion, do not install the PL in areas containing flammable gases.
- The PL is not appropriate for use with aircraft control devices, aerospace equipment, central trunk data transmission (communication) devices, nuclear power control devices, or medical life support equipment, due to these devices' inherent requirements of extremely high levels of safety and reliability.
- When using the PL with transportation vehicles (trains, cars and ships), disaster and crime prevention devices, various types of safety equipment, non-life support related medical devices, etc. redundant and/or fail-safe system designs should be used to ensure the proper degree of reliability and safety.

### To Prevent Accidents

- Do not push on the PL's screen too strongly, with either your finger or with a hard object. Excessive pressure can scratch, crack or damage the screen. Do not use a pointed object, such as a mechanical pencil or screwdriver, to press any of the touch panel's switches, since they can damage the display.
- If the screen becomes dirty or smudged, moisten a soft cloth with diluted neutral detergent, wring the cloth well, and wipe the display. Do not use thinner or organic solvents.
- Avoid storing and operating the PL in direct sunlight, high temperatures and humidity, and in areas where excessive dust and vibration will occur.
- Avoid using the PL in areas where sudden, extreme changes in temperature can occur. This may cause condensation to form inside the unit, possibly leading to an accident.
- To prevent the PL from overheating, be sure its air circulation vents are clear and clean, and keep the unit's operation area well-ventilated.
- Avoid operating or storing the PL near chemicals, or where chemicals can come into contact with the unit.
- The Digital Electronics Corporation shall not be held responsible or provide any compensation for damage(s) caused by the loss of data stored in the PL's hard disk drive (HDD). It is therefore strongly suggested that all important data and software be backed up regularly to an external data backup device.
- After turning OFF the PL's power, wait until the internal HDD stops spinning before turning on the power again (approx. 5 seconds).

# UL/c-UL (CSA) Application Notes

The PL792\*-T4\* is a UL/c-UL 1950 recognized component (UL File No. E171486). Please pay special attention to the following instructions when applying for UL/c-UL approval for machinery which includes any of these PL units.

**The PL conforms as a component to the following standards:**

UL 1950, Third Edition, dated March 1,1998 (Standard for Safety of Information Technology Equipment, including Electrical Business Equipment)

CSA-C22.2 No. 950-95 (Standard for Safety of Information Technology Equipment, including Electrical Business Equipment)

**PL7920-T4\* (UL Registration Model No.: 2780054-02)**

**PL7921-T4\* (UL Registration Model No.: 2780054-01)**

- Equipment with a PL unit mounted in it requires UL/c-UL evaluation for the combination of the PL and equipment.
- The PL must be used as a built-in component of an end-use product.
- Use the PL indoors only.
- When connecting the PL's power cable, be sure to use a cable that is appropriate for the current and voltage used and that has conductive wires that are 0.75 mm<sup>2</sup> or larger.
- When using the PL in an end-use product, be sure to install the PL unit's power cut-off switch where the operator can easily reach it.
- Danger of explosion if backup battery is incorrectly replaced. Should be replaced only with same or equivalent type recommended by the manufacturer. Dispose of used batteries according to the manufacturer's instructions.
- Be sure the unit the PL is built into uses a UL1950 compatible structure.

## CE Marking Notes

The PL792\*-T4\* units are CE marked, EMC compliant products.

**<Complies with the following Standards>**

• **Safety**

EN60950

• **EMI**

EN55011 (Group1 Class A), EN61000-3-2, EN61000-3-3

• **EMS (EN61000-6-2)**

EN61000-4-2, EN61000-4-3, EN61000-4-4, EN61000-4-5, EN61000-4-6, EN61000-4-8, EN61000-4-11

If the following requirements are not met, the PL may fail to meet EN60950 standard requirements.

- The PL must be used as a built-in component of an end-use product.
- Use the PL indoors only.
- When connecting the PL's power cable, be sure to use a cable that is appropriate for the current and voltage used and that has conductive wires that are 0.75 mm<sup>2</sup> or larger.
- When using the PL in an end-use product, be sure to install the PL unit's power cut-off switch where the operator can easily reach it.
- There is a danger of explosion if the backup battery is incorrectly replaced. This battery should be replaced only with same or equivalent type recommended by the manufacturer. Dispose of used batteries according to the manufacturer's instructions.
- Be sure the PL unit's enclosure is an EN60950 approved sheet steel structure.

# Package Contents

The PL package should include the following items:

■ **PL Unit**

(PL-7920/PL-7921)

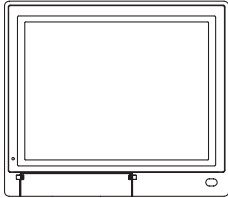

■ **Power Cord**

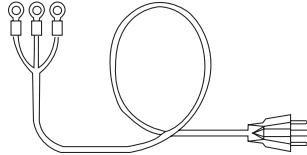

■ **Installation Brackets (12)**

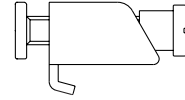

- Be careful when installing the PL not to damage the built-in HDD.
- This cord is designed only for AC100/115V use. Any other voltage will require a different cable.

■ **Installation Guide  
(Japanese and English)**

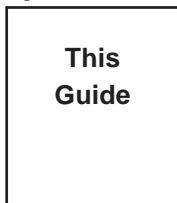

■ **CD-ROM (1)  
PL-X920 Series User  
Manual & Driver CD**



**Note:** Contains User Manual and PL-X920 Series Utility and Driver. For details, refer to the User Manual.

When you order a PL unit built to your specifications, the PL package should include all optional Items' Installation Guides. Be sure to check the contents of each optional item.

## About The PDF Manual

The CD-ROM contains the following PDF manual file.

PL-6920/PL-7920 Series User Manual

Reading a PDF file requires installation of the Adobe Corporation's Acrobat® Reader.

■ **Acrobat® Reader Installation:**

To install the Acrobat® Reader software, follow the steps given below.

- 1) This software, in the form of a self-extracting file, is located in this CD-ROM in the folder titled [Reader]. Use the Explorer software to find the file [Reader\ENG\ar505enu.exe], and double-click on the file icon to begin the Reader installation.
- 2) After Installation begins, follow the instructions given on the Installation screens.

■ **Viewing the PDF manual:**

To view the PDF manual contained in this CD-ROM, follow the steps given below.

- 1) Use the Explorer software to locate the file [manual\ENG\pl7920e.pdf] in the folder titled [manual].
- 2) Double-click on the PDF file's icon. Acrobat® Reader will automatically start and the first page of the PDF manual will appear.

# 1 PL External Features

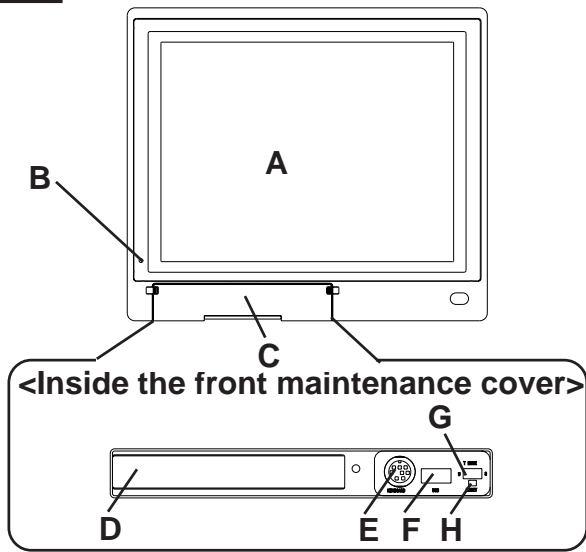

PL-7920  
(4Slot)

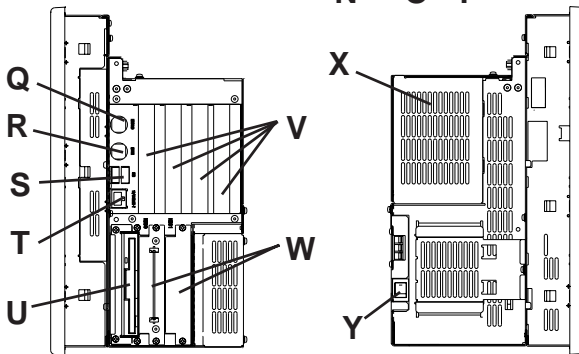
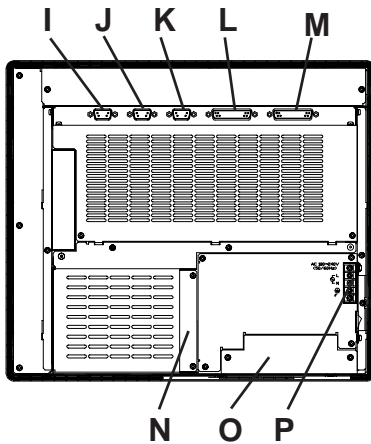

PL-7920(4Slot)

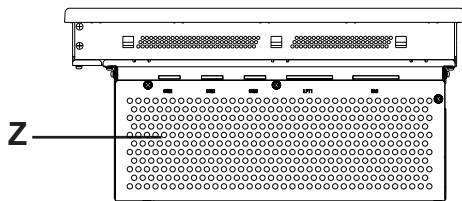

PL-7920(4Slot)

- A : Display Area/Touch Panel
- B : Power Lamp LED/RAS Status Lamp
- C : Front Maintenance Cover
- D : Front Mount FDD Slot  
(Only for PL-7920)
- E : Keyboard Connector (KEYBOARD)
- F : USB Connector (USB)
- G : Touch Panel I/F Selector Switch  
(T-MODE)
- H : Hardware Reset Switch (RESET)
- I : RS-232C Connector (COM1)
- J : RS-232C Connector (COM2)  
(Changeover RI/+5v)
- K : RS-232C Connector (COM3)  
(Changeover RI/+5v)
- L : Printer Connector (LPT1)
- M : RAS Connector
- N : IDE I/F Cover
- O : Front Mount FDD Slot  
(Only for PL-7920)
- P : Power Terminals
- Q : Keyboard Connector
- R : Mouse Connector
- S : USB Connector
- T : LAN Connector (10/100 BASE-T)
- U : Side Mount FDD Slot
- V : Expansion Slots
- W : HDD/CF Card Unit Expansion Slots
- X : Half Cover
- Y : Power Switch
- Z : Rear Maintenance Cover



- Prior to attaching peripheral units to the PL, be sure the PL's power cord is disconnected from the main power supply.
- To prevent an electrical shock, be sure to disconnect the PL's power cord from the power supply before connecting the cord's power terminals or any peripheral devices to the PL.

## 2 PL Dimensions

(Unit: mm [in.] - excluding projections)

### • PL-7920 General Dimensions

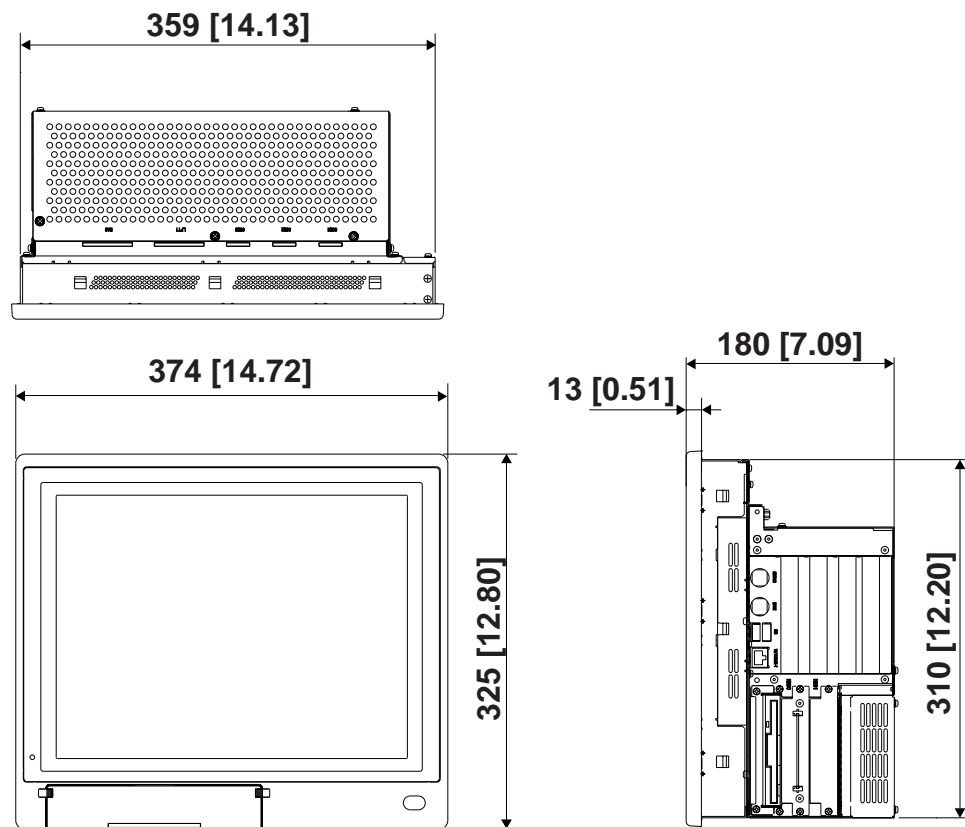

### • PL-7921 General Dimensions

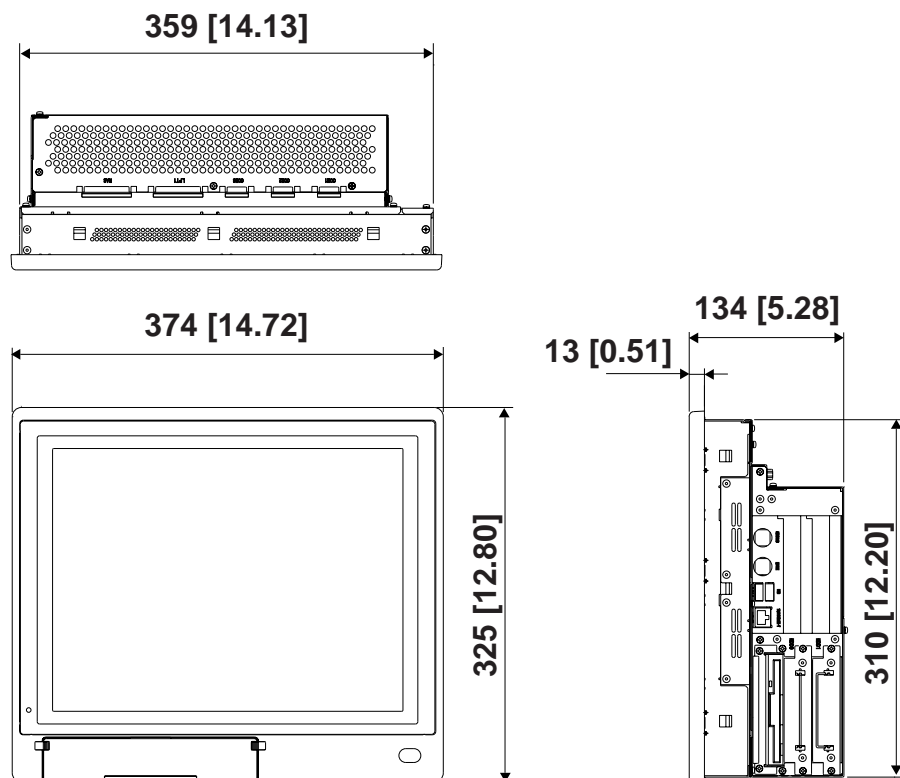

### 3 General Specifications

#### ■ Electrical

	PL-7920	PL-7921
Rated Voltage	AC 100V to AC 240V	
Rated Voltage Range	AC 85V to AC 265V	
Frequency	50/60Hz	
Allowable Voltage Interruption	shorter than 1 cycle (however, pause occurrences must be more than 1 second apart)	
Power Consumption	less than 150VA	less than 120VA
Voltage Endurance	AC 1500V at 20mA for 1 minute (between charging and FG terminals)	
Insulation Resistance	Greater than 10M $\Omega$ at DC 500V (between charging and FG terminals)	

#### ■ Environmental

Operating Temperature	PL792*-T41 (CPU:700MHz)	Cabinet Interior	W/Fan	5°C to 50°C (With HDD attached)
			W/out Fan* <sup>1</sup>	5°C to 40°C (With HDD attached)
		Panel Face	5°C to 40°C	
	PL792*-T42 (CPU:1GHz)	Cabinet Interior	W/Fan	5°C to 45°C (With HDD attached)
		W/out Fan* <sup>1</sup>	(Must use fan)	
Panel Face		5°C to 40°C		
Storage Temperature	-10 °C to 60 °C			
Humidity	10% RH to 85% RH (no condensation)			
Maximum wet bulb	29 °C			
Air Purity	Free of dust			
Pollution Level	Pollution Level 2			
Atmosphere	Free of corrosive gas			
Vibration Endurance	19.6m/s <sup>2</sup> at 10Hz to 25Hz in X, Y, Z directions for 30 minutes With HDD attached : 4.9m/s <sup>2</sup> With FDD attached : 9.8m/s <sup>2</sup>			
Noise Endurance (Impulse Noise)	Noise Voltage : 1500V (via noise simulator) Pulse Duration : 50ns, 500ns, 1 $\mu$ s Rise Time : 1ns			
Noise Immunity (First transient burst noise)	Power Line : 2kV IEC 61000-4-4 COM Port : 1kV IEC 61000-4-4			
Electrostatic Discharge	4kV IEC 61000-4-2			

\*1 When the PL's internal electric fan is removed.



- When using any of the PL's optional devices, be sure to check that device's specifications for any special conditions or cautions that may apply to its use.
- When using a full sized expansion board, be sure to check its dimensions and shape, since they will affect the board's environment specifications, such as those for vibration, etc.
- Be aware that not only does the Hard Disk have a fixed lifetime, but that accidents can always occur. Therefore, be sure to back up your Hard Disk's data regularly, or prepare another Hard Disk unit that can be used for backup.



- The Hard Disk lifetime given here may be reduced due to unforeseen environmental factors, however, generally speaking, at an operating temperature of 20°C the disk should last for 20,000 hours (of operation) or approximately 5 years, whichever comes first.
- Using the Hard Disk in an environment that is excessively hot and/or humid will shorten the disk's usage lifetime. A maximum wet bulb temperature of 29°C is recommended. This is equivalent to the following data.

Temperature	Humidity
at 35°C	no higher than 64%RH
at 40°C	no higher than 44%RH

## ■ Structural

		PL-7920	PL-7921
<b>Grounding</b>		Exclusive grounding only: Less than 100Ω, or your country's applicable standard.	
<b>Rating<sup>*1</sup></b>		Equivalent to IP65f (JEM1030)	
<b>Cooling Method</b>	<b>700MHz CPU Model</b>	Via heat convection tubes and electric fan	
	<b>1GHz CPU Model</b>	Via both heat convection tubes built in to CPU fan and electric fan	
<b>Weight</b>		Less than 10.5 kg (23.1 lb) (with HDD and FDD installed)	Less than 9.5 kg (20.9 lb) (with HDD and FDD installed)
<b>External Dimensions (excluding projections)</b>		W374 mm [14.72 in.] x H325 mm [12.80 in.] x D180 mm [7.09 in.]	W374 mm [14.72 in.] x H325 mm [12.80 in.] x D134 mm [5.28 in.]
<b>Dimensions Including Full-sized Cover (excluding projections)</b>		W422 mm [16.61 in.] x H325 mm [12.80 in.] x D180 mm [7.09 in.]	W422 mm [16.61 in.] x H325 mm [12.80 in.] x D134 mm [5.28 in.]
<b>Dimensions Including PL-RC500 Unit (excluding projections and cable)</b>		W374 mm [14.72 in.] x H325 mm [12.80 in.] x D180 mm [7.09 in.]	W374 mm [14.72 in.] x H325 mm [12.80 in.] x D156 mm [6.14 in.]

*\*1 The front face of the PL unit, installed in a solid panel, has been tested using conditions equivalent to the standard shown in the specification. Even though the PL unit's level of resistance is equivalent to the standard, oils that should have no effect on the PL can possibly harm the unit. This can occur in areas where either vaporized oils are present, or where low viscosity cutting oils are allowed to adhere to the unit for long periods of time. If the PL's front face protection sheet becomes peeled off, these conditions can lead to the ingress of oil into the PL and separate protection measures are suggested. Also, if non-approved oils are present, it may cause deformation or corrosion of the front panel's plastic cover. Therefore, prior to installing the PL be sure to confirm the type of conditions that will be present in the PL's operating environment.*

*If the installation gasket is used for a long period of time, or if the unit and its gasket are removed from the panel, the original level of the protection cannot be guaranteed. To maintain the original protection level, you need to replace the installation gasket regularly.*

## 4 Interface Specifications

### ■ Printer Interface (LPT1)

#### D-sub 25 pin (Female)

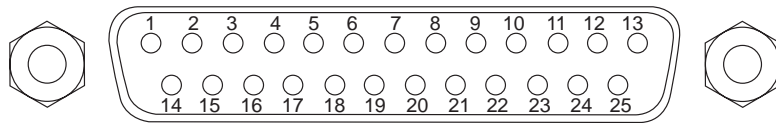

Note: Electrical Specifications

**O.D** : Open Drain

**T.S** : 3 state I/O

**TTLIN** : TTL Input

Screw Size: (4-40): Inch Type

Pin No.	SPP/ECP Mode Signal Name	EPP Mode Signal Name	Direction	Electrical Specif.	Pin No.	SPP/ECP Mode Signal Name	EPP Mode Signal Name	Direction	Electrical Specif.
1	STRB	WRITE	In/Output	O.D	14	AUTOFD	DSTRB	In/Output	O.D
2	DATA0	DATA0	In/Output	O.D	15	ERROR	ERROR	Input	TTL
3	DATA1	DATA1	In/Output	O.D	16	INIT	INIT	In/Output	O.D
4	DATA2	DATA2	In/Output	O.D	17	SLCTIN	ADSTRB	In/Output	O.D
5	DATA3	DATA3	In/Output	O.D	18	GND	GND		
6	DATA4	DATA4	In/Output	O.D	19	GND	GND		
7	DATA5	DATA5	In/Output	O.D	20	GND	GND		
8	DATA6	DATA6	In/Output	O.D	21	GND	GND		
9	DATA7	DATA7	In/Output	O.D	22	GND	GND		
10	ACKNLG	ACKNLG	Input	TTL	23	GND	GND		
11	BUSY	WAIT	Input	TTL	24	GND	GND		
12	PE	PE	Input	TTL	25	GND	GND		
13	SLCT	SLCT	Input	TTL					



- Pins 1, 4, 16 and 17 will become O.D when the SPP mode specification is used. If the mode changes to ECP or EPP, these pins will become T.S

### ■ USB Interface (USB) Receptacle

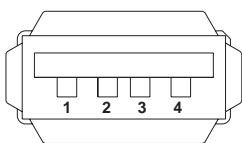

Pin No.	Name
1	Vcc
2	- Data
3	+ Data
4	GND

### ■ Keyboard Interface/Mouse Interface (The PL's front and side connectors are the same)

#### Mini - DIN 6 pin (Female)

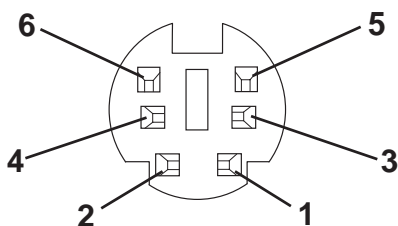

#### Keyboard

Pin No.	Signal Name
1	KEYDATA
2	NC
3	GND
4	+5V
5	KEYCLK
6	NC
SHIELD	GND

#### Mouse

Pin No.	Signal Name
1	Mouse DATA
2	NC
3	GND
4	+5V
5	Mouse CLK
6	NC
SHIELD	GND



107 key (English) and 112 key (Japanese) ACPI-compatible keyboards cannot be used. Be sure your keyboard is a 101 key, 104 key (English), 106 key, or 109 key (Japanese) keyboard.



## ■ RS-232C Interface (COM1/COM2/COM3)

### Dsub 9 pin (Male)

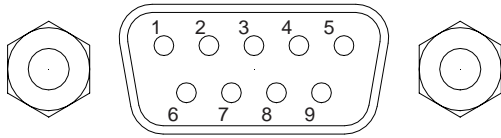

**Screw Size:** (4-40): Inch Type

Pin No.	Signal Name	Pin No.	Signal Name
1	DCD	6	DSR
2	RXD	7	RTS
3	TXD	8	CTS
4	DTR	9	RI/+5V
5	GND		



The GND terminal is the signal ground. Be sure to connect the GND terminal to the other unit's SG (signal ground).

Number 9 pin's [RI/+5V] changeover is COM2 and COM3. COM1 becomes [RI]. To set the changeover for COM2 and COM3, remove the PL's rear maintenance cover and locate the main function switches, next to the PL's circuit board. To change COM2, set main function switch SW2 to ON, and COM2 will change to +5V. The factory setting is OFF and [RI]. To change COM3, simply turn SW3 to ON.

**Reference** *PL-6920/PL-7920 Series Panel Computer User Manual, 2.3.4 RS-232C Interface (COM1/COM2/COM3)*



Be sure to confirm what settings will be used by the other device and set the dip switches accordingly. Failure to do so can result in a unit malfunction or damage.

Whenever changing the PL Main Function switches, be sure to first turn the PL's power supply OFF. Failure to do so can cause a PL malfunction.

## ■ RAS Interface

### Dsub 25 pin (Male)

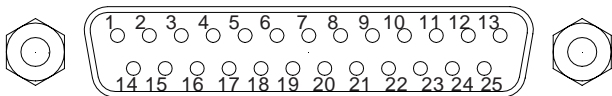

**Screw Size:** (4-40): Inch Type

Pin No.	Signal Name	Pin No.	Signal Name
1	GND	14	GND
2	+5V (MAX. 100mA)	15	+5V
3	+12V (MAX. 100mA)	16	NC
4	NC	17	NC
5	RESET INPUT (+)	18	NC
6	DIN 0 (+)	19	NC
7	DOUT (-)	20	NC
8	DOUT (+)	21	LAMP OUT (-)
9	ALARM OUT (-)	22	LAMP OUT (+)
10	ALARM OUT (+)	23	NC
11	RESET INPUT (-)	24	DIN1 (-)
12	DIN 0 (-)	25	NC
13	DIN 1 (+)		



When using No.2 (+5V) and No.3 (+12V) External Power Output, be sure to use only the designated level of current. Failure to do so can cause equipment damage or a unit malfunction.

◆ External Input Signal (Dual use of DIN, Remote Set Input Port)

<b>Input Voltage</b>	DC12V to DC24V
<b>Input Current</b>	7mA
<b>Operating Voltage</b>	ON voltage: 9V (min), OFF voltage:3V (max)
<b>Isolation Method</b>	Via photocoupler

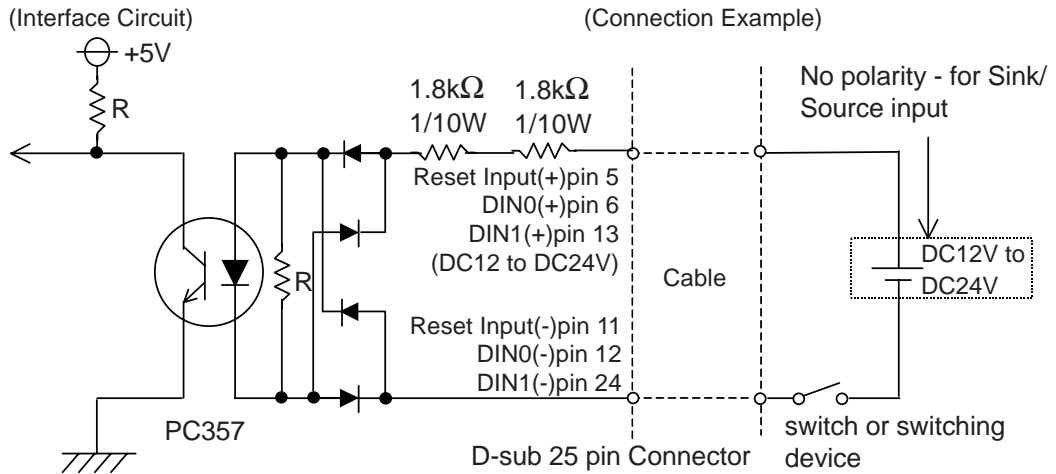

- General Purpose Input (DIN) level must be 1.5S or longer to be detected.
- Be sure the voltage value between terminals is controlled via the input voltage, so that the PL is operated within its recommended range. If the input voltage exceeds this range, a malfunction or PL damage may occur.
- With Sink/Source input, even if the D(-), and RESET(-) are positive, and D(+), RESET(+) are negative, no problems are created. Be sure to operate the unit within the recommended voltage range.

◆ External Output Signal (Dual use of DOUT, Alarm Output, Lamp Output Port)

<b>Rated Load Voltage</b>	DC12V to DC24V
<b>Maximum Load Current</b>	100mA/point
<b>Maximum Voltage Drop between Terminals</b>	1.5V (at 100mA load current)
<b>Isolation Method</b>	Via photocoupler

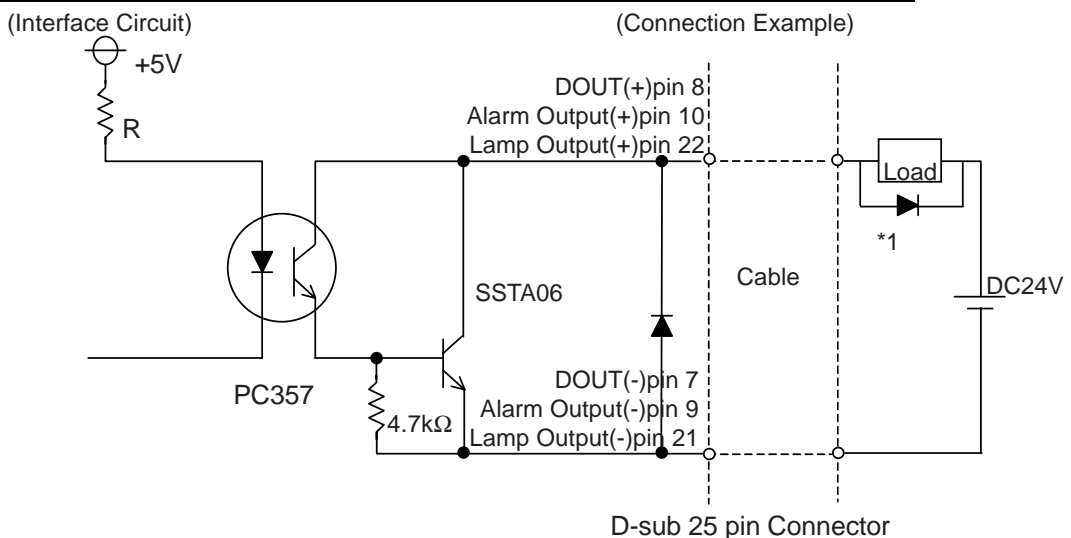

- Be sure to operate the unit within its maximum load current. If the maximum load current exceeds this range, a malfunction or PL damage may occur.



- Design your electrical system by adding the load current and voltage values to the terminal voltage. If load current value used is large, a maximum voltage of 1.5V will exist between the terminals.
- When connecting an induction load, be sure to connect the above drawing's protection diode(\*1).

## 5 Installing the PL

Follow the steps given below when installing the PL.

### ■ Attaching the Moisture Resistant Gasket

Even if the your PL's Moisture Resistant Gasket is not needed to prevent water from entering the unit, the gasket also acts as a vibration absorber and should always be attached. To install it, place the PL face down on a soft surface and attach the gasket to the rear side of the display face, in the plastic bezel's groove (see picture below).



Before installing the PL into a cabinet or panel, check that the moisture resistant gasket is attached to the unit.

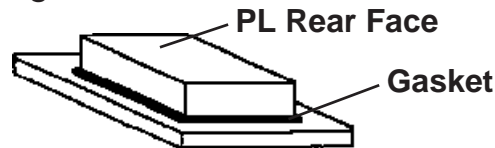

### ■ Create a Panel Cut

Create a panel cut for the PL unit, using the dimensions given here. Two additional items, the moisture resistant gasket and the mounting brackets are also required when installing the PL.

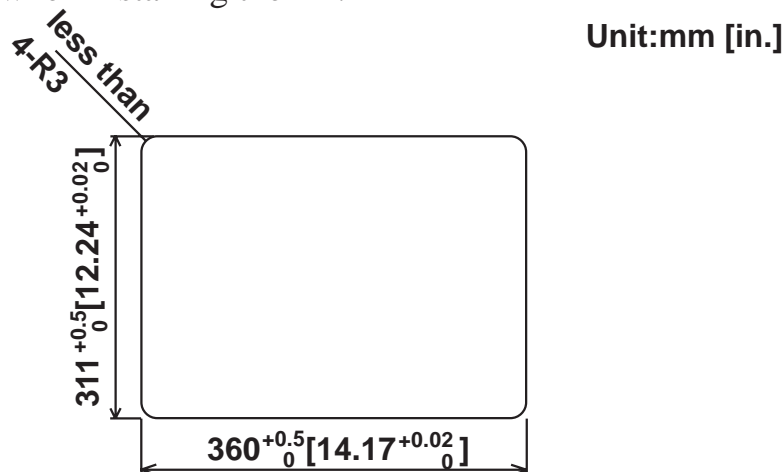

**Note:** To obtain the maximum degree of moisture resistance, be sure to install the PL on a smooth, flat surface.



- The panel itself can be from 1.6 mm [0.06 in.] to 10.0 mm [0.39 in.] thick.
- Strengthening may be required for the panel. Be sure to consider the weight of the PL when designing the panel.

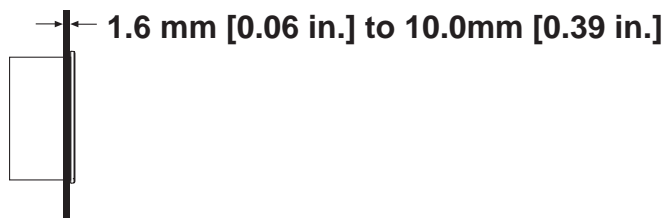

## ■ Installation

- 1) Insert the PL into the panel cut.

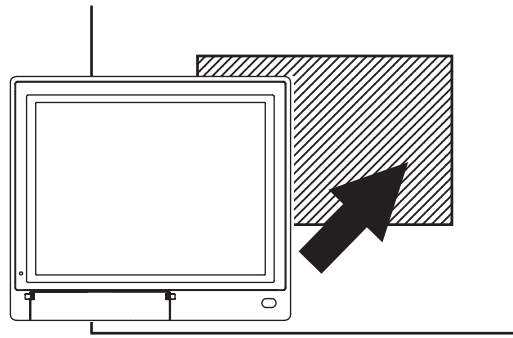

- 2) Locate the PL unit's twelve (12) attachment holes (top, bottom, and sides). Insert each bracket into its attachment hole.

### Top and Bottom Faces

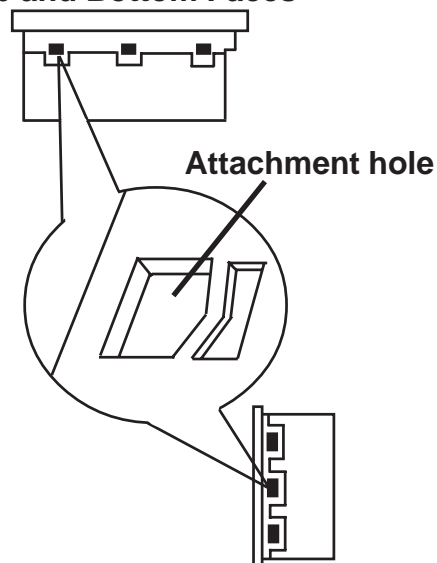

- 3) After inserting each bracket into its attachment hole, slide the bracket backwards until it stops.

### Left and Right sides

- 4) Slowly tighten each fastener attachment screw in sequence (top, bottom, left side, right side), until all fasteners are evenly and securely tightened.

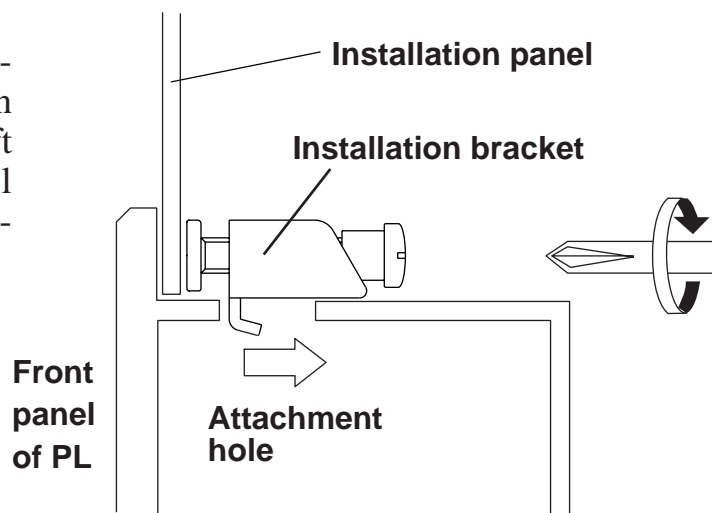

Excessive torque may damage the panel or bracket. To ensure a high degree of moisture resistance, the torque should be 0.5N•m.

## 6 Wiring the PL

### ■ Connecting the power cord

(Side View of PL)

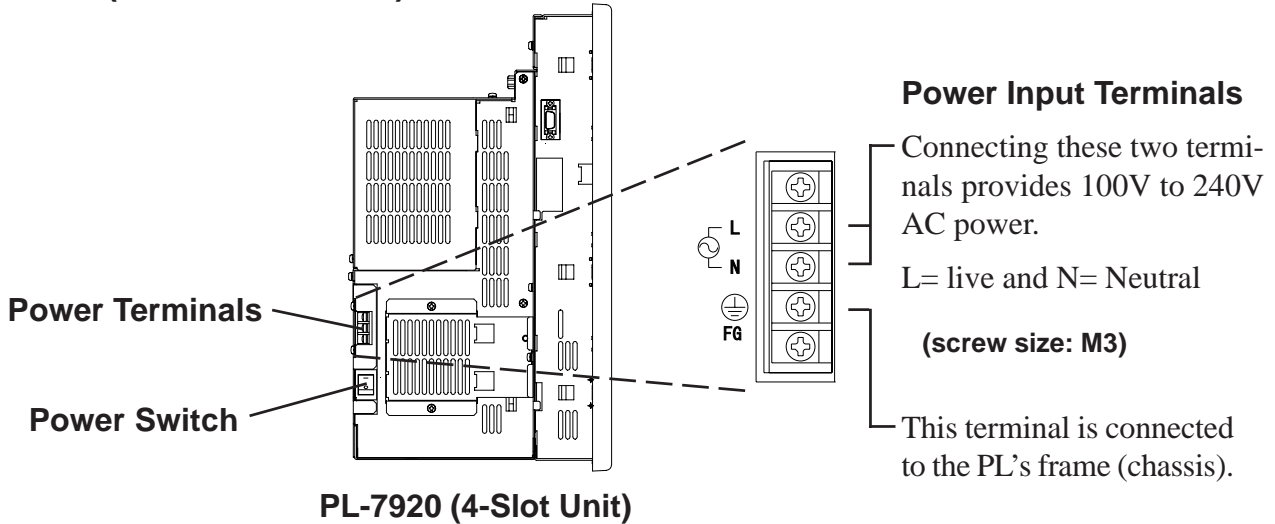

## WARNINGS

- To prevent electric shocks, be sure to turn the PL's power supply OFF before connecting the power cord.
- To avoid the dangers of fire, electric hazards and equipment damage, be sure to use only the specified power supply voltage when operating the PL.

Use the following steps when connecting the power cord to the PL's power terminals.

### POWER

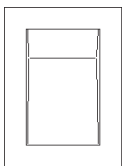

I :ON  
o :OFF

- 1) Confirm that the PL unit's power switch is turned OFF. Then, remove the power terminal's transparent plastic cover.

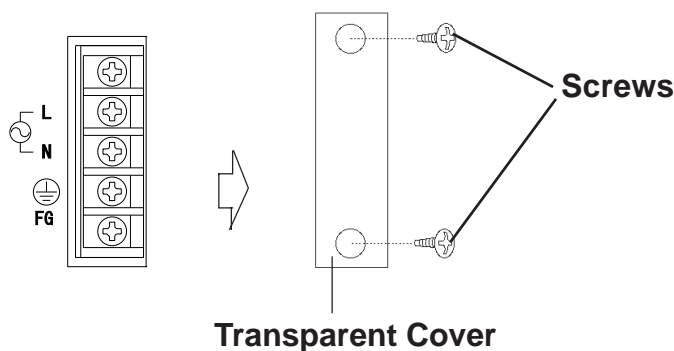

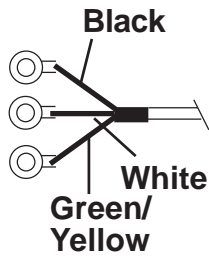
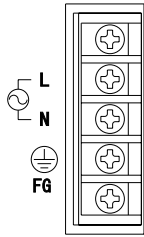

2) Loosen and remove the middle three (3) screws from the terminal strip. Align the crimp terminals with each screw hole, and tighten the screws.



- Crimp Terminal Types : V1.25-3, by J.S.T. or equivalent (JIS standard part number : **RAV1.25-3**)
- Crimp terminals must be the same as shown below.

$\phi$  3.2 mm [0.13 in.] or larger

Max. 6.0 mm [0.24 in.]

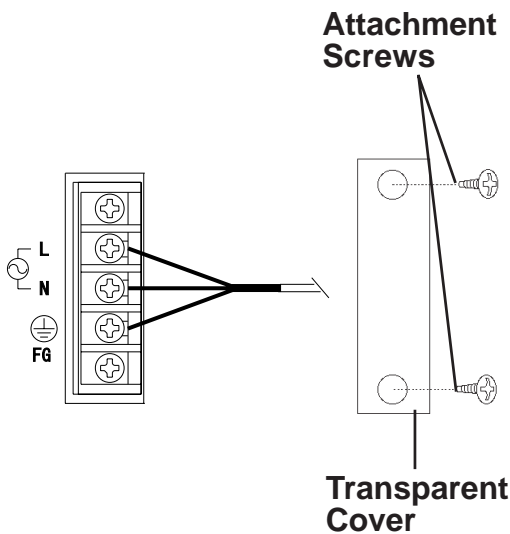
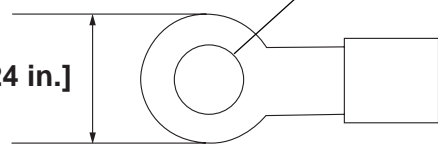

- The colors in the figure above are for the cable which came with the PL.
  - This power cable is designed only for AC100/115V use. Be sure to use a different cable when using other than AC100/115V power.
- 3) Reattach the terminal strip's transparent cover with the attachment screws.

## 7 Power Supply Cautions

When connecting the PL unit's AC power terminals, please be aware of the following:

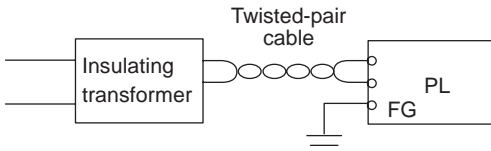
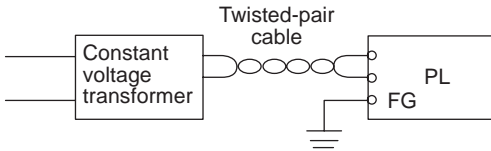

- If voltage fluctuations are expected to vary beyond the specified range, connect a constant voltage transformer.
- Use a low-noise power supply both between the lines and between the PL and its ground. If there is still excess noise, connect an insulating transformer (noise-prevention type).



**Note:** Be sure any constant or insulating transformer used has a capacity of 200VA or more.

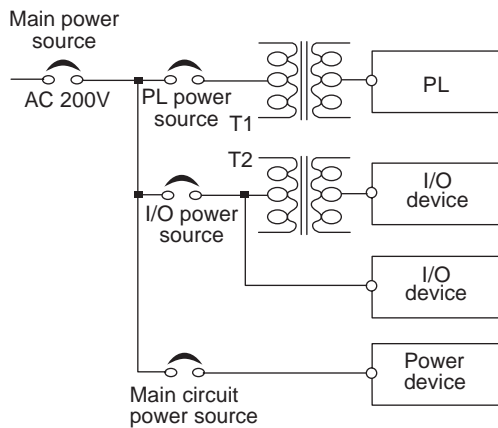
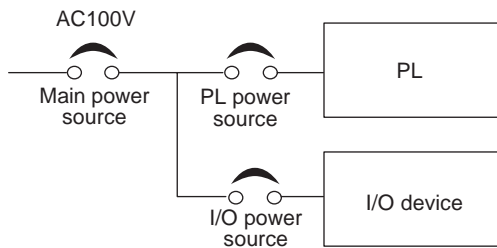

- Wire the power cords of the PL, I/O devices, and power supply devices separately.
- To improve noise immunity, it is recommended to attach a ferrite core to the power cord.
- Isolate the main circuit (high voltage, large current) line, I/O signal lines, and power cord, and do not bind or group them together.
- To prevent damage from lightning, connect a lightning surge absorber.

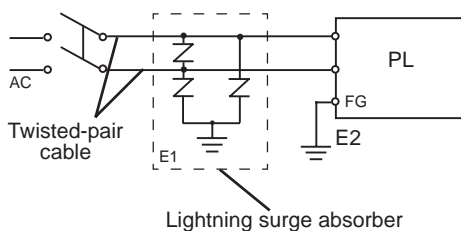

- Ground the lightning surge absorber (E1) and the PL (E2) separately.
- Select a lightning surge absorber which will not exceed the allowable circuit voltage, even when the voltage rises to the maximum.

## 8

## Grounding Cautions

### (a) Dedicated Ground



### (b) Shared Ground - allowed

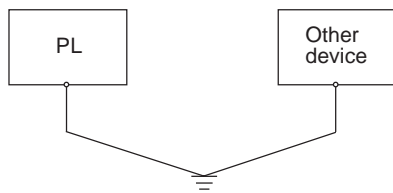

### (c) Shared ground - not allowed

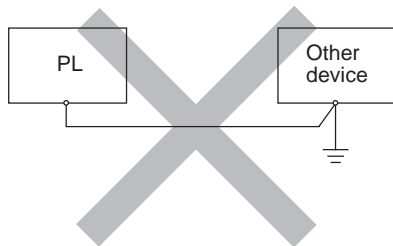

- Set up a dedicated ground when using the rear panel's FG terminal. Use a grounding resistance of  $100\Omega$ , a wire of  $2\text{ mm}^2$  or thicker, or your country's applicable standard.
- If a dedicated ground is not possible, use a shared ground, as shown in figure (b).
- Inside the PL unit, the SG (Signal Ground) and FG (Frame Ground) terminals are connected to each other.
- When connecting an external device to PL with the SG terminal, ensure that no short-circuit loop is created when you set up the system.
- The grounding point must be as close to the PL as possible, and the grounding wires must be as short as possible. If the wires must be long, use thick, insulated wires and run them through conduits.

## 9

## Cautions When Connecting I/O Signal Lines

- I/O signal lines must be wired separately from the power circuit cable. If the power circuit cable needs to be wired together with the input/output (I/O) signal lines for any reason, use shielded cables and ground one end of the shield to the PL's FG terminal.
- To improve noise immunity, it is recommended to attach a ferrite core to the power cord.

### Note

Please be aware that Digital Electronics Corporation shall not be held liable by the user for any damages, losses, or third party claims arising from the uses of this product.

Digital Electronics Corporation

8-2-52 Nanko Higashi, Suminoe-ku, Osaka 559-0031, Japan

URL: <http://www.pro-face.com/>

© 2003 Digital Electronics Corporation All rights reserved.

058220D .PL7920-MT03-BTHE 2003.2 JM/A