

PL-3000B Series Installation Guide

Caution

Be sure to read the "Warning/Caution Information" on the attached sheet before using the product.

Package Contents

- (1) PL Unit (1)
- (2) English and Japanese Installation Guides (one of each) <This Guide>
- (3) Warning/Caution Information (1)
- (4) Installation Fasteners (Fasteners: 2, screws: 4)

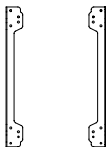

- (5) USB Cable Clamp (2 ports) (2)

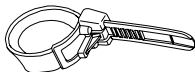

- (6) USB holder: 1 set (fasteners: 1, screws: 2)



- (7) Power Connector (For AC type or DC type) (1)



AC type
(5.08mm [0.2in.] pitch)



DC type
(7.62mm [0.3in.] pitch)

- (8) Power Switch cover (cover: 1, screws: 2)
(AC type only)



IMPORTANT

- Be careful when installing the PL not to damage the built-in HDD.

This unit has been carefully packed, with special attention to quality. However, should you find anything damaged or missing, please contact your local PL distributor immediately.

When you order a PL unit built to your specifications, that PL package should include each optional item's Installation Guide. Please use that guide to check the contents of each optional item's package.

About the Manuals

For the detailed information on PL series, refer to the following manuals.

- PL3000 Series Hardware Manual
- PL3000 Series Reference Manual
- PL3000 Series API Reference Manual

The manual can be downloaded from Pro-face Home Page.

URL

<http://www.pro-face.com/otasuke/>

NOTE

- The drivers and utilities for PL can be downloaded from Pro-face Home Page.

Part Names and Functions

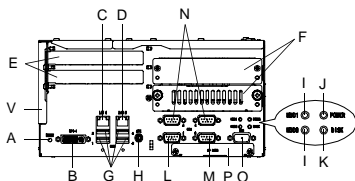

Front (2 slot type)

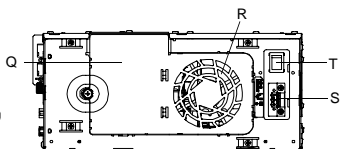

Right side (2 slot type)

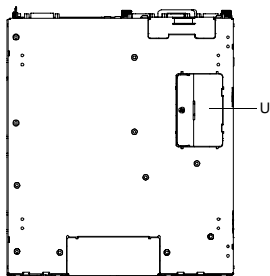

Bottom

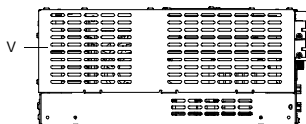

Left side (2 slot type)

	Name	Description						
A	Hardware reset switch (RESET)	Resets the PL unit and returns the system from Soft OFF ^{*1} .						
B	DVI-I interface (DVI-I)	Interface with DVI monitor or analog RGB monitor						
C	Ethernet interface (LAN1)	10BASE-T/100BASE-TX/1000BASE-T Auto Changeover. This interface uses an RJ-45 type modular jack connector (8 pins).						
D	Ethernet interface (LAN2)	10BASE-T/100BASE-TX Auto Changeover. This interface uses an RJ-45 type modular jack connector (8 pins).						
E	Expansion slot	For expansion board (PCI). 2 slots or 4 slots.						
F	HDD slot	For serial ATA HDD/SSD unit. HDD slot 0 and then HDD slot 1 from the bottom						
G	USB interface (USB1/2/3/4)	4 ports. USB2.0 compatible. Type-A connector is used. <table border="1" style="margin-left: 20px;"> <tr> <td>Power supply voltage</td> <td>DC5V±5%</td> </tr> <tr> <td>Output current</td> <td>500mA (Max.)</td> </tr> <tr> <td>Maximum communication distance</td> <td>5m</td> </tr> </table>	Power supply voltage	DC5V±5%	Output current	500mA (Max.)	Maximum communication distance	5m
Power supply voltage	DC5V±5%							
Output current	500mA (Max.)							
Maximum communication distance	5m							

H	Speaker output interface (SPK)	Mini pin jack connector										
I	HDD status lamp	For HDD slot 0 and then for HDD slot 1 from the bottom <table border="1"> <thead> <tr> <th>LED</th> <th>Indicates</th> </tr> </thead> <tbody> <tr> <td>Green (lit)</td> <td>HDD/SSD mounted (Normal operation)</td> </tr> <tr> <td>Not lit</td> <td>No HDD/SSD mounted</td> </tr> </tbody> </table>	LED	Indicates	Green (lit)	HDD/SSD mounted (Normal operation)	Not lit	No HDD/SSD mounted				
LED	Indicates											
Green (lit)	HDD/SSD mounted (Normal operation)											
Not lit	No HDD/SSD mounted											
J	Power LED / RAS status lamp (POWER)	<table border="1"> <thead> <tr> <th>LED</th> <th>Indicates</th> </tr> </thead> <tbody> <tr> <td>Green (lit)</td> <td>Normal operation (power is on)</td> </tr> <tr> <td>Green (blinking)</td> <td>Soft OFF state</td> </tr> <tr> <td>Orange (lit)</td> <td>System monitor error (RAS error)</td> </tr> <tr> <td>Not lit</td> <td>Power is OFF</td> </tr> </tbody> </table>	LED	Indicates	Green (lit)	Normal operation (power is on)	Green (blinking)	Soft OFF state	Orange (lit)	System monitor error (RAS error)	Not lit	Power is OFF
LED	Indicates											
Green (lit)	Normal operation (power is on)											
Green (blinking)	Soft OFF state											
Orange (lit)	System monitor error (RAS error)											
Not lit	Power is OFF											
K	Disk access lamp (DISK)	<table border="1"> <thead> <tr> <th>LED</th> <th>Indicates</th> </tr> </thead> <tbody> <tr> <td>Green (lit)</td> <td>When HDD/SSD or IDE is accessed</td> </tr> <tr> <td>Not lit</td> <td>When neither HDD/SSD nor IDE is accessed</td> </tr> </tbody> </table>	LED	Indicates	Green (lit)	When HDD/SSD or IDE is accessed	Not lit	When neither HDD/SSD nor IDE is accessed				
LED	Indicates											
Green (lit)	When HDD/SSD or IDE is accessed											
Not lit	When neither HDD/SSD nor IDE is accessed											
L	Serial interface (COM1)	D-Sub 9-pin plug type.RS-232C, RS-422, RS-485 Changeover.CI (RI)/+5V Changeover.										
M	Serial interface (COM2)	D-Sub 9-pin plug type.RS-232C. CI (RI)/+5V Changeover.										
N	Serial interface (COM3/COM4)	D-Sub 9-pin plug type.RS-232C. COM3 and then COM4 from the left										
O	RAS interface (RAS)	D-Sub 9 pin socket type.										
P	CF card interface (CF CARD)	IDE-type connection *2 CF card (Type I/II) is available.										
Q	Fan cover	System fan inside										
R	System fan	A fan for cooling the PL unit.										
S	Power connector	–										
T	Power switch	AC type only.										
U	Switch cover	Remove switch cover when setting the DIP switch, slide switch, and replacing batteries for clock data backup.										
V	Expansion slot cover	Expansion slot cover is removed when mounting expansion board and DIM module.										

*1 The Soft OFF refers to the state when Windows® has been shut down and the power is provided only for the electric circuit to boot system. This Soft OFF State is different from Windows® System Standby.

*2 Since an IDE-type connection is used, the unit is not hot-swappable. When inserting/removing the CF card, be sure that power is turned OFF.

IMPORTANT

- When attaching peripheral units to the PL, be sure the PL's power cord is disconnected from the main power supply.

General Specifications

■ Electrical Specifications

Power Supply		DC type	AC type
	Input Voltage	DC24V	AC100 to 240V
	Rated Voltage	DC19.2 to 28.8V	AC85 to 264V
	Rated Frequency	–	50/60Hz
	Allowable Frequency Range	–	47 to 63Hz
	Allowable Voltage Drop	5ms or less	1 cycle or less (Voltage drop interval must be 1s or more.)
	Power Consumption	2 slot type: 120W or less 4 slot type: 145W or less	2 slot type: 120VA or less 4 slot type: 145VA or less
	In-Rush Current	40A or less	
Voltage Endurance	AC1000V 20mA for 1 minute (between charging and FG terminals)	AC1500V 20mA for 1 minute (between charging and FG terminals)	
Insulation Resistance	DC500V 10M Ω (min.) (between charging and FG terminals)	DC500V 10M Ω (min.) (between charging and FG terminals)	

■ Environmental Specifications

Physical	Surrounding Air Temperature	0 to 50°C : without HDD *1 5 to 50°C : with HDD *1
	Storage Temperature	-20 to +60°C (when packed)
	Ambient Humidity	10 to 90% RH (Not condensing, wet bulb temperature: 39°C or less. Wet bulb temperature with HDD *1: 29°C or less.)
	Storage Humidity	10 to 90% RH (Not condensing, wet bulb temperature: 39°C or less.)
	Dust	Free of dust
	Pollution Degree	For use in Pollution Degree 2 environment

*1 It is regarding whether SSD installing.

IMPORTANT

- When using any of the PL's optional devices, be sure to check that device's specifications for any special conditions or cautions that may apply to its use.
- Be aware that not only does the HDD/SSD have a fixed lifetime, but that accidents can always occur. Therefore, be sure to back up your HDD/SSD's data regularly, or prepare another HDD/SSD unit that can be used for backup.
- The Hard Disk lifetime given here may be reduced due to unforeseen environmental factors, however, generally speaking, the disk should last for 20,000 hours (of operation) or approximately 5 years, whichever comes first at an operating temperature of 20°C and 333 hours of operation per month. (HDD access frequency of 20% or less)
- Using the Hard Disk in an environment that is excessively hot and/or humid will shorten the disk's usage lifetime. A wet bulb temperature of 29°C or less is recommended. This is equivalent to the following data.

Temperature	at 35°C	at 40°C
Humidity	no higher than 64% RH	no higher than 44% RH

- In order to extend the lifetime of the hard disk, Pro-face recommends you set the Windows® 2000's [Control panel]-[Power Management option]-[Turn off hard disks] selection or the Windows® XP's [Control panel]-[Performance and Maintenance]-[Power Management option]-[Turn off hard disks] selection to turn the hard disk off when the unit is not being operated. A setting of 5 minutes is recommended.
- Do not vibrate the hard disk continuously at the same frequency. Doing so may cause the hard disk to reduce transfer speeds or stop temporarily.

Internal Switches

Open the switch cover on the bottom of the PL unit and you will find the following five switches:

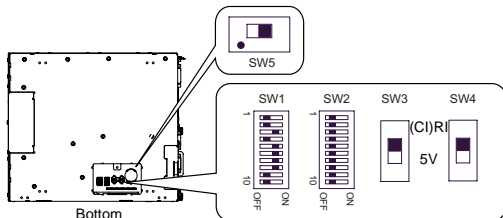

IMPORTANT

- Make sure to turn off the power supply before using the switches. Adjusting the switches while power is supplied may cause errors.

Switch Location	Switch Name	Compatible I/F	Factory Settings	Description
SW1	System Set Switch	-	See ■ System Set Switch	10-point DIP switch. For System Set Switch and the factory settings details, see ■ System Set Switch.
SW2	Serial Mode Select Switch	COM1	All OFF (RS-232C)	10-point DIP switch. Designates COM1 communication settings. For Serial Mode Select Switch details, see ■ Serial Mode Select Switch.
SW3	CI(RI)/+5V Changeover Switch	COM2	CI(RI)	Changes # 9 pin (CI(RI) / +5V).
SW4	CI(RI)/+5V Changeover Switch	COM1	CI(RI)	Changes # 9 pin (CI(RI) / +5V).
SW5	DVI Cable Selection Switch	-	 Side without the symbol ● (FP-DV01-100 is not supported)	Toggles between supporting and not supporting the FP-DV01-100 [DVI-D cable (10m)], a Pro-face FP3000 Series option. For details, see ■ DVI Cable Selection Switch.

■ System Set Switch

Switch No.	Description	ON	OFF	Factory Settings	Notes
1	Used for the system	Reserved	Reserved	OFF	Use this switch as factory setting.
2	Implements the logical inversion operation for RAS output	Normal Close	Normal Open	OFF	RAS output is a CLOSE state when the switch and the system is ON. When the Switch is OFF, it is the opposite. The RAS Output keeps Normal OPEN when the Soft OFF state occurs or the power turns OFF.
3	Used for the system	Reserved	Reserved	ON	Use this switch as factory setting.
4				OFF	
5 to 8				ON	
9 to 10				OFF	

■ Serial Mode Select Switch

Switch No.	Description	ON	OFF	RS-232C	RS-422	RS-485
1	Used for the system	Reserved	Reserved	OFF ^{*1}	OFF ^{*1}	OFF ^{*1}
2	Changes COM1's communication method	RS-422/RS-485	RS-232C	OFF	ON	ON
3	Changes COM1's communication method	RS-422/RS-485	RS-232C	OFF	ON	ON
4	Changes SD (TXD) data's output mode	SD (TXD) data output is controlled via the RS (RTS) signal.	SD (TXD) data output is NOT controlled via the RS (RTS) signal. (normally output)	OFF	ON/ OFF	ON/ OFF ^{*2}
5	Switches the SD (TXD) termination resistance ON/OFF	Inserts termination resistance of 220Ω between SDA and SDB.	No termination	OFF	ON	ON/ OFF ^{*3}
6	Switches the RD (RXD) termination resistance ON/OFF	Inserts termination resistance of 220Ω between RDA and RDB.	No termination	OFF	ON	ON/ OFF ^{*3}

Switch No.	Description	ON	OFF	RS-232C	RS-422	RS-485
7	Switches the shorting of SDA and RDA ON or OFF	Shorts SDA and RDA (RS-485 mode)	No shorting (RS-422 mode)	OFF	OFF	ON
8	Switches the shorting of SDB and RDB ON or OFF	Shorts SDB and RDB (RS-485 mode)	No shorting (RS-422 mode)	OFF	OFF	ON
9	RS (RTS) Automatic control mode	The data is automatically controlled via the RS (RTS) signal.	The data is not automatically controlled via the RS (RTS) signal.	OFF	OFF	ON/ OFF*2
10	(enabled only when RS-485 mode)			OFF	OFF	ON/ OFF*2

Serial Mode Select Switches (SW4 to SW10) operate as shown in the circuit diagram below.

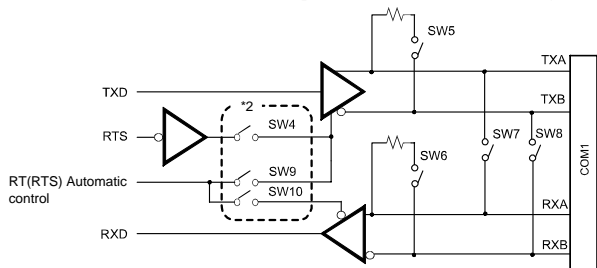

*1 Be sure to leave these settings OFF.

*2 Set switches number 9 and 10 to ON when the SD (TXD) output driver is automatically controlled with RS (RTS). Set switch number 4 to OFF. Set switches number 9 and 10 to OFF when the SD (TXD) output driver is controlled with the RS (RTS) signal. Set switch number 4 to ON.

*3 If you use the termination resistance, base your settings on the connection specifications.

■ DVI Cable Selection Switch

When connecting Pro-face FP3000 Series to PL unit, use the Pro-face DVI-D cable (10m) FP-DV01-100. (Other 10m DVI cables are not supported)

When using FP-DV01-100, change DVI Cable Selection Switch (SW5) settings.

Factory Setting



For FP-DV01-100



IMPORTANT

- When using the display unit with a cable other than FP-DV01-100 (such as FP-DVD01-50), use the Factory Setting.

NOTE

- The default Resolution and Screen Refresh Rates are as follows.
 - Resolution : SVGA (800x600) Screen Refresh Rate: 60Hz
 - Maximum resolution varies depending on the FP3000 Series models. Please customize it for your FP model.

External Interfaces

IMPORTANT

- Always connect the #5 SG (Signal Ground) of the PL unit to the connected device, especially if the connected device is also not isolated. Failure to do so may damage the RS-232C/RS-422/RS-485 circuit.
- Never connect NC to COM1.
- Connect FG to housing.

Serial Interface (COM1, COM2, COM3, COM4)

Interfit Bracket	#4-40(UNC)
------------------	------------

◆COM1, COM2, COM3, COM4

Pin #	RS-232C	
	Signal Name	Description
1	CD	Carrier Detect
2	RD(RXD)	Receive Data
3	SD(TXD)	Send Data
4	ER(DTR)	Data Terminal Ready
5	SG	Signal Ground
6	DR(DSR)	Data Set Ready
7	RS(RTS)	Request to Send
8	CS(CTS)	Clear to Send
9	CI(RI)/+5V	Called status display/ +5V Output 0.5A ^{*1} ^{*2}
Shell	FG	Frame Ground (Common with SG)

^{*1} Only COM1 and COM2 are available for switching to +5 V. COM3 and COM4 are used exclusively for CI (RI).

^{*2} Slide switch on the circuit board in the PL unit switches between CI (RI) and +5 V. For details, see [Internal Switches].

◆COM1

Pin #	RS-422 ^{*3}	
	Signal Name	Description
1	RDA	Receive Data A(+)
2	RDB	Receive Data B(-)
3	SDA	Send Data A(+)
4	ERA	Data Terminal Ready A(+)
5	SG	Signal Ground
6	CSB	Clear to Send B(-)
7	SDB	Send Data B(-)
8	CSA	Clear to Send A(+)
9	ERB	Data Terminal Ready B(-)
Shell	FG	Frame Ground (Common with SG)

Pin #	RS-485 ^{*3}	
	Signal Name	Description
1	DATA +	Send/Receive Data (+)
2	DATA -	Send/Receive Data (-)
3	NC	No Connection
4	NC	No Connection
5	SG	Signal Ground
6	NC	No Connection
7	NC	No Connection
8	NC	No Connection
9	NC	No Connection
Shell	FG	Frame Ground (Common with SG)

^{*3} To change the communication method, set the DIP switch located on the circuit board in the PL unit to the desired position. For details, see [Internal Switches].

■ RAS Interface

IMPORTANT

- Be sure to use only the rated voltage level when using pin #1 (+12V) for external power output. Failure to do so can lead to a unit malfunction or accident.

Interfit Bracket	#4-40(UNC)
------------------	------------

Pin #	Signal Name	Description
1	+12V	Output Current: 100mA or less Output Voltage: 12V±5%
2	DOUT0(+)	Data out 0(+)
3	DOUT1(+)	Data out 1(+)
4	DIN0(+)	Data in 0(+)
5	DIN1(+)	Data in 1(+) ^{*1}
6	GND	Ground
7	DOUT0(-)	Data out 0(-)
8	DOUT1(-)	Data out 1(-)
9	DINCOM	Data in ground common

*1 Can be used as reset input.

NOTE

- For the circuit diagram, refer to “PL3000 Series Reference Manual”.

Installations

1. Installation Requirements

- For easier maintenance, operation, and improved ventilation, be sure to install the PL at least 50mm [1.97 in.] away from adjacent structures and other equipment. 120 mm [4.72 in.] space (minimum) is necessary at the front for cable curve.

Unit:mm[in.]

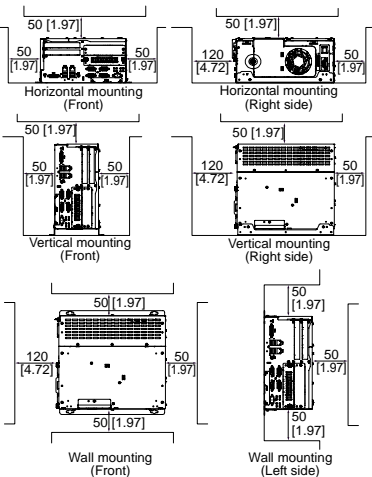

- Be sure that the surrounding air temperature and the ambient humidity are within their specified ranges.

Check the surrounding air temperature 30 mm [1.18 in.] away from the main unit.

Ex.: Horizontal mounting Unit:mm[in.]

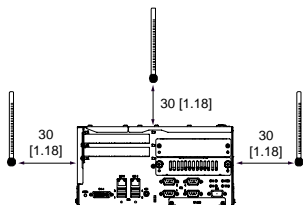

- Be sure that heat from surrounding equipment does not cause the PL to exceed its standard operating temperature.

2. PL Installation

IMPORTANT

- Determine the thickness of the board in consideration of its strength. The minimum thickness of a board is 1.6 mm [0.06 in.] for M4 screws.
 - M4 screws are not included with the PL unit. Please prepare them by yourself.
- (1) Create holes and perform the necessary processing on the board according to the drawing of mounting holes.

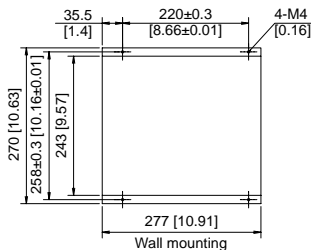
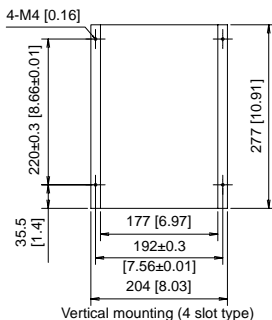
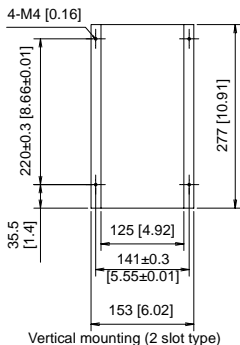
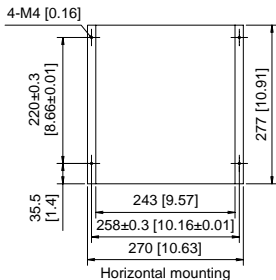

- (2) Attach installation fasteners with the accompanying four screws (M3) to the PL unit. Pay close attention to the direction of the fasteners. The torque required to tighten these screws is 0.5 to 0.6N•m.

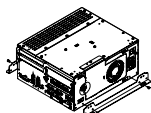

Horizontal mounting
or wall mounting

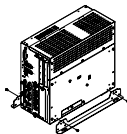

Vertical mounting

- (3) Attach the PL unit to the board with the screws (M4): First, tighten the screws temporarily on the board; mount installation fasteners temporarily onto the screws; and then tighten the screws until the PL unit is securely fixed. The torque should be 1.0 to 1.2N•m.

Ex.: Horizontal mounting

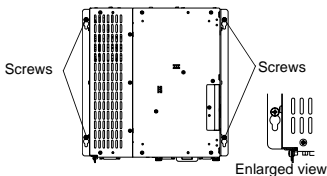

IMPORTANT

- Tightening the screws with too much force can damage the PL unit.
- Be sure to insert installation fasteners in the recessed portion of an installation fasteners hole. If the fasteners are not correctly attached, the PL unit may shift or fall out of the panel.

Wiring

⚠ WARNING

- To avoid an electric shock, prior to connecting the PL unit's power cord terminals to the power terminal block, confirm that the PL unit's power supply is completely turned OFF via a breaker or similar unit.
- Any other power level can damage both the PL and the power supply.
- Since DC type has no power ON/OFF switch, be sure to attach a breaker-type switch to its power cord.
- When the FG terminal is connected, be sure the wire is grounded.

■ Power Connector

The following parts are used in the power connector (plug).

	Accompanying Power Connector	Shape
AC type	CA7-ACCNL-01 of Pro-face	Straight Spring
	FKC2,5/3-STF-5,08 of Phoenix Contact	
DC type	CA7-DCCNL-01 of Pro-face	
	GFKC 2,5/3-STF-7,62 of Phoenix Contact	

When PL is mounted vertically, a right-angle power connector is recommended. Use the following right-angle power connectors.

	Optional Power Connector	Shape
AC type	CA7-ACCNLR-01 of Pro-face	Right-angle Spring
	FKCVR 2,5/3-STF-5,08 of Phoenix Contact	
DC type	CA5-DCCNL-01 of Pro-face	Right-angle Screw
	GMVSTBW 2,5/3-STF-7,62 of Phoenix Contact	

1. Wiring power cords with a spring-type power connector

IMPORTANT

- When the FG terminal is connected, be sure the wire is grounded. Not grounding the PL unit will result in excessive noise. Use your country's applicable standard for grounding.

■ Power Cord Specifications

Use copper conductors only.

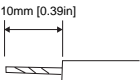
Power Cord Diameter	0.75 to 2.5mm ² (18 - 12 AWG)
Conductor Type	Simple or Stranded Wire ^{*1}
Conductor Length	10mm [0.39in] 

*1 If the Conductor's end (individual) wires are not twisted correctly, the end wires may either short against each other, or against an electrode.

■ Wiring

When connecting the power cord, use the following items when performing wiring.
(Items are made by Phoenix Contact.)

Recommended Driver	SZS 0.6x3.5 (1205053)
Recommended Pin Terminals	AI 0.75-10GY (3201288) AI 1-10RD (3200182) AI 1.5-10BK (3200195) AI 2.5-12BU (3200962)
Recommended Pin Terminal Crimp Tool	CRIMPFOX ZA3 (1201882)

■ Connecting the Power Cord

- Confirm that the power is not supplied to the PL unit.
- Push the Opening button with a small slot screw driver to open the desired pin hole.
- Insert each pin terminal into its each hole. Release the Opening button to clamp the pin place.

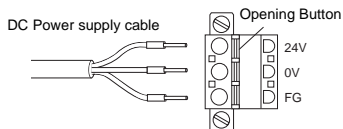
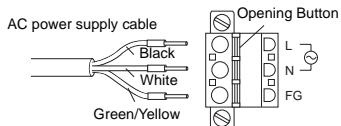

- After inserting all three pins, insert the Power Plug into the Power Connector at PL. Fix the plug with two minus screws.

IMPORTANT

- Confirm that all wires are connected correctly.
- The torque required to tighten these screws is 0.5 to 0.6 N•m.
- To prevent the possibility of a terminal short, use a pin terminal that has an insulating sleeve.

2. Wiring power cords with a screw-type power connector

IMPORTANT

- When the FG terminal is connected, be sure the wire is grounded. Not grounding the PL unit will result in excessive noise. Use your country's applicable standard for grounding.

■ Power Cord Specifications

Use copper conductors only.

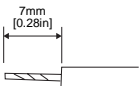
Power Cord Diameter	0.75 to 2.5mm ² (18 - 12 AWG)
Conductor Type	Simple or Stranded Wire ^{*1}
Conductor Length	7mm [0.28in] 

*1 If the Conductor's end (individual) wires are not twisted correctly, the end wires may either short against each other, or against an electrode.

■ Power Connector (Right-angle Screw) Specifications

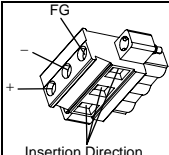
	+	24V
	-	0V
	FG	Grounding Terminal connected to the PL chassis

■ Wiring

When connecting the power cord, use the following items when performing wiring. (Items are made by Phoenix Contact.)

Recommended Driver	SZF 1-0.6x3.5 (1204517)
Recommended Pin Terminals	AI 0.75-8GY (3200519) AI 1-8RD (3200030) AI 1.5-8BK (3200043) AI 2.5-8BU (3200522)
Recommended Pin Terminal Crimp Tool	CRIMPFOX ZA 3 (1201882)

■ Connecting the PL Power Cord

- (1) Confirm that the power is not supplied to the PL unit.
- (2) Loosen three screws in the center of the Power Connector (plug).
- (3) Strip the power cord, twist the conductor's wire ends, insert them into the pin terminal and crimp the terminal. Attach the terminal to the Power Connector.

IMPORTANT

- Use a flat-blade screwdriver (Size 0.6 x 3.5) to tighten the terminal screws. The torque required to tighten these screws is 0.5 to 0.6 N•m.

- Do not solder the cable connection.

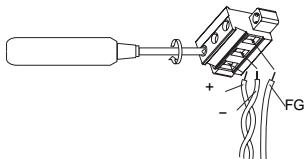

- (4) Attach the Power Connector (plug) to the PL and fix it to the PL main unit with right/left tightening screws.

3. Power Supply Cautions

- Input and Output signal lines must be separated from the power control cables for operational circuits.
- To improve the noise resistance, be sure to twist the ends of the power cord wires before connecting them to the Power connector (Plug).
- The PL unit's power supply cord should not be bundled with or kept close to main circuit lines (high voltage, high current), or input/output signal lines.
- To reduce noise, make the power cord as short as possible.
- If the supplied voltage exceeds the PL unit's range, connect a voltage transformer.
- Between the line and ground, select a power supply that is low in noise. If there is an excess amount of noise, connect an insulating transformer.
- The temperature rating of field installed conductors: 75°C only.

IMPORTANT

- Use constant voltage and insulating transformers with capacities exceeding Power Consumption value.
- Branch Circuit Protective device shall be use for rating 20A for DC24V input device.
- Connect a surge absorber to handle power surges.

IMPORTANT

- Be sure to ground the surge absorber (E1) separately from the PL unit (E2). Select a surge absorber that has a maximum circuit voltage greater than that of the peak voltage of the power supply.

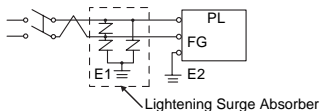

4. Grounding Cautions

- Be sure to create an exclusive ground for the Power Cord's FG terminal. Use a grounding resistance of 100Ω , a wire of 2mm^2 or thicker, or your country's applicable standard.
- The SG (signal ground) and FG (frame ground) terminals are connected internally in the PL unit. When connecting the SG line to another device, be sure that the design of the system/connection does not produce a shorting loop.
- The grounding wire should have a cross sectional area greater than 2mm^2 . Create the connection point as close to the PL unit as possible, and make the wire as short as possible. When using a long grounding wire, replace the thin wire with a thicker wire, and place it in a duct.

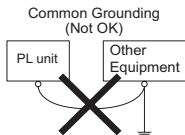
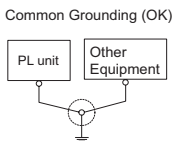
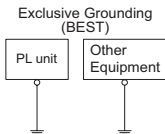

5. Input/Output Signal Line Cautions

- All PL Input and Output signal lines must be separated from all operating circuit (power) cables.
- If this is not possible, use a shielded cable and ground the shield.
- To improve noise immunity, it is recommended to attach a ferrite core to the power cord.

Attaching the Power Switch cover

For the AC type to conform to ANSI/ISA standards, the Power Switch cover needs to be attached to the main unit.

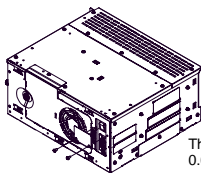

The torque is 0.5 to 0.6N•m.

Connecting USB Cable Clamp

■ Attaching the USB Cable Clamp

- (1) Place the PL unit face-down on a flat surface as shown below. Your PL unit has four USB connectors.

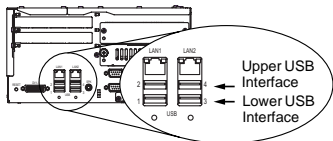

NOTE

- When using two or more USB ports, be sure to first connect one USB cable to the lower USB connector, and then connect the second USB cable to the upper USB connector.
 - When using only one of the USB ports, be sure to use the lower USB connector. This allows you to securely clamp the USB cable in the cable clamp.
- (2) Fix the USB holder with two screws. The torque required to tighten these screws is 0.5 to 0.6 N•m.

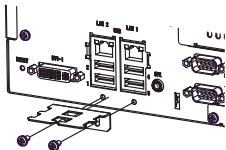

- (3) As the figure shows, pass the USB Cable Clamp's band around the depressed surface of the holder, twist the USB Cable Clamp's band around the USB cable, pull the band in the direction of the arrow, and then fasten the band using the clamp.

NOTE

- Be sure the clamp is securely holding the USB cable's plug and collar.
- Be sure the clamp is positioned as shown in the following image, with the clamp

pointing upwards - not to the side. This is to keep the clamp from interfering with nearby connectors and their cables.

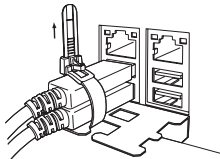

■ Removing the USB Cable Clamp

- (1) To remove the clamp from the USB cables, push down on the clamp strap's clip to release it while pulling up on the clamp.

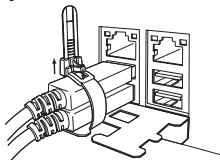

Installation prerequisites for standards

For the detailed certification's information, refer to the Pro-face Home page.

<Cautions>

Be aware of the following items when building the PL into an end-use product:

- The PL unit is approved as an open-type unit.
- Install the PL unit on a flat surface. Create space between the PL unit, the structure that the PL unit is attached to and immediate parts according to the mounting conditions. The temperature must be checked on the final product in which the PL is installed.

<Hazardous Locations - Compliance and Handling Cautions>

- Suitable for use in Class I, Division 2, Groups A, B, C, and D Hazardous Locations only.
- **WARNING:** Explosion hazard - substitution of components may impair suitability for Class I, Division 2.
- **WARNING:** Explosion hazard - do not disconnect equipment while the circuit is live or unless the area is known to be free of ignitable concentrations.
- **WARNING:** Explosion hazard - when using the PL with the AC type power supply, be sure to attach the Power Switch Cover.

CE Marking

- APL3000-BA units are CE marked, EMC directives and Low Voltage Directive compliant products.
- APL3000-BD is a CE marked, EMC Directive compatible product.

For the detailed information, be downloaded and refer the Declaration of Conformity from Pro-face Home Page.

Inquiry

Do you have any questions or comments about this product? Please access our site anytime you need help with a solution.

<http://www.pro-face.com/otasuke/>

Note

Please be aware that Digital Electronics Corporation shall not be held liable by the user for any damages, losses, or third party claims arising from the uses of this product.

Digital Electronics Corporation
8-2-52 Nanko-higashi
Suminoe-ku, Osaka 559-0031
JAPAN
TEL: +81-(0)6-6613-3116
FAX: +81-(0)6-6613-5888
<http://www.pro-face.com/>

The information in this document is subject to change without notice.

© Copyright 2007 Digital Electronics Corporation. All rights reserved.
PFX105918A .PL3000B-MT05E-BTH
2012.3 JM/D