

**Pro-face**

by **Schneider** Electric

# PE4000B Series User Manual

---

The information provided in this documentation contains general descriptions and/or technical characteristics of the performance of the products contained herein. This documentation is not intended as a substitute for and is not to be used for determining suitability or reliability of these products for specific user applications. It is the duty of any such user or integrator to perform the appropriate and complete risk analysis, evaluation and testing of the products with respect to the relevant specific application or use thereof. Neither Schneider Electric nor any of its affiliates or subsidiaries (hereinafter, referred to as Schneider Electric) shall be responsible or liable for misuse of the information that is contained herein. If you have any suggestions for improvements or amendments or have found errors in this publication, please notify us.

You agree not to reproduce, other than for your own personal, noncommercial use, all or part of this document on any medium whatsoever without permission of Schneider Electric, given in writing. You also agree not to establish any hypertext links to this document or its content. Schneider Electric does not grant any right or license for the personal and noncommercial use of the document or its content, except for a non-exclusive license to consult it on an "as is" basis, at your own risk. All other rights are reserved.

All pertinent state, regional, and local safety regulations must be observed when installing and using this product. For reasons of safety and to help ensure compliance with documented system data, only the manufacturer should perform repairs to components.

When devices are used for applications with technical safety requirements, the relevant instructions must be followed.

Failure to use Schneider Electric software or approved software with our hardware products may result in injury, harm, or improper operating results.

Failure to observe this information can result in injury or equipment damage.

Copyright © 2018 Schneider Electric Japan Holdings Ltd. All Rights Reserved.



# Table of Contents

	<b>Safety Information</b> .....	<b>5</b>
	<b>About the Book.</b> .....	<b>7</b>
<b>Part I</b>	<b>General Overview</b> .....	<b>11</b>
<b>Chapter 1</b>	<b>Important Information</b> .....	<b>13</b>
	Federal Communications Commission Radio Frequency Interference Statement - For U.S.A. ....	<b>14</b>
	Qualified Personnel .....	<b>15</b>
	Certifications and Standards .....	<b>16</b>
<b>Chapter 2</b>	<b>Physical Overview</b> .....	<b>19</b>
	PE-B Atom N2600 Models Package Contents .....	<b>20</b>
	PE-B Atom N270 Models Package Contents .....	<b>21</b>
	PE-B Atom N2600 Models Description .....	<b>22</b>
	PE-B Atom N270 Models Description .....	<b>24</b>
<b>Chapter 3</b>	<b>Characteristics</b> .....	<b>25</b>
	Characteristics of the PE-B .....	<b>26</b>
	Environmental Characteristics .....	<b>28</b>
<b>Chapter 4</b>	<b>Dimensions/Assembly</b> .....	<b>29</b>
	Dimensions .....	<b>30</b>
	PE-B Mounting .....	<b>31</b>
	Preparing to Install the PE-B .....	<b>33</b>
<b>Part II</b>	<b>Implementation</b> .....	<b>35</b>
<b>Chapter 5</b>	<b>Getting Started</b> .....	<b>37</b>
	First Power up .....	<b>37</b>
<b>Chapter 6</b>	<b>PE-B Connections</b> .....	<b>39</b>
	Grounding .....	<b>40</b>
	Connecting the DC Power Cord .....	<b>43</b>
	PE-B Atom N2600 Models Interface Connections. ....	<b>45</b>
	PE-B Atom N270 Models Interface Connections. ....	<b>48</b>
<b>Chapter 7</b>	<b>PE-B Configuration of the BIOS</b> .....	<b>51</b>
7.1	BIOS Options PE-B Atom N2600 Models and Atom N270 Models ...	<b>52</b>
	BIOS Options .....	<b>52</b>
7.2	BIOS PE-B Atom N2600 Models .....	<b>54</b>
	<b>Main Menu</b> .....	<b>55</b>
	<b>Advanced Menu</b> .....	<b>56</b>
	<b>Chipset Menu</b> .....	<b>59</b>
	<b>Boot Menu</b> .....	<b>60</b>
	<b>Save &amp; Exit Menu</b> .....	<b>60</b>
7.3	BIOS PE-B Atom N270 Models .....	<b>61</b>
	<b>Main Menu</b> .....	<b>62</b>
	<b>BIOS Menu</b> .....	<b>63</b>

---

<b>Chapter 8</b>	<b>Hardware Modifications</b> . . . . .	<b>65</b>
	Before Modifications . . . . .	<b>66</b>
	SSD Drive Description and Installation for PE-B Atom N2600 Models . . . . .	<b>67</b>
	CFast Card Installation for PE-B Atom N2600 Models . . . . .	<b>70</b>
	Compact Flash Card Installation for PE-B Atom N270 Models . . . . .	<b>72</b>
<b>Part III</b>	<b>Installation</b> . . . . .	<b>75</b>
<b>Chapter 9</b>	<b>System Monitor</b> . . . . .	<b>77</b>
	System Monitor Interface . . . . .	<b>78</b>
	Using <b>System Monitor</b> . . . . .	<b>82</b>
	Using <b>Remote Monitoring</b> . . . . .	<b>85</b>
	Using <b>Notification Center</b> . . . . .	<b>88</b>
<b>Chapter 10</b>	<b>Maintenance</b> . . . . .	<b>89</b>
	Reinstallation Procedure . . . . .	<b>90</b>
	Regular Cleaning and Maintenance . . . . .	<b>91</b>
<b>Appendices</b>	. . . . .	<b>93</b>
<b>Appendix A</b>	<b>Accessories</b> . . . . .	<b>95</b>
	Accessories for the PE-B. . . . .	<b>96</b>
	Mounting Jumper of The PE-B Atom N270 Models. . . . .	<b>96</b>
	<b>After-sales service</b> . . . . .	<b>99</b>

# Safety Information



## Important Information

### NOTICE

Read these instructions carefully, and look at the equipment to become familiar with the device before trying to install, operate, or maintain it. The following special messages may appear throughout this documentation or on the equipment to warn of potential hazards or to call attention to information that clarifies or simplifies a procedure.



The addition of this symbol to a “Danger” or “Warning” safety label indicates that an electrical hazard exists which will result in personal injury if the instructions are not followed.



This is the safety alert symbol. It is used to alert you to potential personal injury hazards. Obey all safety messages that follow this symbol to avoid possible injury or death.

## DANGER

**DANGER** indicates a hazardous situation which, if not avoided, **will result in** death or serious injury.

## WARNING

**WARNING** indicates a hazardous situation which, if not avoided, **could result in** death or serious injury.

## CAUTION

**CAUTION** indicates a hazardous situation which, if not avoided, **could result in** minor or moderate injury.

## NOTICE

**NOTICE** is used to address practices not related to physical injury.

### PLEASE NOTE

Electrical equipment should be installed, operated, serviced, and maintained only by qualified personnel. No responsibility is assumed by Schneider Electric for any consequences arising out of the use of this material.

A qualified person is one who has skills and knowledge related to the construction and operation of electrical equipment and its installation, and has received safety training to recognize and avoid the hazards involved.



# About the Book



## At a Glance

### Document Scope

This manual describes the configuration and usage of the PE4000B Series (hereafter referred to as the "PE-B").

The PE-B is designed to operate in an industrial environment.

**NOTE:** On Atom N2600 models the dual display is not supported under Windows® Embedded Standard 2009.

The table is a legend that identifies the features corresponding to each character of the part number:

Character Number	Prefix	1	2	3	4	5	6	7	8	9
Part Number Example	PFXPE	B	A	D	2	2	B	N	*	*
PC family	PE-B	B								
PC type	Atom N270		A							
	Atom N2600		B							
Power	DC			D						
RAM	2GB				2					
	4GB				4					
Operating system	None					0				
	Windows® Embedded Standard 2009					1				
	Windows® Embedded Standard 7					2				
Storage device	None						N			
	CF 8GB (Atom N270 models)						A			
	CFast 8GB (Atom N2600 models)						B			
	CFast 16GB (Atom N2600 models)						C			
	SSD						D			
Options	None							N		
Reserved	None								*	*

**NOTE:** All instructions applicable to the enclosed product and all safety precautions must be observed.

### Validity Note

This documentation is valid for PE4000B Series.

The technical characteristics of the devices described in this document also appear online. To access this information online, please go to our website <http://www.pro-face.com/otasuke/>

The characteristics that are presented in this manual should be the same as those characteristics that appear online. In line with our policy of constant improvement, we may revise content over time to improve clarity and accuracy. If you see a difference between the manual and online information, use the online information as your reference.

---

## Registered trademarks

Microsoft® and Windows® are registered trademarks of Microsoft corporation.

Intel® is a registered trademark of Intel corporation.

Product names used in this manual may be the registered trademarks owned by the respective proprietors.

The following terms differ from the abovementioned trade names and trademarks.

Term used in this manual	Formal Trademark or Tradename
Windows Embedded Standard 2009	Windows® Embedded Standard 2009 (32 bit)
Windows Embedded Standard 7	Windows® Embedded Standard 7 (32 bit)
Atom N2600	Intel® Atom™ Dual Core N2600
Atom N270	Intel® Atom™ N270

## Related Documents

Title of Documentation
PE4000B Series User Manual (this manual)

You can download these technical publications and other technical information from our website at <http://www.pro-face.com/otasuke/>.

## Global Code

A global code is assigned to every Pro-face product as a universal reference. For more information on product models and their matching global codes, please refer to the following URL.

URL: <http://www.pro-face.com/product/globalcode.html>

## Product Related Information

Observe the following:

 <b>DANGER</b>
<b>RISK OF EXPLOSION IN HAZARDOUS LOCATION</b>
Do not use this product in hazardous location.
<b>Failure to follow these instructions will result in death or serious injury.</b>



## DANGER

### HAZARD OF ELECTRIC SHOCK, EXPLOSION OR ARC FLASH

- Remove all power from the device before removing any covers or elements of the system, and prior to installing or removing any accessories, hardware, or cables.
- Unplug the power cable from both the PE-B and the power supply.
- Always use a properly rated voltage sensing device to confirm power is off.
- Replace and secure all covers or elements of the system before applying power to the unit.
- Use only the specified voltage when operating the PE-B. The DC unit is designed to use 24 Vdc.

**Failure to follow these instructions will result in death or serious injury.**

## WARNING

### LOSS OF CONTROL

- The designer of any control scheme must consider the potential failure modes of control paths and, for certain critical control functions, provide a means to achieve a safe state during and after a path failure. Examples of critical control functions are emergency stop and overtravel stop.
- Separate or redundant control paths must be provided for critical control functions.
- System control paths may include communication links. Consideration must be given to the implications of unanticipated transmission delays or failures of the link.<sup>(1)</sup>
- Each implementation of a PE-B must be individually and thoroughly tested for proper operation before being placed into service.

**Failure to follow these instructions can result in death, serious injury, or equipment damage.**

<sup>(1)</sup> For additional information, refer to *NEMA ICS 1.1 (latest edition), "Safety Guidelines for the Application, Installation, and Maintenance of Solid State Control"* and to *NEMA ICS 7.1 (latest edition), "Safety Standards for Construction and Guide for Selection, Installation and Operation of Adjustable-Speed Drive Systems"* or other applicable standards in your location.

**NOTE:** The PE-B is a highly configurable device and is not based on a real-time operating system. Changes to the software and settings of the following must be considered new implementations as discussed in the previous warning messages. Examples of such changes include:

- System BIOS
- System Monitor
- Operating system
- Installed hardware
- Installed software

## WARNING

### UNINTENDED EQUIPMENT OPERATION

Use only Pro-face software with the devices described in this manual.

**Failure to follow these instructions can result in death, serious injury, or equipment damage.**

---

---

# Part I

## General Overview

---

### Subject of this Part

This part provides an overview of the PE-B.

### What Is in This Part?

This part contains the following chapters:

Chapter	Chapter Name	Page
1	Important Information	13
2	Physical Overview	19
3	Characteristics	25
4	Dimensions/Assembly	29



---

# Chapter 1

## Important Information

---

### General

This chapter describes specific aspects of the operation of the PE-B.

### What Is in This Chapter?

This chapter contains the following topics:

Topic	Page
Federal Communications Commission Radio Frequency Interference Statement - For U.S.A.	14
Qualified Personnel	15
Certifications and Standards	16

## **Federal Communications Commission Radio Frequency Interference Statement - For U.S.A.**

### **FCC Radio Interference Information**

This equipment has been tested and found to comply with the Federal Communications Commission (FCC) limits for a Class A digital device, pursuant to Part 15 of the FCC Rules. These limits are designed to provide reasonable protection against harmful interference in a commercial, industrial or business environment. This equipment generates, uses, and can radiate radio frequency energy and, if not installed and used in accordance with the instructions, may cause or be subject to interference with radio communications. To minimize the possibility of electromagnetic interference in your application, observe the following two rules:

- Install and operate the PE-B in such a manner that it does not radiate sufficient electromagnetic energy to cause interference in nearby devices.
- Install and test the PE-B to ensure that the electromagnetic energy generated by nearby devices does not interfere with the PE-B's operation.

### **WARNING**

#### **ELECTROMAGNETIC / INTERFERENCE**

Electromagnetic radiation may disrupt the PE-B's operations, leading to unintended equipment operation. If electromagnetic interference is detected:

- Increase the distance between the PE-B and the interfering equipment.
- Reorient the PE-B and the interfering equipment.
- Reroute power and communication lines to the PE-B and the interfering equipment.
- Connect the PE-B and the interfering equipment to different power supplies.
- Always use shielded cables when connecting the PE-B to a peripheral device or another computer.

**Failure to follow these instructions can result in death, serious injury, or equipment damage.**

## Qualified Personnel

### General

Only qualified personnel can install, operate, and maintain the product. A qualified person is one who has skills and knowledge related to the construction, operation, and installation of electrical equipment, and has received safety training to recognize and avoid the hazards involved. Refer to the most current release of NFPA 70E®, Standard for Electrical Safety in the Workplace, for electrical safety training requirements or other applicable standards in your location. Examples of qualified personnel may include:

- at the application design level, engineering department personnel who are familiar with automation safety concepts (for example, a design engineer)
- at the equipment implementation level, personnel who are familiar with the installation, connection and commissioning of automation equipment (for example, an installation assembly or cabling engineer or a commissioning technician)
- at the operation level, personnel who are experienced in the use and control of automation and computing equipment (for example, an operator)
- for preventive or corrective maintenance, personnel trained and qualified in regulating or repairing automated and computing devices (for example, an operating technician or after-sales service technician)

## Certifications and Standards

### Agency Certifications

Schneider Electric submitted this product for independent testing and qualification by third-party agencies. These agencies have certified this product as meeting the following standards:

- Underwriters Laboratories Inc., UL 60950-1, 2nd Edition, and CSA C22.2 N°60950-1-07, Information Technology Equipment.
- GOST-R or EAC Eurasian Conformity. Please refer to product markings.
- CCC China Compulsory Product Certification. Please refer to product markings.

For information on certifications and standards, such as certified models and certificates, see product markings or the following:

<http://www.pro-face.com/worldwide.html>

### Compliance Standards

Schneider Electric tested this product for compliance with the following compulsory standards:

United States:

- Federal Communications Commission, FCC Part 15

Europe: CE

- Directive 2006/95/EC (Low Voltage)
- Directive 2004/108/EC (EMC)
- EMI: EN55011 (Group 1, Class A), EN 61000-6-4
- Information Technology Equipment: EN 60950-1
- EMS: EN 61000-6-2

Taiwan: BSMI

Korea: KC Markings

### Qualification Standards

Schneider Electric voluntarily tested this product to additional standards. The additional tests performed, and the standards under which the tests were conducted, are specifically identified in Environmental Characteristics (*see page 28*).

### Hazardous Substances

This product is compliant with:

- WEEE, Directive 2012/19/EU
- RoHS, Directive 2011/65/EU
- RoHS China, Standard SJ/T 11364
- REACH regulation EC 1907/2006

### End of Life (WEEE)

The product contains electronic boards. It must be disposed of in specific treatment channels. The product contains cells and/or storage batteries which must be collected and processed separately, when they have run out and at the end of product life.

These batteries do not contain a weight percentage of heavy metals over the threshold notified by European Directive 2006/66/EC.



## KC Markings

사용자안내문

기종별	사용자안내문
A급 기기 (업무용 방송통신기자재)	이 기기는 업무용(A급) 전자파적합기기로서 판매자 또는 사용자는 이 점을 주의하시기 바라며, 가정외의 지역에서 사용하는 것을 목적으로 합니다.

## BSMI RoHS

設備名稱： 電腦      型號（型式）： PFXPEBAD20NNN1 ; PFXPEBAD21ANN1						
Equipment name      Type designation (Type)						
單元Unit	限用物質及其化學符號 Restricted substances and its chemical symbols					
	鉛 Lead (Pb)	汞 Mercury (Hg)	鎘 Cadmium (Cd)	六價鉻 Hexavalent chromium (Cr <sup>+6</sup> )	多溴聯苯 Polybrominated biphenyls (PBB)	多溴二苯醚 Polybrominated diphenyl ethers (PBDE)
電路板	—	○	○	○	○	○
存儲模組	—	○	○	○	○	○
記憶卡	—	○	○	○	○	○
線材	○	○	○	○	○	○
內外殼	○	○	○	○	○	○
其它固定 組件 (螺絲)	—	○	○	○	○	○
<p>備考1. “超出0.1 wt %”及“超出0.01 wt %”係指限用物質之百分比含量超出百分比含量基準值。            Note 1: “Exceeding 0.1 wt %” and “exceeding 0.01 wt %” indicate that the percentage content of the restricted substance exceeds the reference percentage value of presence condition.</p> <p>備考2. “○”係指該項限用物質之百分比含量未超出百分比含量基準值。            Note 2: “○” indicates that the percentage content of the restricted substance does not exceed the percentage of reference value of presence.</p> <p>備考3. “—”係指該項限用物質為排除項目。            Note 3: The “—” indicates that the restricted substance corresponds to the exemption.</p>						



---

# Chapter 2

## Physical Overview

---

### Subject of this Chapter

This chapter provides a physical overview of the PE-B.

### What Is in This Chapter?

This chapter contains the following topics:

Topic	Page
PE-B Atom N2600 Models Package Contents	20
PE-B Atom N270 Models Package Contents	21
PE-B Atom N2600 Models Description	22
PE-B Atom N270 Models Description	24

## PE-B Atom N2600 Models Package Contents

### Items

The items are included in the PE-B package. Before using the PE-B, confirm that all items listed here are present:

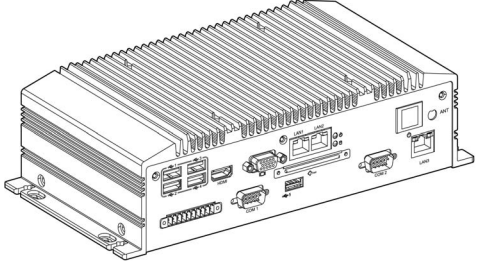
Atom N2600 model	
Screw 4 pieces (D= 5, H= 1.1, M3x4) (included only for the Atom N2600 model without OS)	
Recovery DVD-ROM (not included for the Atom N2600 model without OS)	
PE4000B Series Installation Guide	
Warning/Caution Information	
Acronis license EULA document	
China RoHS	
Simplified Chinese user manual	
Power supply connector and Digital I/O connector	

This unit has been carefully packed, with special attention to quality. However, should you find anything damaged or missing, contact your local distributor immediately.

## PE-B Atom N270 Models Package Contents

### Items

The items are included in the PE-B package. Before using the PE-B, confirm that all items listed here are present:

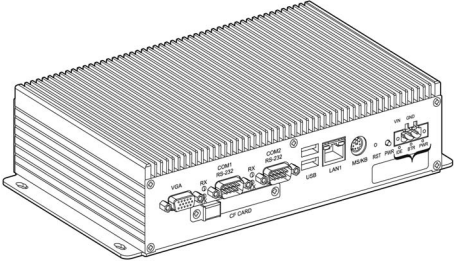
Atom N270 model	
Screw 4 pieces (D= 5, H= 1.1, M3x4)	
Mini jumper 2 pin 2 mm 10 pieces	
Cable M-DIN 6 pin(M)/M-DIN 6 pin(F)x2 L= 200 mm	
Cable SATA 15 pin/8 pin L= 150 mm	
Cable SATA 7 pin/SATA 7 pin L=130 mm	
Recovery DVD-ROM (not included for the Atom N270 model without OS)	
PE4000B Series Installation Guide	
Warning/Caution Information	
Acronis license EULA document	
China RoHS	
Simplified Chinese user manual	
Power supply connector	

This unit has been carefully packed, with special attention to quality. However, should you find anything damaged or missing, contact your local distributor immediately.

## PE-B Atom N2600 Models Description

### Introduction

The following PE-B - description shows the LEDs, the buttons, the connectors and the input power supply.

During operation, surface temperatures of the heat sink may reach more than 70 °C (158 °F).

## **⚠ WARNING**

### **RISK OF BURNS**

Do not touch the surface of the heat sink during operation.

**Failure to follow these instructions can result in death, serious injury, or equipment damage.**

### Atom N2600 Models Front View

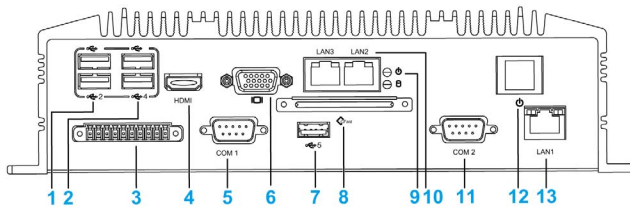

- 1 USB1 and USB2
- 2 USB3 and USB4
- 3 Digital I/O
- 4 HDMI
- 5 COM1
- 6 VGA
- 7 USB5
- 8 CFast memory card
- 9 LEDs
- 10 LAN3 and LAN2
- 11 COM2
- 12 Power switch
- 13 LAN1

### NOTE:

There are 2 LEDs for indicating system status:

- PWR LED is for power status.
- SSD LED is for SSD & CFast disk status.

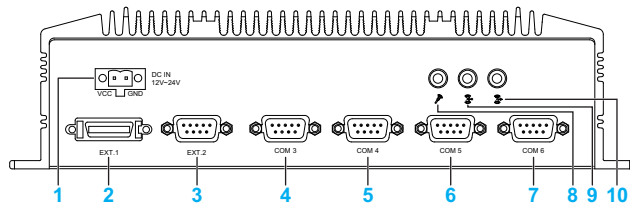
**Atom N2600 Models Rear View**

- 1 DC INPUT
- 2 EXT.1 (not used)
- 3 EXT.2 (not used)
- 4 COM3
- 5 COM4
- 6 COM5
- 7 COM6
- 8 MIC
- 9 LIN-IN
- 10 LINE-OUT

## PE-B Atom N270 Models Description

### Introduction

The following PE-B - description shows the LEDs, the buttons, the connectors and the input power supply.

During operation, surface temperatures of the heat sink may reach more than 70 °C (158 °F).

## ⚠ WARNING

### RISK OF BURNS

Do not touch the surface of the heat sink during operation.

**Failure to follow these instructions can result in death, serious injury, or equipment damage.**

### Atom N270 Models Front View

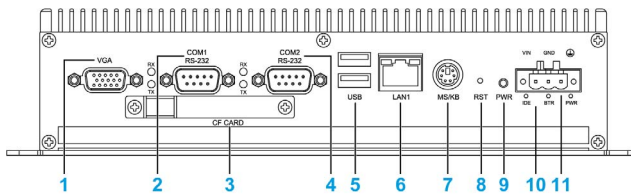

- 1 VGA
- 2 COM1 and LEDs (Rx/Tx)
- 3 Compact Flash memory card
- 4 COM2 and LEDs (Rx/Tx)
- 5 USB1 USB2
- 6 LAN1
- 7 Keyboard and mouse connector
- 8 Reset button
- 9 Power button
- 10 LEDs
- 11 DC input power supply

**NOTE:** Press the **PWR** button to power on or power off the PE-B. The PE-B Atom N270 models support the ACPI (Advanced Configuration and Power Interface). Besides power ON/OFF, they support multiple suspend modes, such as Power-on Suspend (S1), Suspend to RAM (S3), and Suspend to Disk (S4). In S3 and S4 suspend modes, the power consumption can be less than 2 W, which meets the Energy Star criteria.

**NOTE:** Press the **RST** button to activate the hardware reset function.

### NOTE:

There 2 LEDs indicating system status:

- IDE
- PWR

### Atom N270 Models Rear View

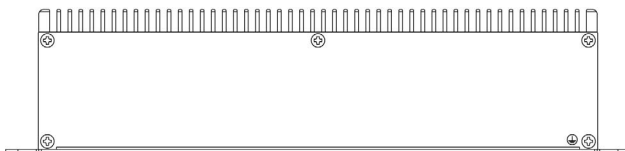



---

# Chapter 3

## Characteristics

---

### Subject of this Chapter

This chapter lists the product characteristics.

### What Is in This Chapter?

This chapter contains the following topics:

Topic	Page
Characteristics of the PE-B	26
Environmental Characteristics	28

## Characteristics of the PE-B

### Product Characteristics

The characteristics of the PE-B are given below:

Element	Characteristics	
	Atom N2600 models	Atom N270 models
Processor	Intel Atom™ Dual Core N2600 1.6 GHz	Intel Atom™ N270 1.6 GHz
Cooling method	Passive heat sink, fanless operation	
Memory	2 GB/4 GB	2 GB
Graphics		
Graphics engine	DirectX 10.1 and OpenGL 3.0 support Hardware accelerated video decode Video decoder: Support MPEG4, VC1, WMV9, H.264	Integrated 3D graphics engine, based on Intel™ GMA 950 architecture, delivers sophisticated graphics for large display applications
Interface		
Ethernet	3 x 10/100/1000 Mbits/s Intel 82583V Ethernet controller, support for Wake-on-LAN	1 x 10/100/1000 Base-T RJ45 port (Built-in boot ROM in flash BIOS)
Audio	High Definition Audio (HD) Line-in, Line out, Mic-in	No
Serial ports	2 x RS-232 ports, 4 x RS-232/422/485 port with auto flow control (by BIOS setting)	2 x RS-232 ports
USB	5 x USB 2.0	2 x USB 2.0
Digital I/O	8 bits	–
Watchdog timer	255 levels timer interval, programmable, 1...255 s	
Analog RGB (VGA)	Up to 1920 x 1200 resolution at 60 Hz	Up to 1600 x 1200 resolution at 85 Hz
HDMI	Supports 1920 x 1200 resolution, max data rate: up to 1.65 Gb/s Supports HDMI 1.3 up to 1080p	–
Storage		
SSD	Supported	Supported
CFast memory card	Supported	–
Compact Flash memory card	–	Supported
Reset button	No	Yes
Buzzer	Yes	

Element	Characteristics	
	Atom N2600 models	Atom N270 models
Power supply		
Power type	AT/ATX	ATX
Rated voltage	12...24 Vdc $\pm 5\%$	9...36 Vdc $\pm 5\%$
Rated current	12...24 Vdc, 3.0...1.5 A	24 Vdc, 1.5 A
Power consumption	Typically 16 W	Typically 15 W
Dimensions (Width x height x depth)	264.5 x 69.2 x 133 mm (10.41 x 2.72 x 5.24 in.)	254.8 x 58.7 x 149.2 mm (10.03 x 2.31 x 5.88 in.)
Weight	Approx. 2.5 kg (5.5 lbs)	Approx. 2.5 kg (5.5 lbs)

**NOTE:**

- The Atom N2600 models are intended to be supplied by a UL certified power supply or DC source rated from 12 to 24 Vdc, 3 to 1.5 A, Tma 45 °C and whose output meets SELV, non-hazardous energy level.
- The Atom N270 models are intended to be supplied by a UL certified power supply and output rated 9 to 36 Vdc, 5.0 A minimum.
- On Atom N2600 models the dual display is not supported under Windows® Embedded Standard 2009.
- I/O ports (such as serial, USB and Ethernet interfaces) on this product have internal port numbers that may differ from physical port numbers, such as "COM1", "USB1" or "ETH1", printed on the product and used for identification in this manual. Check the port numbers in your environment.

## Environmental Characteristics

### Characteristics

The environmental characteristics of the PE-B are as follows:

Characteristics	Value	Standards
Degree of protection	IP40	IEC 60529
Operating temperature	Atom N2600 models: <ul style="list-style-type: none"> <li>● 0...60 °C (32...140 °F) with air flow, speed = 0.7 m/s</li> <li>● 0...50 °C (32...122 °F)</li> </ul> Atom N270 models: <ul style="list-style-type: none"> <li>● 0...70 °C (32...158 °F) with air flow, speed = 0.7 m/s</li> <li>● 0...60 °C (32...140 °F)</li> </ul>	EN/IEC 60068-2-2
Storage temperature	-40...85 °C (-40...185 °F)	IEC 60068-2-2 IEC 60068-2-14
Operating altitude	2000 m (6560 ft) max	IEC 60664-1
Vibration	2...9 Hz: 1.75 mm (0.07 in.) 9...200 Hz: 4.9 m/s <sup>2</sup>	IEC 60068-2-6
Shock resistance (in operation)	CFast/SSD/CF: 50 G at wall mount, half sine, 11 ms	IEC 60068-2-27 Ea
Surrounding air humidity during operation	95 % RH (Wet bulb temperature: 40 °C (104 °F) max. - no condensation)	EN/IEC 60068-2-78 cab
Storage humidity	10...85 % RH (Wet bulb temperature: 29 °C (84.2 °F) max. - no condensation)	EN/IEC 60068-2-30 dB
Electromagnetic compatibility (EMC)	Immunity to High Frequency Interference	IEC 61000-4-x
	Electromagnetic Emissions Class A	EN 55022, EN 55011

**NOTE:** IP40 is not part of UL certification.

---

# Chapter 4

## Dimensions/Assembly

---

### Subject of this Chapter

This chapter describes PE-B dimensions and installation panels.

### What Is in This Chapter?

This chapter contains the following topics:

Topic	Page
Dimensions	30
PE-B Mounting	31
Preparing to Install the PE-B	33

## Dimensions

### Dimensions of the Atom N2600 Models

The illustration below shows the dimensions:

$\frac{\text{mm}}{\text{in.}}$

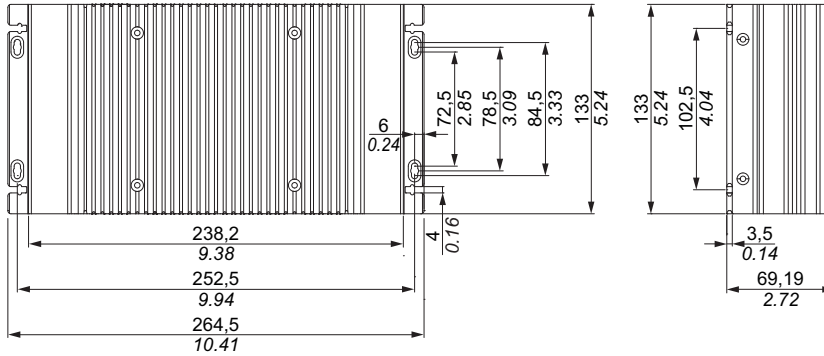

### Dimensions of the Atom N270 Models

The illustration below shows the dimensions:

$\frac{\text{mm}}{\text{in.}}$

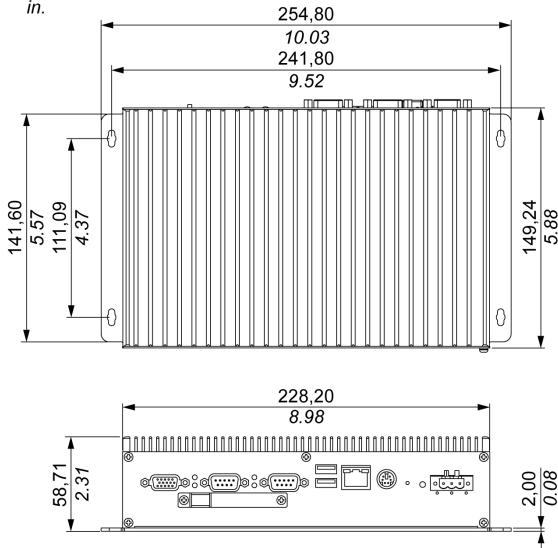

## PE-B Mounting

### Installation Location

## ⚠ WARNING

### UNINTENDED EQUIPMENT OPERATION

- Do not place the PE-B next to other devices that might cause overheating.
- Keep the PE-B away from arc-generating devices such as magnetic switches and non-fused breakers.
- Avoid using the PE-B in environments where corrosive gases are present.
- Install the PE-B in a location providing a minimum clearance of 50 mm (1.96 in.) or more on the left and right sides, and 100 mm (3.93 in.) or more above and below the product from all adjacent structures and equipment.
- Install the PE-B with sufficient clearance to provide for cable routing and cable connectors.

**Failure to follow these instructions can result in death, serious injury, or equipment damage.**

PE-B Atom N2600 models are designed to be mounted using M4 screws:

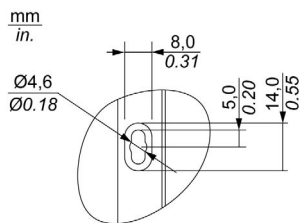

PE-B Atom N270 models are designed to be mounted using M4 screws:

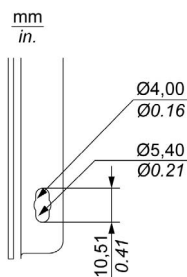

### Mounting Information

- Environmental Characteristics. (see page 28)
- The PE-B is only permitted for operation in closed rooms.
- The PE-B cannot be situated in direct sunlight.
- The PE-B vent holes must not be covered.
- When mounting the PE-B, adhere to the allowable mounting angle.
- Be sure that the wall or switching cabinet can support a minimum of 4 times the total weight of the PE-B.
- When connecting certain cable types (DVI, USB, and so on), keep the flex radius of the cable in mind.

### Mounting Angle

The PE-B unit must be mounted on a DIN-rail or desk/wall mounting.

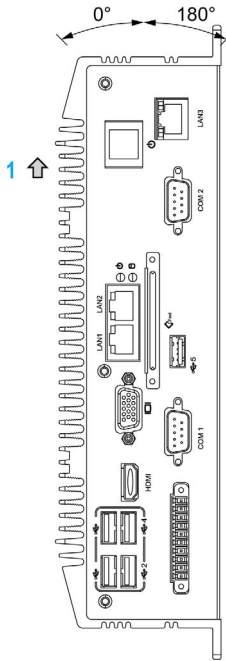

- 1 Heat sink

### Spacing for air circulation

In order to provide sufficient air circulation, mount the system so that the clearance on the top, bottom, and sides is as follows:

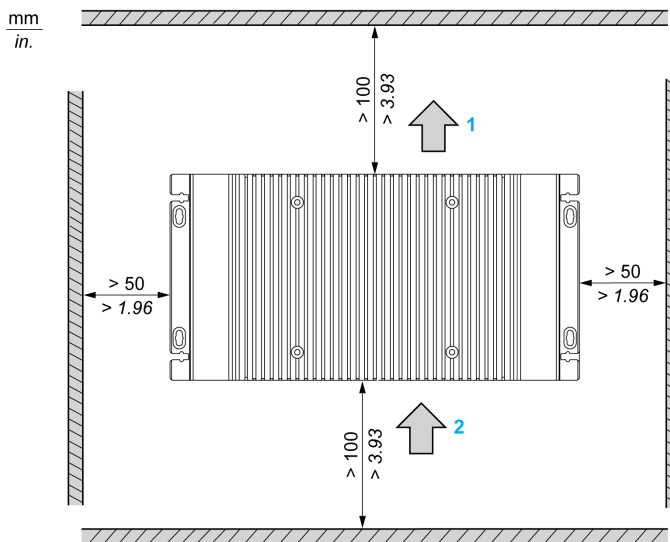

- 1 Air out
- 2 Air in



## Preparing to Install the PE-B

### Vibration and Shocks

Extra care should be taken with respect to vibration levels when installing or moving the PE-B. If the PE-B is moved, for example, while it is installed in a rack equipped with caster wheels, the unit can receive excessive shock and vibration.

### CAUTION

#### EXCESSIVE VIBRATION

- Plan your installation activities so that shock and vibration tolerances in the unit are not exceeded.
- The recommended torque for mounting the PE-B is 0.5 Nm (4.5 lb-in).

**Failure to follow these instructions can result in injury or equipment damage.**



# Part II

## Implementation

---

**Subject of this Part**

This part describes setting up the product.

**What Is in This Part?**

This part contains the following chapters:

Chapter	Chapter Name	Page
5	Getting Started	37
6	PE-B Connections	39
7	PE-B Configuration of the BIOS	51
8	Hardware Modifications	65



---

# Chapter 5

## Getting Started

---

### First Power Up

#### License Agreement

Limitations on your usage of the Microsoft Windows Operating System are noted in Microsoft's End User License Agreement (EULA). This EULA is included on the DVD-ROM. Read this document before first powering-up.

On first power-up of your PE-B, to customize and set the parameters for your system, refer to PE4000B Series Installation Guide.

#### EFW Manager (Enhanced Write Filter Manager)

The EFW Manager (Enhanced Write Filter Manager) minimizes the number of write operations to help extend the life of the memory card. It loads temporary data (for example, system updates and software operations) into RAM, and does not write this information to the memory card.

As a result, when using the EFW, restarting the PE-B causes any changes the user made to the system to be discarded. The following types of modifications may be discarded if the EFW is active and the system is restarted:

- Newly installed applications.
- Newly installed peripherals.
- Newly created or modified user accounts.
- Network configuration changes (for example, IP address, default gateway, and so on).
- Operating System customizations (for example, background pictures, and so on).

### ***NOTICE***

#### **DATA AND CONFIGURATION LOSS**

- Disable the EFW before making any permanent changes to the hardware, software, or Operating System of the PE-B.
- Re-enable the EFW after making permanent changes. This can help extend the operating life of the memory card.
- Back up all memory card data regularly to other storage media.

**Failure to follow these instructions can result in equipment damage.**

#### Enabling/Disabling the EFW

The status of the EFW Manager may be changed by running the `EFWManager.exe` program located in the `C:\Program Files\EFWManager` directory. After running `EFWManager.exe`, you need to restart the system for the change to take effect. You need Windows administrator privileges to enable and disable the EFW.



---

# Chapter 6

## PE-B Connections

---

### Subject of this Chapter

This chapter describes the connection of the PE-B to the main power supply. It also describes the USB ports and identifies the serial interface pin assignment.

### What Is in This Chapter?

This chapter contains the following topics:

Topic	Page
Grounding	40
Connecting the DC Power Cord	43
PE-B Atom N2600 Models Interface Connections	45
PE-B Atom N270 Models Interface Connections	48

## Grounding

### Overview

The grounding resistance between the PE-B ground and the ground must be 100 Ω or less. When using a long grounding wire, check the resistance and, if required, replace a thin wire with a thicker wire and place it in a duct. In addition, refer to the table below for maximum lengths of wire with the given cross-section.

### Ground Wire Dimensions

Wire Cross-section	Maximum Line Length
2.5 mm <sup>2</sup> (AWG 13)	30 m (98 ft)
	60 m (196 ft) round trip.

### Precaution

 **WARNING**

**UNINTENDED EQUIPMENT OPERATION**

- Use only the authorized grounding configurations shown below.
- Confirm that the grounding resistance is 100 Ω or less.
- Test the quality of your ground connection before applying power to the device. Excess noise on the ground line can disrupt operations of the PE-B.

**Failure to follow these instructions can result in death, serious injury, or equipment damage.**

### Dedicated Ground

Connect the PE-B Atom N270 model's ground to a dedicated ground:

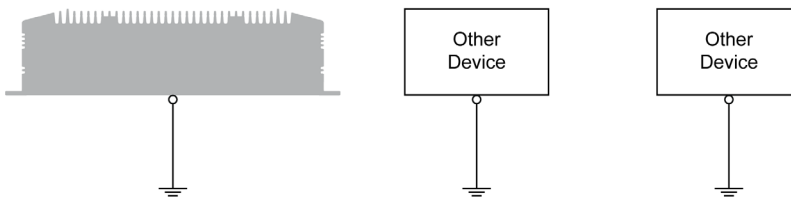

### Shared Ground Allowed

If a dedicated ground is not possible, use a shared ground, as shown below:

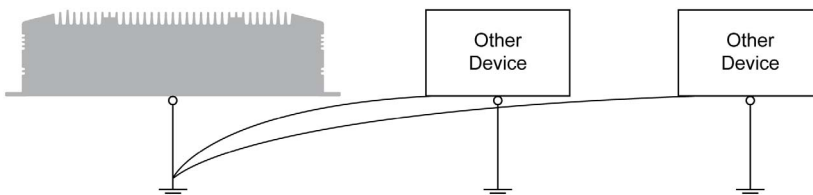



### Shared Ground not Allowed

Do not connect the PE-B to ground through other devices:

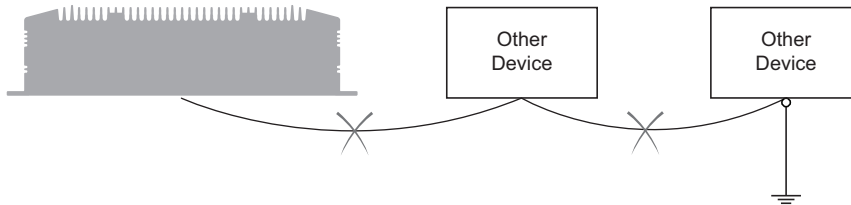

### Shared Ground - Avoid Ground Loop

When connecting an external device to a PE-B with the shield ground (SG), ensure that a ground loop is not created. The PE-B's ground connection screw and SG are connected internally.

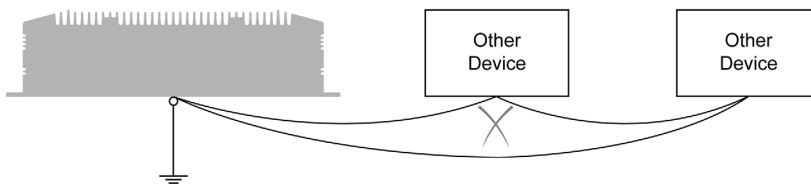

### Grounding Procedure

The PE-B Atom N270 models ground has 2 connections:

- DC supply voltage
- Ground connection pin

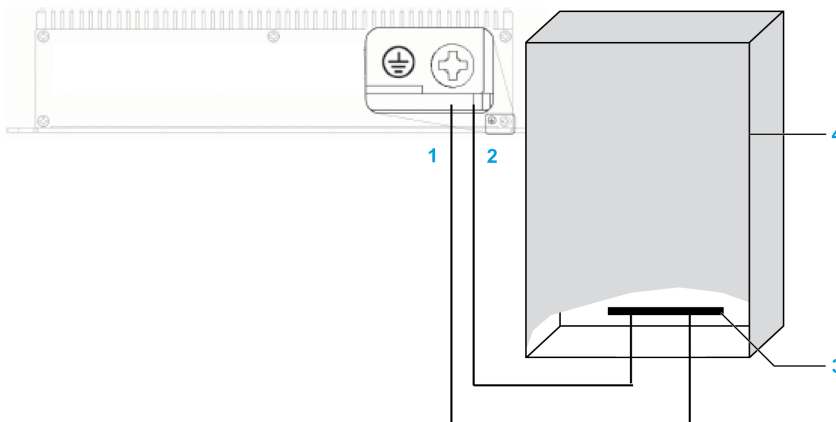

- 1 Ground connection pin (protective earth ground connection pin)
- 2 Supply voltage
- 3 Grounding strip
- 4 Switching cabinet

When grounding, follow the procedure below:

Step	Action
1	Check that the grounding resistance is 100 $\Omega$ or less.

Step	Action
2	When connecting the SG line to another device, ensure that the design of the system/connection does not produce a ground loop. <b>NOTE:</b> The SG and ground connection screw are connected internally in the PE-B.
3	Use 2.5 mm <sup>2</sup> (AWG 13) wire to make the ground connection. Create the connection point as close to the PE-B as possible and make the wire as short as possible.

### Grounding I/O Signal Lines

Electromagnetic radiation may interfere with the control communications of the PE-B.

 <b>WARNING</b>
<b>UNINTENDED EQUIPMENT OPERATION</b> <ul style="list-style-type: none"><li>● If wiring of I/O lines near power lines or radio equipment is unavoidable, use shielded cables and ground one end of the shield to the PE-B ground connection screw.</li><li>● Do not wire I/O lines in proximity to power cables, radio devices, or other equipment that may cause electromagnetic interference.</li></ul> <b>Failure to follow these instructions can result in death, serious injury, or equipment damage.</b>

## Connecting the DC Power Cord

### Precaution

When connecting the power cord to the power connector on the PE-B, first ensure that the power cord is disconnected from the DC power supply.

### DANGER

#### HAZARD OF ELECTRIC SHOCK, EXPLOSION OR ARC FLASH

- Remove all power from the device before removing any covers or elements of the system, and prior to installing or removing any accessories, hardware, or cables.
- Unplug the power cable from both the PE-B and the power supply.
- Always use a properly rated voltage sensing device to confirm power is off.
- Replace and secure all covers or elements of the system before applying power to the unit.
- Use only the specified voltage when operating the PE-B. The DC unit is designed to use 24 Vdc.

**Failure to follow these instructions will result in death or serious injury.**

### WARNING

#### EQUIPMENT DISCONNECTION OR UNINTENDED EQUIPMENT OPERATION

- Ensure that power, communication, and accessory connections do not place excessive stress on the ports. Consider the vibration environment when making this determination.
- Securely attach power, communication, and external accessory cables to the panel or cabinet.
- Use only D-sub 9 connector cables with a locking system in good condition.
- Use only commercially available USB cables.

**Failure to follow these instructions can result in death, serious injury, or equipment damage.**

### Wiring and Connecting the Terminal Block

The table describes how to connect the power cord to the DC-powered PE-B:

Step	Action
1	Remove all power from the PE-B and confirm that the DC power supply has been disconnected from its power source.

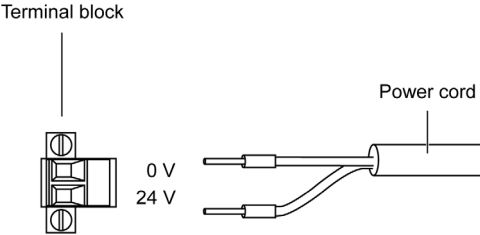
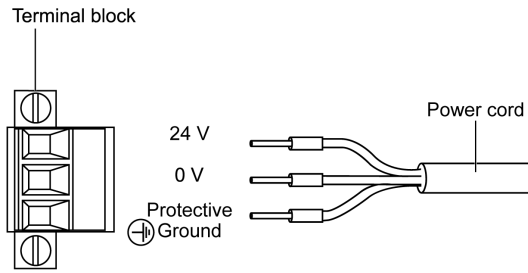
Step	Action
2	<p>Remove the terminal block from the power connector and connect the power cord to the terminal block.</p> <p>Terminal block of the Atom N2600 models:</p>  <p>Terminal block of the Atom N270 models:</p>  <p>Use 75°C (167 °F) copper wire. Use wire with cross-section 0.75...2.5 mm<sup>2</sup> (AWG 18...AWG 12).</p>
3	<p>Place the terminal block in the power connector and tighten the screws.</p> <p><b>NOTE:</b> The recommended torque to tighten these screws is 0.5 Nm (4.5 lb-in).</p>

## PE-B Atom N2600 Models Interface Connections

### Introduction

The information below describes usage of the interface connections of the PE-B.

### **WARNING**

#### **EQUIPMENT DISCONNECTION OR UNINTENDED EQUIPMENT OPERATION**

- Ensure that power, communication, and accessory connections do not place excessive stress on the ports. Consider the vibration environment when making this determination.
- Securely attach power, communication, and external accessory cables to the panel or cabinet.
- Use only D-sub 9 connector cables with a locking system in good condition.
- Use only commercially available USB cables.

**Failure to follow these instructions can result in death, serious injury, or equipment damage.**

### USB Connections

The PE-B provides USB interface connectors, which give complete plug and play and hot swapping for up to 127 external devices. The USB interface complies with USB UHCI, Rev. 2.0 compliant. The USB interface can be disabled in the system BIOS setup. The USB connectors are used to connect any device that conforms to the USB interface. Most digital devices conform to this standard.

### Serial Interface Connections

This interface is used to connect PE-B to remote equipment, via a cable. The connector is a D-sub 9 male connector.

The PE-B provides a D-sub 9 connector, which offers RS-232/422/485 serial communication interface ports.

The RS-422/485 mode of PE-B can be supported via BIOS setting. The setting is under **Advanced BIOS Features Setup** → **Super IO Configuration**.

By using a long PLC cable to connect to the PE-B, it is possible that the cable can be at a different electrical potential than the panel, even if both are connected to ground.

The PE-B serial port is not isolated. The SG (signal ground) and the protective ground (FG) terminals are connected inside the PE-B.

### **DANGER**

#### **ELECTRIC SHOCK**

- Make a direct connection between the ground connection screw and ground.
- Do not connect other devices to ground through the ground connection screw of this device.
- Install all cables according to local codes and requirements. If local codes do not require grounding, follow a reliable guide such as the US National Electrical Code, Article 800.

**Failure to follow these instructions will result in death or serious injury.**

The table below shows the D-sub 9 pin assignments:

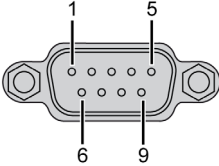
Pin	Assignment			D-sub 9 male connector:
	RS-232	RS-422	RS-485	
1	DCD	TX-	DATA-	
2	RXD	TX+	DATA+	
3	TXD	Rx+	–	
4	DTR	RX-	–	
5	GND	GND	GND	
6	DSR	–	–	
7	RTS	–	–	
8	CTS	–	–	
9	RI	–	–	

**NOTE:**

- COM1 and COM2 support only RS-232.
- Any excessive weight or stress on communication cable may disconnect the equipment.

**Ethernet Port Connector**

**NOTE:** Ethernet networks must be installed by a trained and qualified person.

One to one (1:1) connections must be made with a hub or a switch. It is possible to use the 1:1 connection with a cross cable depending on the connected PCs and network cards.

The table below describes the different Ethernet characteristics:

Characteristic	Description
Connector type	RJ45
Driver	<ul style="list-style-type: none"> <li>• 10 M half duplex (auto negotiation)</li> <li>• 100 M full duplex (auto negotiation)</li> </ul>
Cable type	Shielded
Automatic cross-over detection	Yes

**NOTE:** The PE-B supports the MDI/MDIX auto-crossover cable function. You do not have to use special Ethernet crossover cables to connect devices directly to this port (connections without an Ethernet hub or switch).

The table below describes the Ethernet status LEDs:

LED	
Color	Description
Yellow	Speed status
Green	Active/Link status

## Audio Connector

The PE-B offers stereo audio ports by 3 phone jack connectors.

The figure below shows the audio connector pin assignment:

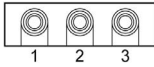

The table below describes the audio connectors:

Jack	Signal
1	Mic_In
2	Line_In
3	Line_Out

## HDMI Connector

The PE-B provides an **HDMI** (High-Definition Multimedia Interface). HDMI is a compact audio/video interface for transferring video and digital audio data. HDMI is backward compatible with single-link **Digital Visual Interface** digital video (DVI-D or DVI-I, but not DVI-A). No signal conversion is required when an interface is used, so there is no loss of video quality

## VGA Connector

The PE-B provides a high-resolution VGA interface connected by a D-sub 15 connector to support a VGA CRT monitor.

## DIO Connector

The PE-B provides one Phoenix 10-pin male connector, which offers a digital input/output communication interface.

The figure below shows the DIO connector pin assignment:

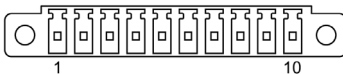

The table below describes the DIO connector pins:

Pin	Signal
1	+5 Vdc (OUT)
2	DIO0
3	DIO1
4	DIO2
5	DIO3
6	DIO4
7	DIO5
8	DIO6
9	DIO7
10	GND

**NOTE:** For details on the DIO settings, see the API manual. You can download this manual from our website at <http://www.pro-face.com/otasuke/>.

## PE-B Atom N270 Models Interface Connections

### Introduction

The information below describes usage of the interface connections of the PE-B.

**⚠ WARNING**

**EQUIPMENT DISCONNECTION OR UNINTENDED EQUIPMENT OPERATION**

- Ensure that power, communication, and accessory connections do not place excessive stress on the ports. Consider the vibration environment when making this determination.
- Securely attach power, communication, and external accessory cables to the panel or cabinet.
- Use only D-sub 9 connector cables with a locking system in good condition.
- Use only commercially available USB cables.

**Failure to follow these instructions can result in death, serious injury, or equipment damage.**

### Serial Interface Connections

This interface is used to connect PE-B to remote equipment, via a cable.

By using a long PLC cable to connect to the PE-B, it is possible that the cable can be at a different electrical potential than the panel, even if both are connected to ground.

The PE-B serial port is not isolated. The SG (signal ground) and the protective ground (FG) terminals are connected inside the PE-B.

**⚡ ⚠ DANGER**

**ELECTRIC SHOCK**

- Make a direct connection between the ground connection screw and ground.
- Do not connect other devices to ground through the ground connection screw of this device.
- Install all cables according to local codes and requirements. If local codes do not require grounding, follow a reliable guide such as the US National Electrical Code, Article 800.

**Failure to follow these instructions will result in death or serious injury.**

The table below shows the D-sub 9 COM1 and COM2 pin assignments:

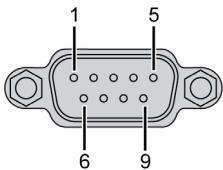
Pin	Assignment	
	RS-232	
1	DCD	D-sub 9 male connector: 
2	RXD	
3	TXD	
4	DTR	
5	GND	
6	DSR	
7	RTS	
8	CTS	
9	RI	

**NOTE:** Any excessive weight or stress on communication cables may disconnect the equipment.



## Ethernet Port Connector

**NOTE:** Ethernet networks must be installed by a trained and qualified person.

One to one (1:1) connections must be made with a hub or a switch. It is possible to use the 1:1 connection with a cross cable depending on the connected PCs and network cards.

The table below describes the different Ethernet characteristics:

Characteristic	Description
Connector type	RJ45
Driver	<ul style="list-style-type: none"> <li>10 M half duplex (auto negotiation)</li> <li>100 M full duplex (auto negotiation)</li> </ul>
Cable type	Shielded
Automatic cross-over detection	Yes

**NOTE:** The PE-B supports the MDI/MDIX auto-crossover cable function. You do not have to use special Ethernet crossover cables to connect devices directly to this port (connections without an Ethernet hub or switch).

The table below describes the Ethernet status LEDs:

LED	
Color	Description
Yellow	Speed status
Green	Active/Link status

## VGA Connector

The PE-B provides a high-resolution VGA interface connected by a D-sub 15 connector to support a VGA CRT monitor. It supports display resolutions of up to 1900 x 1200.

## PS/2 Keyboard and Mouse Connector

The PE-B provides a DIN connector.

The figure below shows the MS/KB connector pin assignment:



The table below describes the MS/KB connector pins:

Pin	Signal
1	KB DATA
2	MS DATA
3	GND
4	VCC
5	KB clock
6	MS clock



---

# Chapter 7

## PE-B Configuration of the BIOS

---

### What Is in This Chapter?

This chapter contains the following sections:

Section	Topic	Page
7.1	BIOS Options PE-B Atom N2600 Models and Atom N270 Models	52
7.2	BIOS PE-B Atom N2600 Models	54
7.3	BIOS PE-B Atom N270 Models	61

# Section 7.1

## BIOS Options PE-B Atom N2600 Models and Atom N270 Models

---

### BIOS Options

#### General Information

BIOS stands for **Basic Input Output System**. It is the most basic means of communication between the user and the hardware. The BIOS used in the PE-B is produced by Pro-face.

The **BIOS Setup Utility** lets you modify basic system configuration settings. These settings are stored in Flash ROM for the Atom N2600 models and in CMOS RAM for the Atom N270 models as a backup.

#### Entering BIOS Setup

To enter BIOS Setup, press **DEL** or **F2** key after the PE-B has been initialized.

#### BIOS Setup Keys

**NOTE:** Key input from the USB keyboard is only registered after the PE-B has been initialized.

You can use the following keys after entering the BIOS setup:

<Atom N2600 models>

Key	Function
F1	General help.
Cursor ↑	Moves to the previous item.
Cursor ↓	Goes to the next item.
Cursor ←	Moves to the previous item.
Cursor →	Goes to the next item.
±	Changes the value of the selected item.
Enter	Changes to the selected menu.
PgUp ↑	Changes to the previous page.
PgDn ↓	Changes to the next page.
F2	Returns to the previous value.
F3	Restores the default settings.
F4	Saves and closes BIOS setup.
Esc	Exits the submenu.

<Atom N270 models>

Key	Function
F1	General help.
F2	Item help.
Cursor ↑	Moves to the previous item.
Cursor ↓	Goes to the next item.

---

<b>Key</b>	<b>Function</b>
Cursor ←	Moves to the previous item.
Cursor →	Goes to the next item.
±/PgUp/PgDn	Changes the value of the selected item.
Enter	Changes to the selected menu.
F5	Returns to the previous value.
F7	Restores the default settings.
F10	Save and closes BIOS setup.
Esc	Exits the submenu.

# Section 7.2

## BIOS PE-B Atom N2600 Models

---

### Overview

This section describes the BIOS of the PE-B Atom N2600 models.

### What Is in This Section?

This section contains the following topics:

Topic	Page
<b>Main</b> Menu	55
<b>Advanced</b> Menu	56
<b>Chipset</b> Menu	59
<b>Boot</b> Menu	60
<b>Save &amp; Exit</b> Menu	60

## Main Menu

### Main Tab

When you enter the BIOS (see page 52) during startup, the PE-B **Main** BIOS setup menu appears:

This screen, like all the BIOS screens, is divided into 3 frames:

- Left  
This frame displays the options available on the screen.
- Upper right  
This frame gives a description of the user selected option.
- Lower right  
This frame displays how to move to other screens and the screen edit commands.

This table shows the **Main** menu options that can be set by the user:

BIOS Setting	Description
<b>System Time</b>	This is the current time setting. The time must be entered in HH:MM:SS format. The time is maintained by the battery (CMOS battery) when the unit is turned off.
<b>System Date</b>	This is the current date setting. The date must be entered in MM/DD/YY format. The date is maintained by the battery (CMOS battery) when the unit is turned off.

**NOTE:** The grayed-out options on all BIOS screens cannot be configured. The blue options can be configured by the user.

## Advanced Menu

### Advanced BIOS Features Tab

This tables shows the directly accessible options on the **Advanced** menu:

BIOS Setting	Description
Launch PXE OpROM	Enables or disables launch PXE OpROM, if available.
Launch Storage OpROM	Enables or disables launch storage OpROM, if available.

For details about the **Advanced** submenus, refer to:

- ACPI Settings (*see page 56*)
- Trusted Computing (*see page 56*)
- CPU Configuration (*see page 56*)
- USB Configuration (*see page 57*)
- Intel Fast Flash Standby (*see page 57*)
- IT8760 Super I/O Configuration (*see page 57*)
- SCH3106 Second Super I/O Configuration (*see page 58*)
- AOAC Configuration (*see page 58*)
- PPM Configuration (*see page 58*)

### ACPI Settings Submenu

This table shows the **ACPI Settings** options:

BIOS Setting	Description
Enable ACPI Auto Configuration	Enables or disables BIOS ACPI auto configuration.
Enable Hibernation	Enables or disables hibernation.
ACPI Sleep State	Sets the ACPI sleep state.
Lock Legacy Resources	Locks legacy device resources.
S3 Video Report	Enables or disables S3 resume for VBIOS.

### Trusted Platform Module Submenu

This table shows the **Trusted Computing** option:

BIOS Setting	Description
TPM SUPPORT	Enables or disables TPM, if available.

### CPU Configuration Submenu

This table shows the **CPU Configuration** options:

BIOS Setting	Description
Hyper Threading Technology	Enables or disables the Intel Hyper Threading Technology.
Execute Disable Bit	Enables or disables the no-execution page protection.
Limit CPUID Maximum	Enables or disables the limit CPUID maximum for Windows XP.



### IDE Configuration Submenu

This table shows the **SATA Configuration** options:

BIOS Setting	Description
SATA Port0	Not Present
SATA Port1	SQF-S10M2-16G
SATA Controller(s)	Enables or disables the SATA Controllers.
SATA Mode Selection	Allows selection of the mode of the SATA Controllers.

### Intel Fast Flash Standby Submenu

This table shows the **Intel Fast Flash Standby** option:

BIOS Setting	Description
IFFS Support	Enables or disables iFFS.

### USB Configuration Submenu

This table shows the **USB Configuration** options:

BIOS Setting	Description
Legacy USB Support	Enables support for legacy USB. The <b>Auto</b> option disables legacy support if no USB devices are connected.
EHCI Hand-Off	This is a work around for the OS without EHCI hand-off support. The EHCI ownership change is claimed by EHCI driver.
USB transfer time-out	Sets the time-out value for control, bulk, and interrupt transfers.
Device reset time-out	Sets USB mass storage device start unit command time-out value.
Device power-up delay	Sets the maximum time the device will take before it properly reports itself to the host controller. <b>Auto</b> uses a default value: for a root port, the delay is 100 ms; for a hub port, the delay is taken from the hub descriptor.
Mass Storage Devices	Shows the connected USB storage device.

### Embedded Controller Configuration Submenu

This table shows the **Embedded Controller Configuration** options:

BIOS Setting	Description
EC Software API WatchDog IRQ	Sets the IRQ number of the EC watchdog.
EC Power Saving Mode	Sets the board's power saving when off.
EC Software API Smart FAN	Enables or disables the smart fan feature.
Backlight Enable Polarity	Sets the backlight enable polarity.
EC Watch Dog Function	Enables or disables the EC watchdog function.

### IT8760 Super I/O Configuration Submenu

This table shows the **Super I/O Configuration** options:

BIOS Setting	Description
Serial Port 1 Configuration	Allows configuration of serial port 1.

**SCH3106 Second Super I/O Configuration Submenu for Atom N2600 Models PE-B:**

This table shows the **Second Super I/O Configuration** options:

BIOS Setting	Description
<b>Serial Port 3 Configuration</b>	Allows configuration of serial port 3.
<b>Serial Port 4 Configuration</b>	Allows configuration of serial port 4.
<b>Serial Port 5 Configuration</b>	Allows configuration of serial port 5.
<b>Serial Port 6 Configuration</b>	Allows configuration of serial port 6.

**AOAC Configuration Submenu**

This table shows the **AOAC Configuration** options:

BIOS Setting	Description
<b>AOAC Configuration</b>	Enables or disables the AOAC function.

**PPM Configuration Submenu**

This table shows the **PPM Configuration** options:

BIOS Setting	Description
<b>EIST</b>	Enables or disables the Intel SpeedStep function.
<b>CPU C state Report</b>	Enables or disables the CPU C state report to OS.
<b>Enhanced C state</b>	Enables or disables the enhanced C state.
<b>CPU Hard C4E</b>	Enables or disables the CPU Hard C4E function.
<b>CPU C6 state</b>	Enables or disables the CPU C6 state.
<b>C4 Exit Timing</b>	Sets the programmable time for the CPU voltage to stabilize when exiting from a C4 state.
<b>C-state POPDOWN</b>	Enables or disables the Intel C-state POPDOWN function.
<b>C-state POPUP</b>	Enables or disables the Intel C-state POPUP function.

## Chipset Menu

### Chipset Tab

The following options are available from the **Chipset** tab:

- **Host Bridge** (see page 59)  
This option allows Intel IGT configuration.
- **TPT Devices** (see page 59)  
This option allows, among other things, configuration of TPT devices and PCI express ports.

### Host Bridge/Intel IGD Configuration Submenu

This table shows the **Intel IGD Configuration** menu options:

BIOS Setting	Description
<b>Auto Disable IGD</b>	Enables the auto disable IGD when an external GFX detected.
<b>IGFX - Boot Type</b>	Selects the output device during the POST.
<b>Active LFP (Atom N2600 only)</b>	Selects the active LFP configuration.
<b>Fixed Graphics Memory Size</b>	Configures a fixed graphic memory size.

### TPT Devices Submenu

This table shows the **TPT Devices** menu options:

BIOS Setting	Description
<b>Azalia Controller</b>	Enables or disables BIOS the Azalia controller.
<b>Select USB Mode</b>	Selects USB mode by either controllers or ports.
<b>SMBus Controller</b>	Enables or disables the on-chip SMBus controller.
<b>SIRQ Logic</b>	Enables or disables the SIRQ logic.
<b>SIRQ Mode</b>	Sets SIRQ mode.
<b>MSATA/PCIe Switch</b>	Enables MSATA and disables PCIe.
<b>LAN1/LAN2 Controller</b>	Enables or disables LAN devices.
<b>PCI Express PME</b>	Enables or disables the PDI PME function.
<b>PCI Express Root Port 0/1</b>	Allows configuration of the PCIe ports 0/1.
<b>DMI Link ASPM Control</b>	Enables or disables the control of active state power management on both NB and SB sides of DMI link.
<b>High Precision Timer</b>	Enables or disables the high precision timer.
<b>SLP_S4 Assertion Width</b>	Sets a delay of sorts.
<b>Restore AC Power Loss</b>	–

## Boot Menu

This table shows the **Boot** menu options:

BIOS Setting	Description
<b>Setup Prompt Timeout</b>	Selects the number of seconds to wait for the setup activation key.
<b>Bootup NumLock State</b>	Selects the Numlock power-on state.
<b>Quiet Boot</b>	If disabled, the BIOS displays the normal POST messages. If enabled, an OEM Logo is shown instead of the POST messages.
<b>Option ROM Message</b>	Sets the display mode for an optional ROM.
<b>Interrupt 19 Capture</b>	Allows optional ROMs to trap interrupt 19.
<b>Boot Option Priorities</b>	Sets boot device priority.

## Save & Exit Menu

The following table shows the **Save & Exit** menu options:

BIOS Setting	Description
<b>Save Changes and Exit</b>	When the system configuration is complete, select this option to save changes, exit BIOS setup and, if necessary, reboot the computer to take into account all system configuration parameters.
<b>Discard Changes and Exit</b>	Select this option to quit Setup without making any permanent changes to the system configuration.
<b>Save Changes and Reset</b>	Selecting this option displays a confirmation message box. On confirming, you save changes to the BIOS settings, save the settings to CMOS, and restart the system.
<b>Discard Changes and Reset</b>	Select this option to quit BIOS setup without making any permanent changes to the system configuration and reboot the computer.
<b>Save Changes</b>	Select this option to save the system configuration changes without exiting the BIOS setup menu.
<b>Discard Changes</b>	Select this option to discard any current changes and load previous system configuration.
<b>Restore Defaults</b>	Select this option to automatically configure all BIOS setup items to the optimal default settings. The optimal defaults are designed for maximum system performance, but may not work best for all computer applications. Do not use the optimal defaults if the user's computer is experiencing system configuration problems.
<b>Save User Defaults</b>	When the system configuration is complete, select this option to save changes as the user defaults without exit BIOS setup menu.
<b>Restore User Defaults</b>	Select this option to restore the user defaults.
<b>Boot Override</b>	Selects a device to use for a boot override.

---

## Section 7.3

### BIOS PE-B Atom N270 Models

---

#### Overview

This section describes the BIOS of the PE-B Atom N270 models.

#### What Is in This Section?

This section contains the following topics:

Topic	Page
Main Menu	62
BIOS Menu	63

## Main Menu

### Main Screen

When you enter the BIOS (*see page 52*) during startup, the PE-B **Main** BIOS setup menu appears:

This screen, like all the BIOS screens, is divided into 2 frames:

- Upper  
This frame displays the options available on the screen.
- Lower  
This frame displays how to move to other screens and the screen edit commands.

**NOTE:** The grayed-out options on all BIOS screens cannot be configured. The blue options can be configured by the user.

## BIOS Menu

### BIOS Features

For details about the **BIOS CMOS Setup Utility** submenus, refer to:

- Standard CMOS Features (see page 63)
- Advanced BIOS Features (see page 63)
- Advanced Chipset Features (see page 63)
- Integrated Peripherals (see page 63)
- Power Management Setup (see page 64)
- PnP/PCI Configurations (see page 64)
- Boot (see page 64)

### Standard CMOS Features Menu

This table shows the **Standard CMOS Features** options:

BIOS Setting	Description
IDE Channel 0 Master	Sets the IDE channel 0.
IDE Channel 2 Master	Sets the IDE channel 2.

### Advanced BIOS Features Menu

This table shows the **Advanced BIOS Features** option:

BIOS Setting	Description
Hard Disk Boot Priority	Sets the hard disk boot priority (see page 64).

This table shows the **CPU Feature** options:

BIOS Setting	Description
Limit CPUID MaxVal	Enables or disables the maximum value of the CPU ID.
Execute Disable Bit	Enables or disables the disable bit execution.

### Advanced Chipset Features Menu

This table shows the **Advanced Chipset Features** options:

BIOS Setting	Description
System BIOS cacheable	Enables or disables the system BIOS cacheable.
VIDEO BIOS cacheable	Enables or disables the video BIOS cacheable.

### Integrated Peripherals Menu

This table shows the **Integrated Peripherals** options:

BIOS Setting	Description
USB Device Setup	Allows selection of the USB devices.
IDE Device Setup	Allows selection of the IDE devices.

### Power Management Setup Menu

This table shows the **Power Management Setup** option:

BIOS Setting	Description
ACPI Function	Enables or disables ACPI functions.

### PnP/PCI Configurations Menu

This table shows the **PnP/PCI Configurations** option:

BIOS Setting	Description
Reset Configuration Data	Enables or disables the reset of the configuration data.

### Boot Menu

Go to the **Boot Menu**:

**Main menu** → **Advanced BIOS Features** → **Hard Disk Boot Priority**



---

# Chapter 8

## Hardware Modifications

---

### Subject of this Chapter

This chapter is about the hardware modifications for the PE-B.

You can use optional units, Main Memory, CF cards by Pro-face, and commercial devices and boards with this product.

### What Is in This Chapter?

This chapter contains the following topics:

Topic	Page
Before Modifications	66
SDD Drive Description and Installation for PE-B Atom N2600 Models	67
CFast Card Installation for PE-B Atom N2600 Models	70
Compact Flash Card Installation for PE-B Atom N270 Models	72

## Before Modifications

### Overview

For detailed installation procedures for optional units, refer to the OEM (Original Equipment Manufacturer) Installation Guide included with the optional unit.

### **DANGER**

#### **HAZARD OF ELECTRIC SHOCK, EXPLOSION OR ARC FLASH**

- Remove all power from the device before removing any covers or elements of the system, and prior to installing or removing any accessories, hardware, or cables.
- Unplug the power cable from both the PE-B and the power supply.
- Always use a properly rated voltage sensing device to confirm power is off.
- Replace and secure all covers or elements of the system before applying power to the unit.
- Use only the specified voltage when operating the PE-B. The DC unit is designed to use 24 Vdc.

**Failure to follow these instructions will result in death or serious injury.**

During operation, surface temperatures of the heat sink may reach more than 70 °C (158 °F).

### **WARNING**

#### **RISK OF BURNS**

Do not touch the surface of the heat sink during operation.

**Failure to follow these instructions can result in death, serious injury, or equipment damage.**

### **CAUTION**

#### **OVERTORQUE AND LOOSE HARDWARE**

- Do not exert more than 0.5 Nm (4.5 lb-in) of torque when tightening the installation fastener, enclosure, accessory, or terminal block screws. Tightening the screws with excessive force can damage the plastic installation fastener.
- When installing or removing screws, ensure that they do not fall inside the PE-B chassis.

**Failure to follow these instructions can result in injury or equipment damage.**

### **CAUTION**

#### **STATIC SENSITIVE COMPONENTS**

PE-B internal components, including accessories such as RAM modules and expansion boards, can be damaged by static electricity.

- Keep static-producing materials (plastic, upholstery, carpeting) out of the immediate work area.
- Do not remove ESD-sensitive components from their anti-static bags until you are ready to install them.
- When handling static-sensitive components, wear a properly grounded wrist strap (or equivalent).
- Avoid unnecessary contact with exposed conductors and component leads with skin or clothing.

**Failure to follow these instructions can result in injury or equipment damage.**

## SSD Drive Description and Installation for PE-B Atom N2600 Models

### Overview

This device does not support hot swapping. Before any RAID hardware modification, shut down Windows® in an orderly fashion and remove all power from the device.

### **DANGER**

#### **HAZARD OF ELECTRIC SHOCK, EXPLOSION OR ARC FLASH**

- Remove all power from the device before removing any covers or elements of the system, and prior to installing or removing any accessories, hardware, or cables.
- Unplug the power cable from both the PE-B and the power supply.
- Always use a properly rated voltage sensing device to confirm power is off.
- Replace and secure all covers or elements of the system before applying power to the unit.
- Use only the specified voltage when operating the PE-B. The DC unit is designed to use 24 Vdc.

**Failure to follow these instructions will result in death or serious injury.**

### SSD Drive Installation

### **NOTICE**

#### **ELECTROSTATIC DISCHARGE**

Take the necessary protective measures against electrostatic discharge before attempting to remove the PE-B cover.

**Failure to follow these instructions can result in equipment damage.**

**NOTE:** Be sure to remove all power before attempting this procedure.

This table describes how to install an SSD drive in the PE-B Atom N2600 models:

Step	Action
1	Disconnect the power cord to the PE-B.
2	Touch the housing or ground connection (not the power supply) to discharge any electrostatic charge from your body.

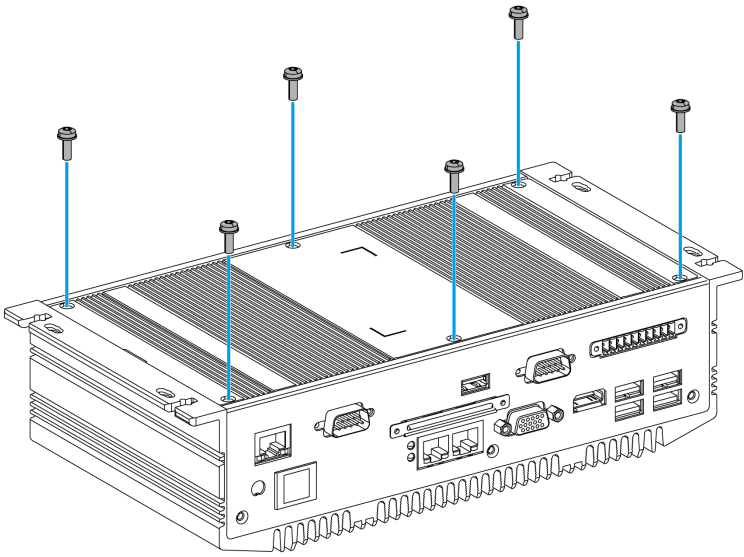
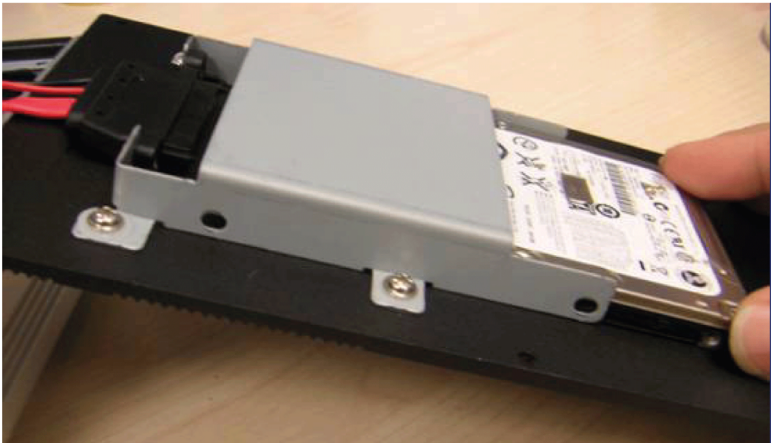
Step	Action
3	<p data-bbox="353 200 912 227">Remove the 6 Phillips screws (size 2) on the bottom cover:</p>  <p>The diagram shows the bottom cover of a device with six screws highlighted by blue lines. The screws are located at the top edge of the cover, two on each side and two in the center. The cover has various ports and connectors on the right side, including a USB port, a FireWire port, and a SATA port. The bottom edge of the cover has a series of pins or connectors.</p>
4	<p data-bbox="353 842 857 869">Slide the SSD into the SSD bay on the bottom cover:</p>  <p>The photograph shows a hand sliding a SATA SSD into a bay on the bottom cover. The SSD is a 2.5-inch drive with a silver metal casing. The bay is a black plastic component with a silver metal sliding mechanism. The SSD is being inserted into the bay, and the sliding mechanism is being pushed down to secure it.</p>

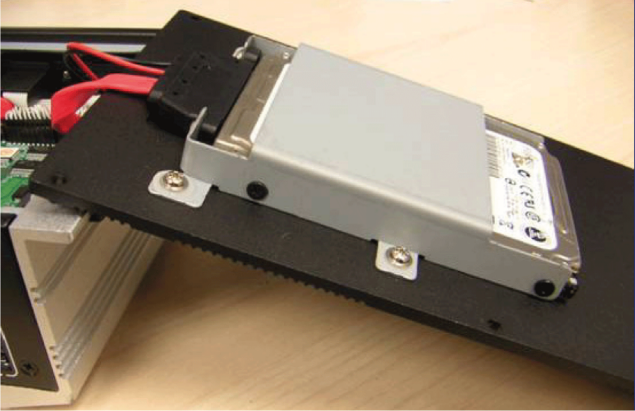
Step	Action
5	<p>Screw the 4 screws on the side of SSD bracket. The screws are used to fix the SSD to the bracket. (The screws are in the accessory box.):</p> 
6	Replace the bottom cover with the screws.

## CAUTION

### **OVERTORQUE AND LOOSE HARDWARE**

- Do not exert more than 0.5 Nm (4.5 lb-in) of torque when tightening the installation fastener, enclosure, accessory, or terminal block screws. Tightening the screws with excessive force can damage the plastic installation fastener.
- When installing or removing screws, ensure that they do not fall inside the PE-B chassis.

**Failure to follow these instructions can result in injury or equipment damage.**

## CFast Card Installation for PE-B Atom N2600 Models

### Preparing to Use a Memory Card for Atom N2600 Models

The PE-B Operating System views the CFast card as a hard disk. Proper handling and care of the memory card extends the life of the card. Familiarize yourself with the card prior to attempting insertion or removal of the card.

**DANGER**

**HAZARD OF ELECTRIC SHOCK, EXPLOSION OR ARC FLASH**

- Remove all power from the device before removing any covers or elements of the system, and prior to installing or removing any accessories, hardware, or cables.
- Unplug the power cable from both the PE-B and the power supply.
- Always use a properly rated voltage sensing device to confirm power is off.
- Replace and secure all covers or elements of the system before applying power to the unit.
- Use only the specified voltage when operating the PE-B. The DC unit is designed to use 24 Vdc.

**Failure to follow these instructions will result in death or serious injury.**

**CAUTION**

**MEMORY CARD DAMAGE AND DATA LOSS**

- Remove all power before making any contact with an installed memory card.
- Use only memory cards by Pro-face. The performance of the PE-B has not been tested using memory cards from other manufacturers.
- Confirm that the memory card is correctly oriented before insertion.
- Do not bend, drop, or strike the memory card.
- Do not touch the memory card connectors.
- Do not disassemble or modify the memory card.
- Keep the memory card dry.

**Failure to follow these instructions can result in injury or equipment damage.**

### Inserting the Memory Card for Atom N2600 Models

The procedure describes how to insert the memory card in the Atom N2600 models:

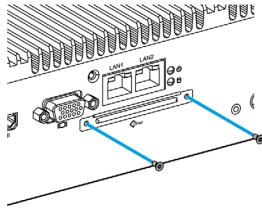
Step	Action
1	Shut down Windows® in an orderly fashion and remove all power from the device.
2	Remove the 2 screws on the memory slot cover.  

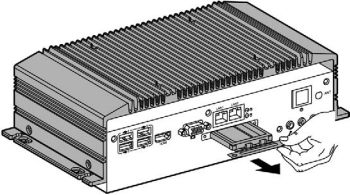
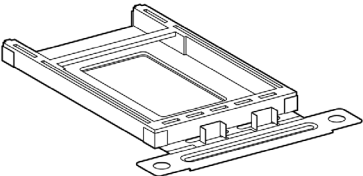
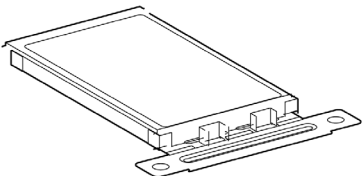
Step	Action
3	<p>Pull out the memory card tray.</p> 
4	<p>Remove the dummy memory card bracket:</p> 
5	<p>Insert the memory card firmly into the memory card tray:</p> 
6	<p>Push the memory card tray back in and fasten the memory card slot cover with the 2 screws.</p>

### Data Writing Limitation

The memory card allows approximately 100,000 write operations. Back up all memory card data regularly to other storage media.

### Memory Card Data Backup

Refer to the relevant procedure in the software installation guide for the PE-B and terminals.

## Compact Flash Card Installation for PE-B Atom N270 Models

### Preparing to Use a Memory Card for Atom N270 Models

The PE-B Operating System views the Compact Flash card as a hard disk. Proper handling and care of the memory card extends the life of the card. Familiarize yourself with the card prior to attempting insertion or removal of the card.

DANGER

**HAZARD OF ELECTRIC SHOCK, EXPLOSION OR ARC FLASH**

- Remove all power from the device before removing any covers or elements of the system, and prior to installing or removing any accessories, hardware, or cables.
- Unplug the power cable from both the PE-B and the power supply.
- Always use a properly rated voltage sensing device to confirm power is off.
- Replace and secure all covers or elements of the system before applying power to the unit.
- Use only the specified voltage when operating the PE-B. The DC unit is designed to use 24 Vdc.

**Failure to follow these instructions will result in death or serious injury.**

CAUTION

**MEMORY CARD DAMAGE AND DATA LOSS**

- Remove all power before making any contact with an installed memory card.
- Use only memory cards by Pro-face. The performance of the PE-B has not been tested using memory cards from other manufacturers.
- Confirm that the memory card is correctly oriented before insertion.
- Do not bend, drop, or strike the memory card.
- Do not touch the memory card connectors.
- Do not disassemble or modify the memory card.
- Keep the memory card dry.

**Failure to follow these instructions can result in injury or equipment damage.**

### Inserting the Memory Card for Atom N270 models

The procedure describes how to insert the memory card in the Atom N270 models:

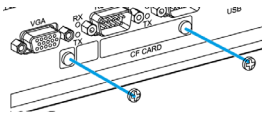
Step	Action
1	Shut down Windows® in an orderly fashion and remove all power from the device.
2	Remove the 2 screws on the memory card slot cover. 
3	Insert the memory card firmly into the memory card slot, and check that the eject button pops out.
4	Fasten the memory card slot cover with the 2 screws.



**Data Writing Limitation**

The memory card allows approximately 100,000 write operations. Back up all memory card data regularly to other storage media.

**Memory Card Data Backup**

Refer to the relevant procedure in the software installation guide for PE-B and terminals.



---

# Part III

## Installation

---

**Subject of this Part**

This part describes product installation.

**What Is in This Part?**

This part contains the following chapters:

Chapter	Chapter Name	Page
9	System Monitor	77
10	Maintenance	89



---

# Chapter 9

## System Monitor

---

### Subject of this Chapter

This chapter describes the system monitor features of the PE-B.

### What Is in This Chapter?

This chapter contains the following topics:

Topic	Page
System Monitor Interface	78
Using <b>System Monitor</b>	82
Using <b>Remote Monitoring</b>	85
Using <b>Notification Center</b>	88

## System Monitor Interface

### Overview

The **System Monitor** interface provides remote monitoring—a feature that helps you to access multiple clients through a single console for remote device management. The **System Monitor** immediately recognizes equipment and provides real-time equipment maintenance, which improve system stability and reliability.

**Remote Monitoring** monitors the system status of remote devices. The monitored items include hard disk temperature, hard drive health, network connection, system/CPU temperature, and system voltage.

**Remote Monitoring** also provides support for function logs so that managers can regularly check the status of their remote devices.

The **System Monitor** can display messages when thresholds are exceeded.

### System Monitor Requirements

Operating System requirements:

Operating System
Windows Embedded Standard 2009
Windows Embedded Standard 7

Software requirements:

Description	Software
Framework	Microsoft.NET framework version 2.0 or higher
Driver	Pro-face Software API

### System Monitor Console

The **System Monitor** console acts as a server for the clients. Devices that run on the **System Monitor** console displays health and status information from the **System Monitor** clients. The console has to be made available by the client over a network.

To launch the **System Monitor** console, click **Windows Start Menu** → **All Programs** → **Pro-face** → **System Monitor**:

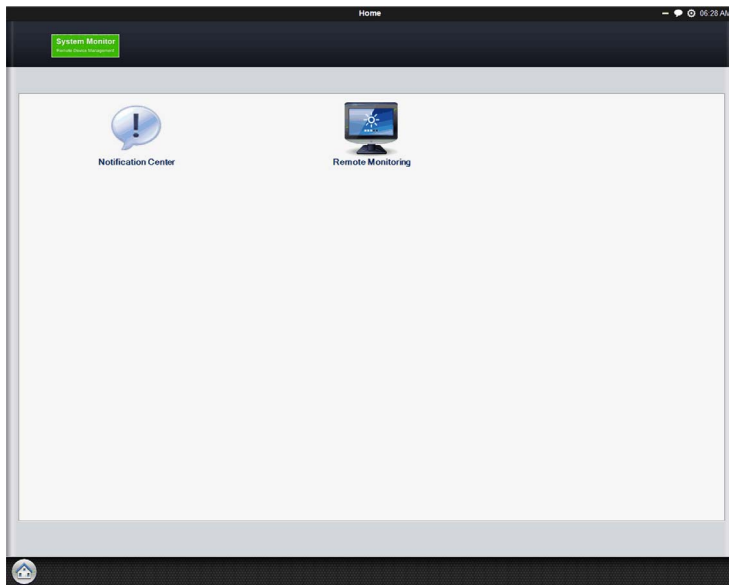

Click **Remote Monitoring** application:

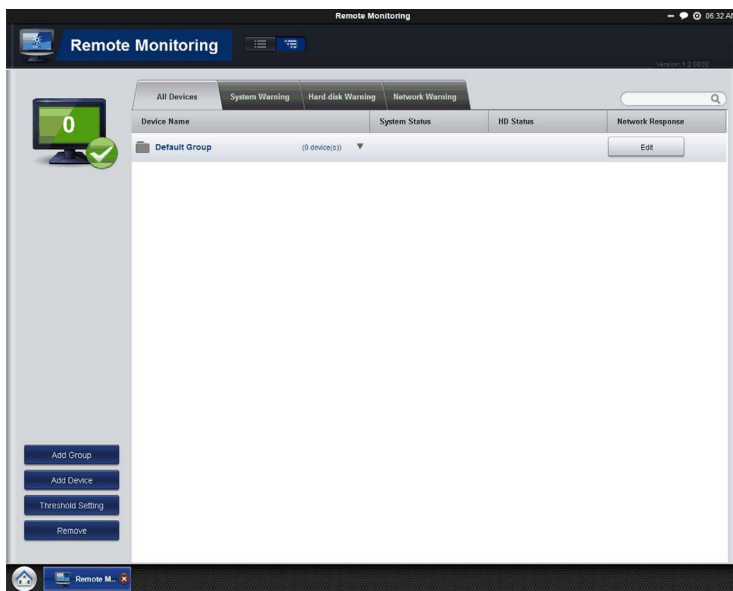

### System Monitor Agent

This procedure describes the **System Monitor Stand Alone Agent** general user interface:

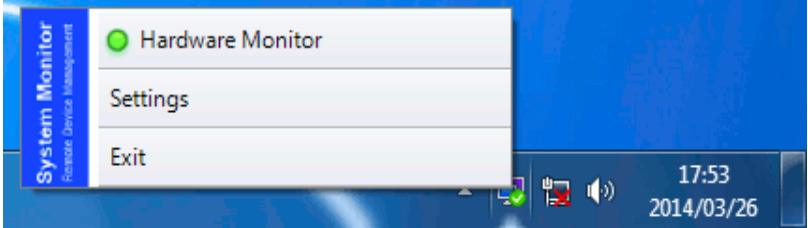
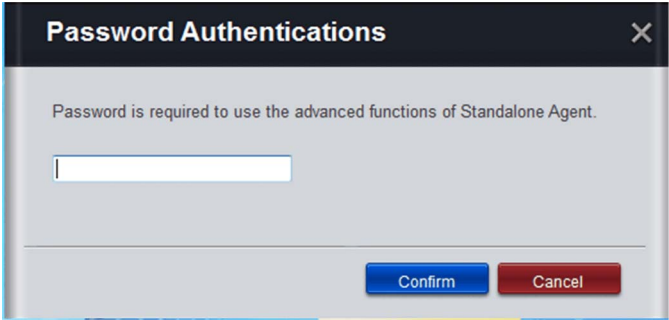
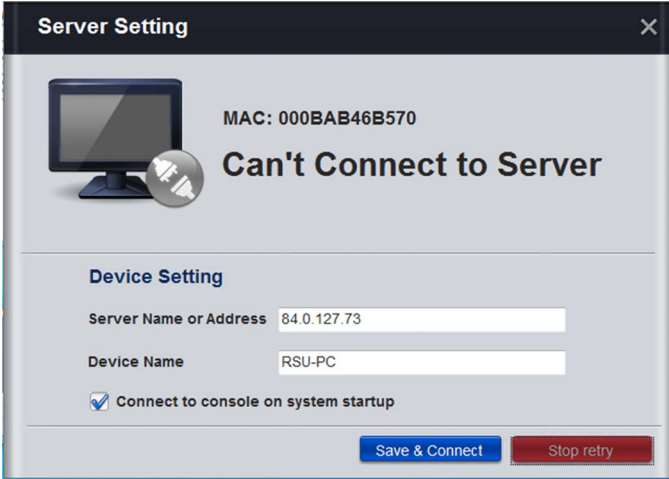
	Description
1	<p>The <b>System Monitor</b> stands alone agent automatically starts when the system starts. If you have to enter a new server IP address, you need to open the <b>System Monitor Agent</b>, click the icon in the toolbar:</p> 
2	<p>You have to enter your <b>Password Authentications</b>:</p> 
3	<p>You have to enter your server IP address. Your server is the device which has <b>System Monitor</b> console running. Name the device gives the possibility to recognize it in multiple client configurations:</p> 

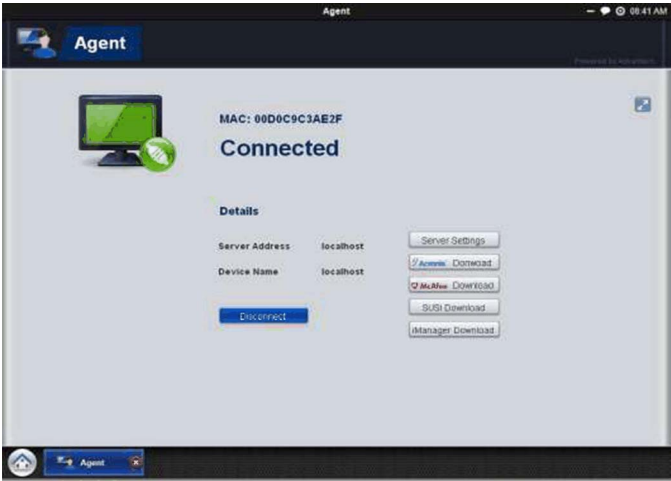
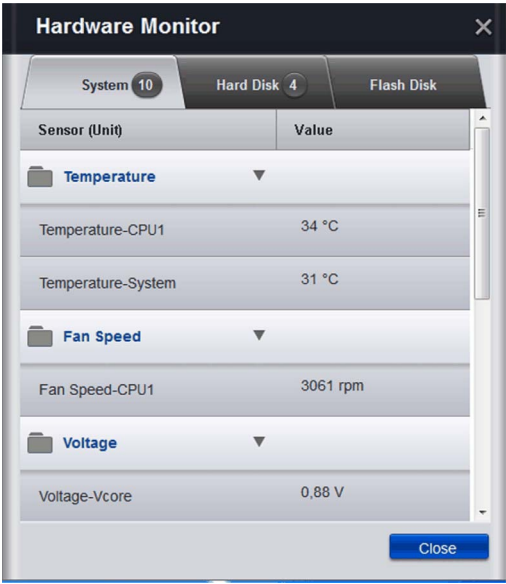

Description																	
4	<p>Click <b>Save &amp; Connect</b> connect the agent to the <b>System Monitor</b> console server:</p>  <p>The screenshot shows the 'Agent' interface. At the top, it says 'Agent' and 'Powered by HPE iLO'. Below that, there's a computer icon with a green checkmark and the text 'MAC: 00D0C9C3AE2F' and 'Connected'. Under 'Details', it shows 'Server Address: localhost' and 'Device Name: localhost'. There are several buttons: 'Server Settings', 'Agent Download', 'MacOS Download', 'SMB Download', 'Manager Download', and a blue 'Disconnect' button.</p>																
5	<p>If you want to see the <b>Hardware Monitor</b>, you need to open the <b>System Monitor Agent</b>, click the icon in the toolbar:</p>  <p>The screenshot shows the 'Hardware Monitor' window. It has tabs for 'System' (10), 'Hard Disk' (4), and 'Flash Disk'. Below the tabs is a table with columns 'Sensor (Unit)' and 'Value'. The table is grouped into three sections: 'Temperature', 'Fan Speed', and 'Voltage'. A 'Close' button is at the bottom right.</p> <table border="1"><thead><tr><th>Sensor (Unit)</th><th>Value</th></tr></thead><tbody><tr><td colspan="2"><b>Temperature</b></td></tr><tr><td>Temperature-CPU1</td><td>34 °C</td></tr><tr><td>Temperature-System</td><td>31 °C</td></tr><tr><td colspan="2"><b>Fan Speed</b></td></tr><tr><td>Fan Speed-CPU1</td><td>3061 rpm</td></tr><tr><td colspan="2"><b>Voltage</b></td></tr><tr><td>Voltage-Vcore</td><td>0.88 V</td></tr></tbody></table>	Sensor (Unit)	Value	<b>Temperature</b>		Temperature-CPU1	34 °C	Temperature-System	31 °C	<b>Fan Speed</b>		Fan Speed-CPU1	3061 rpm	<b>Voltage</b>		Voltage-Vcore	0.88 V
Sensor (Unit)	Value																
<b>Temperature</b>																	
Temperature-CPU1	34 °C																
Temperature-System	31 °C																
<b>Fan Speed</b>																	
Fan Speed-CPU1	3061 rpm																
<b>Voltage</b>																	
Voltage-Vcore	0.88 V																

## Using System Monitor

### Overview

**System Monitor** is for remote device management.

### Using System Monitor

This procedure describes the **System Monitor** general user interface:

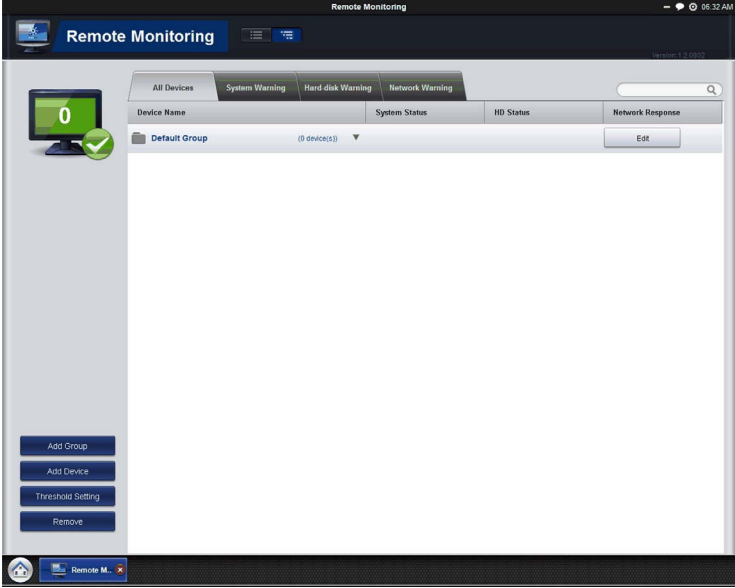
	Description
1	<p>Search bar: You can search for a device by device name. The list view shows the result instantly.</p>  <p><b>Hierarchical or Flat Viewing Mode:</b> click the buttons on the right to the application name to switch between hierarchical or flat viewing mode. In the hierarchical mode, the devices can be divided into different groups for easier management; in the flat mode, all the devices are shown in the same page to have the overview of all the devices.</p>
2	<p><b>Group Tab:</b> according to the information or functionality they are divided into several tabs. The tabs also display the number of current devices.</p>
3	<p><b>Sorting:</b> click on the column header to sort all the important information. Default is to sort by device name.</p>
4	<p><b>Device item:</b> shows all device items.</p>
5	<p><b>Status count:</b> this shows the values that users care most about.</p>
6	<p><b>Extended function:</b> for each user, every remote application has its own customized functions.</p>

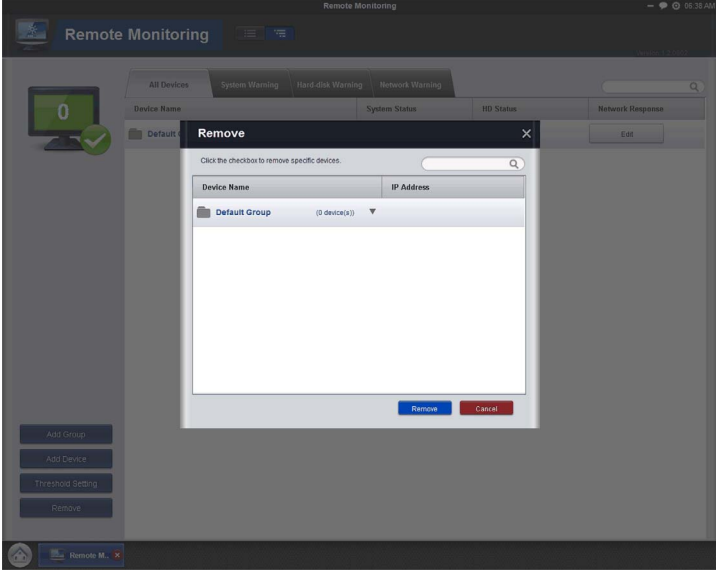
	Description
7	<p>Remove devices: If a device is offline for some time and you do not want it to show up, click the <b>Remove Device</b> button to remove it.</p> <p><b>NOTE:</b> If the device comes online, it shows up again.</p> 

## Configuration

You can set configurations such as auto start up, language selection, wallpaper and update.

**General (Change system behaviors):** click **Edit** to set **System Monitor** to appear in the system tray and then set it to appear automatically in the system tray when the OS starts up.

### Language (Change User Interface Language)

**Change Wallpaper (Change your main wallpaper in the framework):** click **Edit** to select your own wallpaper on the main screen.

**System Monitor Console Framework Update (Detect available updates):** When the console connects to the internet and finds a new update on the server, the **Update** icon is enabled and allows you to update online. Sometimes, the updater will ask you reboot the device when the update is complete.

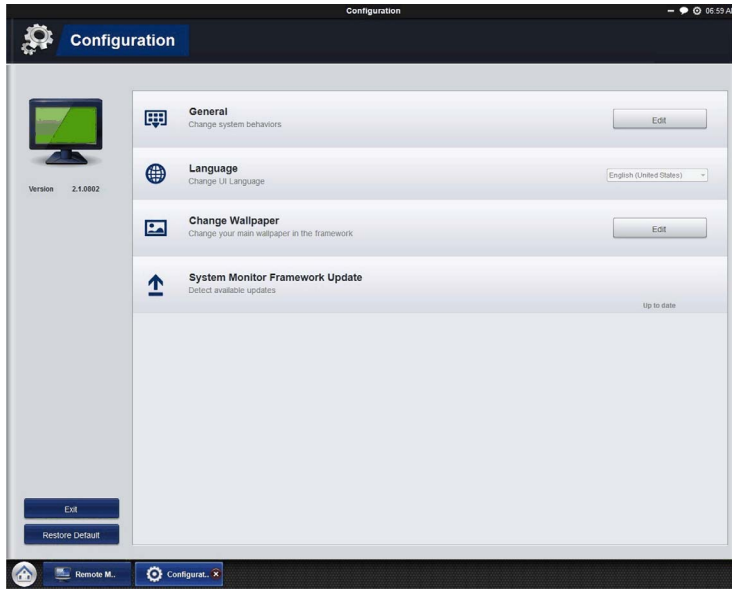

## Using Remote Monitoring

### Remote Monitoring

The **Remote Monitoring** application monitors the system status of remote devices, this includes hard disk temperatures, hard drive health, network connection, system/CPU temperatures, system/CPU fan speeds and system voltages. Email alarms and function logs are generated so that managers can regularly keep track of their remote devices.

This procedure shows how to access the **Remote Monitoring** application:

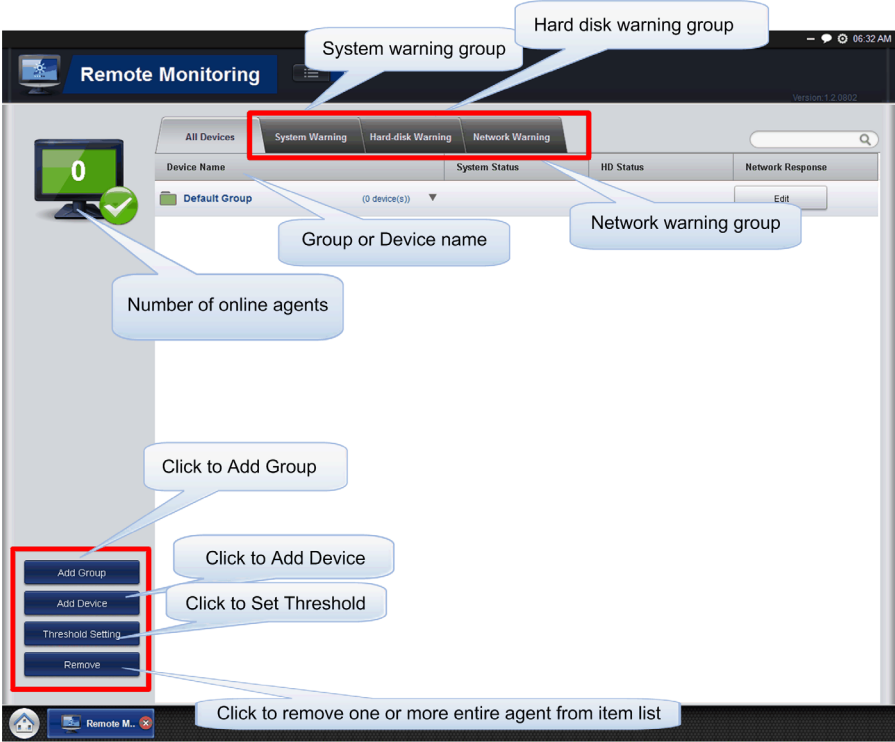
	Description
1	<p>Click <b>Remote Monitoring</b> icon to run the application. Main application screen.</p>  <p><b>Add Group:</b> create group name and edit description then add device(s) to specific group.  <b>Add Device:</b> click <b>Add Device</b> to add device. Click Search to scan device(s) in LAN and select device(s) which you wanted then add it/them.  <b>Threshold Setting:</b> monitoring threshold contains four items: <b>Temperature</b>, <b>Fan Speed</b>, <b>Voltage</b>, and <b>Hard Disk</b>. In addition to the defaults, managers can increase or decrease items from this page. When the status higher or lower than threshold, the number color will change to red for warning.  <b>Remove:</b> if you have determined that your device or group will not be online, you can click on the <b>Remove</b> button to delete it.  <b>Update All Agent:</b> console detect agent's update status, once one of your agents on device list is not up to date, the icon <b>Update All Agents</b> will show on the top of extended function, and you can update all agents by clicking it.  <b>Manage device of group:</b> click <b>Edit</b> on the device bar to add or remove device(s). Click <b>Edit</b> to edit group name and related description.</p>

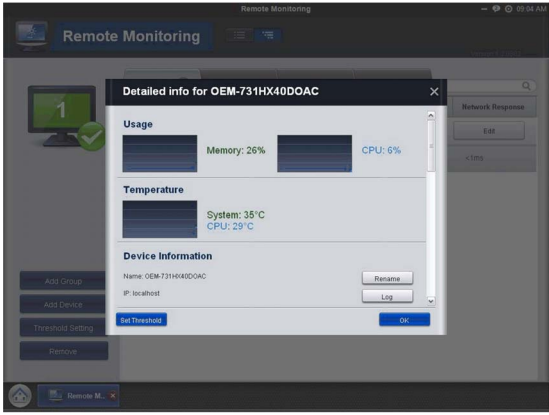
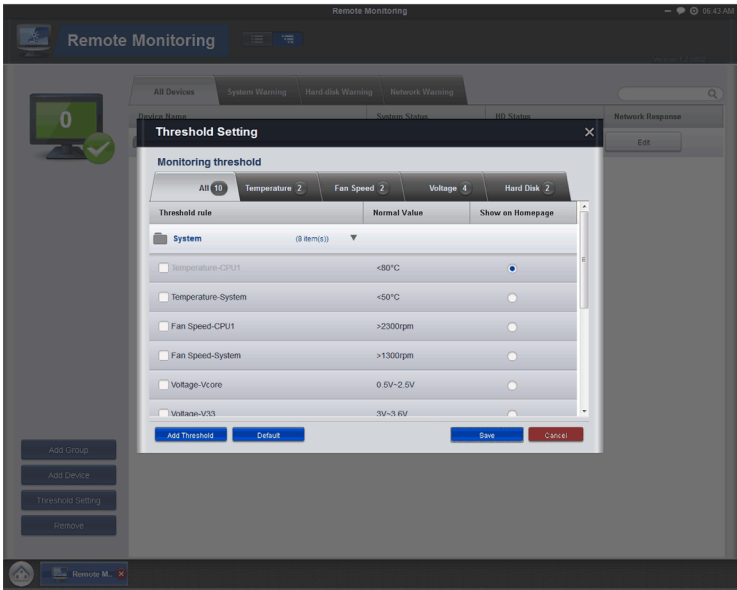
	Description
<p>2</p>	<p><b>Detailed device status:</b> click device to get detailed Information contained several items: CPU/Memory Usage, System Temperature, CPU Temperature, Device MAC Address, Motherboard Model, BIOS version, Processor Model, Memory Capacity, OS version, System Status, Storage Status and Network Status.</p> 
<p>3</p>	<p><b>Monitoring threshold settings</b>                      The <b>Setting</b> window can be used to monitor threshold setting, this contains 4 items: Temperature, fan speed, voltage, and hard disk. In addition to this, managers can increase or decrease items in this page.</p> 

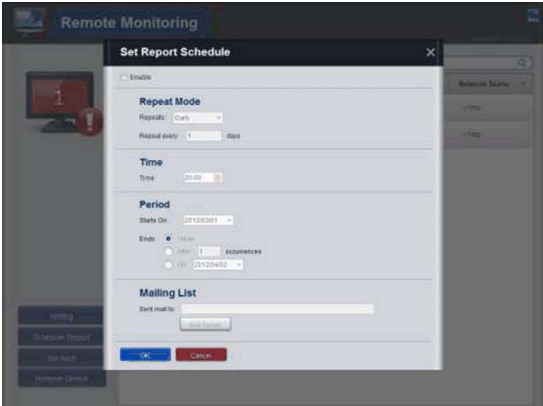
	Description
4	<p><b>Set report schedule</b></p> <p>The main function for this is to set up a schedule and the runtime report status. The function is based on the information that you set in the <b>Set Report Schedule</b> window. If you want to use the schedule and the repeat functions, follow the step-by-step instructions: Click the <b>Schedule Report</b> button to start, and set the repeat mode, time, and mailing list recipient then press the <b>OK</b> button.</p> 

## Using Notification Center

### Notification Center Monitoring

The **Notification Center** application manages the messages with 3 different types: Error, Warning and Notify.

This procedure shows how to use the **Notification Center** application:

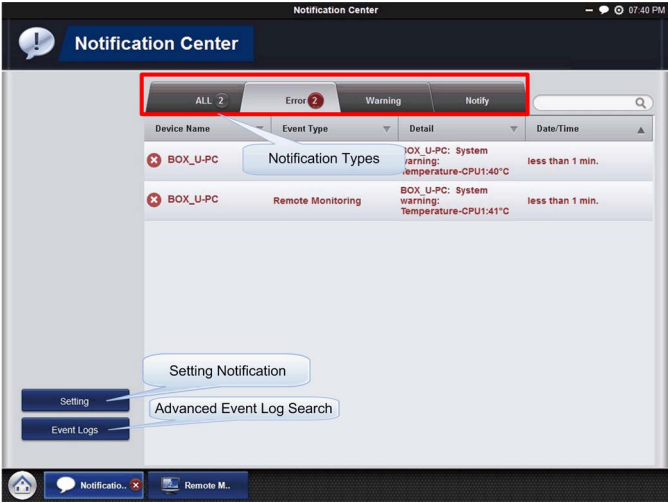
	Description
<p>1</p>	<p>Click <b>Notification Center</b> icon to run the application. Main application screen.</p>  <p><b>All:</b> list latest 500 logs in 5 pages, and allow search bar to search the latest 500 event logs. <b>Setting:</b> shows advanced notification center settings.</p>
<p>2</p>	<p><b>Event Logs:</b> click <b>Event Logs</b> icon to search log. <b>Search:</b> you can search all logs here within a period by keyword. <b>Export:</b> log supports to be exported for your searching result.</p>



---

# Chapter 10

## Maintenance

---

### Subject of this Chapter

This chapter covers maintenance of the PE-B.

### What Is in This Chapter?

This chapter contains the following topics:

Topic	Page
Reinstallation Procedure	90
Regular Cleaning and Maintenance	91

## Reinstallation Procedure

### Introduction

In certain cases, it may be necessary to reinstall the operating system.

Precautions to take:

- Keep static-producing materials (plastic, upholstery, carpeting) out of the immediate work area.
- Do not remove ESD-sensitive components from their anti-static bags until you are ready to install them.
- When handling static-sensitive components, wear a properly grounded wrist strap (or equivalent).
- Avoid unnecessary contact with exposed conductors and component leads with skin or clothing.

### Before Reinstallation

Hardware required:

- Reinstallation DVD-ROM.
- Commercially available USB DVD drive, compatible with DVD+R DL format, and with USB connection.

Setting up the hardware:

- Shut down Windows® in an orderly fashion and remove all power from the device.
- Disconnect all external peripherals.

**NOTE:** Save all important data on the hard drive or memory card (the reinstallation process will erase all data). The reinstallation process will return the computer to its factory settings.

### Reinstallation

For the reinstallation procedure, refer to the recovery guide inserted in the recovery DVD-ROM cover.

## Regular Cleaning and Maintenance

### Introduction

Inspect the PE-B periodically to determine its general condition. For example:

- Are all power cords and cables connected properly? Have any become loose?
- Are all installations holding the unit securely?
- Is the ambient temperature within the specified range?

The following describes service/maintenance work which can be carried out by a trained, qualified user.

### DANGER

#### HAZARD OF ELECTRIC SHOCK, EXPLOSION OR ARC FLASH

- Remove all power from the device before removing any covers or elements of the system, and prior to installing or removing any accessories, hardware, or cables.
- Unplug the power cable from both the PE-B and the power supply.
- Always use a properly rated voltage sensing device to confirm power is off.
- Replace and secure all covers or elements of the system before applying power to the unit.
- Use only the specified voltage when operating the PE-B. The DC unit is designed to use 24 Vdc.

**Failure to follow these instructions will result in death or serious injury.**

During operation, surface temperatures of the heat sink may reach more than 70 °C (158 °F).

### WARNING

#### RISK OF BURNS

Do not touch the surface of the heat sink during operation.

**Failure to follow these instructions can result in death, serious injury, or equipment damage.**

### Cleaning Solutions

### CAUTION

#### HARMFUL CLEANING SOLUTIONS

Do not clean the unit or any component of the unit with paint thinner, organic solvents, or strong acids.

**Failure to follow these instructions can result in injury or equipment damage.**



# Appendices



---

---

# Appendix A

## Accessories

---

### Subject of this Chapter

This chapter concerns the accessories relating to the products.

### What Is in This Chapter?

This chapter contains the following topics:

Topic	Page
Accessories for the PE-B	96
Mounting Jumper of The PE-B Atom N270 Models	96

## Accessories for the PE-B

### Available Accessories

Accessories are available as options. The accessories available for the PE-B are:

Reference	Description
PFXZPESSD81	SSD Unit without OS, 80GB
PFXZPESSD161	SSD Unit without OS, 160GB
PFXZPECF81	CF Card, 8GB
PFXZPECF82	CFast Card, 8GB
PFXZPECF162	CFast Card, 16GB
PFXZPEAFDR1	DIN rail Adaptor for PE-4000B Atom N270
PFXZPEAFDR2	DIN rail Adaptor for PE-4000B Atom N2600
PFXZPECNDC1	DC power supply connector for N270 (5 pcs)
PFXZPECNDC2	DC power supply connector for N2600 (5 pcs)
PFXZPECNDIO1	DIO Connector (5pcs)
PFXZPECNHDDV1	A Connector converting HDMI to DVI

## Mounting Jumper of The PE-B Atom N270 Models

### Overview

You may configure the PE-B to match the needs of your application by setting jumpers. A jumper is a metal bridge used to close an electric circuit. It consists of 2 metal pins and a small metal clip (often protected by a plastic cover) that slides over the pins to connect them. To close a jumper, you connect the pins with the clip. To open a jumper, you remove the clip. Sometimes a jumper will have 3 pins, labeled 1, 2 and 3, in this case you would connect either pins 1 and 2, or 2 and 3.

The jumper settings are schematically depicted as follows:

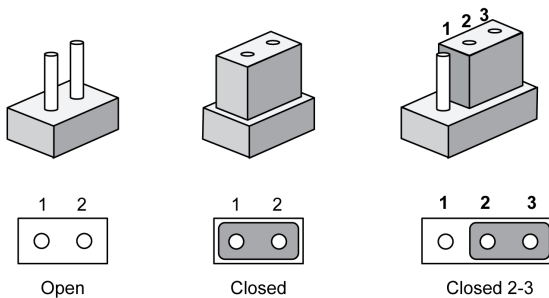

**NOTE:** A pair of needle-nose pliers may be helpful when working with jumpers.



## Mounting Jumper Clips

The following steps describe the mounting of jumper of the PE-B Atom N270 models.

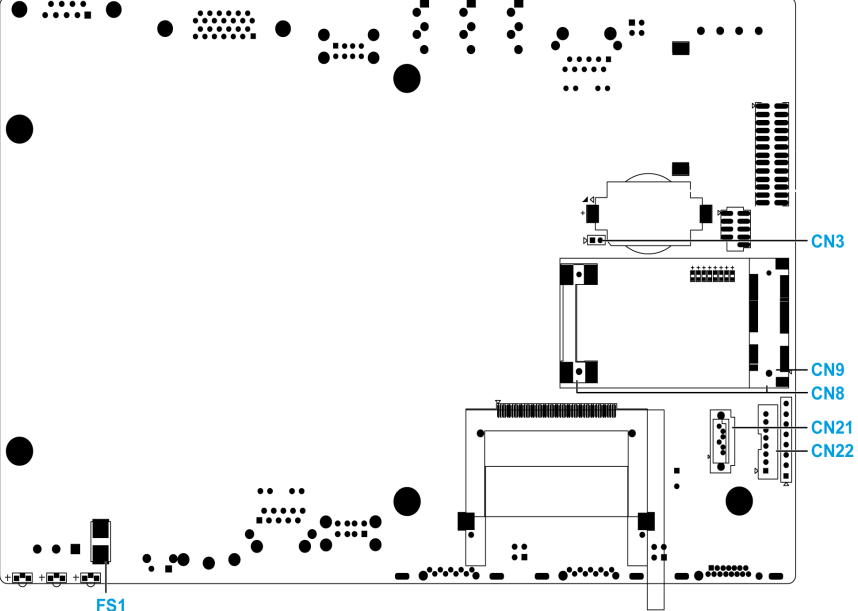
Step	Action
1	Remove the power.
2	Connectors and jumper list of the main board: <div style="text-align: center;">  </div> <p> <b>FS1</b> Fuse for input DC power  <b>CN3</b> Clear CMOS  <b>CN8 CN9</b> PCI express mini card socket  <b>CN21</b> SATA 2 signal connector  <b>CN22</b> SATA power connector         </p>
3	Set the jumper to CN3 to clear CMOS.



## **After-sales service**

---

For details on after-sales service, refer to our website at  
<http://www.pro-face.com/trans/en/manual/1001.html>

