



Flexi Soft Driver

| | | |
|---|-----------------------------------|----|
| 1 | System Configuration..... | 3 |
| 2 | External Device Selection | 6 |
| 3 | Communication Settings | 7 |
| 4 | Setup Items | 9 |
| 5 | Cable Diagrams | 15 |
| 6 | Supported Device..... | 17 |
| 7 | Device Code and Address Code..... | 22 |
| 8 | Error Messages..... | 23 |

Introduction

This manual describes how to connect the Display and the External Device (target PLC).

In this manual, the connection procedure is described in the sections identified below.

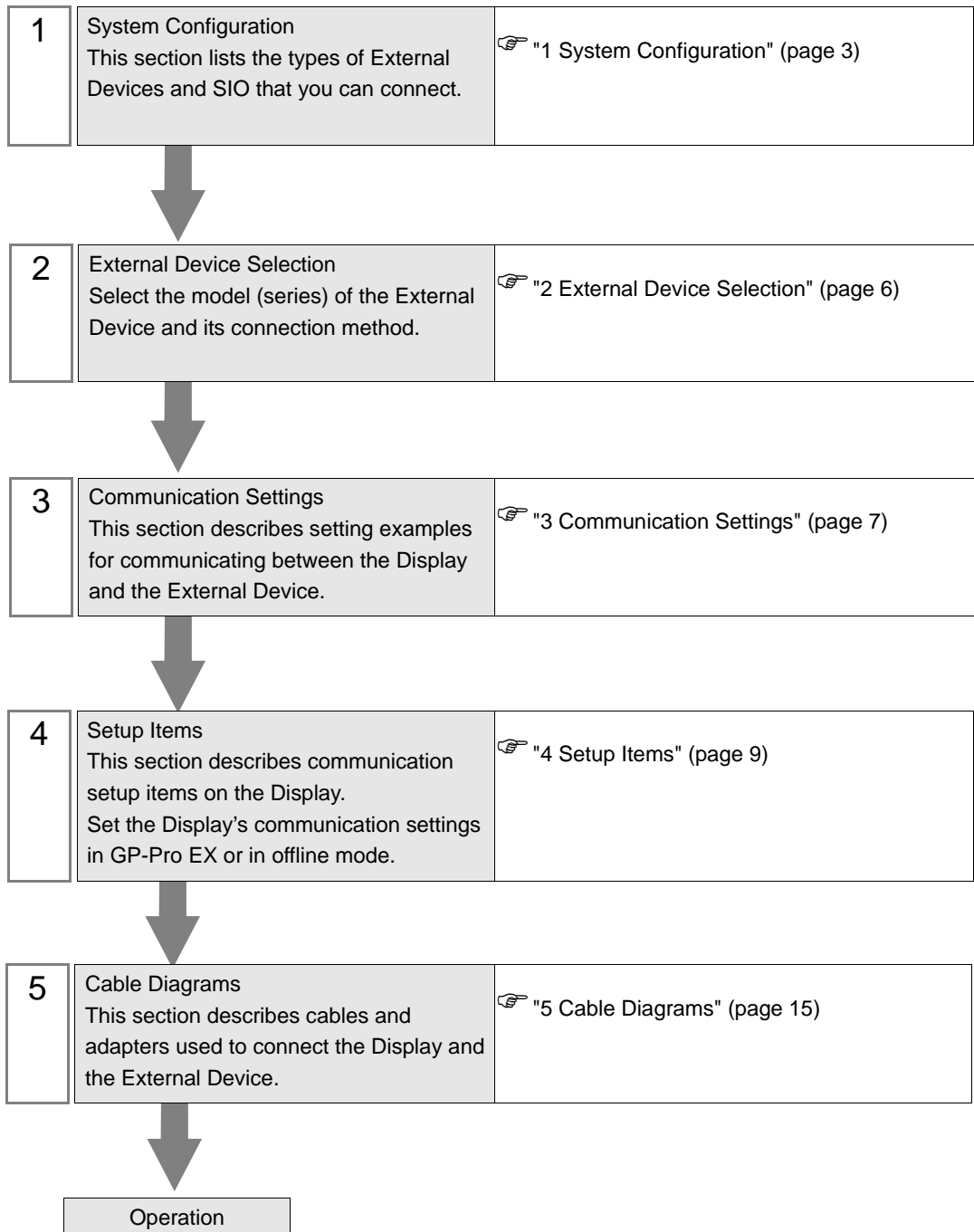

1 System Configuration

The system configuration when the External Device of SICK AG and the Display are connected is shown.

| Series | CPU | Link I/F | SIO Type | Setting Example | Cable Diagram |
|------------|----------------------|--------------------|----------|----------------------------|---------------------------|
| Flexi Soft | FX3-CPU0 FX3-CPU1 | Port 1 on CPU unit | RS-232C | Setting Example 1 (page 7) | Cable Diagram 1 (page 15) |

■ Connection Configuration

- 1:1 Connection



- 1:n Connection

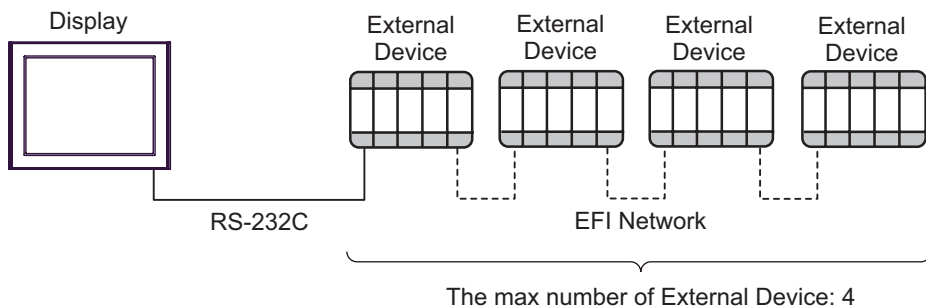

-
- NOTE** • Ladder software from SICK AG (Flexi Soft Designer) and a Display cannot be used simultaneously with External Devices in 1:n connection.
-

■ IPC COM Port

When connecting IPC with an External Device, the COM port used depends on the series and SIO type. Please refer to the IPC manual for details.

Usable port

| Series | Usable Port | | |
|---|--|----------------------|----------------------|
| | RS-232C | RS-422/485(4 wire) | RS-422/485(2 wire) |
| PS-2000B | COM1 ^{*1} , COM2, COM3 ^{*1} , COM4 | - | - |
| PS-3450A, PS-3451A, PS3000-BA, PS3001-BD | COM1, COM2 ^{*1*2} | COM2 ^{*1*2} | COM2 ^{*1*2} |
| PS-3650A (T41 model), PS-3651A (T41 model) | COM1 ^{*1} | - | - |
| PS-3650A (T42 model), PS-3651A (T42 model) | COM1 ^{*1*2} , COM2 | COM1 ^{*1*2} | COM1 ^{*1*2} |
| PS-3700A (Pentium®4-M) PS-3710A | COM1 ^{*1} , COM2 ^{*1} , COM3 ^{*2} , COM4 | COM3 ^{*2} | COM3 ^{*2} |
| PS-3711A | COM1 ^{*1} , COM2 ^{*2} | COM2 ^{*2} | COM2 ^{*2} |
| PS4000 ^{*3} | COM1, COM2 | - | - |
| PL3000 | COM1 ^{*1*2} , COM2 ^{*1} , COM3, COM4 | COM1 ^{*1*2} | COM1 ^{*1*2} |

*1 The RI/5V can be switched. Use the IPC's switch to change if necessary.

*2 Set up the SIO type with the DIP Switch. Please set up as follows according to SIO type to be used.

*3 When making communication between an External Device and COM port on the Expansion slot, only RS-232C is supported. However, ER (DTR/CTS) control cannot be executed because of the specification of COM port.

For connection with External Device, use user-created cables and disable Pin Nos. 1, 4, 6 and 9.

Please refer to the IPC manual for details of pin layout.

DIP Switch setting: RS-232C

| DIP Switch | Setting | Description |
|------------|-------------------|---|
| 1 | OFF ^{*1} | Reserved (always OFF) |
| 2 | OFF | SIO type: RS-232C |
| 3 | OFF | |
| 4 | OFF | Output mode of SD (TXD) data: Always output |
| 5 | OFF | Terminal resistance (220Ω) insertion to SD (TXD): None |
| 6 | OFF | Terminal resistance (220Ω) insertion to RD (RXD): None |
| 7 | OFF | Short-circuit of SDA (TXA) and RDA (RXA): Not available |
| 8 | OFF | Short-circuit of SDB (TXB) and RDB (RXB): Not available |
| 9 | OFF | RS (RTS) Auto control mode: Disabled |
| 10 | OFF | |

*1 When using PS-3450A, PS-3451A, PS3000-BA and PS3001-BD, turn ON the set value.

DIP Switch setting: RS-422/485 (4 wire)

| DIP Switch | Setting | Description |
|------------|---------|---|
| 1 | OFF | Reserved (always OFF) |
| 2 | ON | SIO type: RS-422/485 |
| 3 | ON | |
| 4 | OFF | Output mode of SD (TXD) data: Always output |
| 5 | OFF | Terminal resistance (220Ω) insertion to SD (TXD): None |
| 6 | OFF | Terminal resistance (220Ω) insertion to RD (RXD): None |
| 7 | OFF | Short-circuit of SDA (TXA) and RDA (RXA): Not available |
| 8 | OFF | Short-circuit of SDB (TXB) and RDB (RXB): Not available |
| 9 | OFF | RS (RTS) Auto control mode: Disabled |
| 10 | OFF | |

DIP Switch setting: RS-422/485 (2 wire)

| DIP Switch | Setting | Description |
|------------|---------|--|
| 1 | OFF | Reserved (always OFF) |
| 2 | ON | SIO type: RS-422/485 |
| 3 | ON | |
| 4 | OFF | Output mode of SD (TXD) data: Always output |
| 5 | OFF | Terminal resistance (220Ω) insertion to SD (TXD): None |
| 6 | OFF | Terminal resistance (220Ω) insertion to RD (RXD): None |
| 7 | ON | Short-circuit of SDA (TXA) and RDA (RXA): Available |
| 8 | ON | Short-circuit of SDB (TXB) and RDB (RXB): Available |
| 9 | ON | RS (RTS) Auto control mode: Enabled |
| 10 | ON | |

2 External Device Selection

Select the External Device to connect to the Display.

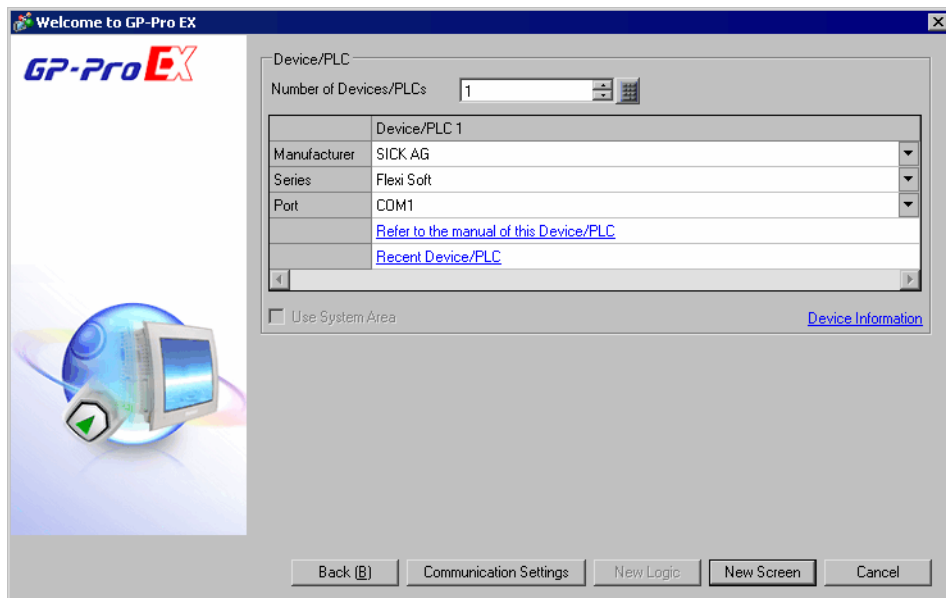

| Setup Items | Setup Description |
|------------------------|---|
| Number of Devices/PLCs | Enter an integer from 1 to 4 to define the number of Devices/PLCs to connect to the display. |
| Manufacturer | Select the manufacturer of the External Device to connect. Select "SICK AG". |
| Series | Select the External Device model (series) and the connection method. Select "Flexi Soft". In System configuration, make sure the External Device you are connecting is supported by "Flexi Soft". ☞ "1 System Configuration" (page 3) |
| Port | Select the Display port to connect to the External Device. |
| Use System Area | Check this option to synchronize the system data area of the Display and the device (memory) of the External Device. When synchronized, you can use the External Device's ladder program to switch the display or display the window on the Display. Cf. GP-Pro EX Reference Manual "LS Area (Direct Access Method Area)" This feature can also be set in GP-Pro EX or in the Display's offline mode. Cf. GP-Pro EX Reference Manual "System Settings [Display Unit] - [System Area] Settings Guide" Cf. Maintenance/Troubleshooting Guide "Main Unit - System Area Settings" |

3 Communication Settings

This section provides examples of communication settings recommended by Pro-face for the Display and the External Device.

3.1 Setting Example 1

■ GP-Pro EX Settings

◆ Communication Settings

To display the setup screen, from the [Project] menu, point to [System Settings] and select [Device/PLC].

Device/PLC 1

Summary [Change Device/PLC](#)

Manufacturer Series Port

Text Data Mode [Change](#)

Communication Settings

SIO Type RS232C RS422/485(2wire) RS422/485(4wire)

Speed Auto Baudrate

Data Length 7 8

Parity NONE EVEN ODD

Stop Bit 1 2

Flow Control NONE ER(DTR/CTS) XON/XOFF

Timeout (sec)

Retry

Wait To Send (ms)

Data Refresh Cycle (sec)

Client ID

RI / VCC RI VCC

In the case of RS232C, you can select the 9th pin to RI (Input) or VCC (5V Power Supply). If you use the Digital's RS232C Isolation Unit, please select it to VCC.

Device-Specific Settings

Allowable Number of Devices/PLCs [Add Device](#)

| No. | Device Name | Settings |
|----------------------------------|-----------------------------------|---|
| <input type="button" value="1"/> | <input type="text" value="PLC1"/> | <input type="text" value="Station Address=Direct"/> |

NOTE

- Set Timeout to 2 (sec) or more.

◆ Device Setting

To display the [Individual Device Settings] dialog box, from [Device-Specific Settings] in the [Device/PLC] window, select the external device and click [Settings] .

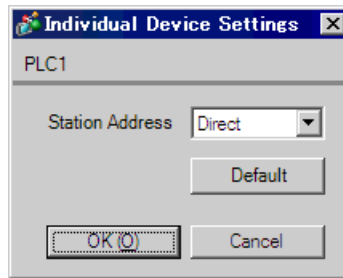

■ External Device Settings

Use Flexi Soft Designer to perform communication settings for the External Device. Refer to your External Device manual for details.

- 1 Start Flexi Soft Designer.
- 2 Select [New] from the [Project] menu, and select [Standalone station project] for a 1:1 connection and [Flexi Link system project] for a 1:n connection.
- 3 In the [Hardware configuration] screen, select the CPU to use.

NOTE

- For a 1:n connection, click the [Adds a new station] icon in the [System overview] screen to display the [Hardware configuration] screen. For hardware configuration, it is necessary to perform settings for the number of External Devices connected.

- 4 To display the [Settings] dialog box, click the [Settings] icon.
- 5 Select the [General] tab and place a check next to [Enable RS232 routing for the CPU].
- 6 After clicking [Connect], click [Network settings].
- 7 Drag each of the displayed devices to allocate a station address from A to D.

NOTE

- In the PLC communication settings, the following parameter settings are fixed.

| | |
|--------------|--------|
| Speed | 115200 |
| Data Length | 8 |
| Parity | OFF |
| EVEN/ODD | NONE |
| Stop Bit | 1 |
| Flow Control | NONE |

4 Setup Items

Set up the Display's communication settings in GP-Pro EX or in the Display's offline mode.

The setting of each parameter must match that of the External Device.

 "3 Communication Settings" (page 7)

4.1 Setup Items in GP-Pro EX

■ Communication Settings

To display the setup screen, from the [Project] menu, point to [System Settings] and select [Device/PLC].

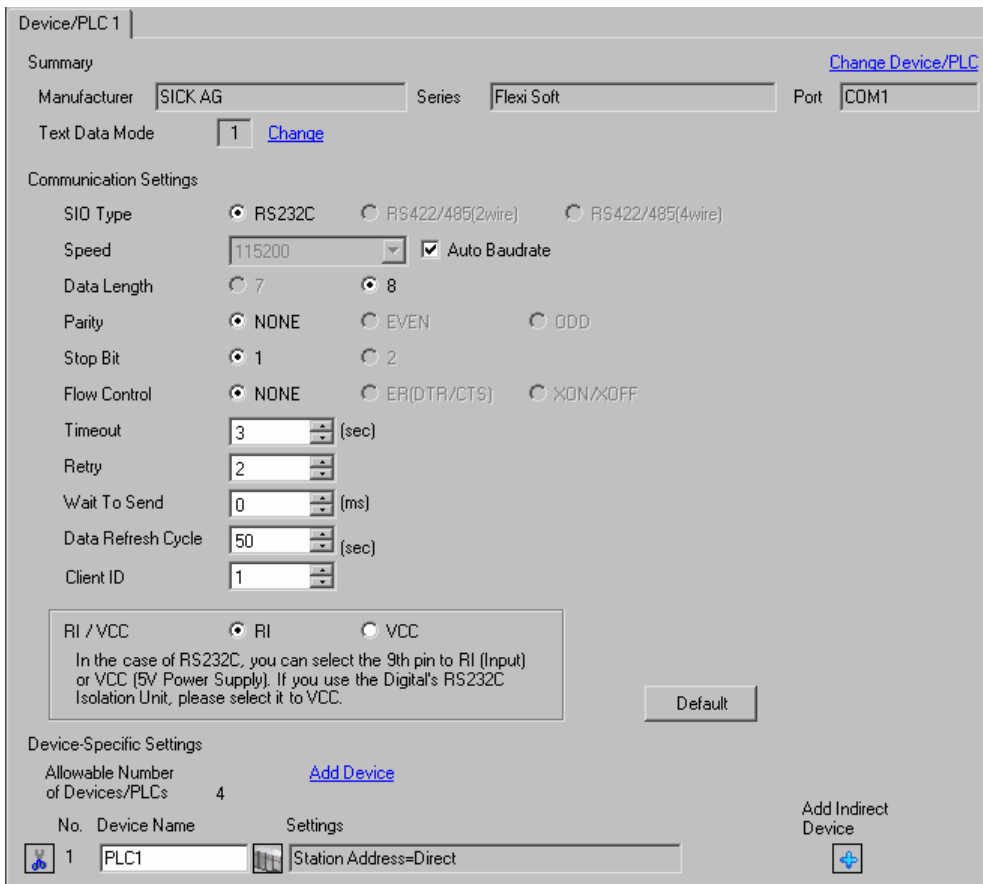

Device/PLC 1

Summary [Change Device/PLC](#)

Manufacturer Series Port

Text Data Mode [Change](#)

Communication Settings

SIO Type RS232C RS422/485(2wire) RS422/485(4wire)

Speed Auto Baudrate

Data Length 7 8

Parity NONE EVEN ODD

Stop Bit 1 2

Flow Control NONE ER(DTR/CTS) XON/XOFF

Timeout (sec)

Retry

Wait To Send (ms)

Data Refresh Cycle (sec)

Client ID

RI / VCC RI VCC

In the case of RS232C, you can select the 9th pin to RI (Input) or VCC (5V Power Supply). If you use the Digital's RS232C Isolation Unit, please select it to VCC.

[Default](#)

Device-Specific Settings

Allowable Number of Devices/PLCs [Add Device](#)

| No. | Device Name | Settings |
|---|-----------------------------------|---|
|  1 | <input type="text" value="PLC1"/> | <input type="text" value="Station Address=Direct"/> |

[Add Indirect Device](#)

| Setup Items | Setup Description |
|-------------|--|
| SIO Type | Display the SIO type for communicating with the External Device. |
| Speed | Select the communication speed between the External Device and the Display. To detect the speed automatically, place a check [Auto Baudrate]. |
| Data Length | Data length is displayed. |
| Parity | The parity check method is displayed. |
| Stop Bit | Stop bit length is displayed. |

Continues to the next page.

| Setup Items | Setup Description |
|--------------------|---|
| Flow Control | The communication control method to prevent overflow of transmission and reception data. |
| Timeout | Enter the time (sec) for which the Display waits for the response from the External Device, from "1 to 127". |
| Retry | In case of no response from the External Device, enter how many times the Display retransmits the command, from "0 to 255". |
| Wait To Send | Enter the standby time (ms) from when the Display receives packets until it transmits the next command, from "0 to 255". |
| Data Refresh Cycle | Enter the Data Refresh Cycle for retaining written values, from "10 to 59". Normally, this is set at the default setting of "50". NOTE <ul style="list-style-type: none"> The External Device resets the data in RS-232 to Flexi Soft automatically as soon as one minute has elapsed since the last writing. To prevent the written data from being reset, the Display executes writing cyclically. |
| Client ID | Enter the Display number, from "0 to 255". Normally, this is set at the default setting of "1". NOTE <ul style="list-style-type: none"> An error may occur if Client ID is changed while writing is being performed. |
| RI/VCC | You can switch RI/VCC of the 9th pin when you select RS232C for SIO type. It is necessary to change RI/5V by changeover switch of IPC when connect with IPC. Please refer to the manual of the IPC for more detail. |

NOTE • Refer to the GP-Pro EX Reference Manual for Indirect Device.

Cf. GP-Pro EX Reference Manual "Changing the Device/PLC at Runtime (Indirect Device)"

■ Device Setting

To display the [Individual Device Settings] dialog box, from [Device-Specific Settings] in the [Device/PLC] window, select the external device and click [Settings] . To connect multiple External Devices, from [Device-Specific Settings] in the [Device/PLC] window, click [Add Device] to add another External Device.

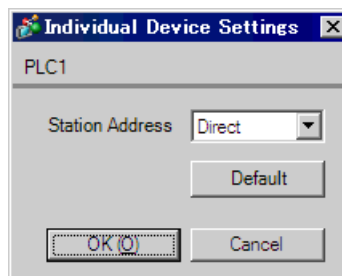

| Setup Items | Setup Description |
|-----------------|---|
| Station Address | Select "Direct", "A", "B", "C", or "D". |

4.2 Setup Items in Offline Mode

NOTE

- Refer to the Maintenance/Troubleshooting guide for information on how to enter offline mode or about the operation.

Cf. Maintenance/Troubleshooting Guide "Offline Mode"

- The number of the setup items to be displayed for 1 page in the offline mode depends on the Display in use. Please refer to the Reference manual for details.

■ Communication Settings

To display the setting screen, touch [Device/PLC Settings] from [Peripheral Settings] in offline mode. Touch the External Device you want to set from the displayed list.

| Comm. | Device | Option | | |
|------------------|--------|---|--------|------------------------|
| Flexi Soft | | | [COM1] | Page 1/1 |
| SIO Type | | RS232C | | |
| Speed | | 115200 | | |
| Auto Baudrate | | <input checked="" type="radio"/> Yes <input type="radio"/> No | | |
| Data Length | | 8 | | |
| Parity | | NONE | | |
| Stop Bit | | 1 | | |
| Flow Control | | NONE | | |
| Timeout(s) | | 3 | | |
| Retry | | 2 | | |
| Wait To Send(ms) | | 0 | | |
| Data Refresh(s) | | 50 | | |
| Client ID | | 1 | | |
| | Exit | | Back | 2011/10/05 19:13:32 |

| Setup Items | Setup Description |
|---------------|--|
| SIO Type | The SIO type for communicating with the External Device is displayed. |
| Speed | Select the communication speed between the External Device and the Display. When "auto" is selected, it is not used. |
| Auto Baudrate | Select whether to automatically detect the communication speed. |
| Data Length | Data length is displayed. |
| Parity | The parity check method is displayed. |

Continues to the next page.

| Setup Items | Setup Description |
|--------------|--|
| Stop Bit | Stop bit length is displayed. |
| Flow Control | The communication control method to prevent overflow of transmission and reception data. |
| Timeout | Enter the time (sec) for which the Display waits for the response from the External Device, from "1 to 127". |
| Retry | In case of no response from the External Device, enter how many times the Display retransmits the command, from "0 to 255". |
| Wait To Send | Enter the standby time (ms) from when the Display receives packets until it transmits the next command, from "0 to 255". |
| Data Refresh | <p>Enter the Data Refresh Cycle for retaining written values, from "10 to 59". Normally, this is set at the default setting of "50".</p> <p>NOTE</p> <ul style="list-style-type: none"> The External Device resets the data in RS-232 to Flexi Soft automatically as soon as one minute has elapsed since the last writing. To prevent the written data from being reset, the Display executes writing cyclically. |
| Client ID | <p>Enter the Display number, from "0 to 255". Normally, this is set at the default setting of "1".</p> <p>NOTE</p> <ul style="list-style-type: none"> An error may occur if Client ID is changed while writing is being performed. |

■ Device Setting

To display the setting screen, touch [Device/PLC Settings] from [Peripheral Settings]. Touch the External Device you want to set from the list that appears, and touch [Device].

| Comm. | Device | Option | | |
|-----------------|--------|---|----------|------------------------|
| | | | | |
| Flexi Soft | | [COM1] | Page 1/1 | |
| Device/PLC Name | | PLC1 <input type="button" value="v"/> | | |
| Station Address | | Direct <input type="button" value="v"/> | | |
| Exit | | Back | | 2011/10/05 19:13:38 |

| Setup Items | Setup Description |
|-----------------|---|
| Device/PLC Name | Select the External Device to set. Device/PLC Name is the title of the External Device set with GP-Pro EX. (Initial value [PLC1]) |
| Station Address | Select "Direct", "A", "B", "C", or "D". |

■ Option

To display the setting screen, touch [Device/PLC Settings] from [Peripheral Settings]. Touch the External Device you want to set from the list that appears, and touch [Option].

| Comm. | Device | Option | | |
|--|--------|--------|--------|------------------------|
| Flexi Soft | | | [COM1] | Page 1/1 |
| RI / VCC <input checked="" type="radio"/> RI <input type="radio"/> VCC In the case of RS232C, you can select the 9th pin to RI(Input) or VCC(5V Power Supply). If you use the Digital's RS232C Isolation Unit, please select it to VCC. | | | | |
| | Exit | | Back | 2011/10/05 19:13:41 |

| Setup Items | Setup Description |
|-------------|--|
| RI/VCC | You can switch between RI/VCC for the 9th pin when you select RS-232C for SIO type. To connect to the IPC, you need to switch between RI/5V using the IPC selector switch. Refer to your IPC manual for details. |

NOTE

- GP-4100 series and GP-4*0ITM do not have the [Option] setting in the offline mode.

5 Cable Diagrams

The cable diagrams shown below may be different from the cable diagrams recommended by SICK AG. Please be assured there is no operational problem in applying the cable diagrams shown in this manual.

- The FG pin on the External Device must be D-class grounded. Refer to your External Device manual for details.
- The SG and FG are connected inside the Display. If you connect the External Device to the SG, do not form any short-circuit loop in the system design.
- If the communication is not stable because of noise or other factors, connect an isolation unit.

Cable Diagram 1

| Display (Connection Port) | Cable | | Remarks |
|--|-------|--|---------------------------|
| GP3000 (COM1) GP4000* ¹ (COM1) ST (COM1) LT (COM1) IPC* ² PC/AT | 1A | SICK part no. 2027649 (10m) or SICK part no. 6021195 (2m) | |
| GP4105 (COM1) | 1B | User-created cable + SICK part no. 2027649 (10m) or SICK part no. 6021195 (2m) | Cable length: 15m or less |

*1 All GP4000 models except GP-4100 series and GP-4203T

*2 Only the COM port which can communicate by RS-232C can be used.

 ■ IPC COM Port (page 4)

1A)

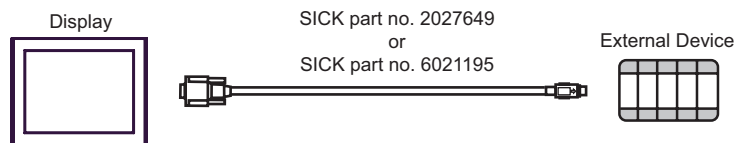

1B)

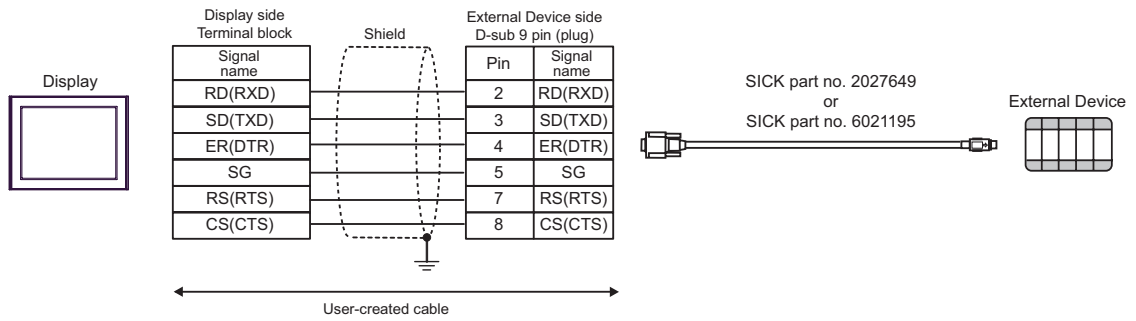
**NOTE**

- Create a short between the 7 pin and 8 pin of the SICK AG cable of the Display-side connector.











6 Supported Device

The range of supported device addresses is shown in the table below.

Refer to your External Device manual for information on terminology and features related to the External Device.





 : This address can be specified as system data area.

■ Basic devices

| Device | Bit Address | Word Address | 32 bits | Remarks |
|-------------------------|-------------|--------------|--------------|---|
| RS-232 to Flexi Soft | 0.0 - 3.7 | 0 - 2 | [L/H] |   |
| Flexi Soft to RS-232 | 00.0 - 99.7 | 00 - 98 | |   *1 |
| Module Status Bit Array | 00.0 - 59.7 | 00 - 58 | |   *1 |
| Operating Data Block | 0.0 - 9.7 | 0 - 8 | |   *1 |
| Configuration CRCs | 00.0 - 19.7 | 00 - 18 | |   *1 |

*1 Write disable

■ Advanced devices

| Device | Bit Address | Word Address | 32 bits | Remarks |
|----------------------------------|---------------|--------------|--------------|--|
| CPU Module Type Key | 00.0 - 17.7 | 00 - 16 | [L/H] |   *1 *2 |
| Extension Modules Type Key Array | 000.0 - 335.7 | 000 - 334 | |   *1 *2 |

*1 Write disable

*2 This device can be used by creating the empty file "adv.dat" inside the "\\Protocol\SCKFLEXI" folder located in the folder where GP-Pro EX was installed.

NOTE

- Refer to the GP-Pro EX Reference Manual for system data area.

Cf. GP-Pro EX Reference Manual "LS Area (Direct Access Method Area)"

- Refer to the precautions on manual notation for icons in the table.

 "Manual Symbols and Terminology"

RS-232 to Flexi Soft

The RS-232 to Flexi Soft device (R2F) allows writing 4 bytes to the Flexi Soft for use in the Flexi Soft logic.

Flexi Soft to RS-232

The Flexi Soft to RS-232 device (F2R) allows access to 100 byte process and status data. It can be compiled using the Flexi Soft Designer tool. The following table gives an overview which bytes are assigned to the default configuration.

| Bit Address | Module Status Bit Array FX3-CPU0 | Module Status Bit Array FX3-CPU1 |
|-------------------|-------------------------------------|-------------------------------------|
| F2R00.0 - F2R00.7 | Input values module 1 | Input values module 1 |
| F2R01.0 - F2R01.7 | Input values module 2 | Input values module 2 |
| : | : | : |
| F2R11.0 - F2R11.7 | Input value module 12 | Input value module 12 |
| F2R12.0 - F2R12.7 | Output value module 1 | Output value module 1 |
| F2R13.0 - F2R13.7 | Output value module 2 | Output value module 2 |
| : | : | : |
| F2R23.0 - F2R23.7 | Output value module 12 | Output value module 12 |
| F2R24.0 - F2R24.7 | Logic result 0 | Logic result 0 |
| F2R25.0 - F2R25.7 | Logic result 1 | Logic result 1 |
| F2R26.0 - F2R26.7 | Logic result 2 | Logic result 2 |
| F2R27.0 - F2R27.7 | Logic result 3 | Logic result 3 |
| F2R28.0 - F2R31.7 | Not assigned | EFI 1, Device 1 Input |
| F2R32.0 - F2R35.7 | Not assigned | EFI 1, Device 2 Input |
| F2R36.0 - F2R39.7 | Not assigned | EFI 1, Device 3 Input |
| F2R40.0 - F2R43.7 | Not assigned | EFI 2, Device 1 Input |
| F2R44.0 - F2R47.7 | Not assigned | EFI 2, Device 2 Input |
| F2R48.0 - F2R51.7 | Not assigned | EFI 2, Device 3 Input |
| F2R52.0 - F2R55.7 | Not assigned | EFI 1, Device 1 Output |
| F2R56.0 - F2R59.7 | Not assigned | EFI 2, Device 1 Output |
| F2R60.0 - F2R99.7 | Not assigned | Not assigned |

Module Status Bit Array

The Module Status Bit Array device (STAT) returns 60 bytes of data containing the individual module status and diagnostics data with four (4) bytes per module.

Refer to your External Device manual for details on status and diagnostics data.

| Module Status Bit Array | Word Address |
|-------------------------|-----------------|
| CPU Module | STAT00 - STAT02 |
| Extension Module 1 | STAT04 - STAT06 |
| Extension Module 2 | STAT08 - STAT10 |
| : | : |
| Extension Module 12 | STAT48 - STAT50 |
| Gateway 1 | STAT52 - STAT54 |
| Gateway 2 | STAT56 - STAT58 |

Operating Data Block

The Operating Data Block device (OBD) returns various time information of the external device

| Operating Data Block | Word Address | Remarks |
|----------------------|--------------|--|
| Operating Time | ODB0 - ODB2 | Total operating time in seconds |
| Power On time | ODB4 - ODB6 | Time expired since last power-up cycle |
| Power Cycles | ODB8 | Number of power up cycles |

Configuration CRCs

The Flexi Soft provides various checksums to validate that the configuration within the Flexi Soft was not altered or manipulated.

| Operating Data Block | Word Address | Remarks |
|----------------------------|---------------|--|
| Overall CRC | CRC00 - CRC02 | The overall CRC is the checksum displayed in the Flexi Soft Designer report. |
| SCID | CRC04 - CRC06 | System CRC - For the Flexi Soft external device the SCID and the Overall CRC have the same value. |
| CRC 2 | CRC08 - CRC10 | Reserved. |
| Verified Configuration CRC | CRC12 - CRC14 | If this value is identical to the System CRC (SCID) the configuration is verified. Otherwise the configuration is not verified. Refer to your External Device manual for details on verification. (Requires Flexi Soft firmware V2.00 or higher) |
| CRC 3 | CRC16 - CRC18 | Reserved. |

CPU Modules Type Key

The CPU Module Type Key device (CTYP) returns the type information for the connected Flexi Soft CPU. The serial number is equivalent to date of manufacture listed on the type label in the S/N field in the format yywwnnnn (yy = year, ww = calendar week, nnnn = continuous serial number in the calendar week).

| CPU Module Type Key | Word Address | Remarks |
|--|---------------------|---|
| Flexi Soft Family | CTYP00.0 - CTYP00.3 | Members of the Flexi Soft family returns "7". |
| Safety Level | CTYP00.4 - CTYP00.7 | 0: Standard 3: Safety |
| Module Type | CTYP01.0 - CTYP01.7 | 00: FX3-CPU0 01: FX3-CPU1 |
| Module Diagnose ID | CTYP07.0 - CTYP07.7 | Reserved |
| Serial Number - Year | CTYP14.0 - CTYP14.7 | yy (e.g. 10 = year 2010) |
| Serial Number - Calendar Week | CTYP15.0 - CTYP15.7 | ww |
| Serial Number - Continuous number in Calendar Week | CTYP16.0 - CTYP17.0 | nnnn |

Extension Modules Type Key Array

The Extension Modules Type Key Array device (MTYP) returns a list of the module type key of the modules currently connected to external device. The list includes extension modules and gateway modules. Each individual module type key is 24 bytes in length.

Refer to your External Device manual for details on device information.

| Extension Modules Type Key Array | Word Address | Remarks |
|----------------------------------|-------------------|---------------------------------|
| Extension Module 1 | MTYP000 - MTYP022 | Type Key of Extension Module 1 |
| Extension Module 2 | MTYP024 - MTYP046 | Type Key of Extension Module 2 |
| Extension Module 3 | MTYP048 - MTYP070 | Type Key of Extension Module 3 |
| : | : | : |
| Extension Module 12 | MTYP264 - MTYP286 | Type Key of Extension Module 12 |
| Gateway 1 | MTYP288 - MTYP310 | Type Key of Gateway 1 |
| Gateway 2 | MTYP312 - MTYP324 | Type Key of Gateway 2 |

The following table provides a description of the 24 bytes type key.

The serial number is equivalent to date of manufacture listed on the type label in the S/N field in the format yywwnnnn (yy = year, ww = calendar week, nnnn = continuous serial number in the calendar week).

| Extension Modules Type Key Array | Byte | Remarks |
|--|-------------------|--|
| Flexi Soft Family | Byte 0, Bit 0...3 | Members of the Flexi Soft family returns "7". |
| Safety Level | Byte 0, Bit 4...7 | 0: Standard 3: Safety |
| Module Type | Byte 1 | 04: FX3-XTDI 06: FX3-XTIO 07: FX0-GPRO 08: FX0-GDEV 09: FX0-GCAN 0A: FX-GENT 0B: FX-GMOD 0C: FX-GPNT 16: FX-GECT |
| Module Diagnose ID | Byte 7 | Reserved |
| Serial Number - Year | Byte 8 | yy (e.g. 10 = year 2010) |
| Serial Number - Calendar Week | Byte 9 | ww |
| Serial Number - Continuous number in Calendar Week | Byte 10 - Byte 11 | nnnn |

7 Device Code and Address Code

Use device code and address code if you select "Device Type & Address" for the address type in Data displays.

| Device | Device Name | Device Code (HEX) | Address Code |
|----------------------------------|-------------|-------------------|------------------------------------|
| RS-232 to Flexi Soft | R2F | 0081 | Value of word address divided by 2 |
| Flexi Soft to RS-232 | F2R | 0080 | Value of word address divided by 2 |
| Module Status Bit Array | STAT | 0082 | Value of word address divided by 2 |
| CPU Module Type Key | CTYP | 0083 | Value of word address divided by 2 |
| Extension Modules Type Key Array | MTYP | 0084 | Value of word address divided by 2 |
| Operating Data Block | ODB | 0086 | Value of word address divided by 2 |
| Configuration CRCs | CRC | 0088 | Value of word address divided by 2 |

8 Error Messages

Error messages are displayed on the Display screen as follows: "No.: Device Name: Error Message (Error Occurrence Area)". Each description is shown below.

| Item | Description |
|-----------------------|--|
| No. | Error No. |
| Device Name | Name of the External Device where an error has occurred. Device name is a title of the External Device set with GP-Pro EX. (Initial value [PLC1]) |
| Error Message | Displays messages related to an error that has occurred. |
| Error Occurrence Area | <p>Displays the IP address or device address of the External Device where an error has occurred, or error codes received from the External Device.</p> <p>NOTE</p> <ul style="list-style-type: none"> • IP address is displayed as "IP address (Decimal): MAC address (Hex)". • Device address is displayed as "Address: Device address". • Received error codes are displayed as "Decimal [Hex]". |

Display Examples of Error Messages

"RHAA035: PLC1: Error has been responded for device write command (Error Code: 1 [01H])"

NOTE

- Refer to your External Device manual for details on received error codes.
- Refer to "Display-related errors" in "Maintenance/Troubleshooting Manual" for details on the error messages common to the driver.

■ Error Codes Specific to the External Device

| Error Code (HEX) | Error Description |
|------------------|---|
| 08 | RK512 handler is busy, RK512 request cannot be processed. |
| 0A | Source/destination parameter invalid or timeout occurred. |

NOTE

- The error codes shown above may display in cases when a Display and Flexi Soft Designer are connected concurrently or when multiple Displays are connected.

■ Error Messages Specific to the External Device

| Message ID | Error Message | Description |
|------------|--|---|
| RHxx128 | Automatic baud rate detection has failed. | This will display when the baud rate cannot be detected. Check that the cable is connected. |
| RHxx129 | Writing to R2F area did not complete properly. | This will display when processing stops during writing to the RS232 Flexi Soft device. Check whether communication can be correctly performed. |
| RHxx130 | R2F data refresh has failed. (Error Code: (Decimal))[(Hex)]) | This displays when data refresh in the RS232 to Flexi Soft device has failed. There is a possibility that data will be reset, so write data as necessary. |
| RHxx131 | R2F data refresh has failed. | This displays when data refresh in the RS232 to Flexi Soft device has failed. There is a possibility that data will be reset, so write data as necessary. |