

37 | Use the Computer to Display and Operate GP Data

This chapter describes the basic operation and setup of GP-Viewer EX and the Web Server, both of which you can use to display and interact with GP screen data from a computer. First, read the general overview about this feature in "37.1 Use GP-Viewer EX to Display and Operate GP Data over a Network" (page 37-2), and then go to "37.3 Settings Menu" (page 37-10) and "37.9 Settings Menu" (page 37-39) to find explanations of individual features.

37.1	Use GP-Viewer EX to Display and Operate GP Data over a Network.....	37-2
37.2	GP-Viewer EX Operation Environment and Development Flow	37-4
37.3	Settings Menu	37-10
37.4	Using GP-Viewer EX to Display and Operate GP Data	37-11
37.5	Restricting Access to GP-Viewer EX	37-19
37.6	Using Synchronous and Asynchronous Modes with GP-Viewer EX.....	37-25
37.7	Display/Maintain GP Alarms or Device Addresses with Web Server/Browser	37-33
37.8	Web Server Operation Environment and Development Flow	37-34
37.9	Settings Menu	37-39
37.10	Displaying and Editing Addresses Via Web Server	37-42
37.11	Displaying Alarm information on the Web Server	37-55
37.12	Displaying Alarm Information as RSS Data on the Web Server	37-57
37.13	Using the Web Server to Transfer Files to the CF Card or USB Storage....	37-60
37.14	Restricting Access to the Web Server.....	37-67
37.15	Settings Guide.....	37-73
37.16	Restrictions	37-84

37.1 Use GP-Viewer EX to Display and Operate GP Data over a Network

37.1.1 GP-Viewer EX

■ Summary

GP-Viewer EX is an application that displays and operates remotely located display screens. It enables you to recover and monitor activities for troubleshooting and perform daily maintenance.

To use this feature, the computer and display unit must be placed on the same network.

GP-Viewer EX must be installed on the computer and the license must be set for the display unit.

Please install GP-Viewer EX using the GP-Pro EX 2.10 or later installation CD. You can download updates from the Pro-face Web site.

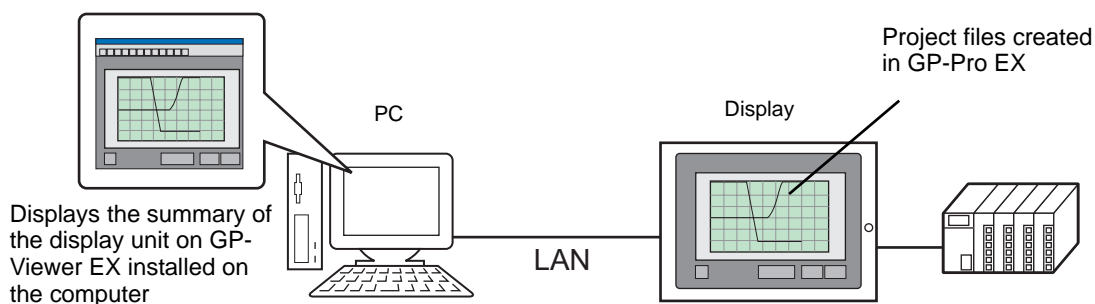

■ Model Environment

In this section, the following system configuration is used as a model to explain the operations and features. In other system configurations, the display and part names may differ. If so, replace the names with those with similar features used in your system configuration.

■ Standard Configuration

Learning material/ software	Model system specifications	Remarks
Operating System	Windows® 2000	—
Device/PLC	Mitsubishi Electric Q/QnA Serial Communication Series	—
Browser	Internet Explorer 6	—

■ License

◆ Key code

To use GP-Viewer EX, a separate license (Type: EX-VIEWER-LICENSE) is required for each display unit. When you purchase this license, documents, including a [Key code], will be issued. To enter key codes, please refer to the following.

IMPORTANT

- Maintenance/Troubleshooting:
 - ☞ Maintenance/Troubleshooting Guide, "Setting up GP-Viewer EX or Remote PC Access License"
- The key code cannot be reissued if lost. Please keep it at hand.

◆ Application

GP-Viewer EX is installed from the following location.

- For installations using a CD-ROM of GP-Pro EX (Ver2.10 or later)
From GP-Pro EX Disk 2's "GPViewerEX" folder, double-click setup.exe to install.
- Downloading Updates from the Pro-face Web site
You can download updates from our Web site, "Otasuke Pro!" <http://www.pro-face.com/otasuke/>

NOTE

- For installation procedures, refer to the following.
 - ☞ "37.4.2 Setup Procedure ■ Installing and Uninstalling GP-Viewer EX" (page 37-16)

■ Full Configuration

Connection or option environment when using GP-Viewer EX is as follows.

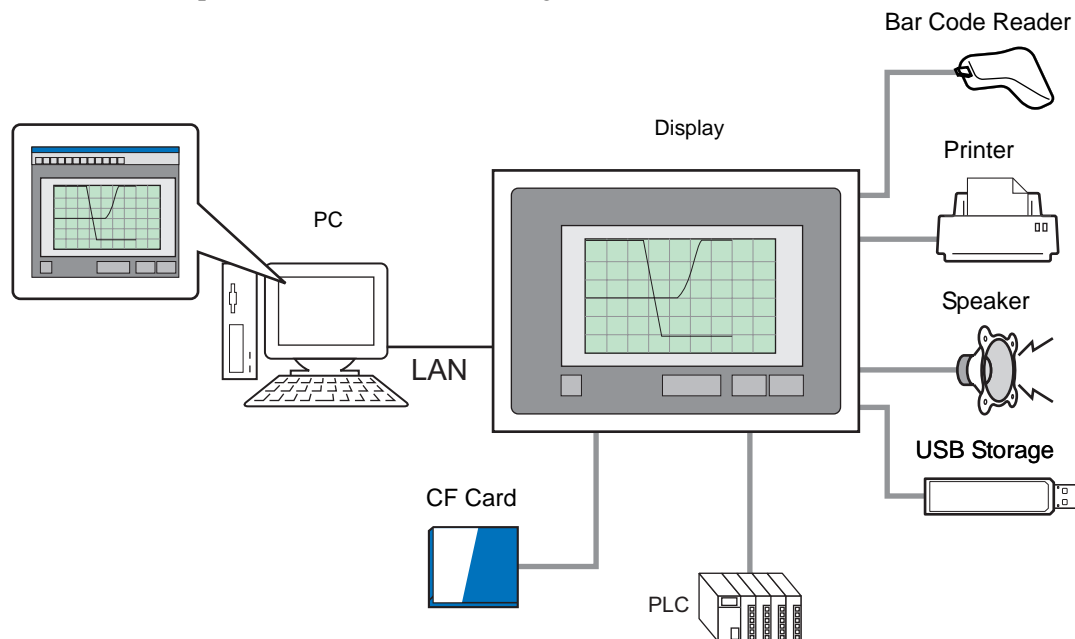

37.2 GP-Viewer EX Operation Environment and Development Flow

37.2.1 Target models

Display models supported by GP-Viewer EX are as follows.

■ Display Units

Series	Model	Model number	
GP-3000 Series	GP3200A	AGP3200-A1-D24	
	GP3200T	AGP3200-T1-D24	
	GP-3300HL	AGP3300H-L1-D24	
	GP-3300HS	AGP3300H-S1-D24	
	GP-3310HT	AGP3310H-T1-D24	
	GP3300L		AGP3300-L1-D24
			AGP3300-L1-D24-D81K
			AGP3300-L1-D24-D81C
			AGP3300-L1-D24-FN1M
			AGP3300-L1-D24-CA1M
	GP3300S		AGP3300-S1-D24
			AGP3300-S1-D24-D81K
			AGP3300-S1-D24-D81C
			AGP3300-S1-D24-CA1M
	GP3300T		AGP3300-T1-D24
			AGP3300-T1-D24-D81K
			AGP3300-T1-D24-D81C
			AGP3300-T1-D24-FN1M
			AGP3300-T1-D24-CA1M
	GP3400S		AGP3400-S1-D24
			AGP3400-S1-D24-D81K
			AGP3400-S1-D24-D81C
			AGP3400-S1-D24-CA1M
	GP3400T		AGP3400-T1-D24
			AGP3400-T1-D24-D81K
			AGP3400-T1-D24-D81C
			AGP3400-T1-D24-FN1M
			AGP3400-T1-D24-CA1M
	GP3450T		AGP3450-T1-D24
	GP3500L		AGP3500-L1-D24
			AGP3500-L1-D24-D81C
	GP3500S		AGP3500-S1-D24
			AGP3500-S1-D24-D81K
			AGP3500-S1-D24-D81C
			AGP3500-S1-D24-CA1M
			AGP3500-S1-AF
			AGP3500-S1-AF-D81K
			AGP3500-S1-AF-D81C
			AGP3500-S1-AF-CA1M
	GP3500T		AGP3500-T1-D24

Continued

Series	Model	Model number	
		AGP3500-T1-D24-D81K	
		AGP3500-T1-D24-D81C	
		AGP3500-T1-D24-FN1M	
		AGP3500-T1-D24-CA1M	
		AGP3500-T1-AF	
		AGP3500-T1-AF-D81K	
		AGP3500-T1-AF-D81C	
		AGP3500-T1-AF-FN1M	
		AGP3500-T1-AF-CA1M	
		GP3510T	AGP3510-T1-AF
			AGP3510-T1-AF-CA1M
GP-3000 Series	GP3550T	AGP3550-T1-AF	
	GP3560T	AGP3560-T1-AF	
	GP3600T	AGP3600-T1-D24	
		AGP3600-T1-D24-D81K	
		AGP3600-T1-D24-D81C	
		AGP3600-T1-D24-FN1M	
		AGP3600-T1-D24-CA1M	
		AGP3600-T1-AF	
		AGP3600-T1-AF-D81K	
		AGP3600-T1-AF-D81C	
		AGP3600-T1-AF-FN1M	
	AGP3600-T1-AF-CA1M		
	GP3650T	AGP3650-T1-AF	
	GP3750T	AGP3750-T1-AF	
AGP3750-T1-D24			
IPC series	WinGP		

■ Supported Operating Systems

Windows[®] 2000 (Service Pack 3 or later),
Windows[®] XP (Service Pack 2)
Windows Vista[®] Ultimate
Windows Vista[®] Home Premium/Basic
Windows Vista[®] Business
Windows Vista[®] Enterprise
Windows Server[®] 2003 (Service Pack 2)

■ Screen resolution

1024x768 or higher

■ Difference between GP-Viewer EX and Displays

Feature	Details
Switches	<ul style="list-style-type: none"> • AUX Output cannot be used. • Special switches related to security, resetting, offline or other unsupported features cannot be used. • If switches overlap or use the Multifunctional List, operations may differ from the display unit.
Sampling Display	<ul style="list-style-type: none"> • You cannot edit data. • All of the sampled data is acquired at first, and then information is updated at a frequency set in GP-Viewer EX. Point to [Change setting] and select [Automatic update frequency of information].
Alarm feature	<ul style="list-style-type: none"> • The Sub Display feature may be executed at an unexpected time by operation on the display unit even when the alarm display unit is not displayed. • Alarm information cannot be cleared by external operation. • Display contents may be displayed differently from the display unit (time information, active alarm status, etc.) • You cannot save alarm information. • You cannot perform [Acknowledged] or [Clear] operation. • You cannot perform [Alarm Number Acquisition] operation.
Logic Programing Global D-Script Extended Script	You can review the results processed on the display unit, but the results of drawing are not reflected.
D-Script	<p>This feature is enabled in Synchronous Mode. However, the results of drawing are not reflected.</p> <p>This feature may be executed even in Asynchronous Mode when the same screen is displayed.</p>
Trigger Action	<ul style="list-style-type: none"> • This feature is executed in Asynchronous Mode when the same screen is displayed. In this case, changing screens on the display unit does not change screens in GP-Viewer. Therefore, execution of [Start Application] or [Exit WinGP] cannot be confirmed by GP-Viewer, so do not perform such operations from GP-Viewer. • This feature is enabled in Synchronous Mode. However, the results of drawing are not reflected.
Screen Capture	<ul style="list-style-type: none"> • The screen of the display unit cannot be captured with Screen Capture Settings. This should be performed from [Screen Capture] in the [Tool] menu.

Continued

Feature	Details
Error	<ul style="list-style-type: none"> • Displays errors on both the display unit and GP-Viewer EX. • All errors are acquired at first and then the information is updated at a frequency set in GP-Viewer EX. Point to [Change setting] and select [Automatic update frequency of information]. • Errors that are restored will not disappear. Such errors disappear only when the screen is changed.
Data Display	<ul style="list-style-type: none"> • In Numeric Display or Text Display, when Device Type & Address is specified for Address Type and a device (PLC) is used for Monitor Word Address, an error occurs.
Historical Trend Graph	<ul style="list-style-type: none"> • You cannot review Cursor Information Storage Address, Status Address and Search Status of the Viewer.
Data Block Display Graph	<ul style="list-style-type: none"> • In Asynchronous Mode, select [Block Display Graph] from the [Update (U)] menu to clear/re-display the graph. Follow the same procedure when update does not happen in Synchronous Mode.
XY Historical Scatter Graph	<ul style="list-style-type: none"> • Immediately after changing screens, all the data in the buffer is displayed on a graph, including the previously sampled data.
XY Block Display Scatter Graph XY Historical Scatter Graph Normalization	<ul style="list-style-type: none"> • When quickly changing, on the display unit, the control word using D-Script or a ladder of PLC to be connected, operations on the server may not be detected. • When updating the graph in Asynchronous Mode, the Display Completion bit of the graph does not turn ON. Therefore, the control word cannot be returned to 0 on the display unit. Place a switch for returning the control word to 0 in advance.
Bulletin Message	<ul style="list-style-type: none"> • When you perform a display/hide operation continuously, display contents may not be synchronized with the display unit. • In order to update the message, clear the message and display it again. • Display Completion bit cannot be operated.
Recipes	<ul style="list-style-type: none"> • The recipe feature does not work. Special Data Display (Data Transmission, Filing and Show CSV) is not displayed.
File Manager	<ul style="list-style-type: none"> • Status Address and Select Movie cannot be set. • Files in the GP-Viewer EX computer are displayed.
LS Area Memory Link	<ul style="list-style-type: none"> • You cannot write data in the Special Relay Area (LS2071 to LS2074, LS2078 to LS2095) from the Viewer. • Write operation into Special Relay Area and Extend System Area is not supported.

Continued

Feature	Details
Security Level Clear	<ul style="list-style-type: none"> To change or clear the level, go to Menu -> Feature -> Change Security Level or Switch User ID. You can set the security level to 0 if you leave the user ID/ password field blank and press the OK button. (This cannot be completed when the security is set for reading Viewer data.)
Standby Mode	<ul style="list-style-type: none"> The screen does not change to the standby mode. The display unit will switch to standby mode, but the screen will not be changed while the Viewer is connected.
Japanese FEP (Help)	<ul style="list-style-type: none"> Dictionary information registered on the display unit cannot be used.
Cursor Information Storage Address Status Address Search Status Address	<ul style="list-style-type: none"> Information on the items shown on the left for each part/feature cannot be obtained.
Operation Log	<ul style="list-style-type: none"> A log file is not saved.
Web Server and FTP Features	<ul style="list-style-type: none"> Web Server and FTP Features do not work.
Monitor	<ul style="list-style-type: none"> Logic Monitor, Ladder Monitor, Device Monitor, VM/DVI and RPA do not work.
Remote PC Access	<ul style="list-style-type: none"> RPA feature cannot be used.
Printing feature	<ul style="list-style-type: none"> The printing feature does not work.
Transfer Project File	<ul style="list-style-type: none"> Project files cannot be transferred.
Monitor	<ul style="list-style-type: none"> Device Monitor, Address Monitor and Ladder Monitor cannot be used.
2-color Backlight Switching	<ul style="list-style-type: none"> 2-color Backlight Switching cannot be used.
Offline mode	<ul style="list-style-type: none"> Cannot change to the offline mode.
Bar Code Reader	<ul style="list-style-type: none"> A bar code reader cannot be connected.
Modem	<ul style="list-style-type: none"> Cannot be connected to a modem.
Function Keys of Hand- held GP	<ul style="list-style-type: none"> Function keys of Hand-held GP cannot be operated.
Playing Movies	<ul style="list-style-type: none"> You cannot record or play movies. Parts are not displayed.
Others	<ul style="list-style-type: none"> Does not respond to the station search of Pro-Server EX.

37.2.2 Development Process

The following describes the process flow for starting GP-Pro EX, creating a new screen, displaying screen data from a display unit on a computer, installing GP-Viewer EX for operation, and operating GP-Viewer EX.

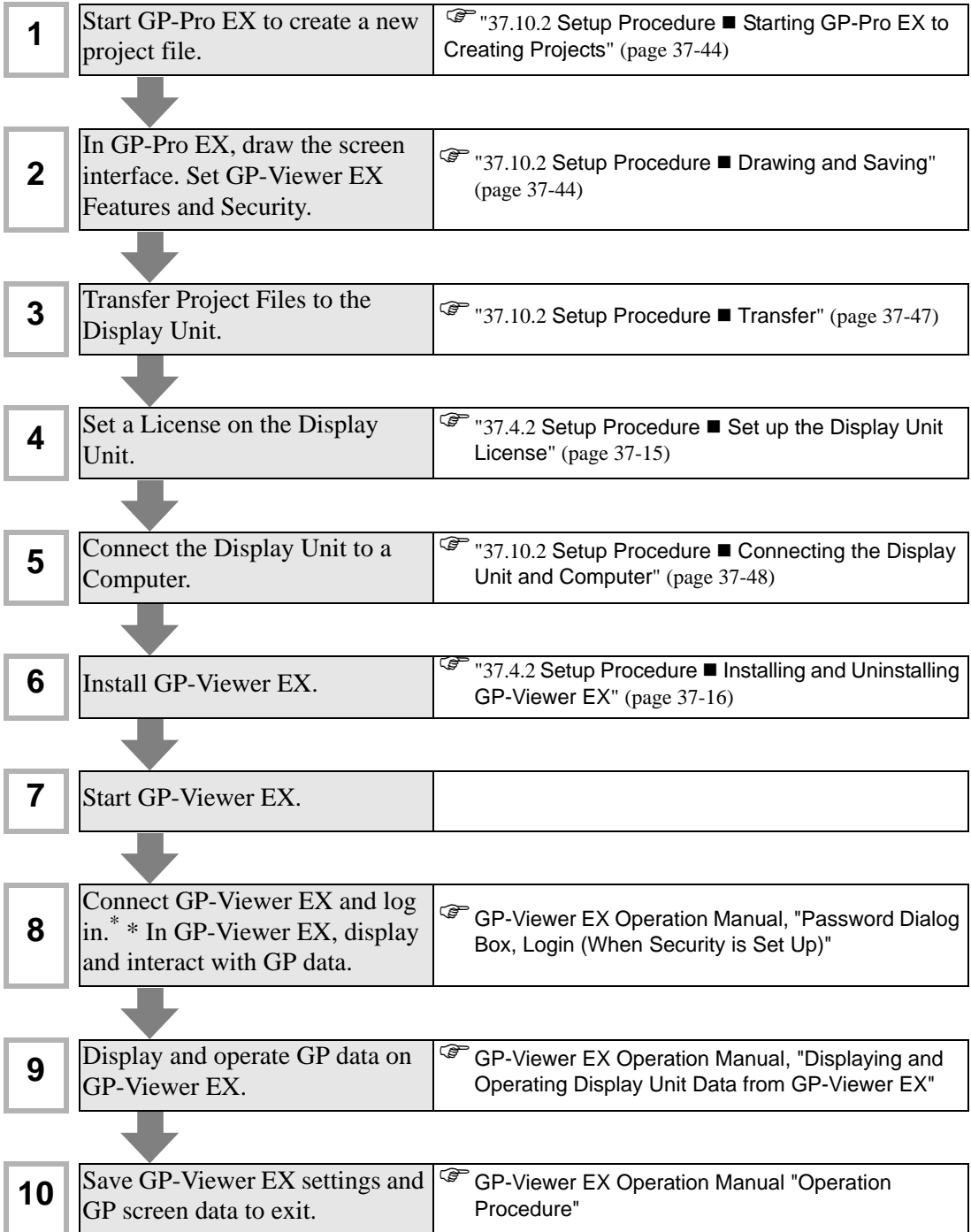

37.3 Settings Menu

Some models cannot use the features introduced in this chapter. Check whether your model supports the features before changing any settings.

☞ "1.3 Supported Features" (page 1-5)

Using GP-Viewer EX to Display and Operate GP Data

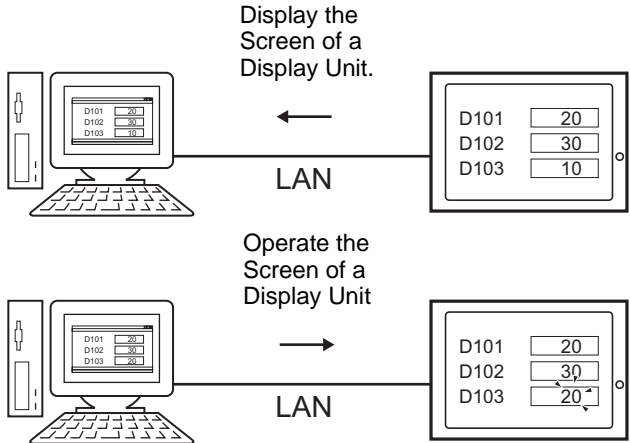

Display the Screen of a Display Unit.

←

LAN

Operate the Screen of a Display Unit

→

LAN

☞ "37.4.2 Setup Procedure" (page 37-12)

☞ "37.4.1 Introduction" (page 37-11)

Restricting Access to GP-Viewer EX

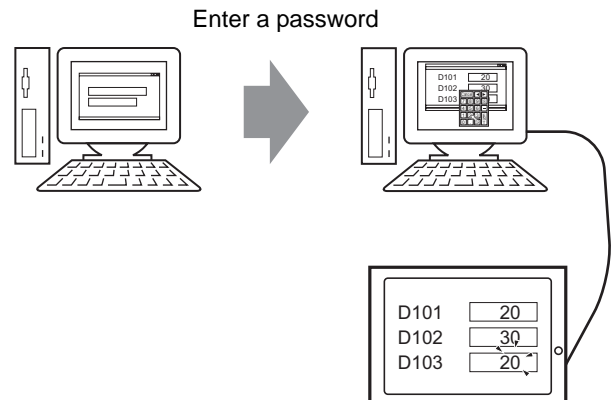

Enter a password

☞ "37.5.2 Setup Procedure" (page 37-20)

☞ "37.5.1 Introduction" (page 37-19)

37.4 Using GP-Viewer EX to Display and Operate GP Data

37.4.1 Introduction

By connecting the display unit (server), and the computer running GP-Viewer EX (client), you can use the computer to view screens on the display unit. Using this feature, you can check the displayed content and operate display units in remote locations. In the following example, you can acknowledge the alarm displayed on the GP.

IMPORTANT

- To use GP-Viewer EX, a separate license (Type: EX-VIEWER-LICENSE) is required for each display unit. With a single key code, you can view the display unit screen on up to three instances of GP-Viewer EX.
- The key code cannot be reissued if you lose it. Please keep it at hand.
- For more information on key code input, see  Maintenance/Troubleshooting Guide, "Setting up GP-Viewer EX or Remote PC Access License"

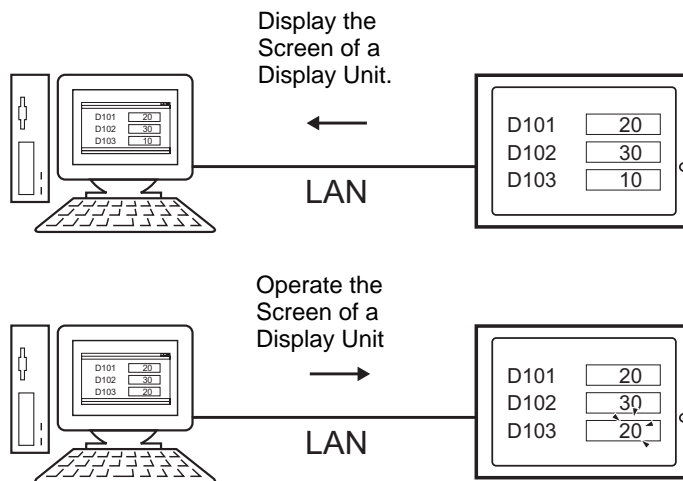

37.4.2 Setup Procedure

NOTE

- Please refer to the Settings Guide for details.
 ☞ "37.15.2 System Settings [Display Unit] - [Remote Viewer] Settings Guide" (page 37-80)

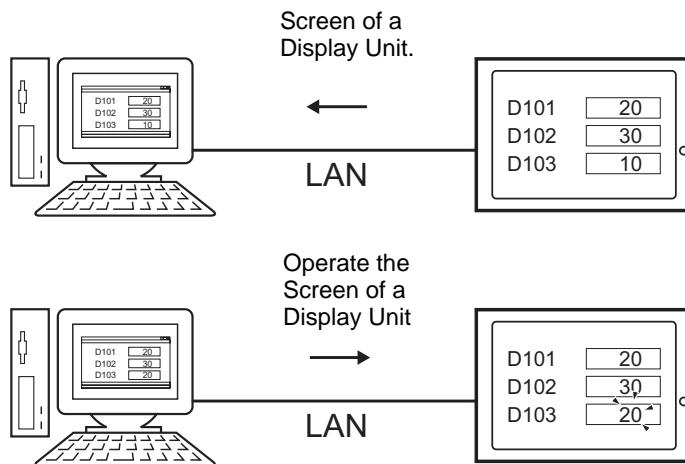

■ Necessary Device

- Display Unit. (See "37.2.1 Target models ■ Display Units" (page 37-4) for supported models.)
- GP-Pro EX (Ver.2.10 or later)
- GP-Viewer EX key code (Product sold separately. Model number: EX-VIEWER-LICENSE)
- Computer (For supported models, refer to "37.2.1 Target models ■ Supported Operating Systems" (page 37-5).)
- LAN cable and HUB (Commercial product)

■ Procedure Outline

- 1 Start GP-Pro EX to create a new project file.
- 2 In GP-Pro EX, draw the screen interface. Set GP-Viewer EX Features and Security.
- 3 Transfer the project to the display unit.
- 4 Set a License on the Display Unit.
- 5 Connect the Display Unit to a Computer.
- 6 Install GP-Viewer EX on the computer.
- 7 Start GP-Viewer EX.

■ From Starting GP-Pro EX to Creating Project Files

Start GP-Pro EX to create a new project file. The startup method is the same procedure as "5.2.2 Setup Procedure" (page 5-10).

NOTE

- Please refer to the Settings Guide for details.
☞ "5.17.2 [New] Settings Guide" (page 5-102)
-

■ Drawing and Saving

◆ Drawing

Draws pictures. For drawing methods, refer to "5.2.2 Setup Procedure ■ Creating/Saving" (page 5-15). You can also refer to chapters related to particular features, such as alarms.

IMPORTANT

- There are differences in which features can be used in GP-Viewer EX. The following describes which features you can use in GP-Viewer EX.
☞ " ■ Difference between GP-Viewer EX and Displays" (page 37-6)
-

◆ GP-Viewer EX Features

In the System Settings workspace, click [Display Unit] and select the [Remote Viewer] tab. Select the [Enable Remote Viewer] check box to use GP-Viewer EX. Select the [Enable Screen Changes From Client] check box to run screen change operations on the display unit from a remote PC.

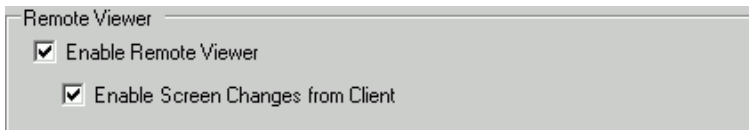

NOTE

- Even when [Enable Screen Changes from Client] is set, if [Write GP-Viewer Data] is disabled in the security setup, the screen change from GP-Viewer cannot be performed.
-

◆ Operation Lock

When multiple GP-Viewers are connected, it is possible to configure them to protect against multiple users touching screens simultaneously, by locking the other units after you touch one GP screen or GP-Viewer.

In the System Settings workspace, select [Display Unit] and click [Extended Settings]. Select the [Enable Operation Lock] check box in [Operation Lock].

When you select the Lock Screen touch check box, you can use the [Timeout] window to enter how many seconds to count down until the other GP or GP-Viewer screens are unlocked after the last touch on the enabled GP or GP-Viewer screen.

NOTE

- For more details on Operation Lock, refer to the following:
☞ "7.6 In a Multiple GP Environment, Make Only One GP Active" (page 7-35)
-

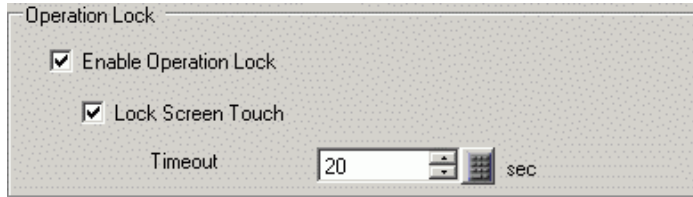

◆ **Security**

You can restrict access to GP-Viewer EX by adding security to display screens or individual features. In the following example, security is set up for screen data operations run from a computer. Level 1 users can display screen data, and Level 15 users can display and operate screen data.

- 1 In GP-Pro EX, from the [Common Settings (R)] menu point to [Security (Q)], select [Security Password (P)], or click  .

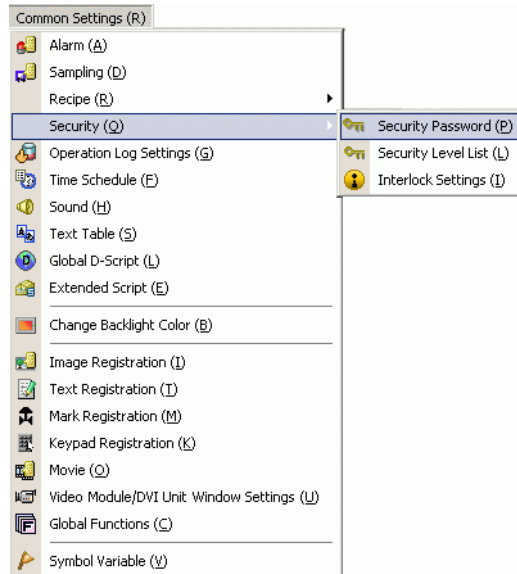

- 2 The password setting screen will open. Check [Enable Security Function] and input password "1111" in [Level 1] and password "5555" in [Level 15].

NOTE

- To set up user IDs for each level, see the following.
 "37.5.2 Setup Procedure ■ User ID Mode" (page 37-22)

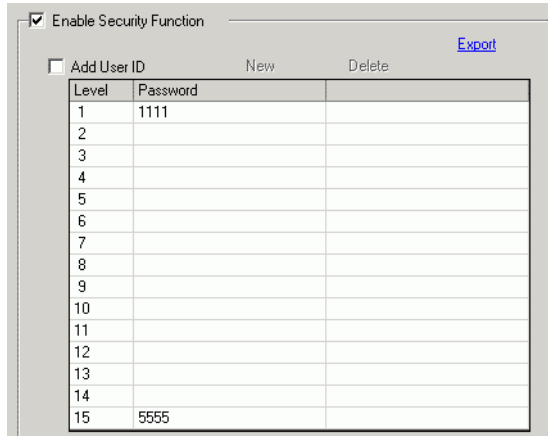

3 Next, when you select the [Set up Functions For Each Feature] check box, you can define which functions are permitted at each security level set in procedure 2 above. (For example, [Read GP-Viewer Data] = Level 1, [Write GP-Viewer Data] = Level 15)

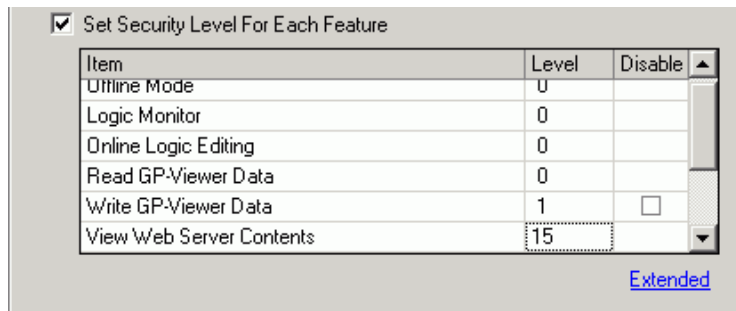

NOTE

- If you select Disable, the function cannot be performed regardless of the security level.
- After selecting Disable, if you want to change it to Enable, modify the project file with drawing software and then transfer it again. You cannot change it to Enable from the offline menu.

Transfer

Transfer Project Files to the Display Unit.

For the procedure for transferring project files, refer to the following.

☞ "33.1 Settings Menu" (page 33-2)

Set up the Display Unit License

On the display unit, go to offline mode, and then touch [Main Unit], [Extended Settings], and [GP-Viewer EX Key Code].

For details about how to set up the license, refer to the following.

 Maintenance/Troubleshooting Guide, "Setting up GP-Viewer EX or Remote PC Access License"

IMPORTANT

- To use GP-Viewer EX, a separate license (Type: EX-VIEWER-LICENSE) is required for each display unit. With a single key code, you can view the display unit screen on up to three instances of GP-Viewer EX.
 - The key code cannot be reissued if you lose it. Please keep it at hand.
 - When starting GP-Viewer EX without setting up the key code on the display unit, the trial version will start.
-

■ Connecting the Display Unit and Computer

Use the network HUB or Ethernet cable to connect the display unit to the computer.

IMPORTANT

- To communicate using Ethernet, Ethernet settings, such as the IP address and port number, must be set up on the GP.
-

NOTE

- Set up the display unit's IP address in Offline mode. Touch [Main Unit] and [Ethernet Setup]. For details on the setup procedure, refer to the following.
 Maintenance/Troubleshooting Guide, "Assigning an IP Address to the Display"
 - Make sure to use a HUB for Ethernet Communication. 1:1 connections using a cross cable may not be possible depending on the type of PC and network card you are using.
-

■ Installing and Uninstalling GP-Viewer EX

◆ Install

Install GP-Viewer EX on the computer. Please install GP-Viewer EX using the GP-Pro EX 2.10 or later installation CD. You can download updates from the Pro-face Web site.

IMPORTANT

- GP-Viewer EX does not run if installed on an unsupported computer.
 - Use a user account with administrator authority for installation.
 - Exit all programs including virus check software.
-

NOTE

- GP-Viewer EX does not have an Online Update feature.
-

- Installing from CD (GP-Pro EX Ver.2.10 or later)

1 Place the GP-Pro EX installation CD-ROM (Disk2) in the computer's CD drive.

2 In the GP-Pro EX set up screen, click [GP-Viewer EX].



3 Follow the instructions in the installation wizard.

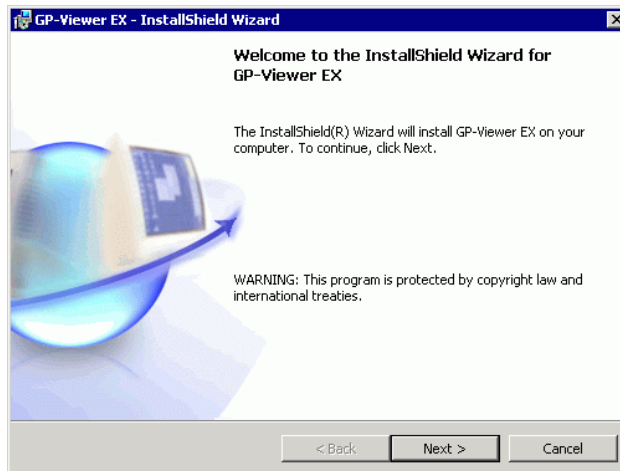

4 To specify the installation folder, in the next screen click [Change] and define a folder path with 80 single-byte characters or less.

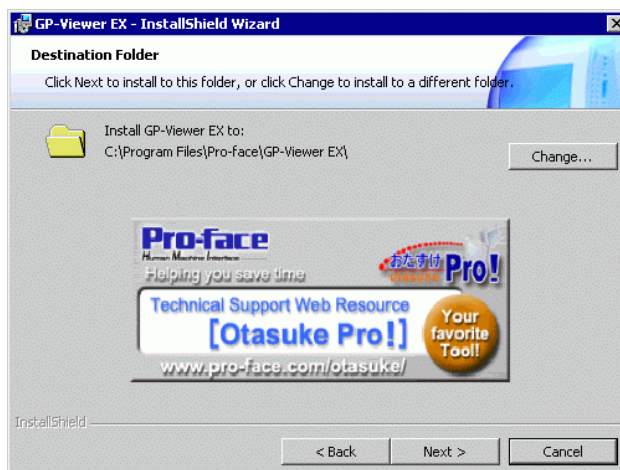

5 The following message appears. Click OK to complete the installation.

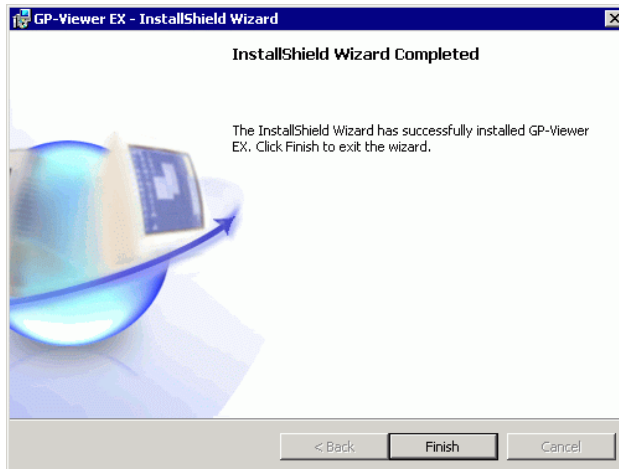

- Downloading and Installing Updates from the Web site

1 After downloading, double-click the file. In the confirmation message box click [RUN].

2 Follow the instructions in the installation wizard.

◆ Uninstall

Uninstall GP-Viewer EX from the computer.

Uninstall using Windows Control Panel, [Add/Remove Programs]

From the task bar, click [Start], point to [Settings] and then click [Control Panel]. In the [Control Panel], select [Add/Remove Programs]. In the list of installed applications, select [GP-Viewer EX] and click [Remove] to uninstall.

37.5 Restricting Access to GP-Viewer EX

37.5.1 Introduction

Set up security to place restrictions on which people can display and operate GP-Viewer EX to view and interact with data on the display unit. Set up security level 15 and password "5555" for maintenance staff. Set up security level 1 and password "1111" for status monitoring staff.

For the security settings, there are level mode settings and user ID mode settings.

Enter a password

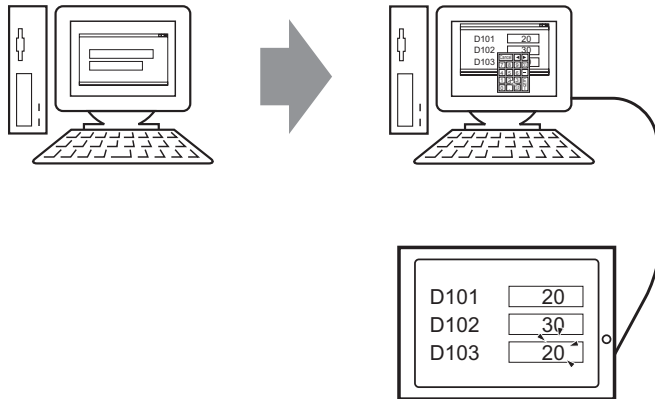

37.5.2 Setup Procedure

- NOTE**
- Please refer to the Settings Guide for details.
 ☞ "22.10.1 Common (Security Settings) Settings Guide" (page 22-40)

Set up security level 15 and password "5555" for maintenance staff. Set up security level 1 and password "1111" for status monitoring staff.

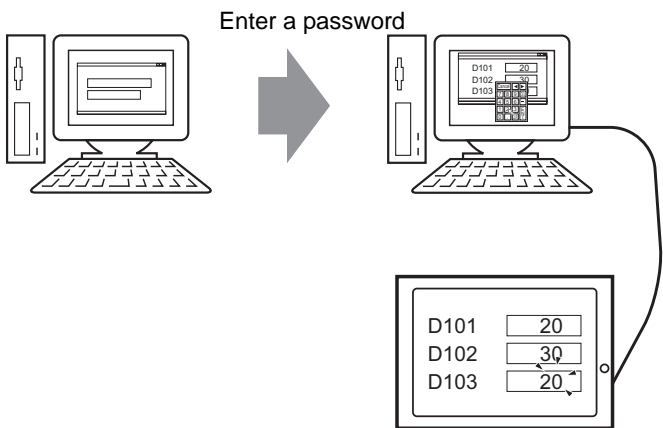

- NOTE**
- Security level 0 means no security is set.

■ Level Mode

Registers passwords for security levels 1 to 15 and defines the security level for each display screen.

- 1 From the [Common Settings (R)] menu, point to [Security (Q)] and select [Security Password (P)] or click  on the toolbar.

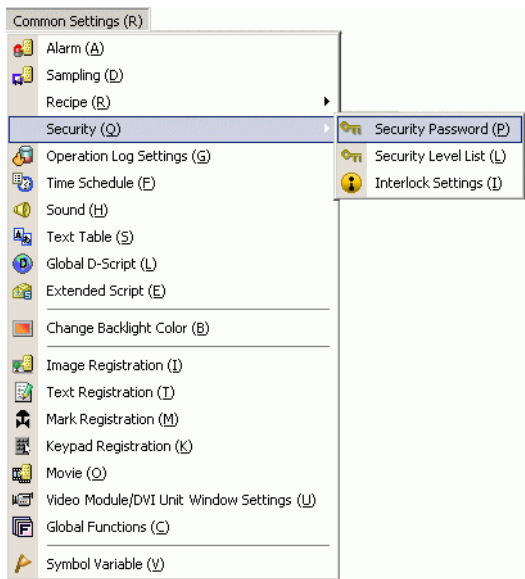

2 The password setting screen will open. Select the [Enable Security Function] check box and type password "1111" for [Level 1], and password "5555" for [Level 15].

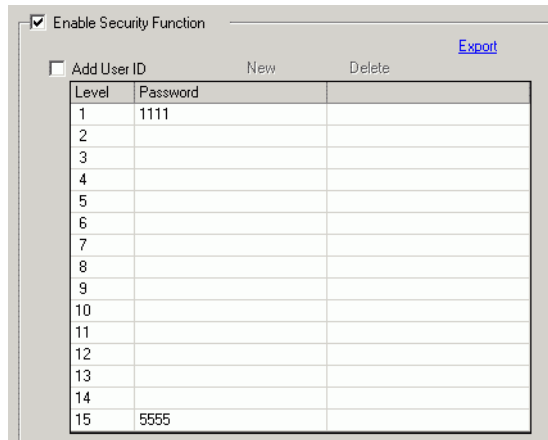

NOTE

- Each password should be 8 single-byte characters or less.

3 Next, select the [Set up Functions at Each Security Level] check box and define the security level set in the above procedure 2 for each [Item]. (For example, [Read GP-Viewer Data] = Level "1", [Write GP-Viewer Data] = Level "15")

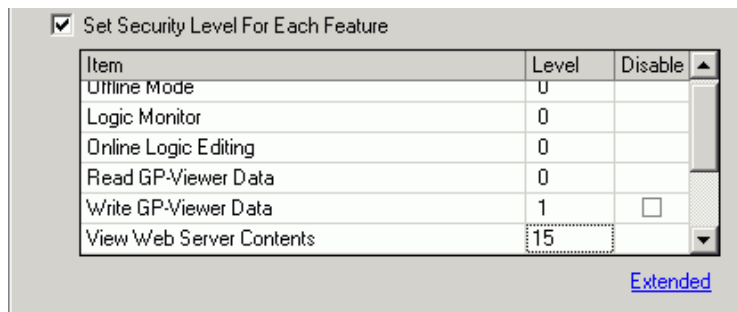

NOTE

- If you select Disable, the function cannot be performed regardless of the security level.
- After selecting Disable, if you want to change it to Enable, modify the project file with drawing software and then transfer it again. You cannot change it to Enable from the offline menu.

- 4 From the [Common Settings (R)] menu, point to [Security (Q)] and select [Security Level List (L)].



- 5 For the monitor screen (Screen: B1) set a [Security Level] of 1, and for the maintenance screen (Screen: B2) set a [Security Level] of 15.

Screen	Security Level	Title
B1	1	Monitor Screen
B2	15	Maintenance Screen

NOTE

- After setting up security levels, transfer the project to the display unit.
- Refer to the following for information on security operations in GP-Viewer EX.

☞ GP-Viewer EX Operation Manual, "Displaying and Operating Display Unit Data from GP-Viewer EX"

■ User ID Mode

Register user IDs and passwords for each security level, then the security level for each display screen.

- 1 From the [Common Settings (R)] menu, point to [Security (Q)] and select [Security Password (P)] or click  on the toolbar.

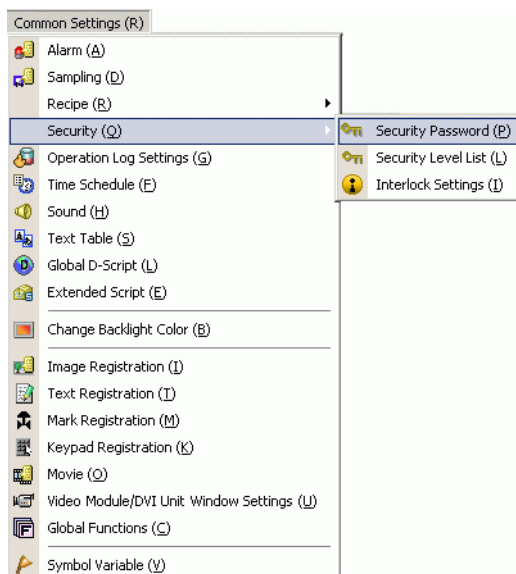

- 2 In the Set Password screen, select the [Enable Security Function] and [Add User ID] check boxes. Click [Create] to add one set of settings: Security Level, User ID, and Password.

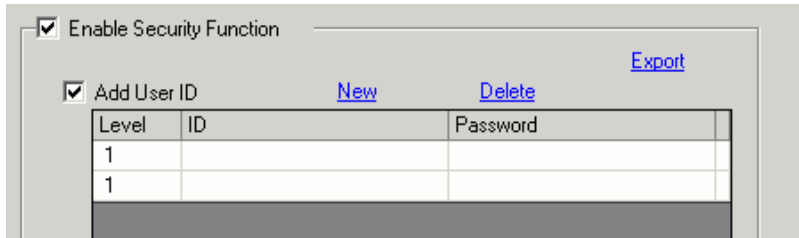

The screenshot shows a web interface for setting security. At the top, there is a checkbox labeled 'Enable Security Function' which is checked. To the right of this checkbox is a blue link labeled 'Export'. Below this, there is another checkbox labeled 'Add User ID' which is also checked. To the right of this checkbox are two blue links: 'New' and 'Delete'. Below these elements is a table with three columns: 'Level', 'ID', and 'Password'. The table contains two rows, both with the value '1' in the 'Level' column. The 'ID' and 'Password' columns are currently empty.

Level	ID	Password
1		
1		

- 3 Set the security level, user ID, and password for status monitoring and maintenance staff (for example, Status Monitoring: (For example, Status Monitoring: [Level] = "1", [Password] = "1111", [ID] = "Monitor"; Maintenance: [Level] = "15", [Password] = "5555", [ID] = "Admin")

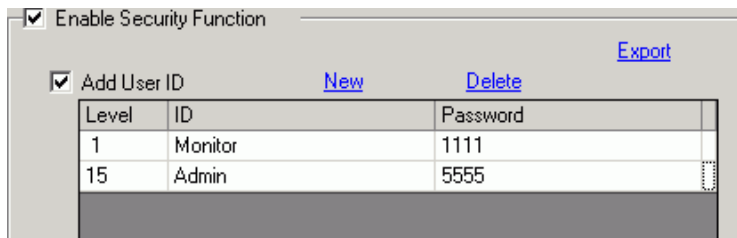

The screenshot shows the same web interface as before, but now the 'Add User ID' table is populated with two rows. The first row has '1' in the 'Level' column, 'Monitor' in the 'ID' column, and '1111' in the 'Password' column. The second row has '15' in the 'Level' column, 'Admin' in the 'ID' column, and '5555' in the 'Password' column. The 'Enable Security Function' and 'Add User ID' checkboxes remain checked, and the 'Export', 'New', and 'Delete' links are still present.

Level	ID	Password
1	Monitor	1111
15	Admin	5555

NOTE

- Each password should be 8 single-byte characters or less.

- 4 Next, select the [Set up Functions at Each Security Level] check box and define the security level set in the above procedure 2 for each [Item]. (For example, [Read GP-Viewer Data] = Level "1", [Write GP-Viewer Data] = Level "15")

Item	Level	Disable
Offline Mode	0	
Logic Monitor	0	
Online Logic Editing	0	
Read GP-Viewer Data	0	
Write GP-Viewer Data	1	<input type="checkbox"/>
View Web Server Contents	15	

[Extended](#)

NOTE

- When defining [Read GP-Viewer Data], first set up the level for [Write GP-Viewer Data].
- After setting up security levels, transfer the project to the display unit.
- Refer to the following for information on security operations in GP-Viewer EX.
 - ☞ GP-Viewer EX Operation Manual, "Displaying and Operating Display Unit Data from GP-Viewer EX"
- If you select Disable, the function cannot be performed regardless of the security level.
- After selecting Disable, if you want to change it to Enable, modify the project file with drawing software and then transfer it again. You cannot change it to Enable from the offline menu.

IMPORTANT

- When security is not set up for [Read GP-Viewer Data], the security level is reset to 0 if an incorrect password is entered in the [Switch User ID] or [Change Security Level] dialog box.

37.6 Using Synchronous and Asynchronous Modes with GP-Viewer EX

37.6.1 Screen Mode

In screen mode, there are two methods of displaying GP-Viewer EX: Synchronous Mode and Asynchronous Mode. Synchronous mode shows the same screen data as the display unit. Asynchronous Mode shows screen data independent of screen changes on the display unit. The screen mode, the security level on the display unit, and the GP-Viewer EX login security level affect GP-Viewer EX operations. The following describes how the relationship between the screen mode and security level affects operations.

Screen mode	
Synchronous Mode	GP-Viewer EX displays the same screen as the display unit.
Asynchronous Mode	GP-Viewer EX can display a different screen than the display unit. Screen changes on the display unit do not affect the GP-Viewer EX screen.

37.6.2 On GP-Viewer EX Startup

The relationship between the screen mode and security level when starting up GP-Viewer EX is as follows.

Setting file	Screen mode when saving setting files	GP-Viewer EX operation
None	—	If you succeed in login at a security level of the screen displayed on the display and above, the screen of the display is displayed in [Synchronous Mode].
		As you do not have appropriate security access rights to view the current screen on the display unit, it shows the display unit's initial screen in [Asynchronous Mode].
Enable	Synchronous Mode	If you succeed in login at a security level of the screen displayed on the display and above, the screen of the display is displayed in [Synchronous Mode].
		As you do not have appropriate security access rights to view the current screen on the display unit, it shows the display unit's initial screen in [Asynchronous Mode].
	Asynchronous Mode	Shows the display unit's initial screen in [Asynchronous Mode].

37.6.3 When Changing Screens

(1) Synchronous Mode (When the display unit and GP-Viewer EX security levels are the same "1")

- Changing screens from the display unit

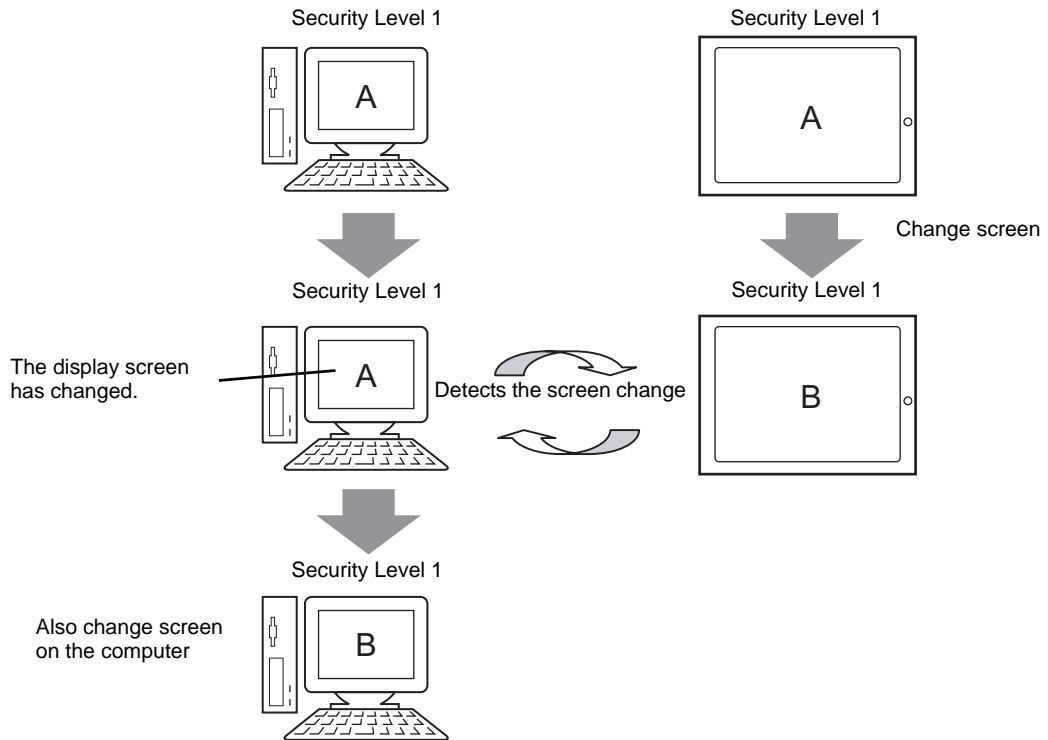

- Changing screens from GP-Viewer EX

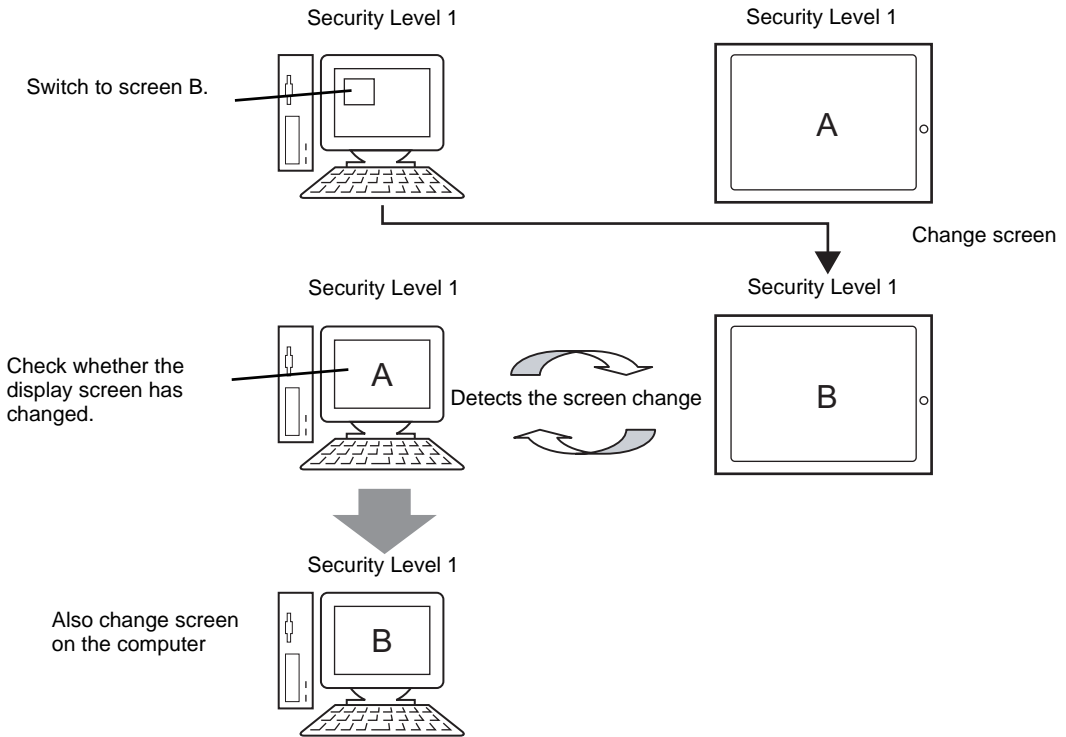

(2) Synchronous Mode (When the display unit security level is "10", and the GP-Viewer EX security level is "1")

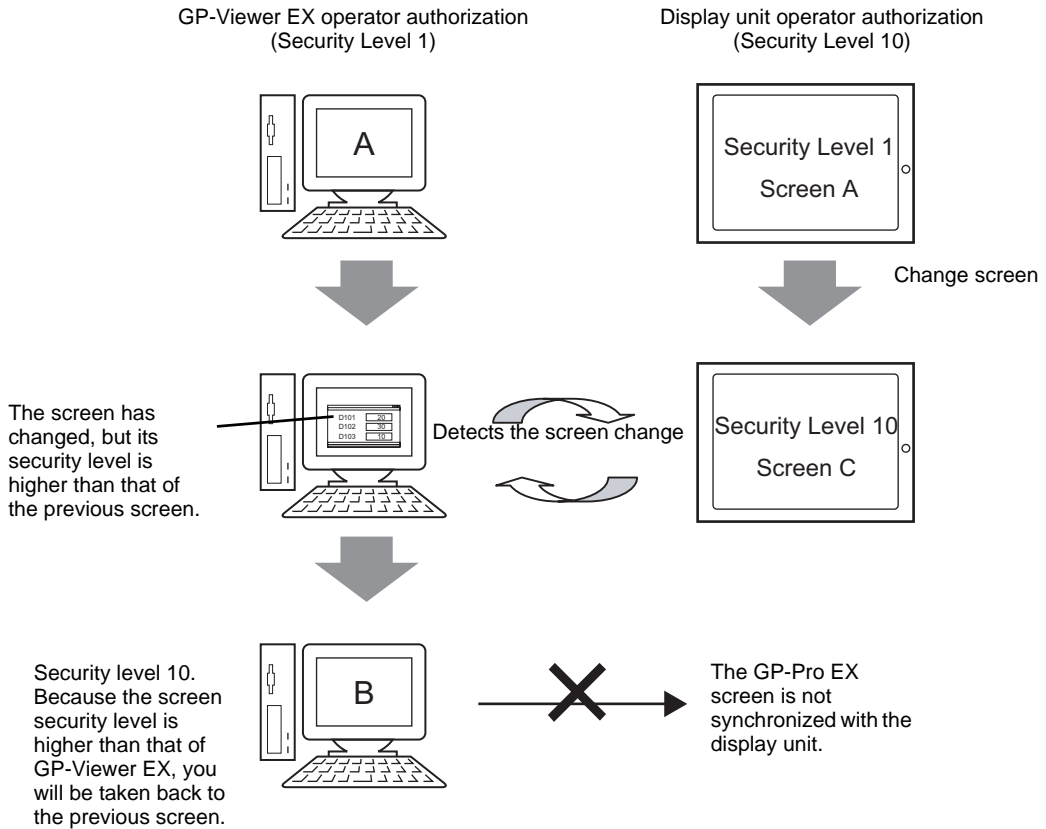

- NOTE**
- When GP-Viewer EX does not have access rights to security level 10, in the screen authentication dialog box click [Cancel] to return to the previous screen and enter [Asynchronous Mode].
 - When GP-Viewer EX has access rights to security level 10, type the password to display the same screen as the display unit.
 - If a popup window operation occurs at the same time as a screen change, even if authorization on the display unit is not at security level 10, the popup window operation may be forced through.

(3) Synchronous Mode (When the display unit security level is "1", and the GP-Viewer EX security level is "10")

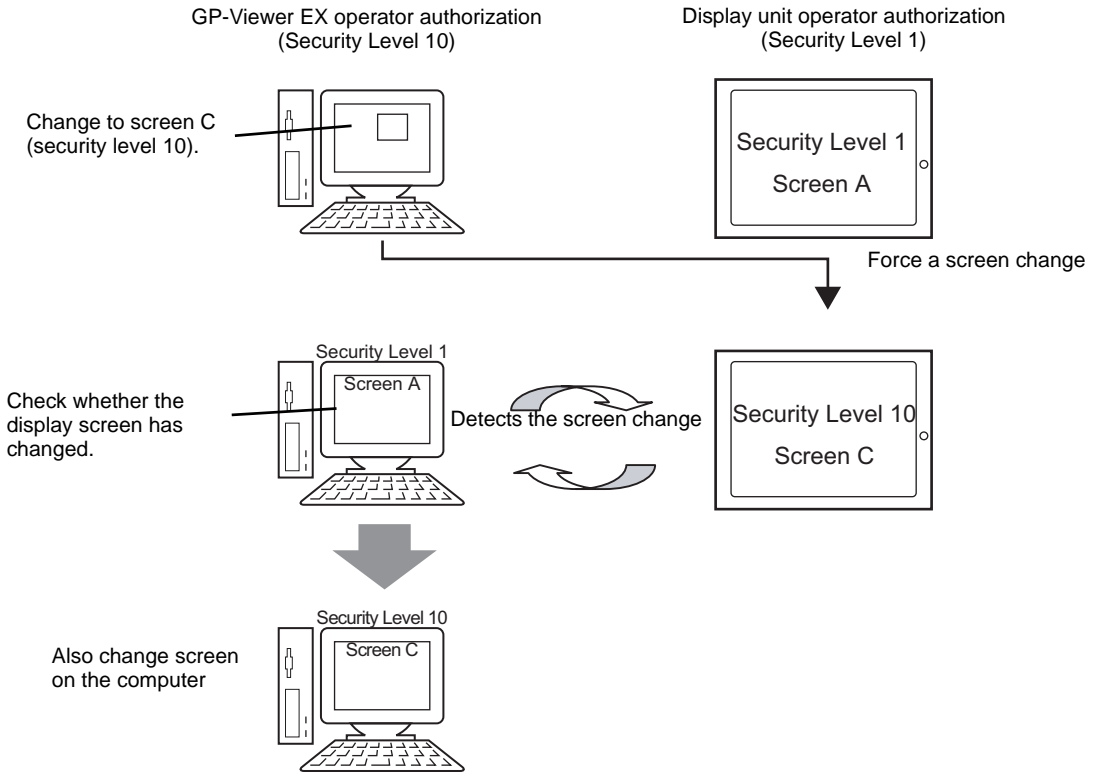

IMPORTANT

- When you use GP-Viewer EX to change the display unit to a higher security level screen, before terminating the GP-Viewer connection you should return the display unit to a screen with a security level that allows operations by the current panel operator. When you use GP-Viewer EX to temporarily change to a higher security level, the panel operator on the display unit logged in at a lower security level may not be able to run any operations. If you exit GP-Viewer EX with the display unit at a high security level, reconnect to the display unit using GP-Viewer EX then change to a lower security level screen.

(4) Asynchronous Mode (When the GP-Viewer EX security level is "1")

GP-Viewer EX does not synchronize its screen with the display unit. Even if a screen change occurs on the GP, GP-Viewer EX continues displaying the same screen.

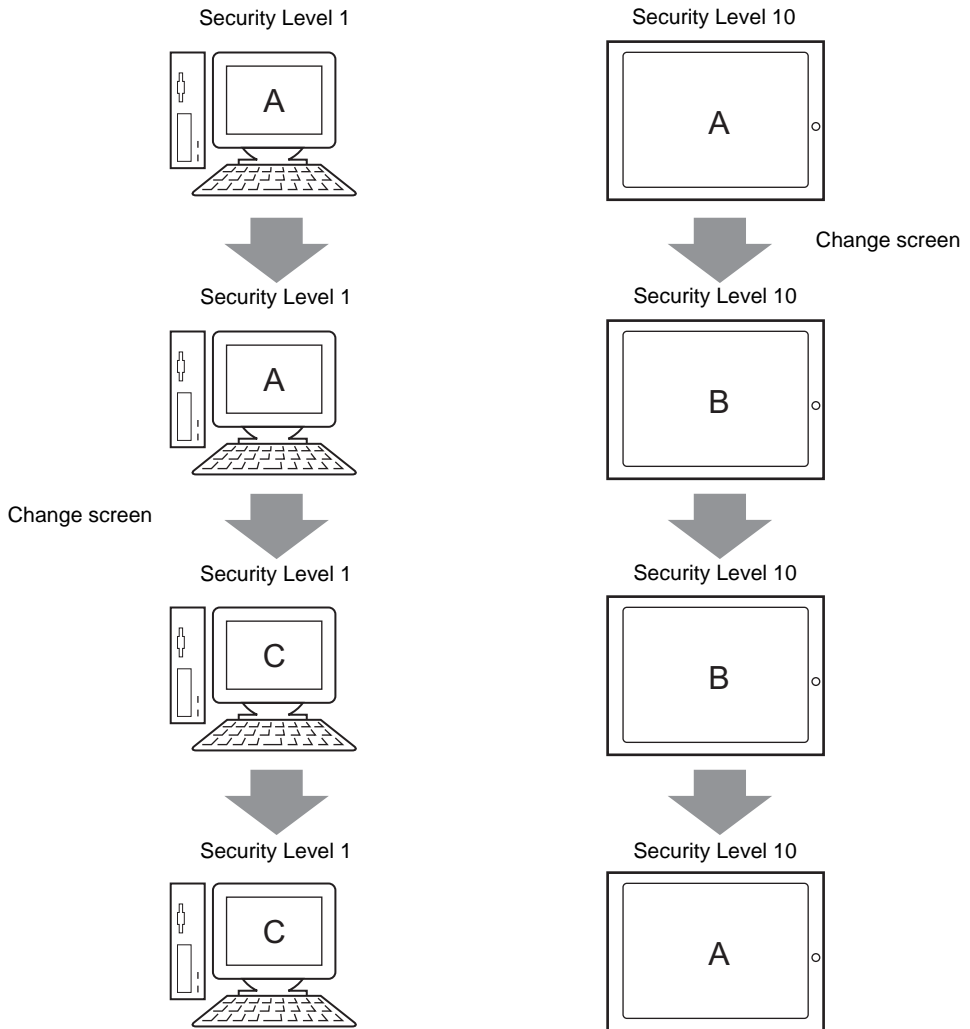

37.6.4 When Running Screen Operations

Screen mode	Screen Change Change Screen (Enable/Disable)	Write from GP-Viewer EX	GP-Viewer EX operation
Synchronous Mode	O	O	Operations on GP-Viewer EX are reflected by the display unit. Note that only the displayed screen is the same, and that not all operations are synchronized. For example, for alarm display operations, the scroll position between the display unit and GP-Viewer EX may be different.
	X	O	You can view the current screen on the display unit and change device address values, but you cannot initiate screen change operations. However, if a change in a device address value triggers the screen change operation, then the display unit will change screens, and the GP-Viewer EX screen will follow suit.
	O	X	Remote display of the display unit screen. On screen change, an authentication screen displays. If authentication is successful, you can change screens from GP-Viewer EX. Successful authentication allows change screen operations with the connection, as well as write operations from GP-Viewer EX.
	X	X	Remote display of the display unit screen. Operations are not allowed. Changing screens on the display unit also changes screens in GP-Viewer EX.

Continued

Screen mode	Screen Change Change Screen (Enable/ Disable)	Write from GP-Viewer EX	GP-Viewer EX operation
Asynchronous Mode	O or X (Does not depend on the screen change settings)	O	You can use GP-Viewer EX to display a different screen from the display unit, to enable daily monitoring. If maintenance is required, login with the appropriate security level, and write values to device addresses.
	O or X (Does not depend on the screen change settings)	X	For maintenance purposes, you can remotely monitor the screen. No operations or changes are possible. Always displays the defined screen for daily monitoring.

37.7 Display/Maintain GP Alarms or Device Addresses with Web Server/Browser

37.7.1 Web Server

■ Summary

The Web Server makes alarms and device addresses available for display in Internet Explorer. You can also access files on a CF Card or a USB storage device, allowing for simple maintenance tasks.

To use the Web Server, the computer and display unit must be on the same network, and in the GP-Pro EX Remote Viewer settings, the [Web Server] group's [Enable Web Server] check box must be selected.

■ License

This feature does not require a license.

The CD for GP-Pro EX version 2.10 or later comes standard with Web Contents. You can use Web Contents by downloading it to the GP, and using a computer attached to the same network to view the web contents on the GP.

■ Full Configuration

The following describes the layout of connections and options when using the Web Server.

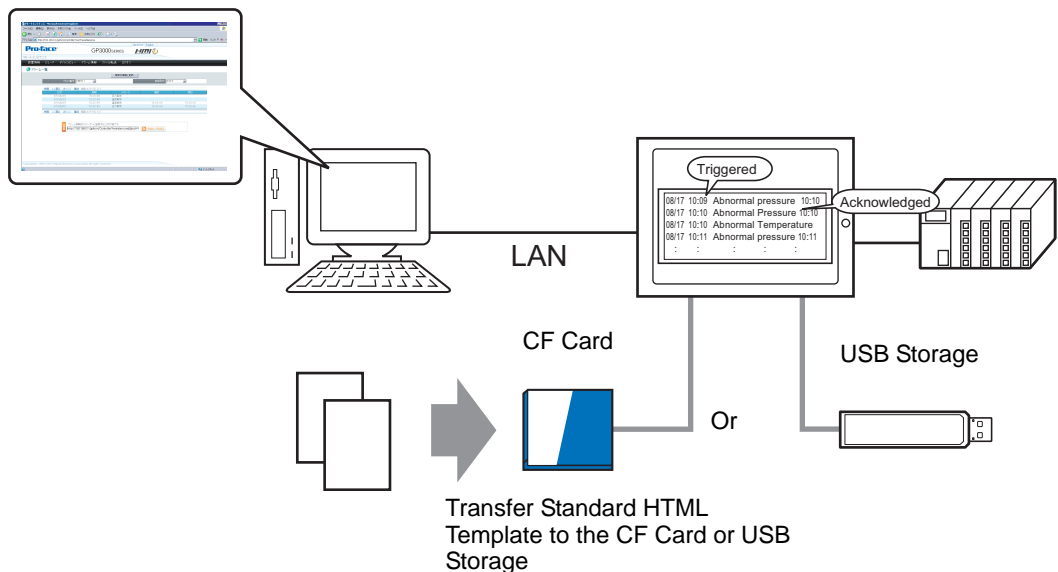

37.8 Web Server Operation Environment and Development Flow

37.8.1 Target models

The following lists the display unit models that support Web Server.

■ Display Units

Series	Model	Model number	
GP-3000 Series	GP3200A ^{*1}	AGP3200-A1-D24	
	GP3200T ^{*1}	AGP3200-T1-D24	
	GP-3300HL	AGP3300H-L1-D24	
	GP-3300HS	AGP3300H-S1-D24	
	GP-3310HT	AGP3310H-T1-D24	
	GP3300L ^{*1}		AGP3300-L1-D24
			AGP3300-L1-D24-D81K
			AGP3300-L1-D24-D81C
			AGP3300-L1-D24-FN1M
			AGP3300-L1-D24-CA1M
	GP3300S ^{*1}		AGP3300-S1-D24
			AGP3300-S1-D24-D81K
			AGP3300-S1-D24-D81C
			AGP3300-S1-D24-CA1M
	GP3300T ^{*1}		AGP3300-T1-D24
			AGP3300-T1-D24-D81K
			AGP3300-T1-D24-D81C
			AGP3300-T1-D24-FN1M
			AGP3300-T1-D24-CA1M
	GP3400S		AGP3400-S1-D24
			AGP3400-S1-D24-D81K
			AGP3400-S1-D24-D81C
			AGP3400-S1-D24-CA1M
	GP3400T		AGP3400-T1-D24
			AGP3400-T1-D24-D81K
			AGP3400-T1-D24-D81C
			AGP3400-T1-D24-FN1M
			AGP3400-T1-D24-CA1M
	GP3450T		AGP3450-T1-D24
	GP3500L		AGP3500-L1-D24
			AGP3500-L1-D24-D81C
	GP3500S		AGP3500-S1-D24
AGP3500-S1-D24-D81K			
AGP3500-S1-D24-D81C			

Continued

Series	Model	Model number
GP-3000 Series		AGP3500-S1-D24-CA1M
		AGP3500-S1-AF
		AGP3500-S1-AF-D81K
		AGP3500-S1-AF-D81C
		AGP3500-S1-AF-CA1M
	GP3500T	AGP3500-T1-D24
		AGP3500-T1-D24-D81K
		AGP3500-T1-D24-D81C
		AGP3500-T1-D24-FN1M
		AGP3500-T1-D24-CA1M
		AGP3500-T1-AF
		AGP3500-T1-AF-D81K
		AGP3500-T1-AF-D81C
		AGP3500-T1-AF-FN1M
		AGP3500-T1-AF-CA1M
	GP3510T	AGP3510-T1-AF
		AGP3510-T1-AF-CA1M
	GP3550T	AGP3550-T1-AF
	GP3560T	AGP3560-T1-AF
	GP3600T	AGP3600-T1-D24
		AGP3600-T1-D24-D81K
		AGP3600-T1-D24-D81C
		AGP3600-T1-D24-FN1M
		AGP3600-T1-D24-CA1M
		AGP3600-T1-AF
		AGP3600-T1-AF-D81K
		AGP3600-T1-AF-D81C
		AGP3600-T1-AF-FN1M
		AGP3600-T1-AF-CA1M
	GP3650T	AGP3650-T1-AF
	GP3750T	AGP3750-T1-AF
		AGP3750-T1-D24

*1 When using the Web Server with GP-3200 and 3300 Series display units, 1 MB must be reserved in the User Screen Area. The Web Server adds 1 MB to the send data size.

■ Supported Operating Systems

The following lists operating systems that support the Web Server.

Windows[®] 2000 (Service Pack 3 or later),

Windows[®] XP (Service Pack 2)

Windows Vista[®] Ultimate

Windows Vista[®] Home Premium/Basic

Windows Vista[®] Business

Windows Vista[®] Enterprise

Windows Server[®] 2003 (Service Pack 2)

■ Target browser

Internet Explorer 6

Internet Explorer 7

37.8.2 Supported Features

■ Features that Enable Display and Operations with Standard HTML Templates

- Log in to Web site
- Log off from Web site
- Device View
- When GP-Viewer EX is installed on the computer, start GP-Viewer EX
- Connect to the display unit's CF Card or USB storage using the FTP server function to get files, delete files, change attributes, and write files
- Alarm display
- Alarm display (RSS data display)

37.8.3 Development Process

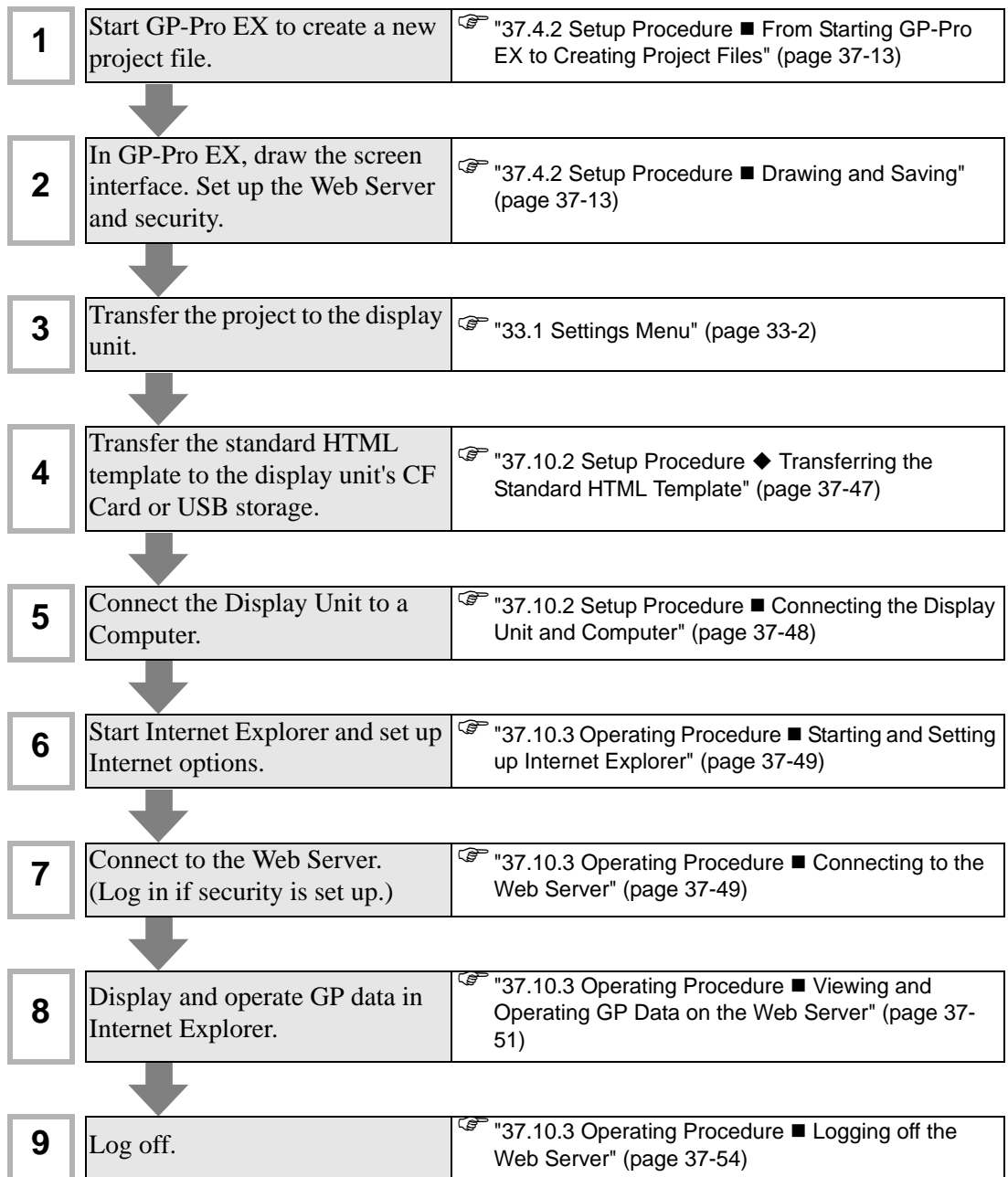

37.9 Settings Menu

Some models cannot use the features introduced in this chapter. Check whether your model supports the features before changing any settings.

☞ "1.3 Supported Features" (page 1-5)

37.9.1 Web Server Settings

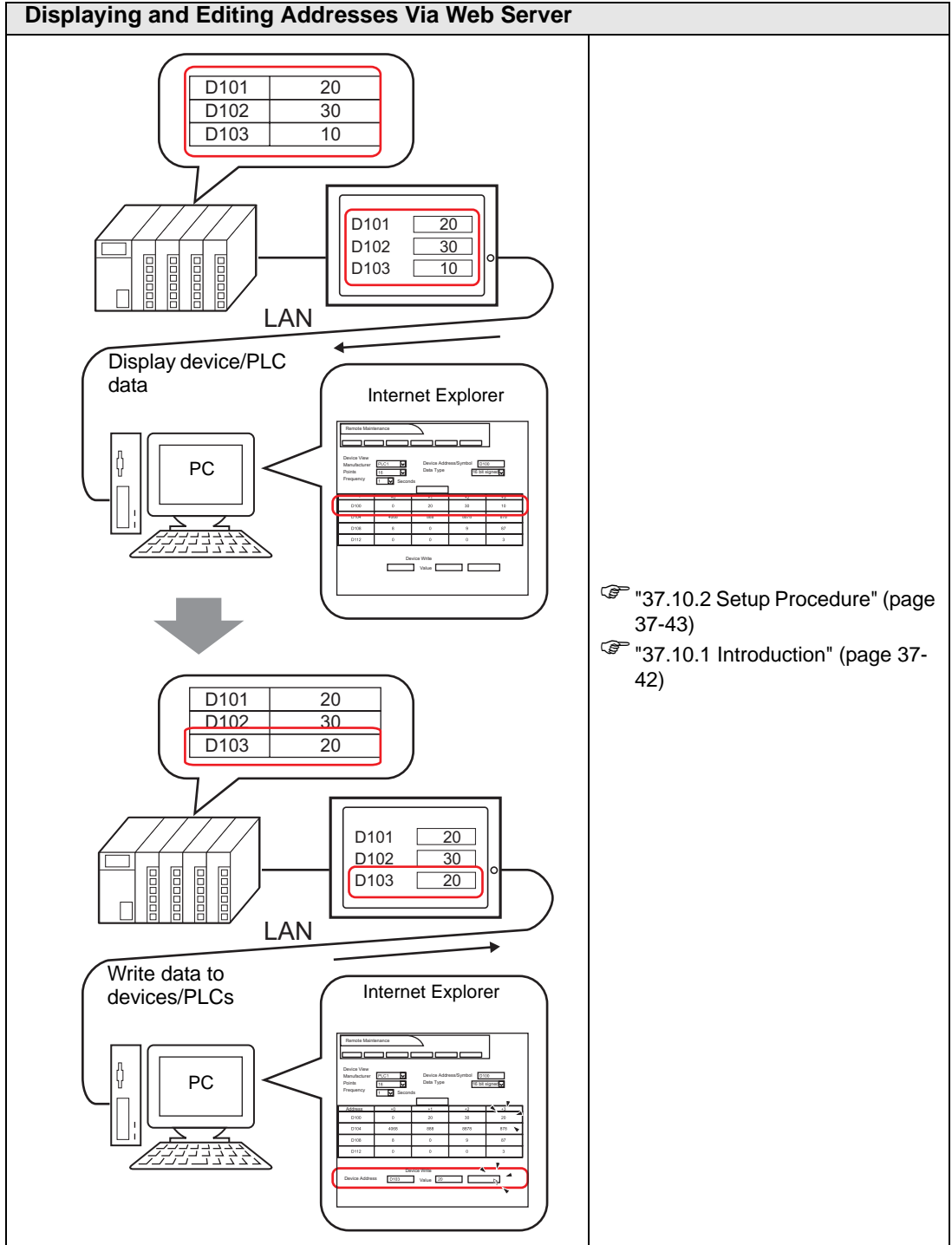

Displaying Alarm information on the Web Server

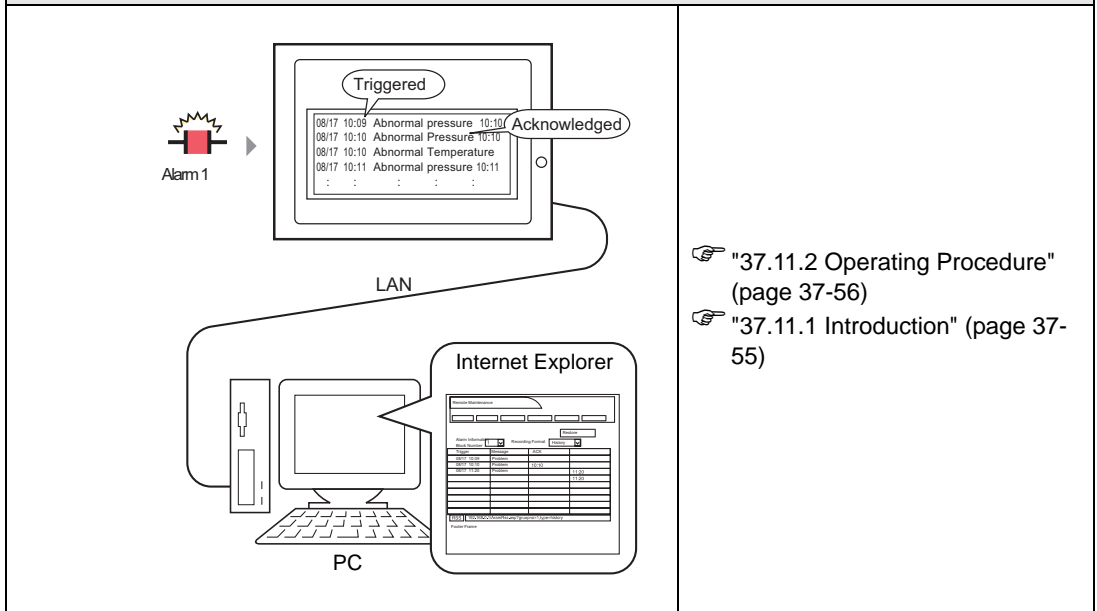

Displaying Alarm Information as RSS Data on the Web Server

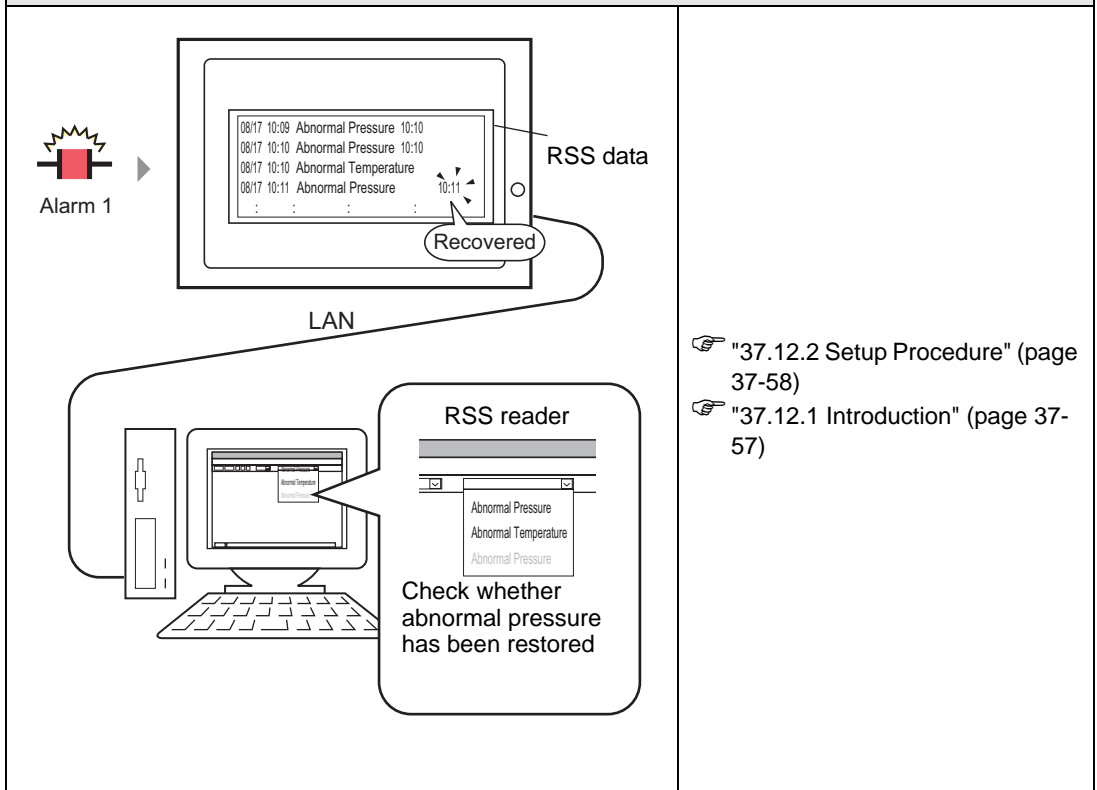

Using the Web Server to Transfer Files to the CF Card or USB Storage

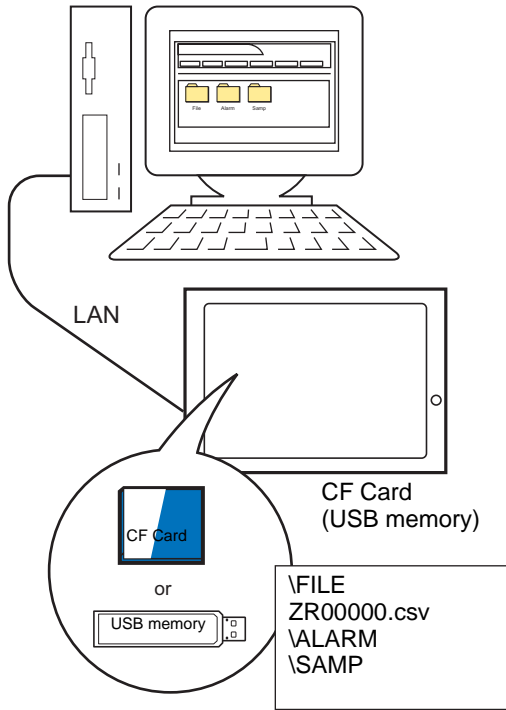

- ☞ "37.13.2 Setup Procedure" (page 37-61)
- ☞ "37.13.1 Introduction" (page 37-60)

Restricting Access to the Web Server

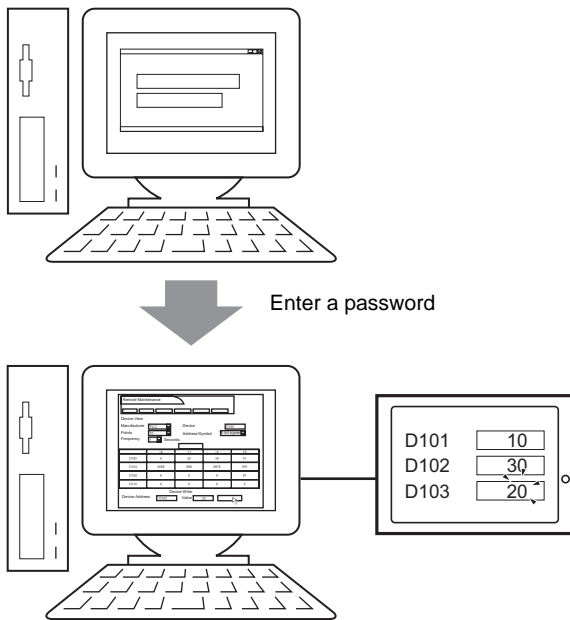

- ☞ "37.14.2 Setup Procedure" (page 37-68)
- ☞ "37.14.1 Introduction" (page 37-67)

37.10 Displaying and Editing Addresses Via Web Server

37.10.1 Introduction

Using the Web Server feature, you can use Internet Explorer to display and change device address values of networked GPs and connected devices/PLCs.

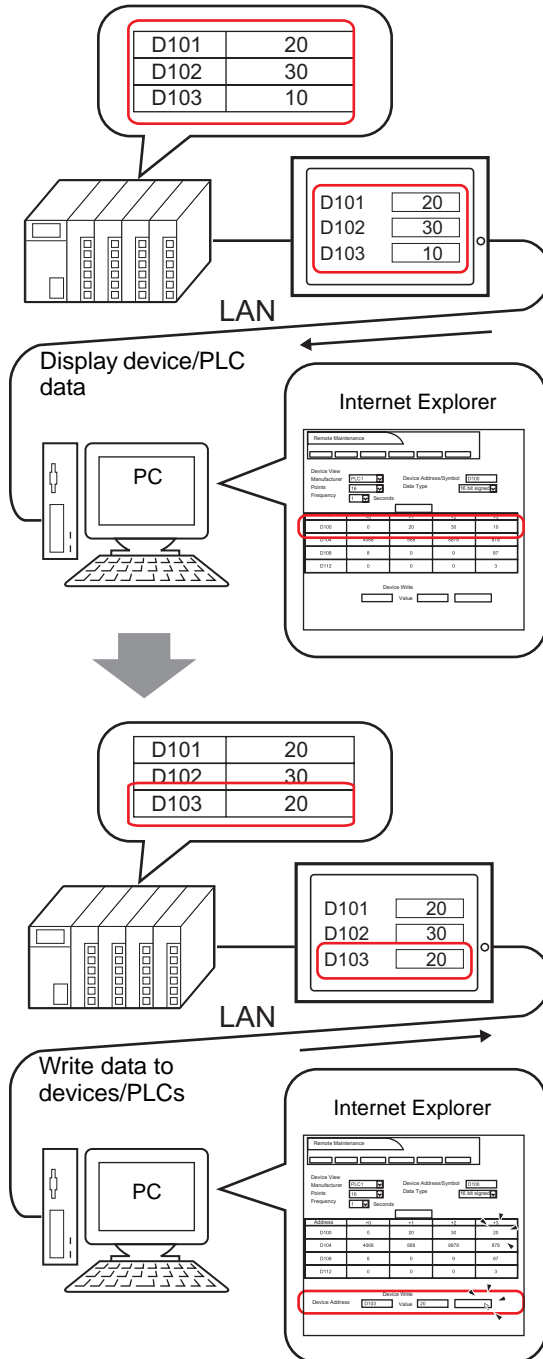

37.10.2 Setup Procedure

NOTE

- Please refer to the Settings Guide for details.
- ☞ "37.15.1 Standard Template HTML Setting Guide" (page 37-73)
- ☞ "37.15.2 System Settings [Display Unit] - [Remote Viewer] Settings Guide" (page 37-80)

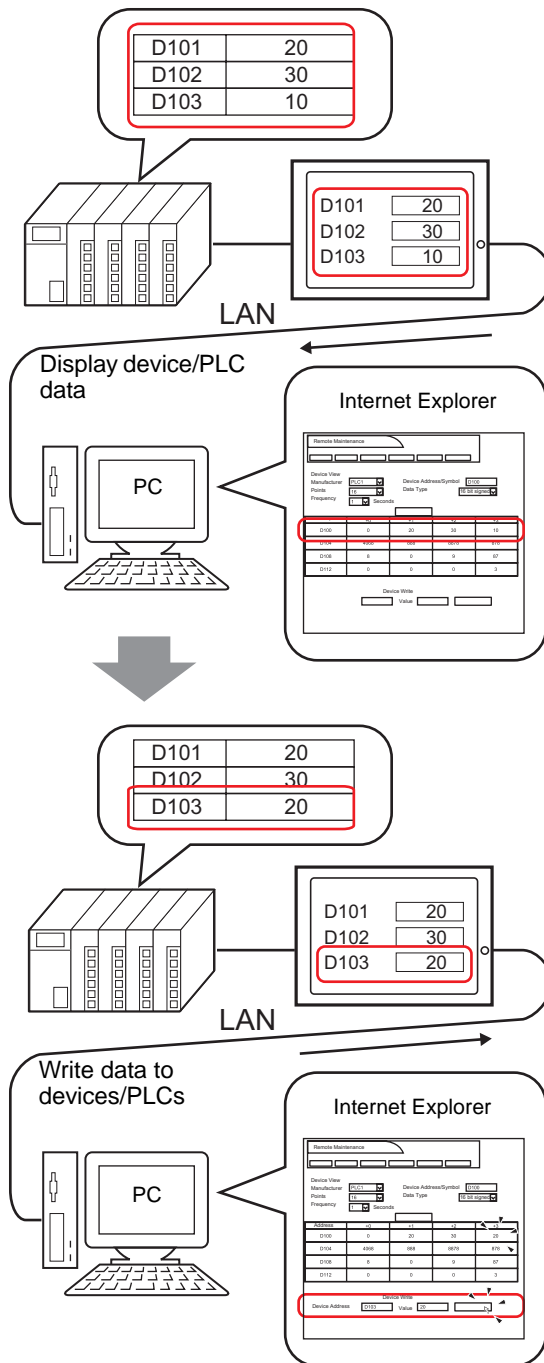

■ Necessary Device

- 1 Display Unit. (See "37.8.1 Target models ■ Display Units" (page 37-34) for supported models.)
- 2 GP-Pro EX (Ver.2.10 or later)
- 3 Computer (For supported models, refer to "37.8.1 Target models ■ Supported Operating Systems" (page 37-36).)
- 4 LAN cable and HUB (Commercial product)

■ Procedure Outline

- 1 Start GP-Pro EX to create a new project file.
- 2 In GP-Pro EX, draw the screen interface. Set up the Web Server and security.
- 3 Transfer the project to the display unit.
- 4 Transfer the standard HTML template to the display unit.
- 5 Connect the Display Unit to a Computer.
- 6 Start Internet Explorer and set up Internet options.

■ Starting GP-Pro EX to Creating Projects

Start GP-Pro EX to create a new project file. The startup method is the same procedure as "5.2.2 Setup Procedure" (page 5-10).

NOTE

- Please refer to the Settings Guide for details.
☞ "5.17.2 [New] Settings Guide" (page 5-102)
-

■ Drawing and Saving

◆ Drawing

In GP-Pro EX, draw the screen interface. For drawing methods, refer to "5.2.2 Setup Procedure ■ Creating/Saving" (page 5-15). You can also refer to chapters related to particular features, such as alarms.

IMPORTANT

- There are differences in which features can be used in the Web Server. The following describes which features you can use in Web Server.
☞ "1.3 Supported Features" (page 1-5)
-

◆ Web Server Features

In the System Settings workspace, click [Display Unit] and select the [Remote Viewer] tab. In the [Web Server] area, select the [Enable Web Server] check box. For the [Destination], select where to transfer the standard HTML template required by the Web Server from [CF Card] and [USB Storage], and define the destination [Folder]. (For example: [Destination] =

CF Card, [Folder] = WebSite,

[Default page when there is no file name] = default.html, [HTTP Port Number] = 80

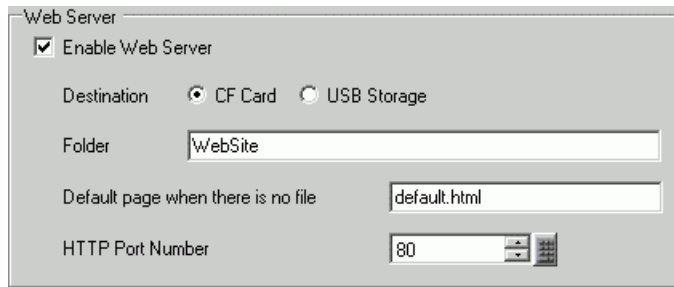

◆ Security

Set up security to place restrictions on which people can display and operate Web Server to display and interact with data on the display unit. Set up security level 15 and password "5555" for maintenance staff. Set up security level 1 and password "1111" for status monitoring staff.

NOTE

- You can use the Web Server without setting up any security.

- In GP-Pro EX, from the [Common Settings (R)] menu point to [Security (Q)], and select [Security Password (P)], or click .

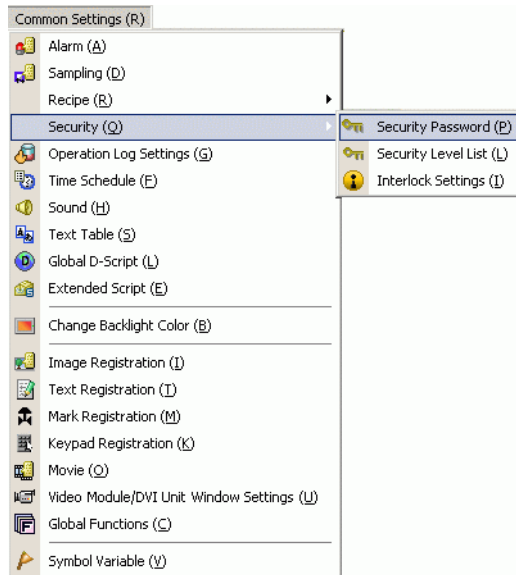

- The password setting screen will open. Check [Enable Security Function] and input password "1111" in [Level 1] and password "5555" in [Level 15].

NOTE

- To set up user IDs for each level, see the following.
 " ■ User ID Mode" (page 37-70)

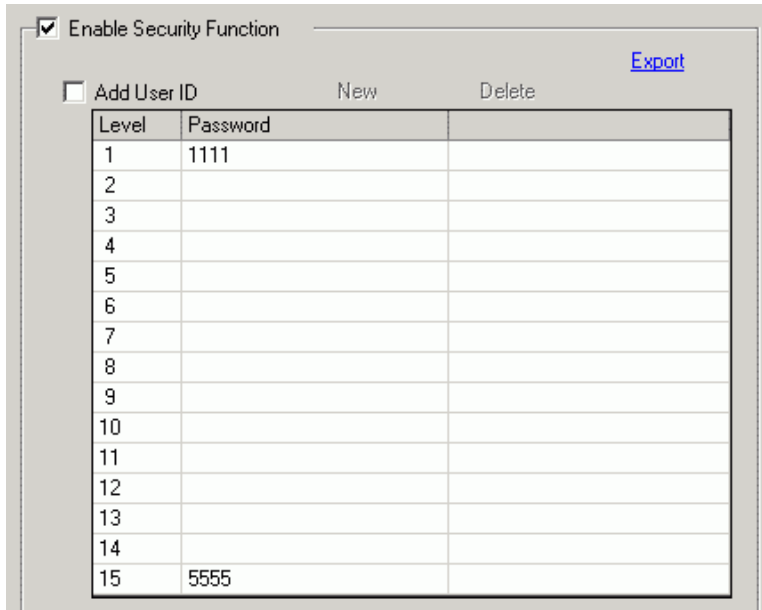

- 3 Next, when you select the [Set up Functions at Each Security Level] check box, you can define which functions are permitted at each security level.
 (For example, [Read Web Server Data] = Level 1, [Write Web Server Data] = Level 15)

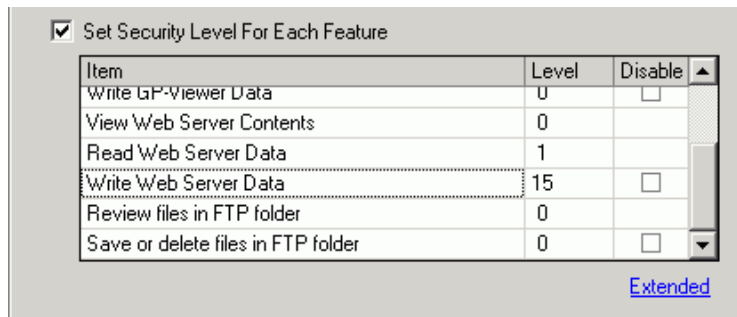

NOTE

- If you select Disable, the function cannot be performed regardless of the security level.
- After selecting Disable, if you want to change it to Enable, modify the project file with drawing software and then transfer it again. You cannot change it to Enable from the offline menu.

■ Transfer

In order to use the Web Server feature, the following two types of data transfer must be performed.

1. Transfer a project file to the GP.
2. Transfer Standard HTML Template to the CF Card or USB Storage

◆ Transfer Project File

Transfer Project Files to the Display Unit.

For the procedure for transferring project files, refer to the following.

☞ "33.1 Settings Menu" (page 33-2)

◆ Transferring the Standard HTML Template

- 1 On the GP-Pro EX state tool bar, click the Transfer Project icon to activate [Transfer Tool].

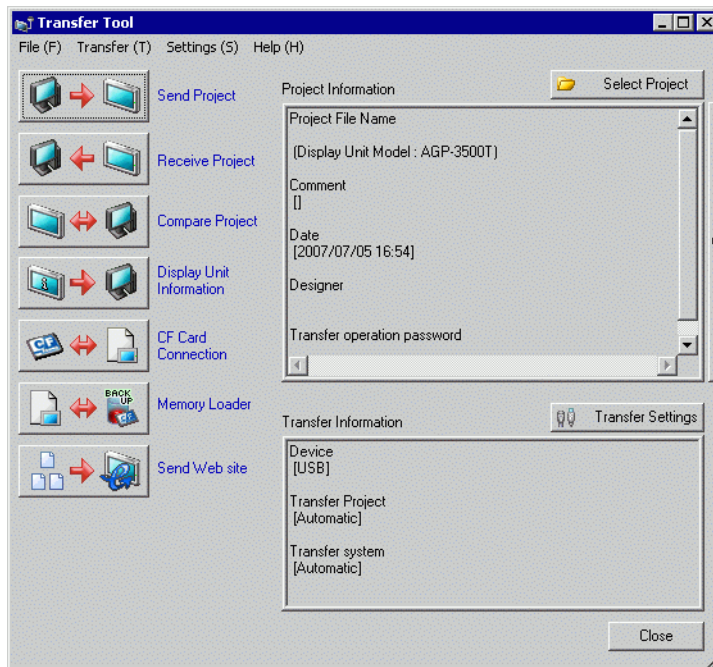

- 2 Click [Send Web site] to display the following dialog box. In the [Transfer From] field, identify the location of the standard HTML template. Create a folder to save the template to be transferred in the destination media, and enter the name of the folder. (For example: Website). Click [OK] to start transfer.

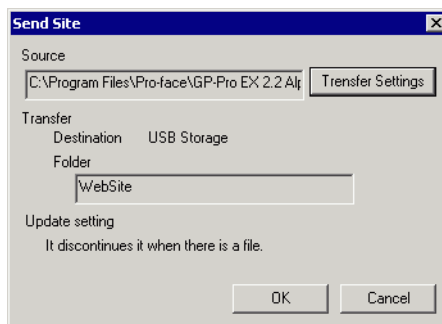

NOTE

- To use the Web Server, be sure to transfer the standard HTML template to the display unit. The standard HTML template is installed in C:\Program Files\Pro-face\GP-Pro EX 2.1\HTMLContent. For transfer methods, refer to the following.
 - ☞ "33.10 Setting Up Transfer Tool" (page 33-58)
 - The system program on the display unit (Runtime) must be GP-Pro EX Ver. 2.10 or later, or you cannot transfer the standard HTML template to the display unit.
 - If [Transfer Site Data] is selected in the [Transfer Settings] tab on the [Transfer Settings] screen displayed when [Settings] is clicked, the project file transfer and the standard HTML site transfer will be performed at the same time. For more details, please refer to the following.
 - ☞ "33.10.1 [Transfer Settings] Settings Guide" (page 33-61)
 - If you upgrade Runtime, please also upgrade (transfer and overwrite) the HTML template. Otherwise, it may not function properly.
-

3 When transfer is completed, the state of the dialog box changes from [Transferring] to [Transfer Complete]. Click [Close] to close the dialog box.

■ Connecting the Display Unit and Computer

Use the network HUB or Ethernet cable to connect the display unit to the computer.

IMPORTANT

- To communicate using Ethernet, Ethernet settings, such as the IP address and port number, must be set up on the GP.
-

NOTE

- Set up the display unit's IP address in Offline mode. Touch [Main Unit] and [Ethernet Setup]. For details on the setup procedure, refer to the following.
 - ☞ Maintenance/Troubleshooting Guide, "Assigning an IP Address to the Display"
 - Make sure to use a HUB for Ethernet Communication. 1:1 connections using a cross cable may not be possible depending on the type of PC and network card you are using.
-

37.10.3 Operating Procedure

■ Starting and Setting up Internet Explorer

- 1 Start Internet Explorer.
- 2 From the [Tools] menu, select [Internet Options]. In the [Internet Options] dialog box, click the [Advanced] tab to set up the following items.
 - (1) Select [Enable FTP folder view (outside of Internet Explorer)].
 - (2) Clear [Show friendly HTTP error messages].
 - (3) Select [Use Passive FTP (for firewall and DSL modem compatibility)].

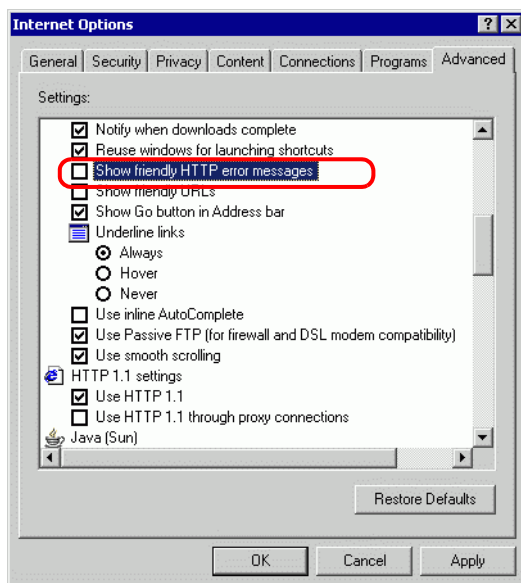

■ Connecting to the Web Server

- 1 Start Internet Explorer, and in the Address bar enter the IP address of the display unit. (For example, 192.168.0.1)

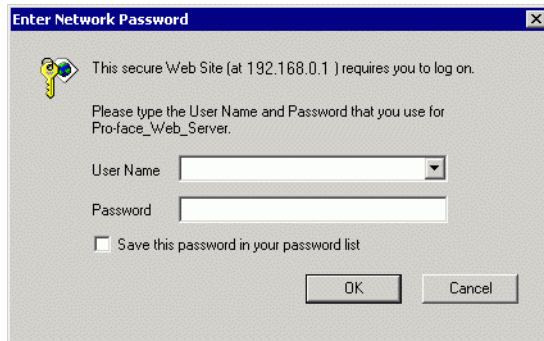

- 2 Press the Enter key to connect to the display unit's Web Server. If security is set up, the [Enter Network Password] dialog box appears. Enter the password, which can be up to 8 single-byte characters long, and click [OK].
(For example, "5555" (Security level that enables viewing and operating GP data))

**NOTE**

- When the [User ID] is set up in the security settings, the [User Name] also needs to be inputted.
- If security is set up and you exit Internet Explorer, the next time you reconnect, even if you type the URL to connect directly to the Web Server, you need to input the password again.

- 3 When you connect to the display unit's Web Server, the following [Welcome] screen appears.

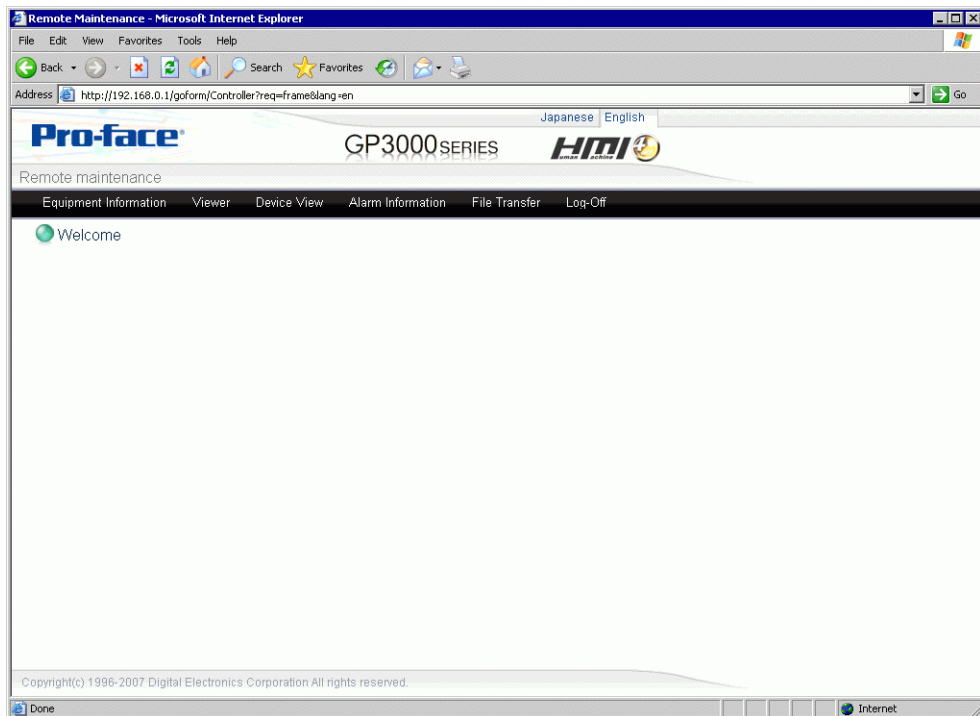

■ Viewing and Operating GP Data on the Web Server

- 1 From the HTML menu, select [Device View].
- 2 [Device View] screen defines the range of device addresses to display and the update rate. Define the [Device/PLC Name], [Device Address], [Access Points], [Data Type], and also the monitoring frequency in the [Update Frequency] field. [Start Monitoring] is selected to begin. (For example, [Device/PLC Name] = PLC1, [Device Address] = D101, [Access Points] = 4, [Data Type] = 16 bits Signed, [Update Frequency] = 60

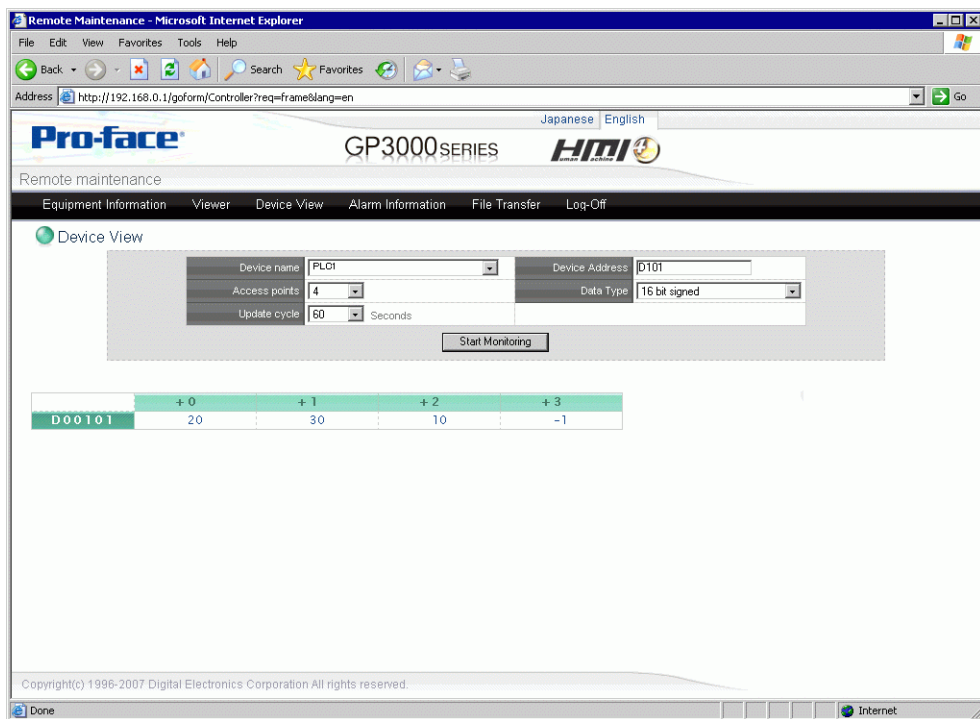

- 3 Click a value to display the [Device View Write] dialog box, and enter a new value in the [Value] field. [Click [Write] to set the value to the device/PLC connected to the GP. (For example, [Device Address] = D103, [Value] = 20)

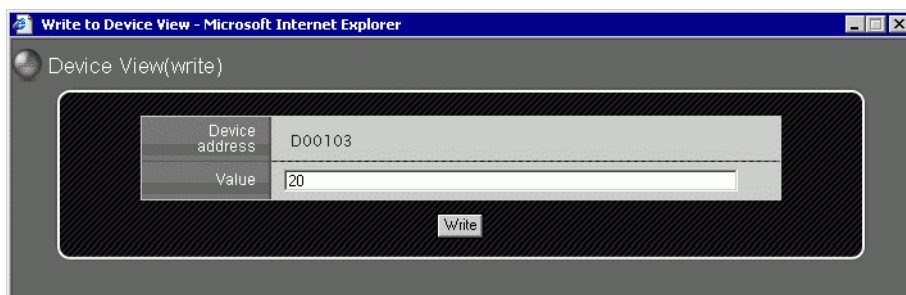

IMPORTANT

- When displaying a Web page in Windows XP Service Pack 2, because the default setting blocks popup windows, make sure you allow popups so you can view the Web page and enter values on the Web Server.

The following describes the steps to allow popups.

Allowing Popup Windows From a Specific URL

In Internet Explorer, from the [Tools] menu point to [Pop-up Blocker] and select [Pop-up Blocker Settings].

In the [Address of Web site to allow] field, type the URL and then click [Add].

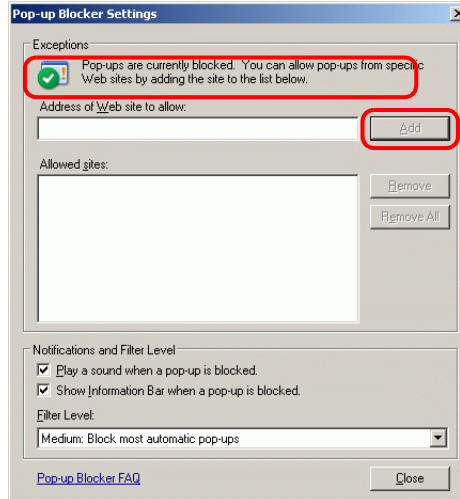

Temporarily Allow Popups

Click the information bar and select [Temporarily Allow Popups] to display the blocked window. You can input multiple values at one time.

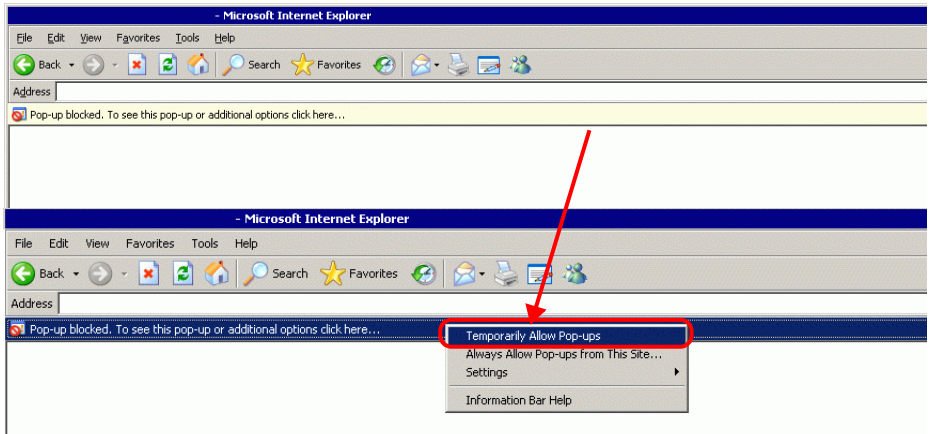

NOTE

- In the [Value] field, input multiple values separated with either spaces or commas. Select [Write] to write the values to consecutive addresses from the defined address. Note, the number of consecutive addresses you can write to depends on the [Data Type], as follows.

Data Type	Input Points
Bit	128 points
16 Bit Signed	36 points
16 Bit Unsigned	42 points
16 Bit Hexadecimal	51 points
32 Bit Signed	21 points
32 Bit Unsigned	23 points
32 Bit Hexadecimal	28 points
Single-precision floating point	28 points
Double-precision floating point	14 points
Text	256 bytes

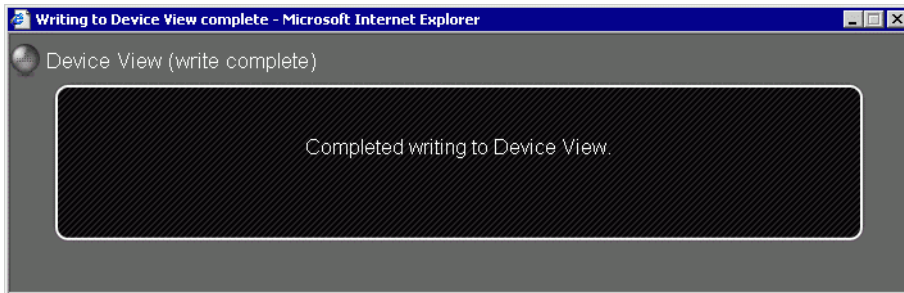

■ Logging off the Web Server

- 1 When you have completed viewing and operating the GP, log off from the Web Server. From the menu, select [Log off] to display the following dialog box.

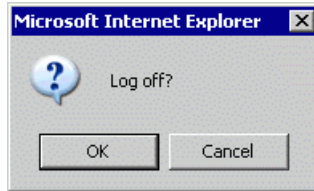

- 2 Click [OK]. When the following dialog box appears, select [Yes].

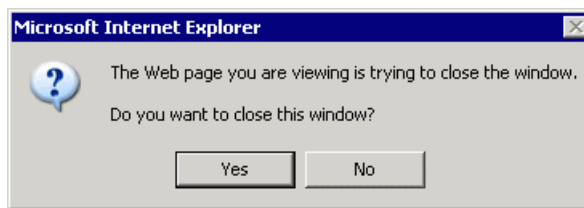

- 3 Close Internet Explorer to complete the log off process.

37.11 Displaying Alarm information on the Web Server

37.11.1 Introduction

Displays the latest alarm information generated on the remote GP in Internet Explorer. Select the [Refresh] command to get the latest alarm information.

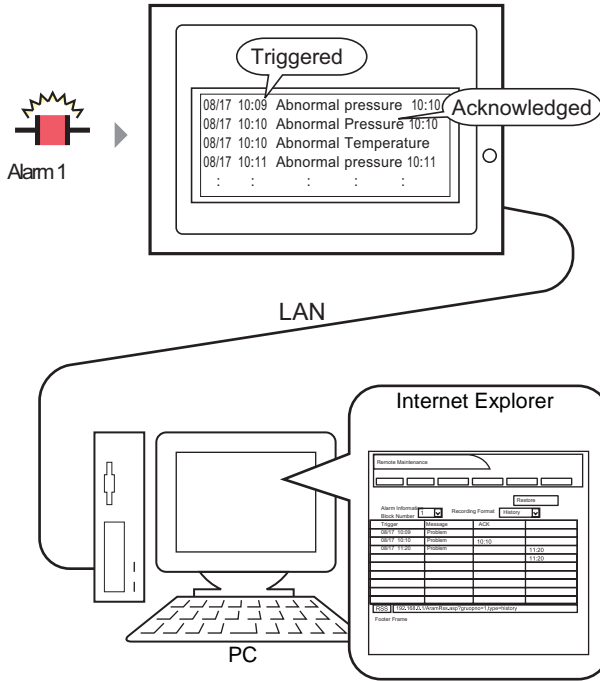

NOTE

- Nothing displays when there is no alarm information on the GP. For steps on displaying an alarm, see the following.
 Chapter 19 Alarms (page 19-1)

37.11.2 Operating Procedure

1 Log in to the Web Server and select [Alarm Information] in the [Welcome] screen.

NOTE

- For information on setting up and connecting to the Web Server, see the following.
 Chapter 37.10 Displaying and Editing Addresses Via Web Server (page 37-42)

2 When the following screen appears, in the [Block Number] field select the alarm block number to display, and in the [Record Format] field select the alarm display mode. [[Refresh] command lists the current alarm information as follows: (for example, [Block Number] = Block 1, [Record Format] = History).

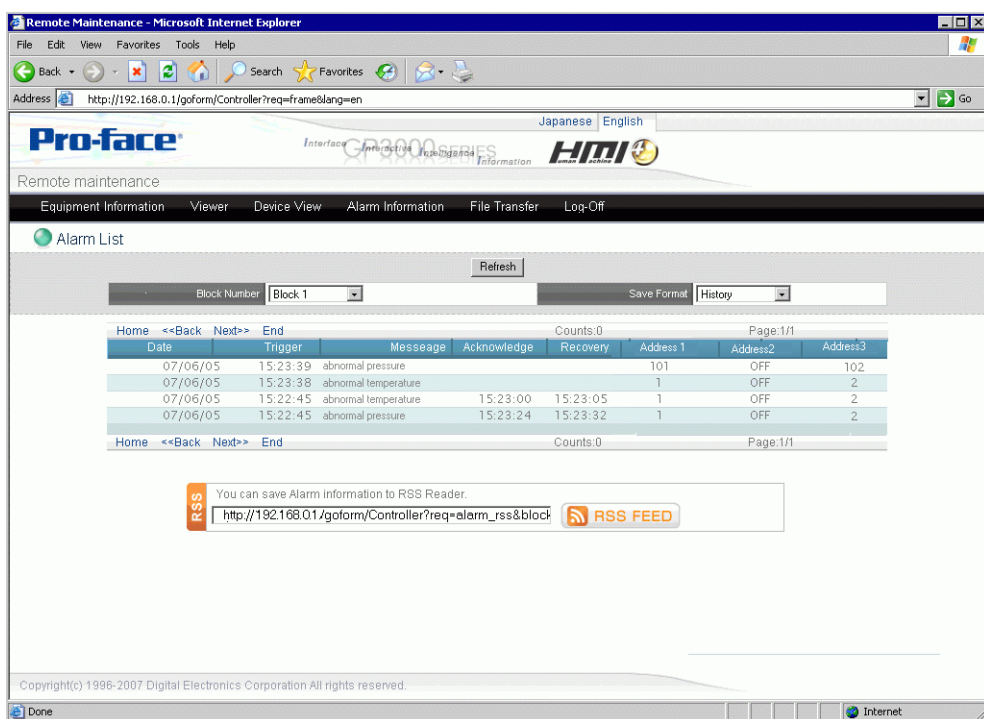

NOTE

- Select the [Refresh] command again to get the latest alarm information.

3 When you complete reviewing the alarm information, [Log off] to disconnect.

NOTE

- In order to display the data values when Alarms are triggered, on the [Common Settings (R)] menu, click [Alarm (A)] and then select the [Read Data From Each Alarm] check box on the [Alarm] screen to specify the address where you want to obtain values. For more details, please refer to the following.
- "19.10.1 Common (Alarm) Settings Guide ■ Alarm (Block 1) Settings Guide" (page 19-85)

37.12 Displaying Alarm Information as RSS Data on the Web Server

37.12.1 Introduction

Displays alarm information accumulated from the remote GP as Internet RSS data. For example, the following describes the setup procedure for displaying alarm information in a RSS bar which is updated just like the browser's Refresh command.

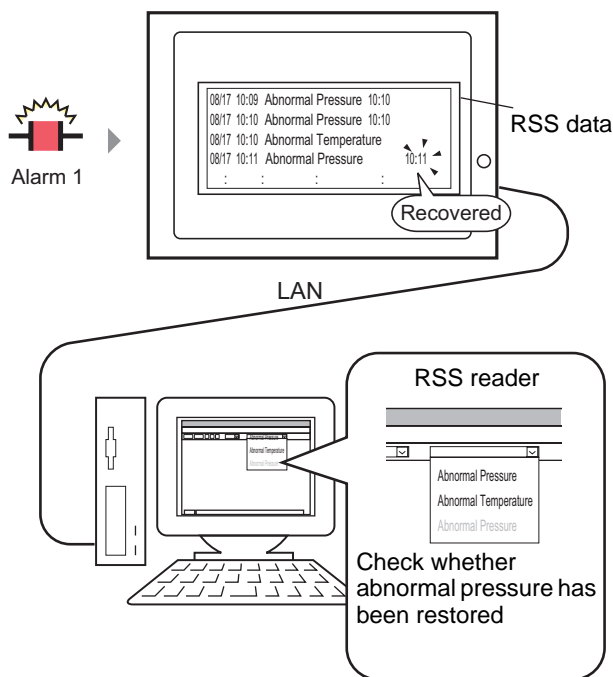

■ Rich Site Summary (RSS) Data

A format for describing HTML data such as the Web site title or site map, RSS is mainly used for disclosing site update information.

Using RSS data increases efficiency as it allows you to check updated information in a consistent format.

To display RSS data, you need to install an RSS reader application. Display methods are different from one RSS reader application to another. Check the Pro-face support site "Otasuke Pro!" (<http://www.pro-face.com/otasuke/>) for RSS readers that have been confirmed to work with GP-Pro EX.

Our Web Server RSS Ver1.0 is supported.
Please use an RSS reader that supports RSS Ver1.0.

37.12.2 Setup Procedure

1 Log in to the Web Server and select [Alarm Information] in the [Welcome] screen.

NOTE

- For information on setting up and connecting to the Web Server, see the following.
 Chapter 37.10 Displaying and Editing Addresses Via Web Server (page 37-42)

2 When the following screen appears, in the [Block Number] field select the alarm block number to display, and in the [Record Format] field select the alarm display mode. (For example: [Block Number] = Block 1, [Record Format] = History).

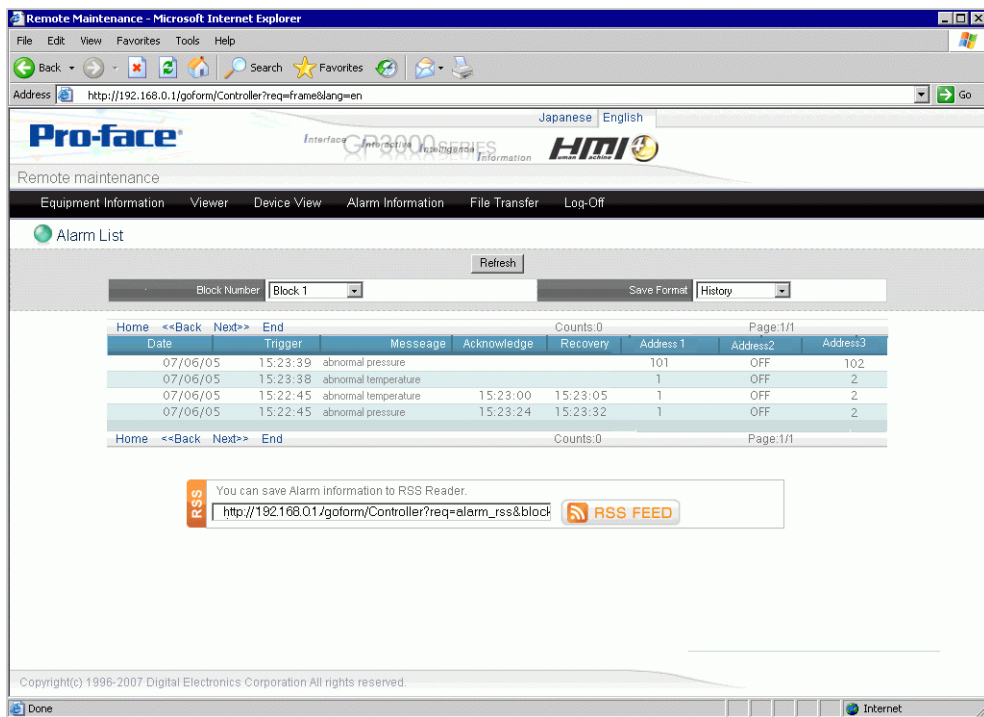

3 The RSS URL appears in the [RSS] field, and the alarm information is displayed. Set up this URL as the RSS reader address.

NOTE

- For information on setting up the displayed URL address in the RSS reader application, refer to the documentation that accompanies the RSS reader.
- Check the Pro-face support site "Otasuke Pro!" (<http://www.pro-face.com/otasuke/>) for RSS readers that have been confirmed to work with GP-Pro EX.

4 Alarm information displays on the RSS reader as shown in the following image. Select Update Information to check the alarm information list. Alarm information is updated whenever the alarm is triggered and recovered. Note, the following illustration is only a sample. The RSS reader determines how the information is displayed.j

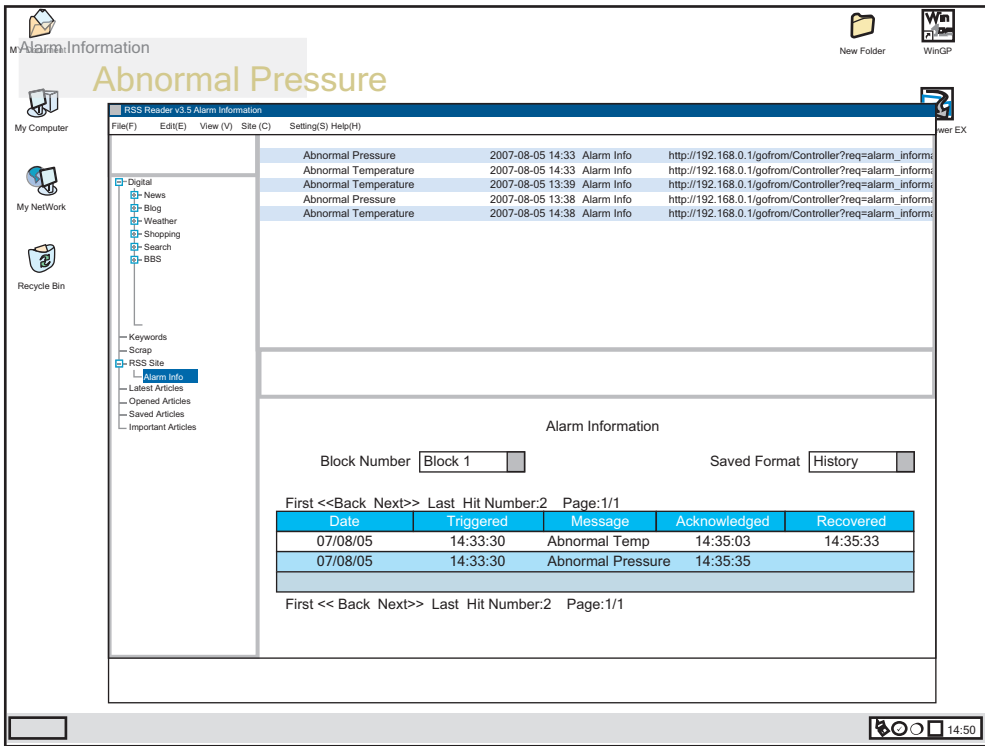

- NOTE**
- Please set the time difference between the standard time in PC installation location and the Greenwich mean time in advance from [Remote Viewer - [Time Zone]]. Otherwise, time data in the RSS reader cannot be displayed correctly.
 - The time displayed on the RSS reader can be calculated by the following formula.
Time difference of the computer - time difference of AGP
 - Update cycle of the RSS reader is once every minute by default. For details on how to change the update cycle, refer to the manuals for the RSS reader used.

37.13 Using the Web Server to Transfer Files to the CF Card or USB Storage

37.13.1 Introduction

External storage devices such as CF cards or USB storage enable you to move files between the GP and computer without using the Transfer Tool. These storage devices further allow you to copy files from one GP to another.

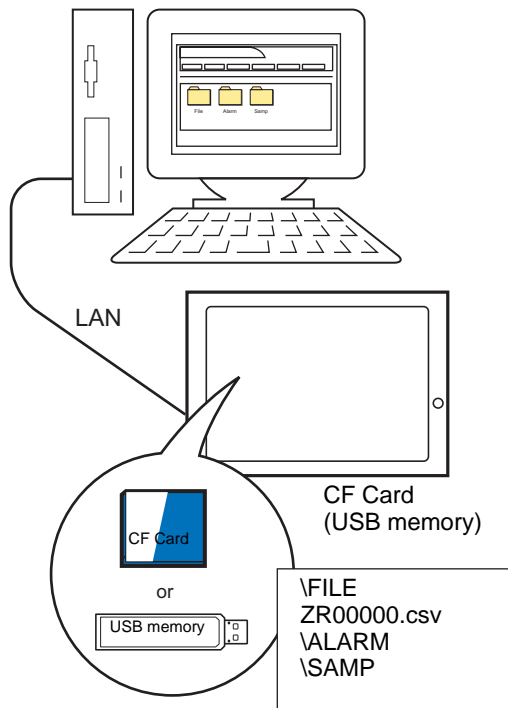

37.13.2 Setup Procedure

To use the Web Server to transfer files to the CF card or USB storage, define the file transfer destination folder in GP-Pro EX.

NOTE

- To use the Web Server's FTP server feature, change the Internet options. For information on the setup procedure, see the following.
☞ "37.10.3 Operating Procedure ■ Starting and Setting up Internet Explorer" (page 37-49)
-

◆ FTP Server

- 1 In the System Settings workspace, select [Display Unit] and click the [Remote Viewer] tab. In the [FTP] group, select [Enable FTP], for the [Destination] option select where the files are stored, and in the [Folder] field define the destination folder (for example, [Destination] = CF Card, [Folder] = WebSite).

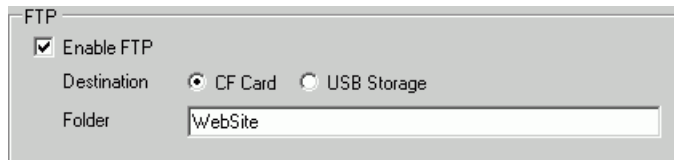

NOTE

- For the FTP destination folder, you can define the same folder as the Web Server destination folder.
-

- 2 Save the project and transfer to the GP.

- ☞ "33.2 Transferring Project Files via USB Transfer Cable" (page 33-5)
- ☞ "33.3 Transferring Project Files via Ethernet (LAN)" (page 33-12)

◆ Security

NOTE

- Please refer to the Settings Guide for details.
☞ "22.10.1 Common (Security Settings) Settings Guide" (page 22-40)

Set up security level 15 and password "5555" for maintenance staff. Set up security level 1 and password "1111" for status monitoring staff.

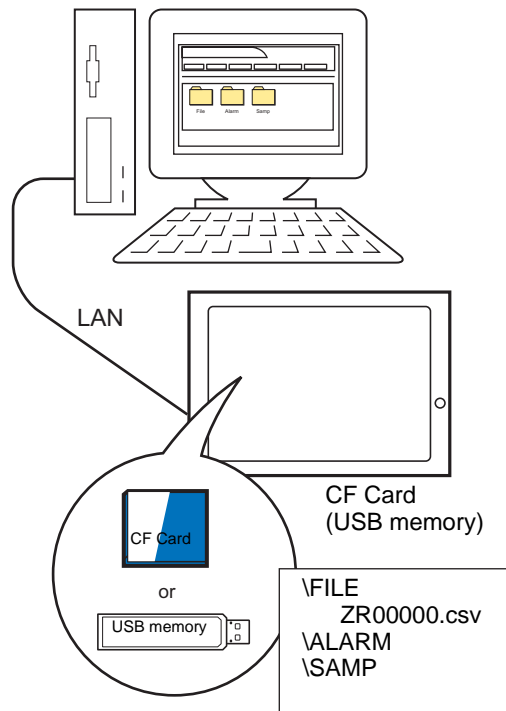

NOTE

- Security level 0 means no security is set.

1 From the [Common Settings (R)] menu, point to [Security (Q)] and select [Security Password (P)] or click  on the toolbar.

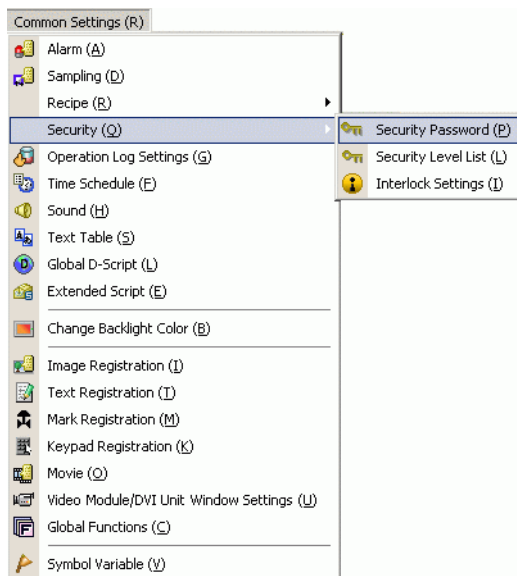

2 The password setting screen will open. Select the [Enable Security Function] check box and type password "1111" for [Level 1], and password "5555" for [Level 15].

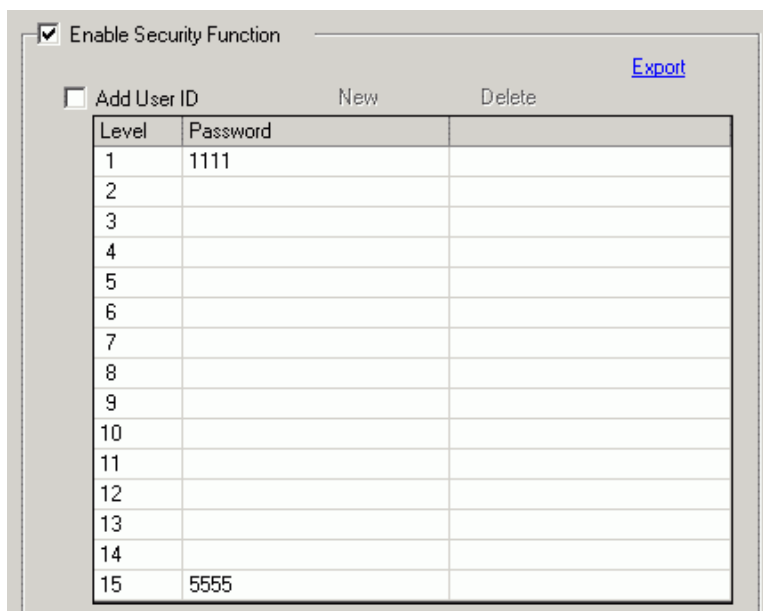

NOTE

- Each password should be 8 single-byte characters or less.

- 3 Next, select the [Set up Functions at Each Security Level] check box and define the security level set in the above procedure 2 for each [Item]. (For example, [Review files in FTP folder] = Level 1, [Save or delete files in FTP folder] = Level "15").

Set Security Level For Each Feature

Item	Level	Disable
Write GP-Viewer Data	1	<input type="checkbox"/>
View Web Server Contents	0	<input type="checkbox"/>
Read Web Server Data	0	<input type="checkbox"/>
Write Web Server Data	0	<input type="checkbox"/>
Review files in FTP folder	1	<input type="checkbox"/>
Save or delete files in FTP folder	15	<input type="checkbox"/>

[Extended](#)

NOTE

- If you select Disable, the function cannot be performed regardless of the security level.
- After selecting Disable, if you want to change it to Enable, modify the project file with drawing software and then transfer it again. You cannot change it to Enable from the offline menu.

37.13.3 Operating Procedure

1 Log in to the Web Server and select [File Transfer] in the [Welcome] screen.

NOTE

- For information on setting up and connecting to the Web Server, see the following.
 "37.10 Displaying and Editing Addresses Via Web Server" (page 37-42)

2 When security is set up, the [Log in] dialog box appears. Enter the [User Name] and password that correspond to the security level you want to work in (For example, 5555).

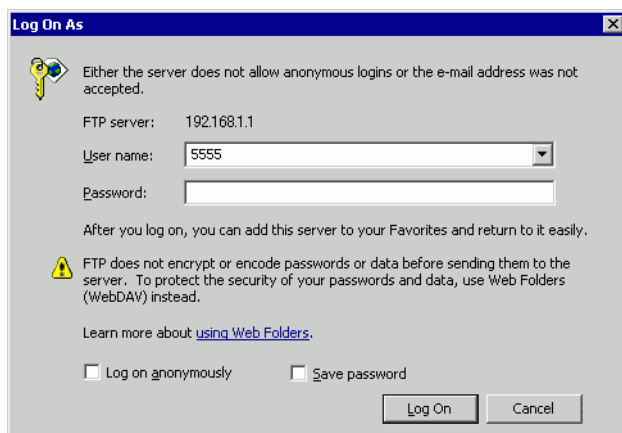

NOTE

- When the [User ID] is set up in the security settings, in the [User Name (U)] field input the user ID and in the [Password (P)] field input the password.
- If security is set up and you exit the Web Server, the next time you reconnect, even if you type the URL to connect directly to the site, you need to input the password again.
- Instead of the [Login] dialog box, if an FTP folder error message appears, click [OK] to close the message box. To display the [Login] dialog box, from the [File] menu select [Login].
- When Internet Explorer is used to log in for FTP connection with the user name and password left blank, the user is recognized as an anonymous user who does not require authentication. Therefore, if [Review files in FTP folder] is assigned with level 0 and [Save or delete files in FTP folder] is assigned with level 1 or higher, you cannot log in without entering the user name and password even for the purpose of browsing. In order to log on for browsing only, enter any user name and password.
- Do not select the [Save password] check box on the Login dialog box.
- If you want to log in as an another user, close the window once and access the FTP server again.

- The contents of the destination folder appears. You can overwrite files, delete files, and other operations corresponding to your login security level.

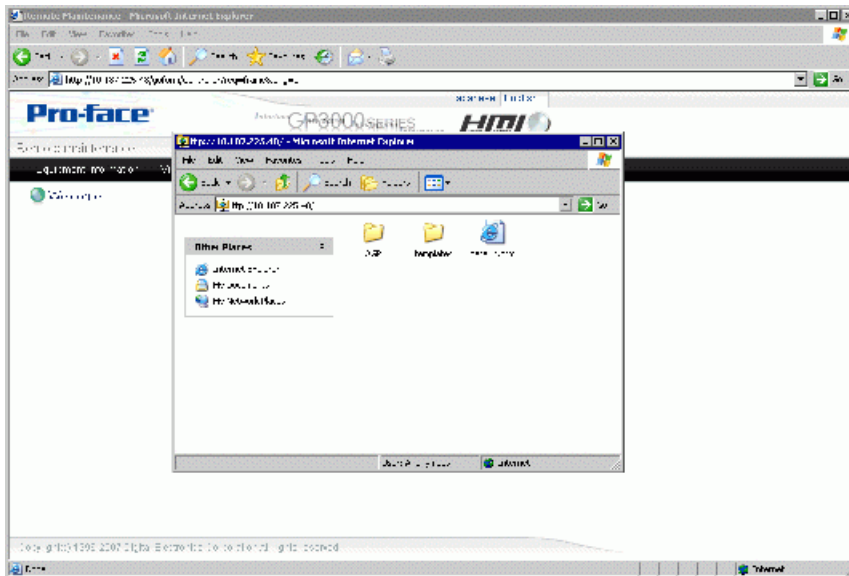
**NOTE**

- Using FTP, you can interact with the CF Card or USB storage. You can get the file list, get files, delete files, change file attributes, and write files.
- When using Internet Explorer 7 for FTP data transfers, from the [Page] menu select [Open FTP site in Windows Explorer]. An instance of Windows Explorer opens, which you can use to read and write selected files. Without opening Windows Explorer, you will not be able to write or delete files. If a login dialog box displays, click Cancel.

37.14 Restricting Access to the Web Server

37.14.1 Introduction

Sets up security to restrict which people can display and operate data displayed on the Web Server. Set up security level 15 and password "5555" for maintenance staff. Set up security level 1 and password "1111" for status monitoring staff.

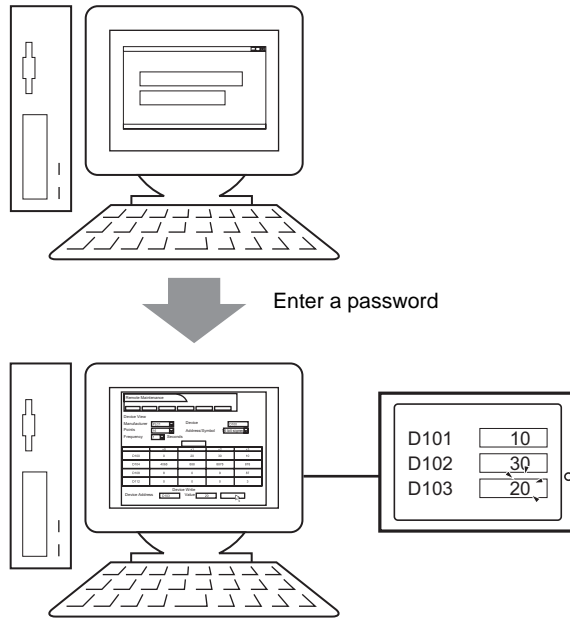

37.14.2 Setup Procedure

NOTE

- Please refer to the Settings Guide for details.
☞ "22.10.1 Common (Security Settings) Settings Guide" (page 22-40)

Set up security level 15 and password "5555" for maintenance staff. Set up security level 1 and password "1111" for status monitoring staff.

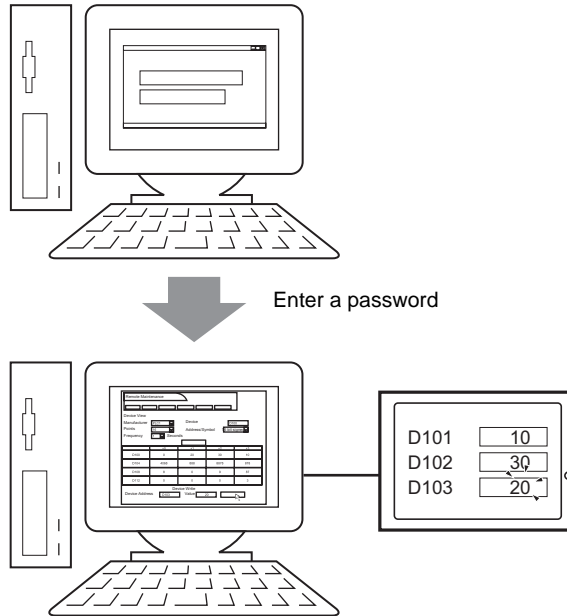

NOTE

- Security level 0 means no security is set.

■ Level Mode

Registers passwords for security levels 1 to 15 and defines the security level for each display screen.

- 1 From the [Common Settings (R)] menu, point to [Security (Q)] and select [Security Password (P)] or click  on the toolbar.

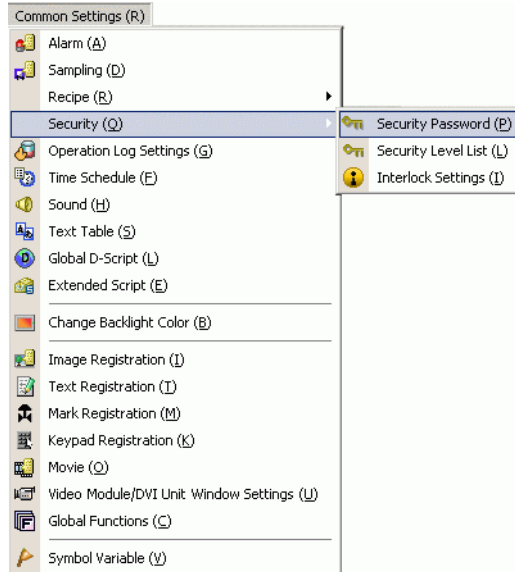

- 2 The password setting screen will open. Select the [Enable Security Function] check box and type password "1111" for [Level 1], and password "5555" for [Level 15].

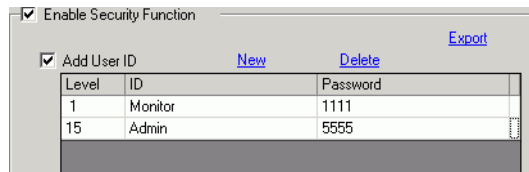

NOTE

- Each password should be 8 single-byte characters or less.

3 Next, select the [Set up Functions at Each Security Level] check box and define the security level set in the above procedure 2 for each [Item]. For example, [Read Web Server Data] = Level 1, [Write Web Server Data] = Level 15.

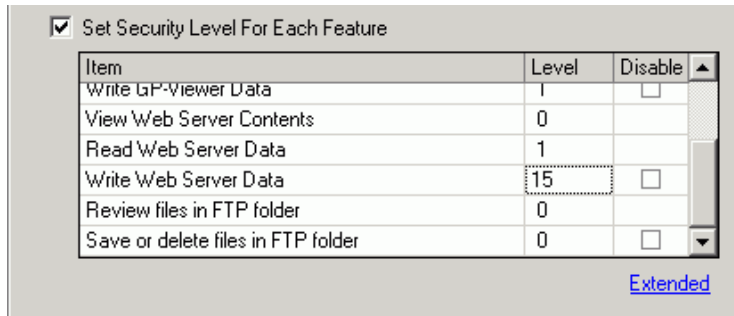

NOTE

- If you select Disable, the function cannot be performed regardless of the security level.
- After selecting Disable, if you want to change it to Enable, modify the project file with drawing software and then transfer it again. You cannot change it to Enable from the offline menu.

■ User ID Mode

Register user IDs and passwords for each security level, then the security level for each display screen.

1 From the [Common Settings (R)] menu, point to [Security (Q)] and select [Security Password (P)] or click  on the toolbar.

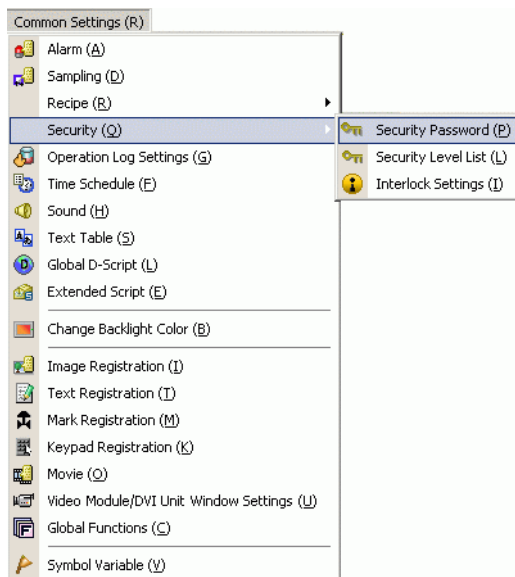

- 2 In the Set Password screen, select the [Enable Security Function] and [Add User ID] check boxes. Click [Create] to add one set of settings: Security Level, User ID, and Password.

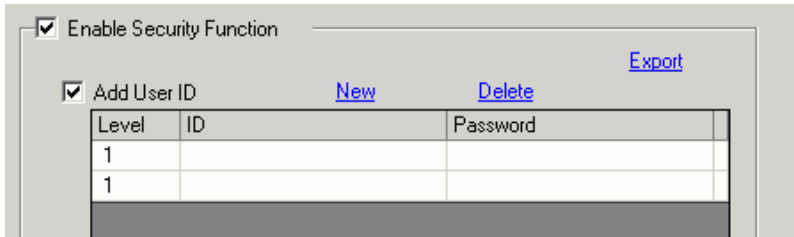

The screenshot shows a web interface with a checked checkbox for "Enable Security Function" and another checked checkbox for "Add User ID". There are links for "New" and "Delete" above a table. The table has three columns: "Level", "ID", and "Password".

Level	ID	Password
1		
1		

- 3 Set the security level, user ID, and password for status monitoring and maintenance staff (for example, Status Monitoring: [Level] = "1", [Password] = "1111", [ID] = "Monitor"; Maintenance: [Level] = "15", [Password] = "5555", [ID] = "Admin").

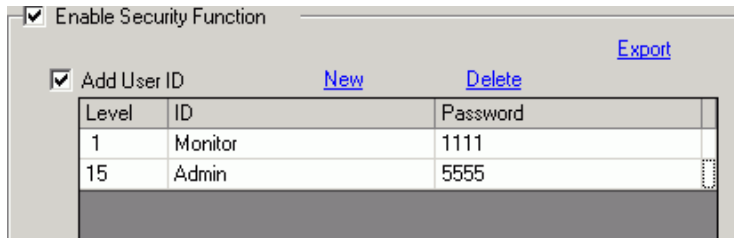

The screenshot shows the same interface as before, but the "Add User ID" table now contains two rows of data.

Level	ID	Password
1	Monitor	1111
15	Admin	5555

NOTE

- Each password should be 8 single-byte characters or less.

- 4 Next, select the [Set up Functions at Each Security Level] check box and define the security level set in the above procedure 2 for each [Item]. For example, [Read Web Server Data] = Level 1, [Write Web Server Data] = Level 15.

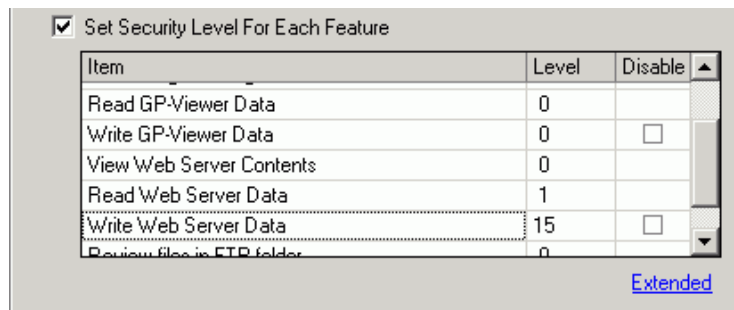

The screenshot shows a web interface with a checked checkbox for "Set Security Level For Each Feature". Below it is a table with three columns: "Item", "Level", and "Disable".

Item	Level	Disable
Read GP-Viewer Data	0	
Write GP-Viewer Data	0	<input type="checkbox"/>
View Web Server Contents	0	
Read Web Server Data	1	
Write Web Server Data	15	<input type="checkbox"/>
Review files in FTP folder	0	

An "Extended" link is visible at the bottom right of the table area.

37.14.3 Operating Procedure

- 1 Start Internet Explorer, and in the Address bar enter the IP address of the display unit.
(For example, 192.168.0.1)

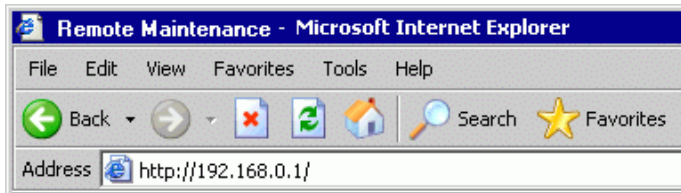

- 2 Select a menu, such as [Device Menu], to display the [Input Network Password] dialog box.
Enter the password, which can be up to 8 single-byte characters long, and click [OK].
(For example, "5555" (Security level that enables viewing and operating GP data))

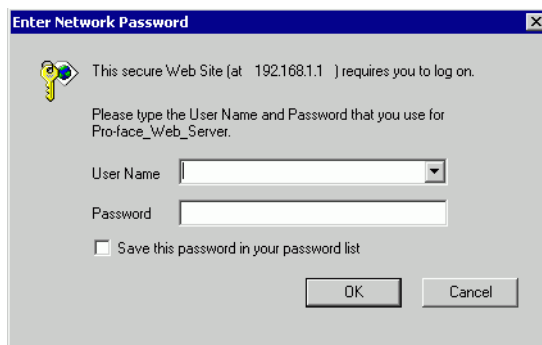

- 3 When you connect to the display unit's Web Server, the following [Welcome] screen appears.

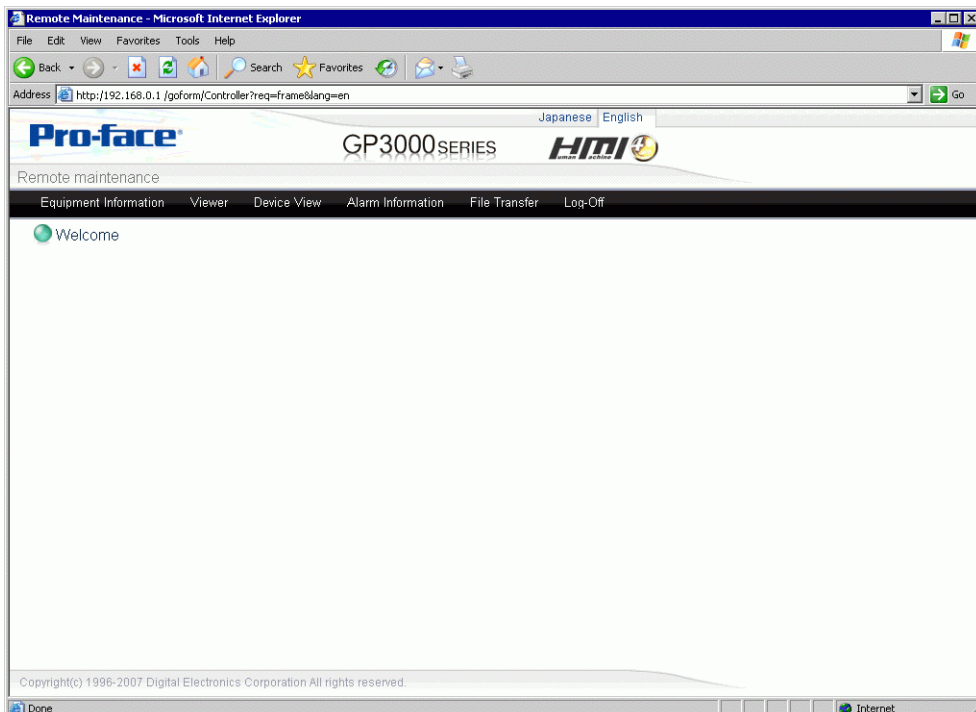

- 4 Select operations from the menu to interact with data on the display unit.

37.15 Settings Guide

37.15.1 Standard Template HTML Setting Guide

This section provides information about the standard HTML template Web pages installed with GP-Pro EX. The standard template Web page consists of three frames: the header, footer, and main frame. The standard HTML template is installed in the following location.
C:\Program Files\Pro-face\GP-Pro EX 2.1\HTMLContent.

NOTE

- To use the Web Server: in the System Settings workspace, click [Display Unit], then in the [Remote Viewer] tab, select the [Enable Web Server] check box, and then transfer the standard HTML template to the display unit.

■ Header Frame

The header frame is common to all page headings, except when logged off. Using the buttons in this frame, you can jump to each page.

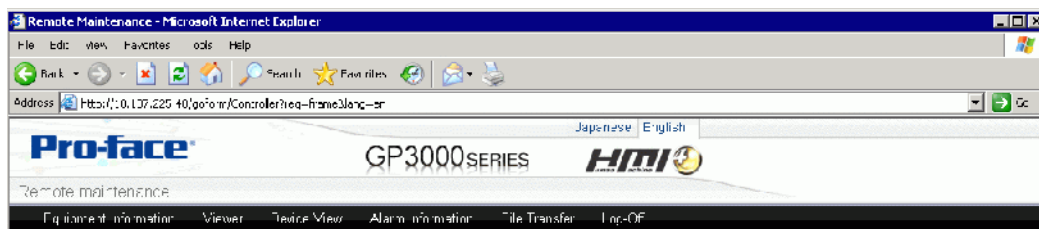

Setting	Description
Title	Displays the title of a Web page.
Equipment information	Displays GP-Pro EX project settings.
Viewer	When GP-Viewer EX is installed, starts the GP-Viewer EX application.
Device View	Monitors device addresses of devices or PLCs connected to the GP.
Alarm information	Displays alarm information accumulated in the GP.
File transfer	Use Internet Explorer as an FTP client to access data in its CF card or USB storage.
Log off	Disconnects the GP and closes the window.
Japanese/English	Switches between the Japanese and English versions of the standard HTML template.

■ Footer Frame

The footer frame displays on the bottom of all pages.

Copyright(c) 1996-2007 Digital Electronics Corporation All rights reserved.

■ Main Frame

Changes to the page corresponding to the button selected in the [Header Frame].

◆ Logon

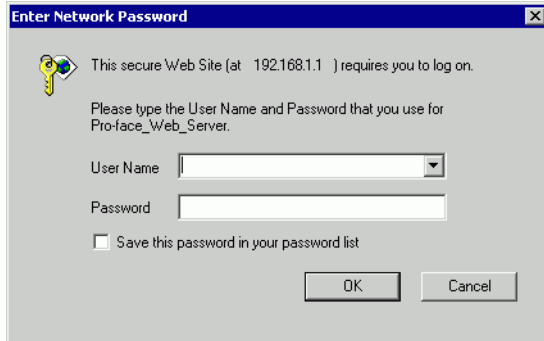

Setting	Description
User Name	Enter the user name with up to 8 single-byte characters, as set up in the GP-Pro EX security settings. [User Name] is blank if user names have not been set up.
Password	Enter the user name with up to 8 single-byte characters, as set up in the GP-Pro EX security settings.
Save password	Select the check box to save the password for the [User Name]. The next time you log in, after you enter the user name, all you have to do is click [OK] without entering a password.

◆ [Welcome] Page

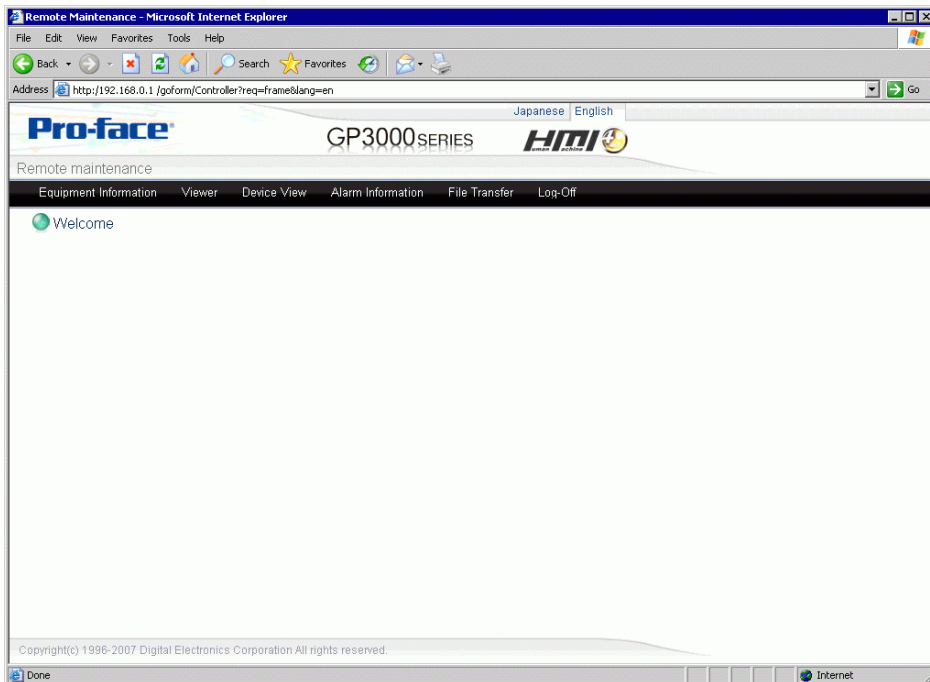

◆ **Device Information Page**

Displays the project and network project settings. You can view these settings, but you cannot change them.

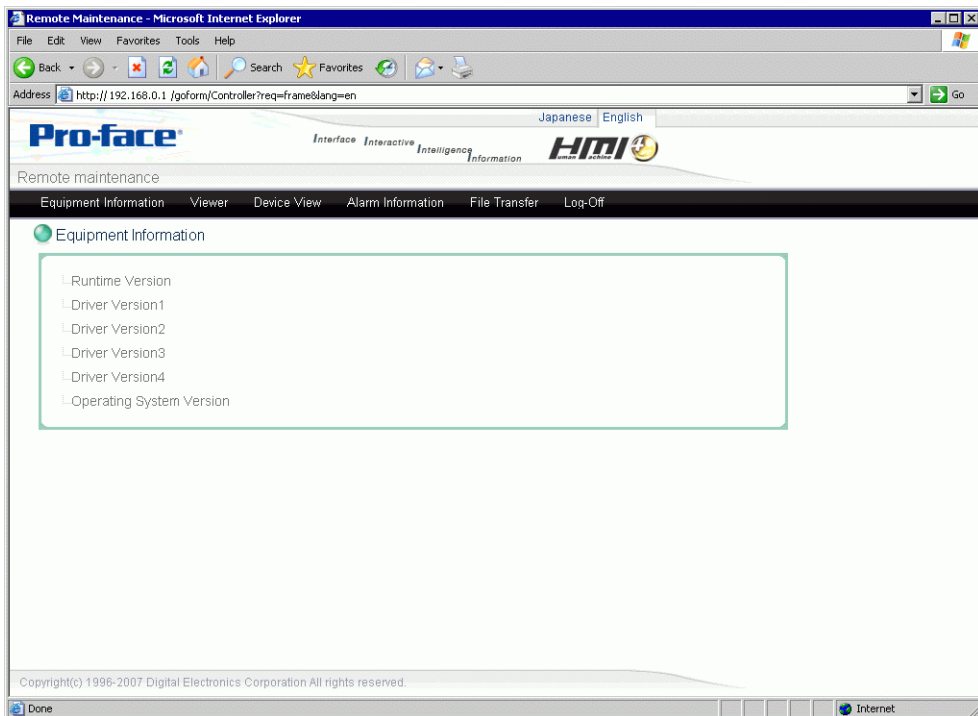

Setting	Description
Runtime Version	Displays the GP Runtime version.
Driver Version 1 to 4	Displays the protocol driver version. If you are connecting the maximum 4 drivers, the version of each driver is displayed.
Operating system version	Displays the GP operating system version.

◆ [GP-Viewer EX] Page



Setting	Description
Run GP-Viewer EX	On the computer where GP-Viewer EX is installed, this is a shortcut key to start up GP-Viewer EX.
Download	Downloads GP-Viewer EX.

◆ Device View Page

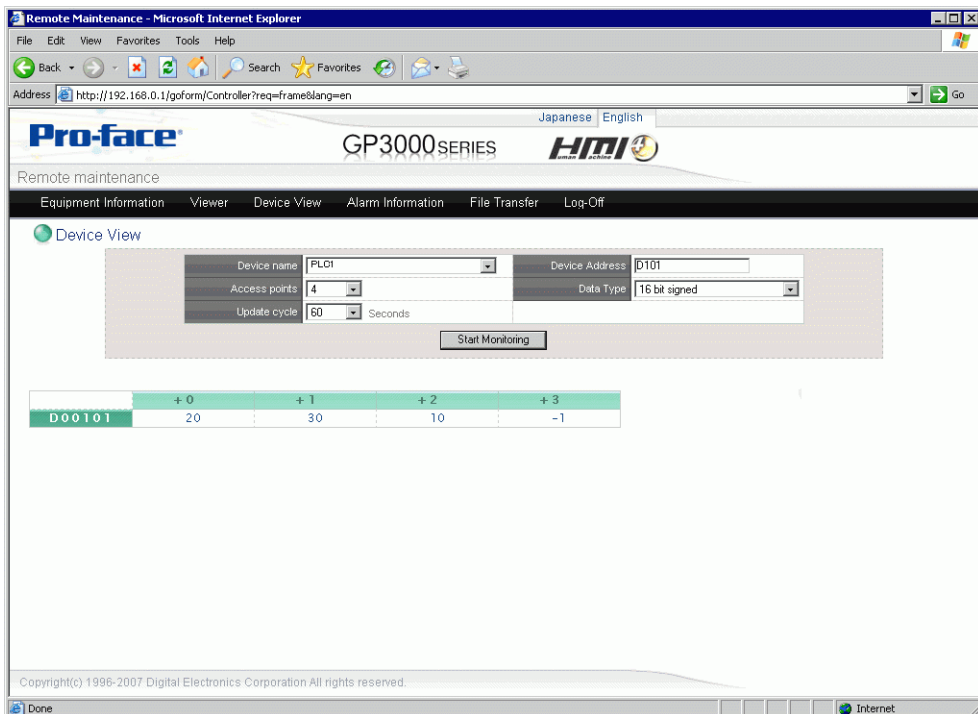

Setting	Description
Device/PLC Name	Selects devices/PLCs connected to GP.
Device Address	Sets up the start address of device addresses to monitor. You cannot specify Symbols.
Access points	Select the number of address points to display and access in one screen: [1], [2], [4], [8], [16], [32], [50], [100], or [200].
Data Type	Define the bit length and data type of addresses: [Bit], [16 Bit Signed], [16 Bit Unsigned], [16 Bit HEX], [32 Bit Signed], [32 Bit Unsigned], [32 Bit HEX], [Single-precision Floating Point], [Double-precision Floating Point], or [Text].
Update cycle	Select the monitoring frequency: [1], [2], [3], [4], [5], [10], [20], [60], [120], [180], or [300] seconds.
Start Monitoring	Starts monitoring device addresses at the defined frequency. Monitoring ends if you change the page or exit the browser.
Device Display Frame	Displays device addresses starting from the [Device Address] field, up to the number of addresses defined in the [Access Point] field.

◆ Alarm Information Page

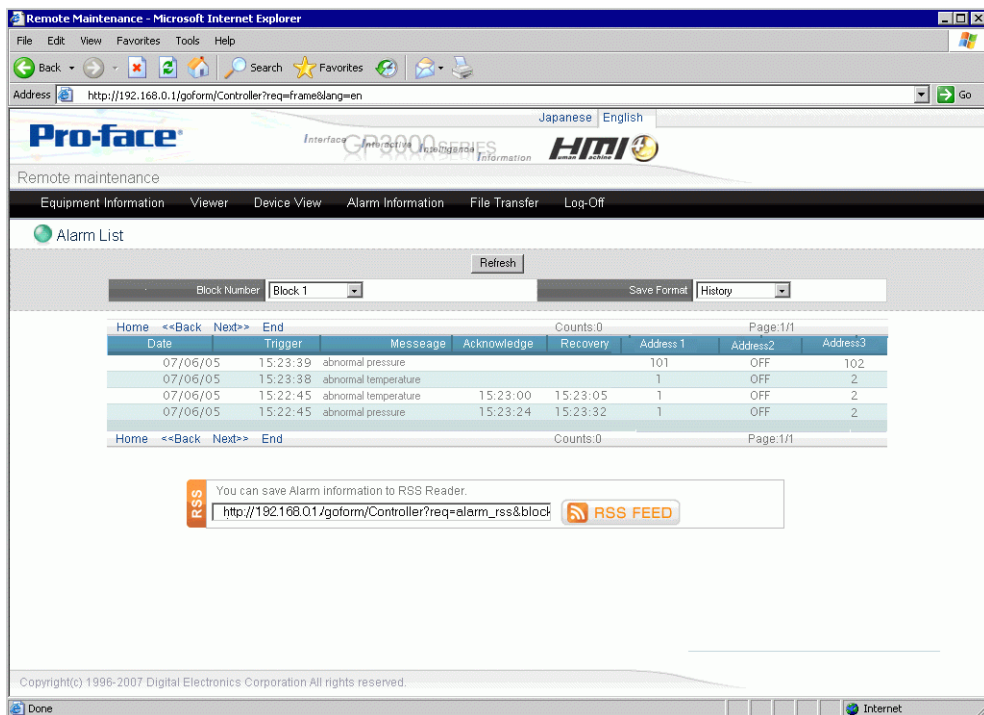

Setting	Description
Refresh	Updates alarm information and displays the latest information from the GP.
Block Number	Specifies the alarm block number (1 to 8) set up on the GP.
Save Format	Selects the alarm [Display Mode]: [History], [Log], or [Active].
Home	Displays the first line of the alarm.
Back	Moves back to the previous page.
Next	Moves to the next page.
End	Displays the last line of the alarm.
Alarm Display Frame	Displays alarm information.
Date	Displays the date and time when the alarm was triggered.
Trigger	Displays the time when an alarm is triggered.
Message	Displays the alarm message.
Acknowledge	Displays the time when an active alarm is acknowledged.
Recovery	Displays the time when an alarm is recovered.
Addresses 1 to 8	The data values when Alarms are triggered are displayed for the address specified in [Alarm]. For more details, please refer to the following. ☞ "19.10.1 Common (Alarm) Settings Guide ■ Alarm (Block 1) Settings Guide" (page 19-85)

Continued

Setting	Description
RSS	<p>Displays alarm information as RSS data. The RSS URL displays whenever changing the [Block Number] or [Save Format]. RSS data is displayed by inputting this URL into the address part of the RSS reader.</p> <p>NOTE</p> <ul style="list-style-type: none"> • Check the Pro-face support site "Otasuke Pro!" (http://www.pro-face.com/otasuke/) for RSS readers that have been confirmed to work with GP-Pro EX.
RSS FEED	You can register the URL of an RSS feed to the RSS reader. Operation of RSS feeds depend on your RSS Reader.

◆ [File Transfer] Page

Use Internet Explorer as a FTP client and starts the Web page [File Transfer] operation. Using this operation, you can access the Destination folder, as defined in the System Settings workspace, [Display Unit] page, [Remote Viewer] tab. You can also access GP files on the FTP server.

NOTE

- Using FTP, you can interact with the CF Card or USB storage. You can get the file list, get files, delete files, change file attributes, and write files.
- When Internet Explorer is used to log in for FTP connection with the user name and password left blank, the user is recognized as an anonymous user who does not require authentication. Therefore, if [Review files in FTP folder] is assigned with level 0 and [Save or delete files in FTP folder] is assigned with level 1 or higher, you cannot log in without entering the user name and password even for the purpose of browsing. In order to log on for browsing only, enter any user name and password.



37.15.2 System Settings [Display Unit] - [Remote Viewer] Settings Guide

■ Viewer

NOTE

- This option is not available when [Slave] is selected in [Action Mode] of [Ethernet Multilink Settings] through [Display Unit] - [Extended Settings].

Setting	Description
Enable	Sets up the GP-Viewer EX feature.
Enable Screen Changes from Client	Defines whether or not you can change the display screen from the GP-Viewer EX client. NOTE <ul style="list-style-type: none"> • If this item is not selected, even users with read/write privilege (as defined in the security settings) cannot change the screen from GP-Viewer EX.

■ Web Server

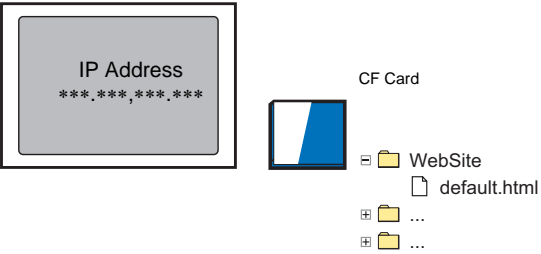

Setting	Description
<p>Enable Web Server</p> <p>Destination</p> <p>Folder</p>	<p>Defines whether or not GP data is made available using a Web page.</p> <p>Select either [CF Card] or [USB Storage] as the destination of the standard HTML template.</p> <p>Defines the folder path, up to 90 single-byte-characters long, to use as the Web Server on the CF card or USB storage.</p> <p>If you define the folder as "WebSite", and enter the address "http://ip_address/default.html" in Internet Explorer, it loads the Web page "WebSite\default.html" from the CF card or USB storage.</p> <p>For example, referencing the "Website" folder on the CF card.</p> <div style="text-align: center;">  </div> <p>NOTE</p> <ul style="list-style-type: none"> As you can specify only a single folder as the Web Server's root folder, set up the destination to either USB storage or the CF card. Slashes ("/" or "\") at the end of paths are automatically deleted when saving. Except in the case when the slash ("/" or "\") is the only character in the path.
<p>Default page when there is no file name</p>	<p>Defines the default file to display when no file name is defined in the http path. The maximum file name length is 90 single-byte characters.</p> <p>For example, when this property is set to "default.html", when you type "http://ip_address" into Internet Explorer's address bar, you are actually accessing "http://ip_address/default.html".</p> <p>NOTE</p> <ul style="list-style-type: none"> When defining the [Folder] and [Default page when there is no file name] fields, when combined, do not exceed 90 single-byte characters.

Continued

Setting	Description
HTTP Port Number	<p>Set the Web-Server port number: 1 to 65535.</p> <p>NOTE</p> <ul style="list-style-type: none"> For most applications, use port number 80. However, if 80 is not available because of the firewall or other issue, you may need to change the port number. As the number of available ports is limited by the firewall, please confirm with your firewall settings.

■ FTP



Setting	Description
Enable FTP	Select to use the FTP feature.
Destination	Select either [CF Card] or [USB Storage] as the location for the FTP server folder.
Folder	<p>Defines the CF card or USB storage folder path, up to 90 single-byte characters long, to share on the FTP server.</p> <p>If you define the folder as "FTPsite" and in Internet Explorer enter the address "ftp://ip_address/", the application displays the "WebSite" folder from the CF card or USB storage.</p> <p>For example, referencing the CF Card's WebSite folder.</p> <div style="text-align: center;"> <p>The diagram illustrates the connection between an IP address and a folder on a CF card. On the left, a box labeled 'IP Address' contains '***.***.***.***'. On the right, a 'CF Card' icon is shown with a folder named 'WebSite' and two other folders represented by ellipses.</p> </div> <p>NOTE</p> <ul style="list-style-type: none"> As you can specify only a single folder as the Web Server's root folder, set up the destination to either USB storage or the CF card. Slashes ("/" or "\") at the end of paths are automatically deleted when saving. Except in the case when the slash ("/" or "\") is the only character in the path. If you want to specify all folders in USB storage or CF card, leave blank.

■ Time Zone

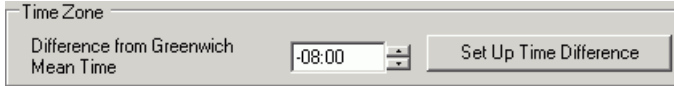

Setting	Description
Difference from Greenwich Mean Time	Set the standard time in the location where the computer is installed using the time difference from Greenwich Mean Time. You can set the time by directly entering the value or using the up/down button.
Set Up Time Difference	Acquires time zone information set to your PC and sets the time difference calculated based on that information to [Difference from Greenwich Mean Time]

NOTE

- Time Zone setting is available only for the Web Server feature.

■ Reset

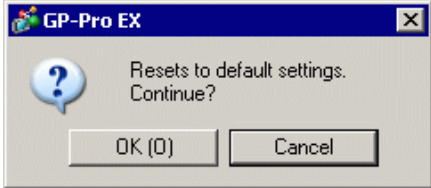

Setting	Description
Reset	<p>Resets all the settings in the [Remote Viewer], [Web Server], and [FTP] groups to their defaults.</p> <p>When you select the [Reset] button, the following confirmation message appears. Click [OK] to continue resetting properties to their defaults.</p> 

NOTE

- If [Slave] is selected for [Action Mode] of [Extended Settings] from [Display Unit], the settings are not reset even when you press the Reset button.

37.16 Restrictions

37.16.1 GP-Viewer EX Restrictions

- If the GP-Viewer EX installation path is longer than 80 single-byte characters, an error message displays indicating GP-Viewer EX cannot start because its install path is too long. Please reinstall GP-Viewer EX to an installation path less than 80 single-byte characters.
- You cannot install different versions of GP-Viewer EX on one computer.
- If you input the wrong key code, the key code will not be set. Input the correct key code.
- If you do not input key codes, the GP-Viewer EX trial version starts up.
- When connecting to the display unit without setting up key codes in GP-Viewer EX, the GP-Viewer EX trial version starts up.
- Regardless of the number of display units on the network, the maximum number of GP-Viewer EX windows you can display on one computer is 4. Conversely, the maximum number of GP-Viewer EX applications that can access the same display unit at the same time is 3.
- When starting GP-Viewer EX or clicking the update button, the display unit and GP-Viewer EX display the same alarm information. Subsequent alarm summary displays may differ between the two, because the display unit and GP-Viewer EX monitor the alarm information independently, depending on their communication speeds
- Because the display unit's external storage and GP-Viewer EX's virtual external storage are not directly synchronized, GP-Viewer EX cannot save alarm information.
- For errors that are automatically restored, such as communication errors with a connected device/PLC, the display unit may erase the error but the error remains in GP-Viewer EX. To remove the error, either change screens or click the Close button [x] in the system menu.
- When multiple errors are triggered at the same time, depending on the timing of when errors are received, all the errors may not display.

37.16.2 Web Server Restrictions

- The Web Server cannot be used without first being set up. In the System Settings workspace, [Display Unit] page, [Remote Viewer] tab, select the [Enable Web Server] check box. Please check this setting before transferring the project.
- Set up no more than 90 single-byte characters for the destination path of the standard HTML template and FTP server. To use the Web Server's standard HTML template, be sure to transfer the standard HTML template to the display unit. The Standard HTML template is installed in the following location.

C:\Program Files\Pro-face\GP-Pro EX 2.1\HTMLContents

For transfer methods, refer to the following.

☞ "33.10 Setting Up Transfer Tool" (page 33-58)

- You cannot transfer the standard HTML template when the GP has not been initialized. In any project, select the [Enable Web Server] check box and transfer it to the GP. Next, use the Transfer Tool's [Send Web site] command to transfer the standard HTML template.
- The system program on the display unit (Runtime) must be GP-Pro EX Ver. 2.10 or later, or you cannot transfer the standard HTML template to the display unit.
- The number of computers that can access the Web Server at the same time depends on the GP model. With the GP-3400, 3500, 3600, and 3700 Series, three computers can access at the same time. With GP-3200 and 3300 Series, only one computer can access the Web Server.
- [Device Information] main frame content cannot be customized by users.
- [Alarm Information] can display a maximum of 15 alarms per page.
- The maximum number of alarms you can display on RSS is 15.
- When Internet Explorer display settings are changed, such as the text size, the standard HTML may not display properly.
- When using the Web Server on GP-3200 and 3300 Series units, 1 MB from the User Screen Area is allocated to the Web Server. As a result, the Web Server adds 1 MB to the send data size.
- When using a RSS reader and the alarm records are either Active or History, recovery and acknowledge operations do not send update notifications to RSS reader. If you want to receive notification of recovery and acknowledge operations, use Log alarm records. However, note that the RSS reader has no way to distinguish between trigger, recovery, and acknowledged alarms.
- If a large number of browsers connect to the Web Server, too much load can be put on the Web Server, which could cause the Web Server to stop responding or break connections.
- When accessing the FTP server, the Internet Explorer folder display may not always update. If that happens, from the [View] menu, select [Refresh] or press the F5 function key.
- If you copy a folder with multiple subfolders on the FTP server, the login screen displays once for every file. Click [Cancel] to close the login screens.
- If you use the FTP server to overwrite read-only files, the [Login] dialog box displays. Click [Cancel] to close the dialog box.

Restrictions

- Connecting to the FTP server prevents screen and Web site transfers. Please logout before running screen or Web site transfer.
- Only direct device specification can be set in the Device View of the Web Server. Symbols, control variables, etc., cannot be used.